

User Guide

S820E Microwave Site Master™

**Cable and Antenna Analyzer
Featuring Classic and Advanced Modes**

The Anritsu logo is displayed in a light blue, sans-serif font. The letter 'A' is stylized with a diagonal slash through it.

Anritsu Company
490 Jarvis Drive
Morgan Hill, CA 95037-2809
USA
<http://www.anritsu.com>

Part Number: 10580-00343
Revision: K
Published: July 2016
Copyright 2016 Anritsu Company

Table of Contents

Chapter 1—General Information

1-1	Introduction	1-1
	Additional Documents	1-1
	Document Conventions	1-2
	Contacting Anritsu for Sales and Service	1-2
1-2	Instrument Description	1-3
	Available Options	1-4
	Battery Information	1-5
1-3	Instrument Care and Preventive Maintenance	1-6
	ESD Caution	1-6
1-4	Calibration and Annual Verification	1-7
1-5	Secure Environment Workplace	1-8
	Site Master Memory Types	1-8
	Erase All User Files in Internal Memory	1-9
	Usage in a Secure Environment	1-10

Chapter 2—Instrument Overview

2-1	Introduction	2-1
2-2	Turning On the Site Master	2-2
2-3	Test Panel Connector Overview	2-3
2-4	Front Panel Overview	2-5
	Front Panel Keys	2-5
	Keypad Menu Keys (1 to 9)	2-9
	LED Indicators	2-11
	Front Panel Interface	2-12

Table of Contents (Continued)

2-5	Touchscreen Display Overview	2-14
	Main Menu Keys	2-15
	Submenu Keys	2-15
	Submenu Button Types.	2-17
	Status Tool Bar	2-19
	System Function Tool Bar.	2-23
	Dual Display Format	2-25
	Display Modes.	2-27
2-6	Calibration	2-29
	Calibration Symbols	2-29
2-7	Soft Carrying Case	2-30
2-8	Tilt Bail Stand	2-31

Chapter 3—Cable and Antenna Measurements

3-1	Introduction.	3-1
3-2	Standard Measurements	3-3
3-3	Return Loss or VSWR Measurement	3-4
3-4	Cable Loss Measurement	3-7
3-5	Distance-To-Fault (DTF)	3-9
	Using DTF Aid.	3-10
	Transmission Line Selection	3-11
	Distance Resolution	3-14
	Windowing	3-16
	DMax (Maximum Usable Distance)	3-17
	DTF Measurement Examples	3-18
3-6	Advanced Measurements	3-23
	Transmission Measurements	3-23
	Transmission (2-Port)	3-24
	Transmission (Ext. Sensor).	3-26
	Smith Chart	3-28
	1-Port Phase	3-28

Table of Contents (Continued)

3-7	Measurement Setup	3-29
	Frequency	3-29
	Distance	3-29
	Amplitude	3-29
	Sweep	3-30
	Limit Lines	3-34
	Markers	3-40
3-8	Trace	3-47
3-9	Cable and Antenna Analyzer Menus	3-53
3-10	Measurement Menu	3-55
3-11	Freq/Dist Menu	3-58
	Freq/Dist Menu (Continued)	3-59
	Windowing Menu	3-60
3-12	Amplitude Menu	3-61
3-13	Calibration Menu	3-62
3-14	Marker Menu	3-63
	Marker Menu (Continued)	3-64
3-15	Limit Menu	3-65
3-16	Limit State Menu	3-66
	Limit Menu (Continued)	3-66
3-17	Sweep Menu	3-67
3-18	Sweep Trigger Menu	3-68
3-19	Trace Menu	3-69
3-20	Other Menus Keys	3-70

Chapter 4—Calibration, CAA

4-1	Introduction	4-1
	Chapter Overview	4-1
4-2	Calibration Setup	4-3
	Cal Type	4-4
	Cal Line	4-7
	Port 1 DUT and Cal Kit	4-8

Table of Contents (Continued)

4-3	Calibration Procedures	4-14
	Calibration Procedure	4-14
	Thru Update	4-15
	Temperature Window	4-16
	Save and Recall Calibration Coefficients	4-16
	Interpolation	4-17
4-4	Calibrate Menu	4-18

Chapter 5—Classic Mode Operation

5-1	Introduction	5-1
5-2	Classic Mode and Advanced Mode	5-2
5-3	Menu Map – Classic Mode	5-4
5-4	Marker Menu	5-6
	Marker Menu (Continued)	5-7
5-5	Limit Menu	5-8
5-6	All Other Menus	5-10

Chapter 6—VNA Mode

6-1	Introduction	6-1
	Chapter Overview	6-3
6-2	S-Parameters	6-4
	Additional Examples:	6-4
6-3	Calculating and Displaying S-Parameters	6-5
	Log Magnitude	6-5
	Log Magnitude / 2	6-6
	Phase	6-6
	Real and Imaginary	6-6
	SWR	6-7
	Group Delay	6-7
	Smith Chart	6-7
	Phase versus Unwrapped Phase Graph Types ..	6-8
6-4	Display Capabilities	6-9
	Flexible Features For Displaying Results	6-9
6-5	Active Trace and Markers	6-15

Table of Contents (Continued)

6-6	VNA Mode Menu	6-17
	Sweep Menu	6-18
	Trace Menu	6-19
6-7	Measurement Menu	6-20
	Trace Format and Number of Traces	6-21
	Graph Type List Box	6-22
6-8	Freq/Dist Menu	6-23
	Freq/Dist Menu (Continued)	6-24
	Cable and Waveguide List Boxes	6-26
	Windowing Menu	6-27
6-9	Amplitude Menu	6-28
6-10	Calibration Menu	6-29
6-11	Marker Menu	6-29
	Marker Menu (Continued)	6-30
6-12	Limit Menu	6-31
6-13	Limit State Menu	6-32
	Edit Segments (Limit) Menu	6-33
6-14	Sweep Menu 1	6-35
6-15	Sweep Trigger Menu	6-36
	IFBW	6-37
	RF Immunity	6-37
6-16	Sweep Menu 2	6-38
	RF Pwr In Hold	6-38
6-17	Sweep Menu 3	6-39
6-18	Trace Menu	6-42
	Trace Menu (continued)	6-43
6-19	Other Menus Keys	6-43

Chapter 7—Calibration, VNA

7-1	Introduction	7-1
7-2	Calibration Considerations	7-2
	Calibration Data and Indications	7-2

Table of Contents (Continued)

7-3	Calibration Setup	7-5
	Cal Type	7-6
	Cal Line and Cal Method	7-7
	Port 1 or Port 2 DUT and Cal Kit	7-9
	Thru Device	7-15
7-4	Calibration Procedures	7-16
	Calibration Procedure	7-16
	Save and Recall Calibration Coefficients	7-17
7-5	Calibration Menu	7-18
	Calibration Dialog Box	7-20
	Start Calibration Menu	7-21

Chapter 8—Vector Voltmeter

8-1	Introduction	8-1
8-2	How the VVM Function Works	8-2
8-3	Example B/A Measurement	8-6
8-4	Relative Measurements	8-9
8-5	Table Display Format	8-12
8-6	VVM Calibration	8-19
	VVM Calibration versus Save Reference	8-19
	Absolute VVM Measurements	8-19
	Relative VVM Measurements	8-19
	A/B or B/A Ratio Measurements	8-20
	Performing Calibrations	8-20
8-7	Vector Voltmeter Menus	8-21
8-8	Measurement Menu (1 of 2)	8-22
8-9	Measurement Menu (2 of 2)	8-23
	Measurement Format	8-24
	Single Display Format	8-25
8-10	Frequency Menu	8-26
8-11	Amplitude Menu	8-26

Table of Contents (Continued)

8-12	Calibration Menu	8-27
	Step 1 Calibration Dialog Box	8-28
8-13	Sweep Menu	8-29
	Source Power	8-29
	IFBW Dialog Box	8-30
8-14	Preset Menu	8-31
8-15	Trace Menu	8-31
8-16	Limit Menu	8-31
8-17	File Menu	8-31
8-18	System Menu	8-31
8-19	Mode Menu	8-31

Chapter 9—High Accuracy Power Meter

9-1	Introduction	9-1
9-2	Power Meter Display	9-3
9-3	General Measurement Setup Connection	9-4
	Connection and Offset	9-5
	Setting the Measurement Frequency	9-5
	Setting the Amplitude	9-5
	Changing the Display Units	9-7
	Displaying Relative Power	9-7
	Setting Upper and Lower Limits	9-9
	Average Menu Options	9-11
	Calibration	9-11
	Zero Failure	9-11
9-4	MA24105A Inline Power Sensor	9-12
	Introduction	9-12
	Inline Sensor Setup	9-13
	Displayed Measurements	9-16
	Summary View	9-17
	Displaying Relative Power	9-18
	Limits for Forward and Reverse Measurements ..	9-19
9-5	High Accuracy Power Meter Menus	9-20
9-6	Frequency Menu	9-21

Table of Contents (Continued)

9-7	Amplitude Menu	9-22
9-8	Calibration Menu	9-23
9-9	Average Menu	9-24
9-10	Limit Menu	9-25
9-11	MA24105A Menus	9-26
9-12	Display Setup Menu	9-27
	Forward Menu	9-28
	Reverse Menu	9-29
9-13	Frequency Menu	9-30
9-14	Amplitude Menu	9-31
9-15	Calibration Menu	9-32
9-16	Average Menu	9-33
9-17	Limit Menu	9-34
9-18	Sweep Menu	9-35
9-19	Trace Menu	9-35
9-20	Other Menus Keys	9-35

Chapter 10—File Management

10-1	Introduction	10-1
10-2	Overview	10-2
10-3	File Types	10-3
10-4	Save Files	10-4
	Set the Save Location	10-5
	Set the File Type	10-8
	Choose the File Name	10-9
	EZ Name Matrix	10-10
	Saving	10-13
	Additional Menus	10-13

Table of Contents (Continued)

10-5	Recall Files	10-14
	Recall a Measurement	10-14
	Recall a Setup	10-16
	Recall/Preview a Screen Shot	10-16
	Recall a VIP Measurement (VIP Mode Only)	10-17
	Recall a VIP Image (VIP Mode Only)	10-18
10-6	Rename Files	10-19
10-7	Copy and Paste Files	10-21
10-8	Delete Files	10-24
10-9	Create a Folder	10-25
10-10	File Menu Overview	10-27
10-11	File Menu	10-28
	Save Menu	10-29
	Save Menu (continued)	10-30
	Save Menu (continued)	10-31
	Recall Menu	10-32
	Recall Menu (continued)	10-33
	File Mgmnt Menu	10-34

Chapter 11—System Operations

11-1	Introduction	11-1
11-2	Self Test	11-2
11-3	Touchscreen Menu	11-3
11-4	Help Menu	11-5
11-5	Updating the Site Master Firmware	11-10
11-6	Screen Shot Capture	11-12
11-7	System Menu Overview	11-14
11-8	System Menu	11-15
	Status Menu	11-18
	Time and Date Menu	11-20
	Display/Audio Menu	11-21
	GPS Menu	11-24
	Ethernet Configuration Menu	11-26

Table of Contents (Continued)

11-9	Preset Menu	11-27
------	-------------------	-------

Chapter 12—Battery Replacement

12-1	Introduction.....	12-1
12-2	Site Master Battery.....	12-2
12-3	Battery Replacement	12-2

Chapter 13—Anritsu Tool Box with LST

13-1	Introduction.....	13-1
13-2	Anritsu Tool Box.....	13-2
13-3	Install the Software.....	13-3
13-4	Why use Line Sweep Tools?	13-4
	Line Sweep Tools Features.....	13-4

Chapter 14—Anritsu easyTest Tools

14-1	Introduction	14-1
14-2	easyTest Tools on the PC	14-2
	Create an easyTest File on the PC	14-2
14-3	easyTest on the S820E	14-4

Chapter 15—Video Inspection Probe (VIP)

15-1	Introduction.....	15-1
15-2	Setup and Operation Summary	15-2
15-3	VIP Setup	15-3
	Connect the VIP	15-3
	Launch the VIP Application.....	15-4
	VIP Test Settings.....	15-4
15-4	Operation	15-6
	VIP Image Analysis	15-6
	VIP Reporting	15-9
15-5	VIP Menus	15-11
	Setup Menu.....	15-12
	Measurement Menu	15-13
	File Menu.....	15-14
	Report Menu	15-15

Table of Contents (Continued)

Appendix A—Instrument Messages

A-1 Introduction A-1

Appendix B—Measurement Review

B-1 Introduction B-1

B-2 Measurement Overview B-1

 What is Measured? B-1

 Why Measure? B-3

 Line Sweeping B-4

 Calibration B-7

B-3 Measurement Review B-8

B-4 Common RF Terms B-9

B-5 Standard Line Sweep Measurements B-11

 Line Sweep Measurement Types B-11

Appendix C—Glossary

C-1 Introduction C-1

C-2 Glossary Terms C-1

Index



Chapter 1 — General Information

1-1 Introduction

This chapter provides a general overview and information about frequency range, additional documents, preventive maintenance, and annual verification requirements for the Anritsu Handheld Site Master S820E.

Additional Documents

The following documents provide additional information about the Site Master S820E Cable and Antenna Analyzer.

- Handheld Instruments Product Information, Compliance, and Safety Guide (10100-00065). Provides important safety, legal, and regulatory notices. Read this guide *before* operating the equipment.
- Site Master S820E Technical Data Sheet (11410-00650). Includes general specifications, detailed measurement specifications for all available measurement modes, ordering information, and a list of available accessories.
- Site Master S820E Programming Manual (10580-00344). Includes an overview of the compatible SCPI commands used to remotely access the Site Master S820E.
- Site Master S820E Product Brochure (11410-00726). Includes an overview of the of the Site Master S820E instrument, ordering information, and accessories information.
- Site Master S820E Maintenance Manual (10580-00345). Includes general information on the instrument, test equipment required, a replaceable parts list, and verification procedures including frequency accuracy, return loss, and dynamic range.

These documents along with additional application notes and white papers covering cable and antenna analysis are available on the documentation disc included with the instrument and also from the Anritsu web site via the Site Master S820E product page:

<http://www.anritsu.com/en-us/test-measurement/products/s820e>

Document Conventions

Main menus and keypad buttons are shown in the user guide using a **Sans Serif Bold** typeface. Main menus are the six buttons that are displayed at the bottom of the touchscreen. Submenus and submenu buttons are displayed on the right side of the touchscreen display and are shown in the user guide using **Sans Serif Regular** typeface.

Menu and button locations may be described in this document by their path:

Measurement > VSWR

The line above reads as “Press the Measurement main menu button, then press the VSWR submenu button.”

Screen images in this User Guide are illustrations of typical instrument features. Some images may include instruments other than the Site Master S820E. Traces and other display features may differ from the screen displays of your instrument.

Contacting Anritsu for Sales and Service

To contact Anritsu, please visit: <http://www.anritsu.com/contact-us>

From there, you can select the latest sales, select service and support contact information in your country or region, provide online feedback, complete a “Talk to Anritsu” form to have your questions answered, or obtain other services offered by Anritsu.

Updated product information can be found on the Anritsu Web site:

<http://www.anritsu.com/>

Search for the product model number. The latest documentation is on the product page under the Library tab.

Example URL for Site Master S820E:

<http://www.anritsu.com/en-us/test-measurement/products/s820e>

1-2 Instrument Description

The Microwave Site Master S820E is a handheld cable and antenna analyzer designed to make measurements in the field on both coaxial cable and waveguide transmission lines. Cable and antenna analyzer measurements include 1-port Return Loss, Cable Loss, VSWR, Distance-To-Fault (DTF), Transmission, Smith Chart, and phase measurements. The S820E also performs 2-port transmission and cable loss measurements (using an external sensor for applications in which the ends of the device are physically separated by a distance longer than is reachable with normal test port cables, such as aircraft communication cables embedded within the body of the aircraft). VNA mode measurements include S-Parameter measurements S_{11} , S_{21} , S_{12} , S_{22} . In addition to the cable and antenna measurements and VNA mode measurements, the instrument includes a high accuracy power meter mode utilizing Anritsu external USB sensors (sold separately).

The bright, high-resolution, 800 x 600 pixel 8.4 inch color display provides easy viewing in a variety of lighting conditions. The combination of a resistive touchscreen plus keypad enables you to navigate menus with the touchscreen and to enter text or numbers directly. A user-editable EZ Name Matrix allows you to configure complex sweep names quickly, saving hours of valuable time daily. The Site Master is equipped with factory installed Li-Ion batteries typically delivering more than 4 hours of battery life when fully charged.

The internal memory is large enough to store more than 2,000 files. Files can be any combination of measurement files, setup files, or screen shots. Files can also be saved or copied to a connected USB flash drive. Measurements can be transferred to a PC using the supplied USB cable or with a USB flash drive.

The use of folders (with no more than 300 files per folder) is advisable when storing a large number of files within the Site Master internal memory. When navigating through folders with larger numbers of files, the sorting process can take noticeably longer and can delay the display of those files.

Included with the S820E is Line Sweep Tools (LST), a PC-based software program that can be used to create reports, view and organize data, analyze historical data, edit markers and limit lines, rename traces, and trace analysis. Refer to [Chapter 13](#) for a brief overview of Line Sweep Tools.

Anritsu easyTest Tools provides a library of commands and a drag-and-drop interface for creating test sequences. The Windows XP, Windows Vista, and Windows 7 compatible software is available on the Anritsu web site.

- A developer creates an easyTest test sequence (.ett) file on a PC. The file is copied to the S820E using a USB flash drive.
- When the file is run using the easyTest icon on the Menu Shortcut screen, the S820E displays instructions one step at a time to the operator, simplifying the process of operating the instrument and completing assigned tasks.

easyTest Tools Help (which includes a Quick Start Topic), full use instructions, and sample .ett files are included on the disc with the software. After installing easyTest Tools on a PC, start the application and choose **Help** for additional information.

Refer to [Chapter 14](#) for a brief overview of easyTest Tools.

Available Options

The Microwave Site Master S820E Technical Data Sheet (part number 11410-00650) contains a list and a description of available options, including standard or premium calibrations and extended warranties.

The Technical Data Sheet is available on the Anritsu web site:

<http://www.anritsu.com>

Table 1-1. Microwave Site Master S820E Frequency Options

Model Option	Frequency Range	RF Ports
S820E-0708	1 MHz to 8 GHz	Type N(f)
S820E-0714	1 MHz to 14 GHz	Type N(f)
S820E-0720	1 MHz to 20 GHz	Ruggedized K(m)
S820E-0730	1 MHz to 30 GHz	Ruggedized K(m)
S820E-0740	1 MHz to 40 GHz	Ruggedized K(m)

Other Options

Option S820E-440 adds VNA Mode to the Microwave Site Master. For additional option configuration information, refer to [“Option Configuration” on page 11-15](#).

Battery Information

The battery that is supplied with the Site Master may need charging before use. It can be charged using either the AC-DC Adapter or the DC adapter. Refer to [“Status Tool Bar” on page 2-19](#) for a description of battery symbols. The batteries are typically charged in the instrument.

Note

Use only Anritsu Company approved batteries, adapters, and chargers with this instrument.

The batteries will charge at a faster rate when the instrument is turned off or is set to standby mode. Charging the batteries while the instrument is running requires a longer time to reach a full charge.

To prolong the useful battery life, the internal charging circuit monitors battery temperature. Normal charging occurs when the battery temperature is between 0 °C and 45 °C. Charging is paused if the internal battery temperature is beyond this range.

Caution

When using the Automotive power outlet adapter, always verify that the supply is rated for a minimum of 60 Watts at 12 VDC, and that the socket is clear of any dirt or debris. If the adapter plug becomes hot to the touch during operation, then discontinue use immediately.

Refer to [Chapter 12, “Battery Replacement”](#) for additional information on replacing the batteries.

Note

Anritsu Company recommends removing the battery for long-term storage of the instrument.

1-3 Instrument Care and Preventive Maintenance

Site Master preventive maintenance consists of cleaning the instrument and inspecting and cleaning the RF connectors on the instrument and all accessories. Clean the Site Master with a soft, lint-free cloth dampened with water or water plus a mild cleaning solution.

Caution	To avoid damaging the display or case, do not use solvents or abrasive cleaners.
----------------	--

Clean the RF connectors with a cotton swab dampened with denatured alcohol. Visually inspect the connectors. If you are unsure whether the connectors are undamaged, then gauge the connectors to confirm that the dimensions are correct.

Carefully inspect the test port cable. The cable should be uniform in appearance, and not stretched, kinked, dented, or broken. A defective test port cable is the most common cause of unreliable or erratic measurements. Extra care should be exercised to ensure that the test port cable remains in good condition.

ESD Caution

The Site Master, like other high performance instruments, is susceptible to electrostatic discharge (ESD) damage. Coaxial cables and antennas may build up a significant static charge, which may damage the Site Master. To prevent ESD damage, you are advised to connect a short to either end of the cable before connecting the cable to the Site Master. If no short is available, then a termination (load) may be used. Site Master operators must always be aware of the potential for ESD damage and take all necessary precautions. Operators should exercise practices outlined within industry standards such as JEDEC-625 (EIA-625), MIL-HDBK-263, and MIL-STD-1686; which pertain to ESD and ESDS devices, equipment, and practices. Remember that the operator may also carry a static charge that can cause damage. Following the practices outlined in the above standards will ensure a safe environment for both personnel and equipment.

1-4 Calibration and Annual Verification

The Cable and Antenna Analyzer requires user-performed calibration before making measurements. Calibration can be quickly and easily performed using several calibration options. Calibration components are sold separately. Refer to [Chapter 4, “Calibration, CAA”](#) for additional information.

Note

Anritsu recommends allowing the S820E to warm up for 10 minutes to typical operating temperature before calibrating. The instrument will require a new calibration if the internal instrument temperature changes more than ± 10 °C after calibration.

Anritsu recommends an annual calibration and performance verification of the Site Master by local Anritsu service centers.

The Site Master is self-calibrating and there are no field-adjustable components. The external calibration components are crucial to the integrity of the user calibration. As a result, they must be verified periodically to ensure performance conformity. This is especially important if the calibration components have been accidentally dropped or over-torqued.

Contact information for Anritsu Service Centers is available at:

<http://www.anritsu.com/contact-us>

1-5 Secure Environment Workplace

This section describes the types of memory in the Site Master, how to delete stored user files that are in the internal memory, and recommended usage in a secure environment workplace.

Site Master Memory Types

The instrument contains non-volatile disk-on-a-chip memory, EEPROM, and volatile DRAM memory. The instrument does not have a hard disk drive or any other type of volatile storage memory.

EEPROM : This memory stores the model number, serial number, and calibration data for the instrument. Also stored here are the user-set operating parameters such as frequency range. During the master reset process, all operating parameters that are stored in the EEPROM are set to standard factory default values.

RAM Memory : This is volatile memory used to store parameters needed for the normal operation of the instrument along with current measurements. This memory is reset whenever the instrument is power cycled. Standby mode does not reset this memory.

External USB Flash Drive (not included with the instrument): This memory can be selected as the destination for saved files. You can also copy the contents of the internal memory to the external flash memory for storage or data transfer. The external USB flash drive can be reformatted or sanitized using software on a PC.

Refer to [Chapter 10, “File Management”](#) for additional information on saving and copying files to the USB flash drive.

Note

The screen images on your instrument or computer may vary from what is shown in this User Guide.

Erase All User Files in Internal Memory

Perform a Master Reset:

1. Press the **Preset (1)** button.
2. Press the Reset drop down submenu then press the Reset button. Select Master Reset and read the description on the screen ([Figure 1-1](#)).

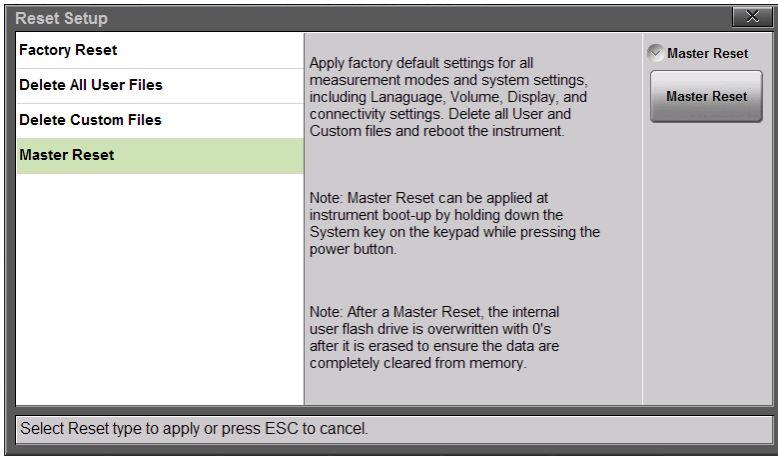

Figure 1-1. Master Reset

3. To erase all user files in internal memory, press the Master Reset button. A dialog box is displayed, warning that all settings will be returned to factory default values and that all user files will be deleted ([Figure 1-2](#)). Deleted files cannot be recovered.

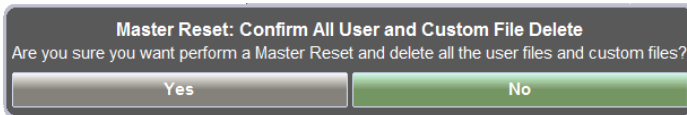

Figure 1-2. Master Reset Confirmation

4. Press **Yes** to complete the master reset and reboot the instrument.
5. The instrument is now reset.

Refer to the [“Preset Menu” on page 11-27](#) for additional information on reset options.

Usage in a Secure Environment

Note

Not all USB flash drives are compatible with the S820E. Anritsu recommends performing a full FAT 32 long format prior to using with the instrument. Some USB devices may not be recognized even after formatting, and in these cases, the device must be replaced with another type.

Set the Site Master to save files to an external USB flash drive:

1. Attach the external flash drive and turn on the instrument.
2. Press the **File (7)** button, then **Save**.



Figure 1-3. Choosing a Storage Drive – Step 2

3. Press the **Location** button then double tap on the word **DRIVE** or press the **Left Arrow** key until the external USB drive is displayed.

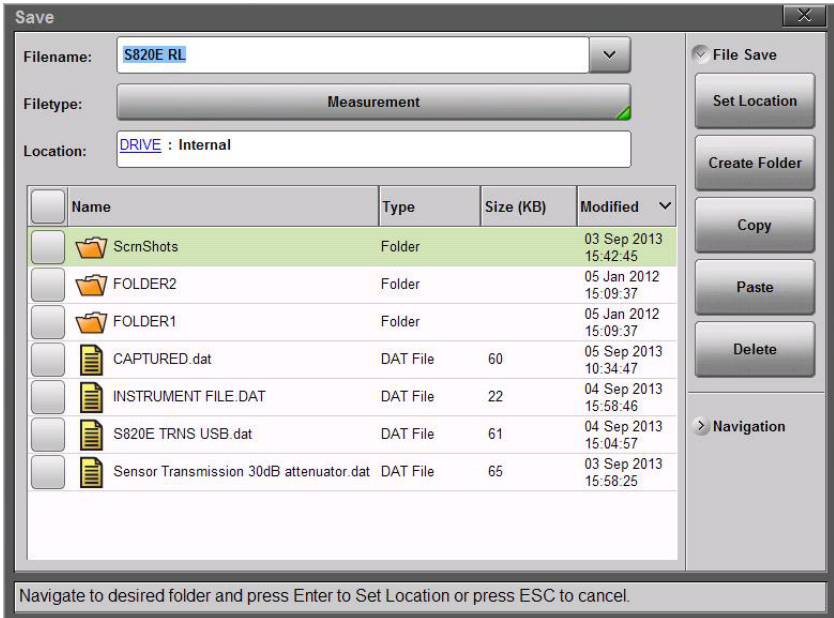

Figure 1-4. Choose a Storage Drive – Step 3

4. Double tap on USB, or highlight USB by using **Arrow** keys or by touching the screen, then press **Enter** or press the **Right Arrow** key. The Location breadcrumb changes to DRIVE : USB.

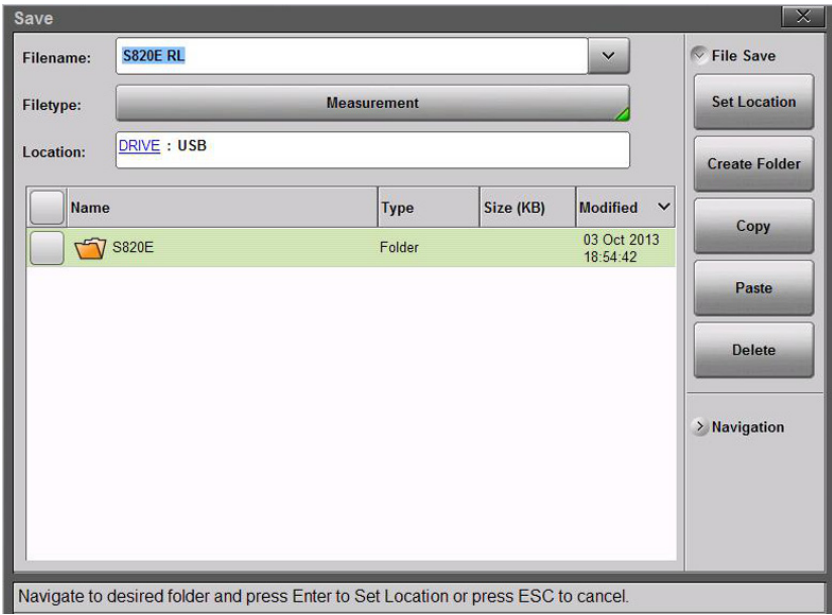

Figure 1-5. Choose a Storage Drive – Step 4

5. Press the Set Location submenu key. The external USB flash drive is now the default location for saving files.

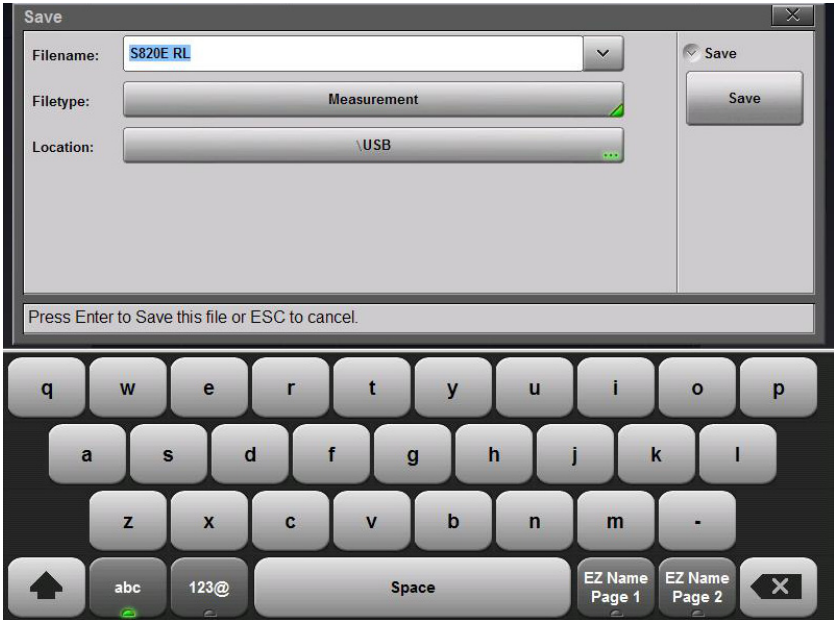

Figure 1-6. Choose a Storage Drive – Step 5

Note

Refer to [Chapter 10, “File Management”](#) for more detailed information.

Chapter 2 — Instrument Overview

2-1 Introduction

This chapter provides an overview of the Anritsu Site Master S820E. The intent of this chapter is to acquaint you with the instrument and its general functionality. For detailed line sweeping information, refer to [Chapter 3](#) for Advanced mode or [Chapter 5](#) for Classic mode or [Chapter 6](#) for VNA mode. User calibration for cable and antenna sweeping is described in [Chapter 4](#). High Accuracy External USB Power Meter operation is described in [Chapter 9](#).

Note

Screen images in this User Guide are illustrations of typical instrument features. Some images may include instruments other than the Site Master S820E. Traces and other display features may differ from the screen displays of your instrument.

2-2 Turning On the Site Master

The Anritsu Site Master S820E is capable of approximately 4 hours of continuous operation from a fully charged battery.

The Site Master can also be operated from a 12 VDC source (which also simultaneously charges the battery). This can be achieved with either the Anritsu AC-DC Adapter or the Automotive power outlet adapter.

Caution

When using the Automotive power outlet adapter, always verify that the supply is rated for a minimum of 60 Watts at 12 VDC, and that the socket is clear of any dirt or debris. If the adapter plug becomes hot to the touch during operation, then discontinue use immediately.

To turn on the Site Master, press the green **On/Off** button on the front panel (Figure 2-5 on page 2-12). The Site Master takes approximately 90 seconds to complete initial power up and load the application software.

Momentarily pressing the **On/Off** button when the Site Master is operating places the instrument into standby mode. A message “Going into Standby Mode” is displayed, and the touchscreen display turns off. The green power LED slowly pulses when the instrument is in standby mode. Press the **On/Off** button momentarily again to restore the instrument to standard operation.

One minute of inactivity causes the Site Master to enter reduced power mode. In this mode the display screen brightness is reduced. Touching any portion of the screen or any keypad press while in reduced power mode instantly restores screen brightness.

Press and hold the **On/Off** button until the shut down popup window appears. The current settings are saved, and the instrument shuts down.

Note

If the instrument appears non-responsive or will not power down using the standard shutdown procedure, then disconnect the external power supply, and then press and hold the power button for 10 to 15 seconds to force an instrument shutdown. Note that the current settings will not be saved.

2-3 Test Panel Connector Overview

The test panel for the Site Master S820E is shown in [Figure 2-1](#).

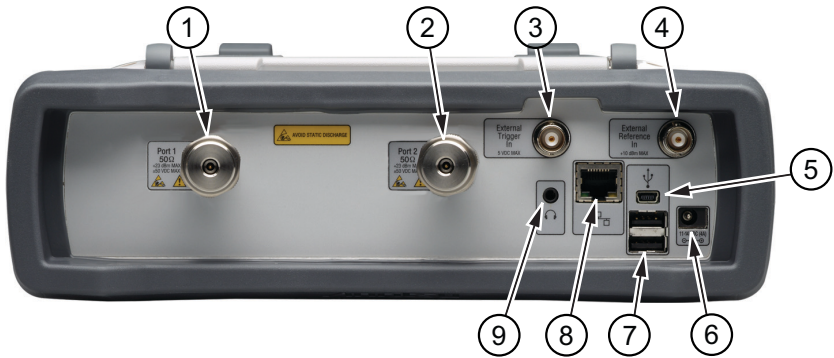

1.	<p>Port 1, Type N, Female (Options 0708, 0714) or Ruggedized K, Male (Options 0720, 0730, 0740)</p> <p>50 ohm impedance. Maximum input is +23 dBm at ± 50 VDC. Torque to 12 lbf·in or 1.4 N·m (N connector) or to 8 lbf·in or 0.90 N·m (K connector).</p>
2.	<p>Port 2, Type N, Female (Options 0708, 0714) or Ruggedized K, Male (Options 0720, 0730, 0740)</p> <p>50 ohm impedance. Maximum input is +23 dBm at ± 50 VDC. Torque to 12 lbf·in or 1.4 N·m (N connector) or to 8 lbf·in or 0.90 N·m (K connector).</p>
3.	<p>External Trigger In, Type BNC(f), 50 ohm</p> <p>A sweep is triggered on the rising edge of a TTL signal.</p> <p>Maximum input is +5 VDC.</p>
4.	<p>External Reference In, Type BNC(f), 50 ohm</p> <p>Auto-detects a 10 MHz external reference. When active the Measurement Setting for Freq Ref displays “External”. Maximum input is +10 dBm.</p>
5.	<p>USB Interface – Type Mini-B (version 2.0)</p> <p>The USB 2.0 Mini-B connector can be used to connect the Site Master directly to a PC.</p>

Figure 2-1. S820E Test Panel Connector (1 of 2)

6.	<p>External Power, 5.5 mm Barrel Connector</p> <p>The external power connector is used to power the instrument and for battery charging. Input is 11 VDC to 14 VDC at up to 4.0 A. When using the AC-DC Adapter, always use a grounded three-wire power cable that is connected to a three-wire power line outlet. Failure to use properly grounded electrical equipment may result in severe or potentially fatal injury.</p>
7.	<p>USB Interface – Type A (version 2.0)</p> <p>The Site Master has two Type A USB 2.0 connectors that accept USB Flash Memory devices for storing or transferring measurements, setups, and screen shots. USB sensors that are used for 2-port cable loss measurements and high accuracy power meter measurements and certain USB peripheral devices (such as a USB GPS module, USB mouse, or USB keyboard) may also be supported.</p>
8.	<p>RJ45 connector (10/100 Ethernet)</p> <p>Used to connect the Site Master to a local area network. When the instrument is connected to a network, the instrument obtains an IP address via DHCP, or a static IP address can be set by the user. Refer to “Status Menu” on page 11-18 for information about obtaining the IP address of the instrument.</p>
9.	<p>Headset Jack</p> <p>The jack accepts a 3.5 mm 3-wire miniature phone plug such as those commonly used with cellular telephones. The speaker output is diverted to the headphone when the headphone is plugged into this jack.</p>

Figure 2-1. S820E Test Panel Connector (2 of 2)

2-4 Front Panel Overview

The Site Master menu-driven interface is easy to use and requires little training. The Site Master uses a touchscreen, keypad, **Arrow** keys, and rotary knob for data input. The menu and submenu keys vary depending upon the selected mode of operation.

The number keypad keys are dual purpose, depending upon the current instrument state. The dual-purpose keys are labeled with a number on the key and the alternate function printed above the key. The numeric keys function when there is an active parameter entry dialog box open. The **Esc** key is used for aborting data entry and closing menus. The rotary knob, the four **Arrow** keys, and the keypad can also be used to change the value of most active parameters.

Note

The Site Master is also compatible with a standard corded USB mouse. Plugging the mouse into one of the USB ports on the Site Master automatically displays the mouse cursor arrow on the display. Mouse input can then be used in combination with touchscreen entry. If the mouse cursor is not displaying, then confirm that the Cursor button (in the **Touchscreen (0)** menu) is turned On.

Front Panel Keys

Menu Key

Press the **Menu** key to open the Menu screen. Select the desired operating mode by touching one of the large mode icons in the top row or by touching one of the user-created shortcuts below. User-created shortcuts may include measurement setups, submenu key, or easyTest Tools scripts. Shortcuts can be added, deleted, or moved as described below.

Measurement mode icons are pre-installed and cannot be moved or deleted. The smaller shortcut icons are easily created or deleted by the user.

Help for the Menu Shortcut screen is available by pressing the Help Shortcut icon in the lower-right corner of the display when the menu screen is active.

The shortcut icons on the left of the Menu screen are available for direct access in all modes except Classic. When in classic mode, shortcuts are available only by pressing the **Menu** key.

Create a Menu Shortcut for a Submenu Key

Press and hold down any submenu key to add a shortcut to the Menu screen. After a few seconds the Menu screen is automatically displayed showing the available locations for the shortcut. Select an unused location to store the new shortcut.

Create a Menu Shortcut for a Setup File

Press **File (7)** then the **Recall** submenu key to display saved files. Locate the desired setup file (.stp) to shortcut and then, using the touchscreen, press and hold on the file name until the Menu screen is displayed. Select an unused location to save the setup file shortcut icon.

User-defined shortcuts stay in memory until deleted. To delete or move a shortcut button, press the **Menu** key, then press and hold the shortcut until the Customize Shortcut dialog box (Figure 2-2) appears. This dialog box provides options to delete or move the shortcut. If Move is selected, then a green rectangle outlines the shortcut button. Touch the new location where the button is to be placed. If the location is empty, then the outlined button moves there. If the location contains a button already, then the two buttons swap locations.

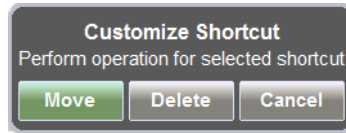
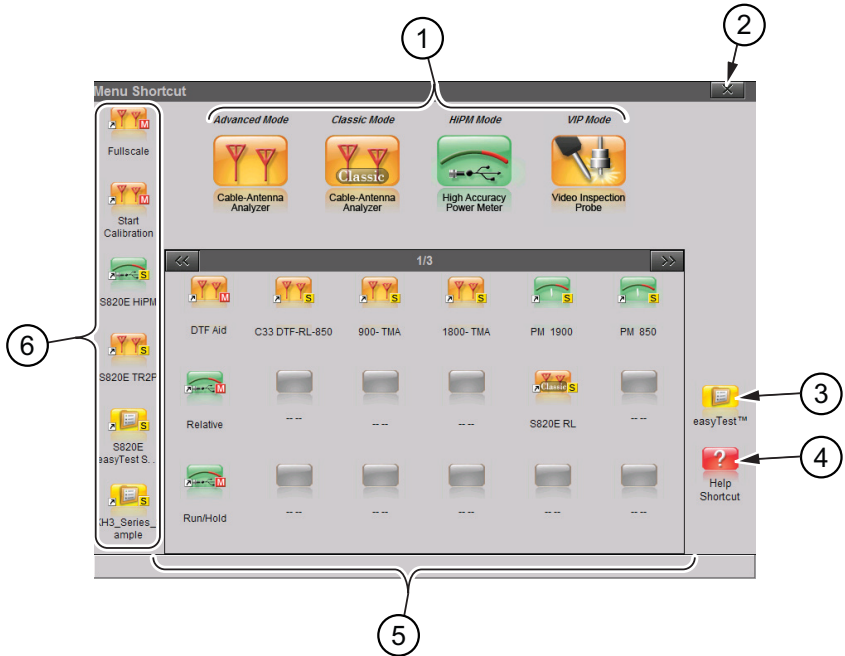

Figure 2-2. Customize Shortcut

If a file (with an assigned shortcut) is moved or deleted, then that shortcut icon becomes nonfunctional and must be removed manually. If a nonfunctional shortcut is pressed, then a message is displayed: “Error Recalling File...”

Figure 2-3 shows the **Menu** key screen with shortcut icons for the installed measurement modes. Touch one of the icons in the top row to change measurement modes.



1.	Installed Applications (Measurement Modes)
2.	Close Box
3.	Icon to Launch easyTest. Refer to Chapter 14 .
4.	Help for Menu Screen
5.	Installed Setup and Menu Shortcuts (Screen 1 of 3)
6.	Shortcuts Displayed in All Menus (not available in Classic Mode)

Figure 2-3. Menu Key Screen, Icons for Installed Applications and Shortcuts

Note

Shortcuts for both menu buttons and setup files can be deleted as a group under the **Preset** Menu > Reset submenu. Select Delete Custom Files, then select the Menu Shortcuts checkbox. Press the Delete Custom Files button.

Refer to “[Preset Menu](#)” on page 11-27 for additional information.

Esc Key

Press this key to cancel any setting that is currently being made or to close the currently dialog box.

Enter Key

Press this key to finalize data input or select a highlighted item from a list.

Shift Key

During file management functions the shift button toggles the on-screen keyboard between upper case and lower case characters. It may also be used for saving screen shots. To save a screen shot, press and hold the **Shift** while then pressing (one at a time) the period (.) key, then the **+/-** key. Refer also to [Section 11-6 “Screen Shot Capture” on page 11-12.](#)

Arrow Keys

The four arrow keys (around the **Enter** key) are used to scroll up, down, left, or right. The **Up/Down** arrow keys can often be used to change a value or to change a selection from a list. This function is similar to the function of the rotary knob. The **Left/Right** arrow keys can be used to move markers and the **Up/Down** arrow keys can also be used to move limit lines.

In Video Inspection Probe (VIP) mode, use the arrow keys to pan a captured image. Refer to [Chapter 15.](#)

Number Keypad

The Number keypad has two functions: The primary function is number entry. The secondary function of the number keypad is to list various menus. See [“Keypad Menu Keys \(1 to 9\)”](#) below.

Rotary Knob

Turning the rotary knob changes numerical values, scrolls through selectable items from a list, and moves markers or limit lines. In VIP mode, use the rotary knob to zoom in and out on a captured image.

Keypad Menu Keys (1 to 9)

Not all Menus are active in various measurement modes. If any one of these menus is available in a specific instrument mode of operation, then it can be called from the number keypad. It may also be available from a main menu key or a submenu key ([Table 2-1 on page 2-9](#)).

Table 2-1. Site Master Keypad Functions (1 of 2)











Menu	Description
Touchscreen 	Opens the touchscreen control menu for access to the touchscreen calibration function, Cursor On/Off selection, and Lock On/Off selection. Refer to “Touchscreen Menu” on page 11-3 .
Preset 	Opens the Preset/Reset submenus for resetting the Site Master back to default settings, deleting custom files, and updating instrument firmware. Refer to “Preset Menu” on page 11-27 for additional information.
Calibrate 	Opens the Calibration submenus to provide access to the user calibration functions. Refer to “Calibration, CAA” on page 4-1 for additional information.
Sweep 	Displays the Sweep menu to adjust Sweep Type. Sweep settings are displayed left of the graph. Function varies by measurement mode. Refer to “Sweep Menu” on page 3-67 for Cable-Antenna mode.
Measure 	Displays the Measurement menu to select the measurement type when the S820E is in Cable-Antenna mode. Refer to “Measurement Menu” on page 3-55 for additional information.
Trace 	Displays the Trace menu and provides access to the available trace functions (mode dependent). Refer to “Trace” on page 3-47 for detailed instructions.
Limit 	Displays the Limit menu to set user-defined limits. Limit Alarms and Pass/Fail messages may be activated to indicate when a limit has been exceeded by the active measurement. Refer to “Limit Menu” on page 3-65 for Advanced Cable-Antenna mode, to “Limit Menu” on page 5-8 for Classic Cable-Antenna mode, and to “Limit Menu” on page 9-25 for High Accuracy Power Meter mode.

Table 2-1. Site Master Keypad Functions (2 of 2)

Menu	Description
<p>File</p> 	<p>Allows you to save, recall, copy, and delete files in internal memory or an external USB flash drive. Refer to “File Management” on page 10-1.</p>
<p>System</p> 	<p>Opens the System menu and provides access to System Information, System Setups, and Diagnostic tools. Refer to “System Operations” on page 11-1 for additional information.</p>
<p>Mode</p> 	<p>Displays the Mode Selector dialog box to allow you to easily switch between available measurement modes. See Figure 2-4.</p>

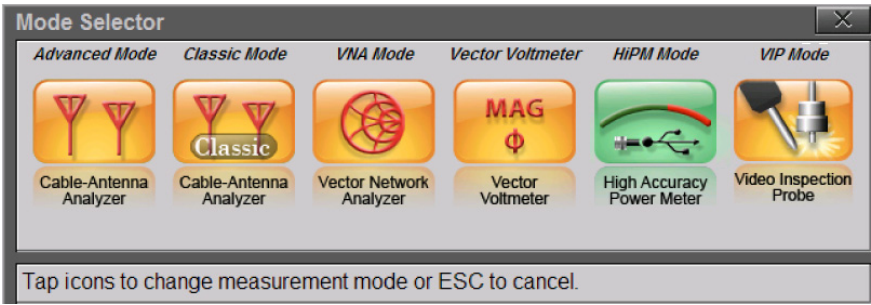

Figure 2-4. Mode Selector

LED Indicators

Power LED

The Power LED is solid green when the instrument is on, and slowly pulses when the Site Master is in standby mode.

Charge LED

The LED is green when the Site Master is on and the battery is fully charged. The LED is orange when the battery is charging, and is off when the Site Master has no external power.

Press the battery icon  at the top of the screen to view the current battery charge.

Front Panel Interface



1.	Status Tool Bar
2.	Port 1
3.	System Function Tool Bar (not available in “Classic” mode)
4.	Port 2
5.	Menu Key
6.	Rotary Knob
7.	Enter Key and Arrow Keys
8.	Esc Key
9.	Number Keypad and Menu Keys
10.	Charge LED
11.	On/Off/Standby Button
12.	Power LED
13.	Submenu Keys
14.	Main Menu Keys

Figure 2-5. Site Master Instrument Overview (1 of 2)

15.	Warning and Status Area
16.	Shortcut Tool Bar (not available in "Classic" mode)
17.	Measurement Settings Summary (touchscreen menu shortcuts)

Figure 2-5. Site Master Instrument Overview (2 of 2)

2-5 Touchscreen Display Overview

Note Screen captured images are provided as examples. The image and measurement details shown on your instrument may differ from the examples in this measurement guide.

Figure 2-6 illustrates some of the Site Master user interface features.

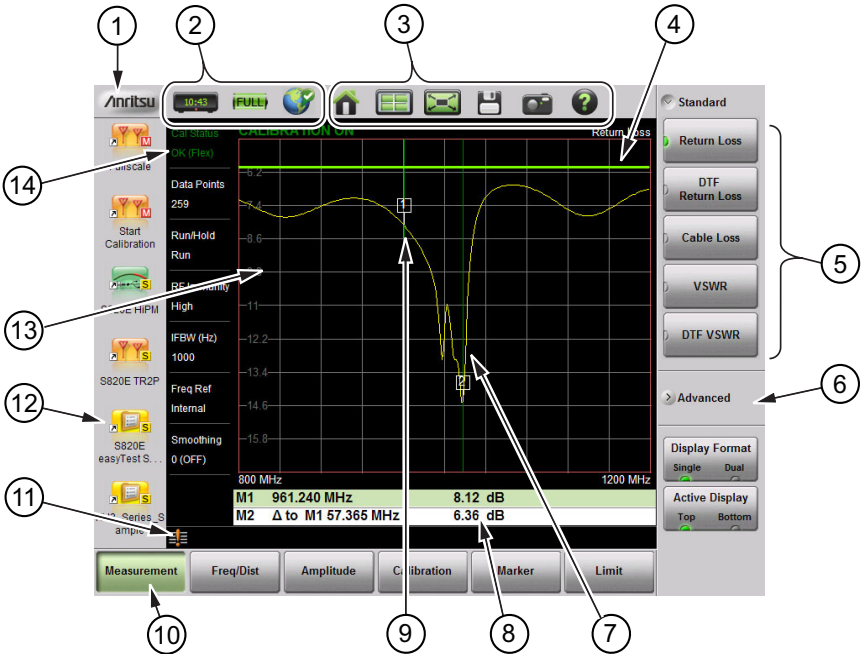

1. Anritsu Logo. Displays the System Status dialog screen when pressed. Press **Esc** or **✕** to close. Refer to the “[Status Menu](#)” on page 11-18 for additional information.
2. Status Tool Bar. Refer to “[Status Tool Bar](#)” on page 2-19 for information on each icon.
3. System Function Tool Bar. Shortcuts to various system functions. See “[System Function Tool Bar](#)” on page 2-23 for information on each icon. Not displayed in Classic Mode.
4. User-defined Limit Line.
5. Expanded submenu. Expanded submenus display the function buttons.

Figure 2-6. Site Master Display Overview (1 of 2)

6.	Collapsed submenu. Pressing a collapsed submenu causes it to expand as shown in row 5. Refer to “Submenu Keys” on page 2-15 .
7.	Active trace sweeping between Start Frequency (F1) and Stop Frequency (F2).
8.	Marker Table. Refer to “Markers” on page 3-40 .
9.	Marker 1.
10.	Main Menu keys with Measurement selected. Refer to “Main Menu Keys” on page 2-15 .
11.	Warning and Status Area.
12.	User-defined Shortcuts. Refer to “Menu Key” on page 2-5 . Not displayed in Classic Mode.
13.	Graph, a 10 x 10 grid showing the active trace.
14.	Instrument Settings Summary provides a selection of Measurement Information pertaining to the current, active trace, or traces. May also be used as a touchscreen shortcut to submenus.

Figure 2-6. Site Master Display Overview (2 of 2)

Main Menu Keys

The main menu keys are horizontally arranged along the lower edge of the touchscreen. The main menu key functions change based on the instrument mode. The instrument mode is set with the **Mode (9)** key, the **Menu** key, or the mode selector icon  (icon not available in Classic mode). The main menu keys generate function-specific submenus.

Submenu Keys

These submenu keys are arranged along the right-hand edge of the touchscreen. The submenu keys change based on the selected Main Menu or Keypad Menu key.

Several submenus may be displayed in the submenu block area. Press any collapsed submenu title to expand the submenu and display the submenu buttons. Press one of the submenu buttons to make a selection or set a parameter.

In **Figure 2-7**, the **Measurement** main menu is selected (Green depressed state) and the DTF Return Loss measurement button is selected (Green semicircle).

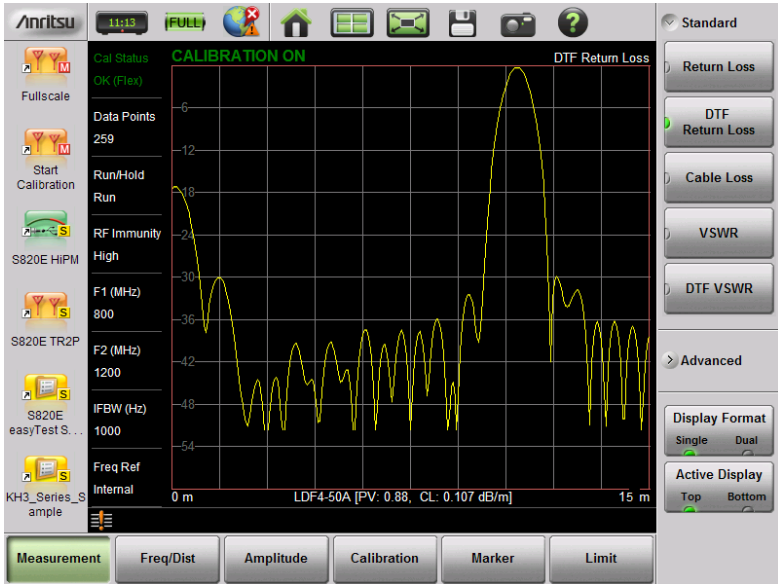

Figure 2-7. Distance to Fault Measurement

Submenu Button Types

The Site Master interface uses several submenu button types. Each is described in [Table 2-2](#).

Table 2-2. Submenu Button Examples (1 of 2)









Button Description	Button Example
<p>1. Numeric Entry</p> <p><i>example:</i> Start Frequency (F1) button in the Freq/Dist menu.</p> <p>Opens an “Edit Parameter Window”. Change the current value using the rotary knob, Up/Down Arrow keys, or number keypad. Using the keypad displays terminator buttons (in frequency units). Press one of the buttons to complete the entry, or press the Esc key to cancel the entry. Press  to delete the last number entered. Entering a value beyond the range of the instrument sets the parameter to the maximum or minimum value.</p>	  <p>▼ Frequency</p>  <p>▼ Units</p>    
<p>2. Toggle</p> <p>Each press of the button cycles between the available states. The active state is indicated by the glowing green semicircle at the bottom of the button.</p>	<p>▼ Sweep Setup</p> 

Table 2-2. Submenu Button Examples (2 of 2)

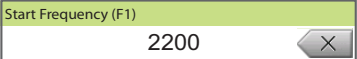
Button Description	Button Example
<p>3. Parameter Value</p> <p><i>example:</i> Measurement main menu.</p> <p>This button type is used when several options are available for the parameter. The current selection is indicated by the glowing green semicircle at the left of a button.</p>	
<p>4. Submenu Selection</p> <p><i>example:</i> Data Points button in the Sweep (3) menu.</p> <p>The current value is displayed below the button name. Pressing the button displays a submenu of the available values. Press one of the buttons to select a new value. Press Esc to cancel. Submenu Selection buttons are indicated by the glowing green triangle in the lower-right corner of the button.</p>	
<p>5. Dialog</p> <p>Pressing this button displays a dialog box or a list box. Press Esc to clear the dialog or list box. Dialog buttons are indicated by the 3 dots within a glowing green background in the lower-right corner of the button.</p>	
<p>6. Action</p> <p>Pressing an Action button triggers the function that is displayed on the submenu button.</p>	

Status Tool Bar

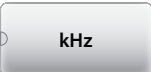
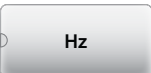
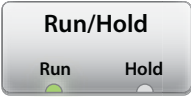
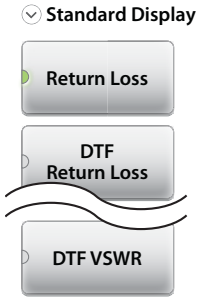
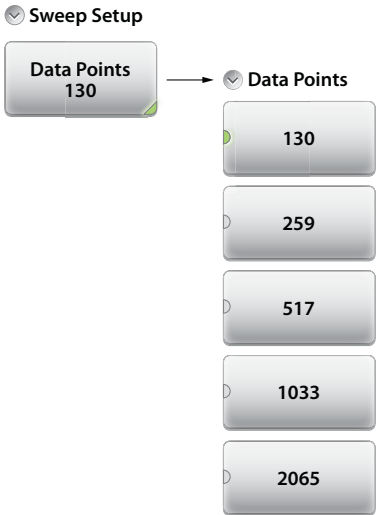
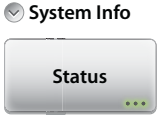
The Status Tool Bar includes icons to display the current time and date, battery charge, GPS status, and screen lock state. Tap one of the icons for additional information. [Figure 2-8](#) shows the icons that are displayed in the Status Tool Bar area.

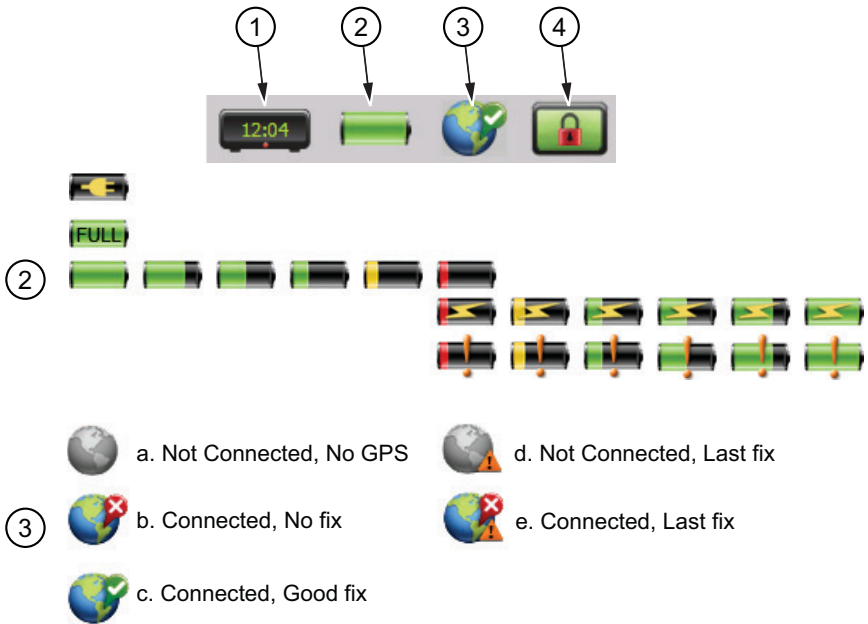

1. Clock icon. Press to set the current date, time, and time zone. Refer to [“Date/Time” on page 11-15](#).

Figure 2-8. Status Tool Bar Icons

- | | |
|----|--|
| 2. | <p>Battery icon. Press to view battery and charge status. Press Esc to close.</p> <p>The first row shows the icon when the Site Master is plugged into the AC adapter or car charger and the battery is not detected.</p> <p>The second row shows the battery icon when the battery is fully charged and the Site Master is plugged into the AC adaptor or car charger.</p> <p>The third row of battery icons show the charge level from 100 % to 2 % when the Site Master is running on battery power.</p> <p>The lightning bolt is displayed when the Site Master is charging from an AC adapter or the car charger and the battery is not fully charged yet.</p> <p>The fourth row shows the battery level from 2 % to 100 % under this condition.</p> <p>An exclamation point is displayed when the battery charging has paused, either due to the ambient temperature being too high or too low to safely charge the battery, or due to a fault in the battery. The exact cause is displayed in the battery dialog under charge status.</p> <p>The last row shows the battery level from 2 % to 100 % under this condition. The battery will resume charging automatically as soon as the pause conditions have changed.</p> <p>Refer to Chapter 12, “Battery Replacement” for additional information.</p> |
| 3. | <p>GPS icon. Press to view the current GPS information (Figure 2-9) obtained from an external USB-based GPS module. The icon indicates the status of the GPS module and location fix. After capturing a good fix, location data are saved with measurements (Figure 2-10) and screen captures.</p> <p>GPS status icon states:</p> <ol style="list-style-type: none"> GPS module (H/W) is not connected. Connect an Anritsu approved GPS module. H/W connected without a current location fix. Module attempts to establish a location fix during this state. H/W connected with a current location fix. H/W not connected, instrument using last saved location fix. Pressing Reset button places GPS in state “a.” H/W connected, GPS fix lost, using last saved location fix. Pressing Reset button places GPS in state “c.” |

Figure 2-8. Status Tool Bar Icons (Continued)

4. Touchscreen Lock icon. The Lock icon is displayed when the touchscreen is locked (**Touchscreen (0) > Lock**) or (**Touchscreen (0) > 1**). When locked, the touchscreen will not register user input. You may lock the screen in order to use the instrument exclusively with a USB mouse or with the Arrow Cursor control.

Unlock by using the keypad only: Press (**Touchscreen (0) > 1**). When the Touchscreen Control window is displayed, press the 1 key on the number keypad to toggle the setting to Off.

The touchscreen could also be locked if it was registering unintended input that was not resolved with a touchscreen calibration. This scenario may happen after touchscreen damage. The Site Master can continue to be used to make measurements and save files (even with touchscreen damage) by using a USB mouse or turning on the Arrow Cursor control. Refer to "[Touchscreen Menu](#)" on [page 11-3](#) for additional information.

Figure 2-8. Status Tool Bar Icons (Continued)

Caution

Use only Anritsu-approved batteries, adapters, and chargers with this instrument.

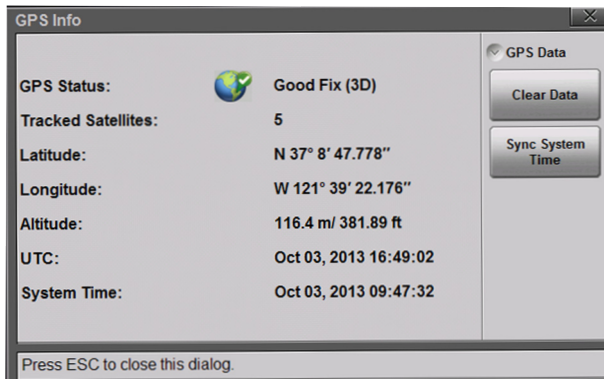

Figure 2-9. GPS Info

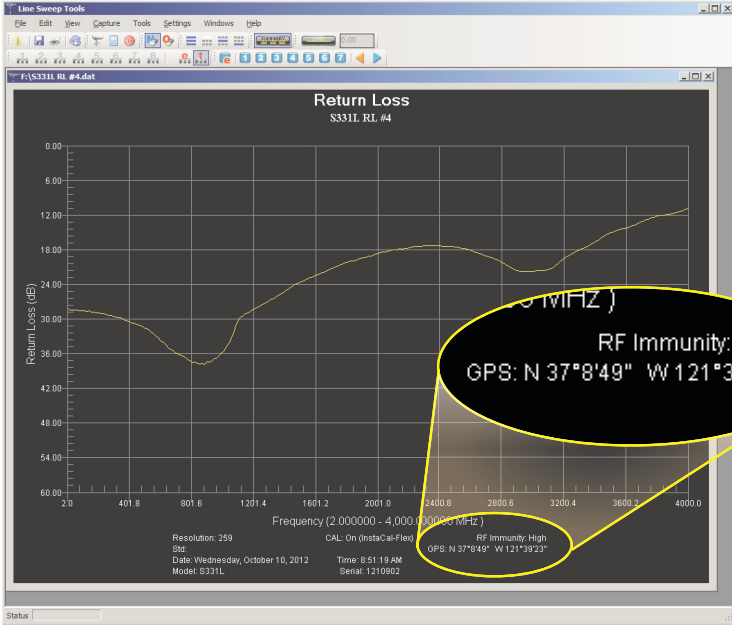
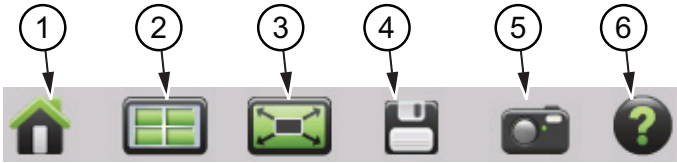

Figure 2-10. Location Data Saved in Measurement File

System Function Tool Bar

The System Function Tool Bar icons allow quick access to functions that are not measurement specific. [Figure 2-11](#) shows the icons that are displayed in the Status Tool Bar Area (Not available in Classic mode).



1.	Preset icon. Opens the Preset (1) Menu. See “Preset Menu” on page 11-27 for additional information.
2.	Mode Selector icon. Press to change measurement mode (including switching between <i>Advanced</i> and <i>Classic</i> Cable-Antenna Analyzer mode). Tap an icon (Figure 2-12 on page 2-24) to change modes or press Esc to cancel.
3.	Full Screen icon. Sets the display to full screen view mode (hides all of the tool bars, shortcut icons, and menus). Full screen view increases the view size of the graph. Press Esc to return to the standard view. Measurement menus are not available in Full screen mode. Refer to Figure 2-13 on page 2-25 for a comparison of the two views.
4.	Save icon. Shortcut to open the File (7) > Save menu. See “Save Files” on page 10-4 for additional information.
5.	Screen Capture icon. Press to capture and save an image of the current screen. The file is automatically saved to internal memory in the <code>ScrnShots</code> folder. The file is automatically named based on the measurement type and saved in Portable Network Graphics (.png) format. Refer to “Screen Shot Capture” on page 11-12 for examples and details on the image capture options (capture size, background color, and header/footer).
6.	Help icon. Shortcut to open the Help menu  . See “Help Menu” on page 11-5 for additional information.

Figure 2-11. System Function Tool Bar Icons

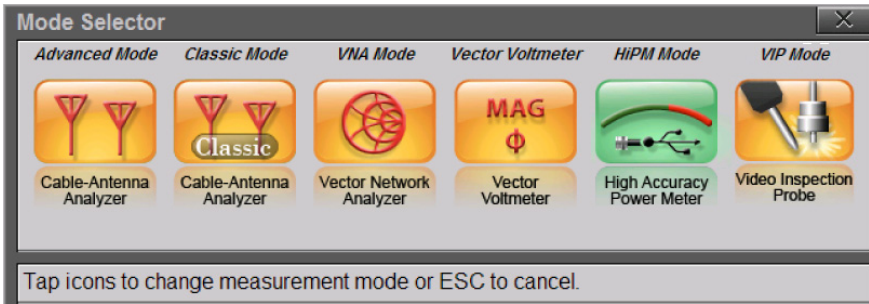
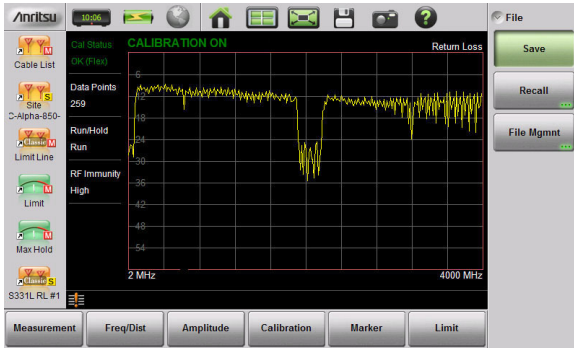
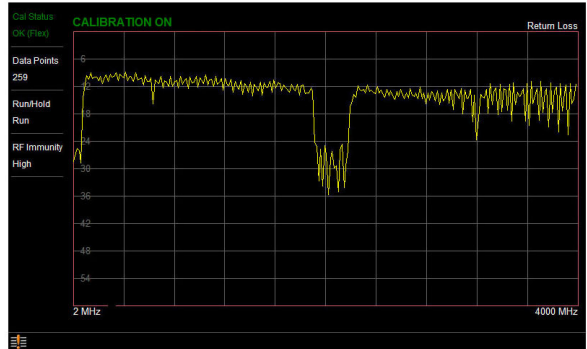

Figure 2-12. Mode Selector



Standard View



Full Screen View

Figure 2-13. Comparison of Standard Mode vs. Full Screen Mode

Dual Display Format

The S820E Microwave Site Master can display two different measurements simultaneously by setting the Display Format to Dual and then selecting the measurement to display.

Note Advanced measurements can be combined with Standard measurements.

Not all measurement combinations may be supported by Line Sweep Tools. Refer to the Line Sweep Tools Help menu for more information.

Different Amplitudes, Limit Lines, and Markers can be set for each display. If the Marker Table is turned On in Dual Display Mode, then the markers for only the active display are shown in the table.

Setting Single or Dual Display

1. Press the **Measurement** main menu key.
2. Toggle the Display Format submenu key so that it is set to Dual.

Saving Measurements in Dual Display

When saving a file while in dual display mode, both traces are saved in a single measurement file. The default filename will contain references to both trace types, but you can change the name, as with any file. Refer to “[Custom Name](#)” on page 10-10.

3. Change the active measurement by toggling the Active Display key or touching the display directly. The red outline around the graph indicates the active display.

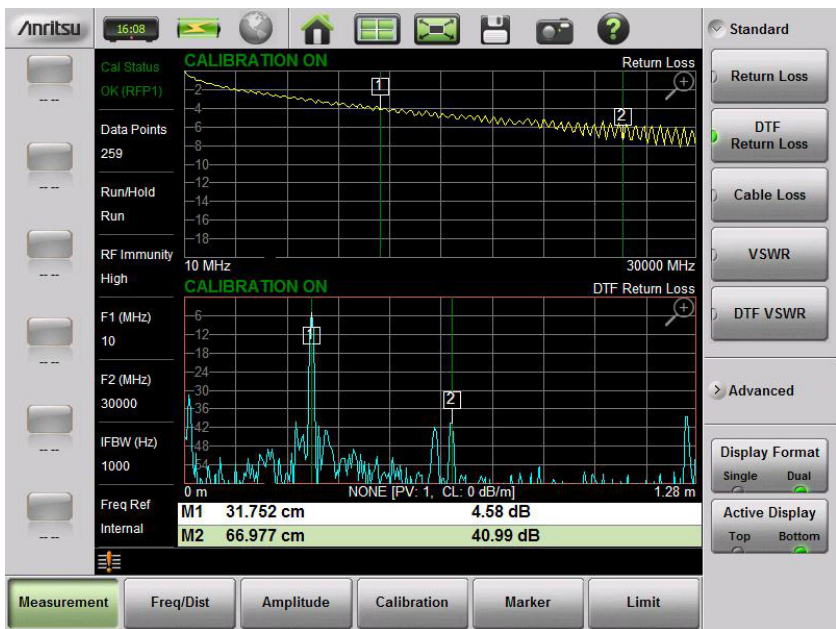



Figure 2-14. Dual Display Format with Bottom Display Active

- To maximize either the top display or bottom display while still in Dual display format, tap the magnifying glass symbol  in the upper-right corner of either graph. The graph maximizes, and the magnifying glass symbol changes from a (+) to a (-).
- Figure 2-15 on page 2-27 shows the Bottom graph maximized. Tapping on the magnifying glass restores the dual display.

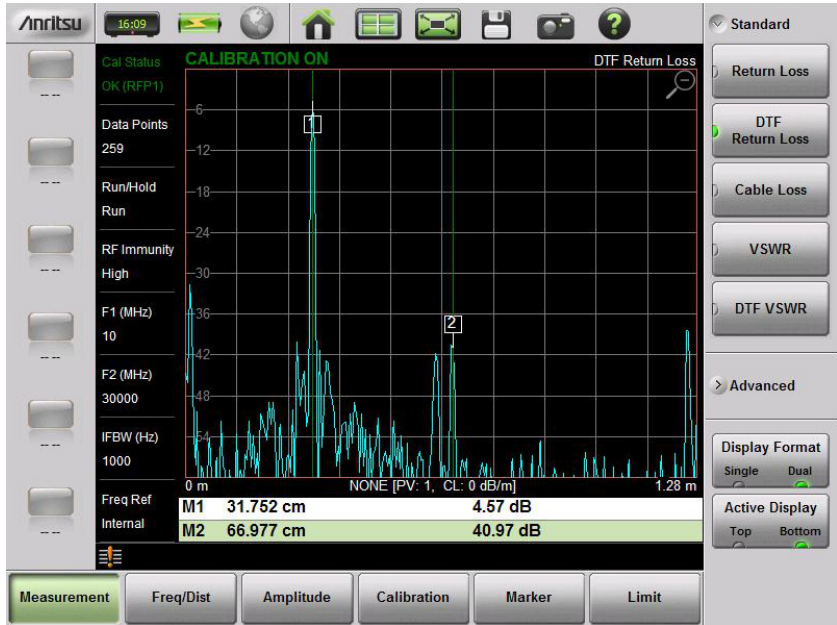

Figure 2-15. Dual Display Format with Bottom Display Maximized

Display Modes

In addition to the standard color display, the Site Master S820E offers the following Color Schemes:

Daytime for challenging daytime viewing conditions requiring increased contrast and brightness.

Nighttime optimized for night-time viewing with decreased contrast and brightness.

To change the display mode, **System (8)** > System Setups > Display/Audio and select one of the Color Schemes. Press **Enter** to set or **Esc** to cancel the display mode change.

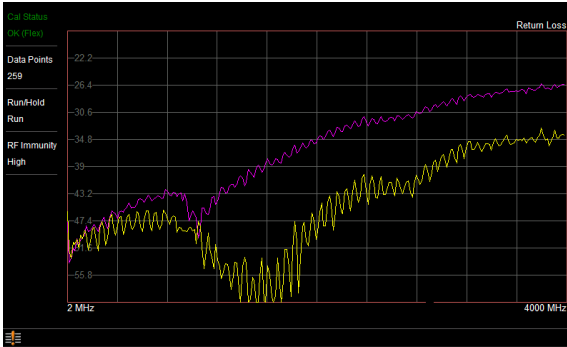

Standard

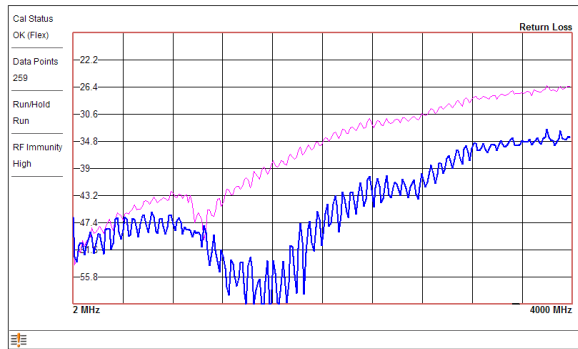

Daytime

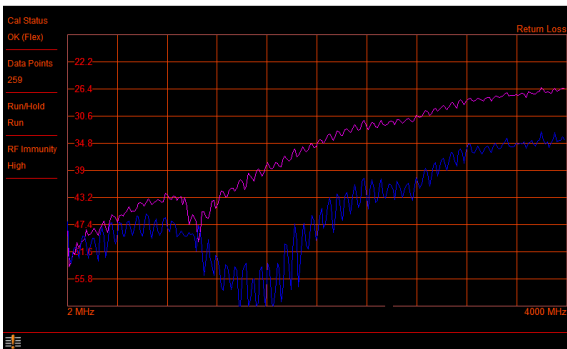

Nighttime

Figure 2-16. Site Master Color Schemes in Full Screen Mode

2-6 Calibration

The following symbols and indicators indicate the instrument status or condition on the display.

Calibration Symbols

The current calibration status and type is displayed in the upper-left of the screen when in Cable-Antenna Analyzer mode. The three status messages are described next.

Cal Status OK (Cal Type)

The Microwave Site Master has a valid calibration being applied. It is not possible to change the frequency range after calibration without performing another calibration. Note that the CALIBRATION OFF message can indicate different calibration conditions.

Cal Status -- **CALIBRATION OFF**

The Site Master has not yet been calibrated (-). Perform a calibration before making measurements.

Cal Status OFF **CALIBRATION OFF**

The Site Master has been calibrated, but Cal Correction is Off (**OFF**). The calibration correction has been turned Off by the user or by the recalled setup. Set the Cal Correction to On, or start a new calibration.

Cal Status OFF **CALIBRATION OFF (↓°C)**

The Site Master has been calibrated, but the instrument temperature has drifted more than ± 10 °C since the last valid calibration was performed (°C). A new calibration is required.

For calibration procedures refer to [Chapter 4](#).

2-7 Soft Carrying Case

The Site Master can be operated while in the soft carrying case. On the back of the case is a large storage pouch for accessories and supplies.

To install the instrument into the soft carrying case:

1. The front panel of the case is secured with hook-and-loop fasteners. Fully close the front panel of the case. When closed, the front panel supports the shape of the case while you are inserting the Site Master.
2. Place the soft carrying case face down on a stable surface, with the front panel fully closed and laying flat.

Note

The soft case has two zippers near the back. The zipper closer to the front of the case opens to install and remove the instrument. The zipper closer to the back of the case opens an adjustable support panel (tilt bail panel) that can be used to provide support for improved stability and air flow while the instrument is in the case. This support panel also contains the storage pouch.

3. Open the zippered back of the case.
4. Insert the instrument face down into the case, taking care that the connectors are properly situated in the case top opening. You may find it easier to insert the connectors first, then pull the corners over the bottom of the Site Master.
5. Close the back panel and secure it with the zipper to secure the Site Master.

The soft carrying case includes a detachable shoulder strap, which can be connected to the D-rings of the case.

Caution

The soft case has panel openings for the fan inlet and exhaust ports. Do not block the air flow through the panels when the instrument is operating.



Figure 2-17. Instrument Inserted into the Soft Carrying Case

2-8 Tilt Bail Stand

A Tilt Bail is attached to the back of the Site Master for desktop operation. The tilt bail provides two settings of backward tilt for improved stability. To deploy the tilt bail, pull the bottom of the tilt bail away from the back of the instrument. To store the tilt bail, push the bottom of the bail towards the back of the instrument until it attaches to the Site Master.

Note Do not use the tilt bail while the instrument is in the soft case. The soft case has an adjustable tilt bail panel in the back zipper.



Figure 2-18. Tilt Bail Extended (different model shown)

Chapter 3 — Cable and Antenna Measurements

3-1 Introduction

This chapter provides an overview of Cable and Antenna measurements and how to set up the instrument and perform basic line sweeps.

Note

Use the **Menu** key and confirm that the instrument is in Cable-Antenna Analyzer Advanced mode (*not Classic mode*). In Classic mode, **Classic Mode** is clearly displayed at the top of the instrument screen in the System Function Tool Bar.

Figure 3-1 illustrates a typical Cable and Antenna Return Loss measurement.

Note

Screen images in this User Guide are illustrations of typical instrument features. Some images may include instruments other than the Site Master S820E. Traces and other display features may differ from the screen displays of your instrument.

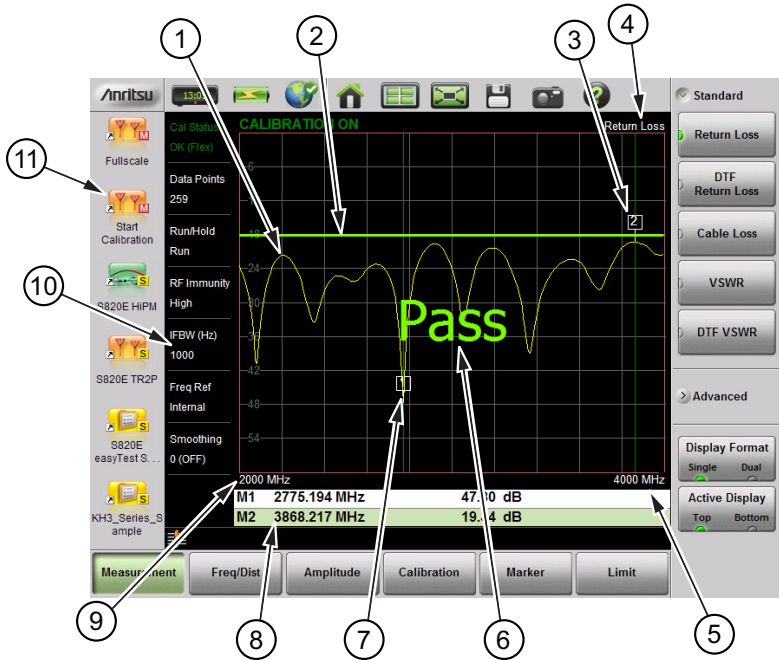

1.	Active Trace (Yellow)
2.	Limit Line (Green when Passing)
3.	Marker 2 (Marker to Peak)
4.	Measurement Type
5.	Stop Frequency (F2)
6.	Pass Message (Active trace is below the limit line in Return Loss measurement)
7.	Marker 1 (Marker to Valley)
8.	Marker Table
9.	Start Frequency
10.	Measurement Details (also Menu Shortcuts)
11.	User-defined Setup and Menu Shortcuts (not available in Classic mode)

Figure 3-1. Cable and Antenna Display Overview

3-2 Standard Measurements

The following sections describe the typical line sweep measurements that are used to analyze the performance of a transmission feed line system including Return Loss, Cable Loss, and DTF.

Note

Anritsu recommends using phase-stable test port cables when making measurements. Attach the cables to the port connectors of the Microwave Site Master and calibrate at the open end of the cables.

3-3 Return Loss or VSWR Measurement

Return Loss measures the reflected power of the system in decibels (dB). This measurement can also be taken in the Standing Wave Ratio (SWR) mode, which is the ratio of voltage peaks to voltage valleys caused by reflections.

System Return Loss measurement verifies the performance of the transmission feed line system with the antenna connected at the end of the transmission line. [Figure 3-2](#) and [Figure 3-3](#) show a sample antenna measured using Return Loss and using VSWR.

Device Under Test: Feed line with Antenna

1. Press the **Measurement** main menu key, under the **Standard** submenu, select **Return Loss** or **VSWR**.
2. Press the **Freq/Dist** main menu key and enter the start and stop frequencies.
3. Press the **Amplitude** main menu key and enter the top and bottom values for the display or press **Fullscale**.
4. Press the **Calibration** main menu key and perform a calibration of the instrument. Anritsu suggests using a phase-stable test port cable. See [Chapter 4](#) for details.
5. Connect the Site Master to the Device Under Test using the calibrated phase-stable test port cable.
6. Press the **Marker** main menu key and set the appropriate markers as described in [“Markers” on page 3-40](#).
7. Press the **Limit** main menu key to enter and set the limit line as described in [“Limit Lines” on page 3-34](#).
8. Press **File (7)** then **Save** to save the measurement to memory. Refer to [Chapter 10](#) for details on setting the save location.

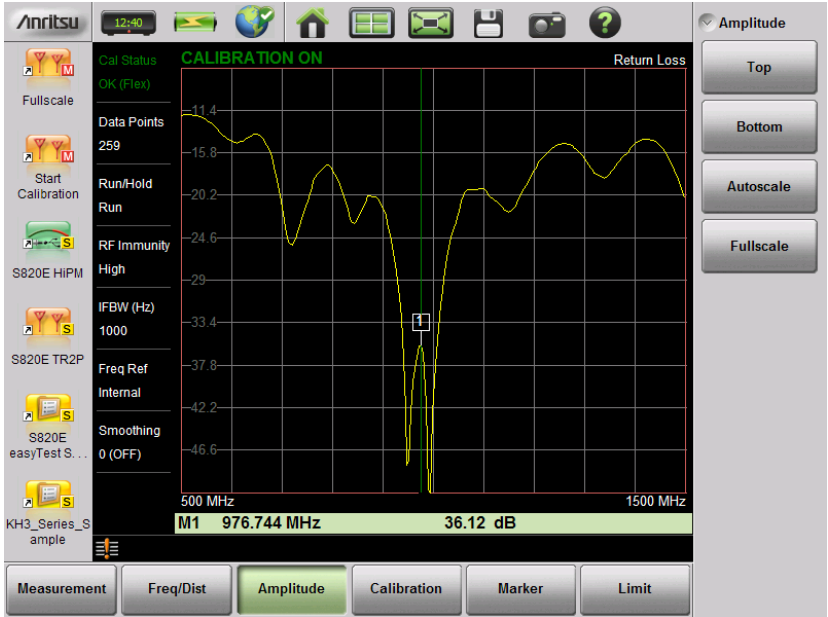

Figure 3-2. Antenna Return Loss Trace

3-3 Return Loss or VSWR Measurement Cable and Antenna Measurements

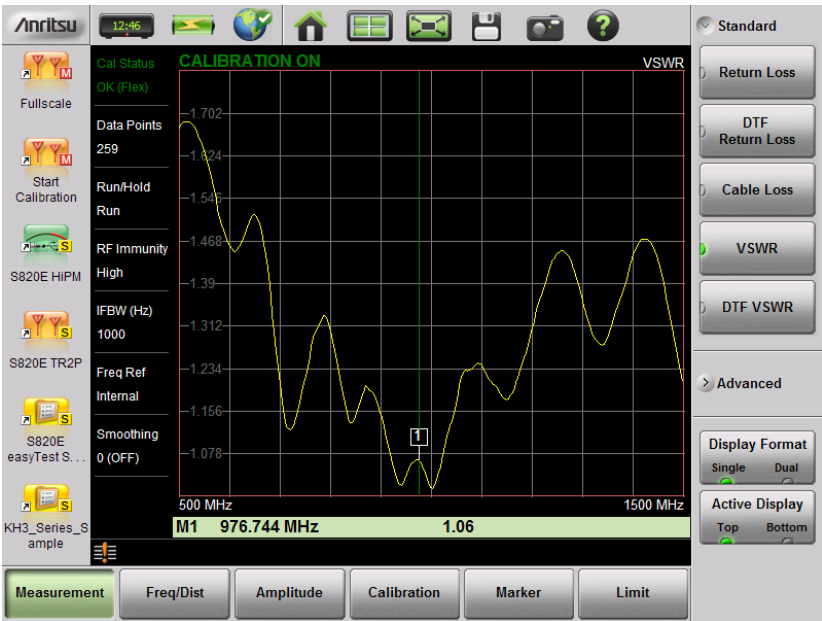

Figure 3-3. Same Antenna Trace in VSWR

3-4 Cable Loss Measurement

The transmission feed line insertion loss test verifies the signal attenuation level of the cable system in reference to the specification. The average cable loss of the frequency range is displayed on the screen in the measurement settings summary area.

Device Under Test: Transmission Feed line with Short

1. Press the **Measurement** main menu key, under the **Standard** submenu, select **Cable Loss**.
2. Press the **Freq/Dist** main menu key and enter start and stop frequencies.
3. Press the **Amplitude** main menu key and enter top and bottom values for the display or press **Full Scale**.
4. Press the **Calibration** main menu key to start calibration of the instrument. Anritsu suggests using a phase-stable test port cable. See [Chapter 4](#) for details.
5. Connect the Site Master to the Device Under Test using the calibrated phase-stable test port cable.
6. Press the **Limit** main menu key to enter and set the limit line as described in [“Limit Lines” on page 3-34](#). This limit line is used only for visual reference and not a pass/fail guide. The pass/fail determination is based on the average cable loss.
7. Press **File (7)** then **Save** to save the measurement to memory. Refer to [“Save Files” on page 10-4](#) for details on setting the save location.

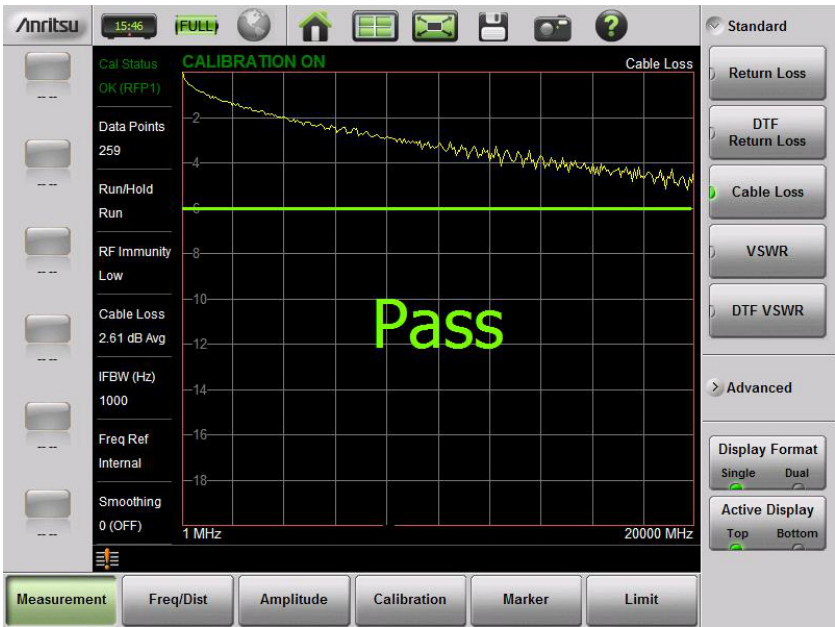

Figure 3-4. Cable Loss Measurement

3-5 Distance-To-Fault (DTF)

DTF reveals the precise fault location of components in the transmission line system. This test helps to identify specific problems in the system, such as connector transitions, jumpers, kinks in a cable, moisture intrusion, or mechanical damage.

The first step is to measure the distance of a cable, this measurement can be made with an open or a short connected at the end of the cable. The peak indicating the end of the cable should be between 0 dB and 5 dB. An open or short should not be used when DTF is used for troubleshooting the system because the open/short reflects most of the RF energy from the Site Master. The true value of a connector might be misinterpreted, or a good connector might look like a failing connector.

A 50 Ω load is the best termination for troubleshooting DTF problems because it will be 50 Ω over the entire frequency range. The antenna can also be used as a terminating device, but the impedance of the antenna will change over different frequencies because the antenna is typically designed to have only 15 dB or better return loss in the passband of the antenna.

DTF measurement is a frequency domain measurement, and the data are transformed to the time domain. The distance information is obtained by analyzing how much the phase is changing when the system is swept in the frequency domain. Frequency selective devices such as TMAs (Tower Mounted Amplifiers), duplexers, filters, and quarter wave lightning arrestors change the phase information (distance information) if they are not swept over the correct frequencies. Care needs to be taken when setting up the frequency range whenever a TMA is present in the path.

Using DTF Aid

Because of the nature of the measurement, maximum distance range and distance resolution is dependent upon the frequency range and number of data points. DTF Aid (**Freq/Distance** > Distance > DTF Aid) shown in [Figure 3-5](#) explains how the parameters are related.

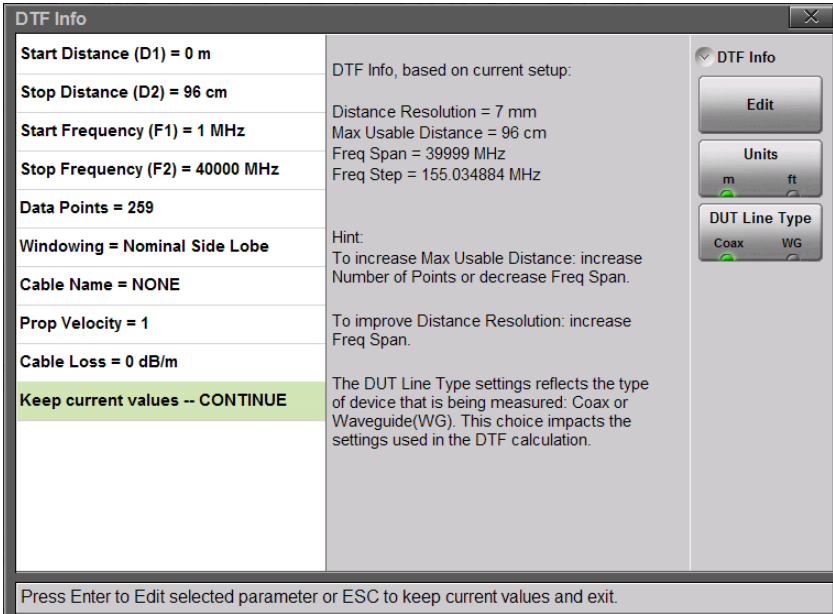

Figure 3-5. DTF Aid

If the cable or waveguide is longer than the Max Usable Distance displayed, then the only way to improve the horizontal range is to reduce the frequency span or to increase the number of data points. Similarly, the distance resolution is inversely proportional to the frequency range and the only way to improve the distance resolution is to widen the frequency span.

Note When determining the frequency range, consider all in-line frequency selective devices.

Transmission Line Selection

The Microwave Site Master 820E is capable of measuring either coaxial cable or waveguide feeder lines. Selecting the correct coaxial or waveguide type is critical for accurate DTF measurements. Incorrect propagation velocity (or Cut Off Frequency in the case of waveguide) values affect the distance accuracy, and inaccurate attenuation values affect the accuracy of the amplitude values.

Selecting the line type or creating a custom type is described in the following sections.

Cable List

The Microwave Site Master S820E is equipped with a built-in, predefined cable list (**Freq/Dist > DTF Setup > Cable List**), which includes most of the common cables that are currently in use. After the correct cable has been selected, the instrument updates the propagation velocity and the cable attenuation values to correspond with the cable. For setups with several different cables types, choose the main feeder cable.

Note

If the Cable list button is not displaying, then toggle DUT Line Type to Coax

For cables not on the list, select NONE and manually enter the Prop Velocity and Cable Loss in DTF Aid or the DTF Setup submenu.

Note

Custom cable settings that are entered manually are not saved when the instrument is preset, reset, or turned Off.

Custom Cables can be created and uploaded to the instrument by using Line Sweep Tools (LST). Instructions for using the LST Cable Editor are available in the LST software Help menu. The latest version of LST is available from the Anritsu web site: <http://www.anritsu.com>

The name, propagation velocity, and cable loss of the selected cable is displayed below the graph during distance measurements (**Measurement > DTF Return Loss** or **DTF VSWR**) as shown in (Figure 3-6).

Waveguide List

The Site Master S820E is equipped with a built-in, predefined waveguide list (**Freq/Dist** > **DTF Setup** > **Waveguide List**) including most of the common waveguides currently in use.

Note	If the Waveguide list button is not displaying, then toggle DUT Line Type to WG
-------------	---

After the correct waveguide has been selected, the instrument updates the Cutoff Frequency and the waveguide attenuation values to correspond with the waveguide. For setups with several different types, choose the main feeder waveguide.

For waveguides not on the list, select **NONE** and manually enter the Waveguide Loss and Cutoff Freq in DTF Aid or the DTF Setup submenu.

Note	Custom waveguide settings that are entered manually are not saved when the instrument is preset, reset, or turned off.
-------------	--

Custom waveguides can be created and uploaded to the instrument using Line Sweep Tools (LST). Instructions for using the LST Waveguide Editor are available in the software's Help menu. The latest version of LST is available from the Anritsu web site: <http://www.anritsu.com>

The name, cutoff frequency, and waveguide loss of the selected cable is displayed below the graph during distance measurements (**Measurement** > DTF Return Loss or DTF VSWR).

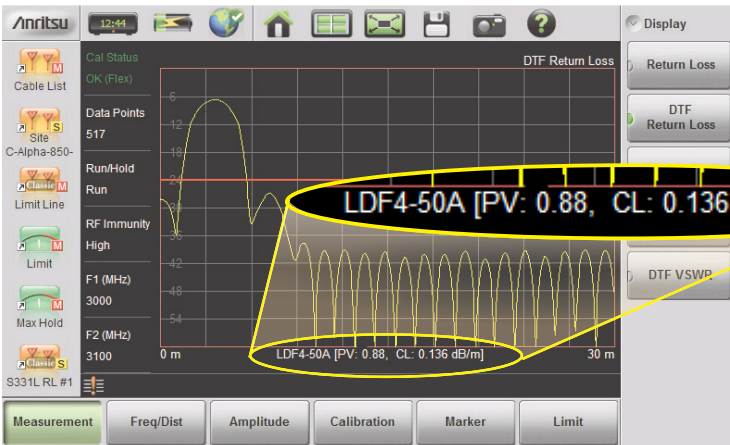
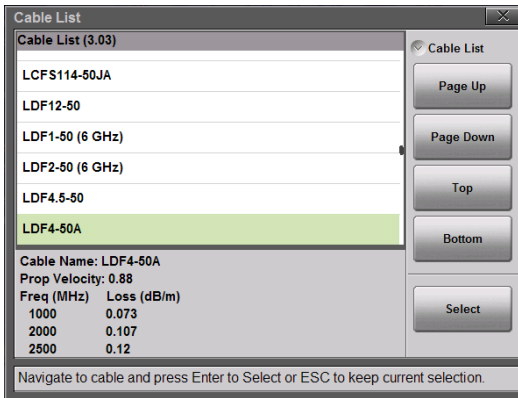

Figure 3-6. Cable List Selection Displayed Under the Graph

Distance Resolution

Distance resolution is the ability of the Site Master to separate two closely spaced discontinuities. If the resolution is 5 meters and two faults are 3 meters apart, then the Site Master will not be able to show both faults until the resolution is improved by widening the frequency span.

$$\text{Distance Resolution (m)} = 300 \times \text{pv} / \Delta F \text{ (MHz)}$$

Figure 3-7 is an example of the same DTF measurement with a 100 MHz span versus a 500 MHz span. The increased span provides additional detail that several unique issues may affect the first 10 meters of the cable. This detail was not available in the narrower span.

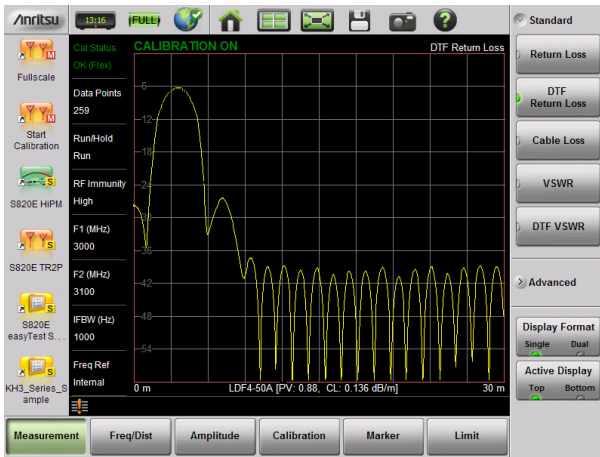

100 MHz Span

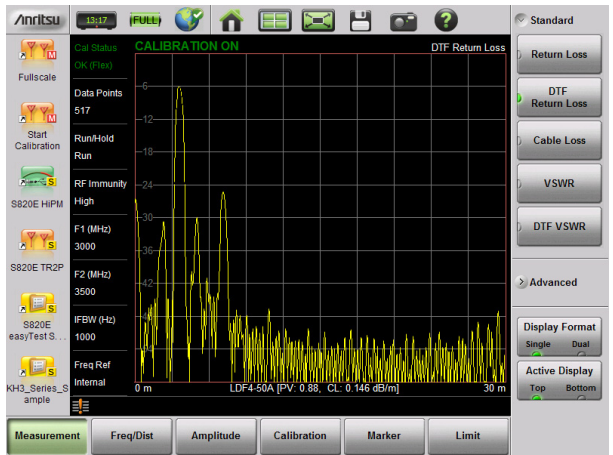

500 MHz Span

Figure 3-7. DTF Measurements at 100 MHz vs. 500 MHz

Windowing

The theoretical requirement for inverse FFT is for the data to extend from zero frequency to infinity. Side lobes appear around a discontinuity because the spectrum is cut off at a finite frequency. Windowing reduces the side lobes by smoothing out the sharp transitions at the beginning and the end of the frequency sweep. As the side lobes are reduced, the main lobe widens, thereby reducing the resolution.

In situations where a small discontinuity may be close to a large one, side lobe reduction windowing helps to reveal the discrete discontinuities. If distance resolution is critical, then reduce the windowing for greater signal resolution.

If two or more signals are very near to each other, then spectral resolution is important. In this case, use **Rectangular Windowing** for the sharpest main lobe (the best resolution).

In summary:

- **Rectangular Windowing** provides best spatial distance resolution for revealing closely spaced events, but the side lobes close to any major event (large reflection) may mask smaller events which are close to the major event. Excellent choice if you suspect multiple faults of similar amplitudes close together.
- **Nominal Side Lobe Windowing** provides very good suppression of close-in side lobes, but compromises spatial distance resolution compared to Rectangular windowing. Closely spaced events may appear as a single event, often non-symmetrical in shape. Excellent overall choice for most typical antenna system sweeps.
- **Low Side Lobe Windowing** provides excellent suppression of close-in side lobes, but spatial distance resolution is worse than Nominal Side Lobe. The additional suppression of side lobes may be useful in locating very small reflection events further away from large events. *This is not often used for field measurements.*
- **Minimum Side Lobe Windowing** provides the highest suppression of side lobes but the worst spatial distance resolution. It can be useful for finding extremely small events spaced further apart than the distance resolution. *This is not typically used for field measurements.*

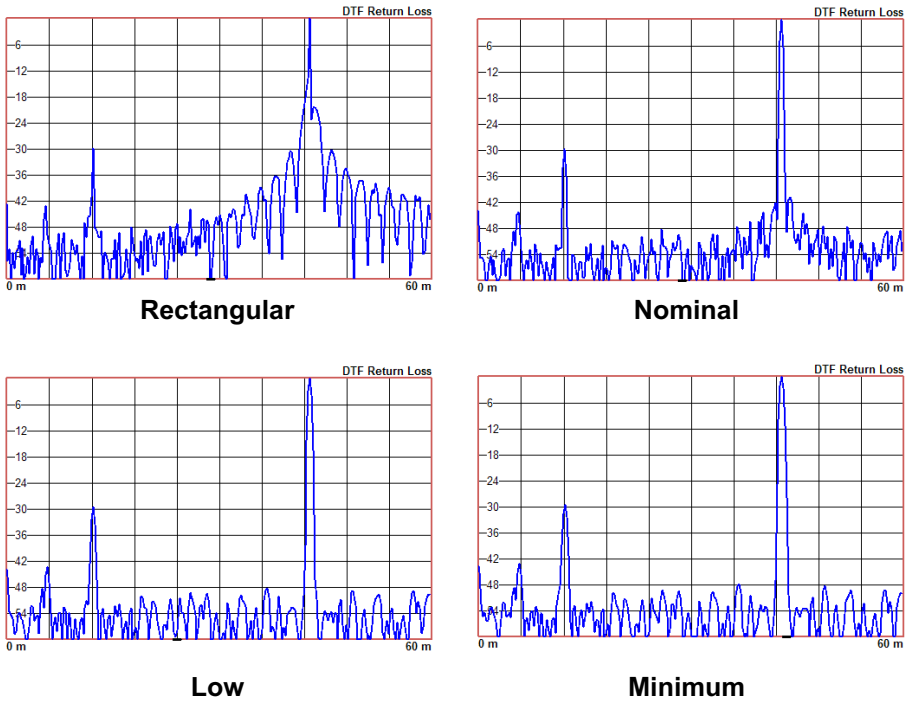

Figure 3-8. Effects of Windowing on a Sample Trace

DMax (Maximum Usable Distance)

DMax is the maximum horizontal distance that can be analyzed. The Stop Distance cannot exceed DMax. If the cable is longer than DMax, then DMax needs to be improved by increasing the number of data points or by lowering the frequency span (ΔF). Note that the data points can be set to 130, 259, 517, 1033, or 2065 (**Sweep** > Data Points).

$$D_{\text{Max}} = (\text{Data points} - 1) \times \text{Distance Resolution}$$

DTF Measurement Examples

1. Press the **Measurement** main menu key and select DTF Return Loss or DTF VSWR.
2. Press the **Freq/Dist** main menu key.
3. Press the **Distance** submenu key and then select DTF Aid. Use the touchscreen, rotary knob, or **Up/Down Arrow** keys to navigate through all the DTF parameters.
 - l. Highlight a parameter in the DTF Aid table to edit and then press Edit or **Enter** to display a parameter for editing.
 - m. Edit all required parameters and then highlight Keep current values – CONTINUE and press **Enter**.

Note	If Stop Distance is greater than DMax, then increase the number of data points or reduce the frequency span accordingly.
-------------	--

4. Connect a phase-stable Test Port cable to the RF Out/Reflect In connector on the Site Master. Press the **Calibration** main menu key to start calibration of the instrument. Refer to [Chapter 4](#) for details.
5. Connect the Site Master to the Device Under Test using the calibrated phase-stable test port cable.

Example 1 – DTF with a Short to Measure Cable Length

To measure the length of a cable, DTF measurements can be made with an open or a short connected at the end of the cable. The peak indicating the end of the cable should be between 0 dB and 5 dB. In [Figure 3-9 on page 3-19](#) the cable end is at 15 meters.

The cable end was found by selecting Marker 3 (**Marker > Select M(1-8) > M3**) then using searching for the trace peak (**Marker > Marker Search > Marker to Peak**).

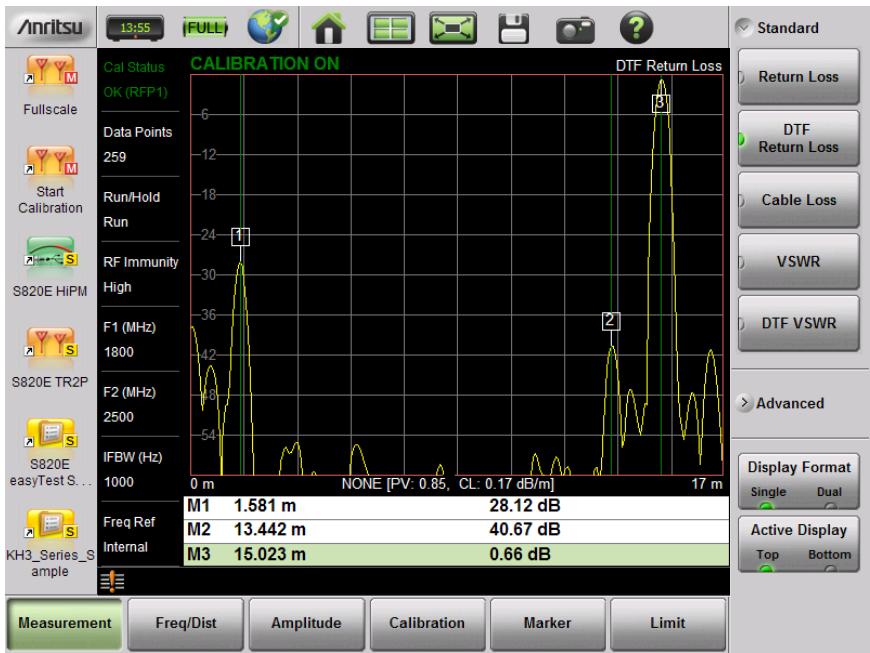

Figure 3-9. DTF Return Loss with Short at End of Cable (15 m)

Note

In [Figure 3-9](#), M1 and M2 are jumper cable connections. The peak beyond the end of the cable at M3 is the return reflection of the M2 peak.

Example 2 – DTF Transmission Line Test

The Distance-To-Fault transmission line test verifies the performance of the transmission line assembly and its components and identifies the fault locations in the transmission line system. This test determines the return loss value of each connector pair, cable component and cable to identify the problem location. This test can be performed in the DTF-Return Loss or DTF-VSWR mode. Typically, for field applications, the DTF-Return Loss mode is used. Figure 3-10 on page 3-20 shows the failure with the antenna still attached.

To perform this test, disconnect the antenna and connect the load at the end of the transmission line (Figure 3-11 on page 3-21).

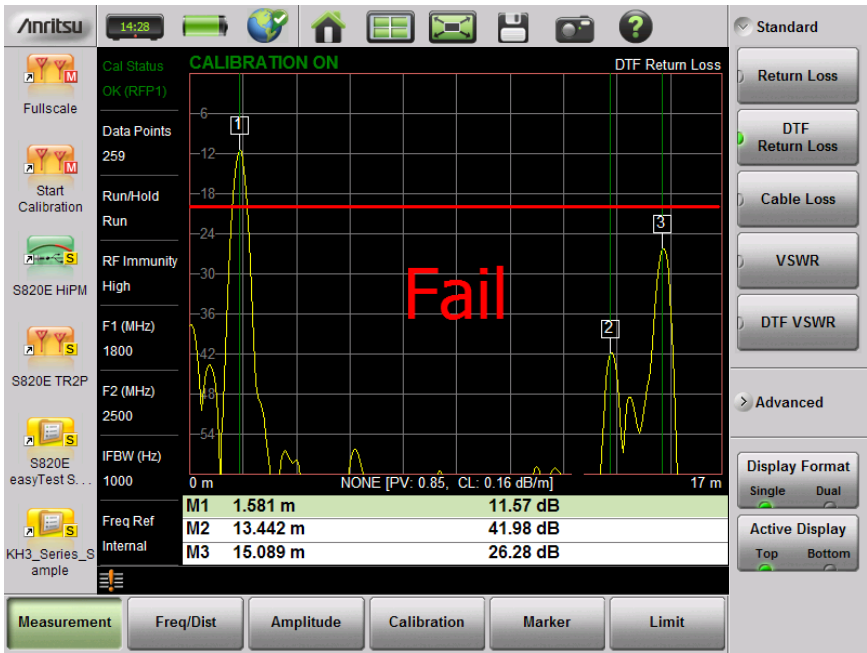

Figure 3-10. DTF Return Loss Measurement (Antenna at 15 m)

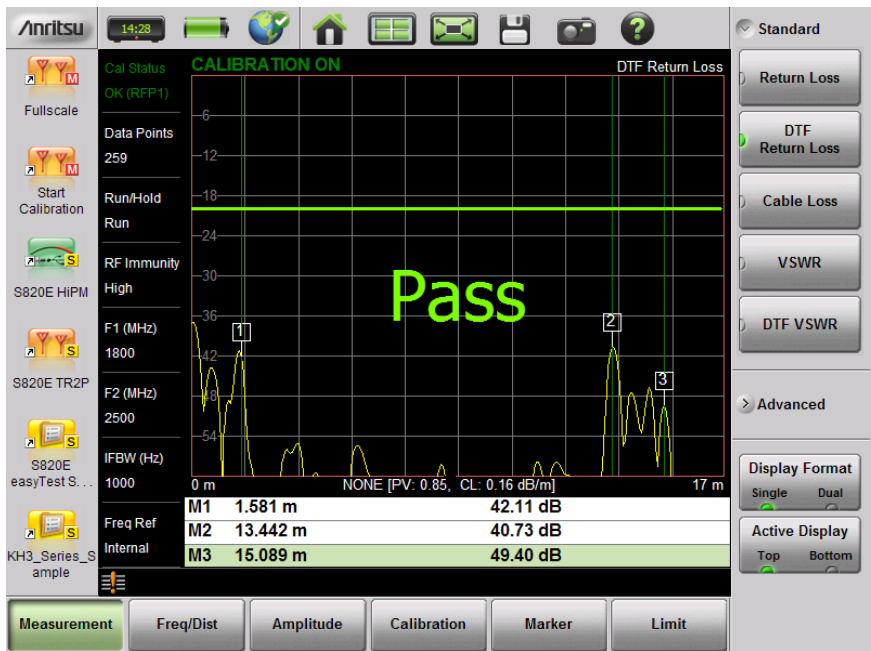

Figure 3-11. Failing DTF Return Loss Measurement (Load at 15 m)

The jumper connector at 1.5 m was found to be loose and dirty. After cleaning and tightening to specification, another DTF measurement showed that the connector now passed the carrier 20 dB specification, indicated by the limit line.

Figure 3-12 shows the same system with the antenna reattached. The reflection of the jumper connector is now reduced to 41.18 dB.

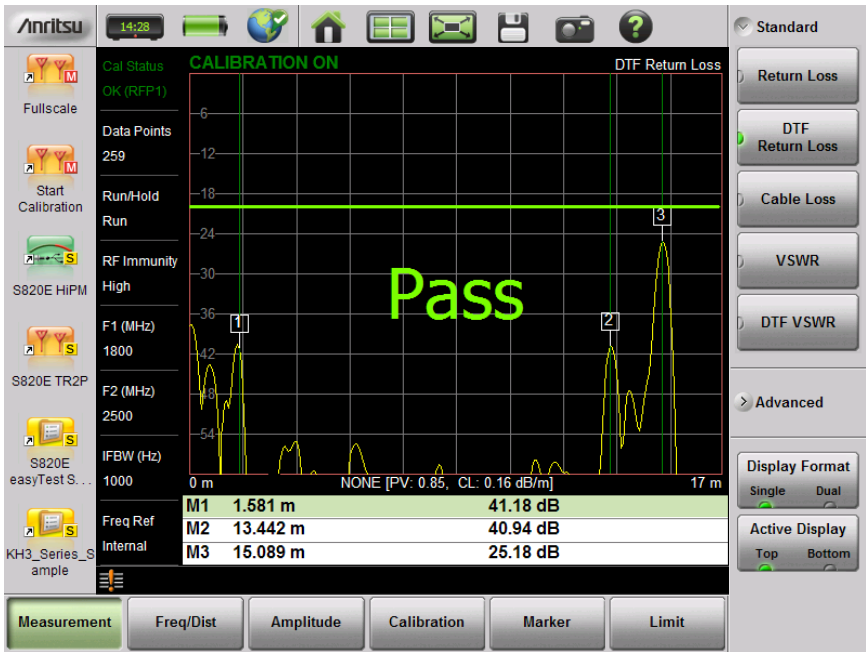

Figure 3-12. DTF Return Loss Measurement (Antenna at 15 m)

3-6 Advanced Measurements

Transmission Measurements

The S820E can measure insertion loss of cables (or other 2-port devices) using three different methods. If you have access to connect only one end of the cable to the instrument, then you must perform either One Port Testing using Cable Loss - One Port mode, or two port Transmission measurements using an external USB sensor.

For One Port Testing, the other end of the cable must be terminated in a short or open to provide a full reflection of the signal. This method provides accurate results when the cable loss is less than 10 dB.

When the cable loss values are higher than 10 dB, then the two-port method must be used to obtain accurate results. If you are able to connect both ends of the cable to Port 1 and Port 2 of the Site Master (either directly or through a port extension cable), then you can use the 2-port Transmission method. If you are able to connect only one end of the cable to the Site Master, then you can use the Transmission measurement with External Sensor.

Press the **Advanced** submenu key to access the following measurements.

Transmission (2-Port)

The S820E provides the capability to perform 2-port vector-corrected transmission measurements. These measurements are used to verify the performance of amplifiers and duplexers, as well as to verify antenna isolation. The excellent dynamic range also makes this measurement suitable for repeaters. When access is available to both ends of a cable or waveguide, the 2-port transmission measurement provides the most accurate method to measure the attenuation in the cable or waveguide. [Figure 3-13](#) is a 2-Port transmission measurement example for a WR-62 waveguide. [Figure 3-13](#) is a 2-Port transmission measurement example for a WR-62 waveguide.



Figure 3-13. 2-Port Transmission Measurement Example, Waveguide

Figure 3-14 is a 2-Port transmission cable loss measurement example.



Figure 3-14. 2-Port Transmission Cable Loss Measurement Example

Transmission (Ext. Sensor)

If you are able to connect only one end of the cable to the Site Master, then you can use the Transmission measurement with External Sensor. For this measurement, you connect the cable under test to Port 1 of the Site Master, and you connect a USB transmission sensor or power sensor to the other end of the cable. USB extenders can be used for long cable runs. This measurement provides accurate results of cable loss up to 30 dB. This is a scalar measurement, providing only magnitude data (no phase) and, therefore, does not use vector error correction for its calibration steps. Instead, it uses a sensor reference calibration. [Figure 3-15](#) is a Cable Loss Measurement Example of an External Sensor Transmission.



Figure 3-15. External Sensor Transmission Measurement Example

When performing both transmission and return loss measurements on the same cable, for best results, the return loss should be measured with a good-quality termination at the end of the cable.

Figure 3-16 shows a comparison between measurements made using both 2-Port and External Scalar Transmission methods. The 2-Port Transmission measurement will always produce the most accurate results. Even with 20 dB of loss, however, the External Sensor Transmission measurement produces results that are comparable, as shown in the figure.

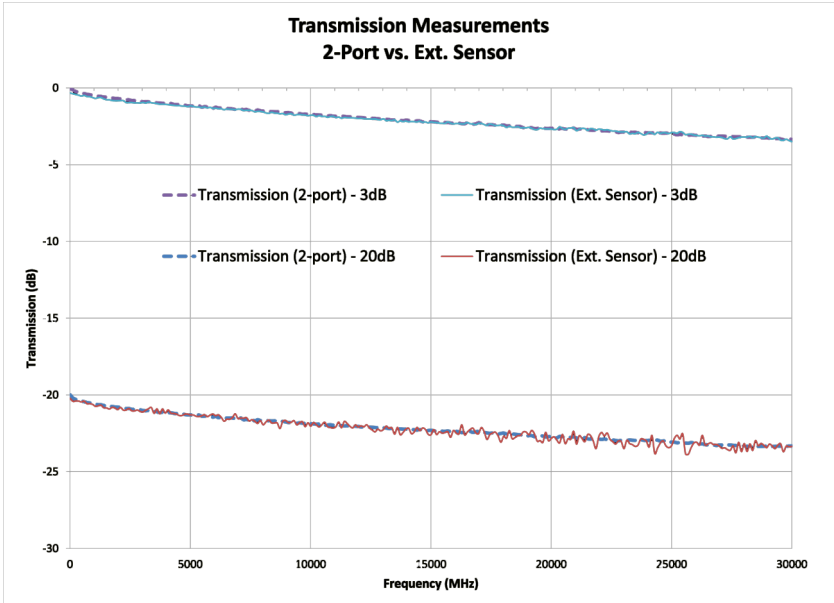

Figure 3-16. Transmission Measurements Compared

Note

The external USB sensors that are supported by the S820E for transmission measurements are the SC8268 Transmission Sensor and the USB power sensors that are listed in the S820E Technical Data Sheet.

Smith Chart

The Smith Chart is a graphical tool for plotting impedance data versus frequency. It converts the measured reflection coefficient data into impedance data and displays it in a manner that makes the Smith Chart a useful tool for determining and tuning input match. This complex impedance plot reveals which matching elements (capacitance, inductance) are necessary to match a device under test to the reference impedance (which can be set to either 50 ohms or 75 ohms). Markers can be used to read the real and imaginary parts of the complex impedance.

1-Port Phase

The S820E can display the phase of the reflection measurements at Port 1. The Phase display range is from -450 degrees to $+450$ degrees.

The 1-port phase measurement is most useful when making relative measurements (comparing the phase of one device to the phase of another) by utilizing the Trace Math function (Trace – Memory).

3-7 Measurement Setup

This section briefly describes how to setup the Cable and Antenna parameters, markers, and limit lines.

Frequency

Setting up the Measurement Frequency using Start and Stop Frequencies

1. Press the **Freq/Dist** main menu key then Frequency if the menu is collapsed.
2. Press the Start Freq (F1) submenu key and enter the start frequency using the **Up/Down Arrow** keys, rotary knob or keypad. When using the keypad, the button labels change to GHz, MHz, kHz, and Hz. Press the appropriate unit key to complete the entry.
3. Press Stop Freq (F2) and enter the stop frequency.

Distance

1. Press the **Freq/Dist** main menu key and then Distance if the menu is collapsed.
2. Press the Start Distance (D1) submenu key and enter the start distance using the **Up/Down Arrow** keys, rotary knob or keypad. When entering a distance using the keypad, press the unit key to complete the entry.
3. Press Stop Distance (D2) and enter the stop distance.

DTF Aid

Refer to [“DTF Measurement Examples” on page 3-18.](#)

Amplitude

Setting the Amplitude using Top and Bottom Keys

1. Press the **Amplitude** main menu key.
2. Press the Top submenu key and use the keypad, rotary knob, or the **Up/Down Arrow** keys to edit the top scale value. Press **Enter** to set.
3. Press the Bottom key and use the keypad, rotary knob, or the **Up/Down Arrow** keys to edit the bottom scale value. Press **Enter** to set.

Setting the Amplitude using Autoscale

The instrument automatically sets the top and bottom scales to display the current measurement.

1. Press the **Amplitude** main menu key
2. Press the Autoscale submenu key

Setting the Amplitude using Fullscale

To automatically set the scale to the default setting, press the Scale Preset key.

1. Press the **Amplitude** main menu key.
2. Press the Scale Preset submenu key.

The instrument automatically sets the top and bottom scales to the default values based on the measurement type.

Scale Preset does not default to the maximum allowable scale range. To set the scale to a range greater than the Scale Preset range, either press the Fullscale key to get the maximum settings available for the measurement, or manually enter the value when the parameter entry window is open by using the **Arrow** keys, the rotary knob, or the number keypad.

Refer to “Amplitude Menu” on page 3-61 for additional information.

Sweep

The **Sweep** menu include keys to set Data Points, Run/Hold, Sweep Type, RF Immunity, RF Pwr In Hold, Source Power, IFBW, Smoothing, and Sweep Averaging.

Data Points

The number of data points can be set to 130, 259, 517, 1033, or 2065 data points. This can be changed before or after calibration, with one exception (refer to the **Note on page 3-31**). The default setting is 259. This is recommended for most measurements. Additional data points slow down the sweep speed but are helpful in DTF, because they enable increased distance coverage for the same distance resolution.

1. Press the **Sweep (3)** menu key then press Data Points.
2. Select 130, 259, 517, 1033, or 2065 data points.

Refer to “[Sweep Menu](#)” on page 3-67 for additional information about the **Sweep** menu and submenus.

Note

Setting Data Points to 2065 can invalidate an active Standard Cal correction that was performed with a lower number of data points. If this occurs, then a new calibration is recommended before making measurements.

To prevent this from occurring, set the number of data points to 2065 before performing any calibration. If this step is done before calibrating, then you may freely switch between any number of data points after calibrating.

Run/Hold

Controls if the instrument is actively sweeping the frequency range. When Sweep Trigger Type is set to Single mode, this key also provides a single sweep trigger.

1. Press the **Sweep (3)** menu key.
2. Toggle the Run/Hold key.

Sweep Trigger Type

The Sweep Trigger submenu key sets the type of trigger that initiates a sweep. The trigger can be internal (single or continuous) or external. Continuous is the default setting.

In continuous sweep mode, a new sweep is triggered automatically at the end of each sweep. In single sweep mode, each sweep is activated by the Run/Hold key. In external trigger mode, each sweep is activated by a TTL signal at the External Trigger In connector.

1. Press the **Sweep (3)** menu key.
2. Toggle the Sweep Trigger key through Single, Continuous, and External Trigger.

RF Immunity

The instrument defaults to RF Immunity Low. When set to High, RF Immunity protects the instrument from stray signals generated by nearby or co-located transmitters that can affect frequency and DTF measurements. The algorithm that is used to improve instrument ability to reject unwanted signals may slow down the sweep speed if interferers are detected. If the instrument is used in an environment where immunity is not an issue, then the RF Immunity key can be set to **LOW** to optimize sweep speed. Use this feature with caution, because the introduction of an interfering signal might be mistaken for a problem with the antenna or cable run. If Immunity is set to **LOW** during a normal Return Loss or VSWR measurement, then the instrument will be more susceptible to interfering signals. Interfering signals can make the measurement look better or worse than it really is.

1. Press the **Sweep (3)** menu key.
2. Toggle RF Immunity between High and Low.

RF Pwr In Hold

This setting determines if the RF output power at the RF Out/Reflect In port stays **On** or is turned **Off** when the instrument Run/Hold setting is toggled to **Hold**. When RF Pwr In Hold is set to **Off**, the power at the port is turned off when the instrument is placed in **Hold** mode and is not sweeping. Power at the port is resumed when the Run/Hold setting is toggled back to **Run**. This is useful when you may not want a signal radiating out of the port at all times.

Smoothing

This function sets the level of smoothing applied to a frequency domain measurement trace. A level of 0 % turns smoothing **OFF**. Levels 1 % through 20 % turn smoothing **ON** and set the smoothing percentage (the higher the level, the higher the percentage of smoothing applied to the trace). Smoothing is a trace averaging process that reduces or removes ripples from frequency swept data. This is especially useful when making 1-port cable loss measurements with a short at the other end of the cable. The ripple that is usually present in this kind of measurement can be removed with smoothing, thereby resulting in a more accurate average cable loss frequency response trace. Care should be taken when applying smoothing in order to not remove ripples that are inherent parts of the data (as opposed to measurement artifacts).

Sweep Averaging

This function sets the trace averaging process to use the measurement values of the same point in a set number of sweeps (refer to [“Data Points” on page 3-30](#)). For settings greater than 1, the Measurement Information displays the current sweep number (since entering the setting) followed by the setting value. For example, if you set the averaging value to 100, then you would see the first number counting from 1 up to 100 as the sweeps are completed. Thereafter, the values would be displayed continuously as 100/100.

A Sweep Averaging setting of 1 means that only one point is used in the averaging calculation, which means that no averaging is being done. The Averaging value that is displayed in the Measurement Information area (item 14 in [Figure 2-6 on page 2-14](#)) is “--” when Sweep Averaging is set to 1.

Source Power

The RF power radiated from Port 1 or Port 2 can be adjusted to be either High (nominally -3 dBm) or Low (nominally -20 dBm). The High power setting (default) is optimized in order to maximize the dynamic range of the measurement. The Low power setting must be used whenever the device under test cannot be operated with high power input signals, such as with high gain amplifiers. Care must be taken when making a transmission measurement on an amplifier in order to prevent damage or excessive distortion in the amplifier under test. Take extra caution to ensure that the output of the amplifier under test does not exceed the maximum rated input to the ports on the S820E analyzer.

IFBW

The Intermediate Frequency Bandwidth (IFBW) setting allows users to optimize instrument measurement speed versus dynamic range performance. Lower IFBW values provide higher dynamic range at the expense of measurement speed. Higher IFBW settings provide faster measurement speed at the expense of dynamic range. The default setting is 1 kHz, maximum is 100 kHz, and minimum is 10 Hz.

Limit Lines

Limit lines are used for visual reference or for pass/fail criteria using the limit alarm and pass/fail message setting. Pressing either the **Limit (6)** key or the **Limit** main menu key displays the Limit menu.

Overview of limit lines:

- Each measurement has a unique limit line.
- The color of the limit line changes to red when a measurement trace exceeds a limit.
- Select the **Limit** main menu key before trying to move a limit line using the touchscreen.
- Limits set beyond the current amplitude range are displayed at either the top or bottom of the graph.
- The last (most recent) limit line amplitude is stored when a limit line is turned off.
- Limit Preset turns off the limit line display, limit amplitude, limit alarm, and the Pass/Fail message.

Limit Line Functions

1. Press **Limit (6)**, then press the **Active Limit** key (if necessary) to choose Upper or Lower, then press the **Limit State** key to turn On a measurement-specific limit line.

The limit line can be set as a single or a segmented limit. A single limit line extends over the entire displayed range of the sweep, independent of the start/stop settings of the sweep. For a single limit line, the amplitude for the start and stop points is the same. A segmented limit line can be divided into connected or disconnected segments with different start/stop x and y values.

Note	Both the Upper and Lower limit lines for a trace must be of the same type: either both are Single, or both are Segmented.
-------------	---

2. Press **Move Active Limit** to set the limit line value by using the **Up/Down Arrow** keys, rotary knob, or number keypad.

Note	Limit lines cannot be moved by using the touchscreen.
-------------	---

Limit Line Segments

- For segmented limit lines, press **Edit Segments** to display the Segments menu. A table displays active limit lines and segments.
- Tap on a limit line segment and then choose to **Add**, **Edit**, or **Delete** the segment. For editing purposes, consider a single, full-span limit line as a single segment. Press the **Close** submenu key or the escape (**ESC**) key to close the Edit Segments menu and return to the Limit menu.

Upper limit lines and segments are labeled with a “U”, and Lower limit lines and segments are labeled with an “L”. Limit lines are displayed in green so long as the limits are not reached or exceeded. When a limit is exceeded (upper or lower), the limit line or segment turns red (Figure 3-17). Any portion of the measurement trace touching or exceeding a limit also turns red, while portions of the trace within limits remain in the default yellow color. When Segmented Limits are used, the trace color does not change when a limit is exceeded.

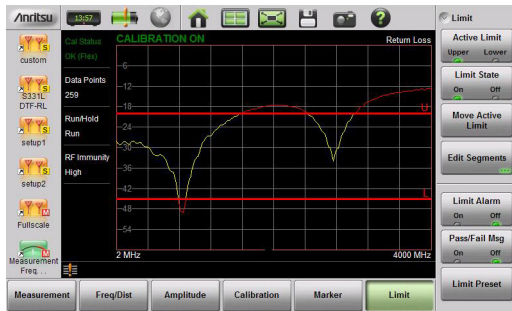

Figure 3-17. Limit Lines and Trace Showing Fail Colors

When editing a segmented limit line, a table is displayed with each segment in a separate row (Figure 3-18). The type is displayed as U or L. The Start and Stop settings are displayed as **Start(x1,y1)** and **Stop(x2,y2)**. In a Return Loss measurement, for example, the x-axis is in units of frequency, and the y-axis is in units of dB.

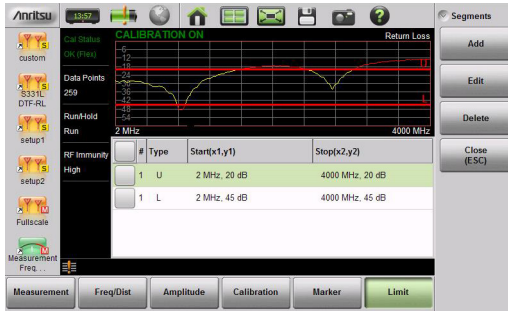

Figure 3-18. Table of Limit Lines (or Segments)

When adding or editing a segmented limit line, a dialog box (Figure 3-19) provides setting choices. You can choose Upper or Lower, then enter the x-axis and y-axis values for the segment Start and Stop. Differing y-axis values result in a sloping line segment.

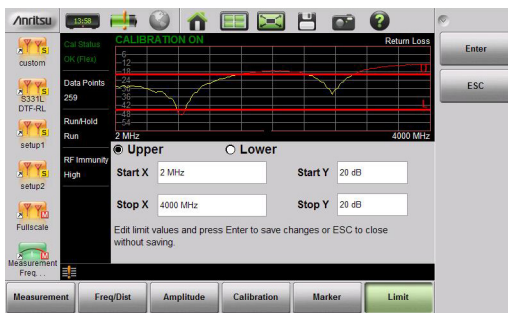

Figure 3-19. Segment Editing Dialog Box

Figure 3-20 shows a sequence of creating limit line segments for a filter measurement.



Figure 3-20. Creating Limit Line Segments

Figure 3-21 shows the result of moving limit line segments. Note that when moving upper or lower segments, all upper segments or all lower segments are moved by the same amplitude value, meaning that all upper or lower segments will move simultaneously. To change the value of a single segment, use the Edit Segments function.

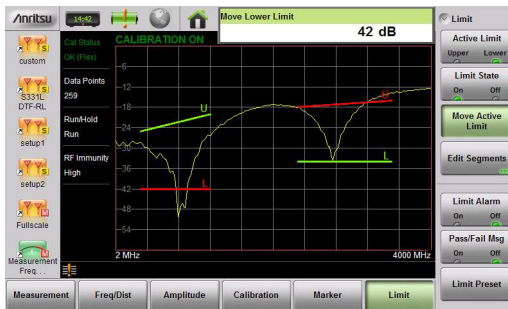
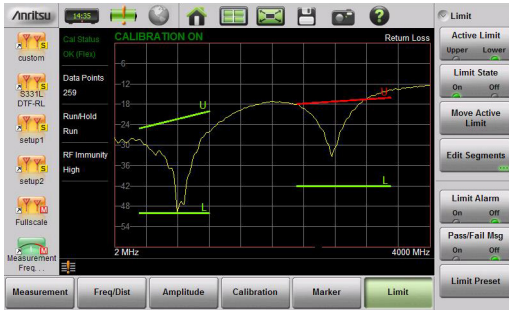

Figure 3-21. Moving Limit Line Segments

Limit Alarm

1. Press the Limit Alarm key to turn On or Off the audible Limit Alarm.
2. Adjust the volume of the limit alarm by pressing **System (8)**, then System Setups. Press the Display/Audio key and then Volume. Adjust the volume with the **Up/Down Arrow** keys, rotary knob, or the touchscreen. Press Enter to apply the new setting.

Pass/Fail Messages

Figure 3-22 shows the Pass/Fail message. Note that in the Fail message, Upper (U) or Lower (L) or both (U,L) are displayed. To change the size and location of the Pass/Fail message, (when the Limit menu is displayed) tap the small circled arrow in the lower-right corner of the large format message box. The circled arrow is in the upper-left corner when the message is in small format.

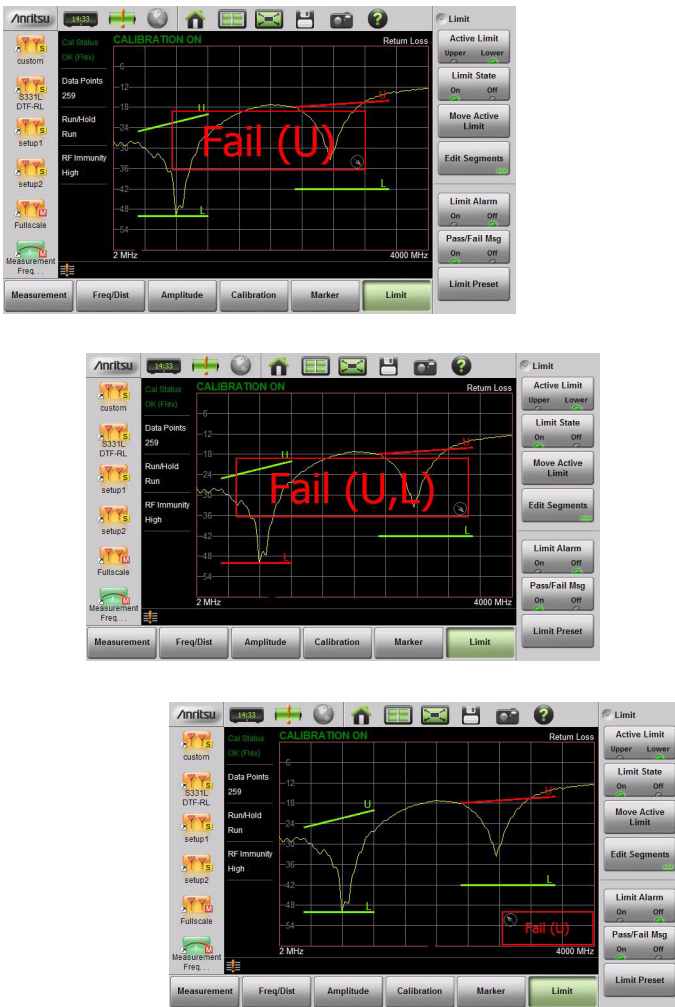

Figure 3-22. Pass/Fail Message Turned On

Markers

Markers can be applied to active or recalled measurements. The instrument supports eight markers. Marker information is stored in measurement files and setup files and is displayed when either file type is recalled. Pressing the **Marker** main menu key displays the marker menu.

Overview of Markers

- Frequency measurements (Return Loss, Cable Loss, and VSWR) have common markers. Distance measurements (DTF Return Loss and DTF VSWR) also have common markers.
- Press and hold on a marker to select and display the amplitude and frequency/distance information. Drag a marker to move it.
- The selected marker displays a vertical red line and has its value displayed in the highlighted row in the marker table. Select a marker to edit by using the touchscreen or the **Select (1-8)** marker button.
- Selected markers can be quickly dragged to a new location using the touchscreen or can be moved by double tapping on the display, by using the **Arrow** keys, or by using the rotary knob.
- Markers can be selected (and moved) outside of the **Marker** menu. Tap on a marker (thin green vertical line) to make it active and ready for moving.
- Markers set beyond the current frequency or distance range are displayed at either the left or right of the graph.
- If the frequency (F1 or F2) or distance (D1 and D2) parameters are moved inside a current marker location, then the out of range (---> or <----) indicator is displayed, and marker values in the Table are blanked (--). See [Figure 3-23](#) for an example of markers beyond the current span.
- Markers beyond the current span cannot be edited.
- Marker location and type are stored when the marker is turned off.
- **Marker Preset** restores the markers to their default state. All markers are turned off except for Marker 1 which is set to the middle of the sweep. Previous marker information is not saved.

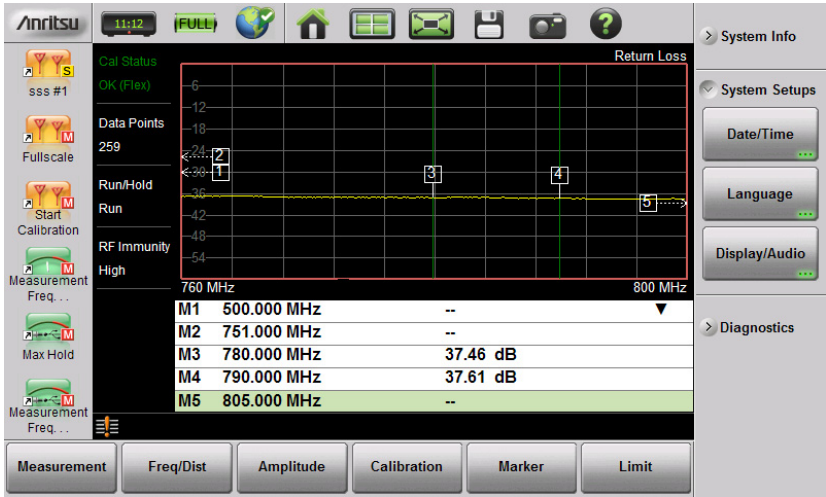

Figure 3-23. Markers 1, 2, and 5 are Out of Range

Select, Activate, and Place a Marker / Delta Marker

1. Press the **Marker** main menu key. One of the markers is automatically selected. Select a different marker with the **Select(1–8)** button or the touchscreen (refer to “[Overview of Markers](#)” on page 3-40). Press one of the Marker buttons to turn the marker on and to make the marker active. The active marker has a red vertical line.
2. Press the Edit submenu key, and use the **Up/Down Arrow** keys, the keypad, the rotary knob, or the touchscreen to move the marker.
3. Markers 2 through 8 can be set as deltas to a reference marker. Use the **Type** key to set the marker type as **Reference** or **Delta** marker. [Figure 3-24](#) on page 3-42 illustrates using a delta marker to estimate the passband of a filter.

Marker Table

The Marker Table is displayed below the sweep window. The table is automatically sized to display all markers that are turned on. The table displays marker frequency/distance, amplitude, and delta information for delta markers. To display the marker table:

Press the **Marker** main menu key then Display. Select Mkr + Table.

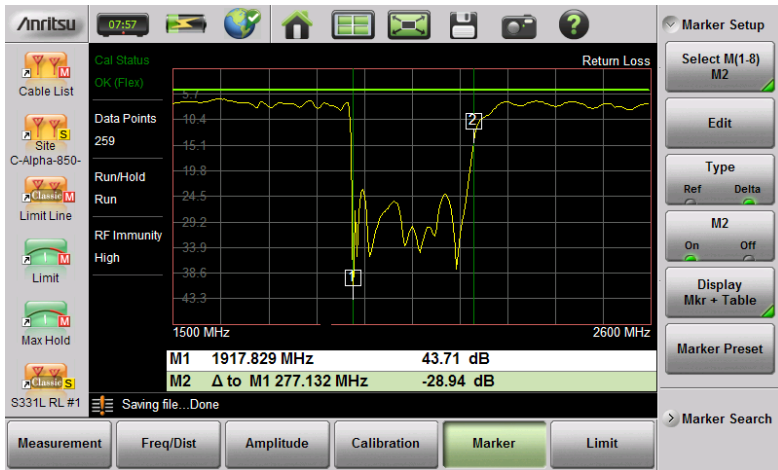

Figure 3-24. Delta Marker 2 and Marker Table

Marker Search

All of the cable and antenna measurements include markers that can automatically find trace peak and trace valley.

1. Press the **Marker** main menu key then Marker Setup. Select the marker to be used for peak or valley.
2. Press Marker Search.
3. Press Marker To Peak to set the marker to the peak of the measurement, or press Marker To Valley to set the marker to the valley of the measurement.

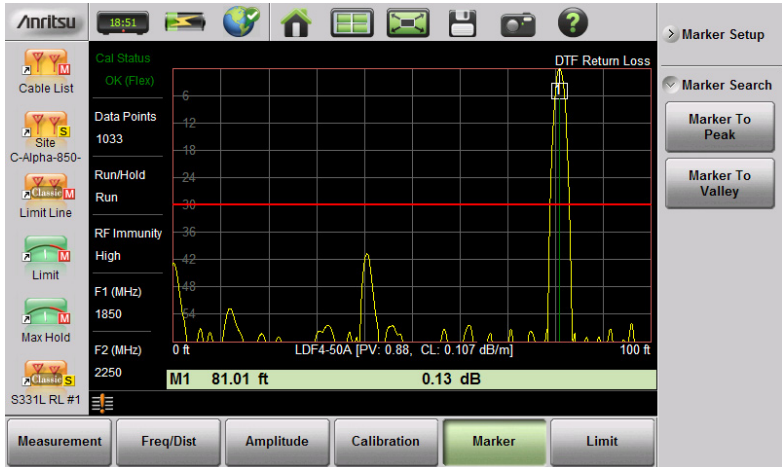

Figure 3-25. Marker Search, Marker 1 Set to Peak

Peak Between Markers

Another marker search option is to select the peak or valley between two Markers instead of the entire displayed frequency or distance span.

Markers 5 and 7 can be used to find the peak or valley between Marker 1 and Marker 2.

Markers 6 and 8 can be used to find the peak or valley between Marker 3 and Marker 4.

1. Press the **Marker** main menu key and set the locations for Marker 3 and Marker 4. Refer to [“Select, Activate, and Place a Marker / Delta Marker” on page 3-41](#) for details.
2. Select Marker 5.
3. Press Marker Search and select Peak between M1 & M2 or Valley Between M1 & M2. Marker 5 then moves to the peak or valley between M1 and M2.
4. In [Figure 3-26 on page 3-44](#), Marker 5 moved to the valley bounded by M1 and M2 instead of the lowest point (48 dB) to the left of Marker 1. The valley search would also work if M1 and M2 were set and then turned off.

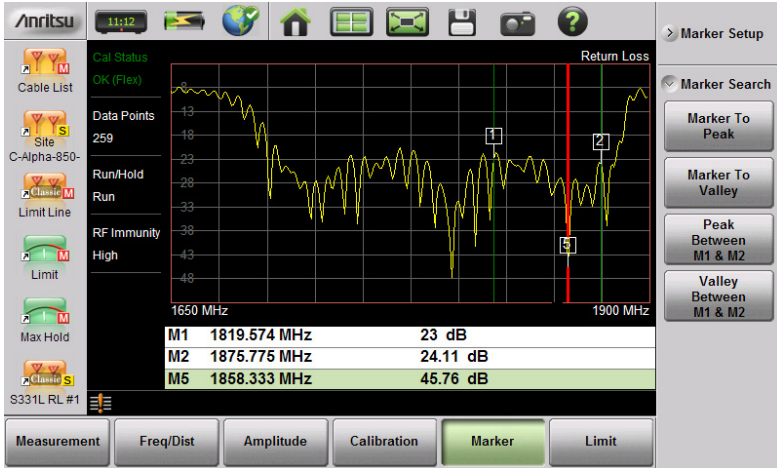

Figure 3-26. Bounded Marker Search

Note

Searching for peaks or valleys turns on any required markers and places them in the default locations.

Tracking Markers

A tracking marker is set to a peak or to a valley. As the peak (or valley) varies in the measurement trace, the tracking marker stays at the peak (or valley).

Any marker can be set for tracking from the Marker Search menu. When set to Tracking, the marker number is displayed inside a triangle rather than a rectangle. For a Tracking marker set for Marker To Peak, the apex of the triangle points upward. For a Tracking marker set for Marker To Valley, the apex of the triangle points downward.

The markers that can be set for Peak Between can also be Tracking markers that are bounded by M1 and M2 or by M3 and M4.

Tracking markers can be especially helpful for specific measurements, such as tuning and testing filters or antennas.

In Figure 3-27, Marker M1 is set for Tracking a Valley. The three images show how the marker remains at the valley as the measurement trace changes.



Figure 3-27. Tracking Marker Set to Valley

In [Figure 3-28](#), Marker M5 is set for Tracking a Valley between markers M1 and M2. Marker M6 is Tracking a Valley between markers M3 and M4. The table of markers (below the sweep window in [Figure 3-28](#)) shows only 4 markers, but the table can be expanded or reduced by tapping on the table.

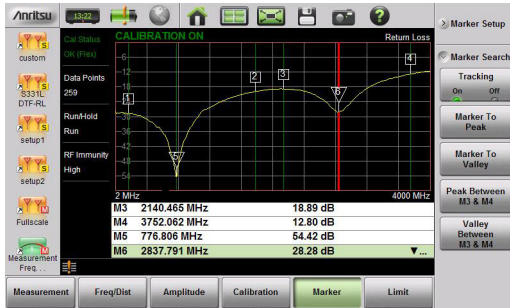

Figure 3-28. Tracking A Valley Between Markers

3-8 Trace

The Site Master S820E allows you to concurrently view the live trace plus a second trace that is stored in trace memory. You can compare the two traces visually or by using trace math functions. Pressing the **Trace (5)** main menu key brings up the trace functions.

Overview of Traces

- Recalled measurements (.dat files) from internal memory or a USB stick are automatically copied to trace memory and are then available to be displayed. To display the recalled measurement trace along with the live measurement, select Trace & Memory from the Trace Display menu.

Note Recalled measurements may change the current instrument settings.

- Copy Trace to Memory** replaces whatever is in memory with the live (yellow) trace. The memory trace (purple) is displayed behind the live (yellow) trace.
- The default view is live **Trace Only**. View options (Trace Display) also include viewing only the trace in memory or both traces.
- View only trace memory to have marker values apply to the purple trace.

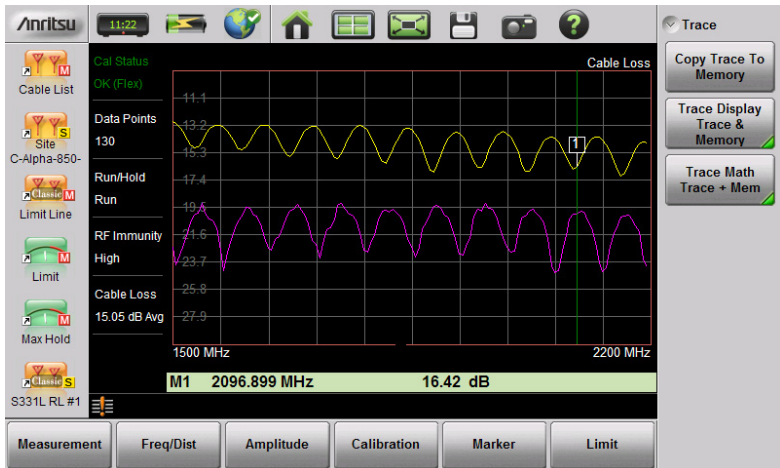

Figure 3-29. Displaying a Live Trace and a Static Trace from Trace Memory

From the **Trace** menu you can Copy Trace to Display Memory. The copied trace can be displayed on the Site Master and used for trace math. Trace Display allows viewing of two traces at the same time to compare the trace stored in memory to the live trace. Trace Math operations include Trace - Memory, Trace + Memory and $(Trc + Memory) / 2$. Saved traces can also be recalled and compared with the live trace.

Trace Overlay

The examples below illustrate how the trace overlay feature can be used to compare the return loss measurements between two cables.

1. Connect the first cable and setup the measurement. Refer to [“Measurement Setup” on page 3-29](#) for additional information.
1. Press **Trace (5)** and then Copy Trace To Memory.
2. Remove the first cable and connect the second cable.
3. Press Trace Display and select Trace & Memory. The purple trace from trace memory is displayed along with the live (yellow) trace.

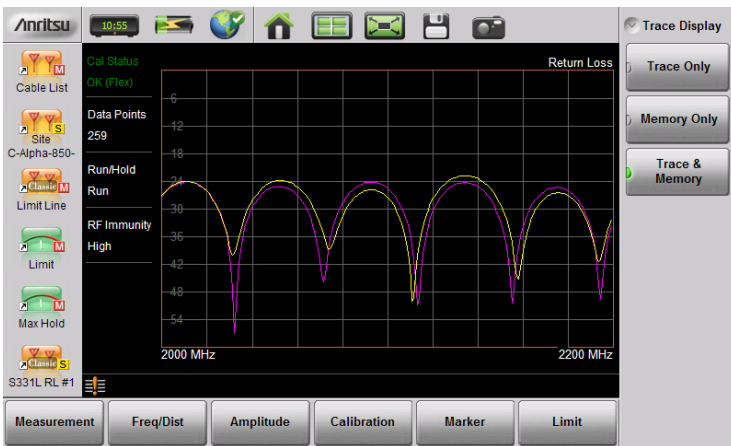

Figure 3-30. Trace Overlay of Two Cables

Note

The trace from memory can be displayed only if the measurement settings (except for Amplitude) have not changed since the trace was copied to memory.

If one of the traces is cut off, then pressing **Amplitude** > Fullscale adjusts the reference level to display both traces.

Trace Math Example

The example below illustrates how the trace math features can be used to compare the measurement of two cables.

1. Complete the steps described in [“Trace Overlay” on page 3-48](#).
2. Press Trace Math and select Trace – Mem, Trace + Mem, or (Trc + Mem) / 2 ([Figure 3-31 on page 3-50](#)).

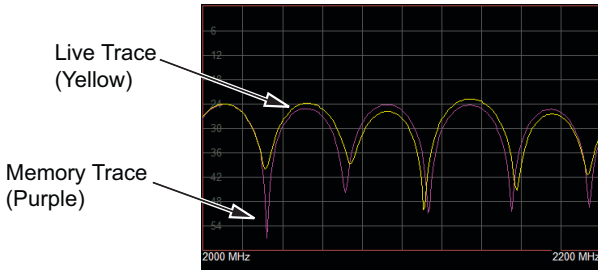

Example A. Sample Traces

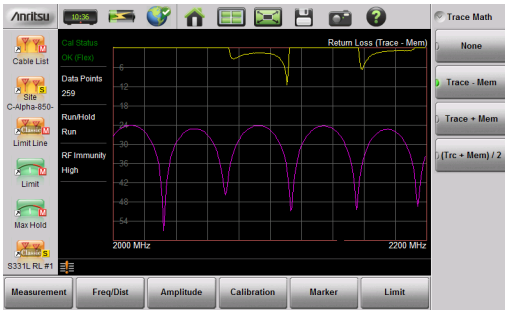

Example B. Trace - Memory

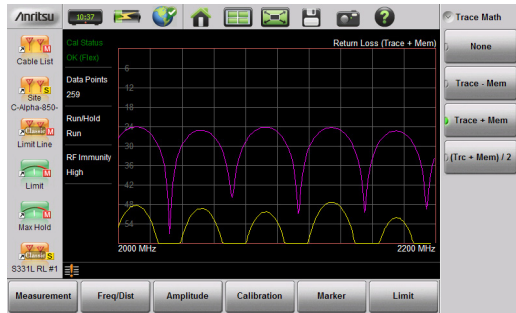

Example C. Trace + Memory

Figure 3-31. Trace Memory Used to Compare Return Loss of 2 Cables

<p>Notes</p>	<p>The trace math functions often seem backwards to new users. The points to remember with Trace - Memory, Trace + Memory, and (Trc + Mem) / 2 are:</p> <ul style="list-style-type: none"> • The numbers on the y-axis are negative. • The purple trace is added to or subtracted from the live trace. The sum or difference of the live trace and memory trace is displayed in yellow.
---------------------	---

Table 3-1. Trace Math Details (Example from [Figure 3-31](#)) (1 of 2)

Example	Example Description
A. Sample Traces	Shows the live yellow trace and purple memory trace.
B. Trace - Memory	<p>In the Trace – Memory graph, the yellow trace is the result of subtracting the purple memory trace from the active trace.</p> <p>(The active trace is displayed in Example B, Trace – Memory as the yellow trace, and appears different because trace math is applied to it.)</p> <p>Note that the yellow Trace – Memory is at 0 or above (and off the graph) whenever the yellow trace (as shown in Example A) is above (has a greater value than) the purple trace.</p> <p>The two down sloping bumps in Example B are when the purple trace (in Example A) moves above the yellow trace. In Trace – Memory, this results in a negative value being displayed.</p>
C. Trace + Memory	<p>In the Trace + Memory graph, the yellow trace is the result of adding the purple trace to the active trace. (The active trace is displayed in Example C, Trace + Memory as the yellow trace, and appears different because trace math is applied to it.)</p> <p>Note that the yellow Trace + Memory is below 60 (and off the graph) whenever adding the yellow trace value to the purple trace value is greater than 60 (refer to Example A).</p>

Table 3-1. Trace Math Details (Example from [Figure 3-31](#)) (2 of 2)

Example	Example Description
(Trace + Memory) / 2 <i>(not shown)</i>	<p>In the (Trace + Memory) / 2 graph, the yellow trace is the result of adding the purple trace to the active trace and then dividing the result by 2.</p> <p>This math function is most useful when measuring one-port Cable Loss (using the Cable Loss measurement).</p> <ol style="list-style-type: none"> 1. Connect a Short to the end of the cable and store the trace into memory. 2. Next, connect an Open to the end of the cable and apply (Trc + Mem) / 2 math function. <p>Because the ripple generated by the Short and Open are 180° out of phase, the effect of this math function will be to cancel out the ripple, resulting in a more accurate cable loss measurement.</p>

Refer to [“Trace Menu” on page 3-69](#) for additional information.

3-9 Cable and Antenna Analyzer Menus

Figure 3-32 and Figure 3-33 show maps of the menus. Menu maps typically display all possible submenu keys, although some keys may be displayed on the instrument only under special circumstances (refer to menu descriptions on the following pages).

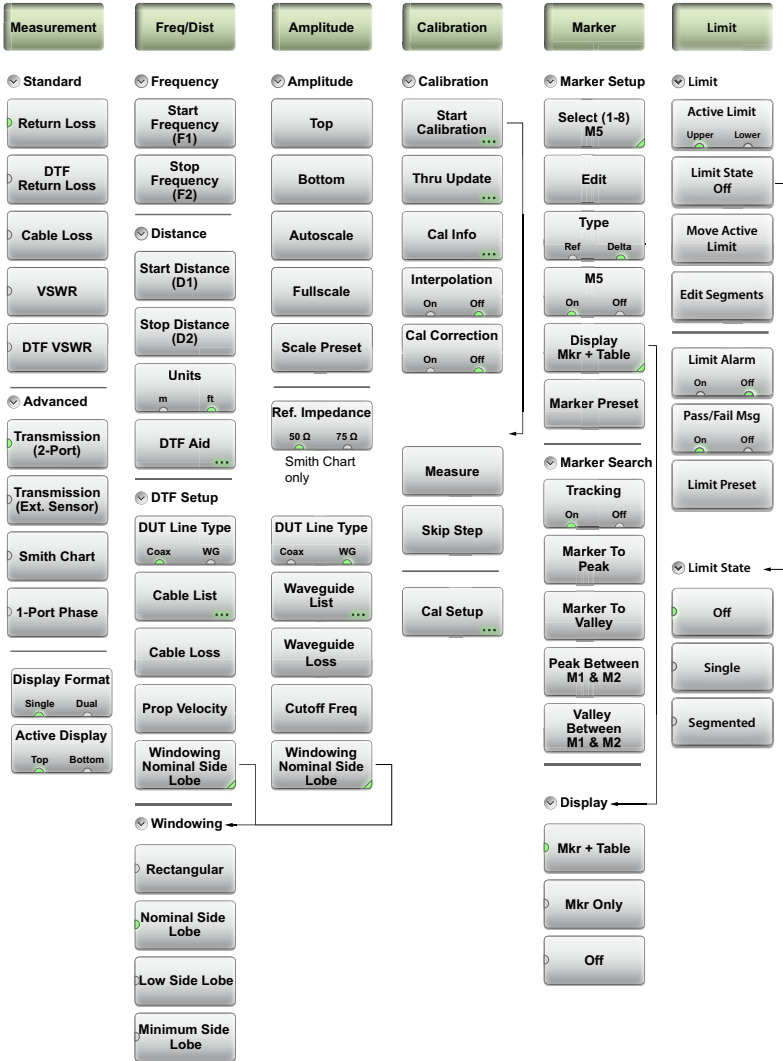

Figure 3-32. Menu Keys (1 of 2)

3-9 Cable and Antenna Analyzer Menus Cable and Antenna Measurements

Touchscreen

0

Refer to Chapter 8

Preset

1

Refer to Chapter 8

Calibrate

2

Refer to Chapter 5

Sweep

3

☑ Sweep Setup

Data Points
259

Run/Hold
Run Hold

Sweep Type
Cont. Single

RF Immunity
High Low

RF Pwr In Hold
On Off

Source Power
High Low

IFBW ...

Smoothing

☑ Data Points

130

259

517

1033

2065

Measure

4

See Measurement Menu

Trace

5

☑ Trace

Copy Trace To Memory

Trace Display
Trace Only

Trace Math
None

☑ Trace Math

None

Trace - Mem

Trace + Mem

(Trc + Mem) / 2

☑ Trace Display

Trace Only

Memory Only

Trace & Memory

Limit

6

See Limit Menu

File

7

Refer to Chapter 7

System

8

Refer to Chapter 8

Mode

9

Refer to Chapter 2

Figure 3-33. Main Menu Keys (2 of 2)

3-10 Measurement Menu

Key Sequence: **Measurement**











	<p><i>Standard</i></p>
<p>Standard</p>	<p>NOTE: All Standard measurements listed below apply only to devices under test that are connected to Port 1 of the Site Master.</p>
	<p>Return Loss: Return Loss is used to characterize RF components and systems. The Return Loss indicates how well the system is matched by taking the ratio of the reflected signal to the incident signal, and measuring the reflected power in dB.</p>
	<p>DTF Return Loss: The DTF measurement displays return loss values versus distance. If the frequency measurements fail or indicate a problem in the system, then the DTF measurement can be used to identify and pinpoint the exact location of the problem. The DTF measurement shows the return loss value of all the individual components including connector pairs and cable components.</p>
	<p>Cable Loss: The cable loss test verifies the signal attenuation level of the cable.</p>
	<p>VSWR: Press the VSWR submenu key to view the impedance match in VSWR. VSWR is a ratio of voltage peaks to voltage valleys.</p>
	<p>DTF VSWR: Press this submenu key to display VSWR values versus distance. If the frequency measurements fail or indicate a problem in the system, then the DTF measurement can be used to identify and pinpoint the exact location of the problem. The DTF measurement shows the VSWR value of all the individual components including connector pairs and cable components.</p>
<p>Advanced</p>	<p>Advanced and Common: Shown on next page.</p>
	
	
	
	
 <p>Single Dual</p>	
 <p>Top Bottom</p>	

Figure 3-34. Measurement Menu

Measurement Menu (continued)

Measurement

Standard

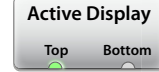
Return Loss

DTF
Return Loss

Cable Loss

VSWR

DTF VSWR

Advanced

Transmission
(2-Port)

Transmission
(Ext. Sensor)

Smith Chart

1-Port Phase

Display Format

Single Dual

Active Display

Top Bottom

Standard (Shown on previous page.)

Advanced

Transmission (2-Port): Press this submenu key to measure through the DUT. The Transmission measurement between Port 1 and Port 2 is used to measure the loss (or gain) in dB of a device. This measurement requires that the device be connected directly (or through a test port cable) to both ports of the instrument.

Transmission (Ext. Sensor): Press this submenu key to measure through the DUT. The Transmission measurement between Port 1 and an External USB Sensor is used to measure the loss (or gain) in dB of a device. This measurement requires that one port of the device be connected directly (or through a test port cable) to Port 1 of the Site Master. The second port of the device connects to the External USB Sensor. This measurement is useful when both ends of the device under test (DUT) are far away from each other and cannot both be connected to the Site Master at the same time.

Smith Chart: Press this submenu key to view the measurement results in a Smith Chart. The Smith Chart is a graphical tool that is used to plot the impedance of the device connected to Port 1 of the Site Master. It converts the measured reflection coefficient data into impedance data and displays it in a manner that makes the Smith Chart a useful tool for determining and tuning input match. This complex impedance plot reveals which matching elements are necessary to match a device under test to the reference impedance (which can be set in the Amplitude menu to either 50 Ω or 75 Ω).

Figure 3-35. Measurement Menu

Measurement Menu (continued)

<p>Measurement</p>	<p><i>Advanced (continued)</i></p>
<p>Standard</p>	
<p>Return Loss</p>	
<p>DTF Return Loss</p>	
<p>Cable Loss</p>	
<p>VSWR</p>	
<p>DTF VSWR</p>	
<p>Advanced</p>	
<p>Transmission (2-Port)</p>	<p>1-Port Phase: Press this submenu key to set the phase of a reflection measurement. 1-Port phase displays the phase of the reflection measurement of the device that is connected to Port 1. The data are displayed from -180° to $+180^\circ$ because the measurement cannot tell the difference between one cycle and the next. This display method removes the discontinuity from the important 0 degrees area that is used as the phase reference.</p>
<p>Transmission (Ext. Sensor)</p>	<p>The 1-port phase measurement is most useful when making relative measurements (comparing the phase of one device to the phase of another) by utilizing the Trace Math function (Trace – Memory).</p>
<p>Smith Chart</p>	<p><i>Common</i></p>
<p>1-Port Phase</p>	<p>Display Format</p>
<p>Display Format Single Dual</p>	<p>Single Dual: Press this submenu key to toggle the sweep window to show one trace (Single) or two traces (Dual).</p>
<p>Active Display Top Bottom</p>	<p>Active Display</p>
	<p>Top Bottom: Press this submenu key to toggle the setting of the active trace. You can also touch either trace to make it the active trace.</p>

Figure 3-36. Measurement Menu

3-11 Freq/Dist Menu

Key Sequence: **Freq/Dist**



Frequency



Distance



Frequency

Start Frequency (F1): Press the Start Frequency (F1) submenu key and enter the desired frequency using the **Up/Down Arrow** keys, the rotary knob, or the keypad. Press **Enter** to complete the entry or, if entering a frequency using the keypad, press the appropriate units key.

Stop Frequency (F2): Press the Stop Frequency (F2) submenu key and enter the desired frequency using the **Up/Down Arrow** keys, the rotary knob, or the keypad. Press **Enter** to complete the entry or, if entering a frequency using the keypad, press the appropriate units key.

Distance

Start Distance (D1): Press the Start Distance submenu key and enter the desired distance using the **Up/Down Arrow** keys, the rotary knob, or the keypad. Press **Enter** to complete the entry or, if entering a distance using the keypad, press the appropriate units key.

Stop Distance (D2): Press the Stop Distance submenu key and enter the desired distance using the **Up/Down Arrow** keys, the rotary knob, or the keypad. Press **Enter** to complete the entry or, if entering a distance using the keypad, press the appropriate units key.

Units: Press the Units key to toggle distance units between meters and feet.

DTF Aid: Opens the DTF Aid dialog box ([Figure 3-5](#)). This interactive parameter box allows setting multiple parameters and displays maximum testing distance and resolution.

Figure 3-37. Frequency/Distance Menu (1 of 2)

Freq/Dist Menu (Continued)Key Sequence: **Freq/Dist**

<p>▼ DTF Setup</p> <p>Cable List ...</p> <p>Cable Loss</p> <p>Prop Velocity</p> <p>Windowing Nominal Side Lobe</p>	<p><i>DTF Setup</i></p> <p>Cable List: The Cable List submenu key opens a list of available cable specifications (Figure 3-6). Using Up/Down Arrow keys, the rotary knob, or the touchscreen, select the desired cable and press Enter.</p> <p>Note: When a cable is selected from this list, propagation velocity and cable loss are automatically set by the instrument. If the preselected values for propagation velocity or cable loss are changed, then the analyzer will use “NONE” as the cable type.</p> <p>Cable Loss: Press the Cable Loss submenu key and enter the loss in dB/ft or dB/m for the selected cable using the keypad, Up/Down Arrow keys, or the rotary knob and press Enter.</p> <p>Prop Velocity: Press the Prop Velocity submenu key and enter the applicable propagation velocity for the selected cable using the keypad, Up/Down Arrow keys, or the rotary knob and press Enter.</p> <p>Windowing: Opens the “Windowing Menu” on page 3-60.</p>
--	---

Figure 3-38. Frequency/Distance Menu (2 of 2)

Windowing Menu

Key Sequence: **Freq/Dist > DTF Setup > Windowing**

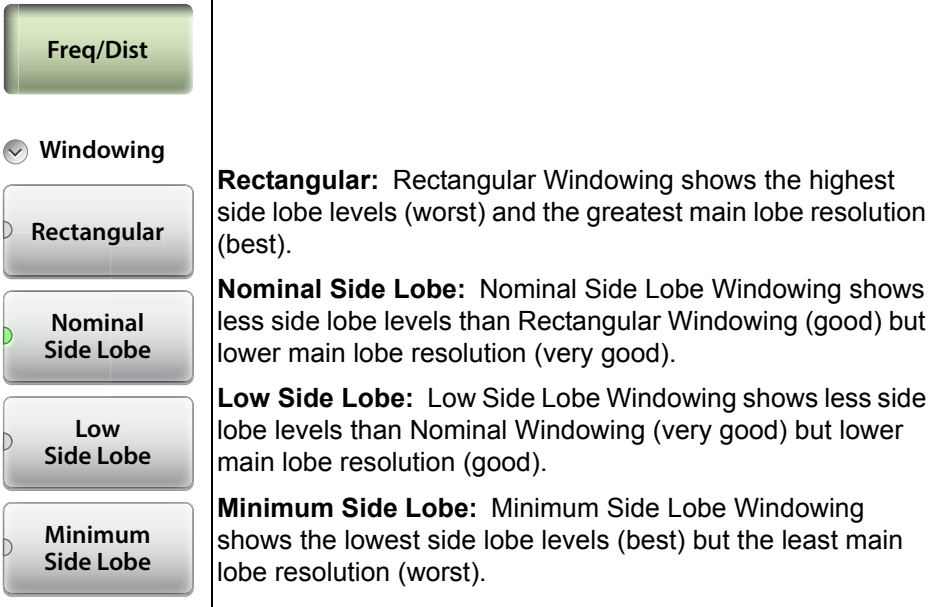

Figure 3-39. Windowing Menu

3-12 Amplitude Menu

Key Sequence: **Amplitude**







	<p><i>Amplitude</i></p> <p>Top: Sets the top amplitude value using the keypad, the Arrow keys, or the rotary knob. Press Enter to complete the entry.</p>
	<p>Bottom: Sets the bottom amplitude value using the keypad, the Arrow keys, or the rotary knob. Press Enter to complete the entry.</p>
	<p>Autoscale: Automatically sets the top and bottom scales to the minimum and maximum values of the measurement with some margin on the y-axis of the display.</p>
	<p>Fullscale: Fullscale automatically sets the scale to the maximum allowable setting for each measurement.</p>
	<p>Scale Preset: Scale Preset automatically sets the scale to the default setting: 0 dB to 60 dB for Return Loss measurements, 0 dB to 30 dB for Cable Loss, 1 to 3 for VSWR measurements, and +10 dB to -90 dB for Transmission measurements.</p>
	<p>The following submenu key appears only for Smith Chart measurements, and is then the only submenu key in the Amplitude Menu:</p>
	<p>Ref. Impedance 50 Ω 75 Ω: Sets the reference impedance that is used for Smith Chart calculations to either 50 Ω or 75 Ω. The reference impedance determines the value of impedance at the center of the Smith Chart.</p>
	

Figure 3-40. Amplitude Menu

3-13 Calibration Menu

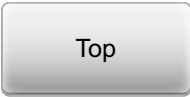
Key Sequence: **Calibration**

	<p><i>Calibration</i></p>
<p>☑ Calibration</p>	<p>Start Calibration: Opens the Calibration dialog box. Refer to Chapter 4, “Calibration, CAA” for detailed information.</p>
	<p>Thru Update: Opens the Calibration dialog box to allow calibrating the Thru component without repeating the entire calibration sequence. This key is displayed only after a calibration with a Thru component.</p>
	<p>Cal Info: Displays the Calibration Information table showing the current and active calibration settings. See Figure 4-3 on page 4-3.</p>
	<p>Interpolation</p>
	<p>On Off: Press this submenu key to toggle Interpolation On or Off. After performing a calibration, you can turn Interpolation On and then change the frequency range (smaller) or change the number of data points (to be higher than 1033).</p>
	<p>Cal Correction</p>
	<p>On Off: Turn Cal Correction On to apply the correction factor to the current measurement.</p>
	<p>Measure: Starts the calibrations process. Follow the on screen instructions.</p>
	<p>Skip Step</p>
	<p>Previous Step: Press this submenu key to skip the current calibration step. In the dialog box for the next step, the button label becomes Previous Step, which returns to the dialog box of the step just skipped.</p>
	<p>Cal Setup: Press this submenu key to choose a calibration type.</p>

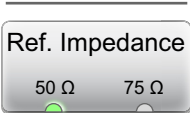
Figure 3-41. Calibration Menu

3-14 Marker Menu

Key Sequence: **Marker**







	<p><i>Marker Setup</i></p>
<p>✓ Marker Setup</p>	<p>Select (1–8) M#: Press to turn on a marker (1 to 8) and selects which marker is active (green half circle). Current active marker is displayed on the button (M1).</p>
	<p>Edit: Press to change the position of the active marker using the Up/Down Arrow keys, rotary knob or the keypad.</p>
	<p>Type: Sets the current active marker as a reference (standard) marker or a delta marker to Marker 1. Marker 1 is always a reference marker.</p>
	<p>M# (On Off): Toggles the display of the active marker on or off. When off the location of the marker is stored.</p>
	<p>Display (Mkr + Table, Mkr Only, Off): Press to open display options.</p>
	<p>Mkr+Table: Displays both the markers that are on and marker table.</p>
	<p>Mkr Only: Displays markers that are on, hides the marker table.</p>
	<p>Off: Hides all markers and the marker table.</p>
	<p>Marker Preset: Turns off all markers except for Marker 1. Sets Marker 1 location to the middle of the sweep.</p>

Figure 3-42. Marker Menu (1 of 2)

Marker Menu (Continued)Key Sequence: **Marker**

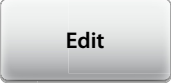
 <p>Tracking</p> <p>On Off</p>	<p><i>Marker Search</i></p> <p>Tracking (On Off): When turned On, the active marker becomes a tracking marker and defaults to tracking the peak. To track Valleys, press the Marker to Valley button after turning on Tracking. The Search settings can all be applied to a Marker with Tracking either On or Off.</p>
<p>Marker to Peak</p>	<p>Marker to Peak: Places the currently active marker on the highest signal amplitude currently displayed on screen.</p>
<p>Marker to Valley</p>	<p>Marker to Valley: Places the currently active marker on the lowest signal amplitude currently displayed on screen.</p>
<p>Peak between M1 & M2</p>	<p>Markers 5, 6, 7, and 8 can perform a special Marker search to find the Peak or Valley between two other markers.</p>
<p>Valley between M1 & M2</p>	<p><i>When Marker 5 or Marker 7 is Active:</i></p> <p>Peak Between M1 & M2: Places Marker 5 or 7 on the highest signal amplitude between Marker 1 and Marker 2.</p> <p>Valley Between M1 & M2: Places Marker 5 or 7 on the lowest signal amplitude between Marker 1 and Marker 2.</p>
	<p><i>When Marker 6 or Marker 8 is Active:</i></p> <p>Peak Between M3 & M4: Places Marker 6 or 8 on the highest signal amplitude between Marker 3 and Marker 4.</p> <p>Valley Between M3 & M4: Places Marker 6 or 8 on the lowest signal amplitude between Marker 3 and Marker 4.</p>

Figure 3-43. Marker Menu (2 of 2)

3-15 Limit Menu

Limit lines can be used for visual reference only, or for pass/fail criteria using the limit alarm and Pass/Fail Message keys. Limit alarm failures are reported whenever a signal crosses the limit line.

Key Sequence: **Limit (6)** or **Limit**







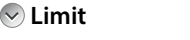

Limit	<i>Limit</i>
	
	<p>Active Limit (Upper Lower): This key toggles the active limit line settings to the Upper or Lower limit.</p>
	<p>Limit State: Press this key to display the Limit State menu and select one of three limit states: Off, Single, or Segmented. The current limit state is displayed on the key.</p>
	<p>Move Active Limit: Press this key to change the amplitude of the limit line with the Up/Down Arrow keys, rotary knob, or the number keypad. If the limit line is divided into segments, then all segments move by the same amount.</p>
	<p>Edit Segments: Press this key to display the Segments menu and a table of limit line segments. Tap a segment (Upper or Lower), and then choose a function from Figure 3-46, "Limit Line Segments Menu" on page 3-66.</p>
	<p>Limit Alarm (On Off): When turned On, the Limit Alarm sounds a repeating beep when the trace touches the limit line.</p>
	<p>Pass/Fail Msg (On Off): When turned On, a Pass or Fail message is displayed to indicate whether the trace touches or exceeds the limit line (Fail).</p>
	<p>Limit Preset: Turns the limit line off and clears amplitude information. The next time that a limit line is turned on, it will be displayed at the default location (center of the display).</p>

Figure 3-44. Limit Menu

3-16 Limit State Menu

Key Sequence: **Limit (6)** or **Limit > Limit State**

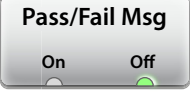
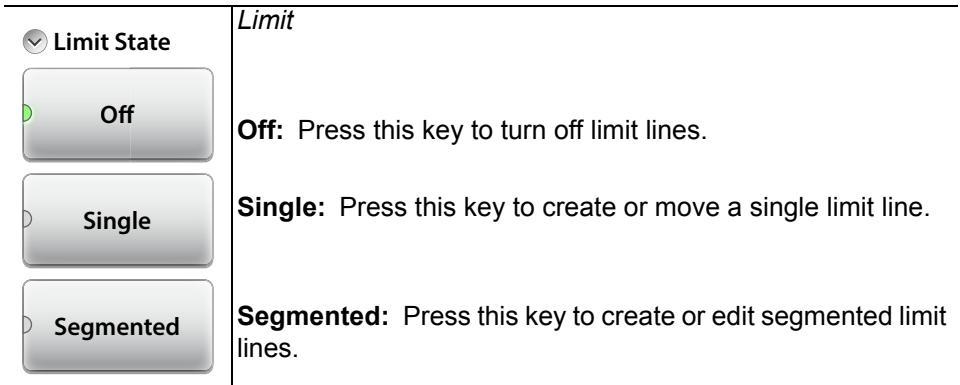

Figure 3-45. Limit State Menu

Limit Menu (Continued)

Key Sequence: **Limit > Edit Segments**

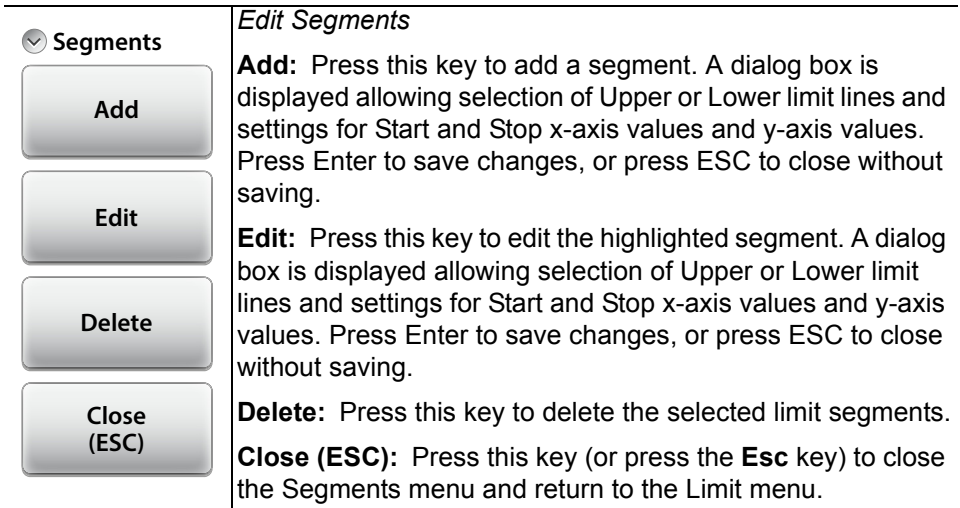

Figure 3-46. Limit Line Segments Menu

3-17 Sweep Menu

Key Sequence: **Sweep (3)**









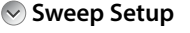

	<p><i>Sweep Setup</i></p>
	<p>Data Points: Sets the number of data points: 130, 259, 517, 1033, or 2065.</p>
	<p>Run/Hold Run Hold: Toggles between Run and Hold. When in Hold mode, pressing this key starts the sweeping and provides a trigger. When in the Run mode, pressing this key pauses the sweep.</p>
	<p>Sweep Trigger: This displays the “Sweep Trigger Menu” on page 3-68. The mode is displayed on the submenu key. Continuous is the default.</p>
	<p>RF Immunity High Low: The instrument defaults to RF Immunity Low. Refer to “RF Immunity” on page 3-32 for details.</p>
	<p>RF Pwr In Hold On Off: Sets the RF Output power to be left On or turned Off when Run/Hold is toggled to Hold. Refer to “RF Pwr In Hold” on page 3-32 for details.</p>
	<p>Source Power High Low: This toggles the source power between High and Low.</p>
	<p>IFBW: Press this submenu key to display the IFBW selection box. Highlight one of the 4 choices: 100 kHz, the maximum sweep speed 1 kHz, default 100 Hz 10 Hz, the maximum dynamic range</p>
	<p>Smoothing: Press this submenu key to set the smoothing in percent (0 % to 20 %). Use the number keypad, the Up/Down Arrow keys, or the rotary knob.</p>
	<p>Sweep Averaging: Press this submenu key to set the number of sweeps to average at each sweep point (1 to 1000). Use the number keypad, the Up/Down Arrow keys, or the rotary knob, then press Enter.</p>

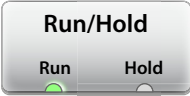
Figure 3-47. Sweep Menu

3-18 Sweep Trigger Menu

Key Sequence: **Sweep (3)** > Sweep Trigger





 Sweep Trigger	<i>Sweep Trigger</i>
 Continuous	<p>Continuous: Sets the sweep trigger to internal and continuous, and sets the Run/Hold setting to Run. A new sweep is triggered automatically at the end of each sweep. This is the default sweep trigger setting.</p>
 Single	<p>Single: Sets the sweep trigger to internal and single, and sets the Run/Hold setting to Hold. Each sweep is activated by the Run/Hold submenu key.</p>
 Ext. Trigger	<p>Ext. Trigger: Sets the sweep trigger to an external source. Each sweep is activated by a TTL signal at the External Trigger In connector. Refer to “Test Panel Connector Overview” on page 2-3.</p>

Figure 3-48. Sweep Trigger Menu

3-19 Trace Menu

Key Sequence: **Trace** (5)

<p>▼ Trace</p> <p>Copy Trace To Memory</p> <p>Trace Display Trace Only</p> <p>Trace Math None</p> <hr/> <p>▼ Trace Math</p> <p>None</p> <p>Trace - Mem</p> <p>Trace + Mem</p> <p>(Trc + Mem) / 2</p> <hr/> <p>▼ Trace Display</p> <p>Trace Only</p> <p>Memory Only</p> <p>Trace & Memory</p>	<p><i>Trace</i></p> <p>Copy Trace to Display Memory: Copies the current trace display to memory for use in Trace Math and Trace Display options.</p> <p>Trace Display: Press to change the display options.</p> <p>Trace Only: The active trace is shown (yellow).</p> <p>Memory Only: The trace stored in memory is displayed in purple.</p> <p>Trace & Memory: Displays both the stored trace (purple) if a trace is stored in memory and the current active trace (yellow).</p> <p>Trace Math: Press to change the trace math options.</p> <p>None: The active trace is shown as is, with no math functions.</p> <p>Trace – Mem: Displays the difference between the active trace and the trace in memory.</p> <p>Trace + Mem: Displays the results of logarithmic adding of the active trace and the trace in memory.</p> <p>(Trc + Mem) / 2: Displays the results of the average of the active trace and trace in memory.</p>
--	--

Figure 3-49. Trace Menu

3-20 Other Menu Keys

Refer to [Table 2-1, “Site Master Keypad Functions”](#) on page 2-9.

Chapter 4 — Calibration, CAA

4-1 Introduction

This chapter provides details and procedures for calibrating the Cable-Antenna Analyzer modes of the Site Master S820E.

The Site Master is a high precision instrument. When making 1-port or 2-port measurements, the instrument must be calibrated in order to remove residual errors due to measurement setup conditions. Anritsu recommends performing the calibration under the same conditions as the measurement: temperature, frequency, number of points, source power, and IFBW. The calibration must be conducted using the appropriate standards at the open end of any test port cables and adapters that are connected to Port 1 or Port 2 of the instrument. This ensures that the match, phase length, and loss of these cables and adapters are all accounted for. For optimal performance, high quality phase-stable cables and precision adapters must be used.

[Figure 4-1 on page 4-2](#) and [Figure 4-2 on page 4-2](#) compare a Return Loss measurement before and after the instrument is calibrated.

Note	For accurate results, the instrument must be calibrated before making any measurements.
-------------	---

Chapter Overview

This chapter contains the following sections:

- [Section 4-2 “Calibration Setup” on page 4-3](#)
- [Section 4-3 “Calibration Procedures” on page 4-14](#)
- [Section 4-4 “Calibrate Menu” on page 4-18](#)

Note	Screen images in this User Guide are illustrations of typical instrument features. Some images may include instruments other than the Site Master S820E. Traces and other display features may differ from the screen displays of your instrument.
-------------	--

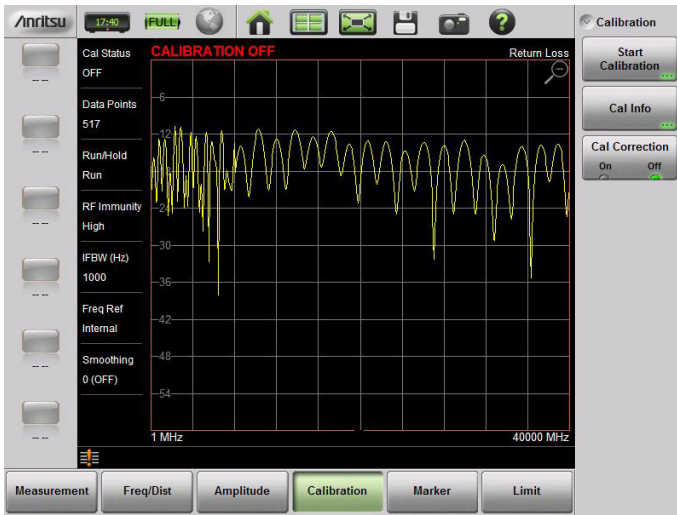

Figure 4-1. Return Loss Measurement before Calibration

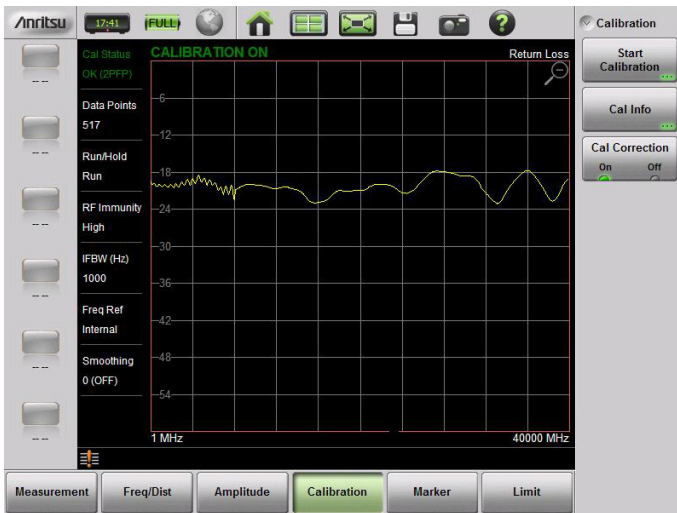

Figure 4-2. Return Loss Measurement after Calibration

4-2 Calibration Setup

In order to perform a proper calibration, several parameters must be set before the calibration procedure is started. These parameters are: Cal Type, Cal Line, Port DUT, and Port Cal Kit.

To view a summary of these settings, begin from the Calibration main menu and press **Cal Info**. A summary of the Active Cal Settings and the Current Settings of the instrument are displayed (see [Figure 4-3](#)). Press **Esc** to close the Cal Info window.



The screenshot shows a dialog box titled "Calibration Information [Cal Status: OK]". It contains a table with three columns: "Type", "Current Settings", and "Active Cal Settings". The table lists various calibration parameters and their values for both the current and active states. At the bottom of the dialog, there is a message: "Press ESC to close this dialog."

Type	Current Settings	Active Cal Settings
Date/Time	27 Sep 2013 / 17:48:09	25 Sep 2013 / 15:48:38
Internal Temp	44 °C / 111 °F	34 °C / 93 °F
Valid Cal Window	--	14 to 54 °C / 57 to 129 °F
Cal Type	1-Path 2-Port - Fwd Path	1-Path 2-Port - Fwd Path
Cal Line Type	Coax	Coax
Cal Kit Port 1	TOSLKF50A-40	TOSLKF50A-40
# of Points	130	1033
Start Frequency	1 MHz	1 MHz
Stop Frequency	40000 MHz	40000 MHz
Source Power	High	High
IFBW	100 kHz	1 kHz

Figure 4-3. Cal Info Window

The Cal Info window displays all of the key setup parameters for the calibration. The current settings are shown on the left, and the settings of the instrument at the time of the last calibration are shown on the right.

Cal Type

Various calibration types are available for the Site Master S820E. The calibration type must be chosen based on the measurement that is required.

Figure 4-4 shows the dialog box with the Cal Type selection table.

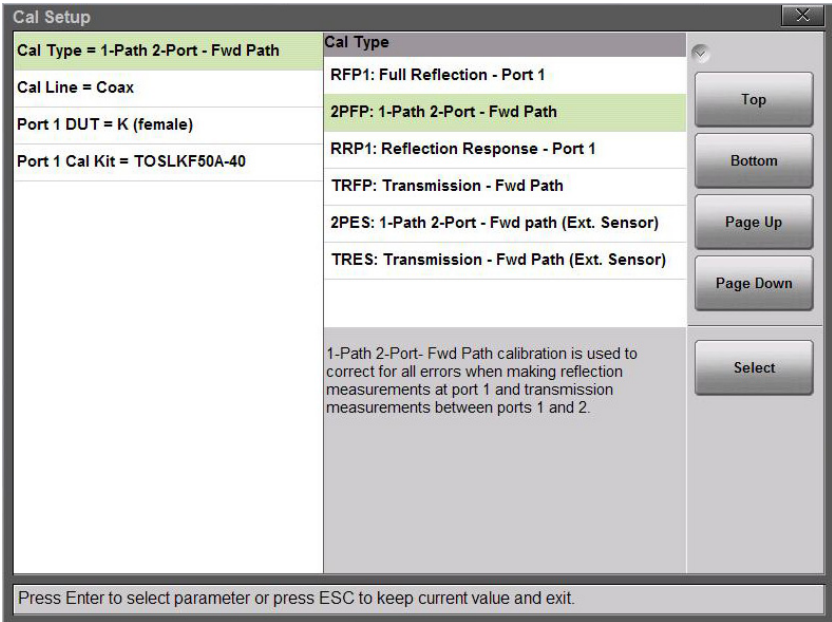

Figure 4-4. Cal Setup Window Showing Cal Type Selection Table

Table 4-1 lists in more detail what types of measurement errors each of these calibration types corrects.

Table 4-1. Measurement Errors Corrected by Calibration (1 of 2)

Calibration Type	Measurement Errors Corrected
RFP1: Full Reflection – Port 1	<p>Full Reflection – Port 1 calibration is used to correct for all errors when making reflection measurements at port 1 (for example, Return Loss, VSWR, Cable Loss, or DTF).</p> <p>This cal type requires three connections to Port 1: Open, Short, Load</p>
2PFP: 1-Path 2-Port – Fwd Path	<p>1-Path 2-Port – Fwd Path calibration is used to correct for all errors when making reflection measurements at port 1 and transmission measurements between ports 1 and 2.</p> <p>This cal type requires four connections to Port 1: Open, Short, Load, Thru (between Port 1 and 2). The Isolation step, using a load connection on each port, is optional. If used, it will improve the dynamic range performance of the Thru measurement.</p>
RRP1: Reflection Response – Port 1	<p>Reflection Response – Port 1 calibration is a quick method used to correct for some errors when making reflection measurements at port 1.</p> <p>This cal type requires one connection to Port 1: Open or Short. The load connection is optional, but if used, will improve the effectiveness of this calibration.</p>

Table 4-1. Measurement Errors Corrected by Calibration (2 of 2)

Calibration Type	Measurement Errors Corrected
TRFP: Transmission – Fwd Path	<p>Transmission Response – Fwd Path calibration is a quick method used to correct for some errors when making transmission measurements between ports 1 and 2.</p> <p>This cal type requires one connection: a Thru connection between Port 1 and Port 2.</p>
2PES: 1-Path 2-Port – Fwd path (Ext. Sensor)	<p>1-Path 2-Port – Fwd Path (Ext. Sensor) calibration is used to correct for errors when making reflection measurements at port 1 and transmission measurements between port 1 and an external USB sensor.</p> <p>This cal type requires four connections to Port 1: Open, Short, Load, Thru (between Port 1 and the external USB sensor).</p>
TRES: Transmission – Fwd Path (Ext. Sensor)	<p>Transmission Response – Fwd Path (Ext. Sensor) calibration is used to correct for errors when making transmission measurements between port 1 and an external USB sensor.</p> <p>This cal type requires one connection: a Thru connection between Port 1 and the external USB sensor.</p>

Cal Line

The Site Master S820E supports measurements and calibrations for both coaxial and waveguide media. In the Cal Setup window, set the Cal Line to either Coax or Waveguide before starting the calibration.

Figure 4-5 shows the selection window for the Cal Line, within the Cal Setup dialog box. For coaxial line types, the calibration method that is used is the Open, Short, Load method, or OSL. For waveguide line types, the calibration method that is used is the Offset Short 1 ($1/8^{\text{th}}$ wavelength), Offset Short 2 ($3/8^{\text{th}}$ wavelength), Load method, or SSL.

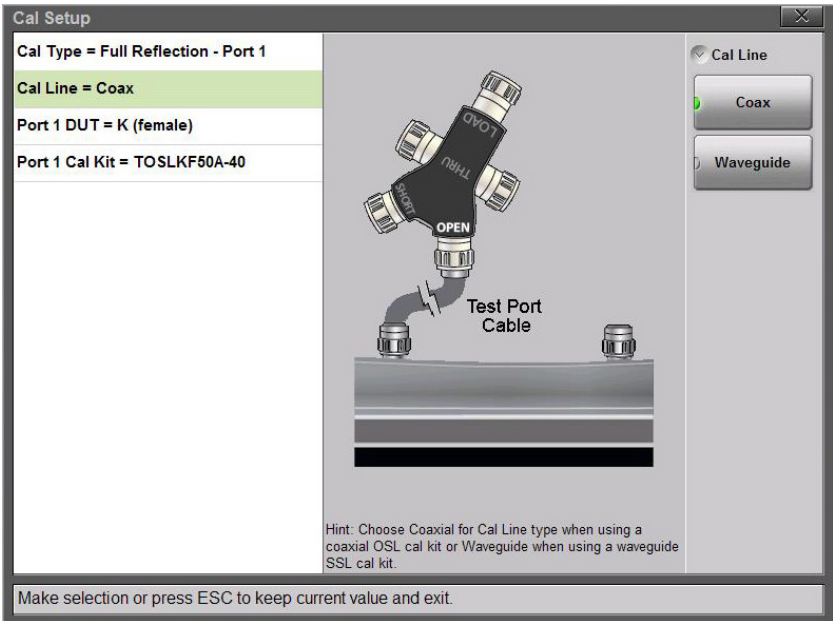

Figure 4-5. Cal Line Selection

Port 1 DUT and Cal Kit

For the most accurate calibrations, you must select the connector of the DUT that will be attached to Port 1 of the instrument. After you select the DUT connector, you must then select the desired calibration kit that will be used for the Port 1 correction. If you do not select a desired calibration kit, then the analyzer defaults to one of the built-in kits.

Figure 4-6 shows the selection window for the Port 1 DUT connector. For easier identification of the DUT connector, a representative picture is shown for each selection. After a connector is chosen, the Port 1 Cal Kit selection is updated in order to list only the available calibration kits that are associated with the selected DUT connector. Figure 4-7 on page 4-9 shows an example of the selection of calibration kits that are available for the K (female) coaxial DUT connector.

For each coaxial kit in the list, the values of the Offset Lengths for the Open, Short, and Thru (if applicable) are listed. The Capacitance and Inductance values for the Open and Short are also listed, as shown in Figure 4-7. For waveguide calibration kits, the Cutoff Frequency and the Offset Short 1 and Short 2 lengths are listed.

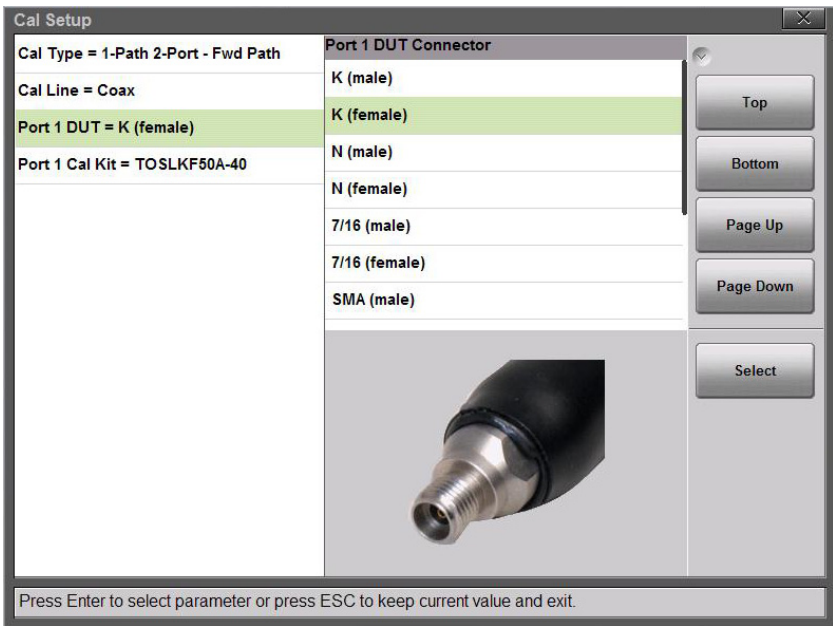

Figure 4-6. Selection Window for Port 1 DUT Connector

Figure 4-7 shows the Selection window for the Port 1 Cal Kit with its list of available calibration kits and the corresponding parameters for each kit.

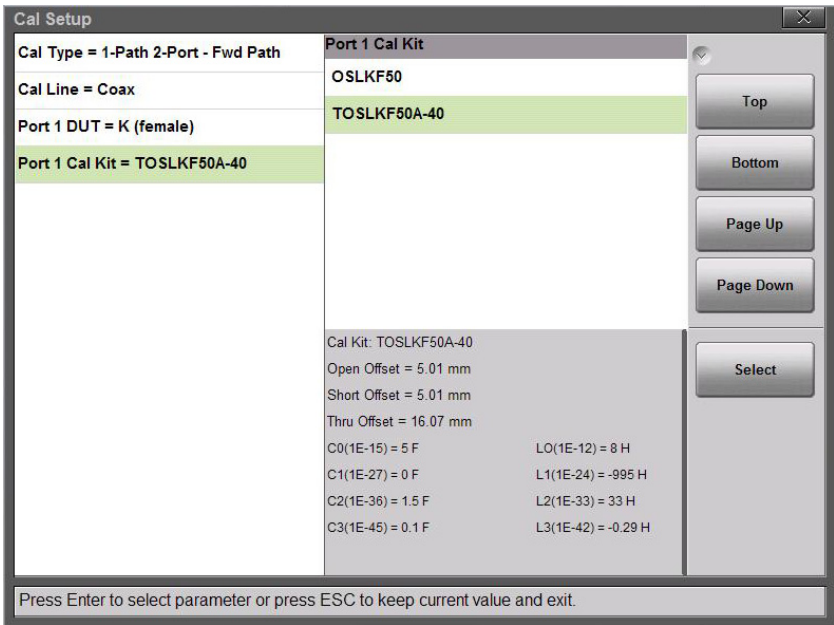

Figure 4-7. Selection Window for Port 1 Cal Kit

The selection list for DUT connectors includes all of the common connectors that you may encounter. [Table 4-2, “Coax DUT Connectors and Cal Kits” on page 4-10](#) and [Table 4-3, “Waveguide DUT Connectors” on page 4-11](#) provide complete lists of Coax and Waveguide connectors and corresponding calibration kits that are selectable through the Cal Setup dialog box.

Table 4-2. Coax Dnt Connectors and Cal Kits

Coaxial Connector Name	Available Cal Kits
N-Type (male)	OSLN50, OSLN50-1, OSLN50A-8, OSLN50A-18, TOSLN50A-8, TOSLN50A-18
N-Type (female)	OSLNF50, OSLNF50-1, OSLNF50A-8, OSLNF50A-18, TOSLNF50A-8, TOSLNF50A-18
K (male)	OSLK50, TOSLK50A-20, TOSLK50A-40
K (female)	OSLKF50, TOSLKF50A-20, TOSLKF50A-40
7/16 (male)	2000-1618-R, 2000-767
7/16 (female)	2000-1619-R, 2000-768
SMA (male)	3650 (male components of kit)
SMA (female)	3650 (female components of kit)
TNC (male)	1091-53, Open
TNC (male)	1091-54, Short
TNC (male)	1015-55, Termination
TNC (female)	1091-55, Open
TNC (female)	1091-56, Short
TNC (female)	1015-54, Termination
User 1: Coax	User 1 (Coax)
User 2: Coax	User 2 (Coax)
User 3: Coax	User 3 (Coax)
User 4: Coax	User 4 (Coax)
User 5: Coax	User 5 (Coax)
User 6: Coax	User 6 (Coax)
User 7: Coax	User 7 (Coax)
User 8: Coax	User 8 (Coax)
User 9: Coax	User 9 (Coax)
User 10: Coax	User 10 (Coax)

Table 4-3. Waveguide DUT Connectors

Waveguide Connector Name
WG11A/R40 (3.30 to 4.90 GHz)
WG12/WR187/R48 (3.95 to 5.85 GHz)
WG13 (4.90 to 7.00 GHz)
WG14/WR137/R70 (5.85 to 8.20 GHz)
WG15/WR112/R84 (7.05 to 10.0 GHz)
WG16/WR90/R100 (8.20 to 12.4 GHz)
WG17/R120 (10.0 to 15.0 GHz)
WG18/WR62/R140 (12.4 to 18.0 GHz)
WG20/WR42/R220 (18.0 to 26.5 GHz)
WG22/WR28/R320 (26.5 to 40.0 GHz)
User 1: WG
User 2: WG
User 3: WG
User 4: WG
User 5: WG
User 6: WG
User 7: WG
User 8: WG
User 9: WG
User 10: WG

If you are using custom connectors that are not already listed, then the Site Master S820E allows you to create up to ten User DUT connectors and corresponding User Cal Kits. Choose one of the User connectors from the Port 1 DUT Connector list, as shown in [Figure 4-8 on page 4-12](#). You can edit the name of the DUT connector, as indicated on the Site Master screen.

For each User DUT connector, a corresponding User Cal Kit is selected, as shown in [Figure 4-9 on page 4-13](#). The coefficients for the calibration kit can be edited, as indicated on the Site Master screen. Customizing the connectors and calibration kit coefficients allows you to have the most flexibility in using any calibration kit that may be required for your measurements.

The user-entered coefficients are retained in the instrument's non-volatile memory and will persist even after the Site Master is powered down or after a Factory Reset. Recalling a setup file will not overwrite the user coefficients.

Caution To ensure utmost measurement accuracy and consistency, please use the Anritsu calibration kits that are listed in the Calibration menu. These can be found in the accessories section of the S820E data sheet. Other Calibration kits that are not listed in the Calibration menu may be used provided you enter the correct required calibration coefficient information under one of the available custom User settings.

Figure 4-8 illustrates the Selection window for the Port 1 DUT connectors, showing the list of custom User connectors available to the user. The name of the connectors can be edited as indicated on the screen.

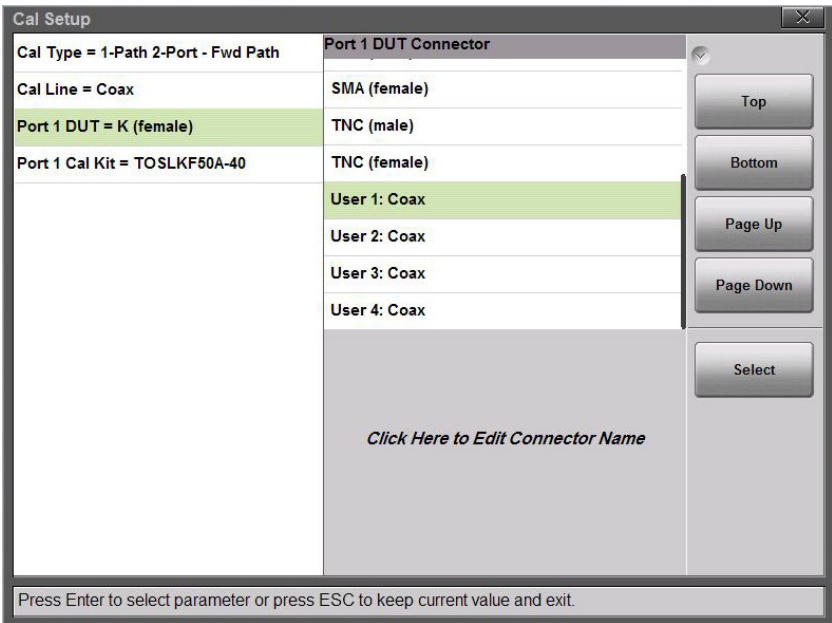

Figure 4-8. Cal Setup, Port 1 DUT Connectors

Figure 4-9 shows the selection window for the custom User cal kits corresponding to the User 6 DUT coaxial connector. The corresponding cal kit parameters are shown and can be edited as indicated on the screen.

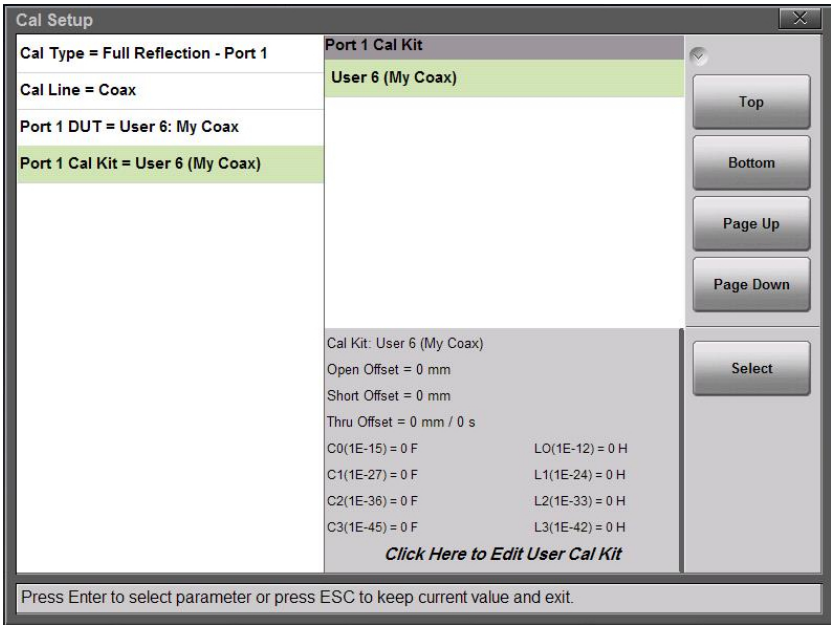

Figure 4-9. Cal Setup, Port 1 DUT Coax Connector

4-3 Calibration Procedures

In Cable and Antenna Analyzer Mode, calibration is required when the “Cal Status Off” or “Cal Status --” message is displayed, or when the test port cable or adapters have been changed. The following sections describe how to perform calibrations.

<p>Note If a Test Port Extension Cable is to be used (this is recommended), then it must be connected to the Site Master before calibration.</p>

Calibration Procedure

1. Press the **Freq/Dist** main menu key and enter the appropriate frequency range.
2. Press the **Calibration** main menu key, then press **Start Calibration**.
3. Press **Cal Setup** to make changes to the setup as needed (refer to [Section 4-2 “Calibration Setup” on page 4-3](#)).
4. Press **Measure** and follow the on screen instructions (see [Figure 4-10 on page 4-15](#)).
5. Verify that the calibration has been completed by confirming that the Cal Status message is now displaying “Cal Status OK (xxxx)”, where “xxxx” indicates the Cal Type. The calibration correction factor will now be applied to the measurements.
6. The calibration factors can be turned Off with the **Cal Correction** button. The calibration coefficients are saved and can be reapplied by setting **Cal Correction** back to On.

Thru Update

When measuring the transmission (or insertion loss) response of a DUT, the calibration requires a Thru measurement to be performed. This requires at least one external cable to be introduced into the calibration. The additional cable component is the most susceptible to changes from environmental conditions, such as temperature changes and mechanical flexing. The Thru Update button (see [Figure 4-11 on page 4-18](#)) allows you to quickly eliminate the effects of temperature changes or of changes caused by mechanical flexing of the cable without having to repeat the entire calibration process. The Thru update is particularly useful when viewing DUT transmission responses with small scale resolution (0.5 dB/division or less).

[Figure 4-10](#) shows the Calibration dialog box showing calibration setup and calibration steps. On-screen instructions are given for each step.

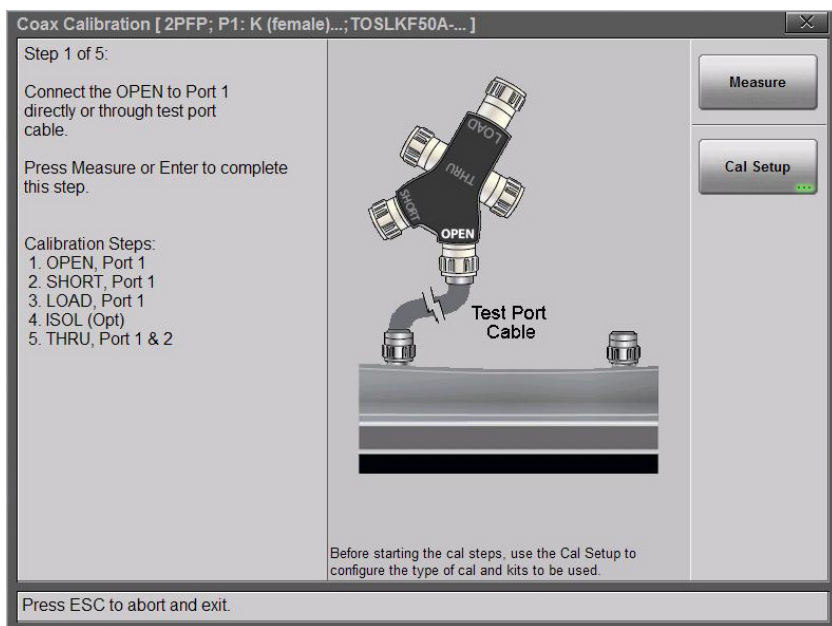

Figure 4-10. Calibration Dialog Box for Coax

Temperature Window

For accurate results, the instrument must be calibrated at the ambient temperature after allowing for warm-up time (approximately 10 minutes) and before making any measurements. The S820E must be re-calibrated whenever the internal instrument temperature exceeds the calibration temperature window (± 10 °C) or when the test port extension cables or adapters are removed or replaced. The instrument must also be re-calibrated every time the frequency range changes.

To ensure that you consistently obtain accurate measurements, the Site Master continuously monitors its internal temperature and compares that to the actual calibration temperature that was recorded when the last calibration was performed. If these 2 values differ by ± 10 degrees or more, then the Site Master displays **CALIBRATION OFF (±°C)**, indicating that the current temperature has exceeded the calibration temperature window. Anritsu recommends that you perform a new calibration after this occurs in order to continue making accurate measurements. Alternatively, if the instrument temperature comes back into the valid calibration temperature window, then you may reactivate the existing calibration by turning it back on in the Calibration Menu.

If you turn off the correction by using the Cal Correction button, then the Site Master displays **CALIBRATION OFF**. In this case, you can re-enable the calibration by simply setting the Cal Correction back to On (as long as the valid calibration temperature window has not been exceeded).

Save and Recall Calibration Coefficients

Calibration information is included when a setup (.stp) file is saved (even if the Cal Correction is Off). The calibration information is recalled with a setup file and can be applied if the current internal instrument temperature is within the saved calibration window.

Calibration information is not included when a measurement (.dat) file is saved.

Interpolation

If Interpolation is set to Off and the current Cal Correction is On and valid, you cannot modify the frequency range or the source power level, or increase the number of points above 1033 points (assuming the calibration was performed with 1033 points or less). Any of these changes will require the active calibration to be turned Off and a new calibration to be performed. You can, however, adjust the number of points from 130 to 1033 without forcing the calibration to become invalid. To use 2065 points, the number of points must be set to 2065 before the calibration is started.

If your current Cal Correction is On and you turn Interpolation On, you can then change the frequency range (smaller and anywhere within the calibrated range) or modify the number of points to be higher than 1033 without invalidating the calibration. In that case, the calibration coefficients are regenerated (interpolated) to match the new settings. You cannot increase the frequency range, however, beyond the range that was used during calibration.

For example, you could perform a calibration from 1 MHz to 20 GHz using 2065 points. With Interpolation On, you could then make a measurement by zooming in on a desired frequency range, 410 MHz to 435 MHz, for example. The trace in your measurement would use the full 2065 points within this much narrower frequency range.

4-4 Calibrate Menu

Key Sequence: **Calibration**





	<p><i>Calibration</i></p>
<p>Calibration</p>	<p>Start Calibration: Press this submenu key and follow the instructions on screen.</p>
	<p>Measure: Press this submenu key to start the calibration process.</p>
	<p>Cal Setup: Press this submenu key to open the Setup window to allow adjustments to the Cal Type, Cal Line, Port DUT, and Port Cal Kit. Refer to Figure 4-4 on page 4-4.</p>
	<p>Thru Update: Opens the Calibration dialog box to allow calibrating the Thru component without repeating the entire calibration sequence. This key is displayed only after a calibration with a Thru component.</p>
	<p>Cal Info ... Press this submenu key to display information about the current settings and active cal settings. Refer to Figure 4-3 on page 4-3.</p>
	<p>Interpolation On Off: Press this submenu key to toggle Interpolation On or Off. After performing a calibration, you can turn Interpolation On and then change the frequency range (smaller) or change the number of data points (to be higher than 1033).</p>
	<p>Cal Correction On Off: Pressing this submenu key determines whether the active cal is applied to the current measurement.</p>

Figure 4-11. Calibrate Menu

Chapter 5 — Classic Mode Operation

5-1 Introduction

The Site Master S820E provides a “Classic” Cable and Antenna Analyzer measurement mode which emulates the user interface from the Anritsu Site Master ‘D’ series of instruments. This emulation is intended to help users of the S820E follow existing carrier Method of Procedure (MOP) documents that specify an earlier Site Master model.

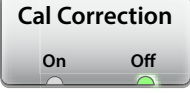
To provide quick and easy familiarity with the Site Master user interface, many of the advanced features such as Dual Screen display, Smith Chart, Phase, and multi-segmented limits, are purposely removed while in Classic Mode. Please switch to Advanced Mode to access these useful features when desired.

Refer to [Figure 5-1 on page 5-2](#) for a comparison of Site Master S820E “Classic” vs. “Advanced” Cable & Antenna modes.

Note

Use the **Menu** key and confirm that the instrument is in “Classic” Cable-Antenna Analyzer mode before continuing.

Classic Mode is always displayed above the measurement type when the instrument is in “Classic” mode.

Refer to [Chapter 3, “Cable and Antenna Measurements”](#) for a complete overview of the instrument GUI. This chapter summarizes the differences between “Classic” mode and the “Advanced” S820E Cable and Antenna mode.

Note

Screen images in this User Guide are illustrations of typical instrument features. Some images may include instruments other than the Site Master S820E. Traces and other display features may differ from the screen displays of your instrument.

5-2 Classic Mode and Advanced Mode

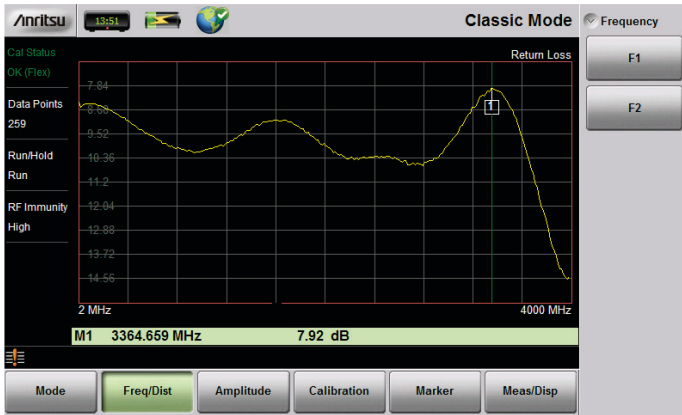

“Classic” Mode (Chapter 4)

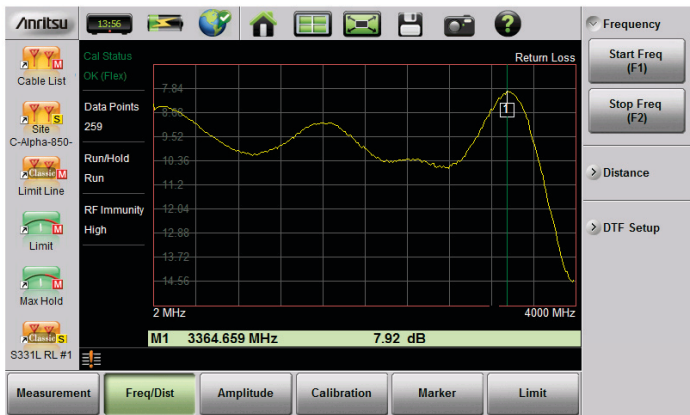

“Advanced” Mode (Chapter 3)

Figure 5-1. Comparison of “Classic” Mode vs. “Advanced” Mode

Figure 5-2 on page 5-4 and Figure 5-3 on page 5-5 show an overview of the Classic Cable and Antenna Analyzer menus and keys. Descriptions of the main menus and associated submenus are provided in Chapter 3.

Table 5-1. Menu Differences Between *Classic* Mode and *Advanced* Mode

Classic Mode	Advanced Cable and Antenna Mode
Meas Mode Menu	“Measurement Menu” on page 3-55
Freq – SWR	“VSWR” on page 3-55
Freq – Return Loss	“Return Loss” on page 3-55
Freq – Cable Loss (one port)	“Cable Loss” on page 3-55
Freq – Cable Loss (two port, ext. sensor)	“Transmission (2-Port)” on page 3-56 “Transmission (Ext. Sensor)” on page 3-56
DTF – SWR	“DTF VSWR” on page 3-55
DTF – Return Loss	“DTF Return Loss” on page 3-55
—	“Smith Chart” on page 3-56
—	“1-Port Phase” on page 3-57
Freq/Dist Menu	“Freq/Dist Menu” on page 3-58
F1	“Start Frequency (F1)” on page 3-58
F2	“Stop Frequency (F2)” on page 3-58
D1	“Start Distance (D1)” on page 3-58
D2	“Stop Distance (D2)” on page 3-58
More	“DTF Setup” on page 3-59
Marker Menu	Refer to Figure 5-2 on page 5-4 for “Classic” mode marker menu structure. Refer to “Marker Menu” on page 5-6 for menu descriptions.
Meas/Disp Menu	Refer to “Sweep Menu” on page 3-67 and “Trace Menu” on page 3-69

Note

Also refer to [Chapter 3](#) for descriptions of other menus not specifically mentioned in [Table 5-1](#).

In Advanced Mode, two additional submenu keys are available to control the measurement display. In the [“Measurement Menu” on page 3-55](#), the Display Format key toggles Single and Dual trace displays (refer to [“Dual Display Format” on page 2-25](#)). The Active Display key toggles the Top or Bottom trace to be active.

5-3 Menu Map – Classic Mode

Menu maps typically display all possible submenu keys, although some keys may be displayed on the instrument only under special circumstances (refer to menu descriptions on the following pages).

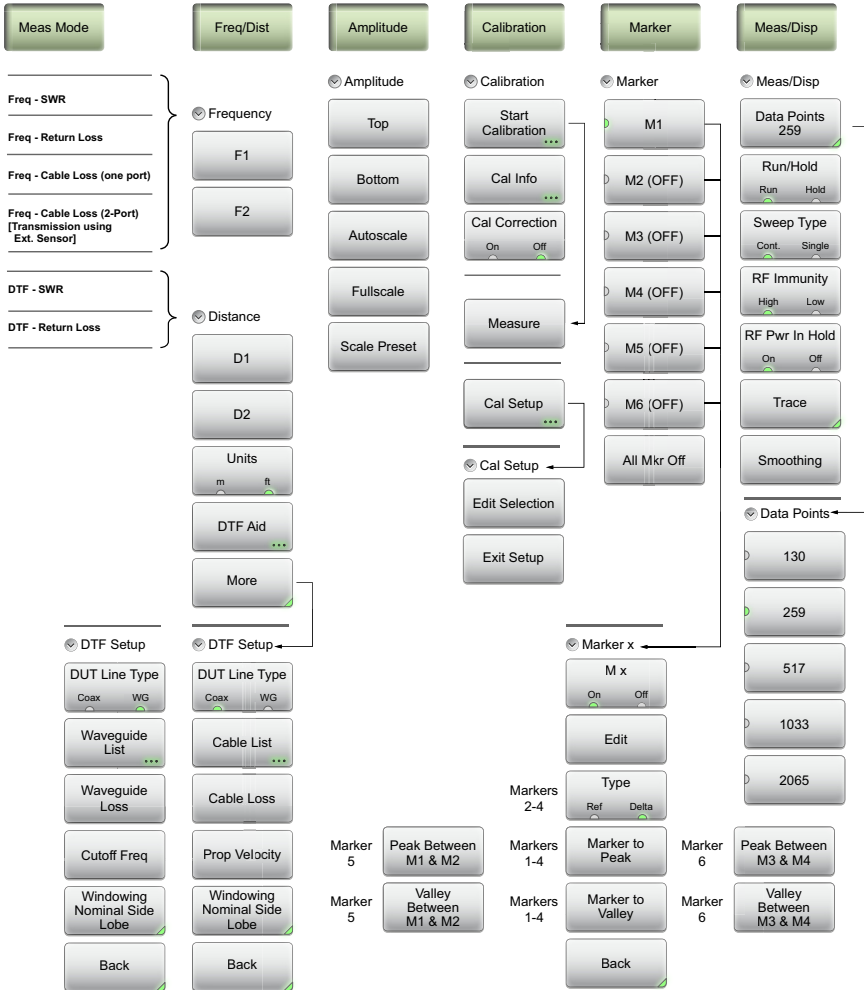

Figure 5-2. "Classic Mode" Menu Keys (1 of 2)

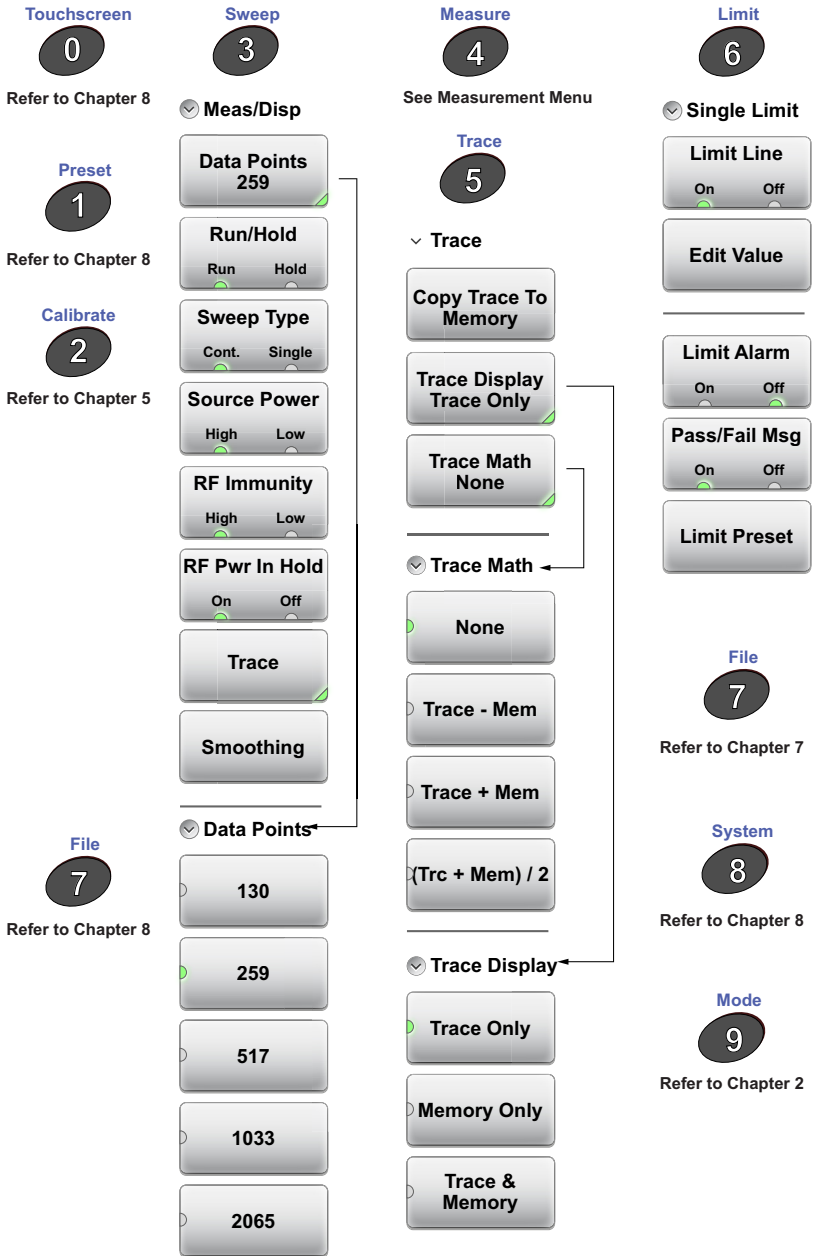

Figure 5-3. “Classic Mode” Menu Keys (2 of 2)

5-4 Marker Menu

Key Sequence: **Marker**





	<p><i>Marker</i></p> <p>After pressing the Marker button, Marker 1 (M1) is automatically turned on and appears at the last used location. If no last used location exists (after a preset for example), then Marker 1 appears in the center of the measurement screen.</p> <p>M1: Press to display the Marker 1 menu (Figure 5-5 on page 5-7), which gives access to marker parameter settings.</p> <p>The key label displays the marker number only (M1 for example) when the marker is ON, and displays M1 (OFF) when the marker is not in use. The green half circle also indicates that the marker is ON.</p> <p>Submenu keys M2 through M6 behave in the same manner as M1.</p> <p>All Mkr Off: Press this key to turn OFF all markers.</p>
	
	
	
	
	
	
	
	

Figure 5-4. Marker Menu (1 of 2)

Marker Menu (Continued)

Key Sequence: **Marker** > M 1

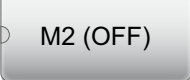
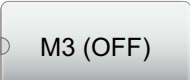
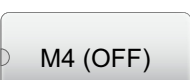
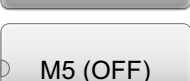

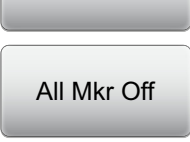





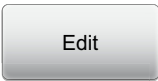
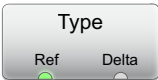

 Marker 1	<i>Marker</i>	
	M 1 (On Off): Press this key to turn OFF the selected marker (M1 to M6).	
	Edit: Press this key to enter a marker value.	
	Type (Ref Delta): Press this key to toggle the marker type between Reference and Delta. This key is displayed for markers M2 through M4 only. Marker M1 is a Reference marker only.	
Markers 1-4		Marker to Peak: Press this key to set a Marker (M1 to M4 only) on the highest signal amplitude in the displayed trace.
Markers 1-4		Marker to Valley: Press this key to set a Marker (M1 to M4 only) on the lowest signal amplitude in the displayed trace.
	Back: Press this key to return to the Marker menu.	
Marker 5		<i>Markers 5 and 6 can perform a special Marker search to find the Peak or Valley between two other markers. When Marker 5 is Active:</i>
Marker 5		Peak Between M1 & M2: Places Marker 5 on the highest signal amplitude between Marker 1 and Marker 2.
Marker 6		Valley Between M1 & M2: Places Marker 5 on the lowest signal amplitude between Marker 1 and Marker 2.
Marker 6		<i>When Marker 6 is Active:</i>
		Peak Between M3 & M4: Places Marker 6 on the highest signal amplitude between Marker 3 and Marker 4.
		Valley Between M3 & M4: Places Marker 6 on the lowest signal amplitude between Marker 3 and Marker 4.

Figure 5-5. Marker Menu (2 of 2)

5-5 Limit Menu

Limit lines can be used for visual reference only, or for pass/fail criteria using the limit alarm and Pass/Fail Message keys. Limit alarm failures are reported whenever a signal crosses the limit line.

Key Sequence: **Limit (6)**







	<i>Single Limit</i>
	<p>Limit Line (On Off): This key toggles the limit line On or Off. Limit line amplitude is stored even when turned off. The type of limit line, upper or lower, is determined by the measurement. For example, VSWR and Return loss utilize an upper limit, and Cable Loss utilizes a lower limit. The limit line changes from green to red when the limit is reached. Any points on a trace that touch or exceed a limit line setting are also displayed in Red.</p>
	<p>Edit Value: Press this key to change the amplitude of the limit line with the Up/Down Arrow keys, rotary knob, or the number keypad.</p>
	<p>Limit Alarm (On Off): When turned On, the Limit Alarm sounds a repeating beep when the trace touches the limit line.</p>
	<p>Pass/Fail Msg (On Off): When turned On, a Pass or Fail message is displayed to indicate whether the trace touches or exceeds the limit line (Fail). See Figure 5-7 on page 5-9.</p>
	<p>Limit Preset: Turns the limit line Off and clears amplitude information. The next time that a limit line is turned On, it is displayed at the default location (center of the display).</p>
	

Figure 5-6. Limit Menu

Pass/Fail Messages

Figure 3-22 on page 3-39 shows the Pass/Fail message. To change the size and location of the Pass/Fail message, (when the Limit menu is displayed) tap the small circled arrow in the lower-right corner of the large format message box. The circled arrow is in the upper-left corner when the message is in small format. Notice that the trace is displayed in red wherever it meets or exceeds the set limit.

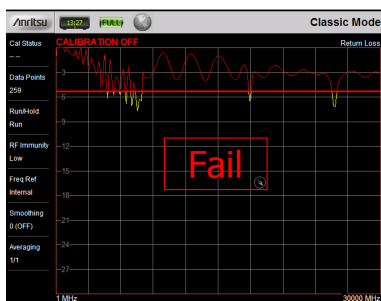
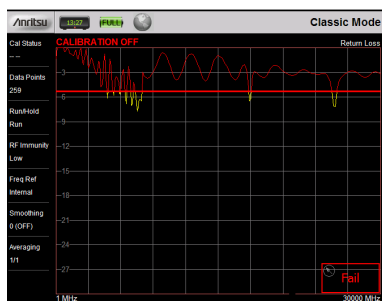
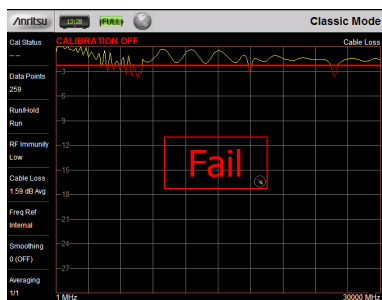

Figure 5-7. Pass / Fail Messages

Table 5-2. Classic Mode Limit Lines Messages

Measurement	Typical End Tool	Pass/Fail Criteria
Return Loss	Load	Pass when the trace is below the limit line
DTF Return Loss	Load	Pass when the trace is below the limit line
Cable Loss	Short or Open	Pass when the trace is above the limit line
VSWR	Load	Pass when the trace is below the limit line
DTF VSWR	Load	Pass when the trace is below the limit line

5-6 All Other Menus

The other menus that are shown in [Figure 5-2 on page 5-4](#) and [Figure 5-3 on page 5-5](#) are described in [Chapter 3](#).

Chapter 6 — VNA Mode

6-1 Introduction

This chapter provides an overview of VNA Mode (Vector Network Analyzer mode, Option 440) measurements.

Note	Use the Menu key and confirm that the instrument is in Vector Network Analyzer mode.
-------------	--

[Figure 6-1 on page 6-2](#) illustrates a typical VNA Mode display screen.

Note	Screen images in this User Guide are illustrations of typical instrument features. Some images may include instruments other than the Site Master S820E. Traces and other display features may differ from the screen displays of your instrument.
-------------	--

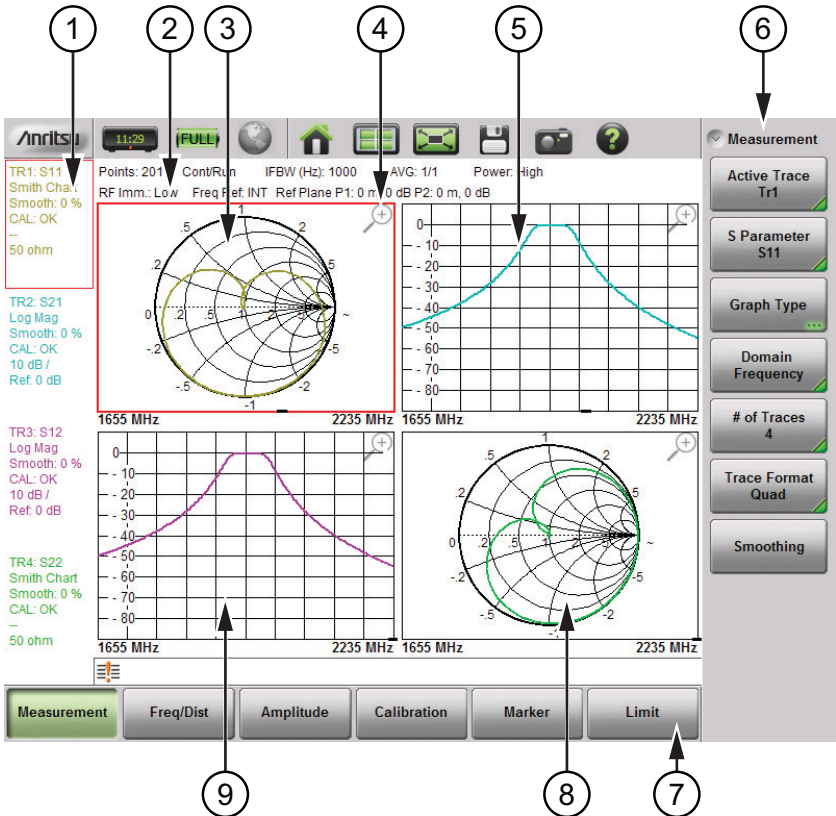

1.	Instrument Settings Summary – unique to each trace
2.	Instrument Settings Summary – applies to all traces
3.	Trace 1 (TR1)
4.	Magnifying Glass, to maximize size of trace
5.	Trace 2 (TR2)
6.	Submenu Button (Key) Labels
7.	Main Menu Button (Key) Labels
8.	Trace 4 (TR4)
9.	Trace 3 (TR3)

Figure 6-1. VNA Mode Display Overview

Chapter Overview

The S820E Site Master is a Vector Network Analyzer that can measure the magnitude and phase characteristics of 1-port or 2-port networks, including cables, antennas, filters, isolators, and attenuators.

VNA mode provides advantages over Cable-Antenna Analyzer Mode via more advanced measurements, more flexibility, and more calibration choices. The main advantages are scattering parameter (S-parameter) choices, graph type choices, and domain choices. In VNA mode, these three measurement choices can be mixed and matched to provide users with more freedom and flexibility. For simplicity in Cable-Antenna Analyzer mode, the choices are more fixed and limited.

Advanced graph types allow you to look at the same device measurements in many different ways. The ability to display four traces provides you with the flexibility of comparing various measurements to obtain the results you need more efficiently.

Advanced graph types such as Group Delay, Real, Imaginary, inverted Smith Chart, Real Impedance, and Imaginary Impedance are available in the S820E in addition to the standard graph types, Log Mag, SWR, Phase, and Smith Chart. The S820E gives you the ability to display four traces overlaid, or they can be displayed in individual graphs.

In Cable-Antenna Analyzer Mode, the S820E is a two-port, 1-path instrument. In VNA Mode, the S820E is a full-reversing VNA that is capable of measuring all S-parameters (S_{11} , S_{21} , S_{22} , and S_{12}) of a 2-port device with a single connection. Being able to measure both forward and reverse S-parameters allows you to use more advanced calibration methods and to make more accurate measurements of a 2-port device.

6-2 S-Parameters

To simplify the description of the types of measurements a VNA can make, the reflection and transmission measurements are defined in terms of scattering parameters, or S-parameters. For a 2-port network, four fundamental S-parameters can be measured, and they are defined as S_{XY} . For a 2-port VNA, measurements of signals leaving Port 1 are called forward measurements, and those leaving Port 2 are called reverse measurements. Signals that leave and return to the same port are designated reflection measurements, and those that leave one port and return to another port are designated transmission measurements. S-parameters are an abbreviated designation for these measurements, and are used as shown in the following list:

- S_{11} : Forward Reflection
- S_{21} : Forward Transmission
- S_{12} : Reverse Transmission
- S_{22} : Reverse Reflection

The first number (X) in S_{XY} is the port number in which the signal is being received, and the second number (Y) is the port number from which the signal is being transmitted. The S-parameter is a ratio of these two signals.

Additional Examples:

S_{11} : Forward Reflection represents the measurement in which the incident signal is transmitted from port 1 and is reflected back to port 1.

S_{21} : Forward Transmission represents the measurement in which the incident signal is transmitted from port 1 and is received at port 2.

S_{12} : Reverse Transmission represents the measurement in which the incident signal is transmitted from port 2 and is received at port 1.

S_{22} : Reverse Reflection represents the measurement in which the incident signal is transmitted from port 2 and is reflected back to port 2.

6-3 Calculating and Displaying S-Parameters

S-parameters are a measure of the ratio of two complex voltage levels, one measured by the port receiver, and one measured by the reference receiver. S-parameters therefore consist of unitless complex numbers.

Depending on the application, S-parameters can be displayed in many ways and can be used to calculate other parameters. S-parameters consist of real and imaginary numbers. More typically, however, they are represented as magnitude and phase. In most cases, the magnitude is displayed in dB (this term is often called log magnitude). We can display phase as “linear phase”. With phase, we cannot tell the difference between one cycle and the next. After going through 360 degrees, we are back to where we began. We can display the measurement from -180 degrees to $+180$ degrees, which keeps the phase transition point at the top and bottom edges of the display and away from the important 0 degrees area that is used as the phase reference. The S820E supports the following display types. Each type is associated with a particular S-parameter:

$$S_{xy} = S_{\text{Real}} + jS_{\text{Imaginary}}$$

(where j is the square root of -1).

Log Magnitude

$$\text{LogMagnitude (dB)} = 20\text{Log}_{10}|S_{xy}|$$

Applications

To measure return loss at Port 1 (or Port 2), use the Log Mag display with S_{11} (or S_{22}).

To measure the gain or loss in a DUT that is connected between Port 1 and Port 2, use the Log Mag display with S_{21} or S_{12} .

Log Magnitude / 2

$$\frac{\text{LogMagnitude}}{2}(\text{dB}) = 0.5 \times 20 \text{Log}_{10} |S_{xy}|$$

Applications

For measuring 1-port cable loss, use S_{11} or S_{22} with the Log Mag/2 display type to account for the round trip signal path through the cable. When using reflection data to measure cable loss, the end of the cable must be shorted or must be a perfect open.

Phase

$$\text{Phase}(\text{degrees}) = \text{Tan}^{-1} \left| \frac{S_{\text{Imaginary}}}{S_{\text{Real}}} \right| \times \left(\frac{180}{\pi} \right)$$

Applications

Use the Phase or Unwrapped Phase measurement to display the phase in degrees of S_{xy} . The Phase measurement is contained within a vertical scale of $\pm 180_{\text{degrees}}$, whereas the unwrapped phase displays the linear phase without wrapping it at the 180_{degrees} transitions. See [Figure 6-2 on page 6-8](#). Unwrapped phase is obtained by counting the number of transitions of the phase measurement (note the vertical scale in the figure). Unwrapped phase will be accurate only if the measurement has enough data points to capture all of these transitions. Also, the first data point must be low enough in frequency so that its phase is less than 180_{degrees} from DC, otherwise the unwrapped phase measurement will have errors.

Real and Imaginary

$$S_{\text{Real}} = \text{Real part of the complex S-parameter } S_{xy}$$

$$S_{\text{Imaginary}} = \text{Imaginary part of the complex S-parameter } S_{xy}$$

Applications

Use the Real and Imaginary graph types to measure the elements of the complex S-parameter S_{xy} .

SWR

$$\text{SWR} = \frac{(1 + |S_{xx}|)}{(1 - |S_{xx}|)}$$

Applications

SWR, or Standing Wave Ratio, is a measure of the reflection from the DUT input port or output port, and it must be used, therefore, with S_{11} or S_{22} .

Group Delay

Group Delay (sec) = rate of change of phase over a specified frequency aperture

Applications

Group Delay is a measure of the time delay of the signals that are propagating through the DUT versus frequency (using S_{21} or S_{12}). Group delay is a good measure of phase distortion through the DUT.

Smith Chart

Smith Chart = graphical tool for plotting impedance or admittance data versus frequency

Applications

Use Smith Chart with S_{11} or S_{22} to plot the input or output impedance of the DUT.

Use the Inverted Smith Chart to plot admittance data.

Phase versus Unwrapped Phase Graph Types

Two S_{11} measurements are shown in [Figure 6-2](#), one using graph type Unwrapped Phase, and one using graph type Phase. The standard Phase plot displays the phase with its natural wrap-around every 360 degrees (or within a display range of ± 180 degrees). The Unwrapped Phase graph removes the wrapping and plots the phase linearly. Unwrapped phase is obtained by counting the number of transitions of the phase measurement. Note the vertical scales of these two measurements in the figure. The Unwrapped Phase display can be useful for measuring the length of a device in degrees of phase.

Unwrapped phase will be accurate only if the measurement has enough data points to capture all of these transitions. Also, the first data point must be low enough in frequency so that its phase is less than 180 degrees from DC, otherwise the unwrapped phase measurement will have errors.

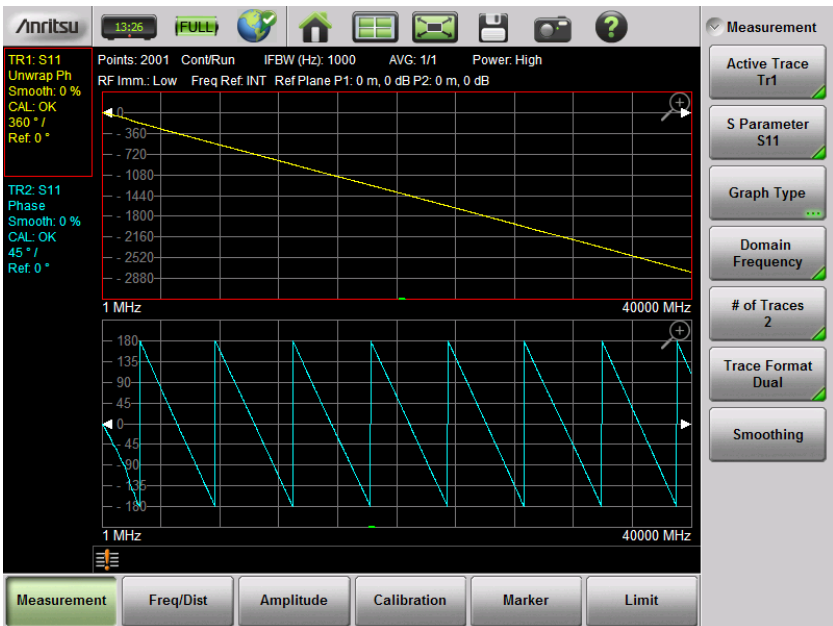

Figure 6-2. Unwrapped Phase Compared with Phase

6-4 Display Capabilities

The vector network analyzer has a flexible display capability that allows single, dual, tri, and quad displays, meaning that you can subdivide the measurement display area into 2, 3, or 4 sections. In addition, the vector network analyzer supports the display of up to four traces in each single, dual, tri, or quad display. Becoming familiar with these flexible display capabilities is important before you begin any calibrations and measurements.

Flexible Features For Displaying Results

If you are not yet familiar with the menus that control trace display, then refer to the [“Measurement Menu” on page 6-20](#) and the [“Trace Menu” on page 6-42](#). To select the Measurement menu in VNA Mode, press the **Measurement** main menu key (you must be in VNA Mode for this example).

Perform the following steps to observe the trace format features:

1. The default view (after preset) uses Trace Format = Quad with Number of Traces = 4. Refer to [Figure 6-3](#).

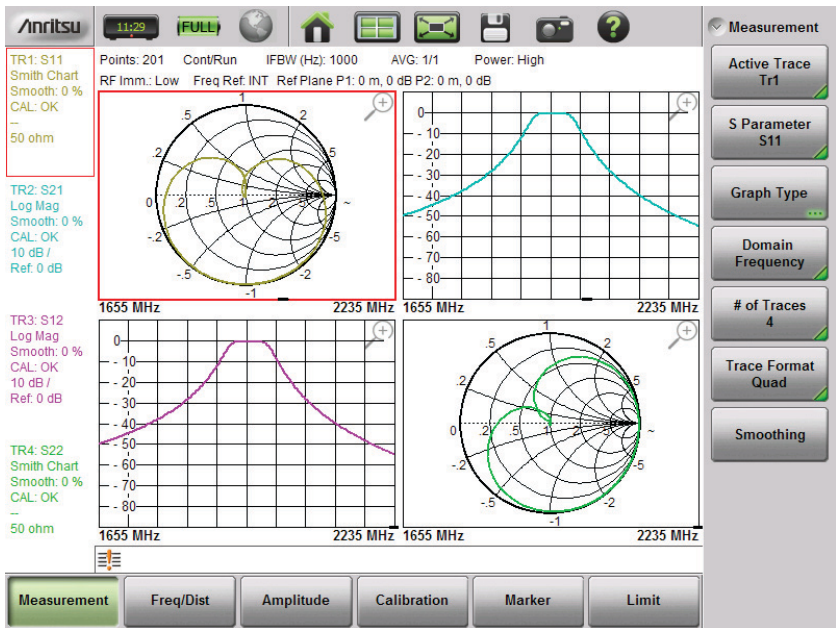

Figure 6-3. Format = Quad, Traces = 4

2. Beginning with the default view, set Trace Format = Single, with Number of Traces = 4. Notice how all 4 traces are overlaid on a single graph. Refer to Figure 6-4.

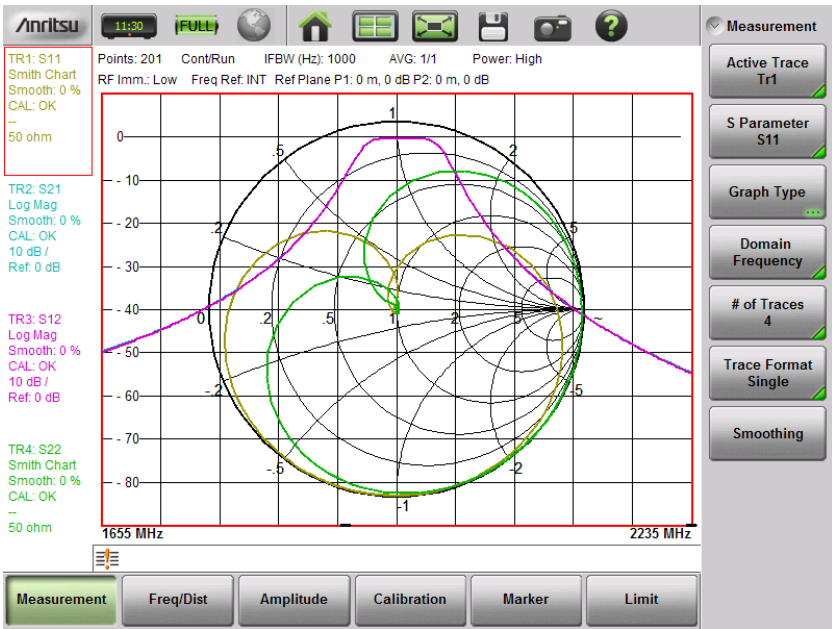

Figure 6-4. Format = Single, Traces = 4

3. Next, set Trace Format = Dual. Note how the 4 traces are assigned to the split display. TR1 (Trace 1) and TR3 are assigned to the top graph. TR2 and TR4 are assigned to the bottom graph. Refer to [Figure 6-5](#).

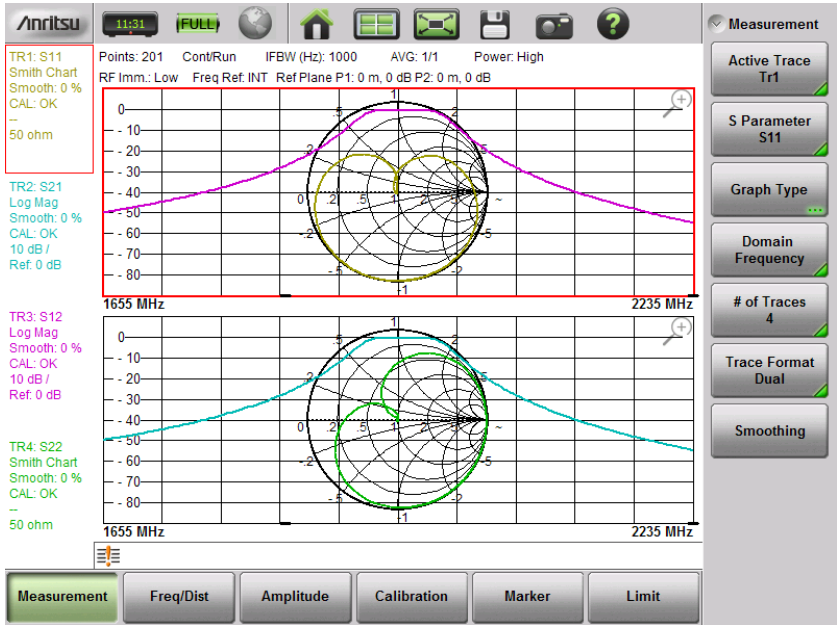

Figure 6-5. Format = Dual, Traces = 4

- Next change Trace Format to Tri. Note how the 4 traces are assigned on this display. TR3 and TR4 are now overlaid in the bottom half of the display area. Refer to [Figure 6-6](#).

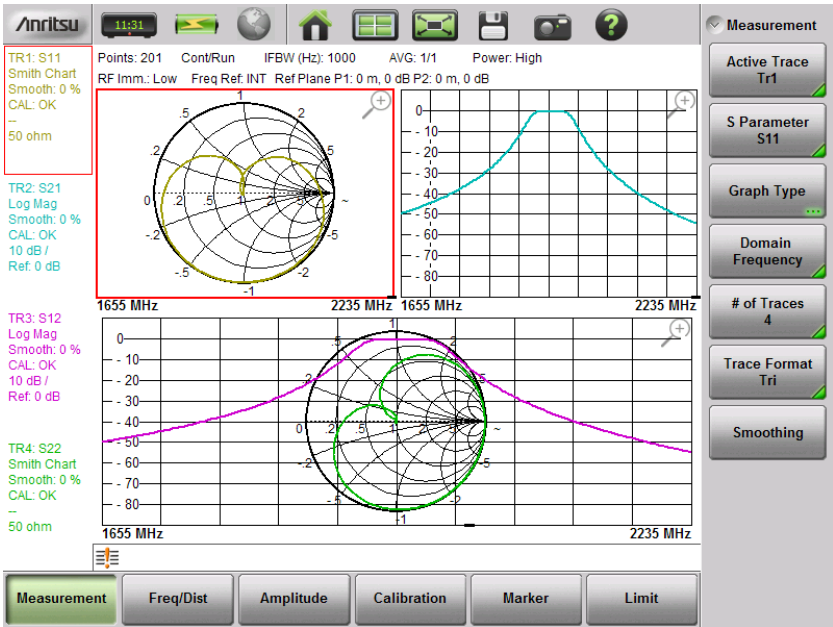

Figure 6-6. Format = Tri, Traces = 4

- Now return to the default display of Trace Format = Quad. Change the Number of Traces from 4 to 1. Note how the top left quadrant is filled, while the other three quadrants have no data. Refer to [Figure 6-7](#).

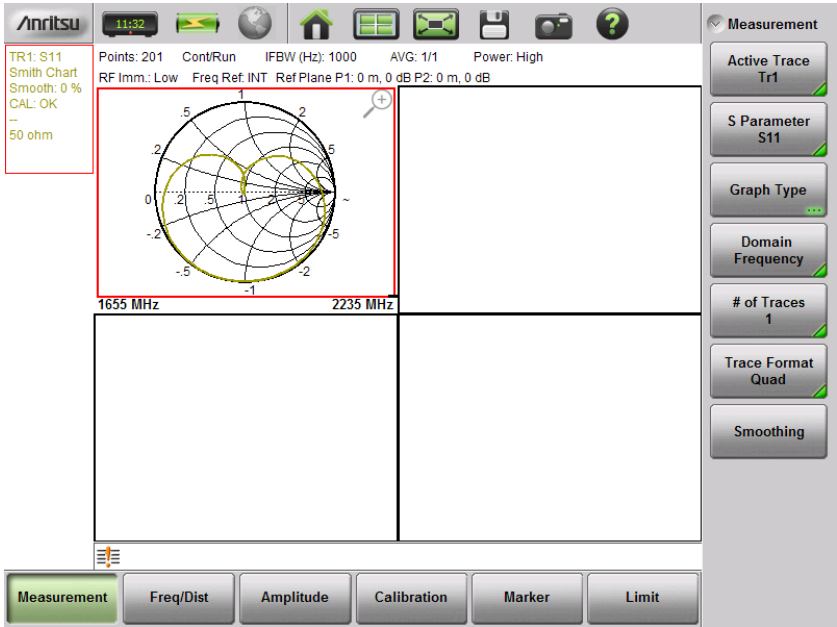

Figure 6-7. Format = Quad, Traces = 1

6. Increment the number of traces from 1 back to 4 and note how the vector network analyzer adds the additional traces to the display. Refer to [Figure 6-8](#). (Note that [Figure 6-3](#) and [Figure 6-8](#) are the same measurement illustration.)

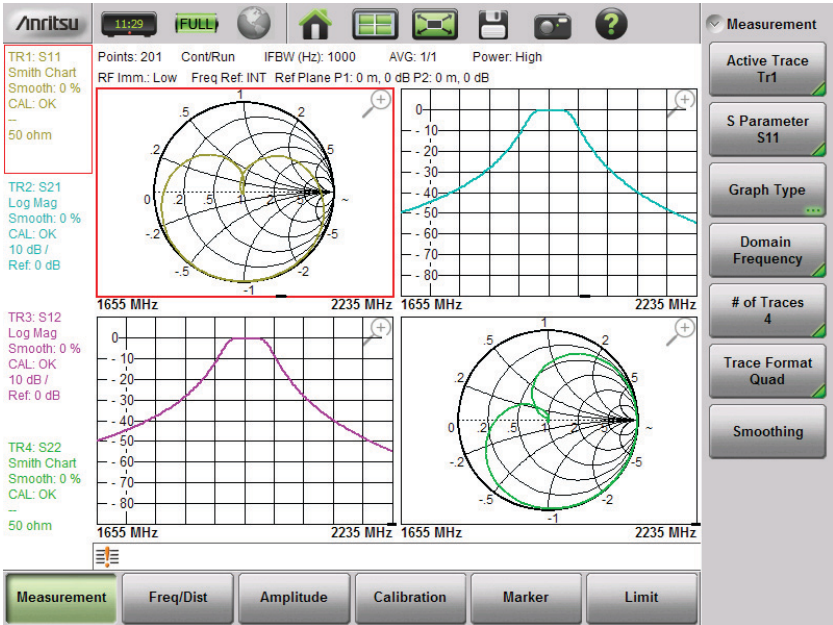

Figure 6-8. Format = Quad, Traces = 4 (same as [Figure 6-3](#))

At this point, the display is back to the default setting of Quad with 4 traces. Regardless of the Trace Format that is selected, the number of traces that are displayed is controlled by the Number of Traces submenu key. For a brief description, refer to the examples in section “[Trace Format and Number of Traces](#)” on page 6-21.

6-5 Active Trace and Markers

Notice on the Quad trace format that one trace has a red outline box on the graph, and the trace number in the Instrument Settings Summary (on the left side of the sweep window) is outlined with a red rectangle. This is the active trace, and only one trace is active at a time. Any display or format selection is applied only to the active trace.

You can change the active trace in two ways:

- In the Measure menu, press the **Active Trace** submenu key to select the trace that you want to be active. After a selection, notice how the active trace indicator on the display has changed. For example, if the active trace changed from TR1 to TR3, then the red highlight box moved from the upper left quadrant to the lower left quadrant.

Not only does the graph get highlighted in red, but the Instrument Settings Summary legend on the left side of the sweep window also highlights the active trace. This becomes more important when you are trying to distinguish between active traces and other traces when they are all overlaid on one graph.

- Touching a trace area or touching the trace data in the Instrument Settings Summary causes that trace to become active.

Magnifying Glass

When Trace Format is Dual, Tri, or Quad, you can magnify the active trace by touching the magnifying glass symbol  in the upper-right corner of the active trace.

Touching the magnifying glass symbol  of a magnified trace reduces the trace size to return the display to the selected trace format.

While a trace is magnified, you can still change the active trace selection by touching the trace data in the Instrument Settings Summary.

Moving a Marker

When Trace Format is Single, Dual, Tri, or Quad, touching a trace can affect a marker. After the trace is active, you can touch and hold a marker to make it active. You can then move that marker by dragging with your finger. Your touch point on the vertical red line of the active marker represents a location on the x-axis, and this touch point may be anywhere on the y-axis (along the vertical red line). You can also double-tap (quickly) anywhere within the active trace window to bring the active marker to the x-axis location of your touch point. For greater precision, you can maximize the trace (with the **“Magnifying Glass”** icon) before moving the marker.

When the Marker Menu is Not Displayed:

You cannot move a marker with the **Arrow Keys** or the rotary knob.

When the Marker Menu is Displayed:

You can then move the active marker by touch, by keypad entry, by **Arrow Key**, or by rotary knob.

6-6 VNA Mode Menus

Figure 6-9, Figure 6-10, and Figure 6-11 show maps of the VNA menus. Menu maps typically display all possible submenu keys, although some keys may be displayed on the instrument only under special circumstances (refer to menu descriptions on the following pages).

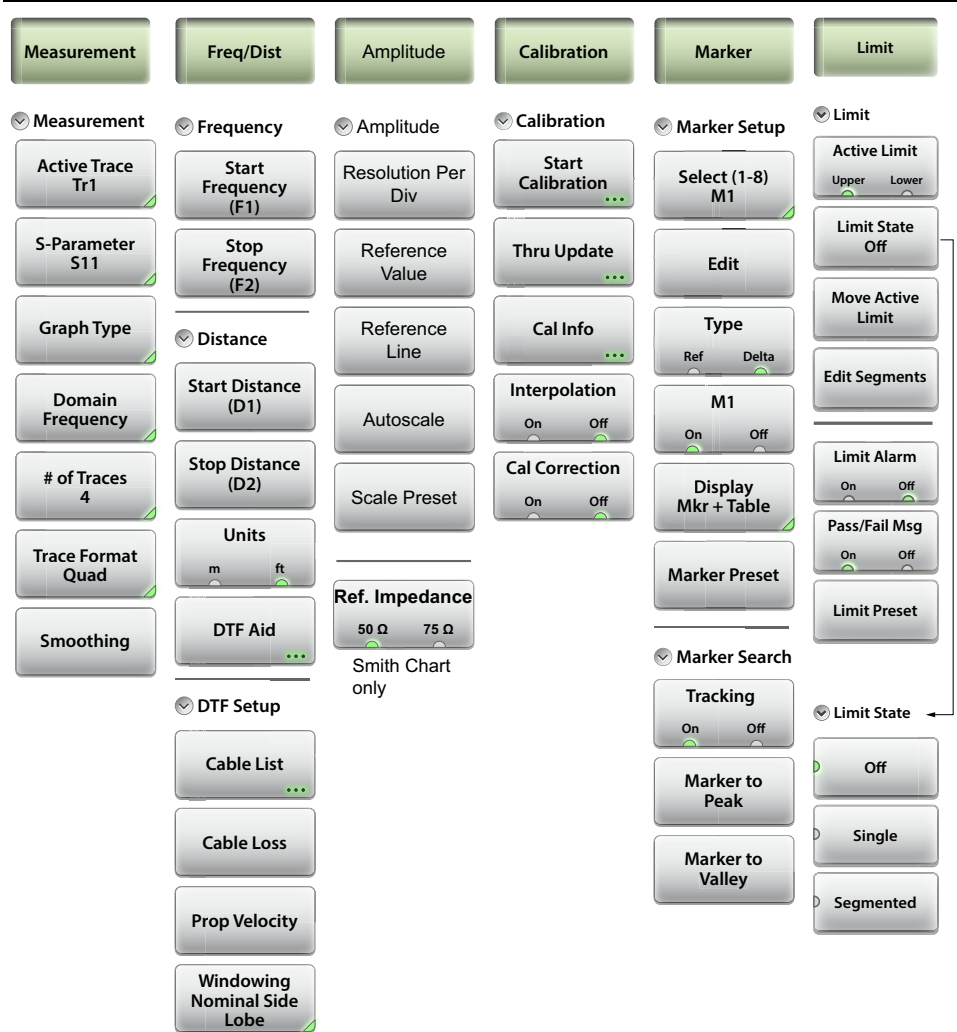

Figure 6-9. Main Menu Keys

Sweep Menu

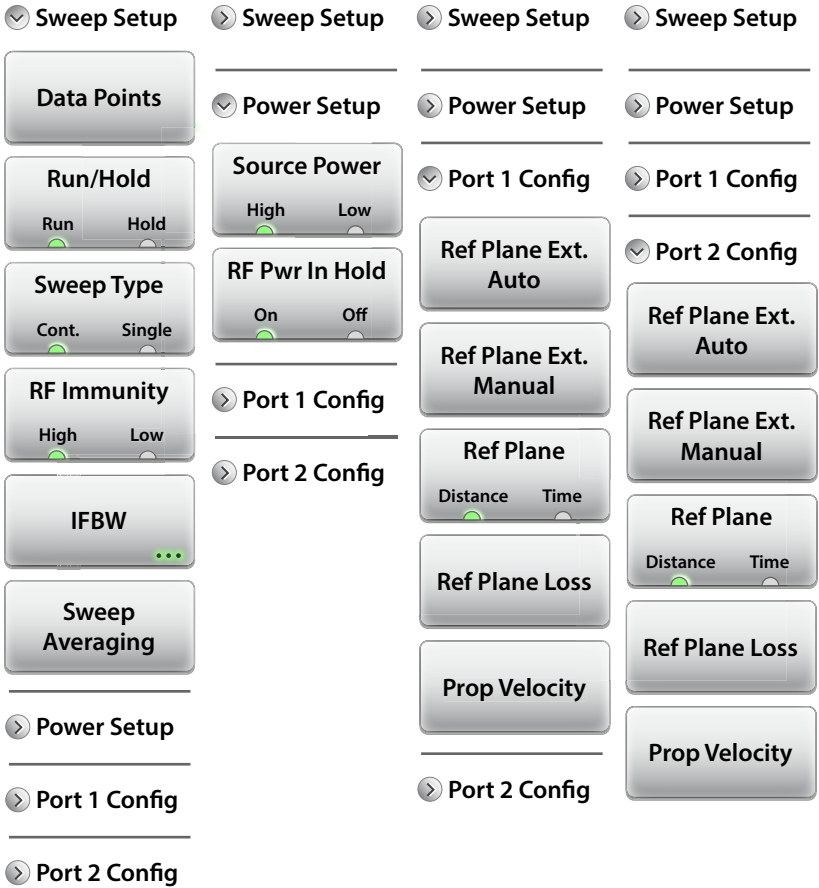

Figure 6-10. Sweep Menu Keys

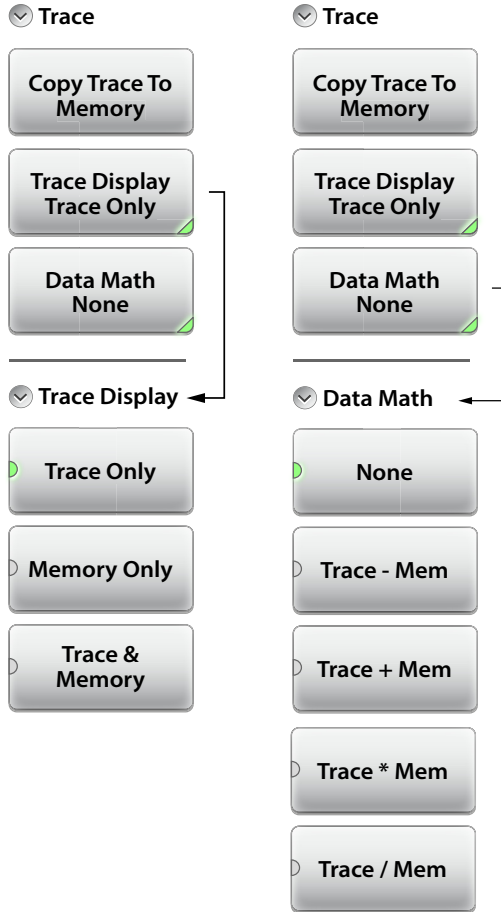

Figure 6-11. Trace Menu Keys

6-7 Measurement Menu

Key Sequence: **Measurement**









	<p><i>Measurement</i></p> <p>Active Trace: Press this submenu key to select a trace to become the active trace.</p> <p>S-Parameter: Press this submenu key to select an S-Parameter for the current (active) trace, choosing from: S_{11}, S_{21}, S_{12}, S_{22}</p> <p>Graph Type: Press this submenu key to display the Graph type list box and choose a type for the current (active) trace. See Figure 6-13 on page 6-22.</p> <p>Domain Frequency: Press this submenu key to choose a domain for the current (active) trace: Frequency or Distance. Each trace can use a different domain.</p> <p># of Traces: Press this submenu key to open the Number of Traces submenu and select the number of traces (1, 2, 3, or 4) to be simultaneously displayed in the sweep window. Refer also to “Trace Format and Number of Traces” on page 6-21.</p> <p>Trace Format: Press this submenu key to open the Trace Format submenu and choose the screen format for trace display: Single, Dual, Tri, Quad. The selected Trace Format is shown on the soft key face.</p> <p>Smoothing: Press this submenu key to add a smoothing percentage from 0 (zero) to 20 %. Use the arrow keys, the rotary knob, or the number keypad to input the value, and then press the % submenu key or the Enter key.</p> <p>To turn smoothing Off, set its value to 0 %.</p>
	
	
	
	
	
	
	
	

Figure 6-12. Measurement Menu

Trace Format and Number of Traces

Use **Single** trace format to display the active trace (or traces) at full size in the sweep window. If more than one trace is selected by the **# of Traces** submenu key, then the traces are displayed overlapping in the sweep window.

Use **Dual** trace format to display 2 traces in the sweep window, with the sweep window divided horizontally into 2 equal rectangles.

Use **Tri** trace format to display 3 traces in the sweep window, with the sweep window divided horizontally and vertically so that 2 equal rectangles share the upper half of the window, and one wide rectangle occupies the lower half of the window.

Use **Quad** trace format to display 4 traces in the sweep window, with the sweep window divided horizontally and vertically into 4 equal rectangles.

Regardless of the **Trace Format** that is selected, the number of traces that are displayed is controlled by the **# of Traces** submenu key.

Examples:

If 4 traces are displayed in **Single Trace Format** mode, then all 4 traces are displayed overlapping in the sweep window.

If 4 traces are displayed in **Dual Trace Format** mode, then Trace 1 and Trace 3 are displayed overlapping in the upper sweep window, and Trace 2 and Trace 4 are displayed overlapping in the lower sweep window.

If 4 traces are displayed in **Tri Trace Format** mode, then Trace 1 and Trace 2 are displayed individually in the upper half of the sweep window, and Trace 3 and Trace 4 are displayed overlapping in the lower sweep window.

If 4 traces are displayed in **Quad Trace Format** mode, then all 4 traces are displayed individually in the sweep window, each trace occupying one quarter of the sweep window.

If 1 trace is displayed in **Dual**, **Tri**, or **Quad** format, then that trace is displayed in the first quarter section of the sweep window, and any other sections are blank.

Graph Type List Box

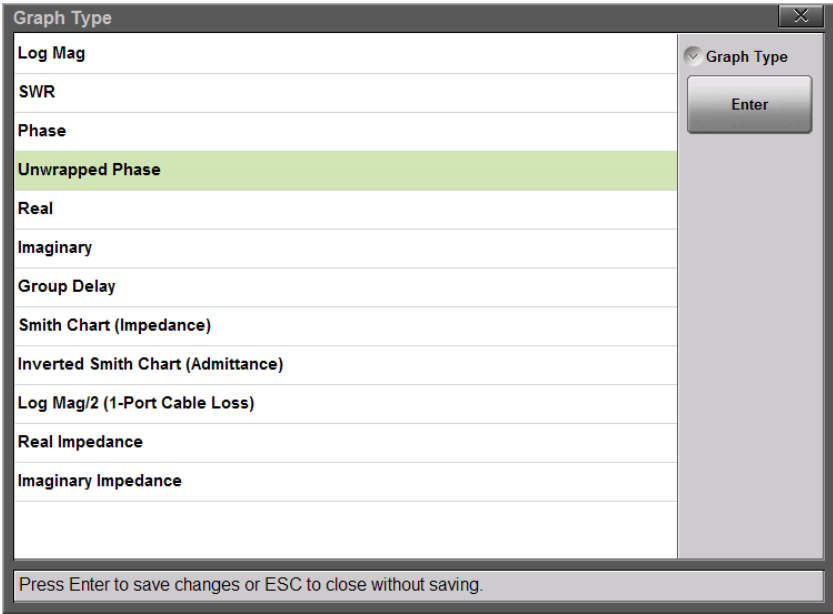

Figure 6-13. Graph Type List Box

6-8 Freq/Dist Menu

Key Sequence: **Freq/Dist** > Frequency or Distance





	<p><i>Frequency</i></p> <p>Start Frequency (F1): Press the Start Frequency (F1) submenu key and enter the desired frequency using the Up/Down Arrow keys, the rotary knob, or the keypad. Press Enter to complete the entry or, if entering a frequency using the keypad, press the appropriate units key.</p>
<p>▼ Frequency</p>  	<p>Stop Frequency (F2): Press the Stop Frequency (F2) submenu key and enter the desired frequency using the Up/Down Arrow keys, the rotary knob, or the keypad. Press Enter to complete the entry or, if entering a frequency using the keypad, press the appropriate units key.</p>
<p>▼ Distance</p>    	<p><i>Distance</i></p> <p>Start Distance (D1): Press the Start Distance submenu key and enter the desired distance using the Up/Down Arrow keys, the rotary knob, or the keypad. Press Enter to complete the entry or, if entering a distance using the keypad, press the appropriate units key.</p> <p>Stop Distance (D2): Press the Stop Distance submenu key and enter the desired distance using the Up/Down Arrow keys, the rotary knob, or the keypad. Press Enter to complete the entry or, if entering a distance using the keypad, press the appropriate units key.</p>
<p>▶ DTF Setup</p>	<p>Units: Press the Units key to toggle distance units between meters and feet.</p> <p>DTF Aid: Opens the DTF Aid dialog box (see Figure 3-5 on page 3-10). This interactive parameter box allows setting multiple parameters and displays maximum testing distance and resolution.</p>

Figure 6-14. Frequency/Distance Menu (1 of 2)

Freq/Dist Menu (Continued)

Key Sequence: **Freq/Dist**



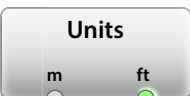
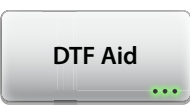





	<i>DTF Setup</i>
	<p>DUT Line Type (Coax WG): Press this submenu key to toggle the line type between Coaxial cable and Waveguide. See Figure 6-16 on page 6-25 for the waveguide submenu keys.</p>
	<p>Cable List: The Cable List submenu key opens a list of available cable specifications. Using Up/Down Arrow keys, the rotary knob, or the touchscreen, select the desired cable and press Enter. See Figure 6-17 on page 6-26 for an example of the cable and waveguide lists.</p>
	<p>Note: When a cable is selected from this list, propagation velocity and cable loss are automatically set by the instrument. If the preselected values for propagation velocity or cable loss are changed, then the analyzer will use “NONE” as the cable type.</p>
	<p>Cable Loss: Press the Cable Loss (or Waveguide Loss) submenu key and enter the loss in dB/ft or dB/m for the selected cable (or Waveguide) by using the keypad, Up/Down Arrow keys, or the rotary knob, and then press Enter.</p>
	<p>Prop Velocity: Press the Prop Velocity submenu key and enter the applicable propagation velocity for the selected cable by using the keypad, Up/Down Arrow keys, or the rotary knob, and then press Enter.</p>
	<p>Cutoff Freq: Press this waveguide submenu key and enter the applicable cutoff frequency in Hz for the selected waveguide by using the keypad, Up/Down Arrow keys, or the rotary knob, and then press Enter. See Figure 6-16 on page 6-25 for the waveguide submenu keys.</p>
	<p>Windowing: Opens the “Windowing Menu” on page 6-27.</p>
	

Figure 6-15. Frequency/Distance Menu (2 of 2)

DTF Setup for Waveguide

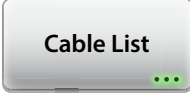
When the DUT line type is WG (waveguide), the coaxial cable submenu keys are changed to waveguide submenu keys.

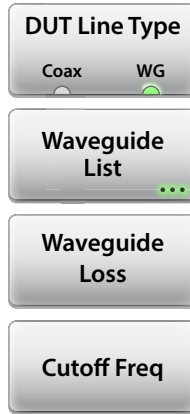

Figure 6-16. Waveguide Submenu Keys

Cable and Waveguide List Boxes

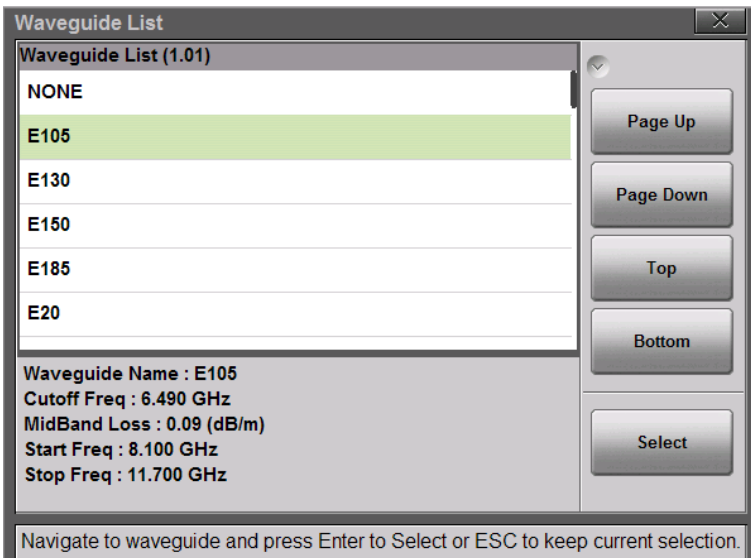
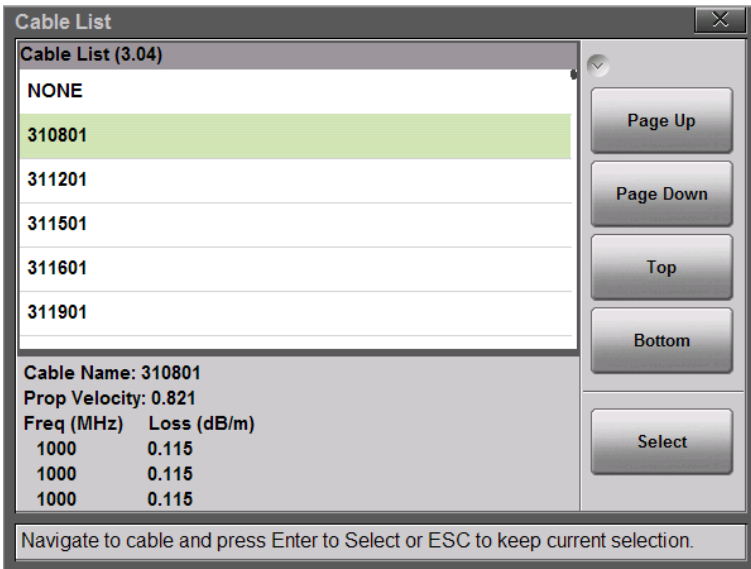

Figure 6-17. Cable and Waveguide List Boxes

Windowing Menu

Key Sequence: **Freq/Dist** > DTF Setup > Windowing

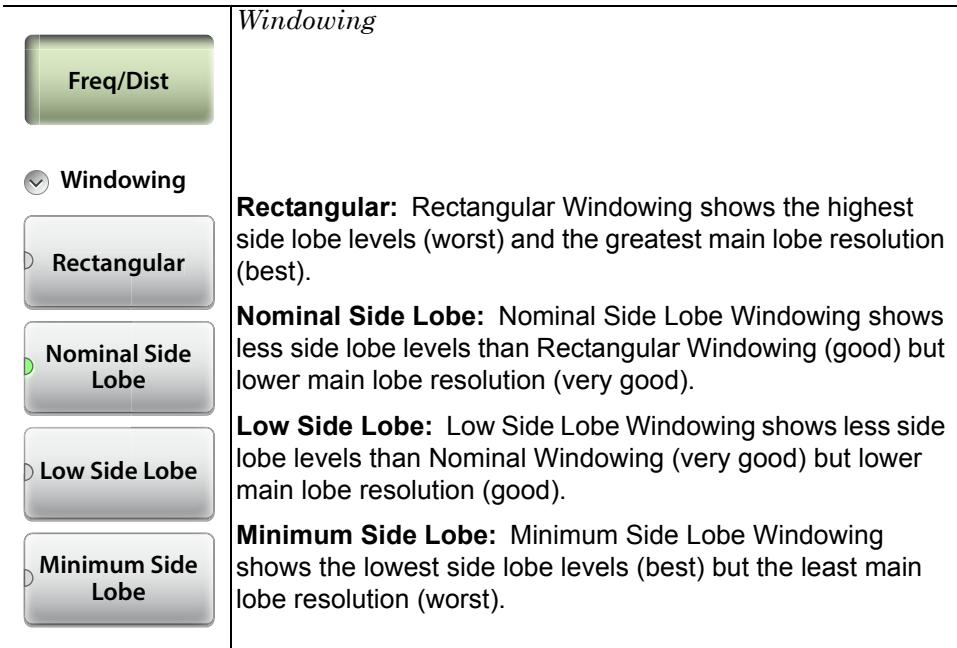

Figure 6-18. Windowing Menu

6-9 Amplitude Menu

Key Sequence: **Amplitude**

<p>Amplitude</p> <p>Resolution Per Div</p> <p>Reference Value</p> <p>Reference Line</p> <p>Autoscale</p> <p>Scale Preset</p> <hr/> <p>Ref. Impedance</p> <p>50 Ω 75 Ω</p>	<p><i>Amplitude</i></p> <p>Resolution Per Div: Press this submenu key to set the number of units that are displayed between horizontal vertical graph lines. Units depend upon frequency, time, and distance settings. Use the Up/Down Arrow keys, the keypad, or the rotary knob to set this parameter, then press the Enter key to complete the entry.</p> <p>Reference Value: Press this submenu key to set the value of the Reference Line. Use the Up/Down Arrow keys, the keypad, or the rotary knob to set this parameter, then press the Enter key.</p> <p>Reference Line: Press this submenu key to set which horizontal graph is at the reference value. The reference line is indicated by a small colored triangle along the right edge of the graph. Use the Up/Down Arrow keys, the keypad, or the rotary knob to set this parameter, then press the Enter key.</p> <p>Autoscale: Press the Autoscale submenu key to automatically adjust the Resolution Per Div and Reference Value so that the trace for the current measurement is shown in the middle of the display.</p> <p>Scale Preset: Scale Preset automatically sets the scale to the default setting:</p> <p style="padding-left: 40px;">Log Mag: Res/Div = 10 dB, Ref Val = 0 dB SWR: Res/Div = 1, Ref Val = 1 Phase: Res/Div = 45 deg, Ref Val = 0 Real/Imag: Res/Div = 0.2, Ref Val = 0 Impedance: Res/Div = 10 ohm, Ref Val = 50 ohm Group Delay: Res/Div = 1 ns, Ref Val = 0 ns;</p> <p>Ref. Impedance 50 Ω 75 Ω: Sets the reference impedance that is used for Smith Chart calculations to either 50 Ω or 75 Ω. The reference impedance determines the value of impedance at the center of the Smith Chart. This submenu key is displayed only when a Smith Chart trace is active.</p>
---	--

Figure 6-19. Amplitude Menu

6-10 Calibration Menu

Refer to [Chapter 7, “Calibration, VNA”](#).

6-11 Marker Menu

Key Sequence: **Marker**







	<i>Marker Setup</i>
	<p>Select (1–8) M#: Press to turn on a marker (1 to 8) and selects which marker is active (green half circle). Current active marker is displayed on the button (M1).</p>
	<p>Edit: Press to change the position of the active marker using the Up/Down Arrow keys, rotary knob or the keypad.</p>
	<p>Type: Sets the current active marker as a reference (standard) marker or a delta marker relative to Marker 1. Marker 1 is always a reference marker.</p>
	<p>M1 (On Off): Toggles the display of the active marker (M1 through M8) On or OFF. When off, the location of the marker is stored.</p>
	<p>Display (Mkr + Table, Mkr Only, Off): Press to see display options.</p>
	<p>Mkr+Table: Displays both the markers that are on and the marker table.</p>
	<p>Mkr Only: Displays markers that are on, but hides the marker table.</p>
	<p>Off: Hides all markers and the marker table.</p>
	<p>Marker Preset: Turns off all markers except for Marker 1. Sets Marker 1 location to the middle of the sweep.</p>

Figure 6-20. Marker Menu (1 of 2)

Marker Menu (Continued)

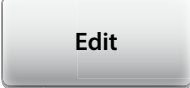
Key Sequence: **Marker** > Marker Search

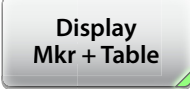
<p>➤ Marker Setup</p>	<p><i>Marker Search</i></p>	
<p>▼ Marker Search</p>		
<p>Tracking</p> <p>On Off</p>		<p>Tracking (On Off): When turned On, the active marker becomes a tracking marker and defaults to tracking the peak. To track Valleys, press the Marker to Valley button after turning on Tracking. The Search settings can all be applied to a Marker with Tracking either On or Off.</p>
<p>Marker to Peak</p>		<p>Marker to Peak: Places the currently active marker on the highest signal amplitude currently displayed on screen.</p>
<p>Marker to Valley</p>	<p>Marker to Valley: Places the currently active marker on the lowest signal amplitude currently displayed on screen.</p>	

Figure 6-21. Marker Menu (2 of 2)

6-12 Limit Menu

Limit lines can be used for visual reference only, or for pass/fail criteria using the limit alarm and Pass/Fail Message keys. Limit alarm failures are reported whenever a signal crosses the limit line.

Key Sequence: **Limit (6)** or **Limit**







	<p><i>Limit</i></p>
	<p>Active Limit (Upper Lower): This key toggles the active limit line settings to the Upper or Lower limit.</p>
	<p>Limit State: Press this key to display the Limit State menu and select one of three limit states: Off, single, or Segmented. The current limit state is displayed on the key.</p>
	<p>Move Active Limit: Press this key to change the amplitude of the limit line with the Up/Down Arrow keys, rotary knob, or the number keypad. If the limit line is divided into segments, then all segments move by the same amount.</p>
	<p>Edit Segments: Press this key to display the Segments menu and a table of limit line segments (see Figure 6-24 on page 6-33). Tap a segment (Upper or Lower), and then choose a function from the Edit Segments menu (Figure 6-25 on page 6-33). Refer also to “Edit Limit Values Dialog Box” on page 6-34.</p>
	<p>Limit Alarm (On Off): When turned On, the Limit Alarm sounds a repeating beep when the trace touches the limit line.</p>
	<p>Pass/Fail Msg (On Off): When turned On, a Pass or Fail message is displayed to indicate whether the trace touches or exceeds the limit line (Fail).</p>
	<p>Limit Preset: Turns the limit line off and clears amplitude information. The next time that a limit line is turned on, it will be displayed at the default location (center of the display).</p>
	

Figure 6-22. Limit Menu

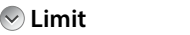
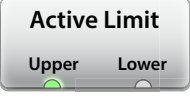
6-13 Limit State Menu

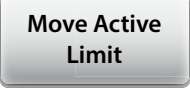
Key Sequence: **Limit (6)** or **Limit > Limit State**

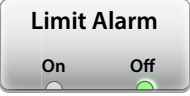
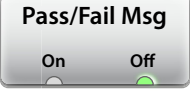
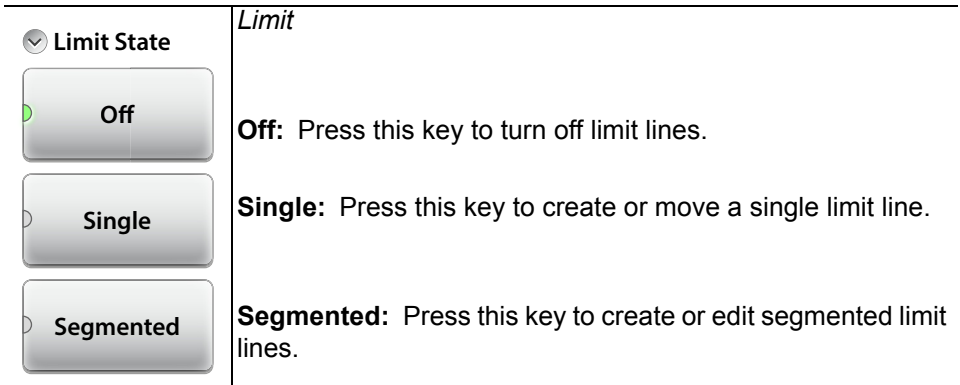

Figure 6-23. Limit State Menu

Edit Segments List Box

#	Type	Start(x1,y1)	Stop(x2,y2)
1	U	1 MHz, 26 dB	40000 MHz, 26 dB
1	L	1 MHz, -14 dB	10000 MHz, -9 dB
2	L	10100 MHz, -9 dB	20000 MHz, -9 dB
3	L	20100 MHz, -9 dB	40000 MHz, -14 dB

Figure 6-24. Edit Segments List Box

Edit Segments (Limit) Menu

Key Sequence: **Limit** > Edit Segments

<p>☑ Segments</p> <p>Add</p> <p>Edit</p> <p>Delete</p> <p>Close (ESC)</p>	<p><i>Edit Segments</i></p> <p>Add: Press this key to add a segment. A dialog box is displayed allowing selection of Upper or Lower limit lines and settings for Start and Stop x-axis values and y-axis values. Press Enter to save changes, or press ESC to close without saving. Refer to “Edit Limit Values Dialog Box” on page 6-34.</p> <p>Edit: Press this key to edit the highlighted segment. A dialog box is displayed allowing selection of Upper or Lower limit lines and settings for Start and Stop x-axis values and y-axis values. Press Enter to save changes, or press ESC to close without saving.</p> <p>Delete: Press this key to delete the selected limit segments.</p> <p>Close (ESC): Press this key (or press the Esc key) to close the Segments menu and return to the Limit menu.</p>
---	--

Figure 6-25. Limit Line Segments Menu

Edit Limit Values Dialog Box

Upper Lower

Start X	<input type="text" value="1 MHz"/>	Start Y	<input type="text" value="26 dB"/>
Stop X	<input type="text" value="40000 MHz"/>	Stop Y	<input type="text" value="26 dB"/>

Edit limit values and press Enter to save changes or ESC to close without saving.

Figure 6-26. Edit Limit Values Dialog Box

6-14 Sweep Menu 1

Sweep Setup

Key Sequence: **Sweep (3)** > Sweep Setup











 Sweep Setup	<i>Sweep Setup</i>
	<p>Data Points: Sets the number of data points in the sweep. This value can be set to any integer value between 2 and 4001.</p>
	<p>Run/Hold Run Hold: Toggles between Run and Hold. When in Hold mode, pressing this key provides a trigger to initiate a sweep. When in the Run mode, pressing this key pauses the sweep.</p>
	<p>Sweep Trigger: This displays the “Sweep Trigger Menu” on page 6-36. The mode is displayed on the submenu key. Continuous is the default.</p>
	<p>RF Immunity High Low: The instrument defaults to RF Immunity Low.</p>
	<p>IFBW: Press this submenu key to display the IFBW selection box. Highlight one of the 13 choices. Refer to “IFBW” on page 6-37.</p>
	<p>Sweep Averaging: Press this submenu key to set the number of sweeps to average at each sweep point (1 to 1000). Use the number keypad, the Up/Down Arrow keys, or the rotary knob, then press Enter.</p>
 Power Setup	
 Port 1 Config	
 Port 2 Config	

Figure 6-27. Sweep Menu – Sweep Setup

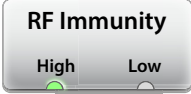
6-15 Sweep Trigger Menu

Key Sequence: **Sweep (3)** > Sweep Setup > Sweep Trigger





 Sweep Trigger	<i>Sweep Trigger</i>
 Continuous	<p>Continuous: Sets the sweep trigger to internal and continuous, and sets the Run/Hold setting to Run. A new sweep is triggered automatically at the end of each sweep. This is the default sweep trigger setting.</p>
 Single	<p>Single: Sets the sweep trigger to internal and single, and sets the Run/Hold setting to Hold. Each sweep is activated by the Run/Hold submenu key.</p>
 Ext. Trigger	<p>Ext. Trigger: Sets the sweep trigger to an external source. Each sweep is activated by a TTL signal at the External Trigger In connector. Refer to “Test Panel Connector Overview” on page 2-3.</p>

Figure 6-28. Sweep Trigger Menu

IFBW

The following choices are available for the intermediate frequency bandwidth setting:

- 100 kHz the maximum sweep speed
- 50 kHz
- 20 kHz
- 10 kHz
- 5 kHz
- 2 kHz
- 1 kHz default
- 500 Hz
- 200 Hz
- 100 Hz
- 50 Hz
- 20 Hz
- 10 Hz the maximum dynamic range

RF Immunity

The instrument defaults to RF Immunity Low. When set to High, RF Immunity protects the instrument from stray signals generated by nearby or co-located transmitters that can affect frequency and distance domain DTF measurements. The algorithm that is used to improve instrument ability to reject unwanted signals may slow down the sweep speed if interferers are detected. If the instrument is used in an environment where immunity is not an issue, then the RF Immunity key can be set to Low to optimize sweep speed. Use this feature with caution, because the introduction of an interfering signal might be mistaken for a problem with the antenna or cable run. If Immunity is set to Low during a normal measurement, then the instrument will be more susceptible to interfering signals. Interfering signals can make the measurement look better or worse than it really is.

6-16 Sweep Menu 2

Power Setup

Key Sequence: **Sweep (3)** > Power Setup

 <p> <input type="radio"/> Sweep Setup <hr/> <input checked="" type="radio"/> Power Setup <hr/> <div style="border: 1px solid gray; padding: 5px; margin-bottom: 5px;"> Source Power High Low <input checked="" type="radio"/> <input type="radio"/> </div> <div style="border: 1px solid gray; padding: 5px; margin-bottom: 5px;"> RF Pwr In Hold On Off <input checked="" type="radio"/> <input type="radio"/> </div> <hr/> <input type="radio"/> Port 1 Config <hr/> <input type="radio"/> Port 2 Config </p>	<p><i>Power Setup</i></p> <p>Source Power High Low: This toggles the source power between High and Low. Refer to “Calibration Data and Indications” on page 7-2.</p> <p>RF Pwr In Hold On Off: Sets the RF Output power to be left On or to be turned Off when Run/Hold is toggled to Hold. Refer to “RF Pwr In Hold” for details.</p>
---	--

Figure 6-29. Sweep Menu – Power Setup

RF Pwr In Hold

This setting determines if the RF output power at the RF Out/Reflect In port stays On or is turned Off when the instrument Run/Hold setting is toggled to Hold. To turn off RF power at the port when the instrument is placed in Hold mode and is not sweeping, set RF Pwr In Hold to Off. Power at the port is resumed when the Run/Hold setting is toggled back to Run. This is useful when you may not want a signal radiating out of the port at all times.

6-17 Sweep Menu 3

Port 1 Config and Port 2 Config

Port 2 configuration is identical except for the port number.

Key Sequence: **Sweep (3)** > Port 1 Config

<p>➤ Sweep Setup</p> <hr/>	<p><i>Port 1 Config or Port 2 Config</i></p>
<p>➤ Power Setup</p> <hr/>	
<p>▼ Port 1 Config</p>	
<p>Ref Plane Ext. Auto</p>	<p>Ref Plane Ext. Auto: Press this submenu key to automatically determine the best distance or time to mathematically extend the reference plane (Plane of Calibration) in order to remove an appropriate amount of linear phase rotation from the measurement data. Refer to “Reference Plane Extension Auto” on page 6-40.</p>
<p>Ref Plane Ext. Manual</p>	<p>Ref Plane Ext. Manual: Press this submenu key to manually enter a distance or time to which the Reference Plane (Plane of Calibration) is extended. Refer to “Reference Plane Extension Manual” on page 6-41.</p>
<p>Ref Plane Distance Time</p>	<p>Ref Plane Distance Time: Press this submenu key to toggle the units setting between Distance and Time for the Reference Plane Extension. This setting affects both the Auto and Manual units setting of the Reference Plane Extension.</p>
<p>Ref Plane Loss</p>	<p>Ref Plane Loss: Press this submenu key to set the reference plane loss in dB. The entered loss value for each port is displayed in the Instrument Settings Summary above the graph area.</p>
<p>Prop Velocity</p>	<p>Prop Velocity: This value is used by the Reference Plane Extension functions (distance units). Press this submenu key to enter the propagation velocity of electrical signals in the length of cable that is being removed by the Reference Plane Extension calculations. Values are expressed as a decimal ratio compared to the speed of light in a vacuum.</p>
<p>➤ Port 2 Config</p>	<p>Examples: 1 = speed of light, and 0.5 = 1/2 the speed of light.</p>

Figure 6-30. Sweep Menu – Port 1 Config or Port 2 Config

Reference Plane Extension Auto

This submenu key is used to automatically determine the best distance or time to mathematically extend the reference plane (Plane of Calibration) in order to remove an appropriate amount of linear phase rotation from the measurement data. The resultant display will unwrap phase (refer to “[Phase versus Unwrapped Phase Graph Types](#)” on page 6-8) to allow a better view of the phase properties of the Device Under Test. This function can be applied to a reflection measurement (S_{11} for port 1 or S_{22} for port 2) or to a transmission measurement (S_{21} for port 1 or S_{12} for port 2), depending on the user setup. To determine the appropriate phase rotation, and depending on your display settings, you may be presented with a message box (see [Figure 6-31](#)) asking you to specify to which S-parameter the reference plane extension should be applied. The calculated distance value or time value for each port is displayed in the Instrument Settings Summary above the graph area.

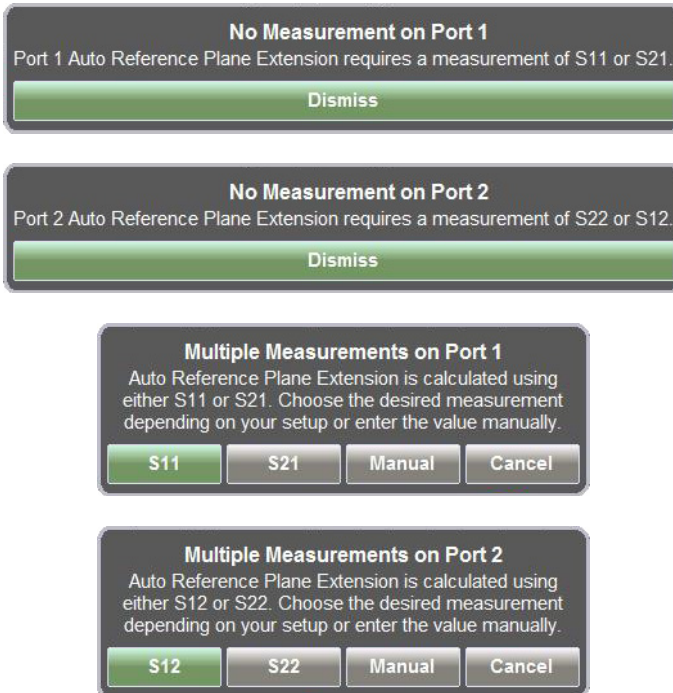

Figure 6-31. Message Boxes for Reference Plane Extension

Reference Plane Extension Manual

This submenu key is used to manually enter a distance or time to which the Reference Plane (Plane of Calibration) is extended. This action calculates and removes an appropriate amount of linear phase rotation (from the measurement data) based on the time or distance entered by using this submenu key. The entered distance or time value for each port is displayed in the Instrument Settings Summary above the graph area. When you enter a time or distance value, a Units menu is provided (as shown in [Figure 6-32](#)).

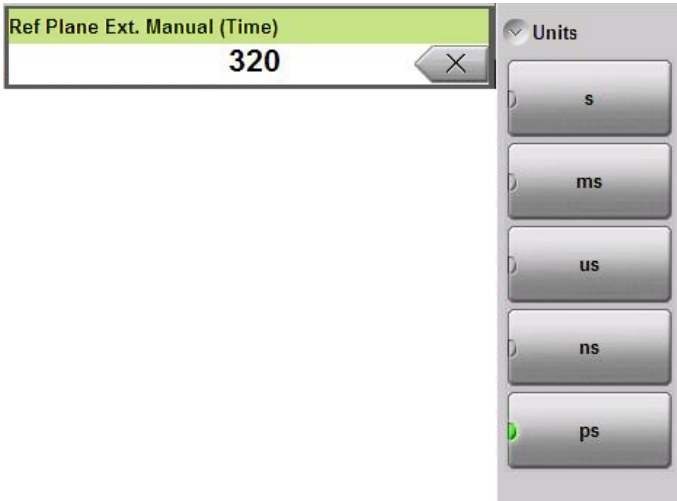

Figure 6-32. Manual Reference Plane Extension Entry with Time Units

6-18 Trace Menu

Key Sequence: **Trace (5)**

and

Key Sequence: **Trace (5) > Trace Display**

<p> <input checked="" type="checkbox"/> Trace <input type="checkbox"/> Trace Display </p> <p> <input type="checkbox"/> Copy Trace To Memory <input type="checkbox"/> Trace Display Trace Only <input type="checkbox"/> Data Math None </p> <hr/> <p> <input checked="" type="checkbox"/> Trace Display <input type="checkbox"/> Trace Only <input type="checkbox"/> Memory Only <input type="checkbox"/> Trace & Memory </p>	<p><i>Trace</i></p> <p>Copy Trace to Display Memory: Copies the current trace display to memory for use in Trace Math and Trace Display options.</p> <p>Trace Display: Press to change the display options.</p> <p>Data Math: Press to change the trace math options. Refer to “Trace Menu (continued)” on page 6-43.</p> <p><i>Trace Display</i></p> <p>Trace Only: The active trace is displayed (yellow).</p> <p>Memory Only: The trace that is stored in memory is displayed (purple).</p> <p>Trace & Memory: If a trace is stored in memory, then the stored trace (purple) and the current active trace (yellow) are both displayed.</p>
---	--

Figure 6-33. Trace Menu (1 of 2)

Trace Menu (continued)

Key Sequence: **Trace (5)** > Data Math

<p>Trace</p> <p>Copy Trace To Memory</p> <p>Trace Display Trace Only</p> <p>Data Math None</p> <hr/> <p>Data Math</p> <p>None</p> <p>Trace - Mem</p> <p>Trace + Mem</p> <p>Trace * Mem</p> <p>Trace / Mem</p>	<p><i>Trace > Data Math</i></p> <p>Data Math: Press to change the trace math options. Note that all data math operations are applied to the complex S-parameter data of the trace or memory.</p> <p>None: Press this submenu key to display the active trace as it is, with no math functions.</p> <p>Trace – Mem: Press this submenu key to display the difference between the active trace and the trace in memory by subtracting the trace in memory from the current trace.</p> <p>Trace + Mem: Press this submenu key to display the results of logarithmic adding of the active trace and the trace in memory.</p> <p>Trace * Mem: Press this submenu key to set the trace math function to multiply the current trace by the trace that is in memory.</p> <p>Trace / Mem: Press this submenu key to set the trace math function to divide the current trace by the trace that is in memory.</p>
---	---

Figure 6-34. Trace Menu (2 of 2)

6-19 Other Menu Keys

Refer to [Table 2-1, “Site Master Keypad Functions”](#) on page 2-9.

Chapter 7 — Calibration, VNA

7-1 Introduction

This chapter provides details and procedures for calibrating the Vector Network Analyzer modes of the Site Master S820E.

Note	For accurate results, the instrument must be calibrated before making any measurements.
-------------	---

The Site Master is a high-precision instrument. When making 1-port or 2-port measurements, the instrument must be calibrated in order to remove residual errors due to measurement setup conditions. Anritsu recommends performing the calibration under the same conditions as the measurement: temperature, frequency, number of points, source power, and IFBW. The calibration must be conducted using the appropriate standards at the open end of any test port cables and adapters that are connected to Port 1 or Port 2 of the instrument. This will ensure that the match, phase length, and loss of these cables and adapters are all accounted for. For optimal performance, high quality phase-stable cables and precision adapters must be used.

Note	Screen images in this User Guide are illustrations of typical instrument features. Some images may include instruments other than the Site Master S820E. Traces and other display features may differ from the screen displays of your instrument.
-------------	--

7-2 Calibration Considerations

Various 2-port calibrations are available in the S820E in VNA Mode. Transmission response is the simplest and requires only one connection during calibration, but it does not correct for test port match errors. 1-Path 2-Port calibration requires four calibration connections and corrects for the transmit port match, but does not correct for the receive port. Full 2-port calibration requires seven calibration connections and corrects for both test port match errors. The full 2-port calibration technique offers the most accuracy. [Figure 7-5 on page 7-8](#) shows how calibration connections are displayed by the S820E.

Note

The previously described calibration considerations omit isolation steps in which loads are connected to each test port. During the isolation step of the calibration procedure, the S820E (in VNA Mode) measures the isolation between test ports in order to achieve best dynamic range performance.

For accurate results, the S820E must be calibrated at the ambient temperature after allowing for warm up time (approximately 15 minutes) and before making any measurements. The instrument must be recalibrated whenever the setup frequency changes, whenever the ambient temperature changes by an amount that has more than likely rendered the calibration invalid, or whenever a test port extension cable is added, removed, or replaced. For an example of measurement improvement after calibration, refer to [“Example of Calibration Benefits” on page 7-4](#).

The calibration menu has a Thru Update submenu key (see [Figure 7-12 on page 7-18](#)) that allows you to recalibrate the Thru component without repeating the entire calibration sequence. Refer to [“Thru Update” on page 4-15](#).

Calibration data are saved when you save a Setup file. When you recall a setup, the calibration remains valid if instrument conditions (such as temperature) remain within the calibration tolerance.

Calibration Data and Indications

When you perform a calibration, the correction coefficients are calculated for specific S-parameters (depending on the type of calibration chosen) and for instrument settings (frequency range, number of points, and power level). The term “calibration correction” refers to the measurement correction coefficients that are applied to measurements as a result of your calibration.

When calibration correction is **On**, the correction is applied to all applicable S-parameters. For example, if a Full S_{11} (1-port) calibration is performed, then only traces that measure S_{11} have a valid calibration. For those traces, the calibration information data in the Instrument Settings Summary shows **"CAL: OK"**. All other traces that do not measure S_{11} display **"CAL: --"** to indicate that no valid calibration is available for those traces. The calibration correction can also be turned off manually under the Calibration menu by toggling the Cal Correction soft key from **On** to **Off**. In that case, the display shows **"CAL: OFF"** for all traces that have valid correction data available.

Note that **"CAL: OFF"** means that a calibration correction has been created, but it is not currently being used. This is different from **"CAL: --"**, which means that no valid calibration correction is available for the current setting.

When you have **Cal Correction** on and **Interpolation** set to off, you cannot modify the frequency range or the source power level, or increase the number of points. You can, however, decrease the number of points without forcing the calibration to become invalid.

If you reduce only the number of points, then the frequency range is not changed. The S820E finds a subset of the original points in the sweep that can be used. You can therefore notice that the instrument may not use the exact number of points that you have entered. It picks a specific number of points that allow the calibration correction to continue to be valid. If you use the rotary knob, then you will more easily find the available number of points that can be set. For example, if you calibrated with 201 points, then you can observe that you can reduce the number of points to 101, 68, 51, 41, and so forth.

If **Interpolation** is set to on, then you can reduce the frequency range and modify the number of points without invalidating the calibration. In that case, the calibration coefficients are regenerated (interpolated) to match the new settings.

Another status information display that you may see is **"CAL: ON (X)"**, which indicates that the instrument temperature has deviated (since the time the calibration was conducted) by an amount that has more than likely rendered the calibration invalid. When this occurs, a new calibration is highly recommended before further measurements are conducted.

Only one calibration is available at one time. Performing a new calibration overwrites any existing calibration. You can, however, store a measurement setup, which also stores the calibration. You can therefore have multiple calibrations available (as long as the calibration settings and conditions continue to apply).

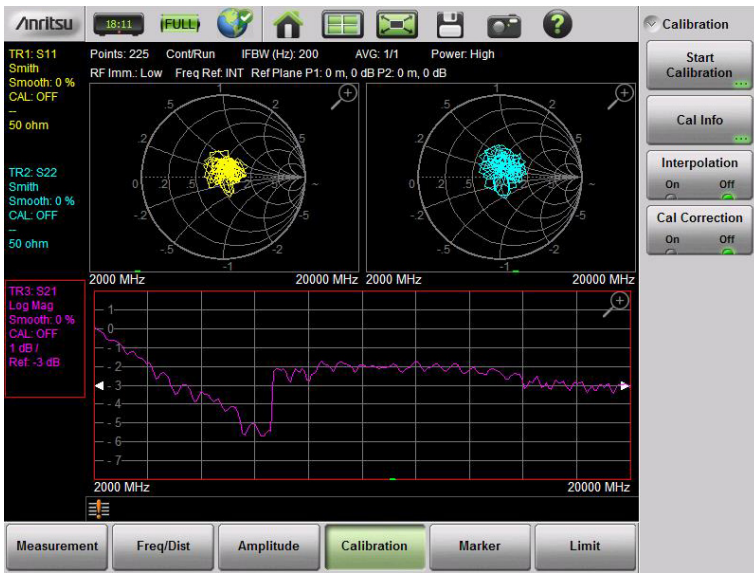

Figure 7-1. S_{11} , S_{22} , and S_{21} Measurements before Calibration

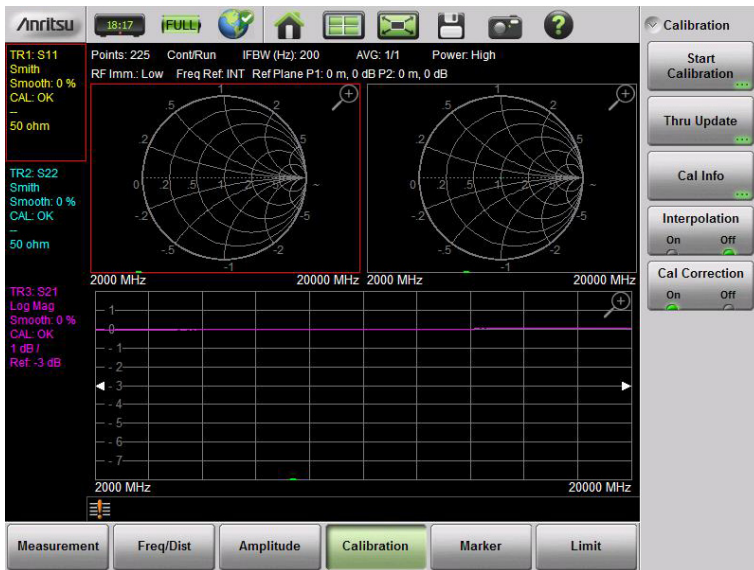
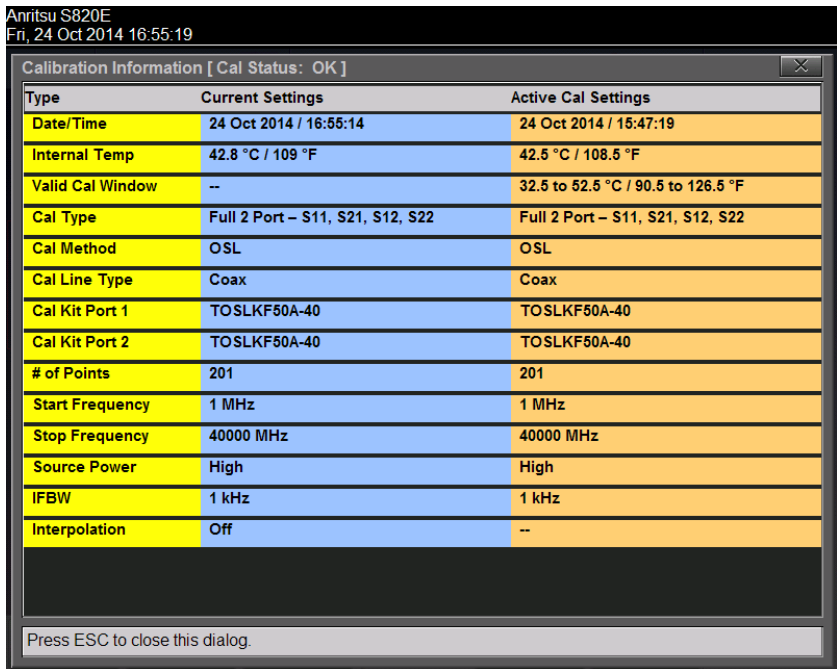

Figure 7-2. S_{11} , S_{22} , and S_{21} Measurements after Calibration

7-3 Calibration Setup

In order to perform a proper calibration, several parameters must be set before the calibration procedure is started. These parameters are: Cal Type, Cal Line, Cal Method, Port DUT, Port Cal Kit, and Thru Device.

To view a summary of these settings, begin from the Calibration main menu and press **Cal Info**. A summary of the Active Cal Settings and the Current Settings of the instrument are displayed (see [Figure 7-3](#)). Press **Esc** to close the Cal Info window.



Type	Current Settings	Active Cal Settings
Date/Time	24 Oct 2014 / 16:55:14	24 Oct 2014 / 15:47:19
Internal Temp	42.8 °C / 109 °F	42.5 °C / 108.5 °F
Valid Cal Window	--	32.5 to 52.5 °C / 90.5 to 126.5 °F
Cal Type	Full 2 Port – S11, S21, S12, S22	Full 2 Port – S11, S21, S12, S22
Cal Method	OSL	OSL
Cal Line Type	Coax	Coax
Cal Kit Port 1	TOSLKF50A-40	TOSLKF50A-40
Cal Kit Port 2	TOSLKF50A-40	TOSLKF50A-40
# of Points	201	201
Start Frequency	1 MHz	1 MHz
Stop Frequency	40000 MHz	40000 MHz
Source Power	High	High
IFBW	1 kHz	1 kHz
Interpolation	Off	--

Press ESC to close this dialog.

Figure 7-3. Cal Info Window

The Cal Info window displays all of the key setup parameters for the calibration. The current settings are shown on the left, and the settings of the instrument at the time of the last calibration are shown on the right.

Cal Type

Press the Cal Setup submenu button to choose a setup. In the Cal Setup menu, press the Edit Selection submenu button to choose a Cal Type.

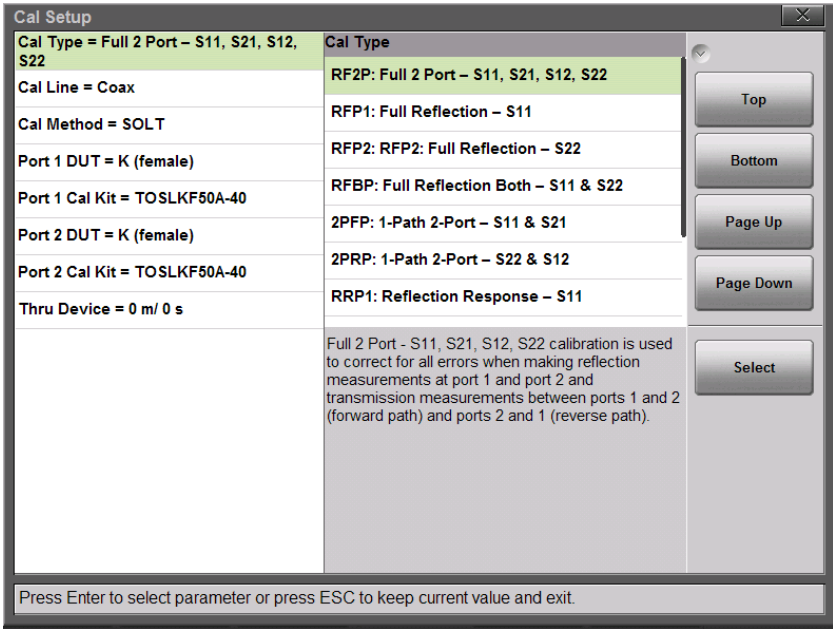

Figure 7-4. Cal Setup and Cal Type Dialog Box

Notice the Cal Type description below the Cal Type selection list.

Cal Line and Cal Method

The Site Master S820E supports measurements and calibrations for both coaxial and waveguide media. In the Cal Setup window, set the Cal Line to either **Coax** or **Waveguide** before starting the calibration.

Figure 7-5 shows the selection window for the Cal Line, within the Cal Setup dialog box. For coaxial line types, the calibration method that is most commonly used is the Open, Short, Load, Thru method, or SOLT. For waveguide line types, the calibration method that is most commonly used is the Offset Short 1 ($1/8^{\text{th}}$ wavelength), Offset Short 2 ($3/8^{\text{th}}$ wavelength), Load, Thru method, or SSLT. Use the Cal Method selection to set the appropriate method for the type of media being used during the calibration and measurements.

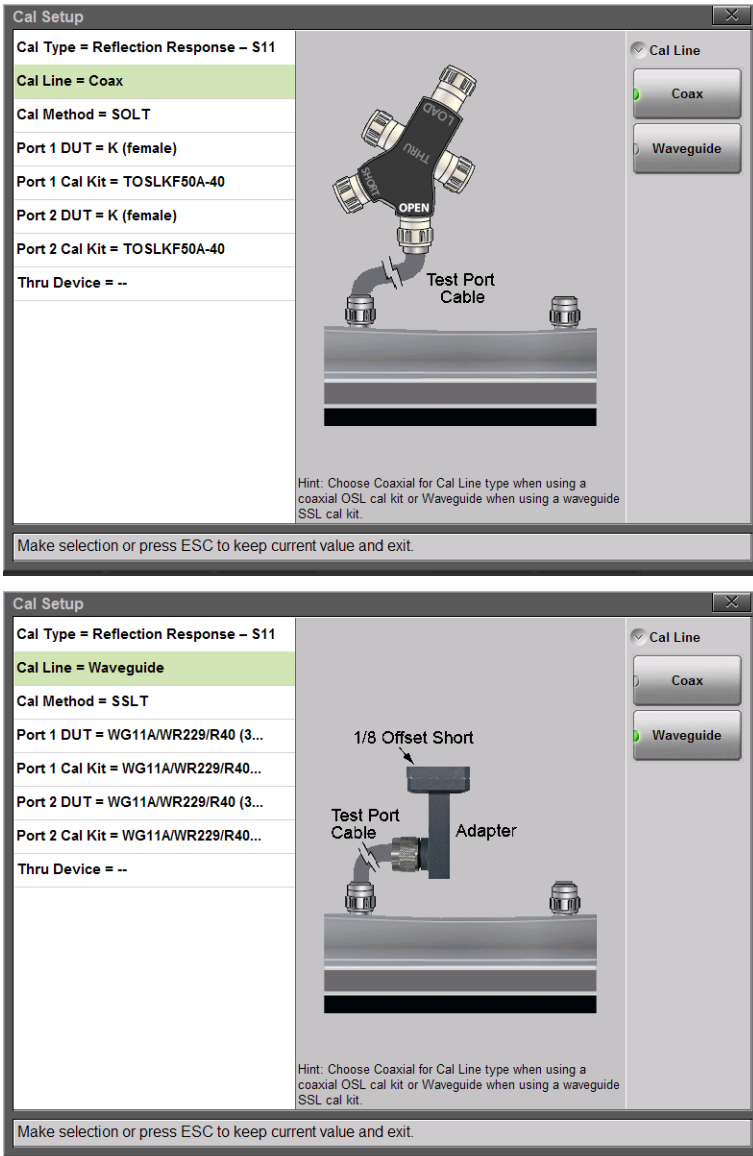

Figure 7-5. Cal Line Setup

Port 1 or Port 2 DUT and Cal Kit

For the most accurate calibrations, you must select the connector of the DUT that will be attached to Port 1 or Port 2 of the instrument. After you select the DUT connector, you must then select the desired calibration kit that will be used for the Port 1 or 2 correction. If you do not select a desired calibration kit, then the analyzer defaults to one of the built-in kits.

Figure 7-6 shows the selection window for the Port 1 DUT connector. For easier identification of the DUT connector, a representative picture is shown for each selection. After a connector is chosen, the Port 1 Cal Kit selection is updated in order to list only the available calibration kits that are associated with the selected DUT connector. Figure 7-7 on page 7-10 shows an example of the selection of calibration kits that are available for the K (female) coaxial DUT connector.

For each coaxial kit in the list, the values of the Offset Lengths for the Open, Short, and Thru (if applicable) are listed. The Capacitance and Inductance values for the Open and Short are also listed, as shown in Figure 7-7. For waveguide calibration kits, the Cutoff Frequency and the Offset Short 1 and Short 2 lengths are listed.

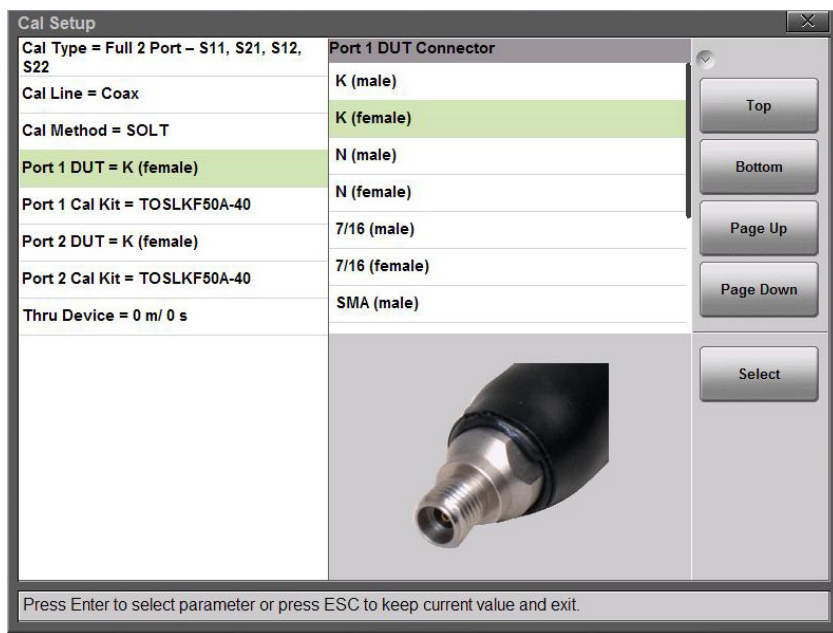

Figure 7-6. Selection Window for Port 1 DUT Connector

Figure 7-7 shows the Selection window for the Port 1 Cal Kit with its list of available calibration kits and the corresponding parameters for each kit.

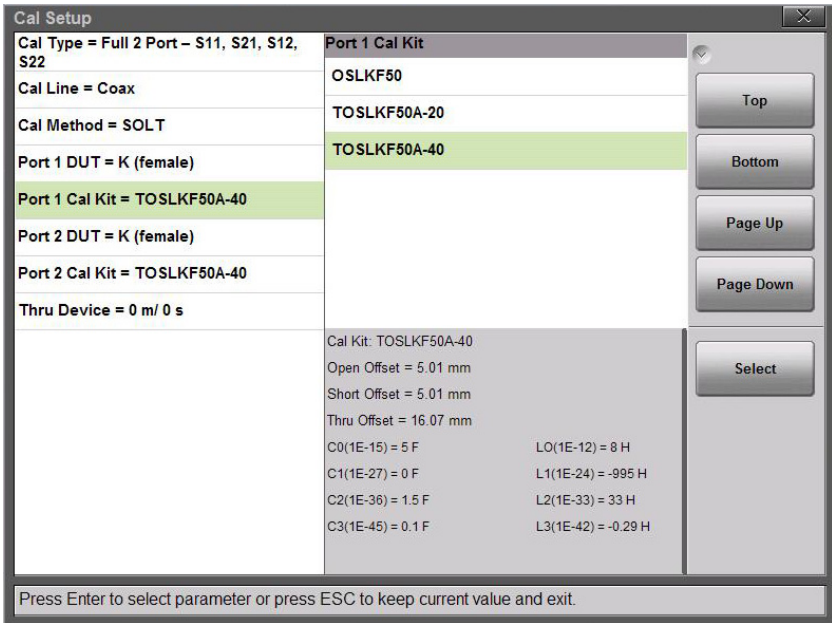

Figure 7-7. Selection Window for Port 1 Cal Kit

The selection list for DUT connectors includes all of the common connectors that you may encounter. [Table 7-1, “Coax DUT Connectors and Cal Kits” on page 7-11](#) and [Table 7-2, “Waveguide DUT Connectors” on page 7-12](#) provide complete lists of Coax and Waveguide connectors and corresponding calibration kits that are selectable through the Cal Setup dialog box.

Table 7-1. Coax DUT Connectors and Cal Kits

Coaxial Connector Name	Available Cal Kits
N-Type (male)	OSLN50, OSLN50-1, OSLN50A-8, OSLN50A-18, TOSLN50A-8, TOSLN50A-18
N-Type (female)	OSLNF50, OSLNF50-1, OSLNF50A-8, OSLNF50A-18, TOSLNF50A-8, TOSLNF50A-18
K (male)	OSLK50, TOSLK50A-20, TOSLK50A-40
K (female)	OSLKF50, TOSLKF50A-20, TOSLKF50A-40
7/16 (male)	2000-1618-R, 2000-767
7/16 (female)	2000-1619-R, 2000-768
SMA (male)	3650 (male components of kit)
SMA (female)	3650 (female components of kit)
TNC (male)	1091-53, Open
TNC (male)	1091-54, Short
TNC (male)	1015-55, Termination
TNC (female)	1091-55, Open
TNC (female)	1091-56, Short
TNC (female)	1015-54, Termination
User 1: Coax	User 1 (Coax)
User 2: Coax	User 2 (Coax)
User 3: Coax	User 3 (Coax)
User 4: Coax	User 4 (Coax)
User 5: Coax	User 5 (Coax)
User 6: Coax	User 6 (Coax)
User 7: Coax	User 7 (Coax)
User 8: Coax	User 8 (Coax)
User 9: Coax	User 9 (Coax)
User 10: Coax	User 10 (Coax)

Table 7-2. Waveguide DUT Connectors

Waveguide Connector Name
WG11A/R40 (3.30 to 4.90 GHz)
WG12/WR187/R48 (3.95 to 5.85 GHz)
WG13 (4.90 to 7.00 GHz)
WG14/WR137/R70 (5.85 to 8.20 GHz)
WG15/WR112/R84 (7.05 to 10.0 GHz)
WG16/WR90/R100 (8.20 to 12.4 GHz)
WG17/R120 (10.0 to 15.0 GHz)
WG18/WR62/R140 (12.4 to 18.0 GHz)
WG20/WR42/R220 (18.0 to 26.5 GHz)
WG22/WR28/R320 (26.5 to 40.0 GHz)
User 1: WG
User 2: WG
User 3: WG
User 4: WG
User 5: WG
User 6: WG
User 7: WG
User 8: WG
User 9: WG
User 10: WG

If you are using custom connectors that are not already listed, then the Site Master S820E allows you to create up to ten User DUT connectors and corresponding User Cal Kits. Choose one of the User connectors from the Port 1 DUT Connector list, as shown in [Figure 7-8 on page 7-13](#). You can edit the name of the DUT connector, as indicated on the Site Master screen.

For each User DUT connector, a corresponding User Cal Kit is selected, as shown in [Figure 7-9 on page 7-14](#). The coefficients for the calibration kit can be edited, as indicated on the Site Master screen. Customizing the connectors and calibration kit coefficients allows you to have the most flexibility in using any calibration kit that may be required for your measurements.

The user-entered coefficients are retained in the instrument's non-volatile memory and will persist even after the Site Master is powered down or after a Factory Reset. Recalling a setup file will not overwrite the user coefficients.

Caution	<p>To ensure utmost measurement accuracy and consistency, please use the Anritsu calibration kits that are listed in the Calibration menu. These can be found in the accessories section of the S820E technical data sheet. Other Calibration kits that are not listed in the Calibration menu may be used provided you enter the correct required calibration coefficient information under one of the available custom User settings.</p>
----------------	---

Figure 7-8 illustrates the Selection window for the Port 1 DUT connectors, showing the list of custom User connectors available to the user. The name of the connectors can be edited as indicated on the screen.

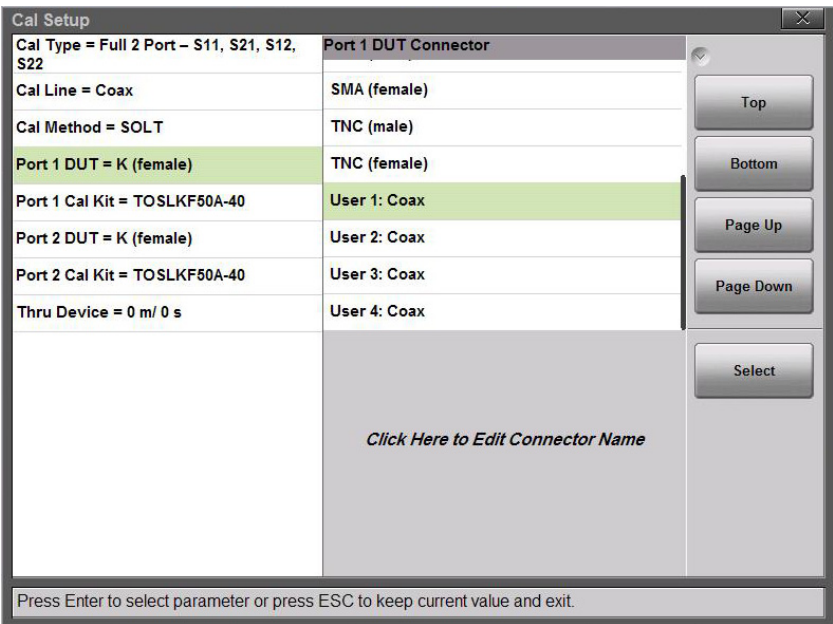

Figure 7-8. Cal Setup, Port 1 DUT Connectors

Figure 7-9 shows the selection window for the custom User cal kits corresponding to the User 6 DUT coaxial connector. The corresponding cal kit parameters are shown and can be edited as indicated on the screen.

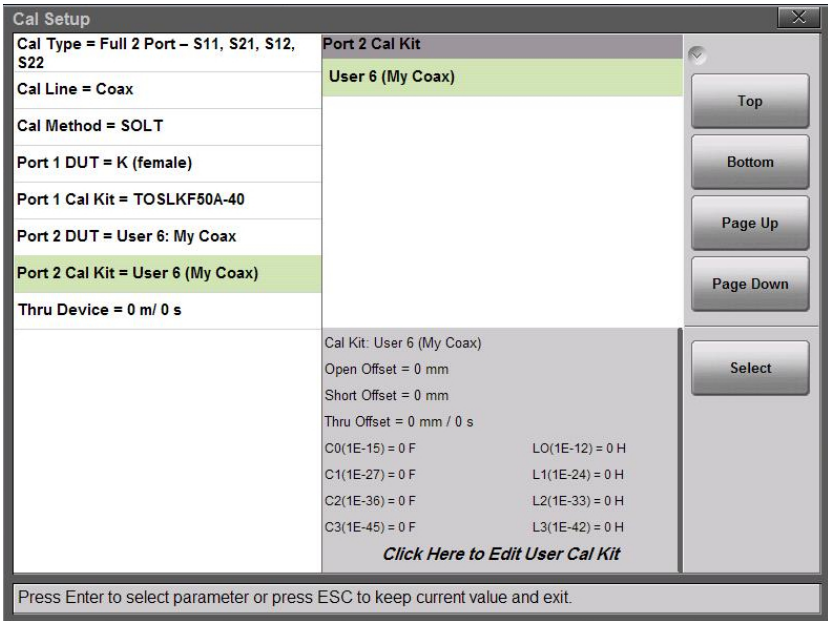

Figure 7-9. Cal Setup, Port 1 DUT Coax Connector

Thru Device

After you have set up Port 1 and Port 2 DUT and cal kits, you must also set the Thru Device that is used in the Thru step of the calibration that is being conducted, if applicable. The Thru device accounts for any extra length that is used during the calibration steps (such as an adapter) but is removed for the actual measurement of the DUT. In these cases, if the Thru device length is not accounted for, then the resulting measurements will have an offset error.

The Thru device length can be set in units of distance or time, or it can be set to equal the Thru length offset of the cal kits that are used for Port 1 or Port 2, if applicable. [Figure 7-10](#) shows the selection window for the Thru device setting.

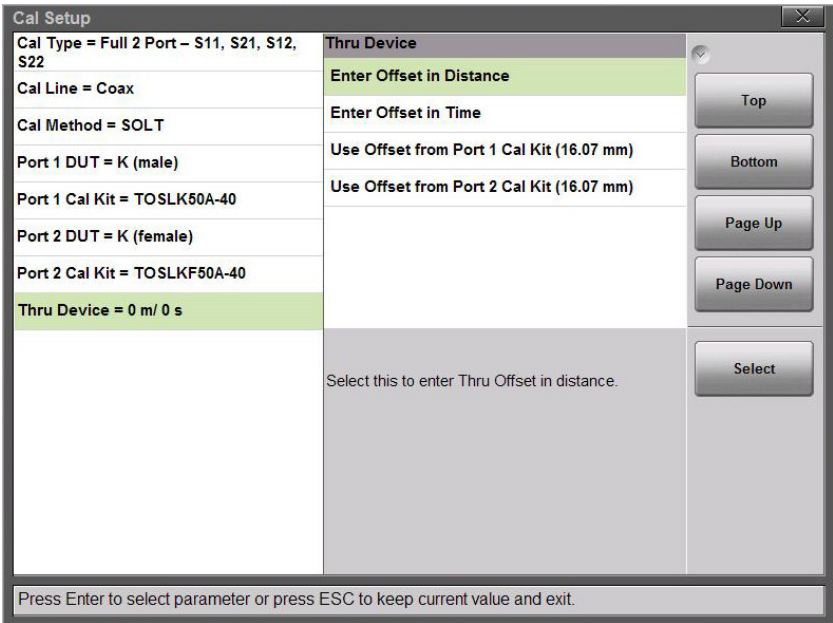

Figure 7-10. Thru Device Setting

7-4 Calibration Procedures

In Vector Network Analyzer Mode, calibration is required when the test port cable or adapters have been changed or when no valid calibration is available (**Cal Status --**). The following sections describe how to perform calibrations.

Note	If a Test Port Extension Cable is to be used (this is recommended), then it must be connected to the Site Master before calibration.
-------------	--

Calibration Procedure

1. Press the **Freq/Dist** main menu key and enter the appropriate frequency range.
2. In the Sweep menu, set the source power level.
3. Press the **Calibration** main menu key, then press Start Calibration.
4. Press **Cal Setup** to make changes to the setup as needed (refer to [Section 7-3 “Calibration Setup” on page 7-5](#)).
5. Press **Measure** and follow the on screen instructions (see [Figure 7-11 on page 7-17](#)).
6. Verify that the calibration has been completed by confirming that the **Cal Status** message is now displaying “**Cal: OK**”. The calibration correction factor will then be applied to the measurements.
7. The calibration factors can be turned Off with the **Cal Correction** button. The calibration coefficients are saved and can be reapplied by setting **Cal Correction** back to On.

Figure 7-11 shows the Calibration dialog box illustrating calibration setup and calibration steps. On-screen instructions are given for each step.

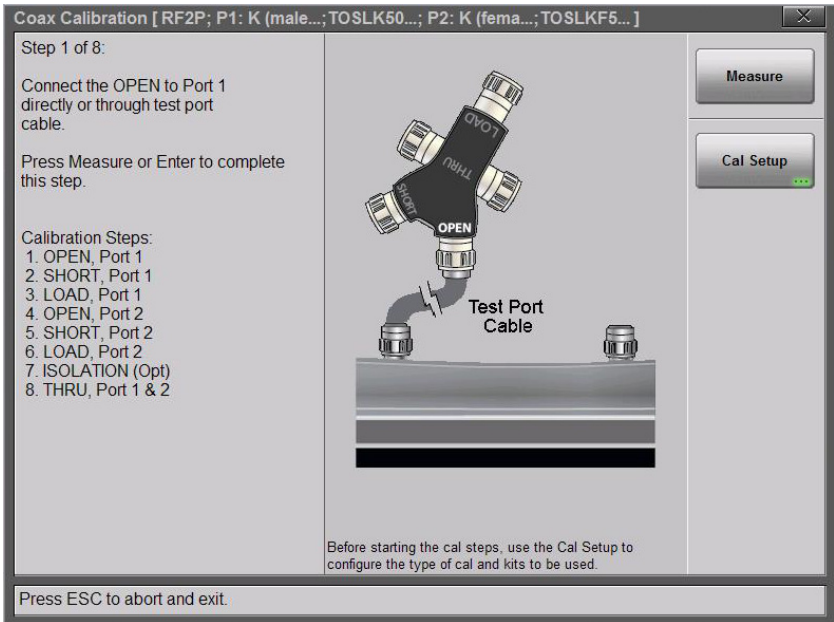

Figure 7-11. Calibration Dialog Box for Coax

Save and Recall Calibration Coefficients

Calibration information is included when a setup (.stp) file is saved (even if the Cal Correction is Off). The calibration information is recalled with a setup file and can be applied if the current internal instrument temperature is within the saved calibration window.

Calibration information is not included when a measurement (.svna) file is saved.

7-5 Calibration Menu

Key Sequence: **Calibration**





<i>Calibration</i>	
 <p>Calibration</p>	<p>Start Calibration: Opens the Calibration dialog box (Figure 7-13 on page 7-20). Two menu buttons are displayed in the Calibration dialog box.</p>
 <p>Start Calibration</p>	
 <p>Thru Update</p>	<p>Thru Update: Opens the Calibration dialog box to allow calibrating the Thru component without repeating the entire calibration sequence. This key is displayed only after a calibration with a Thru component.</p>
 <p>Cal Info</p>	<p>Cal Info: Displays the Calibration Information table showing the current and active calibration settings. See Figure 7-3 on page 7-5.</p>
 <p>Interpolation</p> <p>On Off</p>	<p>Interpolation (On Off): Press this submenu key to toggle Interpolation On or Off. After performing a Standard calibration, you can turn Interpolation On and then change the frequency range (smaller) or change the number of data points. For more details, refer to "Interpolation" on page 7-19.</p>
 <p>Cal Correction</p> <p>On Off</p>	<p>Cal Correction (On Off): Press this submenu key to toggle Cal Correction On or Off. Turn Cal Correction On to apply the correction factor to the current measurement. For more details, refer to "Cal Correction" on page 7-19.</p>

Figure 7-12. Calibration Menu

Interpolation

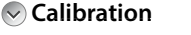
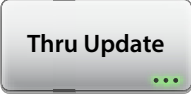
You can set your instrument to interpolate the calibration coefficients of a Standard mode calibration. After performing a Standard calibration, you can turn Interpolation On and then change the frequency range (smaller and anywhere within the calibrated range) or change the number of data points. You cannot increase the frequency range beyond the range that was used during calibration. The submenu key is **“Interpolation (On Off)”** on page 7-18.

For example, you could perform a calibration from 1 MHz to 40 GHz using 4001 points. With Interpolation On, you could then make a measurement by zooming in on a desired frequency range, 410 MHz to 435 MHz for example. The trace in your measurement would use of the full 4001 points within this much narrower frequency range. With Interpolation Off, the instrument would use only the number of points that were calibrated within this narrower frequency band, which would be a much smaller number of points.

Cal Correction

Cal Correction is turned on automatically after the calibration process has been completed successfully. When Cal Correction is On, the calibration coefficients are applied to the measured data, resulting in corrected S-parameter data. You can turn Cal Correction Off, which results in trace data using uncorrected (or raw) S-parameter data.

Calibration Dialog Box

Key Sequence: **Calibration** > Start Calibration

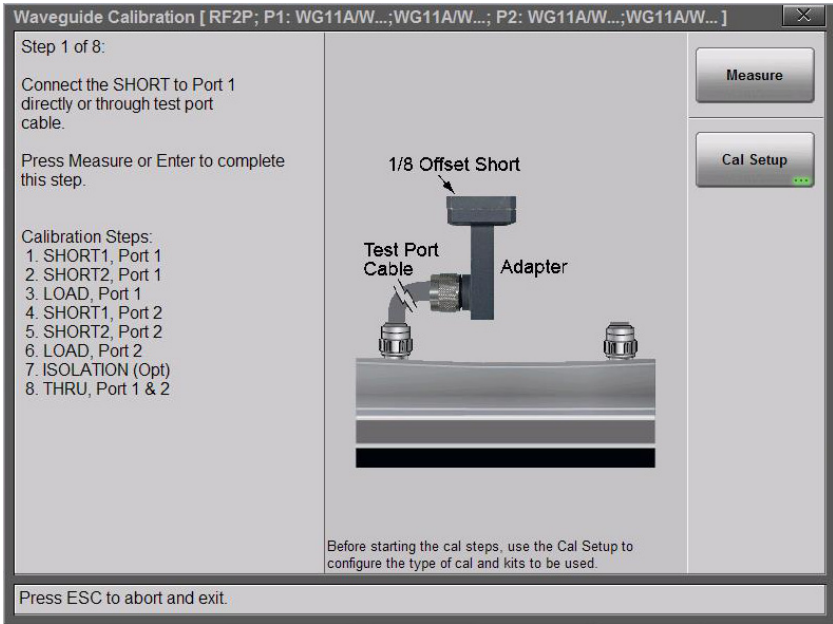

Figure 7-13. Calibration Dialog Box

Measure: Starts the calibrations process. Follow the on screen instructions.

Cal Setup: Press this submenu key to choose a calibration type.

Start Calibration Menu

Key Sequence: **Calibration** > Start Calibration

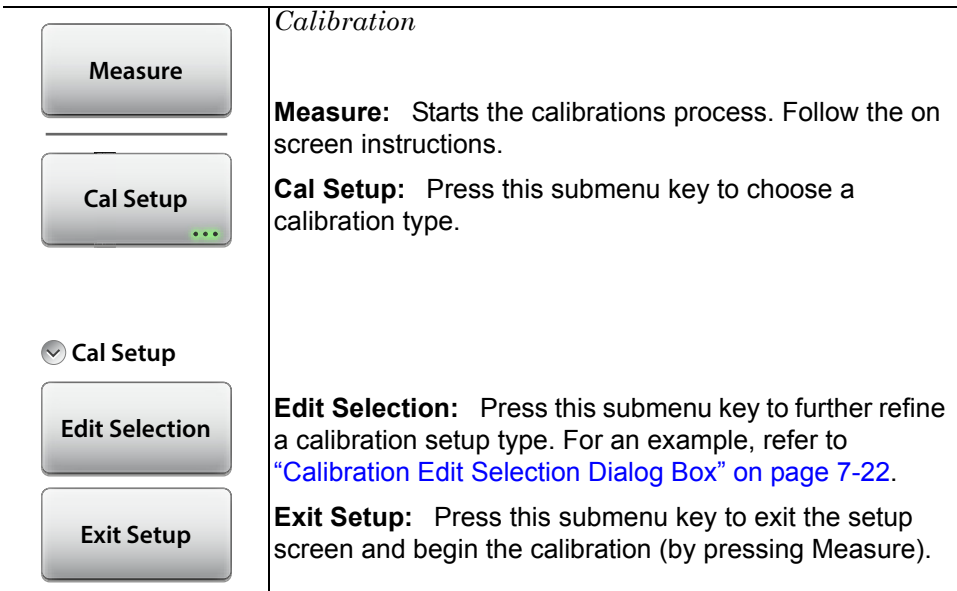

Figure 7-14. Start Calibration Menu

Calibration Edit Selection Dialog Box

Key Sequence: **Calibration** > Start Calibration > Cal Setup > Edit Selection

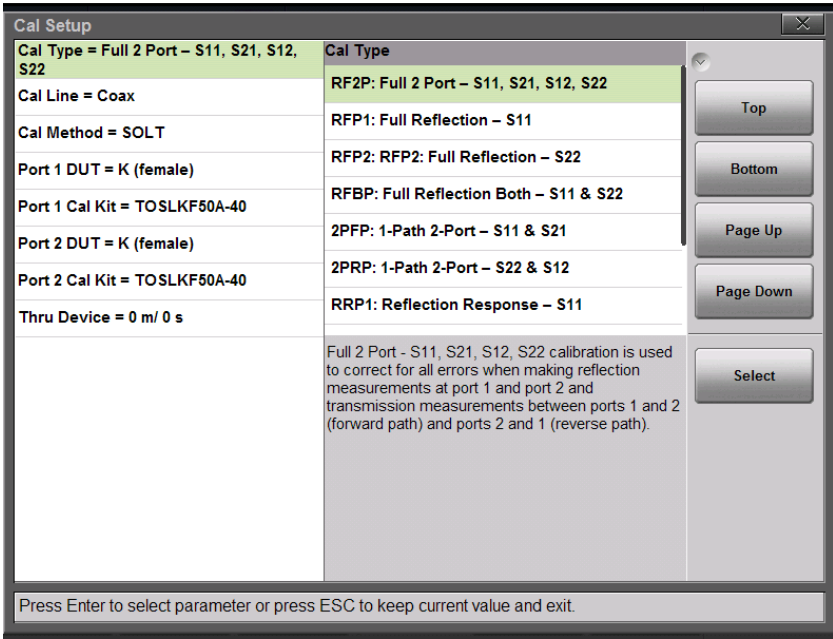

Figure 7-15. Calibration Edit Selection Dialog Box

Chapter 8 — Vector Voltmeter

8-1 Introduction

This chapter provides an overview of Vector Voltmeter or VVM Mode (Option 441). Vector Voltmeter Mode in the S820E provides a modern equivalent functionality to the classic analog Vector Voltmeter (VVM) instrument, which has been discontinued for many years. The classic analog VVM had 2 input channels (typically A and B), and both were capable of measuring voltage directly. The classic VVM, however, did not have any internal signal source or bridges or couplers needed to perform reflection or transmission measurements. Those items needed to be supplied externally.

With the proper addition and usage of those external items, the classic analog VVM could be configured to perform complex measurements (reflection or transmission) between the 2 inputs (A/B or B/A). Typically one of the input channels would be dedicated as the reference channel, and the remaining channel would be used to perform the desired measurements. The A/B and B/A ratio measurements were the predominant usage of the classic analog VVM.

The S820E VVM option provides equivalent A/B and B/A ratio capability, which means that it can be used as a drop-in replacement for a classic analog VVM. Since it already has a source and couplers built-in, it can also measure reflection or transmission of a DUT directly without needing any additional external items.

The S820E VVM option also offers additional capabilities that the classic VVM did not offer, such as the table display, which allows you to measure up to 12 devices. All 12 DUT measurements can be simultaneously compared to a single reference DUT response. This is especially useful in complex phase array antenna systems where cable lengths that are feeding multiple antennas need to have a precise phase relationship to each other.

The function hard keys in Vector Voltmeter mode are:

Measurement, Frequency, Amplitude, Calibration, Sweep, [BLANK]

The sixth key is not used in this mode.

8-2 How the VVM Function Works

Four basic vector voltmeter measurement types are available: Reflection, Transmission, A/B (Port 1/Port 2), and B/A (Port 2/Port 1).

With Option 441 in the S820E, you can measure relative magnitude and phase of a DUT either directly (using the built-in source and couplers) or as a ratio function (A/B or B/A) using appropriate external accessories such as a CW signal source and either a power splitter or a coupler. Direct measurements can be 1-port (reflection) or 2-port (transmission) and may also be vector error corrected, thereby providing absolute measured values versus relative measured values. Option 441 is a stand-alone option in the S820E and does not require the VNA Mode (Option 440) to provide full A/B and B/A ratio capability. All measurements made with Option 441 are based on CW signals. They are not swept frequency measurements.

Reflection measurement (1-port): This technique is most often used for cable trimming, but it can also be used to validate the proper electrical length of any low loss DUT. It is most often used with a reference measurement (golden DUT) which is stored into memory, then subsequent DUTs may be measured and compared against the stored reference. As an option, the measurement port may be vector error corrected (via the calibration process, refer to [Chapter 4](#)) to provide optimal results. This is the simplest and most convenient VVM measurement. Best results are obtained when the DUT loss is < 20 dB. For a very lossy DUT, use the Transmission Measurement type.

Figure 8-1 shows a block diagram comparison of the test configuration for the traditional Vector Voltmeter instrument method (left) and the equivalent measurement capability integrated within the Site Master in VVM mode (right) when the S820E is used for a reflection measurement.

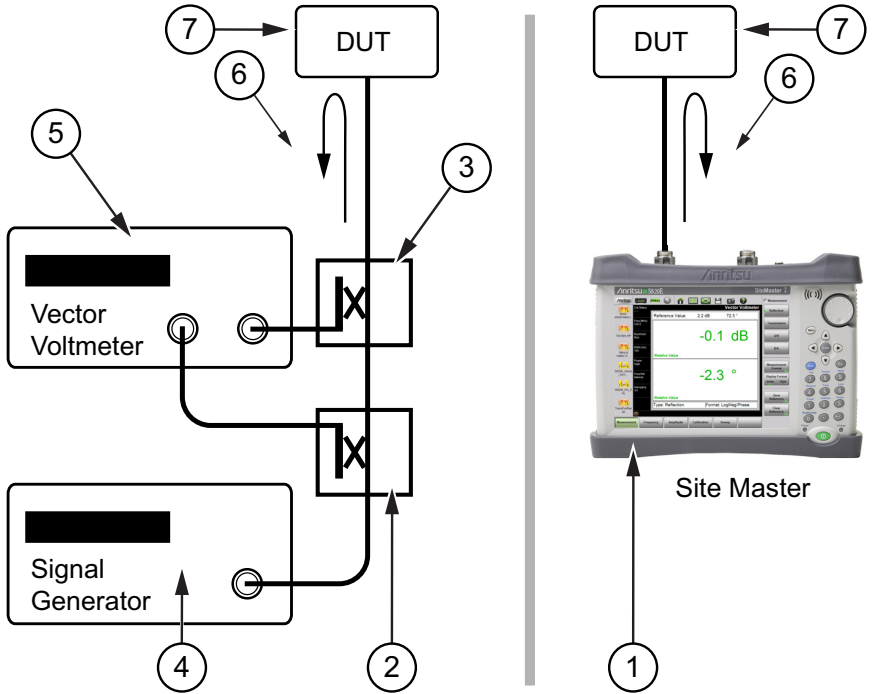

(Left) Vector Voltmeter and (Right) S820E Site Master Equivalent Measurement

1	S820E Site Master
2	Coupler or Splitter
3	Coupler or Bridge
4	Signal Generator
5	Vector Voltmeter
6	Reflection Measurement
7	DUT (Device Under Test)

Figure 8-1. Vector Voltmeter Reflection Measurement

Transmission measurement (2-port): This technique uses the VVM function in a straightforward manner with its 2-port setup. The transmission response of the DUT is measured from port 1 to port 2. The DUT amplitude and phase shift are measured by the highly sensitive port 2 receiver. The high dynamic range of this measurement is ideal when the DUT loss is high.

Figure 8-2 shows a block diagram comparison of the test configuration for the Vector Voltmeter instrument method (left) and the equivalent measurement capability integrated within the Site Master in VVM mode (right) when the S820E is used for a transmission measurement.

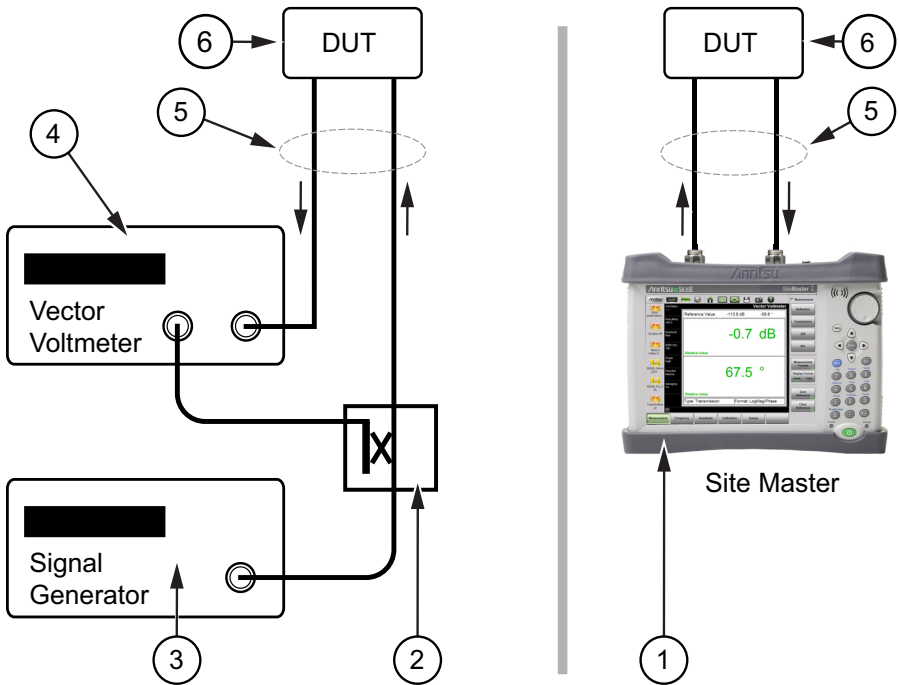

(Left) Vector Voltmeter and (Right) S820E Site Master Equivalent Measurement

1	S820E Site Master
2	Coupler or Splitter
3	Signal Generator
4	Vector Voltmeter
5	Transmission Measurement
6	DUT (Device Under Test)

Figure 8-2. Vector Voltmeter Transmission Measurement

A/B or B/A Measurements: For Reflection or Transmission measurements, the S820E VVM function can replace the entire setup of source, VVM, and couplers, as shown in [Figure 8-1](#) and [Figure 8-2](#). If the measurement setup still requires the use of an external source and couplers, however, then the S820E VVM function can replace only the original Vector Voltmeter by using the A/B or B/A measurement selection. The B/A setup is shown in [Figure 8-3](#) with the traditional Vector Voltmeter instrument method (left) and the equivalent measurement using the Site Master in VVM mode (right). For these measurements, the reference signal is received on one port of the S820E (Port 1 for B/A and Port 2 for A/B) while the signal transmitted through or reflected from the DUT is received on the other port.

B/A Measurement

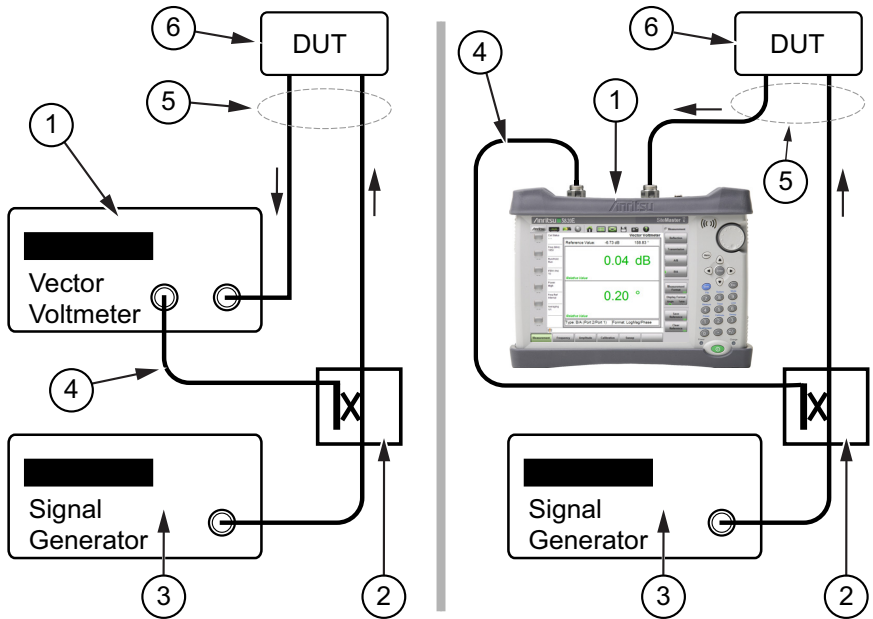

(Left) Vector Voltmeter and (Right) S820E Site Master Equivalent Measurement

1	Vector Voltmeter or S820E Site Master
2	Coupler or Splitter
3	Signal Generator
4	Reference Signal
5	B/A Measurement
6	DUT (Device Under Test)

Figure 8-3. Vector Voltmeter B/A Measurement

8-3 Example B/A Measurement

The S820E in VVM mode can be used to measure the two ports of a splitter and compare them.

1. Connect a reference frequency to Port 1 of the S820E and to the input of the splitter (see [Figure 8-4](#)). This is the A input for the B/A measurement.

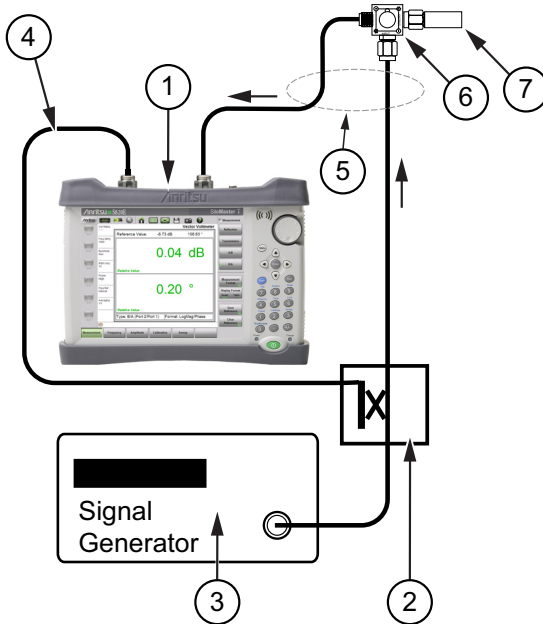

1 S820E Site Master in VVM mode

2 Coupler or Splitter

3 Signal Generator

4 Reference Signal

5 B/A Measurement

6 Splitter as DUT

7 50 ohm Load

Figure 8-4. VVM B/A Measurement of a Splitter

2. Connect one output side of the splitter to Port 2, and connect a 50 ohm load to the opposite output side. Press **Save Reference** to use this measurement as reference when you measure the other output side of the splitter. See [Figure 8-5](#).

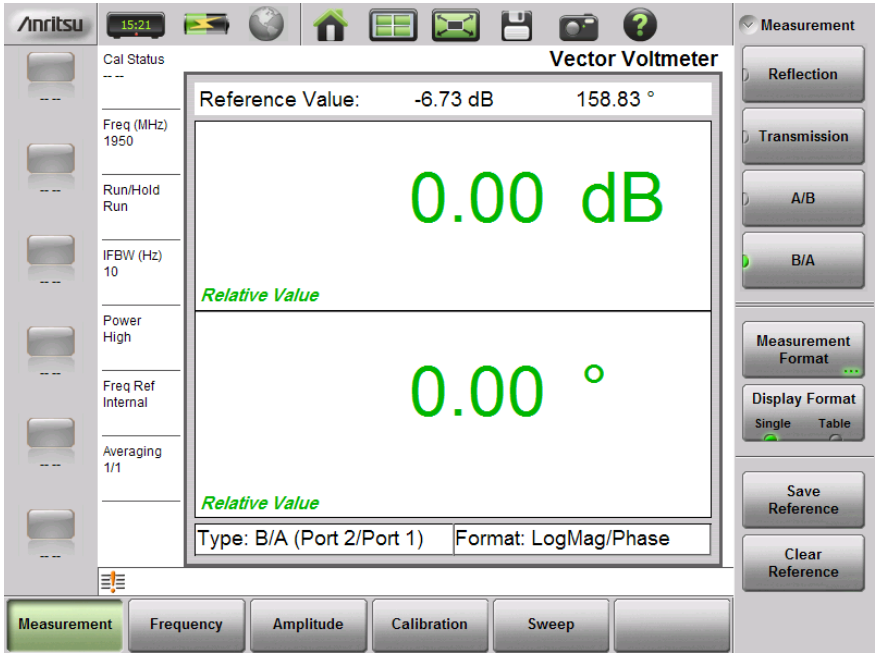

Figure 8-5. First Side of Splitter Measured and Saved as Reference

- After the reference value has been stored (in [Step 2](#)), reverse the splitter output connections and remeasure. The difference between both outputs of the splitter is displayed as the *Relative Value* that is shown in green on the S820E screen. This is the error between the two outputs of the splitter. A properly working splitter should have very closely matched values, as seen in [Figure 8-6](#). When in doubt, consult the splitter data sheet to determine if it is still functioning within specifications.

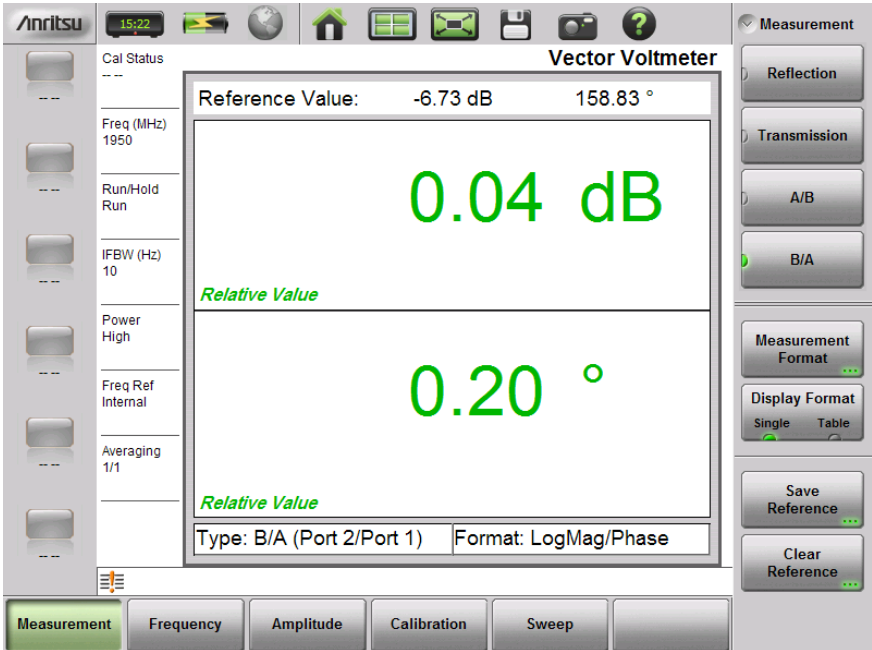

Figure 8-6. Second Side of Splitter Relative to Saved Reference

8-4 Relative Measurements

Often, absolute phase measurement of a DUT (cable in the following example) is not as important as the phase relationships among multiple DUTs. For the following example application, the Vector Voltmeter is used to make relative phase measurements.

The operations for relative measurements are described in the following steps.

1. Preset the S820E, then set up for this measurement by setting the frequency and the measurement type and format.

Measurement format may be LogMag/Phase, LinMag/Phase, SWR, or Impedance. LogMag/Phase measurement format is used in this example. You may change the measurement format at any time. If a reference value has already been recorded in a particular measurement format, and if you change the measurement format, then the reference value is automatically converted to the new selected measurement format.

2. Since many VVM measurements are made relative to a stored reference, vector error correction is not absolutely required. Absolute Reflection or Transmission measurements require calibration to remove residual errors, including port match errors. Refer to [Section 8-6 “VVM Calibration” on page 8-19](#) for more details.

For A/B or B/A measurements, vector error correction of the instrument is not possible. In some cases where the measured results are unstable or not as expected, the overall measurement results may be improved simply by adding 3 dB or 6 dB attenuators on each measurement port (A and B). The process of storing the reference value will need to be repeated if attenuators are added after the initial reference value was stored.

3. Connect the first DUT (device under test).
4. If you want to use the measurement result of this first DUT as your reference (the golden DUT), then press the **Save Reference** submenu key.

5. As shown in [Figure 8-7](#), the current measurement is saved and displayed as the Reference Value (at the top of the VVM display). The displayed values are now relative to the saved values, which are the difference between the current measurement and the saved reference. In other words, saving a reference will normalize the results to the current measurement.

The amplitude and phase windows now display *Relative Value*, and their text and data are displayed in green. If you clear the reference values, then the data are again displayed in black.

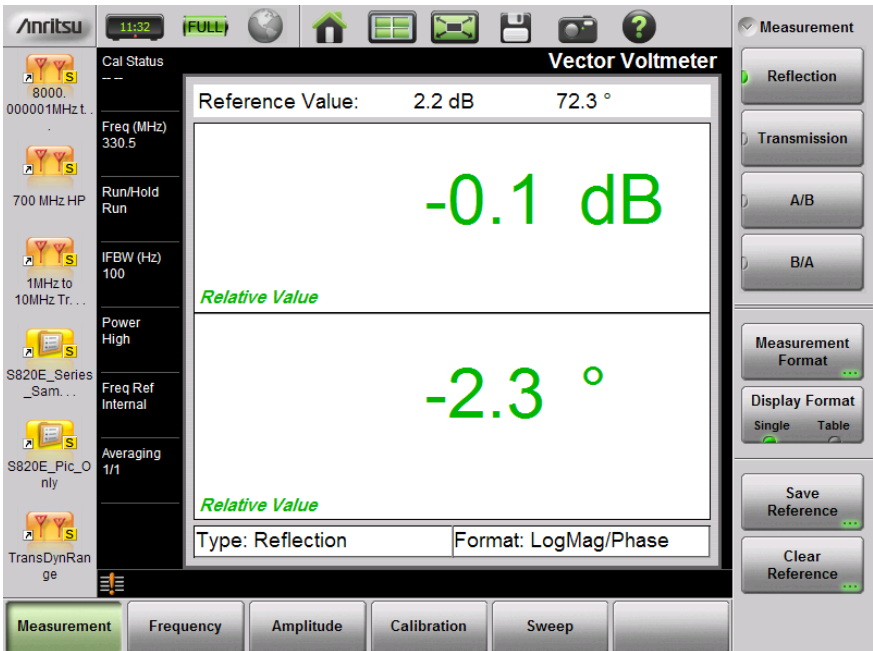

Figure 8-7. Relative Reflection Measurement

6. Additional DUTs may be connected consecutively (as required), and their relative results will be based on the stored reference.
7. To create a new reference, press the **Clear Reference** submenu key, then press the **Save Reference** submenu key while measuring the DUT for which you want to capture the new reference values.

If you are making many measurements, the display format can be set to Table. Refer to [“Table Display Format” on page 8-12](#).

Note

Clearing the reference while using the Table Display Format will immediately clear all of the relative measurement values that have been stored within the table.

Saving a new reference value while using the Table Display Format will immediately recalculate and display all of the relative measurement values with respect to the new saved reference.

You can change the current reference without pressing the Clear Reference submenu key. When the current measurement is desired as the new reference, press the Save Reference submenu key.

This completes the procedure for relative measurements.

8-5 Table Display Format

Begin the measurements and save a reference (if needed). The measurement results are displayed in the top row of the table. Press the **Enter** key to save a measurement and move to the next row of the table.

In the example shown in [Figure 8-8](#), multiple tuning stubs are being measured and compared to a reference stub. Tolerance was specified as ± 0.1 dB and $\pm 2^\circ$ compared to the reference. From the results you can see that stub numbers 4, 5, 6, and 8 fail the tolerance, but numbers 1,2,3 and 7 pass.

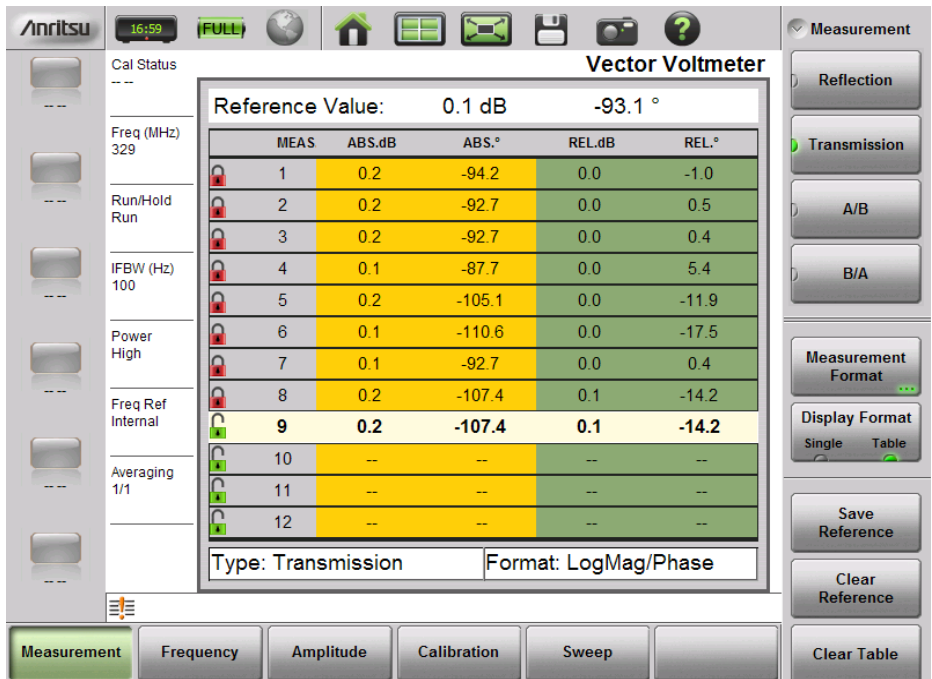

Figure 8-8. Table Display Format

You can make a new row become the active row. Use the touchscreen to tap a lock icon, or use the arrow keys or the rotary knob to highlight a row, then press **Enter**.

When you press **Enter** on a saved row, a message is displayed (see [Figure 8-9](#)). In order to make the measurement row active, the stored data must be cleared. Press the **Continue** button or the **Cancel** button.

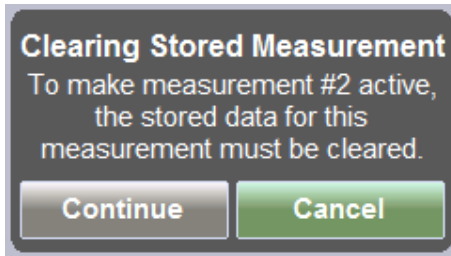

Figure 8-9. Message – Clearing Stored Measurement

When you have saved 12 measurements (the table rows are all used), if you press **Enter** again, you are asked if you want to clear the active measurement and remeasure. If you highlight any saved row and press **Enter**, you are asked if you want to clear the measurement and make that row active.

When the Display Format is set to **Table**, an additional submenu key (**Clear Table**) is displayed at the bottom of the list to allow you to clear the entire table. A message is displayed asking you to confirm your choice. When the table is cleared, the active measurement returns to row 1. The saved reference remains as the reference value.

You can continue to make measurements with the same saved reference until you press the **Clear Reference** key.

Clearing the reference while using the Table Display Format will immediately clear all of the **relative** measurement values that have been stored within the table. The stored measurements are not affected.

Note As soon as you save another reference value, all of the relative measurement values are recalculated for stored measurements. Pressing **Save Reference** when a reference value is already saved, overwrites the saved reference with the new (current) value.

In the example shown in [Figure 8-10 on page 8-15](#), measurement starts from the default active Row 1. When you press **Enter** to lock in the measurement data for that row, the Green unlock icon changes to a Red lock icon to indicate that the data in that row have been locked. The next available row (Row 2) then becomes active with live data. Pressing **Enter** on Row 2 locks the data, and the next available row (Row 3) then becomes active. This repeats until the table has been completely filled. If you skip back to a previously filled row and press **Enter**, then the pop-up message that is shown in [Step 5](#) appears. Pressing **Continue** clears the data for that row, and the row becomes active with live data. After the live data are locked into that row, the next unused row in the table (if any remain) will become live, and the standard sequence returns.

The following procedure describes working with the features of Table Display Format.

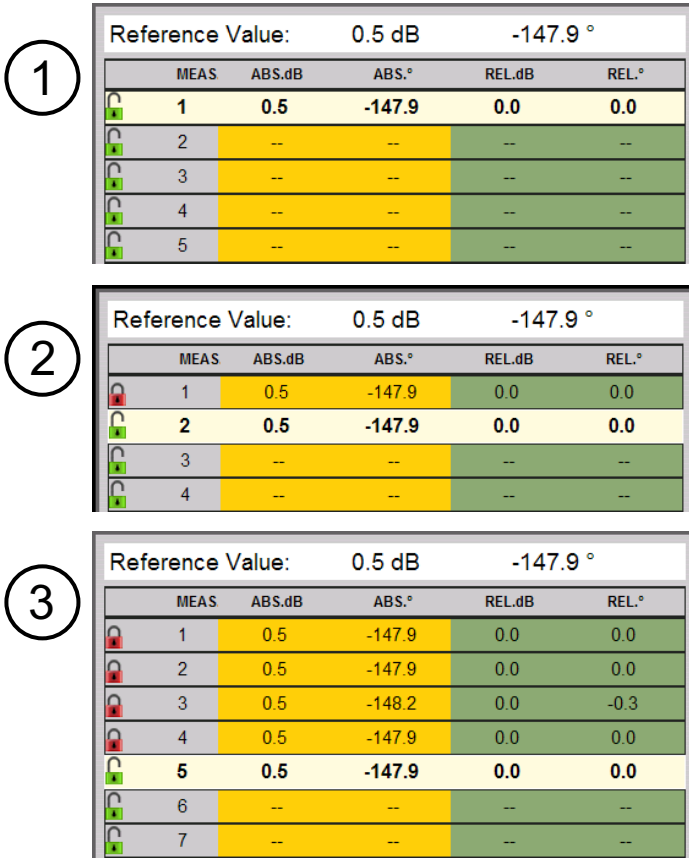

1. Row 1 is active and highlighted.
2. Press **Enter**. Row 1 is saved (lock icon becomes red). Row 2 becomes active and highlighted.
3. Press **Enter** for Row 2, then for Row 3, then for Row 4. Rows 1 through 4 have stored measurements (icons show locked). Row 5 is active and highlighted. Note that the measured values are identical except for Row 3.

Figure 8-10. Working with Table Display Format – 1 of 3

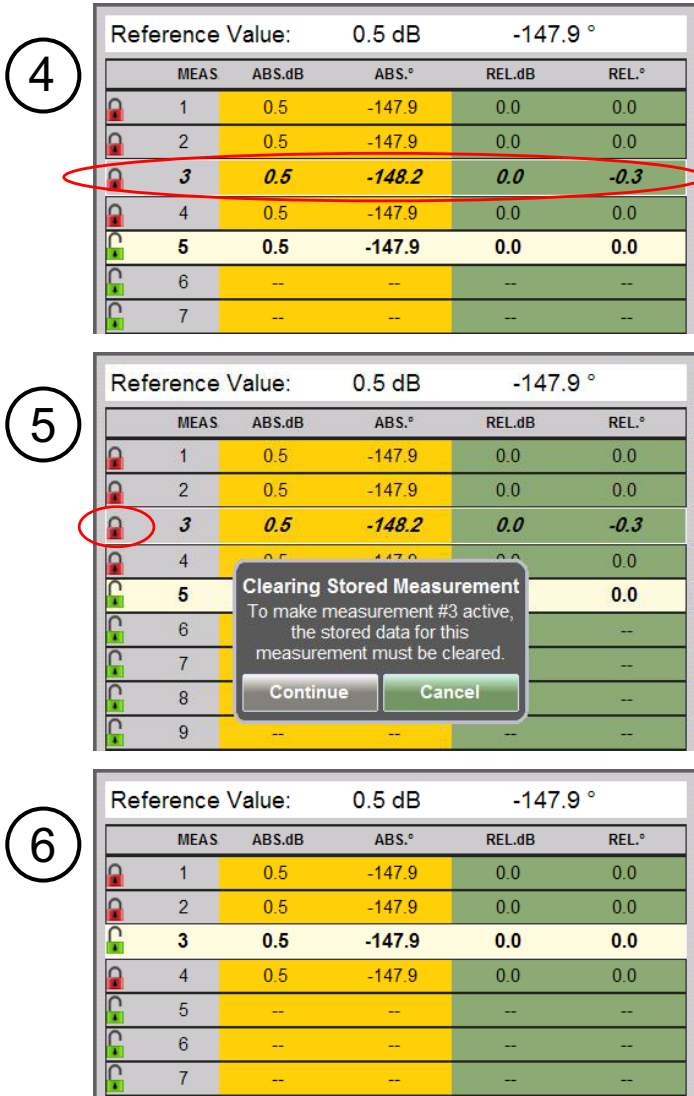

4. Use arrow keys or rotary knob to highlight Row 3 (until the numerals are bold and slanted). Row 5 remains active.
5. Press **Enter** or tap the lock icon for Row 3. Then tap Continue to make Row 3 active. Note that previously saved data are overwritten with the current live data, as shown in [Step 6](#).

Figure 8-11. Working with Table Display Format – 2 of 3

6. Row 3 is active and highlighted. The data that were in Row 5 prior to making Row 3 active are not saved because it was not locked in. After new data are locked in Row 3 by pressing the **Enter** button, the active measurement drops down to the next available row in the table. In this case Row 5 becomes active again. See [Step 7](#).

Figure 8-11. Working with Table Display Format – 2 of 3

7

Reference Value:		0.5 dB	-147.9 °		
MEAS	ABS.dB	ABS.°	REL.dB	REL.°	
1	0.5	-147.9	0.0	0.0	
2	0.5	-147.9	0.0	0.0	
3	0.5	-147.9	0.0	0.0	
4	0.5	-147.9	0.0	0.0	
5	--	--	--	--	
6	--	--	--	--	
7	--	--	--	--	

8

Reference Value:		0.5 dB	-147.9 °		
MEAS	ABS.dB	ABS.°	REL.dB	REL.°	
1	0.5	-147.9	0.0	0.0	
2	0.5	-147.9	0.0	0.0	
3	0.5	-147.9	0.0	0.0	
4	0.5	-147.9	0.0	0.0	
5	0.5	-147.9	0.0	0.0	
6	--	--	--	--	
7	--	--	--	--	

7. In the example of [Step 6](#), the **Enter** key was pressed to save the data in Row 3. This is a view of the table just before pressing **Enter**.
8. Press **Enter** to save the measurement in Row 3 and to make Row 5 active. Note that measurement data in Row 3 were stored, and all measurements are now identical.

Figure 8-12. Working with Table Display Format – 3 of 3

When you press **Enter**, a lower unused row (if available) becomes active.

When you press **Enter**, and the lower unused rows are saved, a higher unused row becomes active.

The lock icon is red if measurement data are saved for that row.

Tapping the green lock icon of the active measurement stores that measurement, which is the same result as pressing **Enter**.

Tapping the green or red lock icon of any inactive row produces the same result as highlighting that row and pressing **Enter**. If the lock icon was green, then the row becomes active immediately. If the lock icon was red, then the confirmation dialog box is displayed, and you must press Continue to unlock the row and overwrite its data.

8-6 VVM Calibration

VVM Calibration versus Save Reference

Which one should be used?

The Save Reference function stores the current measurement and normalizes the main measurement display to the stored value. All subsequent measurements are now displayed as relative to the stored reference value. This function is independent of VVM Calibration and should not be confused with VVM Calibration. The Save Reference function will be used for ALL relative measurements made with the VVM. In comparison, VVM Calibration may not be required for all VVM relative measurements, although it is recommended because it allows for absolute measurement values of the DUTs, including the reference DUT, and it removes any inherent system errors of the instrument itself. VVM Calibration also compensates (via vector error correction) for any test cables, adapters, or fixtures that may have been added between the DUT and the instrument and the appropriate calibration kit.

Absolute VVM Measurements

Absolute, error corrected reflection or transmission measurements may be made on a DUT in VVM mode. For absolute measurements, a VVM calibration is required. The absolute measurement may then be stored as a reference, if required. Vector error corrected measurements on additional DUTs relative to the stored reference can then be made. This provides the best possible accuracy for relative VVM reflection and transmission measurements. VVM calibration removes system errors and defines a known measurement reference plane, which is mandatory for making accurate absolute measurements.

Relative VVM Measurements

Many VVM measurements are made relative to a stored reference, and in these cases, vector error correction may not be required. VVM calibration removes system errors and may improve relative measurement results. For these reasons, when you are making relative measurements, VVM calibration is recommended, but it is not mandatory.

A/B or B/A Ratio Measurements

VVM calibration is not available when making A/B or B/A ratio measurements. In some cases, adding a 3 dB or 6 dB attenuator to each measurement port (A and B) may be helpful to reduce mismatch errors, which cannot be vector error corrected. If attenuators are going to be added, they must be installed BEFORE performing the Save Reference function. Test port cables, adapters, fixtures, or any other items that are needed to connect to the DUT must also be in place before performing the Save Reference function, and must remain in place for the duration of the measurements.

Performing Calibrations

The calibration menu choices are a subset of those found in [Chapter 4, “Calibration, CAA”](#) with fewer choices due to the fewer types of measurements that are available with the vector voltmeter.

To view a summary of these settings, begin from the **Calibration** main menu and press **Cal Info**. A summary of the Active Cal Settings and the Current Settings of the instrument are displayed (for an example, see [Figure 4-3 on page 4-3](#)). Press **Esc** to close the Cal Info window.

The calibration menu has a **Thru Update** submenu key (see [Figure 8-20 on page 8-27](#)) that allows you to recalibrate the Thru component without repeating the entire calibration sequence. Refer to [“Thru Update” on page 4-15](#).

For more specific calibration information, refer to [Chapter 4, “Calibration, CAA”](#).

8-7 Vector Voltmeter Menus

Figure 8-13 shows a menu map of the VVM menus. Menu maps typically display all possible submenu keys, although some keys may be displayed on the instrument only under special circumstances (refer to menu descriptions on the following pages).



Figure 8-13. Main Menu Keys

8-8 Measurement Menu (1 of 2)

Key Sequence: **Measurement**









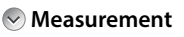

	<i>Measurement</i>
	<p>Reflection: Press this submenu key to select a reflection (Port 1) measurement.</p>
	<p>Transmission: Press this submenu key to select a transmission (Port 1 to Port 2) measurement.</p>
	<p>A/B: Press this submenu key to display the result of Port 1/Port 2.</p>
	<p>B/A: Press this submenu key to display the result of Port 2/Port 1.</p>
	<p>Measurement Format: Press this submenu key to open the Measurement format dialog box and select one of the available formats. Figure 8-17 on page 8-25 Choose from:</p>
	<ul style="list-style-type: none"> LogMag/Phase LinMag/Phase SWR Impedance
	<p>Display Format</p>
	<p>Single Table: Press this submenu key to toggle the display format to Single or Table. Single is the default setting. With Single format, the selected measurement type is displayed as shown in Figure 8-17 on page 8-25. With Table selected, 12 rows are available to display up to 12 measurements. Refer to section “Table Display Format” on page 8-12.</p>
	
	
	

Figure 8-14. Measurement Menu – 1 of 2

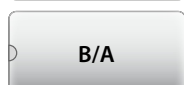
8-9 Measurement Menu (2 of 2)

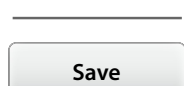
Key Sequence: **Measurement**

<p>Measurement</p>	<p><i>Measurement</i></p>
<p>Measurement</p>	
<p>Reflection</p>	
<p>Transmission</p>	
<p>A/B</p>	
<p>B/A</p>	
<p>Measurement Format</p>	
<p>Display Format</p> <p>Single Table</p>	
<p>Save Reference</p>	
<p>Clear Reference</p>	
<p>Clear Table</p>	

Save Reference: Press this submenu key to save the current measurement as a reference. Note that this is equivalent to the **Zero** function found on some other VVM products. Saving a reference sets the VVM to relative measurement mode. Text and data in the display are changed from black font to green, and “Relative Value” is displayed. The reference values are displayed in black font.

Clear Reference: Press this submenu key to remove the reference measurement from memory. This resets the VVM to display absolute measurement values.

Clear Table: Press this submenu key to clear all of the saved measurements in Table display format. The saved reference value remains saved to allow additional relative measurements. This submenu key appears only when Display Format is set to Table.

Figure 8-15. Measurement Menu – 2 of 2

Measurement Format

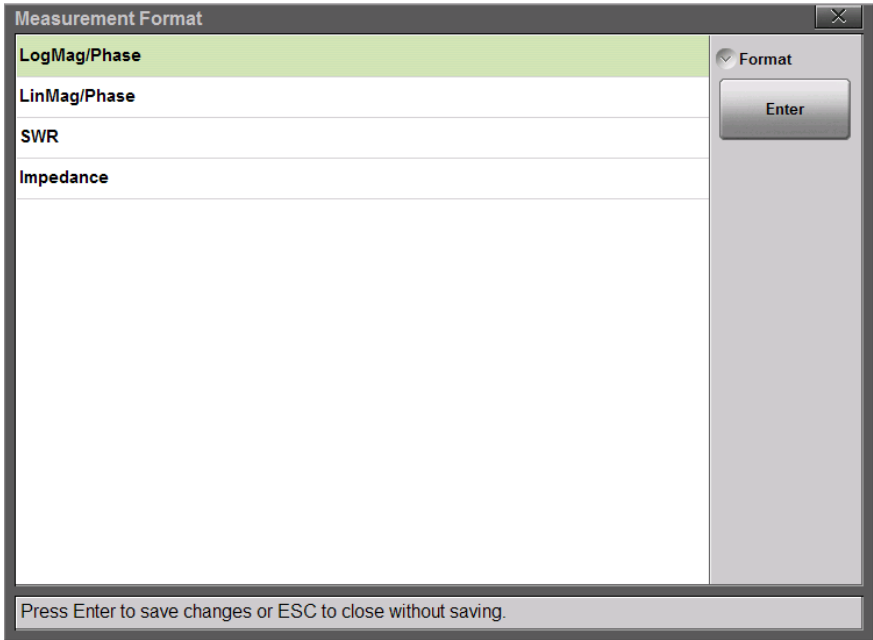

Figure 8-16. Measurement Format Dialog Box

LogMag/Phase measurement results are displayed as logarithmic amplitude in dB in the upper window and as phase in degrees in the lower window.

LinMag/Phase measurement results are displayed as linear amplitude in the upper window and as phase in degrees in the lower window.

SWR displays the ratio (with no units) in the upper window only.

Impedance measurement results are displayed as real impedance in the upper window, and as imaginary impedance in the lower window.

Single Display Format

This Vector Voltmeter display shows single measurement results in 2 rectangular windows, as shown in [Figure 8-17](#). Single is the default Display Format setting. For Reflection and Transmission measurements in magnitude and phase formats, the measurement results are displayed as amplitude in the upper window and phase in the lower window.

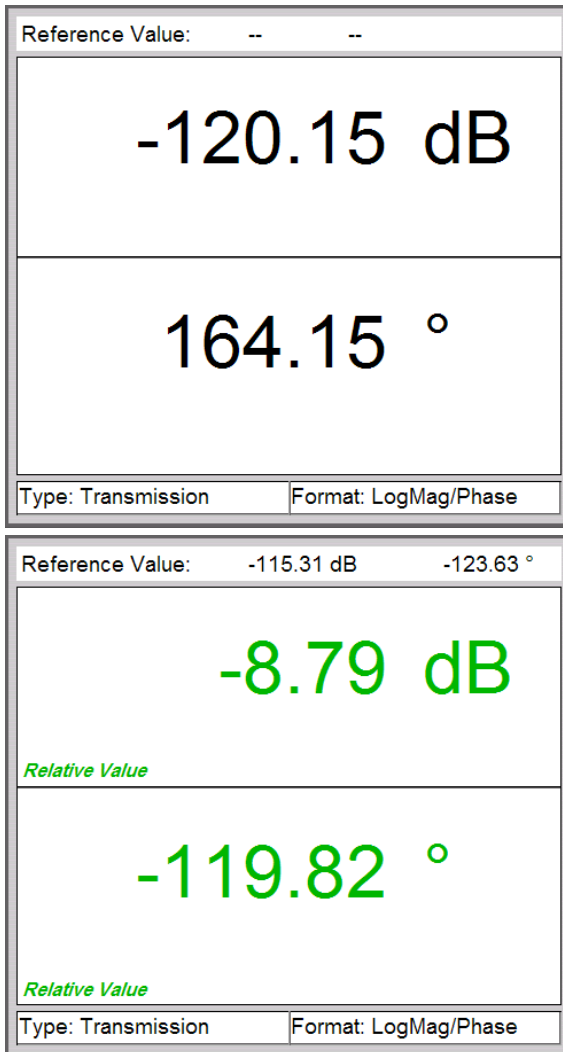

Figure 8-17. Single Display Format

8-10 Frequency Menu

Key Sequence: **Measurement**

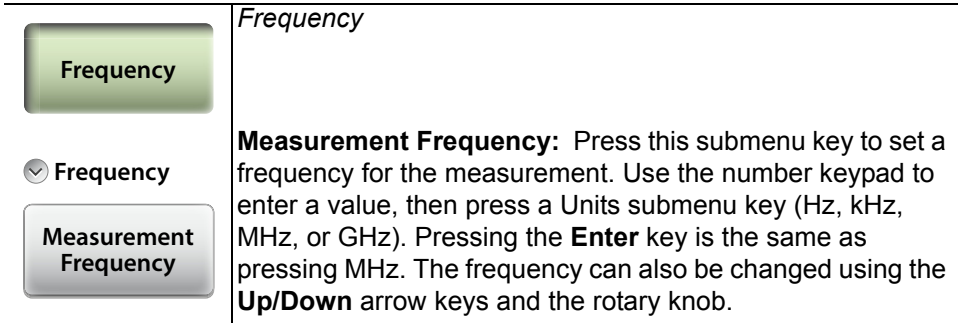

Figure 8-18. Frequency Menu

8-11 Amplitude Menu

Key Sequence: **Amplitude**

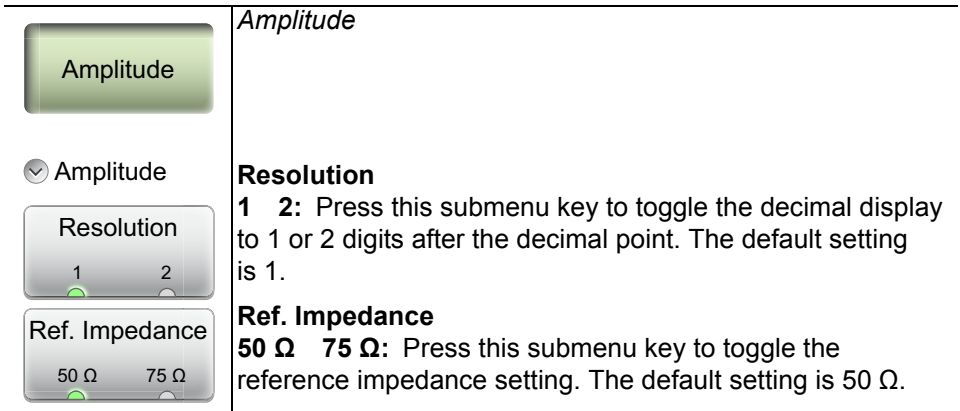

Figure 8-19. Amplitude Menu

8-12 Calibration Menu

Key Sequence: Calibration





	<i>Calibration</i>
	
	<p>Start Calibration: Press this submenu key to display the Step 1 calibration dialog box (see Figure 8-21 on page 8-28).</p>
	<p>Thru Update: Press this submenu key to Open the Calibration dialog box to allow calibrating the Thru component without repeating the entire calibration sequence. This key is displayed only after a calibration with a Thru component.</p>
	<p>Cal Info: Press this submenu key to display the Calibration Information table (for an example, see Figure 4-3 on page 4-3).</p>
	<p>Cal Correction On Off: Press this submenu key to toggle the current calibration On or Off. A valid calibration must be available in order to turn on this setting.</p>

Figure 8-20. Calibration Menu

Step 1 Calibration Dialog Box**Figure 8-21.** Calibration Step 1 of 5

8-13 Sweep Menu

Key Sequence: **Sweep**

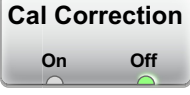
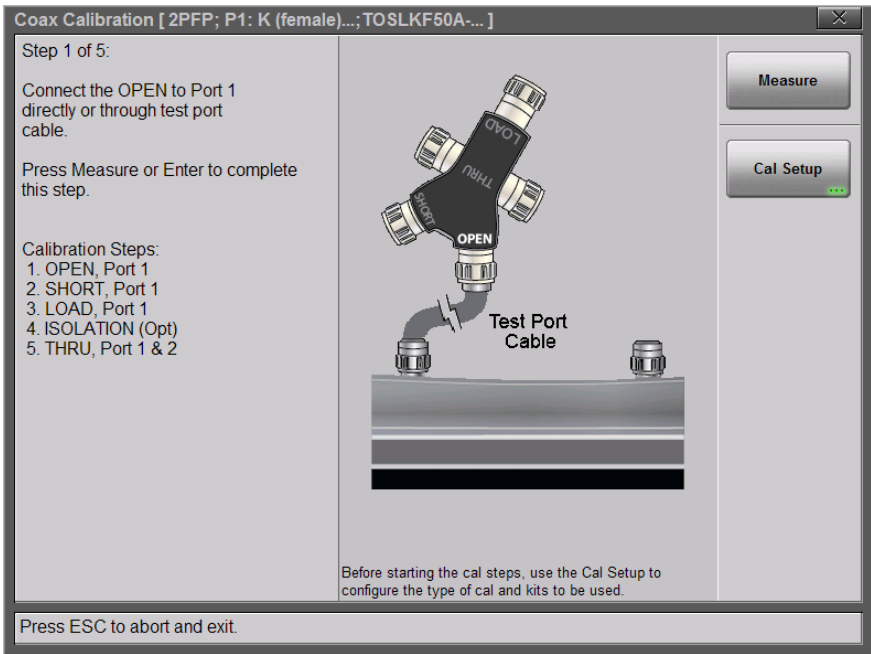



	<p><i>Sweep</i></p> <p>Run/Hold Run Hold: Default is Run. Press this submenu key to toggle the sweep setting between Run and Hold. Hold stops the active measurement and holds the current measurement results. Run restores the active measurement and continuously updates the active measurement results.</p> <p>RF Pwr In Hold On Off: Press this submenu key to toggle RF power On or Off while the sweep is set to Hold.</p> <p>Source Power High Low: Press this submenu key to toggle the internal source power setting to High power or Low power.</p> <p>IFBW: Press this submenu key to display the IFBW dialog box (see Figure 8-23 on page 8-30) and select a bandwidth. Choose from:</p> <ul style="list-style-type: none"> 100 kHz (maximum sweep speed) 1 kHz 100 Hz (default) 10 Hz (maximum dynamic range) <p>Sweep Averaging: Press this submenu key to enter the number of sweeps to use for averaging. Use the Up/Down arrow keys, the rotary knob, or the number keypad. The setting range is 1 to 1000.</p>
	
	
	
	
	
	

Figure 8-22. Sweep Menu

Source Power

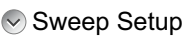
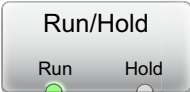
The default setting is High, which is more accurate because you are measuring further above the noise floor. Use Low power for devices that are sensitive to higher power levels, such as amplifiers. Source Power is not applicable for A/B and B/A measurement types.

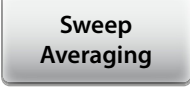
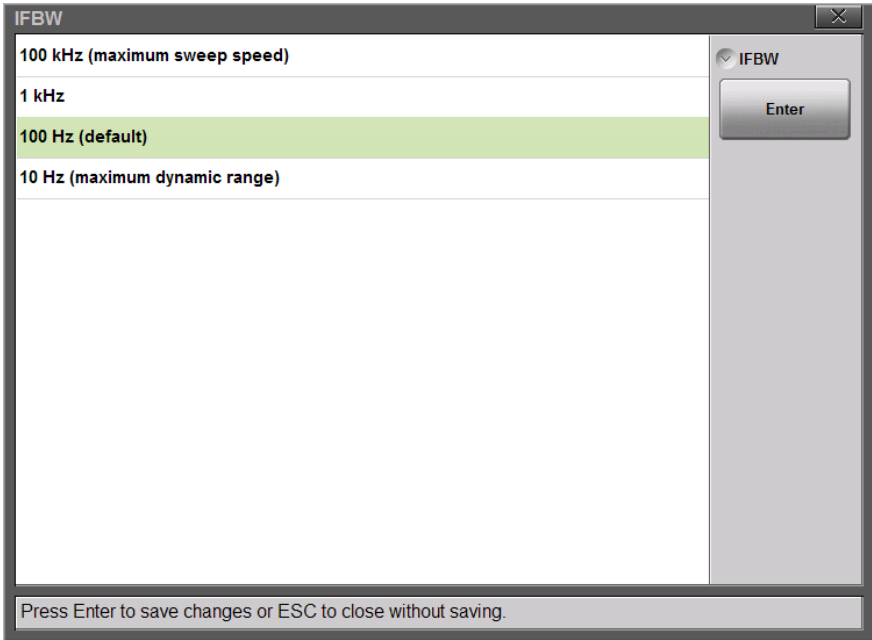

Figure 8-23. IFBW Dialog Box

8-14 Preset Menu

Key Sequence: **Preset (1)**

Refer to [Section 11-9 “Preset Menu”](#) on page 11-27.

8-15 Trace Menu

Key Sequence: **Trace (5)**

Not used in VVM mode.

8-16 Limit Menu

Key Sequence: **Limit (6)**

Not used in VVM mode.

8-17 File Menu

Key Sequence: **File (7)**

Refer to [Section 10-11 “File Menu”](#) on page 10-28.

8-18 System Menu

Key Sequence: **System (8)**

Refer to [Section 11-8 “System Menu”](#) on page 11-15.

8-19 Mode Menu

Key Sequence: **Mode (9)**

Refer to [Table 2-1, “Site Master Keypad Functions”](#) on page 2-9.

Chapter 9 — High Accuracy Power Meter

9-1 Introduction

This chapter provides an overview of power meter measurements and how to setup the instrument to use an external USB Sensor in the High Accuracy Power Meter mode. Actual power is measured at the USB sensor connector in dBm and Watts or relative power in dB and percentage. The frequency span and dynamic range for measurements is determined by the USB external sensor.

Note	Check the graph title in the top right of the display to confirm that the instrument is in High Accuracy Power Meter mode. If necessary, press the Menu key to change modes.
-------------	---

In this mode and with an appropriate sensor, the instrument can be used to make high accuracy power measurements including true RMS measurements for both CW and complex digitally modulated signals.

A general overview of USB sensors, including connection and measurements setup, begins in [Section 9-3 “General Measurement Setup Connection” on page 9-4](#).

With the MA24105A in-line sensor, additional functions are available including: forward and reverse measurements.

- Forward Measurements: Average Power, Crest Factor, Burst Average Power, Peak Envelope Power (PEP), and CCDF.
- Reverse Measurements: Average Power, Reflection Coefficient, Return Loss, and VSWR.

Note	Screen images in this User Guide are illustrations of typical instrument features. Some images may include instruments other than the Site Master S820E. Traces and other display features may differ from the screen displays of your instrument.
-------------	--

Refer to [“MA24105A Inline Power Sensor”](#) on page 9-12 for information specific to this in-line sensor.

Note

Sensors are not included with the Site Master and must be purchased separately. The S820E Site Master data sheet lists compatible sensors.

The SC8268 is not a compatible power sensor. It is not valid for use with High Accuracy Power Meter mode.

9-2 Power Meter Display

Figure 9-1 illustrates the preset Power Meter display with limits turned on.

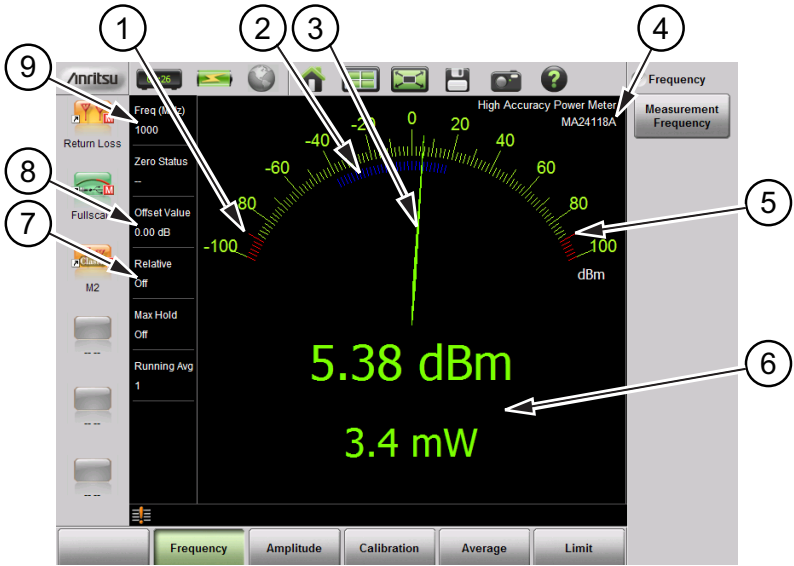

1.	Preset -90 dBm Lower Limit
2.	Power Range of Attached Sensor
3.	Power Meter Needle
4.	High Accuracy Power Meter Mode and Connected USB Sensor
5.	Preset +90 dBm Upper Limit
6.	Current Power in dBm and Watts (including any Offset Value) or "No USB sensor detected" if an external USB sensor is not connected or recognized by the Site Master.
7.	Relative Power (dB and %) or Absolute Power (dBm and Watts)
8.	Offset Value to Account for External Attenuation or Gain
9.	Source Frequency Used for Correction Factor

Figure 9-1. Power Meter Display Overview

9-3 General Measurement Setup Connection

Note Refer to the label on the USB sensor for information on frequency range and dynamic range.

Connection Setup for Anritsu High Accuracy Terminating Sensors

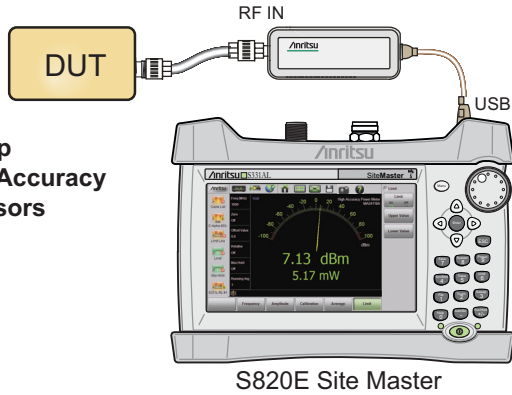

Connection Setup for Anritsu High Accuracy Inline Sensors

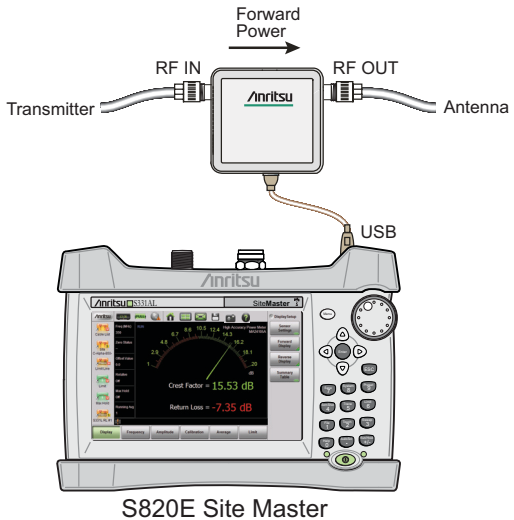

Figure 9-2. External USB Sensor Connection Setups

Connection and Offset

1. Connect the source to be measured to the USB sensor. Use any required external attenuation or gain so the expected power level is within specification for the sensor.
2. Press **Amplitude** then **Offset Value**. Enter an offset value for any external attenuation (negative value) or external gain (positive value). The displayed power is adjusted by the offset value.

As an example, a power source around 1 Watt (30 dBm) may cause damage to some sensors. 10 dB of in-line external attenuation will bring the power level down to approximately 100 mW, within the sensor range. Adding an **Offset Value** of -10 dB will remove the external attenuation from the displayed power level resulting in the correct power value being displayed on the analyzer.

Setting the Measurement Frequency

Press the **Frequency** main menu key then press **Measurement Frequency**. Set the measurement frequency to match the actual signal frequency being measured by using the number keypad. Then press the unit of measure button. The USB sensors contain EEPROM correction data for their own inherent frequency response. Failing to set the measurement frequency properly degrades measurement accuracy.

Setting the Amplitude

The maximum and minimum values of the analog display can be set in the **Amplitude** menu. Relative Power is a useful feature to obtain the power reading with respect to a previous power level.

1. Press the **Amplitude** main menu key.
2. Press the **Max Value** submenu key and set the upper scale value. Press the **Min Value** submenu key and set the lower scale value.

or

Press the **Autoscale** submenu key to adjust the range automatically. The current power level is centered with **Min Value** automatically set at 90 % of the current power and **Max Value** automatically set at 110 % of the current power. Refer to [Figure 9-3 on page 9-6](#).

9-3 General Measurement Setup Connection High Accuracy Power Meter

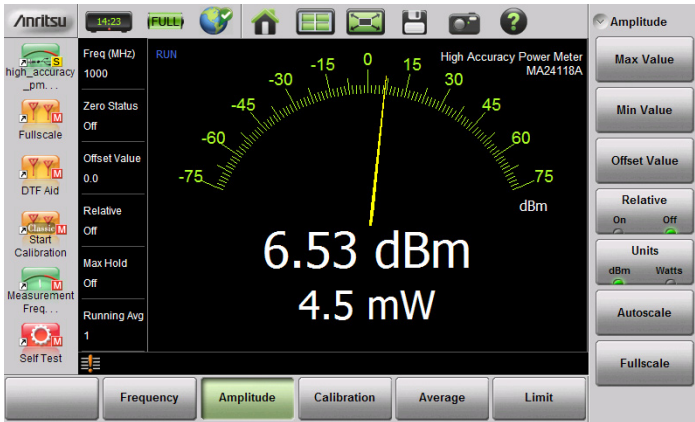

Before Autoscale

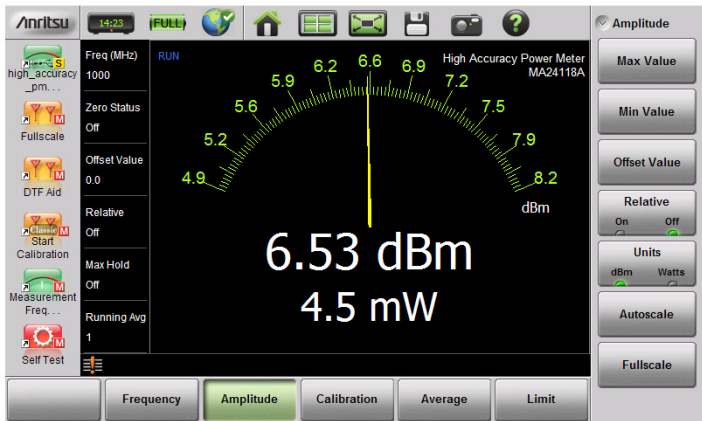

After Autoscale

Figure 9-3. Autoscale to Zoom In on a Measurement

Changing the Display Units

The power meter scale can be displayed in dBm or Watts. Use the following procedure to change the displayed units:

1. Press the **Amplitude** main menu key.
2. Press the Units submenu key and select the display units.

Displaying Relative Power

Use the following procedure to select Relative Power through the Amplitude menu.

1. With the desired base power (reference) level connected to the USB sensor, press the **Amplitude** main menu key.
2. Press the **Relative** submenu key. Note that the absolute value of the measurement at the time the **Relative** key is pressed is shown in yellow below the numerical display (see [Figure 9-4 on page 9-8](#)).
3. Any change in power will now be displayed relative to the set reference level. Refer to the bottom image in [Figure 9-4 on page 9-8](#).

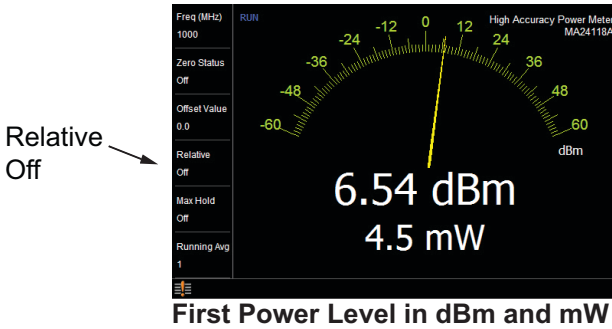

Figure 9-4. Relative Power Example

Note	Relative power is displayed numerically in dB and percentage, scale is absolute.
-------------	--

Setting Upper and Lower Limits

Maximum and minimum limits can be set as follows:

1. Press the **Limit** main menu key and set Limit to On.
2. Press the **Upper Value** submenu key and use the keypad, **Up/Down Arrow** keys, or the rotary knob to set the desired upper limit. Then press **Enter**.
3. Press the **Lower Value** submenu key and use the keypad, **Up/Down Arrow** keys, or the rotary knob to set the desired upper limit. Then press **Enter**.

The needle color and color of the numeric power level displayed below the graph change based on the current limit settings:

- Yellow needle, White text: Limits are turned off.
- Green need and text: Limits are on and the current power level is within limits.
- Red needle and text: Limits are on and the current power level is not within limits.

Refer to [Figure 9-5 on page 9-10](#) for examples of each condition.

9-3 General Measurement Setup Connection High Accuracy Power Meter



Limits Turned Off (Yellow Needle, White Text)

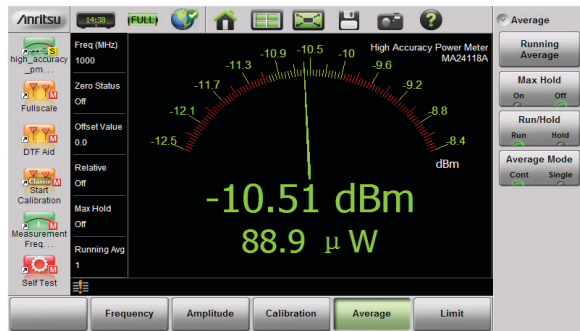

Power Level Within Limits (Green Text and Needle)

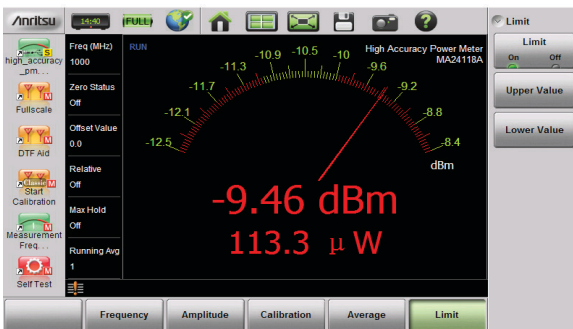

Power Level Beyond Limits (Red Text and Needle)

Figure 9-5. Limit Setting Display Changes

Average Menu Options

If the displayed values are unstable, then increase the **Running Average** from the default value of 1. Maximum value is 60. Increasing the running average is useful when measuring unstable sources or when measuring near the zero calibration level described below.

To monitor and record the maximum power level over time, set **Max Hold** to On. The needle and numeric values display the maximum recorded value until **Max Hold** is turned Off.

In **Cont + Run** mode (Figure 9-5), the power meter is continuously measuring and updating the power reading. In **Cont + Hold** mode, the readings are halted.

In **Single + Run** mode, the power meter performs the number of readings set in **Running Average** (default is 1) and then places the instrument in **Hold** mode. Changing the mode from **Hold** to **Run** initiates another series of readings and then returns the instrument mode to **Hold** once again.

Calibration

Zero the sensor to remove any residual noise before making power measurements. If frequent low-level measurements are being made, then check the sensor zeroing often, and repeat as necessary. Before zeroing the sensor, remove any RF input signal to the external sensor.

Zero Failure

This message appears if the zero operation is unsuccessful. The most common reason could be the presence of RF power at the input of the sensor.

Double check to ensure that no RF signal is present at the input of the sensor, and then try the zero operation again.

1. Press the **Calibration** main menu key and then press the **Zero Sensor** key.
2. When the process is complete, “Zero Status Ok” is displayed in the **Measurement Settings Summary** area.
3. Connect the sensor to the **Device Under Test**. The **High Accuracy Power Meter** will now display the power level of the desired RF signal, with the residual noise removed.

9-4 MA24105A Inline Power Sensor

Refer to the previous sections in this chapter for a general overview of using USB sensors with the Site Master.

Note

This section is specific to the additional options and settings available when the MA24105A in-line sensor is attached (Figure 9-2 on page 9-4). There are numerous menu changes with this meter. Refer to Figure 9-21 on page 9-26.

Introduction

Attaching the MA24105A inline peak power sensor adds additional menus and submenus required for making the following in-line measurements:

- Forward Measurements: Average Power, Crest Factor, Peak Envelope Power (PEP), Burst Average Power, and CCDF.
- Reverse Measurements: Average Power, Reflection Coefficient, Return Loss, and VSWR.

In the default view the analog meter displays the forward measurements. The reverse measurements are displayed below the numerical display of the forward measurements (Figure 9-6). To view all of the forward and reverse measurements in table format, use the Summary Table display (Figure 9-7).



Figure 9-6. Power Meter View

Summary Table			✕
Freq 350 MHz	Forward Average	2.57 dBm	<input checked="" type="checkbox"/> Status <input type="button" value="Measurement Summary"/> <input type="button" value="Sensor Settings"/>
	Crest Factor	14.46 dB	
Zero Off	Burst Average Manual	2.57 dBm	
	Burst Average Auto	22.16 dBm	
Offset Value 0.0	Peak Envelope Power	17.03 dBm	
	CCDF	0.0%	
Relative Off	Reverse Average	1.53 dBm	
	Reflection Coefficient	0.89	
Max Hold Off	Return Loss	1.04 dB	
	VSWR	16.72	
Running Avg 1			
Press ESC to close this dialog.			

Figure 9-7. Summary Table View

Inline Sensor Setup

The Sensor Settings submenu under the **Display** main menu adjusts the inline sensor parameters (Figure 9-8). The on screen instructions provide information for each parameter. To change a parameter, select it with the **Up/Down Arrow** keys or the touchscreen and press Edit.

Note Several sensor settings are only appropriate for specific measurements. Refer to the on screen information in the Sensor Settings dialog for additional information.

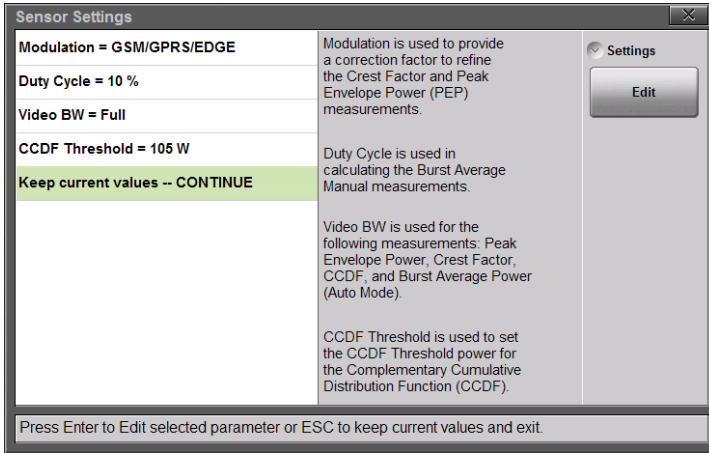

Figure 9-8. Sensor Settings

Modulation

In the Sensor Settings dialog, highlight the **Modulation = ...** row and press **Edit**. Use the **Up/Down** keys, rotary knob or touchscreen to highlight the desired modulation type, and then press **Select**.

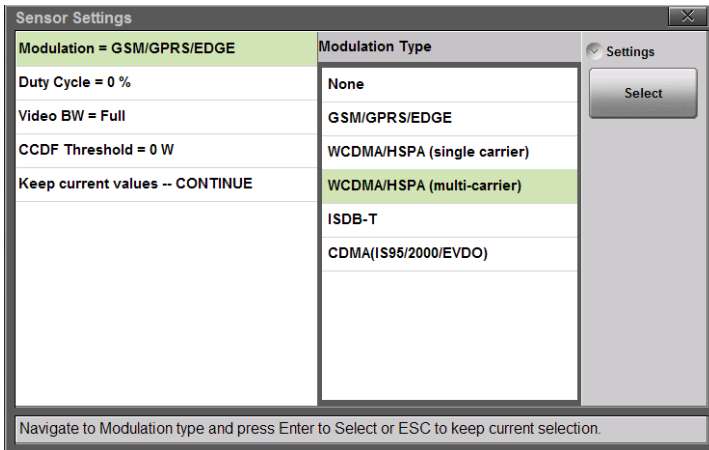

Figure 9-9. Sensor Settings

The selection of a specific modulation type provides a correction factor to refine the PEP calculation.

Duty Cycle

Sets the duty cycle used for averaging when the forward measurement is set to Burst Average Manual. Select a value from 0 % to 100 %. In the Sensor Settings dialog, highlight the Duty Cycle = ... row and press Edit. Use the **Up/Down** keys, rotary knob or key pad to set the duty cycle and then press **Enter**.

Video Bandwidth

Sets the Video Bandwidth span used in several forward measurements. In the Sensor Settings dialog, highlight the Video BW = ... row and press Edit. Use the **Up/Down** keys, rotary knob or touchscreen to highlight the desired View BW and then press **Select**.

CCDF Threshold

Sets the power threshold value used in the Complementary Cumulative Distribution Function (CCDF) forward measurement. CCDF describes the probability that the signal power is greater than the user-defined threshold value. In the Sensor Settings dialog, highlight the CCDF Threshold ... row and press Edit. Set the desired value and press one of the units of measure buttons to complete.

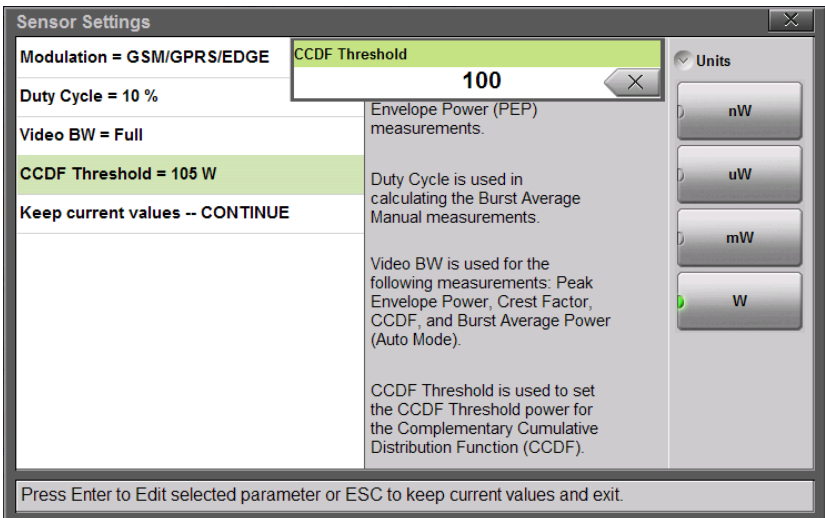

Figure 9-10. CCDF Threshold

Displayed Measurements

Select the forward and reverse measurements to display in the graph area (the analog graph always shows the forward measurement). Select Forward Display and/or Reverse Display under the Display main menu and choose a measurement. See [Figure 9-8](#) for examples of measurement combinations. Refer to “[Forward Menu](#)” on page 9-28 and “[Reverse Menu](#)” on page 9-29 for additional information.

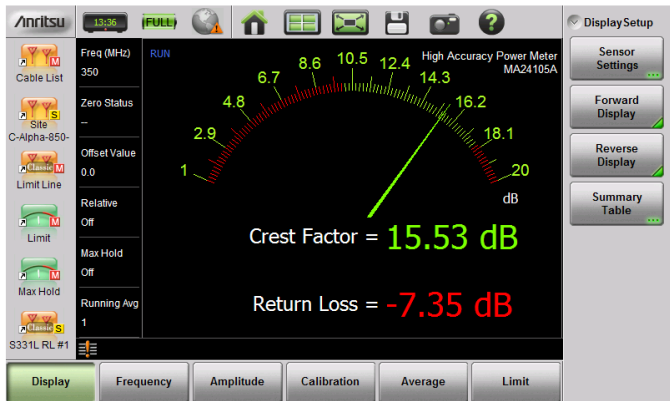
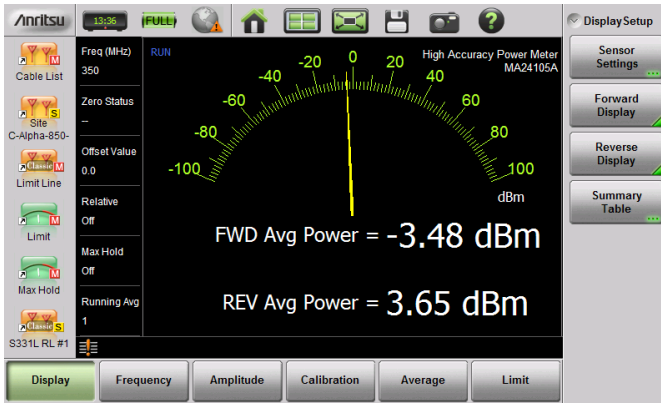

Figure 9-11. Forward and Reverse Measurement Combinations

Summary View

The Summary Table button under the **Display** main menu provides a summary of Site Master instrument settings, DUT forward and reverse measurements, and sensor settings (Figure 9-12).

Summary Table

Freq 350 MHz	Forward Average	2.57 dBm	<input checked="" type="checkbox"/> Status <input type="checkbox"/> Measurement Summary <input type="checkbox"/> Sensor Settings
	Crest Factor	14.46 dB	
Zero Off	Burst Average Manual	2.57 dBm	
	Burst Average Auto	22.16 dBm	
Offset Value 0.0	Peak Envelope Power	17.03 dBm	
	CCDF	0.0%	
Relative Off	Reverse Average	1.53 dBm	
	Reflection Coefficient	0.89	
Max Hold Off	Return Loss	1.04 dB	
Running Avg 1	VSWR	16.72	

Press ESC to close this dialog.

Summary Table

Freq 350 MHz	Modulation	None	<input checked="" type="checkbox"/> Status <input type="checkbox"/> Measurement Summary <input checked="" type="checkbox"/> Sensor Settings
	Duty Cycle	0 %	
Zero Off	Video BW	Full	
	CCDF Threshold	0 %	
Offset Value 0.0			
Relative Off			
Max Hold Off			
Running Avg 1			

Press ESC to close this dialog.

Figure 9-12. Summary Table

Note

Modifying sensor settings is described in [“Inline Sensor Setup”](#) on page 9-13.

Displaying Relative Power

Use the following procedure to select Relative Power through the Amplitude menu.

1. With the desired base power (reference) levels connected to the USB in-line sensor, press the **Amplitude** main menu key.
2. Press the Fwd Relative and/or Rev Relative submenu keys.
3. Any change in either forward or reverse power is now displayed relative to the set reference level power. Refer to [Figure 9-13](#).

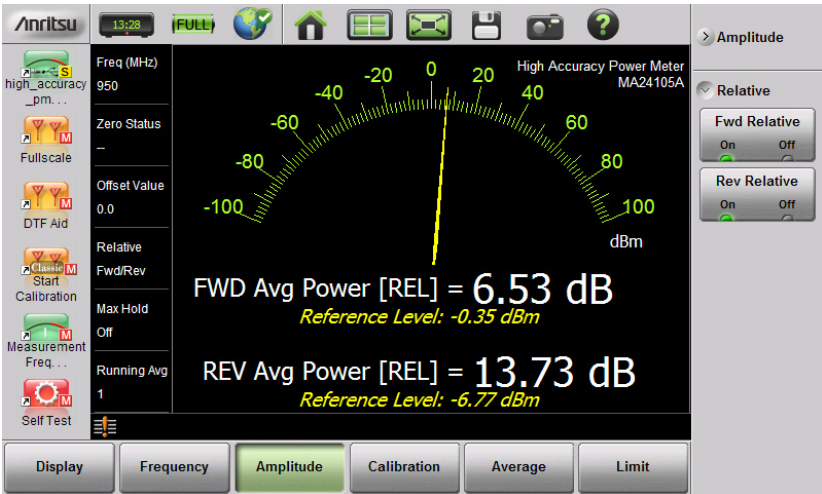

Figure 9-13. Forward and Reverse Relative Power

Limits for Forward and Reverse Measurements

Connecting the MA24105 sensors enhances the limit menu by providing upper and lower limits for both forward and reverse measurements.

1. Press the **Limit** main menu key and set Limit to On.
2. Press the Fwd Upper Value submenu key and use the keypad, **Up/Down Arrow** keys, or the rotary knob to set the limit. Then press **Enter**.
3. Repeat Step 2 for Fwd Lower Value, Rev Upper Value, and Rev Lower Value.

The text color of the numeric power level displayed below the graph changes based on the current limit settings:

- **White text:** Limits are turned off.
- **Green text:** Limits are on and the current measured value is within limits.
- **Red text:** Limits are on and the current measured value is not within limits.

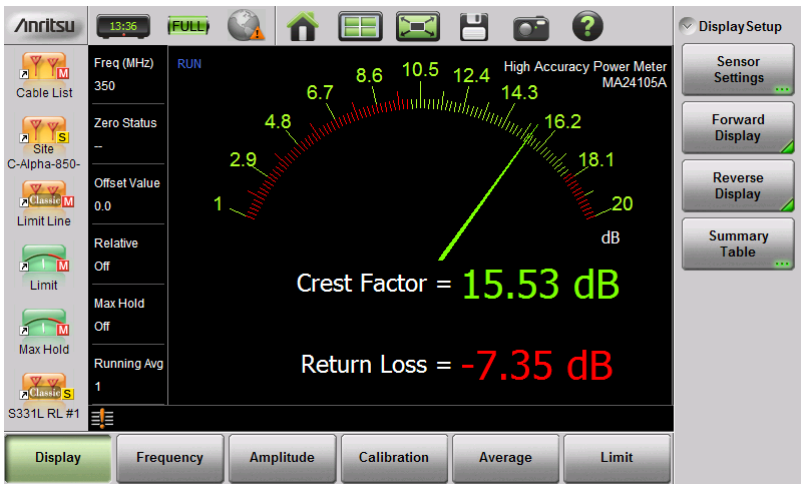

Figure 9-14. Measurement Value Beyond Reverse Limits Indicated by Red Text

9-5 High Accuracy Power Meter Menus

Figure 9-15 shows the map of the High Accuracy Power Meter menus. Menu maps typically display all possible submenu keys, although some keys may be displayed on the instrument only under special circumstances (refer to menu descriptions on the following pages).

Note MA24105A sensor menus in [Section 9-11 on page 9-26](#)

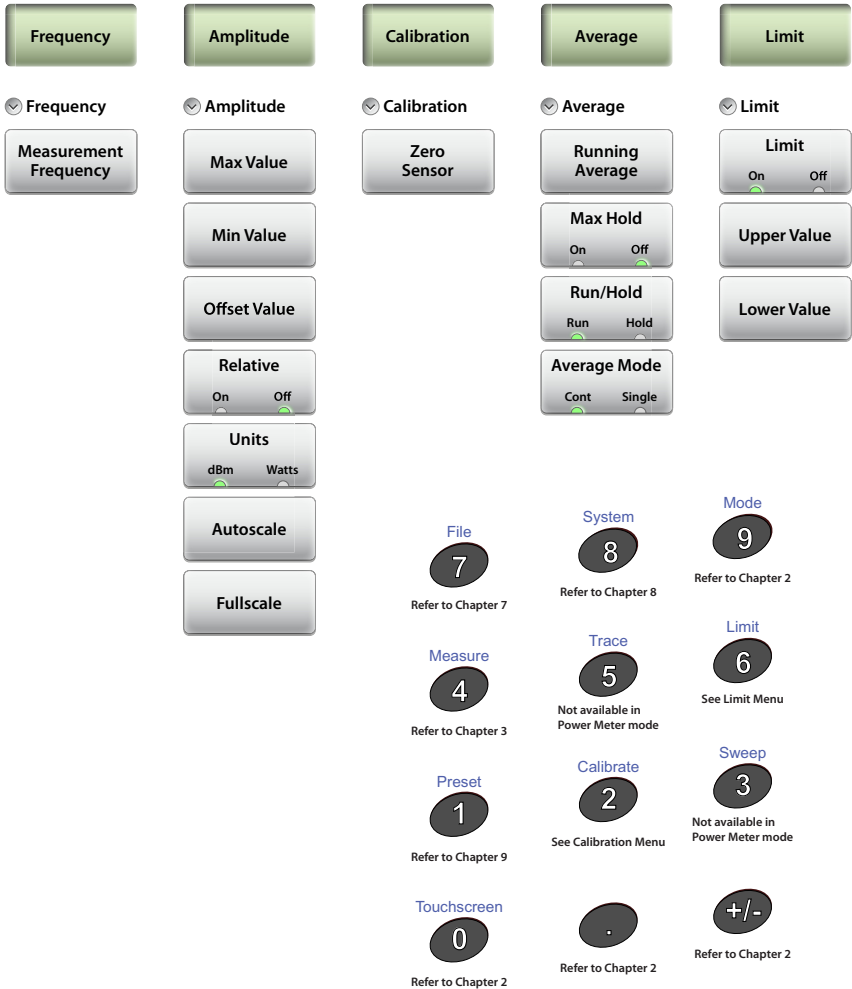

Figure 9-15. High Accuracy Power Meter Menus

9-6 Frequency Menu

Key Sequence: **Frequency**

	<i>Frequency</i>
	Measurement Frequency: Sets the frequency at the center of the measurement. Press the Measurement Frequency submenu key and enter the desired frequency using the Up/Down Arrow keys, the rotary knob, or the keypad. Press Enter to complete the entry or, if entering a frequency using the keypad, press the appropriate units key. Pressing ESC while editing the frequency restores the previous setting.
	

Figure 9-16. High Accuracy Power Meter Frequency Menu

9-7 Amplitude Menu

Key Sequence: **Amplitude**



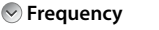
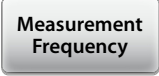





	<i>Amplitude</i>
	
	<p>Max Value: Sets the maximum value on the display in dBm or Watts.</p>
	<p>Min Value: Sets the minimum value on the display in dBm or Watts.</p>
	<p>Offset Value: Used to set external power attenuation or gain. The displayed power level is offset by the dB value entered.</p>
	<p>Relative On Off: Press this submenu key to toggle relative power On or Off. This measurement shows the relative level of the current power level to the level when relative was turned on. When ON, the message Relative On shows in the message area.</p>
	<p>Units dBm Watts: Sets the unit of measure for the power meter.</p>
	<p>Autoscale: Adjusts the Top and Bottom values so that the power meter needle will be shown in the middle of the analog display.</p>
	<p>Fullscale: Adjusts the Top and Bottom values to their maximum allowed values (default settings).</p>

Figure 9-17. High Accuracy Power Meter Amplitude Menu

9-8 Calibration Menu

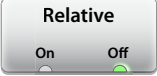
Key Sequence: **Calibration**

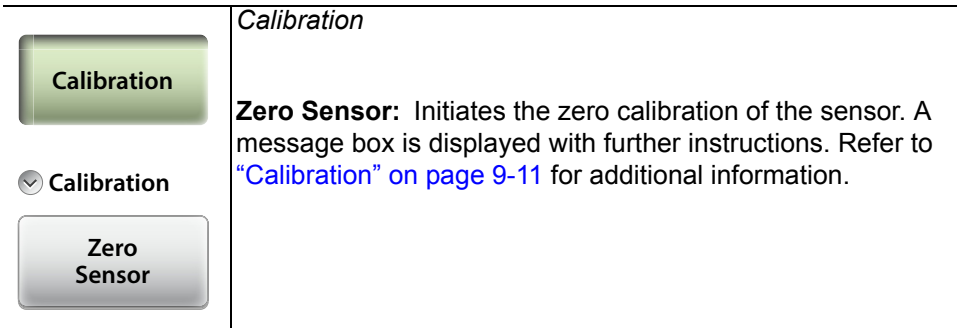

Figure 9-18. High Accuracy Power Meter Calibration Menu

9-9 Average Menu

Key Sequence: **Average**





	<p><i>Average</i></p> <p>Running Average: Sets the number of measurements used in calculating the average. Also sets the number of measurements made when Average Mode is set to Single, and when Run/Hold is toggled from Hold to Run. The default setting is 1 measurement, and the maximum setting is 60 measurements. Enter the desired number by using the keypad, the rotary knob, or the Up/Down Arrow keys. Press Enter to set, or press Esc to restore the previous setting.</p> <p>Max Hold: Setting Max Hold to On will display only the maximum power level. Turning Max Hold Off will display the current power level.</p> <p>Run/Hold: Toggles between Run and Hold. When in Hold mode, pressing this key starts the measurements and provides a trigger. When in the Run mode, pressing this key pauses the sweep.</p> <p>Average Mode: Toggles between single measurement and continuous measurements. In Single, each measurement (or series of measurements if Running Average is greater than 1) must be activated by the Run/Hold key.</p>
	
	
	
	
	

Figure 9-19. High Accuracy Power Meter Average Menu

9-10 Limit Menu

Key Sequence: **Limit** or **Limit (6)**

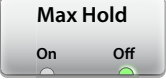
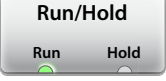



	<p><i>Limit</i></p>
<p>☑ Limit</p> 	<p>Limit: Turns the limits On or Off.</p>
	<p>Upper Value: Sets the upper limit (displayed as red hash marks). Enter the desired number by using the keypad, the rotary knob, or the Up/Down Arrow keys. If the keypad was used to enter new values, then press Enter to set the new values, or press the Esc button to restore the previous setting.</p>
	<p>Lower Value: Sets the lower limit (displayed as red hash marks). Enter the desired number by using the keypad, the rotary knob, or the Up/Down Arrow keys. If the keypad was used to enter new values, then press Enter to set the new values, or press the Esc button to restore the previous setting.</p>

Figure 9-20. High Accuracy Power Meter Limit Menu

9-11 MA24105A Menus

Figure 9-21 shows the map of the High Accuracy Power Meter menus when the MA24105A sensor is attached to the Site Master. Menu maps typically display all possible submenu keys, although some keys may be displayed on the instrument only under special circumstances (refer to menu descriptions on the following pages).

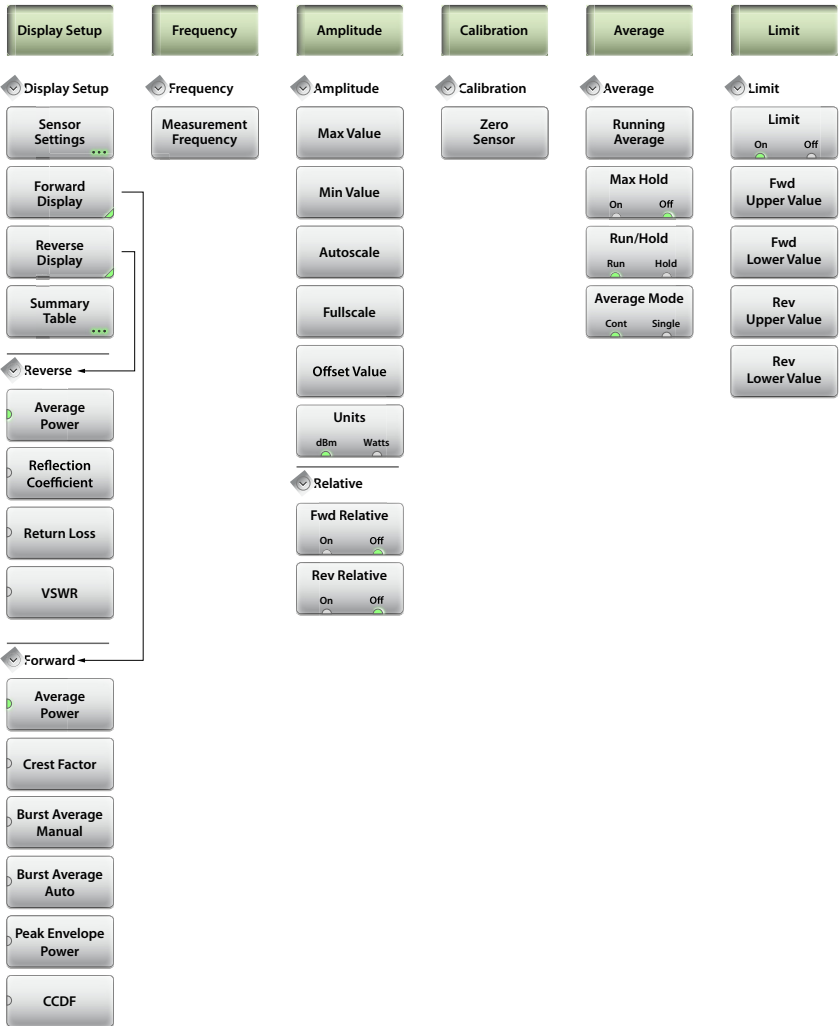

Figure 9-21. High Accuracy PM (MA24105A) Menus

9-12 Display Setup Menu

Key Sequence: **Display Setup**





	<i>Display Setup</i>
<input checked="" type="checkbox"/> Display Setup	
	<p>Sensor Settings: Displays the Forward Settings table (Figure 9-8) for the MA24105A sensor. Select a sensor parameter using the Up/Down Arrow keys or the touchscreen. Press Edit to change the value of the selected parameter.</p>
	<p>Forward Display: Displays the forward measurement options shown in “Forward Menu” on page 9-28.</p>
	<p>Reverse Display: Displays the reverse measurement options shown in “Reverse Menu” on page 9-29.</p>
	<p>Summary Table: Displays a summary of Site Master instrument settings, USB sensor settings, and DUT forward and reverse measurements (Figure 9-12).</p>

Figure 9-22. High Accuracy PM (MA24105A) Display Setup Menu

Forward Menu

Key Sequence: **Display Setup** > Forward









	<i>Forward</i>
	<p>Average Power: Press this submenu key to have the sensor measure the average power in the forward direction.</p>
	<p>Crest Factor: Press this submenu key to have the sensor measure the Crest Factor in the forward direction. Crest Factor is a ratio of peak power to RMS power.</p>
	<p>Burst Average Manual: Press this submenu key to have the sensor measure the average power within the signal bursts (in the forward direction). You define the duty cycle of the bursts in order to complete the averaging calculation.</p>
	<p>Burst Average Auto: Press this submenu key to have the sensor measure the average power within the signal bursts (in the forward direction). In auto, the sensor determines the duty cycle of the bursts in order to complete the averaging calculation.</p>
	<p>Peak Envelope Power: Press this submenu key to have the sensor measure the peak power in the forward direction.</p>
	<p>CCDF: Press this submenu key to have the sensor measure the value of the Complementary Cumulative Distribution Function (CCDF). The CCDF describes the probability that the signal power is greater than a threshold value.</p>
	

Figure 9-23. High Accuracy PM (MA24105A) Forward Menu

Reverse MenuKey Sequence: **Display Setup** > Reverse







	<i>Reverse</i>
	<p>Average Power: Press this submenu key to have the sensor measure the average power in the reverse direction.</p>
	<p>Reflection Coefficient: Press this submenu key to measure the reflection coefficient:</p>
	<p>Reflected Power / Forward Power</p>
	<p>Return Loss: Press this submenu key to measure return loss, which is the measurement in dB of reflected energy caused by impedance mismatch. May also be referred to as S11.</p>
	<p>VSWR: Press this submenu key to measure Voltage Standing Wave Ratio (VSWR), which is another measurement of reflected energy caused by impedance mismatch. Expressed as a ratio of X:1. VSWR measures the voltage peaks and valleys.</p>

Figure 9-24. High Accuracy PM (MA24105A) Reverse Menu

9-13 Frequency Menu

Key Sequence: **Frequency**

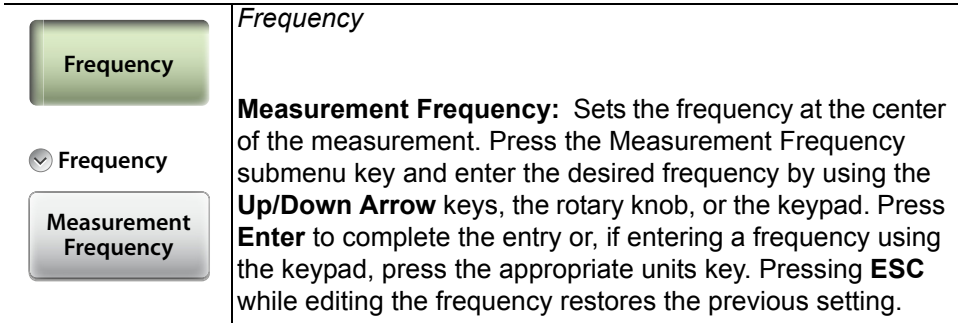

Figure 9-25. High Accuracy PM (MA24105A) Frequency Menu

9-14 Amplitude Menu

Key Sequence: **Amplitude**

	<p><i>Amplitude</i></p>
<p>▼ Amplitude</p>	<p>Max Value: Sets the maximum value on the display in dBm or Watts.</p>
	<p>Min Value: Sets the minimum value on the display in dBm or Watts.</p>
	<p>Autoscale: Adjusts the Top and Bottom values so that the power meter needle will be shown in the middle of the analog display.</p>
	<p>Fullscale: Adjusts the Top and Bottom values to their maximum allowed values (default settings).</p>
	<p>Offset Value: Used to set external power attenuation or gain. The displayed power level is offset by the dB value entered.</p>
	<p>Units dBm Watts: Sets the unit of measure for the power meter.</p>
	<p><i>Relative</i></p>
<p>▼ Relative</p>	<p>Fwd Relative On Off: Press this submenu key to toggle On or Off. This measurement shows the relative level of the current forward power level to the forward power level when Fwd Relative was turned on.</p>
	<p>Rev Relative On Off: Press this submenu key to toggle On or Off. This measurement shows the relative level of the current reverse power level to the reverse power level when Rev Relative was turned on.</p>
	<p>Note: The message Relative On shows in the message area when either Fwd or Rev Relative is on.</p>

Figure 9-26. High Accuracy PM (MA24105A) Amplitude Menu

9-15 Calibration Menu

Key Sequence: **Average**

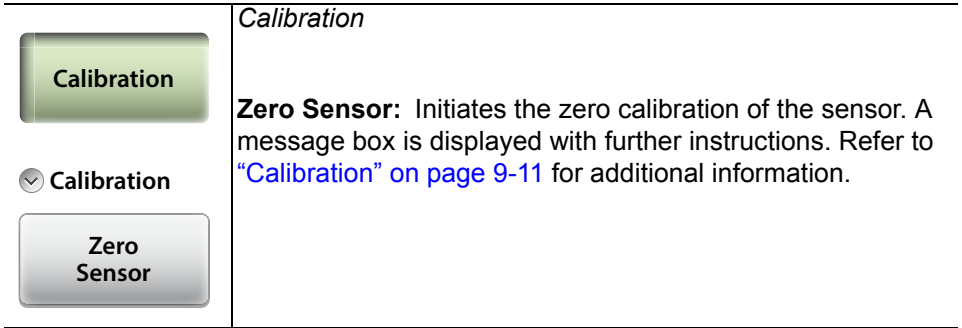

Figure 9-27. High Accuracy PM (MA24105A) Calibration Menu

9-16 Average Menu

Key Sequence: **Average**





	<p><i>Average</i></p>
<p>▼ Average</p> 	<p>Running Average: Sets the number of measurements used in calculating the average. Also sets the number of measurements made when Average Mode is set to Single, and when Run/Hold is toggled from Hold to Run. The default setting is 1 measurement, and the maximum setting is 60 measurements. Enter the desired number by using the keypad, the rotary knob, or the Up/Down Arrow keys. Press Enter to set, or press Esc to restore the previous setting.</p>
	<p>Max Hold: Setting Max Hold to On will display only the maximum power level. Turning Max Hold Off will display the current power level.</p>
	<p>Run/Hold: Toggles between Run and Hold. When in Hold mode, pressing this key starts the measurements and provides a trigger. When in the Run mode, pressing this key pauses the sweep.</p>
	<p>Average Mode: Toggles between single measurement and continuous measurements. In Single, each measurement (or series of measurements if Running Average is greater than 1) must be activated by the Run/Hold key.</p>

Figure 9-28. High Accuracy PM (MA24105A) Average Menu

9-17 Limit Menu

Key Sequence: **Limit** or **Limit (6)**

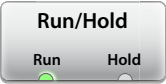

Limit

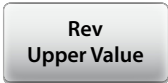

Limit

Limit: Turns the limits On or Off.

Fwd Upper Value: Sets the forward measurement upper limit (displayed as red hash marks). Enter the desired number by using the keypad, the rotary knob, or the **Up/Down Arrow** keys. If the keypad was used to enter new values, then press **Enter** to set the new setting or press the **Esc** button to restore the previous setting.

Fwd Lower Value: Sets the forward measurement lower limit (displayed as red hash marks). Enter the desired number by using the keypad, the rotary knob, or the **Up/Down Arrow** keys. If the keypad was used to enter new values, then press **Enter** to set the new setting or press the **Esc** button to restore the previous setting.

Rev Upper Value: Sets the reverse measurement upper limit. Enter the desired number by using the keypad, the rotary knob, or the **Up/Down Arrow** keys. If the keypad was used to enter new values, then press **Enter** to set the new setting or press the **Esc** button to restore the previous setting.

Rev Lower Value: Sets the reverse measurement lower limit. Enter the desired number by using the keypad, the rotary knob, or the **Up/Down Arrow** keys. If the keypad was used to enter new values, then press **Enter** to set the new setting or press the **Esc** button to restore the previous setting.

Figure 9-29. High Accuracy PM (MA24105A) Limit Menu

9-18 Sweep Menu

This menu is not available in High Accuracy Power Meter measurement mode.

9-19 Trace Menu

This menu is not available in High Accuracy Power Meter measurement mode.

9-20 Other Menus Keys

Refer to [Table 2-1, “Site Master Keypad Functions”](#) on page 2-9.

Chapter 10 — File Management

10-1 Introduction

This chapter reviews the file management features of the Site Master S820E. The associated menus and submenus allow you to save, recall, rename, copy, and delete files in internal memory or on an external USB drive.

The File menu is accessed by pressing the **File** (1) keypad menu key. In Video Inspection Probe (VIP) mode, you can alternatively press the **Save/Recall** main menu key on the touchscreen.

Note

Screen images in this User Guide are illustrations of typical instrument features. Some images may include instruments other than the Site Master S820E. Traces and other display features may differ from the screen displays of your instrument.

10-2 Overview

Remember the following tips when reviewing this chapter:

- Saved measurements also contain setup information.
- Recalled measurements display in purple and may change the current instrument settings (*which will not be saved*) in order to display the recalled measurement.
- Calibration information is recalled with setup files but not recalled with measurement files.
- Rename saved files under the file management (**File** > File Mgmt) menu.
- Sort files by tapping the column headings.
- Quickly move up or down long lists using the buttons under the Navigation submenu.
- Set the location to save files (Internal or USB) with the Set Location button in the File Save submenu (**Save** > Location:).
- Use the **Left Arrow** key to move out of a folder.
- Use the **Right Arrow** key to move inside of a highlighted folder.
- Press **Esc** to return to the previous screen.

10-3 File Types

Filename extensions that are used in the Site Master S820E:

- *.dat for Cable and Antenna measurement files
- *.hipm for High Accuracy Power Meter measurement files
- *.svna for VNA mode measurement files
- *.s2p (SnP) for VNA mode measurement files:
 - Real/Imag
 - Lin Mag/Phase
 - Log Mag/Phase
- *.ett for easyTest files
- *.stp for Setup files
- *.png for Screen Shot files
- *.csv text file with Comma Separated Values (CSV), for saving formatted data
- *.txt for saving Status information and Self Test results
- *.vipi for Video Inspection Probe measurement files

S2P is a standard ASCII text file format that is used for scattering parameters from a 2-Port measurement. This is a subset of SnP (where n equals the number of ports). An S2P file can be used as input for signal analysis.

Note

The CSV and Text files contain setup information and final formatted data that are shown on the instrument display screen. This file information includes any post-processing that was done on the data (smoothing, trace math, and so forth). These files contain the data for any traces that are displayed, including the memory traces. They also contain the markers that are turned on when the file is saved.

10-4 Save Files

Press the **File** (7) key on the numeric keypad to display the **File** main menu, then press **Save** or the  icon in the System Function Tool Bar at the top of the display.

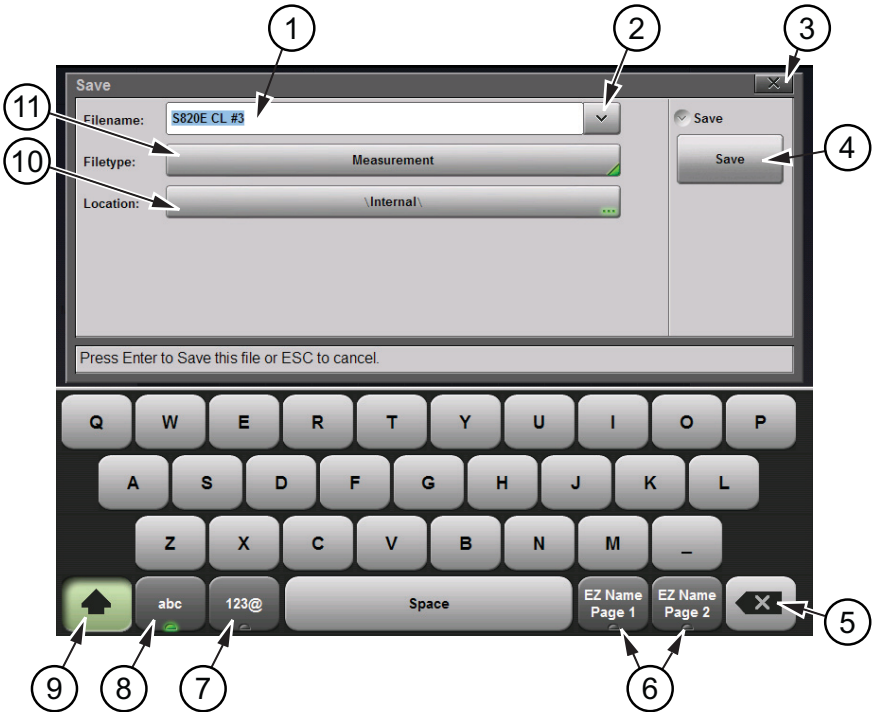

- | | |
|----|---|
| 1. | Current Filename (ready for editing). Refer to “Choose the File Name” on page 10-9. |
| 2. | Recent Filenames (tap to view) |
| 3. | Close Dialog Box Without Saving File |
| 4. | Save File and Close |
| 5. | Delete Filename Character Key |
| 6. | EZ Name Keys. Refer to “EZ Name Matrix” on page 10-10. |
| 7. | Symbols and Numbers Keyboard |
| 8. | Letters Keyboard |
| 9. | Shift Key |

Figure 10-1. Save Dialog Box (1 of 2)

10.	Current Save Location. Tap to Change. Refer to “Set the Save Location” on page 10-5.
11.	Current Filetype. Tap to Change. Refer to “Set the File Type” on page 10-8.

Figure 10-1. Save Dialog Box (2 of 2)

Set the Save Location

Navigate within a location in Internal Memory or a USB flash drive, then press **Set Location**. The selected save location is displayed. In [Figure 10-2](#) the bread crumb shows that pressing **Set Location** will set the location to the root level of the internal memory (even if a subfolder is highlighted).

1. Press the **Location** button shown in [Figure 10-1](#) and select where to save the file. The default location is the Site Master internal memory ([Figure 10-2](#)).

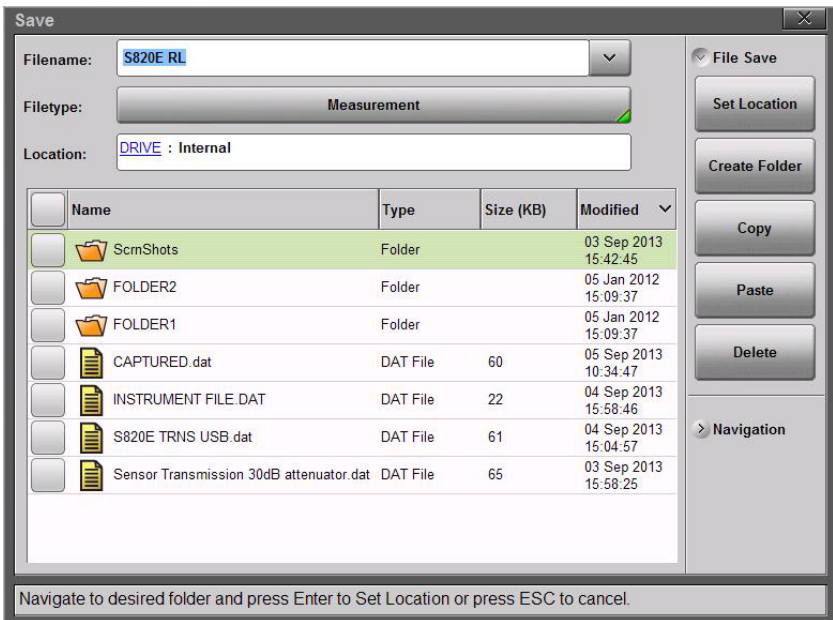

Figure 10-2. Default Save Location

- Files can also be saved to an external USB flash drive. Insert a USB flash drive into the Site Master USB Type-A connector (Figure 2-1) and double tap on DRIVE: (Figure 10-2) to display the top navigation level showing both the internal memory and the external USB drive (Figure 10-3 on page 10-6).

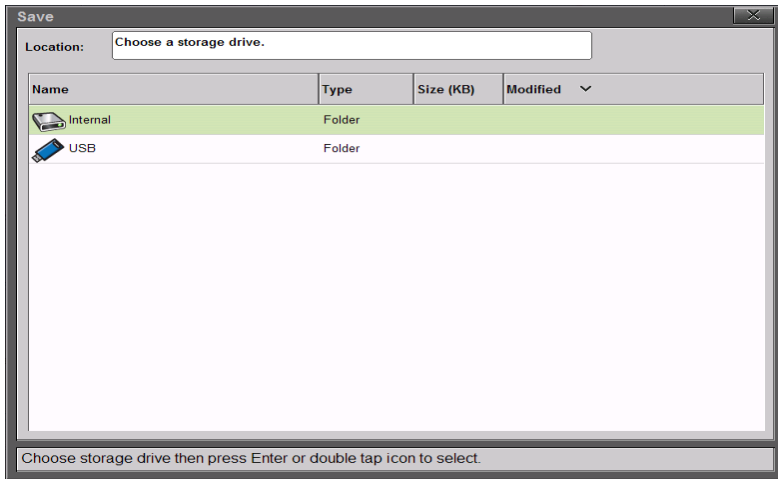

Figure 10-3. Choose a Storage Drive

- Double tap on the USB flash drive icon and, if desired, create folders for the saved files. Press the **Set Location** button. The location for saving is now set to the external USB drive (\USB). Refer to Figure 10-4 on page 10-7.

Double Tap Alternative

An alternative method is available for double tapping in order to move in and out of folders and directories. Use the **Left** and **Right Arrow** keys on the instrument keypad. The **Right Arrow** key moves into the directory or folder, and the **Left Arrow** key moves out of the directory or folder. The **Up** and **Down Arrow** keys may be used to scroll through multiple files within any folder.

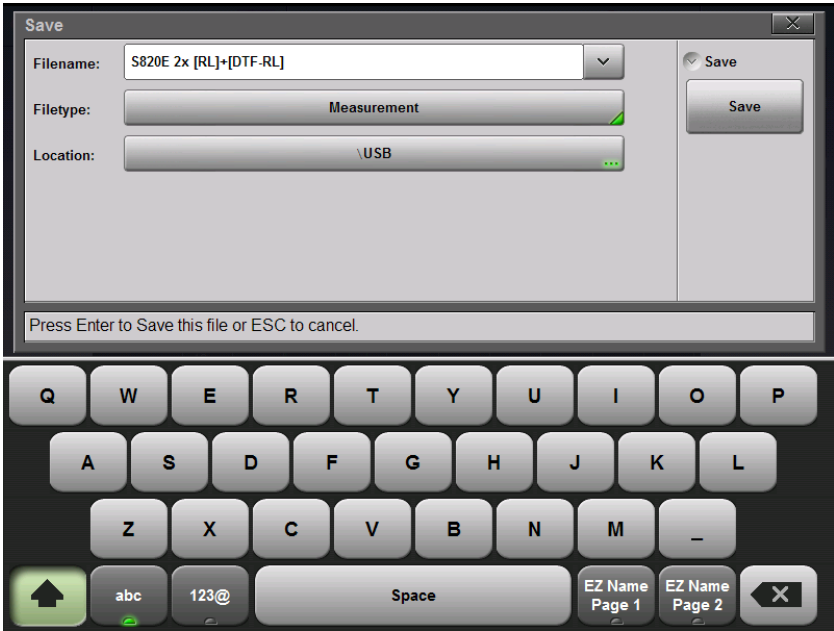

Figure 10-4. Save Location is set to root directory in External USB Drive

Note

Folders and subfolders can be created and renamed in either storage location.

Set the File Type

The next step after setting the save location is choosing the file type to save.

In the Save dialog box (**File (7) > Save**), press **Filetype**, then select **Measurement**, **Setup**, or **ScreenShot** ([Figure 10-5](#)). The default file type is **Measurement**.

Measurement (.dat) is the default setting. Measurement files are typically saved for reporting and monitoring. Measurement files contain all the measurement data and setup data described below (except for the calibration coefficients). They can be recalled and viewed on the instrument and a static trace or measurement can be viewed and edited on a PC with **Line Sweep Tools** ([Chapter 13](#)).

Note In Video Inspection Probe mode, the Measurement file type (.vipi extension) saves the captured VIP image and analysis results. Refer to [Chapter 15, “Video Inspection Probe \(VIP\)”](#).

Setup (.stp) files are typically saved for later recall. Saving setup files helps ensure consistent instrument setup when making future measurements. Setup files contain basic instrument setup details including: measurement type, frequency span, distance span, DTF setup, amplitude setting, markers, limit line, calibration coefficients, and additional instrument settings (data points, run/hold status and RF immunity status).

Screen shot (.png) files are typically saved for reporting. The files contain a screen capture of the current display. The “look” of the file is set using the **“Display/Audio Menu”** on [page 11-21](#).

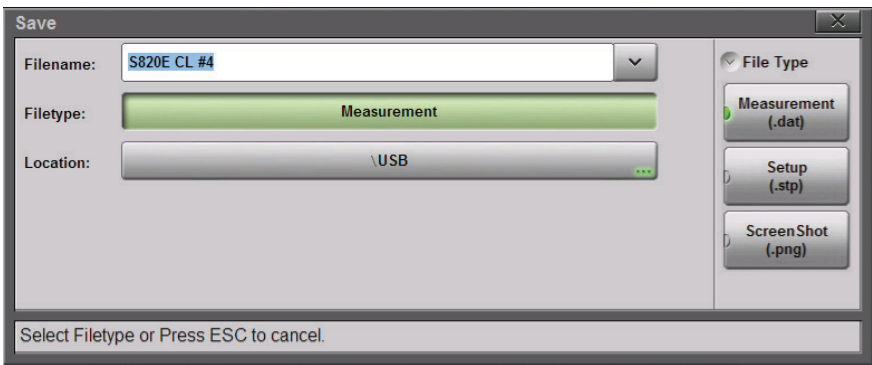

Figure 10-5. Set the File Type

Choose the File Name

Default Name

The Site Master adds a default file name based on the instrument model and current measurement type.

RL = Return Loss

DTF-RL = Distance to Fault Return Loss

CL = Cable Loss

VSWR = Voltage Standing Wave Ratio

DTF-VSWR = Distance to Fault Voltage Standing Wave Ratio

TR2P = Transmission (2-Port)

TRES = Transmission (Ext. Sensor)

SC = Smith Chart

PH = 1-Port Phase



HiPM = High Accuracy Power Meter

Additional measurements of the same type will have a number appended to the file name (#1, #2, and so forth).

Press **Save** or **Enter** to save the file.

Note	A Filetype extension (Figure 10-5) is automatically added to the Filename based on the chosen Filetype.
-------------	---

Custom Name

Replace the default file name using the on screen keyboard or the number keypad. The highlighted filename (blue background) is ready for replacement. Tap the  key (or the **Shift** button on the instrument keypad) for UPPERCASE letters. The  key (row 7 in [Figure 10-1 on page 10-4](#)) will display commonly used symbols, delimiters, and numbers.

Use the **Left** or **Right Arrow** keys to move the text cursor within the filename characters. The  key deletes the character directly to the left of the cursor.

EZ Name Matrix

The EZ Name Matrix buttons display the EZ Name Grids which allows contractors and field personnel to save time entering filenames when they are making measurements.

Often carriers require filenames to be reported in special conventions including site number, sector information, color coding, measurement type, termination device, and frequency information. Set up the buttons in this matrix to quickly enter the required file name.

Using the touchscreen, in the File Mgmt menu, press Rename. Then press either EZ Name Page 1 or EZ Name Page 2 (shown in [Figure 10-6 on page 10-11](#)) to open the EZ Name matrix keyboards.

The EZ Name Separator Keys shown in [Figure 10-6](#) can be used to automatically insert a separator each time a Matrix button is pressed.

The top button toggles the separator on or off. The button below allows you to choose between using a dash “-” or an underscore “_” as the separator.

Note **Naming Examples:**

Separator Off:

Site AAlphaColor CodeRLShort700

Separator On:

Site A-Alpha-Color Code-RL-Short-700

or

Site A_Alpha_Color Code_RL_Short_700

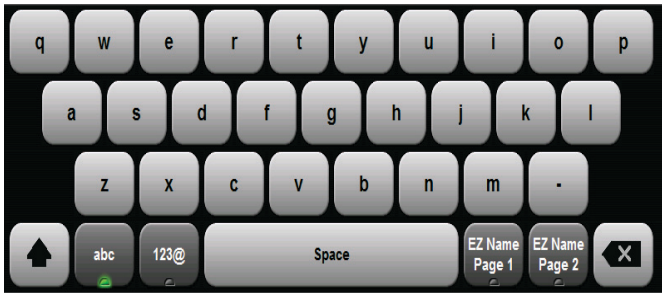

EZ Name Buttons

EZ Name Page 1 Matrix



EZ Name Button Separator Keys

EZ Name Page 2 Matrix

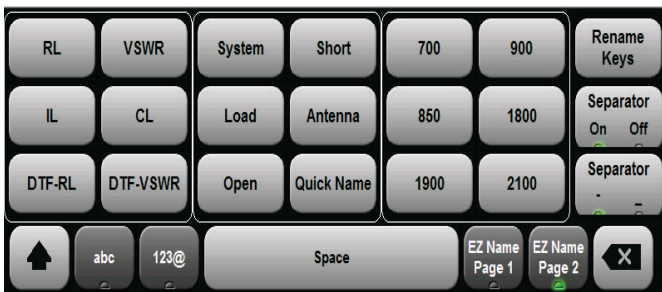

Figure 10-6. EZ Name Matrix

Change Default Matrix Names

1. Press the Rename Keys button shown in [Figure 10-6](#) (upper-right button in either EZ Name matrix). Note that the name of the key changes to **Cancel**. Choose (press) the matrix button that you want to rename. The current name, such as **Color Code**, is displayed in the upper-left corner above the letter keys (see [Figure 10-7](#)). Type the desired name, which appears in the upper-left corner as you type. Then press **Done**. In [Figure 10-8](#) the upper-right button (**Color Code**) was selected and renamed **GREEN**. See the original names in [Figure 10-6](#).

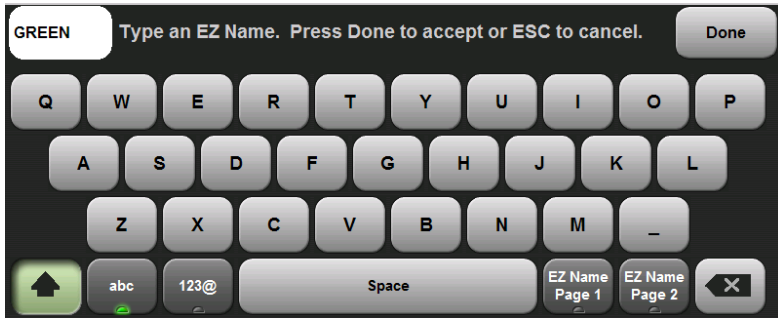

Figure 10-7. Renaming a Matrix Key

2. When you press **Done**, the new name is displayed in the Matrix ([Figure 10-8](#)).



Figure 10-8. Renamed Matrix Key

3. Continue with renaming additional matrix keys as desired.

After the keys have been labeled as needed, they can be used to quickly create filenames with the required file naming conventions. Select the type of file and press Enter to save the file.

Note

A user-defined EZ Name matrix is saved in internal memory and will be available for future use until the custom file is deleted, or a Master Reset is performed. Refer to the [“Preset Menu” on page 11-27](#) for additional information.

Saving

1. After setting the location and file type, press **Save**.
2. The selected location and file type are now set for saving additional files.

Note

Anritsu recommends creating a new folder for each test site and saving all of the measurements for that specific site in the created folder.

The Site Master offers an EZ Name grid for quickly naming measurement files. Refer to [“EZ Name Matrix” on page 10-10](#) for additional information.

Often used setup files can also be created and saved in a user-defined “Setup” folder.

3. If a file with the same name already exists at the save location, then a warning is displayed. You are required to chose whether to overwrite the existing file. The default is No

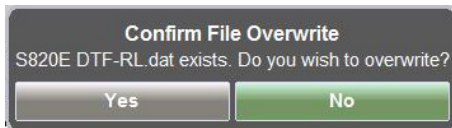

Figure 10-9. Confirm File Overwrite

Additional Menus

Pressing the Location: button (in the Save menu) opens the Save dialog box ([Figure 10-4](#)) and displays the File Save and Navigation submenus. These functions are described in [“File Mgmt Menu” on page 10-34](#).

10-5 Recall Files

The Recall menu enables you to recall a measurement file or a setup file from internal memory or an external USB drive. Recall also allows the user to preview saved image files. Refer to the [“Recall Menu” on page 10-32](#) for additional information.

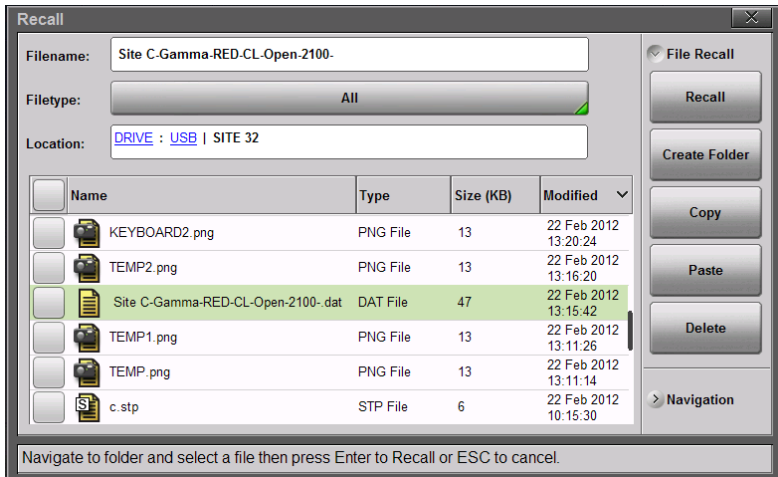

Figure 10-10. Recall Menu

Note

Recalling a measurement or setup may change the current instrument settings, and may turn off any current calibration correction. Consider saving the current setup before recalling a file.

Only one file (of any type) can be recalled at a time.

Recall a Measurement

Press the **File (1)** keypad menu key to display the File menu, then press **Recall** to open the Recall dialog box. Select the measurement file (.dat extension) using the touchscreen, rotary knob, or the **Up/Down** arrow keys, then press **Enter** (or the Recall submenu key).

Recalled measurements are first displayed on the Site Master as a preview. **Figure 10-11** shows the preview of a saved cable loss measurement, S820E CL #1.dat.

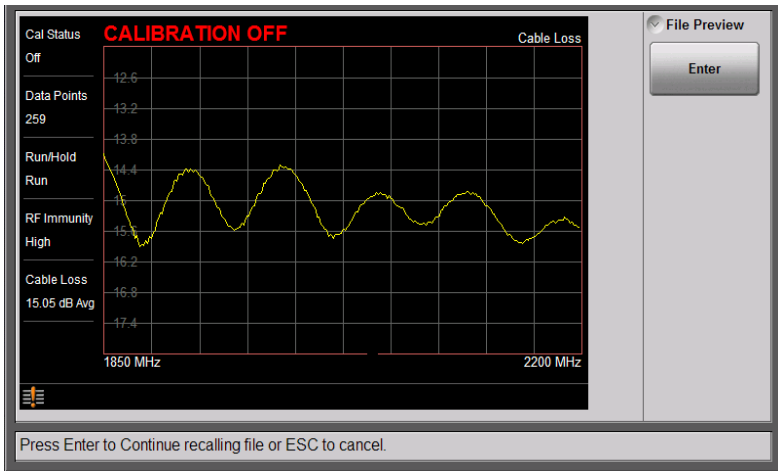

Figure 10-11. Preview of a Recalled Measurement

Press **Enter** to complete recalling the measurement (**Figure 10-12**) or press **Esc** to cancel the recall and return to the File Recall menu.

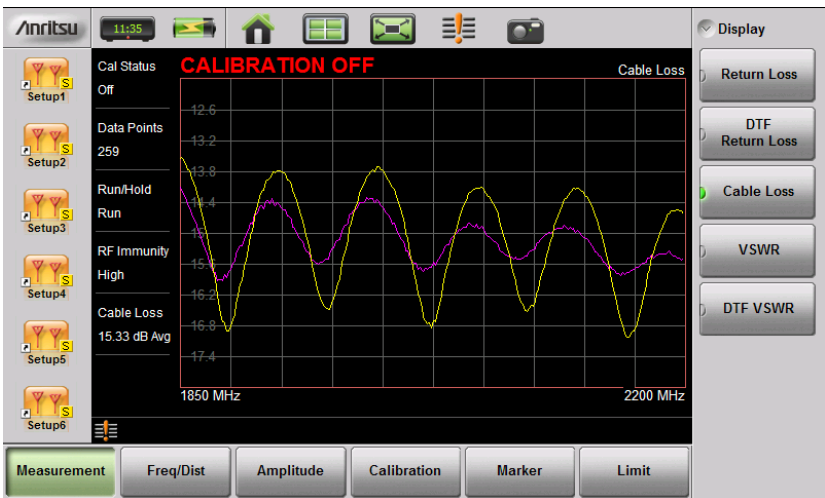

Figure 10-12. Recalled Measurement and Active Trace

The recalled measurement is the purple trace and is overlaid on the current active (yellow) trace. In [Figure 10-12](#), the recalled measurement is used to compare the cable loss of two different RF cables. Recalled measurements are automatically saved to trace memory for use in trace math functions. To see the recalled measurement and the current measurement simultaneously, select Trace & Memory in the Trace Display submenu. Refer to [“Trace” on page 3-47](#).

Recall a Setup

Press the **File** (1) keypad menu key to display the File menu, then press **Recall**. In the Recall dialog box, confirm that the Filetype is **Setup** or **All**. Select the setup file (.stp extension) with the touchscreen, rotary knob, or **Up/Down** arrow keys, then press **Enter** (or the Recall submenu key).

Setup files contain basic instrument setup details including: measurement type, frequency span, distance span, DTF setup, amplitude setting, markers, limit line, calibration coefficients, and additional instrument settings (data points, run/hold status and RF immunity status). Recalling a setup may change the current settings.

Recall/Preview a Screen Shot

Press **File** (1), then press the **Recall** submenu key. Confirm that the Filetype is **Screen Shot** or **All**. Select the file (.png extension) with the touchscreen, rotary knob, or the **Up/Down** arrow keys, then press **Enter**.

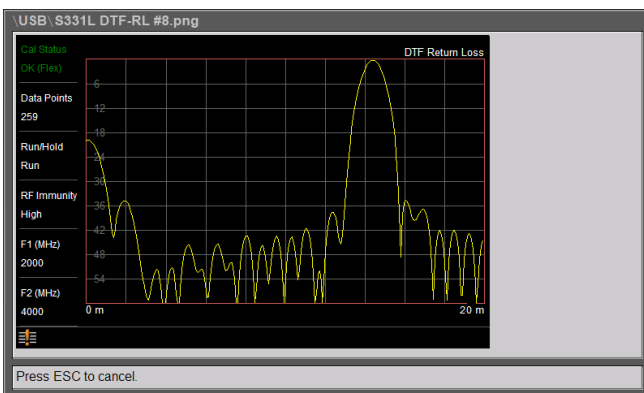

Figure 10-13. Preview of a Recalled ScreenShot

Press **ESC** to return to the File Recall menu.

Recall a VIP Measurement (VIP Mode Only)

In Video Inspection Probe mode, press the Save/Recall main menu key, then press Recall. Confirm that the Filetype is Measurement or All. See [Figure 10-14](#).

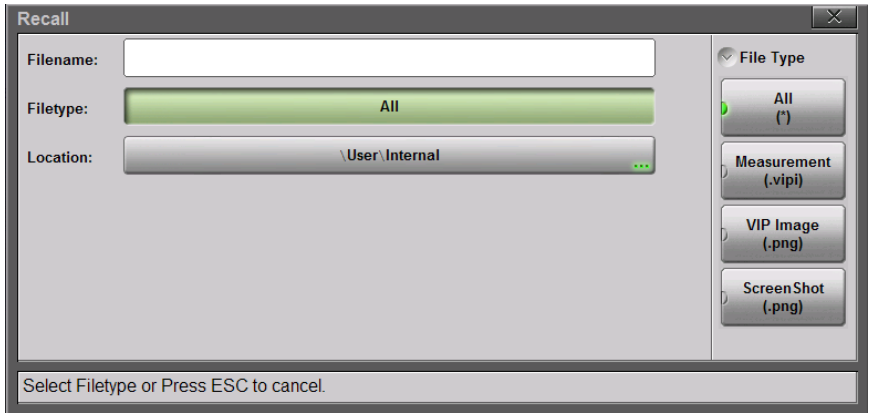

Figure 10-14. Recall File Type (VIP Mode)

Select the file (.vipi extension) with the touchscreen, rotary knob, or the **Up/Down** arrow keys, then press **Enter** (or the Recall submenu key).

Measurement Captured
Zoom (100%)

Tip Type
2.5APC_M

Test Profile
SM PC > 45

Analyze
Auto (OFF)

Filename
Auto (OFF)

File Loaded from: S331L VIP.vipi

VIP (G0306A)

Zone Name	Diameter (µm)	Defects	Defect Count	Area (µ²m)	Scratch	Scratch Count
Core	25	PASS	0	0.00	PASS	0
Cladding	120	PASS	0	0.00	PASS	0
Adhesive	130	PASS	0	0.00	PASS	0
Contact	250	PASS	1	2.90	PASS	0

PASS

Figure 10-15. Recalled VIP Measurement File

Recall a VIP Image (VIP Mode Only)

In VIP mode, press the **Save/Recall** main menu key, then press **Recall**. Confirm that the Filetype is **VIP Image** or **All**. Select the file (.png extension) with the touchscreen, rotary knob, or the **Up/Down** arrow keys, then press **Enter** (or the Recall submenu key).



Figure 10-16.Recalled VIP Image File

A recalled VIP image can be analyzed and the results included in a VIP report. Refer to [“Measurement Menu” on page 15-13](#).

10-6 Rename Files

Press the File menu then the File Mgmt submenu key. Select (green background) the file to rename. Then, under File Mgmt, tap the Rename button (Figure 10-17).

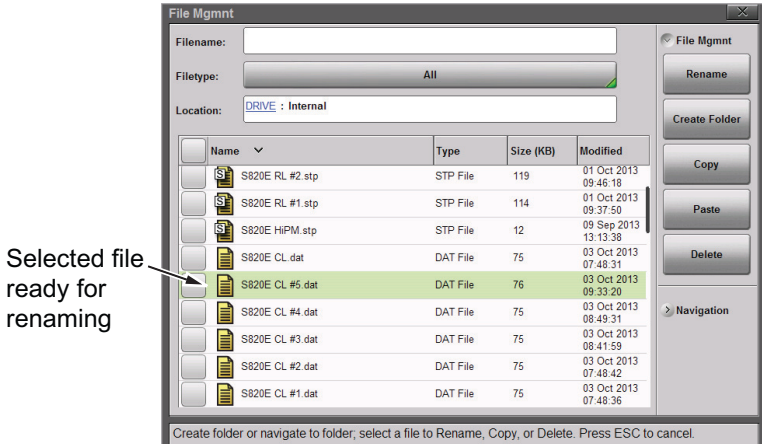

Figure 10-17. Select a File to Rename

Use the on-screen keyboard, the number keypad, or the EZ Name grid to rename the file. In this example, we change the short measurement name (that is automatically created by the Site Master) to a longer name typical of carrier requirement (Figure 10-18). Use the “EZ Name Matrix” on page 10-10 for this type of renaming.

Rename file from: S820E CL #5 .dat
to: Site B-Gamma-RED-DTF-CL-Load-900- .dat.

Same file
after renaming

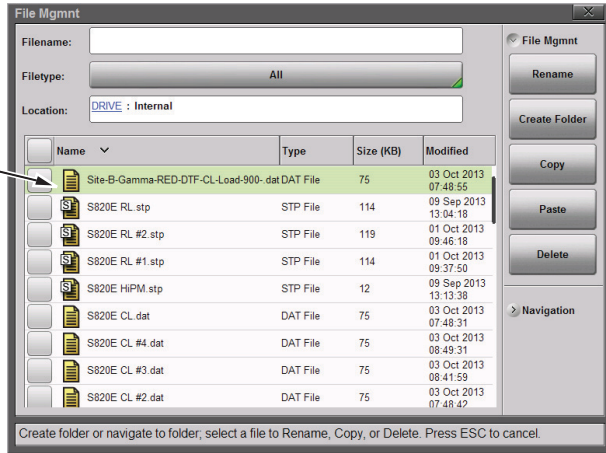

Figure 10-18. Renamed File (Same Modification Date)

10-7 Copy and Paste Files

The Site Master S820E allows multiple files and folder to be copied at the same time. The example below describes copying several files and folders from internal memory to an external flash drive.

1. From the **File** main menu, press the File Mgmt submenu key. Double tap on the Internal memory icon (Figure 10-3 on page 10-6)
2. Select the files and folders to copy. Use the check box column to select multiple files and/or multiple folders (Figure 10-19). Use the Navigation submenu buttons as needed to move through a long list of files.

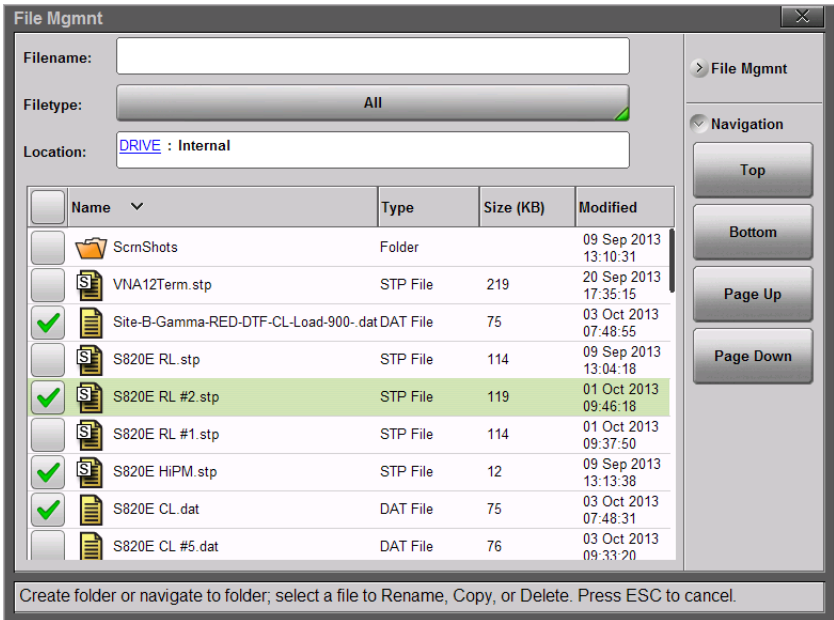

Figure 10-19. Selecting Multiple Items to Copy

3. Under File Mgmt select Copy.
4. Insert a USB flash drive into one of the Site Master's USB ports.
5. Press the **Left Arrow** key or double tap on [Drive](#) to display the external USB drive icon. Double tap on the USB drive icon.

6. Select **Paste** to copy the selected files and folders from Internal memory to the USB drive (Figure 10-21) or to **Move** the files (which copies the files to the new destination and then deletes them from the original destination). The choice of copy or move is made using the message box that appears after the Paste button is pressed (Figure 10-20).



Figure 10-20. Paste Selection Dialog Box

Note Copy, Paste, Delete, and Create Folder buttons are duplicated under File Mgmt, Recall, and Save submenus for your convenience.

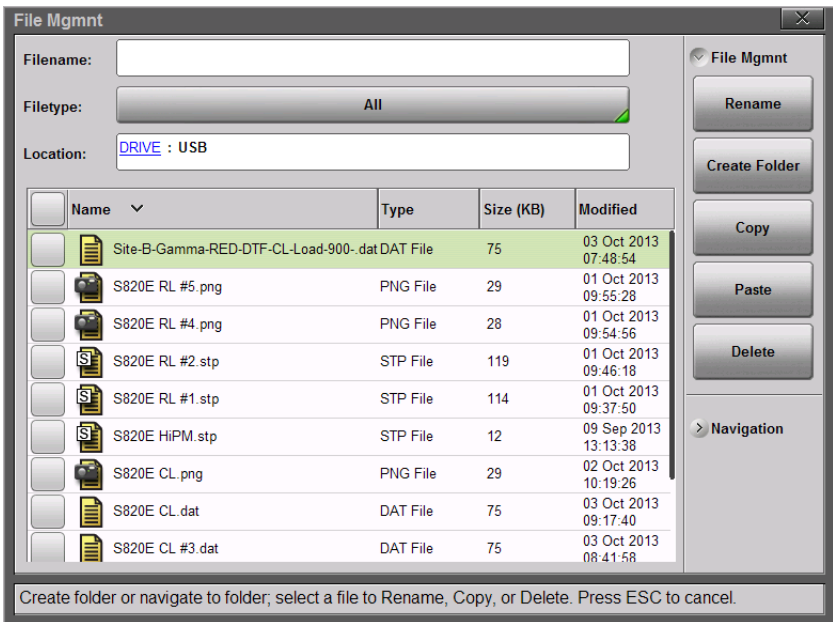

Figure 10-21. Files Pasted to the External USB Drive

7. If files with the same name already exist at the paste location, then a warning is displayed. You are required to select whether to overwrite some or all of the files. The default is No.

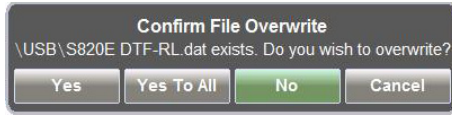

Figure 10-22. Paste Warning

8. After pasting is completed the USB drive can be removed. No type of "Eject" command is required to remove the drive.

Note Files are removed from Site Master clipboard memory after pasting. The Site Master does not allow concurrent pasting.

10-8 Delete Files

The Site Master S820E allows multiple files and folder to be deleted at the same time from either internal memory or an external USB drive.

Warning The Delete button (after user confirmation) will delete all selected files, even files not created by the Site Master. Use caution when deleting files. After being deleted, files are not recoverable.

The example below describes deleting all the files from a folder in internal memory.

1. From the **File** main menu, press the File Mgmt submenu key. Double tap on the Internal memory icon ([Figure 10-3 on page 10-6](#))
2. Select the files and folders to delete. If desired, use the check box column header to select all of the files in the current location or folder ([Figure 10-23](#)). Use the Navigation submenu buttons as needed to move through a long list of files.

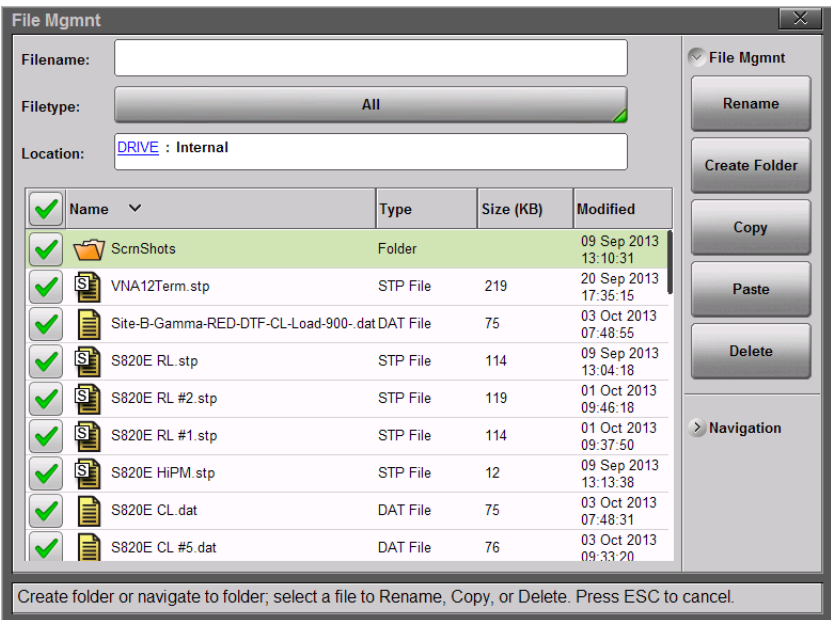

Figure 10-23. Selecting Multiple Items to Delete

3. Under File Mgmt select Delete. Confirm that you want the files deleted by selecting Yes. (The default selection is No.)

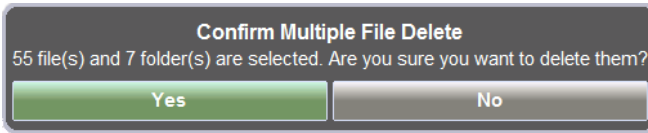

Figure 10-24. Confirm File Deletion

10-9 Create a Folder

The Site Master S820E allows folders to be created in either internal memory or an external USB drive. Multiple subfolders can also be created. This functionality is helpful in organizing traces by date, technician, carrier, and/or site location.

1. From the **File** main menu, press the File Mgmt submenu key.
2. Navigate to the location where the new folder should be created.
3. Press the Create Folder button.
4. Name the folder using the on-screen keyboard. Refer to “[Choose the File Name](#)” on page 10-9 for additional information ([Figure 10-25](#)).

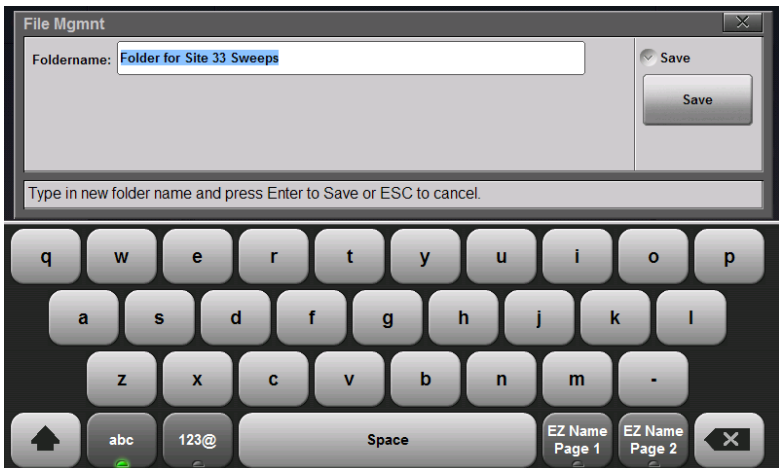

Figure 10-25. Name the Created Folder

5. Press **Save** or **Enter** to complete.

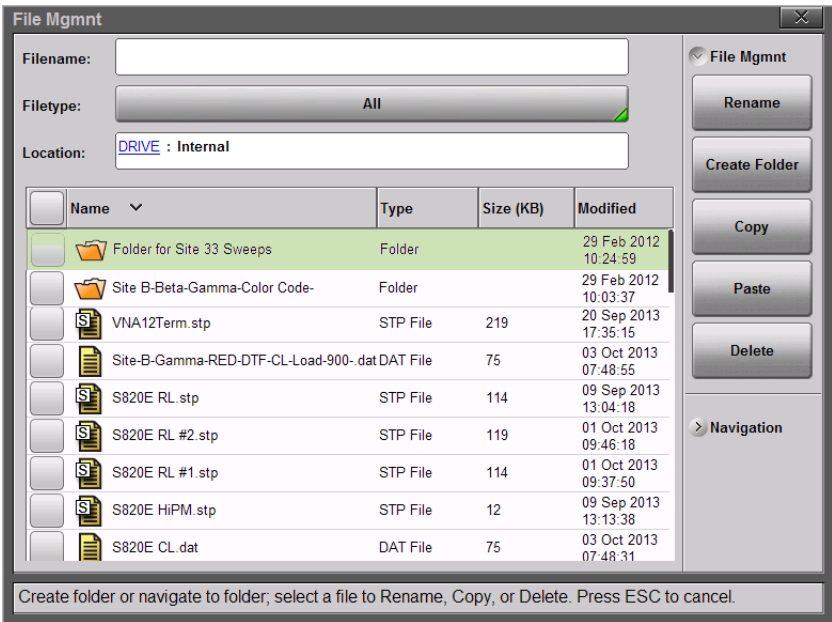

Figure 10-26. New Folder Created

Note

Creating a new folder does not also set the folder as the current save location (displayed in the bread crumb). Refer to [“Set the Save Location”](#) on page 10-5 for additional information.

10-10 File Menu Overview

Figure 10-27 shows the map of the File menus and submenus. The submenus are listed in the order they appear on the display from top to bottom under each main menu. The selectable file types are different in VIP Mode (see Figure 15-7 on page 15-8).

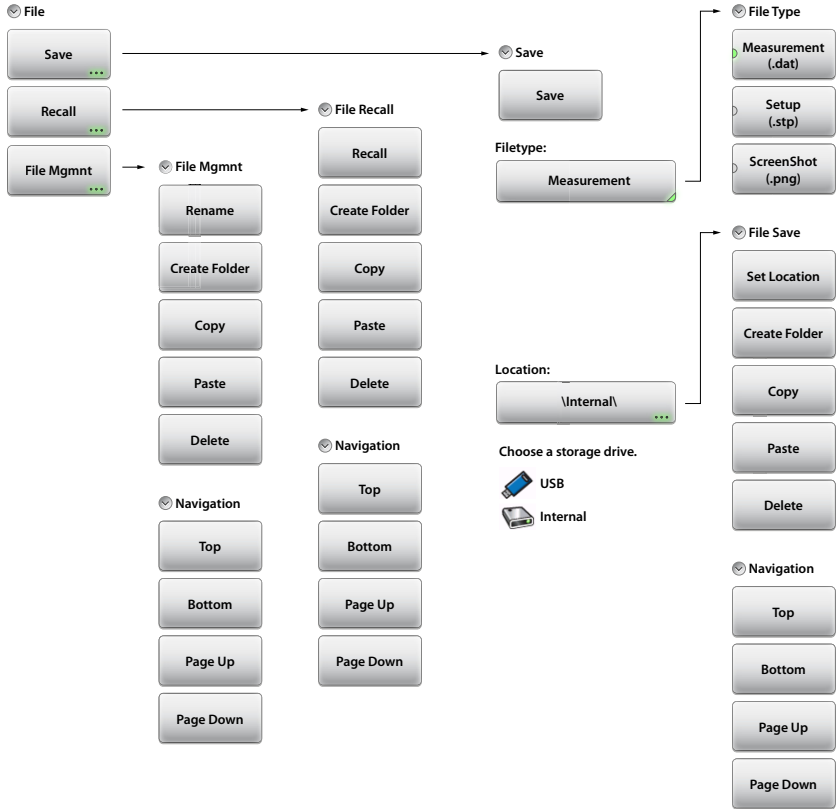

Figure 10-27. File Menu Keys

10-11 File Menu

Key Sequence: **File (7)**

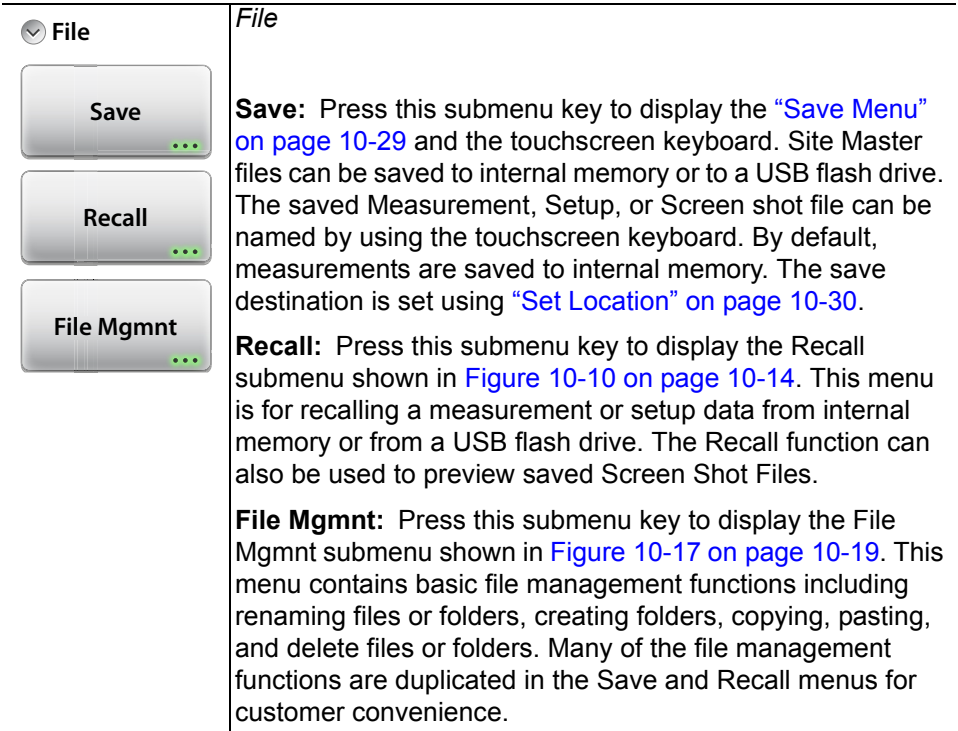

Figure 10-28.File Menu

Save Menu

Key Sequence: **File (7)** > Save





<p>Save</p> 	<p><i>File > Save</i></p> <p>Save: Press this submenu key to display the “Save Dialog Box” on page 10-4. Site Master files can be saved to internal memory or to a USB flash drive. The saved Measurement, Setup, or Screen shot file can be named by using the touchscreen keyboard. By default, measurements are saved to internal memory. The save destination is set using the Set Location submenu key. Refer to “Set the Save Location” on page 10-5.</p>
<p>Filetype:</p> <p>Measurement</p> 	<p>By default, the Filetype is Measurement. Press this button to display the Filetype menu.</p>
<p>File Type</p> <p>Measurement (.dat)</p> 	<p><i>Save > Filetype</i></p> <p>Filetype: Press this button to display the File Type menu:</p>
<p>Setup (.stp)</p> 	<ul style="list-style-type: none"> Measurement (.dat) Setup (.stp) ScreenShot (.png) S2P (.s2p) Text (.txt) CSV (.csv)
<p>ScreenShot (.png)</p> 	<p>The selectable file types are different in Video Inspection Probe (VIP) mode. See Figure 15-7 on page 15-8.</p>

Figure 10-29. Save Menu (1 of 3)

Save Menu (continued)

<p>Location:</p> <div style="border: 1px solid gray; padding: 5px; margin-bottom: 10px;"> \Internal\ </div> <p>Choose a storage drive.</p> <div style="display: flex; align-items: center; margin-bottom: 10px;"> USB </div> <div style="display: flex; align-items: center; margin-bottom: 10px;"> Internal </div> <p><input checked="" type="checkbox"/> File Save</p> <div style="border: 1px solid gray; padding: 10px; margin-bottom: 10px; text-align: center;"> Set Location </div> <div style="border: 1px solid gray; padding: 10px; margin-bottom: 10px; text-align: center;"> Create Folder </div> <div style="border: 1px solid gray; padding: 10px; margin-bottom: 10px; text-align: center;"> Copy </div> <div style="border: 1px solid gray; padding: 10px; margin-bottom: 10px; text-align: center;"> Paste </div> <div style="border: 1px solid gray; padding: 10px; margin-bottom: 10px; text-align: center;"> Delete </div>	<p><i>File Save</i></p> <p>Location: Displays the current save location. Press this key to change the location where the Site Master saves files. Select folders or drives with the Arrow keys, the rotary knob, or the touchscreen. Refer to Figure 10-26 on page 10-26.</p> <p>Set Location: Press this submenu key to set the current location for saving files and return to the “Save Menu” on page 10-29.</p> <p>Create Folder: Press this submenu key to create a new folder in the highlighted location or folder. Name the new folder with the onscreen keyboard and press Save.</p> <p>Copy: Press this submenu key to copy the files and/or folders that are selected and place them in memory for pasting. Only files or folders from one location can be copied at a time. Use the check box column to select multiple items to copy.</p> <p>Paste: Press this submenu key to paste the selected files and/or folders from memory to the current location. Use the check-box column to select multiple items to copy (press to check, press again to uncheck). After files are pasted, they are no longer in memory. If files or folders with the same name already exist in the location, then the Site Master will ask you to confirm that the existing files should be overwritten.</p> <p>Delete: Press this submenu key to delete the files and/or folders that are selected. Only files or folders from one location can be deleted at a time. Use the check-box column to select multiple items to delete.</p> <p>Caution: After an item is deleted, it cannot be recovered.</p>
--	---

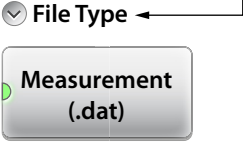
Figure 10-30. Save Menu (2 of 3)

Save Menu (continued)

<input checked="" type="checkbox"/> Save	<i>File > Save</i>
Location:	
<input checked="" type="checkbox"/> File Save	
<input checked="" type="checkbox"/> Navigation	<i>Navigation</i>
<div style="border: 1px solid gray; padding: 5px; text-align: center;">Top</div>	Top: Press this submenu key to display the top of the list.
<div style="border: 1px solid gray; padding: 5px; text-align: center;">Bottom</div>	Bottom: Press this submenu key to display the bottom of the list.
<div style="border: 1px solid gray; padding: 5px; text-align: center;">Page Up</div>	Page Up: Press this submenu key to page upward through the list.
<div style="border: 1px solid gray; padding: 5px; text-align: center;">Page Down</div>	Page Down: Press this submenu key to page downward through the list.

Figure 10-31. Save Menu (3 of 3)

Recall Menu

Key Sequence: **File (7)** > Recall

<p>⌵ File Recall</p> <p>Recall</p> <p>Create Folder</p> <p>Copy</p> <p>Paste</p> <p>Delete</p>	<p><i>File Recall</i></p> <p>Recall: Press this submenu key to recall the selected file. Measurements, setups, or screen shots can be recalled.</p> <p>Recalled measurements are first displayed on the Site Master as a preview. Press Enter to complete recalling the measurement or press Esc to cancel the recall and return to the File Recall menu. Refer to “Recall Files” on page 10-14 for additional information.</p> <p>Recalled setups change the current setup, including measurement type, frequency/distance, amplitude, marker, and limit data.</p> <p>Recalled screen shots are previewed on the Site Master. Press Esc to return to the File Recall menu.</p> <p>Create Folder: Press this submenu key to create a new folder in the highlighted location or folder. Name the new folder with the onscreen keyboard and press Save.</p> <p>Copy: Press this submenu key to copy the files or folders (or both) that are selected and place them into memory for pasting. Only files or folders from one location can be copied at a time. Use the check-box column to select multiple items to copy.</p> <p>Paste: Press this submenu key to paste the selected files or folders (or both) from memory to the current location. Use the check-box column to select multiple items to copy. After files are pasted, they are no longer in memory. If files or folders with the same name already exist in the location, then the Site Master will confirm that the existing files should be overwritten.</p> <p>Delete: Press this submenu key to delete the files or folders (or both) that are selected. Only files or folders from one location can be deleted at a time. Use the check-box column to select multiple items to delete.</p> <p>After an item is deleted it cannot be recovered!</p>
<p>⌵ Navigation</p>	

Figure 10-32. Recall Menu (1 of 2)

Recall Menu (continued)





 File Recall	<i>File Recall</i>
 Navigation	<i>Navigation</i>
	Top: Press this key to navigate to the top item of the current location.
	Bottom: Press this key to navigate to the bottom item of the current location.
	Page Up: Moves up one screen of items (7 rows) in the current location.
	Page Down: Moves down one screen of items (7 rows) in the current location.

Figure 10-33. Recall Menu (2 of 2)

File Mgmt Menu

Key Sequence: **File (7)** > File Mgmt

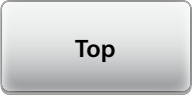
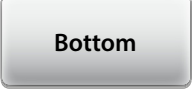
File Mgmt

Rename

File Mgmt

Rename: Press this submenu key to rename a selected file or folder. The current name is displayed for editing or appending. Press Save or **Enter** to complete.

Create Folder

Create Folder: Press this submenu key to create a new folder in the highlighted location or folder. Name the new folder with the onscreen keyboard and press **Save**.

Copy

Copy: Press this submenu key to copy the files and/or folders that are selected and place them in memory for pasting. Only files or folders from one location can be copied at a time. Use the check-box column to select multiple items to copy.

Paste

Paste: Press this submenu key to paste the selected files and/or folders from memory to the current location. Use the check box column to select multiple items to copy. After files are pasted, they are no longer in memory. If files or folders with the same name already exist in the location, then the Site Master will confirm that the existing files should be overwritten.

Delete

Delete: Press this submenu key to delete the files and/or folders that are selected. Only files or folders from one location can be deleted at a time. Use the check-box column to select multiple items to delete.

Navigation

Top

Caution: After a file is deleted, it cannot be recovered!

Navigation

Bottom

Top: Press this key to navigate to the top item of the current location.

Bottom: Press this key to navigate to the bottom item of the current location.

Page Up

Page Up: Moves up one screen of items (7 rows) in the current location.

Page Down

Page Down: Moves down one screen of items (7 rows) in the current location.

Figure 10-34. File Management Menu

Chapter 11 — System Operations

11-1 Introduction

This chapter describes various instrument management features of the Site Master.

Note

The **Save** menu and **File** menu are discussed in [Chapter 10](#). The other keyboard menu keys are measurement mode specific and discussed in [Chapter 3, “Cable and Antenna Measurements”](#) or [Chapter 9, “High Accuracy Power Meter”](#).

Note

Screen images in this User Guide are illustrations of typical instrument features. Some images may include instruments other than the Site Master S820E. Traces and other display features may differ from the screen displays of your instrument.

11-2 Self Test

At power on, the Site Master runs through a series of checks to ensure that the system is functioning properly.

If the Site Master is within the operating temperature range with a charged battery and fails the self test, contact your Anritsu Service Center at <http://www.anritsu.com/contact-us>

To start a self test when the system is already powered up:

1. Press the **System (8)** key.
2. Press the Diagnostics submenu, then **Self Test**. The test starts, and the results are displayed in the dialog box (Figure 11-1).
3. Use the **Up/Down Arrow** keys, rotary knob, or on screen navigation keys to move through the test results.
4. Pressing **Save to File** automatically creates a text file of the test results. The file is saved to internal memory and labeled S820EselfTest#X.txt. The .txt file can be copied to a USB memory device (using the copy/paste function in File Mgmt) and viewed on a PC with a text reader or word processor.

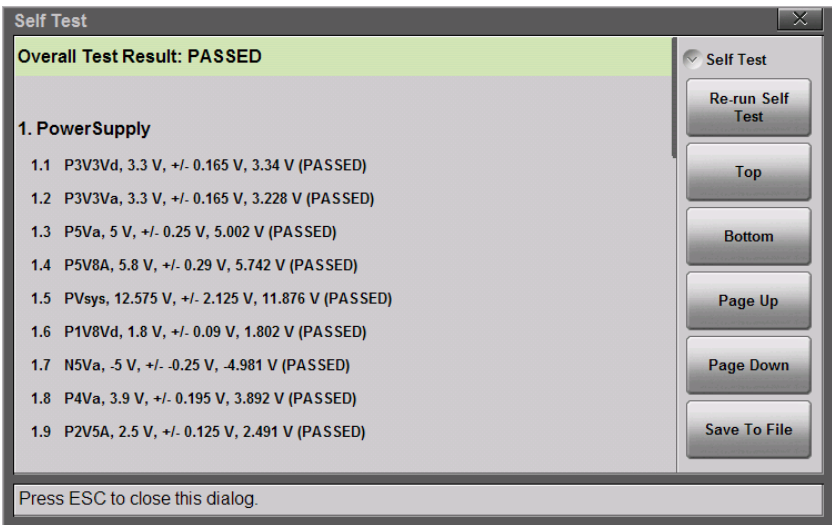

Figure 11-1. Site Master Self Test

11-3 Touchscreen Menu

Key Sequence: **Touchscreen (0)**

The touchscreen menu includes touchscreen calibration, an on screen cursor option moved by the **Arrow** keys, and the ability to lock out the touchscreen. Refer to the instructions shown in [Figure 11-2](#) and the additional details provided in [Figure 11-3](#) on page 11-4.

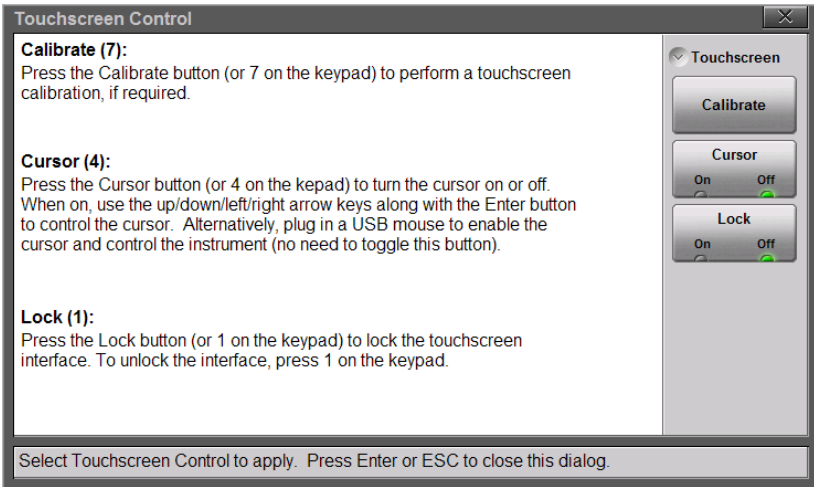
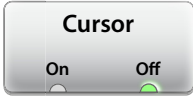



Figure 11-2. Touchscreen Control

 Touchscreen
*Touchscreen*

Calibrate: Calibrate the touchscreen if it does not seem to correctly respond to screen presses. Press Calibrate (or the **7** key on the number keypad) and follow the on-screen instructions to recalibrate the touchscreen. Use an appropriate touchscreen stylus for the most accurate results. After the calibration procedure, press **Enter** to accept, or press **Esc** to cancel the recalibration.

Cursor: The Site Master includes a screen cursor that can be controlled with the four directional **Arrow** keys (#7 in [Figure 2-5 on page 2-12](#)) above the keypad. Toggle the Touchscreen menu Cursor button to On and press one of the four directional **Arrow** keys to display the screen cursor . Control the cursor movement with the 4 **Arrow** keys, and use the **Enter** key for selection. You can also toggle the Cursor key On and Off by pressing the **4** key on the number keypad. When a message box is displayed, the **Left** and **Right Arrow** keys are used to make a selection.

Note that when the cursor is enabled, the **Enter** key is used exclusively for activating the cursor mouse-up/mouse-down key functions. All other **Enter** key functions are disabled.

Lock: When Lock is toggled to On, the touchscreen does not register user input. The touchscreen would normally be locked only if it was registering unintended input that was not resolved with a touchscreen calibration. This scenario may happen after touchscreen damage. A lock icon  is displayed at the top of the screen in the Status Tool Bar when Lock is set to On.

To unlock the touchscreen, press **Touchscreen (0)** to display the Touchscreen menu, and then press the **1** key on the number keypad.

The Site Master can continue to be used to make measurements and save files (even with touchscreen locked or damaged) by using a USB mouse or by turning on the Arrow Cursor control.

Figure 11-3. Touch Menu

11-4 Help Menu

Key Sequence: **Help** 

Pressing this [System Function Tool Bar Help](#) icon displays options to view information about the instrument status, Site Master Frequently Asked Questions (FAQ), or the Instrument User Guide ([Figure 11-4](#)).

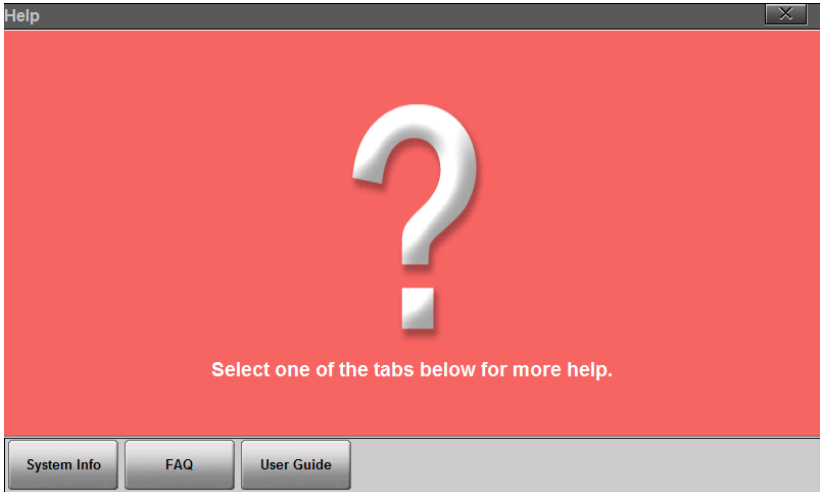
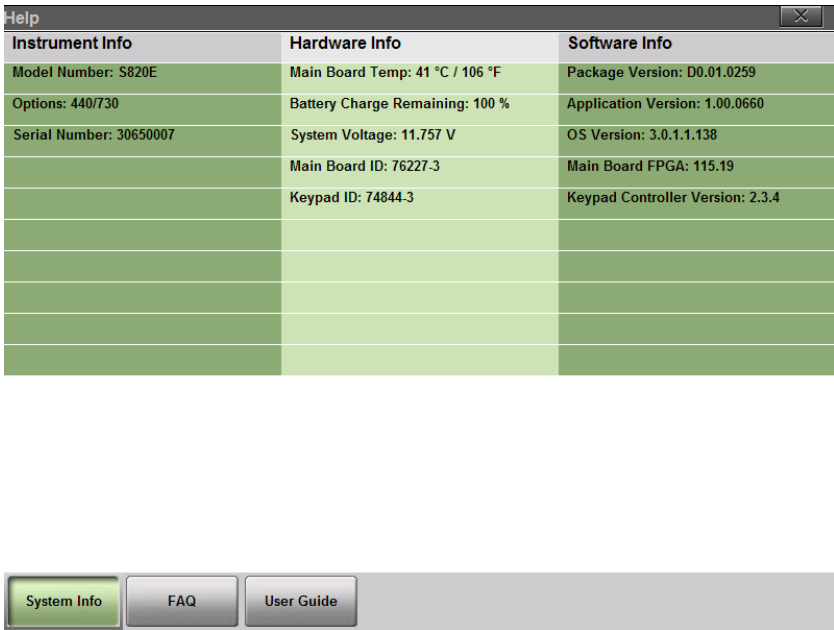

Figure 11-4. Main Help Menu Screen

Press the System Info button to display information about the current status (Figure 11-5).





Instrument Info	Hardware Info	Software Info
Model Number: S820E	Main Board Temp: 41 °C / 106 °F	Package Version: D0.01.0259
Options: 440/730	Battery Charge Remaining: 100 %	Application Version: 1.00.0660
Serial Number: 30650007	System Voltage: 11.757 V	OS Version: 3.0.1.1.138
	Main Board ID: 76227-3	Main Board FPGA: 115.19
	Keypad ID: 74844-3	Keypad Controller Version: 2.3.4

System Info FAQ User Guide

Figure 11-5. System Info

Note that Main Board Temp is displayed in the Hardware Info column. Package Version (in the Software Info column) is the current firmware version.

Press **Esc** or  to close and return to the main help menu screen. Press **Esc** or  a second time to exit the help menu.

From the main help screen, press the FAQ button to display answers to frequently asked questions including the difference between Classic and Advanced Cable-Antenna Analyzer modes (Figure 11-6).

Scroll through the .html files using the touchscreen navigation aids on the top and bottom of each screen.

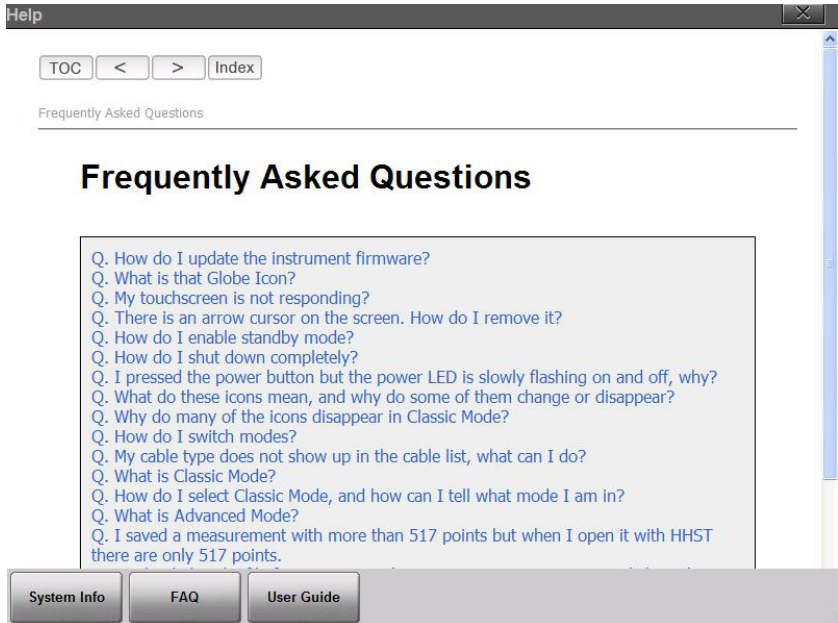





Figure 11-6. FAQ File

Press **Esc** or  to close and return to the main help menu screen. Press **Esc** or  a second time to exit the help menu.

The S820E Site Master **Arrow** keys can be used to navigate through previously viewed screens.

Note

The **Left Arrow** key () functions as the browser back button and displays the screen viewed immediately before the current screen. Pressing the **Left Arrow** key more than once continues to move back to display previously viewed screens.

The **Right Arrow** key () functions as the browser forward button. Pressing it (after having pressed the left arrow key,) returns the display towards the current screen.

From the main help screen, press the **User Guide** button to display the instrument User Guide onscreen. (See [Figure 11-7](#)).

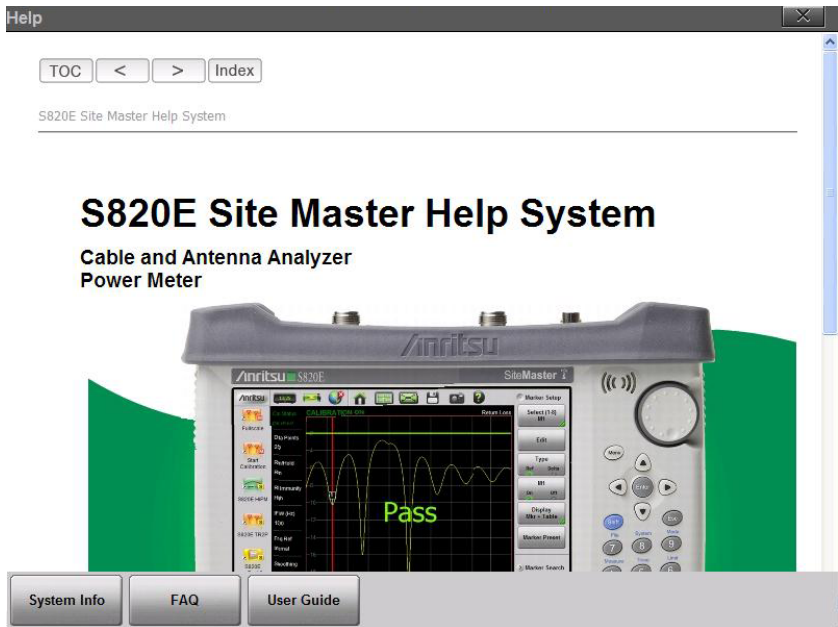



Figure 11-7. User Guide

Each page in the User Guide displays navigation buttons and bread crumbs. Links to the TOC and a compiled index are also available.

Press **Esc** or  to close and to return to the main help menu screen. Press **Esc** or  a second time to exit the help menu.

11-5 Updating the Site Master Firmware

The Site Master firmware is updated using a customer supplied USB memory stick. The firmware update is downloaded from the Anritsu web site.

Note

Press the Anritsu logo in the upper-left corner of the screen to display instrument status. Press **SW Info** button to view the current software revision. Instrument status can also be found in the System menu.

Updated product information can be found on the Anritsu web site:

<http://www.anritsu.com/>

Search for the product model number. The firmware updates are on the product page under the Library tab in the “Drivers, Software Downloads” section.

Note

The “Release History” link provides a summary of the firmware changes.

1. Click on the “Firmware Update for the Site Master S820E” link.
2. Click the “Download” button and then “Run”. After the download is complete, press “Run” again and follow the onscreen instructions.
Press “Help (?)” for additional information.
3. After the firmware update is saved on the USB memory stick, remove the memory stick from the computer.
4. Turn off the Site Master and insert the USB memory stick into the USB port.
5. Connect the AC adapter and turn the Site Master on.
6. Press the **Preset (1)** key.

7. Under the Reset submenu press Update Firmware. The Update Firmware dialog ([Figure 11-8 on page 11-11](#)) appears.

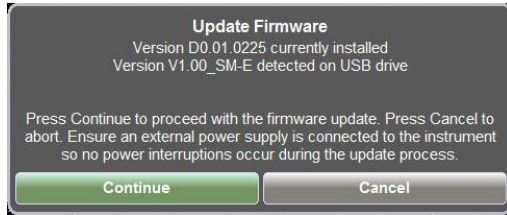



Figure 11-8. Update Firmware Message

8. Select CONTINUE to begin the firmware update or CANCEL to cancel.
9. After the update is complete, the instrument will power down and restart to complete the firmware update.
10. Software version information is displayed in the System Status dialog box. See [Figure 11-5 on page 11-6](#).

Warning Do not remove power or turn off the instrument during the firmware update to avoid potential serious damage to the instrument.

11-6 Screen Shot Capture

The Site Master can capture a bit mapped image of the display in Portable Network Graphics (.png) format using the Camera icon, .

The file is automatically named based on the instrument model and measurement type. Screen shot files are saved to the instrument's internal memory in the ScrnShots folder (Drive : Internal | ScrnShots).

The number keypad can be used to save a screen shot by pressing and holding the **Shift** key while then pressing (one at a time) the period (.) key, then the **+/-** key.

The look of the saved screen shot is set in this location: **System (8)** > System Setups > Display/Audio > ScrnShot Settings. Refer to the [“Display/Audio Menu” on page 11-21](#) for details. [Figure 11-9 on page 11-13](#) is an example of the same measurement saved with different screen shot settings.

Note

Measurements can also be saved as screen shots using the **File (7)** menu then Save and setting the Filetype to ScreenShot. Screen shots saved through the File Save Menu will be saved in the current save directory. Refer to [Chapter 10](#) for additional information.

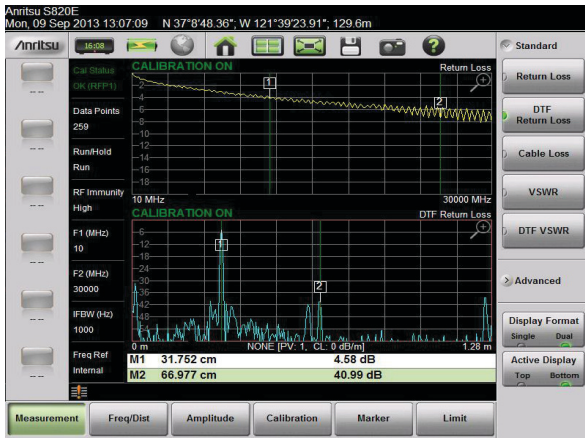

Settings:

Image Capture Size: Full Screen
 Background Color: Standard
 Image header/footer: Header

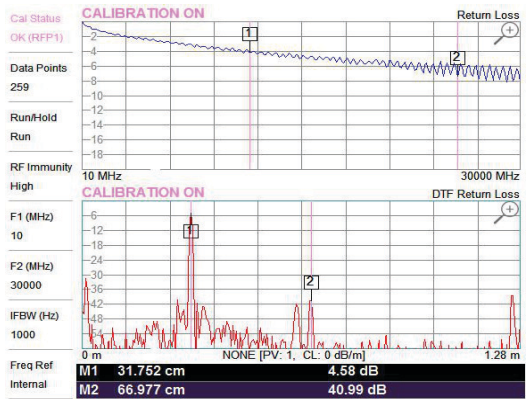

Anritsu S820E
 Mon, 09 Sep 2013 13:07:09 N 37°8'48.36", W 121°39'23.91", 129.6m

Settings:

Image Capture Size: Graph Only
 Background Color: Inverted
 Image header/footer: Footer

Figure 11-9. Screen Shot Settings

11-7 System Menu Overview

Figure 11-10 show the map of the System menus and submenus. The submenus are listed in the order they appear on the display from top to bottom under each main menu.

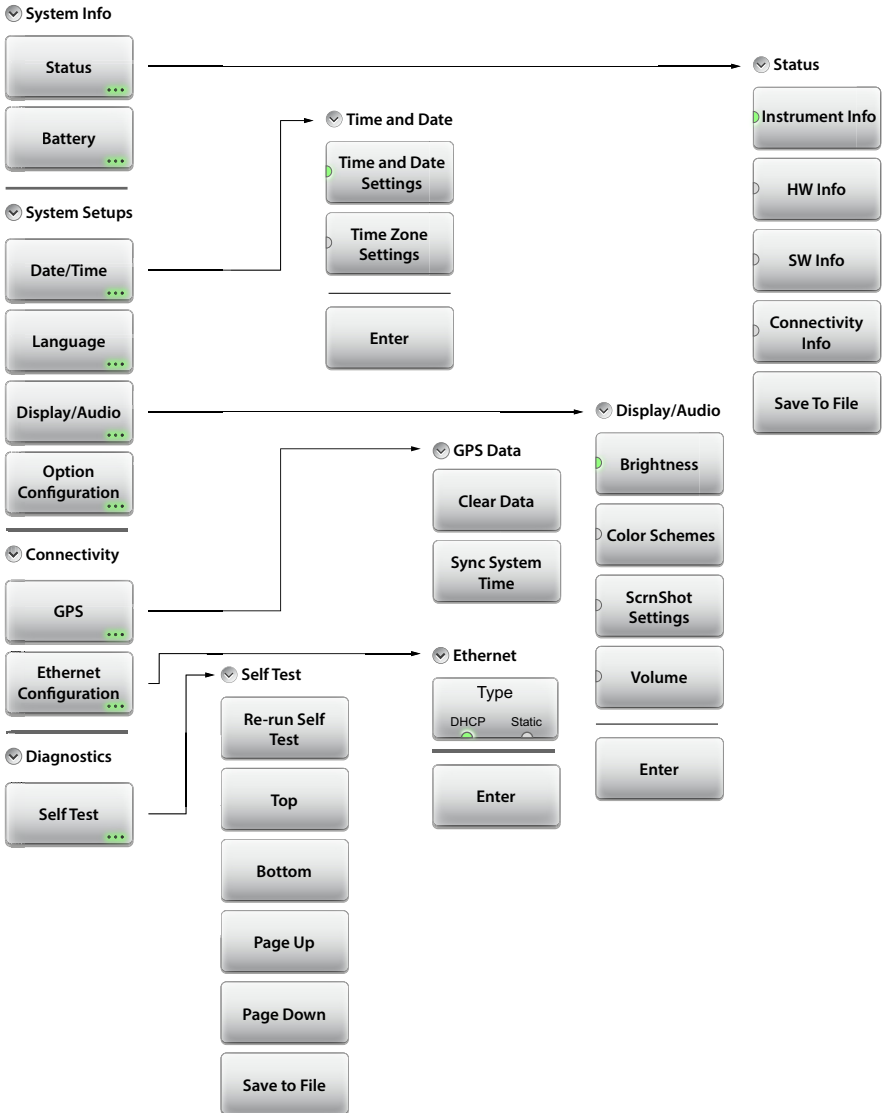

Figure 11-10. System Menu Keys

11-8 System Menu

Key Sequence: **System (8)**

<p>System Info</p> <p>Status</p> <p>Battery</p>	<p><i>System Info</i></p> <p>Status: Press this submenu key to display the “Status Menu” on page 11-18 including detailed instrument, hardware, software and connectivity information.</p> <p>Battery: Press this key to display the battery charge remaining and charge status.</p>
<p>System Setups</p> <p>Date/Time</p> <p>Language</p> <p>Display/Audio</p> <p>Option Configuration</p>	<p><i>System Setups</i></p> <p>Date/Time: Press to display the “Time and Date Menu” on page 11-20.</p> <p>Language: Press to set the default language. Options include: English, French, German, Italian, Spanish, Russian, Portuguese, Japanese, Korean, or Chinese.</p> <p>Display/Audio: Press this submenu key to display the “Display/Audio Menu” on page 11-21, which includes display, screen shot, and volume settings.</p> <p>Option Configuration: Press this submenu key to see a list of installed options and also any available software options. To enable new options, enter the Option Key or the file that is provided by Anritsu Customer Service. Refer to “Option Configuration Dialog Box” on page 11-17.</p>
<p>Connectivity</p> <p>Diagnostics</p>	

Figure 11-11. System Menu (1 of 2)

System Menu (continued)

Key Sequence: **System (8)**

<p>System Info</p>	<p><i>Connectivity</i></p>
<p>System Setups</p>	<p>GPS: Press to display the “GPS Menu” on page 11-24.</p>
<p>Connectivity</p>	<p>Ethernet Configuration: Press this submenu key to display the “Ethernet Configuration Menu” on page 11-26, which displays the IP Address and MAC Address of the instrument and allows you to choose the setting for obtaining the IP Address (DHCP or Static).</p>
<p>GPS</p>	<p><i>Diagnostics</i></p>
<p>Ethernet Configuration</p>	<p>Self Test: Press this submenu key to initiate a series of diagnostic tests that check the components of the instrument. A display lists the individual tests with a pass or fail indication (Figure 11-1 on page 11-2). Press Esc to close the dialog box.</p>
<p>Diagnostics</p>	<p>Press Save to File to create a text file of the test results. The file is saved to internal memory and labeled S820ESelfTest#X.txt. The .txt file can be copied to a USB memory device and viewed on a PC with a text reader or word processor.</p>
<p>Self Test</p>	

Figure 11-12. System Menu (2 of 2)

Option Configuration Dialog Box

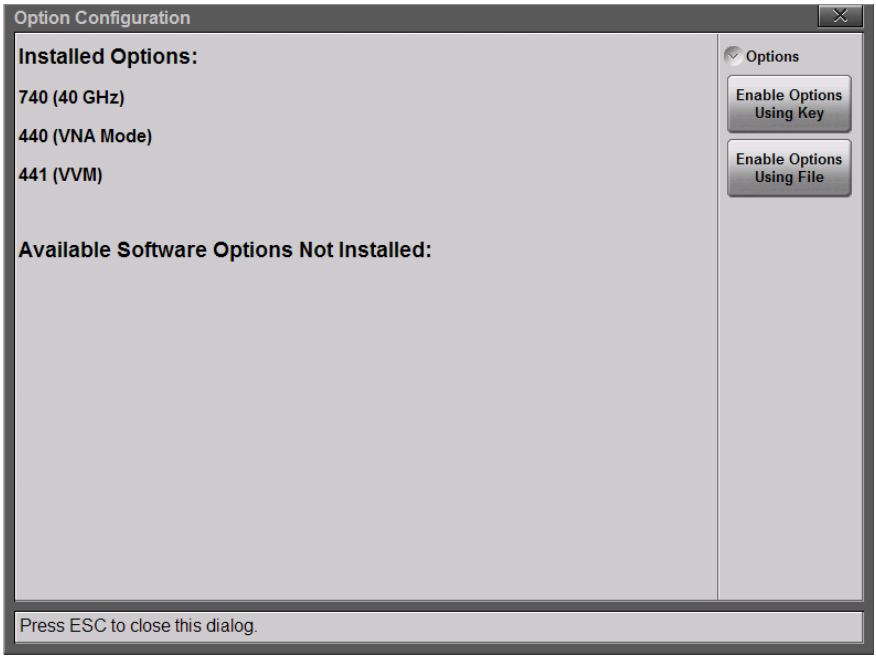

Figure 11-13. Option Configuration Dialog Box

Status Menu

Key Sequence: **System (8)** > System Info > Status

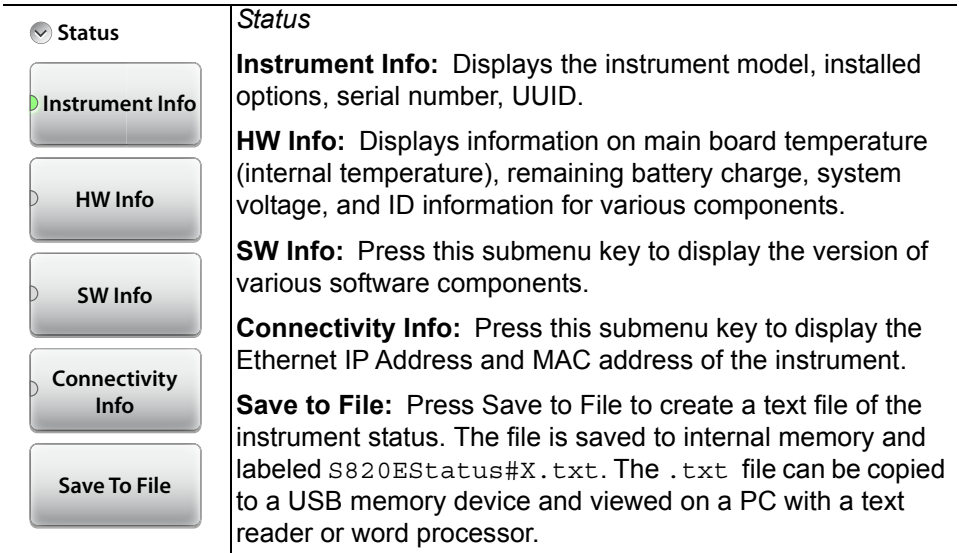

Figure 11-14. Status Menu

Pressing the Anritsu logo on the touchscreen also displays this Status menu. (Refer to item 1 in [Figure 2-6 on page 2-14.](#))

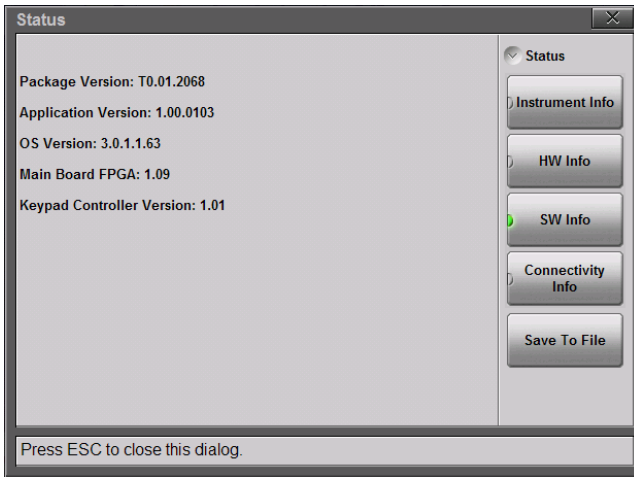

Figure 11-15. System Status Dialog Box

Time and Date Menu

Key Sequence: **System (8)** > System Setups > Date/Time

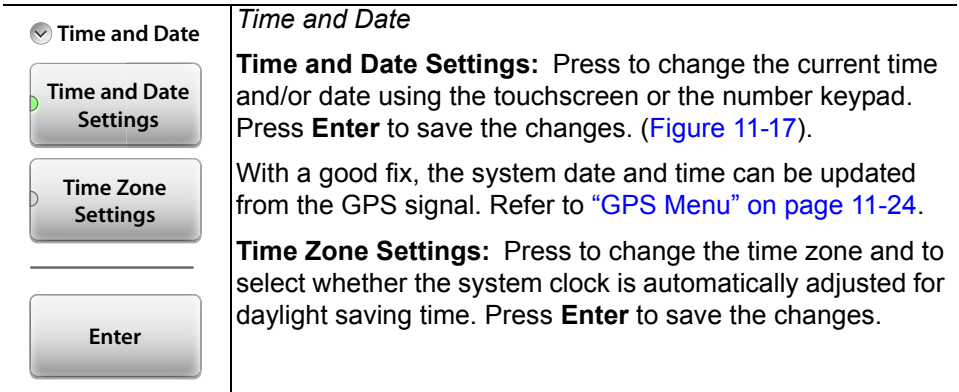

Figure 11-16. Time and Date Menu

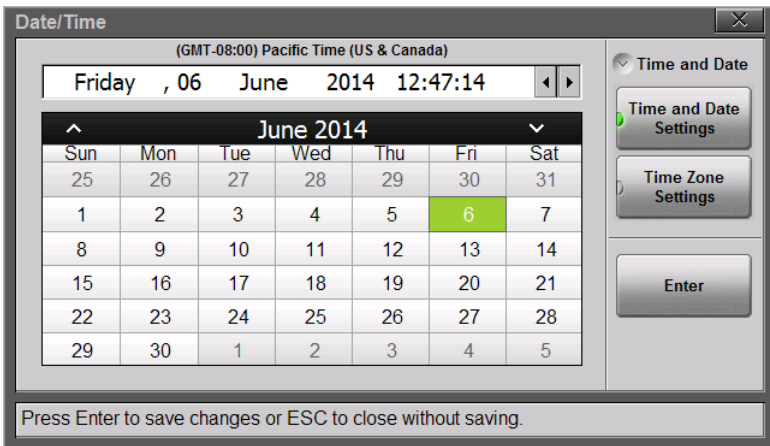

Figure 11-17. Date/Time Dialog Box

Display/Audio Menu

Key Sequence: **System (8)** > System Setups > Display/Audio









 Display/Audio	<p>Brightness: Press this key to access the display brightness settings. See Figure 11-19 on page 11-22. You can adjust the level for a wide variety of lighting conditions. Display Auto-dimming is enabled by default (3 minutes) to extend battery use. Tap the Dim Display After bar to display the available drop down selections for Auto-dimming.</p>
	
	<p>Color Schemes: Press this key and use the touchscreen to select Standard, Daytime, or Nighttime color scheme. Refer to “Color Schemes” on page 11-22.</p>
	<p>ScrnShot Settings: Press to change the settings used when capturing a screen shot with the  icon, or when saving a screen shot (.png) file. Refer to “Screen Shot Settings” on page 11-23 and Figure 11-9 on page 11-13.</p>
	<p>Volume: Press this submenu key to set the volume. The current volume setting is displayed. Use the touchscreen, the Up/Down Arrow keys, or the rotary knob to change the volume, and press the Enter key to accept the change.</p>
	<p>Enter: Press this key or the Enter key on the number keypad to apply changes that have been set in the other Display/Audio submenus.</p>

Figure 11-18. Display/Audio Menu

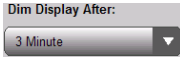
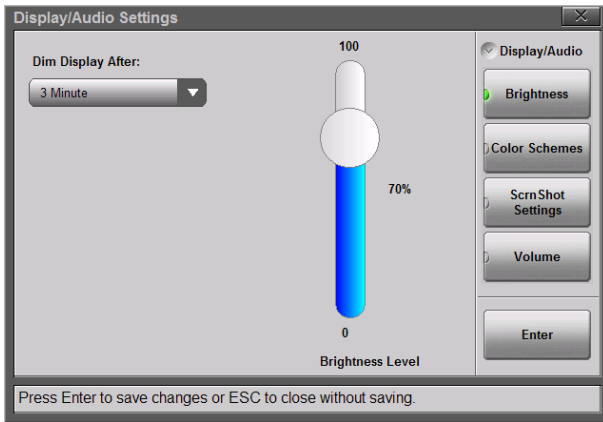
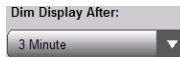

Figure 11-19. Display/Audio Settings – Brightness

Display Auto-dimming is enabled by default (3 minutes) to extend battery use.



Tap the Dim Display After bar to display the available drop down selections for Auto-dimming. Use the touchscreen, the **Up/Down Arrow** keys, or the rotary knob to adjust the currently active setting. Press **Enter** to save the change, or press **Esc** to cancel.

Seven settings are available for dimming the display. Choose to dim after a number of minutes (from 1, 2, 3, 5, 10, or 15) or choose **Never**. See [Figure 11-19](#).

Color Schemes

Standard color and contrast of the display provides the best colors and sweep display.

Daytime increases the contrast of the display and increases line thickness of traces. It is useful outdoors in bright light or other challenging viewing conditions.

Nighttime sets the display to a darker red-tinted color scheme, useful in night-time viewing conditions.

Screen Shot Settings

Under **Image Capture Size:**, select **Graph Only**, or select **Full Screen** to capture the entire display screen including displayed menu buttons.

Under **Background Color:**, select **Inverted** to remove the graph background color (useful for paper printing), or select **Standard** for the typical black background.

Use **Image Header/Footer:** to select the location where the instrument model, name, and date stamp are displayed.

GPS Menu

To use GPS, you must have an external USB-based GPS module connected.

Key Sequence: **System (8)** > Connectivity > GPS

<p>GPS Data</p> <p>Clear Data</p> <p>Sync System Time</p>	<p><i>GPS Data</i></p> <p>Clear Data: Press this key to clear the Site Master’s current GPS location data or last known GPS location data. If a compatible GPS module is attached, then the instrument will attempt to re-acquire a GPS fix.</p> <p>Note: The last Good Fix location information will be retained until the instrument is powered off, the Clear Data button is pressed, or a new Good Fix is acquired. The Good Fix or the Last Fix location information is stored in the measurement file and is included in the screen capture header/footer.</p> <p>Sync System Time: Press this key to sync the instrument’s time setting with the current GPS information. Sync only works with a good GPS fix.</p> <p>After a valid sync the instrument time is reset based on the UTC time plus/minus the time zone offset. Refer to “Time Zone Settings” on page 11-20.</p>
---	---

Figure 11-20. GPS Menu

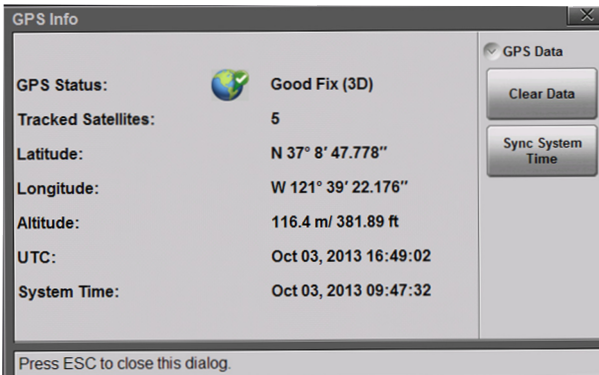

Figure 11-21. GPS Info

Note

An exclamation mark (!) is appended to the GPS location data in screen captures when the instrument is using Last Fix instead of current GPS information.

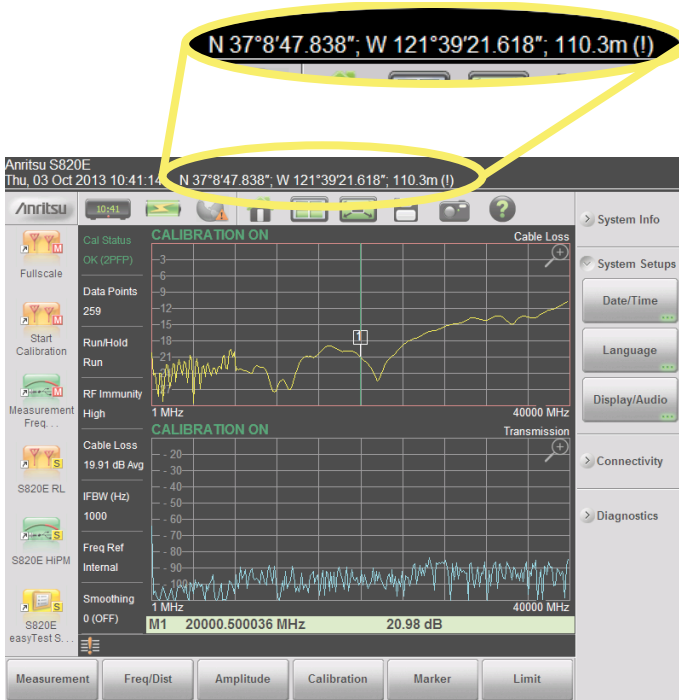

Figure 11-22. "(!)" Indicates Last Fix GPS Data

Ethernet Configuration Menu

Key Sequence: **System (8)** > Connectivity > Ethernet Configuration

<p>☑ Ethernet</p> <div style="border: 1px solid gray; padding: 5px; margin: 5px;"> <p>Type</p> <p>DHCP Static</p> </div> <div style="border: 1px solid gray; padding: 5px; margin: 5px;"> <p>Enter</p> </div>	<p><i>Ethernet</i></p> <p>Type: Press this key to select the type of IP Address setting: DHCP or Static. When set to DHCP, the instrument dynamically sets the IP Address and displays it, as shown in Figure 11-24. When set to Static, the user must manually enter the IP, Gateway, and Subnet addresses, as shown in Figure 11-25. The settings are saved once the Enter button is pressed.</p>
--	--

Figure 11-23. Ethernet Configuration Menu

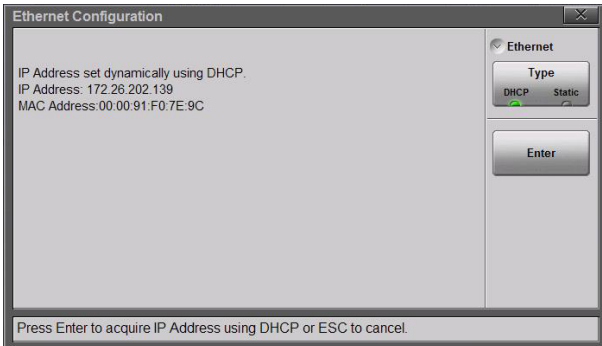

Figure 11-24. Ethernet Configuration Dialog - DHCP

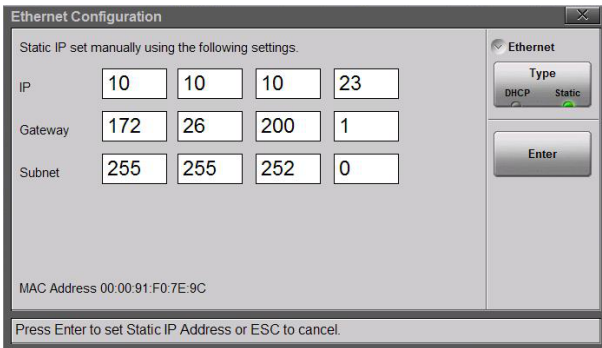

Figure 11-25. Ethernet Configuration Dialog - Static

11-9 Preset Menu

Key Sequence: **Preset (1)**

Caution Carefully read the information on screen before performing any of the functions under the Preset menu. User files that are deleted cannot be recovered.

<p>▼ Preset</p> <div style="border: 1px solid gray; background-color: #f0f0f0; padding: 5px; text-align: center; margin: 5px 0;">Preset</div> <hr style="border: 0.5px solid gray;"/> <p>▼ Reset</p> <div style="border: 1px solid gray; background-color: #f0f0f0; padding: 5px; text-align: center; margin: 5px 0;">Reset ...</div> <div style="border: 1px solid gray; background-color: #f0f0f0; padding: 5px; text-align: center; margin: 5px 0;">Update Firmware</div>	<p><i>Preset</i></p> <p>Preset: Press this key to reset the instrument to the default conditions.</p> <p>Preset condition in Cable-Antenna mode: Return Loss measurement, full frequency range, full amplitude scale, no calibration, all markers off, and limit line off.</p> <p><i>Reset</i></p> <p>Reset: Press this key to display the reset options shown below. Select the Reset option to apply using the touchscreen, Up/Down Arrow keys or rotary knob. Carefully read the on screen information before confirming the reset.</p> <p>Factory Reset: Press this key to restore the instrument to the factory default values, including language, volume, display/audio settings. User saved files and user created shortcut icons on the Menu screen are not deleted.</p> <p>Press the Factor Reset button to initiate the reset, and power cycle the instrument. Press Esc to cancel and close.</p> <p>Delete All User Files: Deletes all user files in Site Master internal memory including measurements, setup files, and screen shots. Menu shortcuts, customized EZ key names, and custom cable types are not deleted.</p> <p>To delete all user files, press the Delete All User Files button and then press Yes to confirm.</p> <p><i>Continued on next page</i></p>
---	--

Figure 11-26. Preset Menu (1 of 2)

<p>▼ Preset</p> <p>Preset</p> <hr/> <p>▼ Reset</p> <p>Reset</p> <p>Update Firmware</p>	<p>Delete Custom Files: Select the custom files to delete including keyboard EZ names, menu shortcuts, and custom cable types (Figure 11-27 on page 11-28).</p> <p>Use the touchscreen to select the custom file types to delete and press the Delete Custom Files button and then press Yes to confirm.</p> <p>Master Reset: In addition to the functions described in Factory Reset above, all user files in the internal memory and all custom files are deleted (Figure 11-28 on page 11-29).</p> <p>Press the Master Reset button to initiate the Master Reset and reboot the instrument, then press Yes to confirm.</p> <p>Update Firmware: Press this submenu key to update the instrument operating system with a USB flash drive. Follow the on screen instructions to update the firmware. Refer to Section 11-5 “Updating the Site Master Firmware” on page 11-10 for additional information.</p>
--	---

Figure 11-26. Preset Menu (2 of 2)

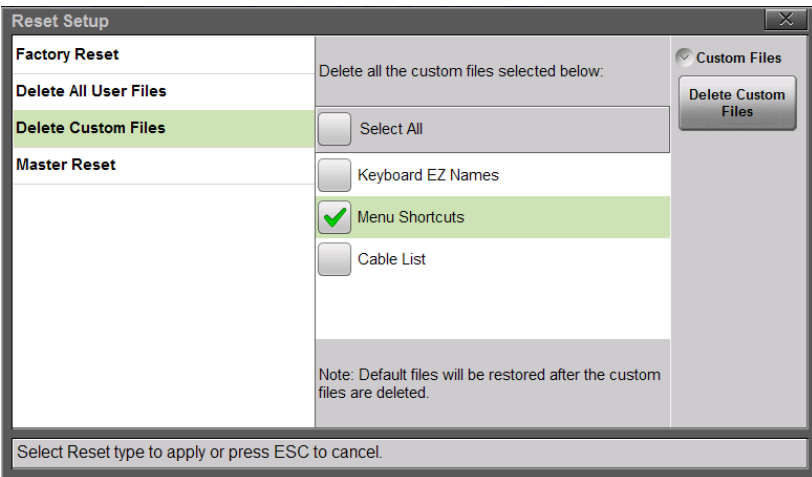

Figure 11-27. Delete Custom Files

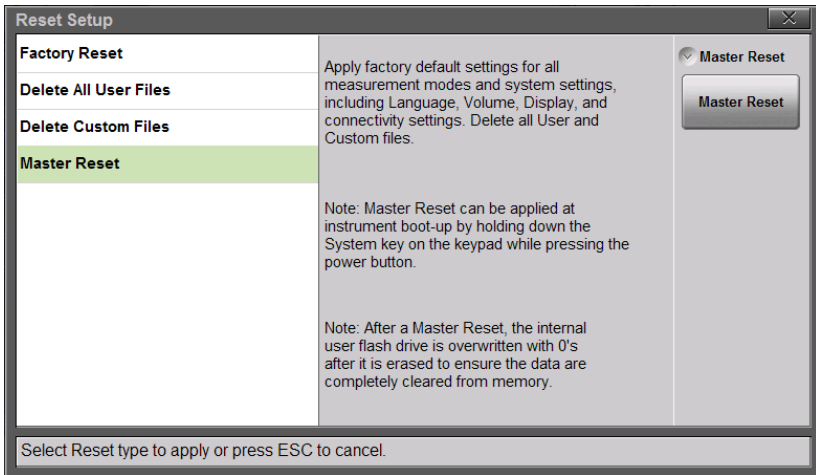

Figure 11-28. Master Reset

If the Site Master is not functioning as expected, then perform a preset. All the current settings and applied calibration factors will be cleared.

Note

The next step (if a preset does not resolve the issue) is a Factory Reset. This can be performed at power On by holding down the **Esc** key and then pressing the power button, or through the **Preset (1)** menu.

Chapter 12 — Battery Replacement

12-1 Introduction

This chapter provides details and procedures about the Site Master batteries including replacing the existing battery.

Note

Screen images in this User Guide are illustrations of typical instrument features. Some images may include instruments other than the Site Master S820E. Traces and other display features may differ from the screen displays of your instrument.

12-2 Site Master Battery

The battery that is supplied with the Site Master may need charging before use. The battery can be charged using either the AC-DC Adapter or the DC adapter. Refer to [Figure 2-8 on page 2-19](#) for a description of battery symbols.

Note Use only Anritsu Company approved batteries, adapters, and chargers with this instrument.

Pressing the battery icon  displays the current battery information ([Figure 12-1](#)). Press **Esc** to clear the message.

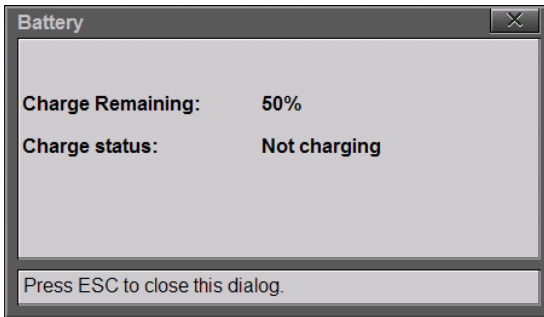

Figure 12-1. Battery Information

12-3 Battery Replacement

The battery can be replaced without the use of tools. The battery compartment is located on the lower left side of the instrument (when you are facing the measurement display).

Remove the battery as follows:

1. Slide the catch toward the bottom of the instrument
2. Pull the top of the door away from the instrument
3. Lift out the battery door.
4. Remove the battery pack from the instrument by grabbing the battery lanyard and pulling it out.

Replacement is the opposite of removal. The battery key side (slot below the contacts) must be facing the front on the instrument and must slide in first.

Note

When inserting the battery, the battery label must face the back of the instrument, and the guide slot on the battery must be below the contacts. If the battery door does not latch closed, then the battery may be inserted incorrectly.



Figure 12-2. Battery Compartment

Note

Anritsu Company recommends removing the battery for long-term storage of the instrument.

Caution

When using the Automotive power outlet adapter, always verify that the supply is rated for a minimum of 5 amps (60 Watts) at 12 VDC, and that the socket is clear of any dirt or debris. If the adapter plug becomes hot to the touch during operation, then discontinue use immediately.

The batteries will charge at a faster rate when the instrument is turned off or is set to standby mode. Charging the batteries while the instrument is running will require a longer time to reach a full charge.

To prolong the useful battery life, the internal charging circuit monitors the battery temperature. Normal charging occurs when the battery temperature is between 0 °C and 45 °C. Charging is paused when the battery temperature is beyond this range.

Chapter 13 — Anritsu Tool Box with LST

13-1 Introduction

This chapter provides a brief overview of the Anritsu Tool Box and the Line Sweep Tools program. For detailed information about Line Sweep Tools, refer to the program Help.

13-2 Anritsu Tool Box

The Anritsu Tool Box is a central location to open an Anritsu measurement, visit the Anritsu web site, or launch an Anritsu application (Figure 13-1 on page 13-2). To open the Anritsu Tool Box, either click on the shortcut icon on the desktop or click Start and navigate through the Programs folder to the Anritsu folder. Then click on the Anritsu Tool Box shortcut to open the Anritsu Tool Box. After the Tool Box is open, move the mouse pointer over any of the application icons to view a short description of the application.



Figure 13-1. Anritsu Tool Box

13-3 Install the Software

Place the Installation DVD in your computer and follow the on-screen instructions (Figure 13-2).

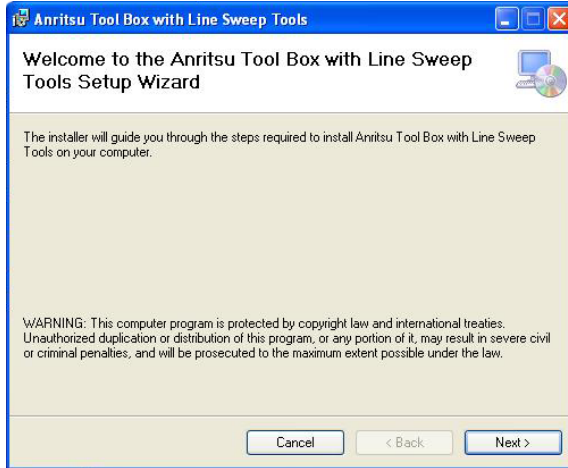

Figure 13-2. Installing Anritsu Tool Box with Line Sweep Tools

If the installer does not start automatically, then navigate to the DVD and run `INSTALL.BAT` (Figure 13-3).

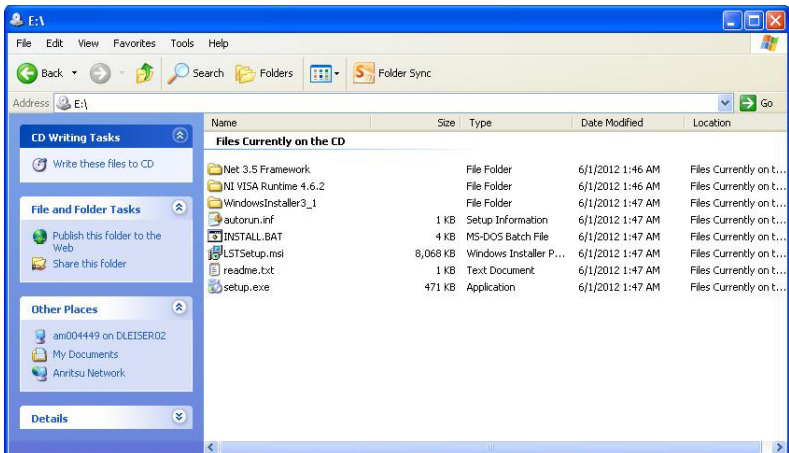

Figure 13-3. `INSTALL.BAT` on the Anritsu Tool Box DVD

The installation will start. Follow the on-screen instructions. The software is also available free of charge from the Anritsu web site:

<http://www.anritsu.com>

13-4 Why use Line Sweep Tools?

Line Sweep Tools is a program designed to increase productivity for people who work with dozens of Cable traces, Antenna traces, and Passive Intermodulation (PIM) traces every day. Line Sweep Tools can:

- Collect sweeps from Anritsu PIM and Line Sweep instruments.
- Help verify that those sweeps are done properly and that the Cable, Antenna, and PIM sweeps meet specifications.
- Help create reports of the findings quickly and to a professional standard.

Line Sweep Tools Features

The Line Sweep Tools user interface is familiar to users of Handheld Software Tools, the current industry standard line sweep post-capture trace processing software. This leads to a short learning curve and easy trace collection, validation, and reporting.

The Anritsu Line Sweep Tools program features include:

- Presets for markers and limit lines take hours off the report preparation time for a user with dozens of traces to verify.
- The Report Generator, which makes generating PDF reports for multiple traces (with logos) quick and easy.
- Dual Trace viewing mode ensures compatibility with the E series line sweep instruments.
- A naming grid makes naming files, titles, and subtitles much quicker and error free.
- Line Sweep Tools can open DAT or VNA files from a wide range of current and supported Anritsu handheld instruments.
- Line Sweep Tools can open the PIM files generated by Passive Inter-Modulation measurements.

Chapter 14 — Anritsu easyTest Tools

14-1 Introduction

easyTest Tools allows you to create a test sequence (.ett) file on a PC. The file can be copied to the S820E via a USB memory stick and opened from the Menu screen by pressing the easyTest  icon.

easyTest Tools files can:

- Display custom user images on the screen of the S820E. Images may include connection diagrams or procedure steps. easyTest supports a variety of image types including .jpg, .bmp, and .png.
- Set instrument parameters to a specific state including measurement type, frequency and amplitude settings, limit lines, and markers. This is accomplished by including a previously-saved instrument setup in the easyTest Tool file.
- Prompt you with a message at the top of the display. While the message is displayed, the instrument can be unlocked for prompts that require user action. An example message is “Press the Autoscale button to zoom in on the trace”.
- Include automatic or manual saving and naming of measurements or

Note

Screen images in this User Guide are illustrations of typical instrument features. Some images may include instruments other than the Site Master S820E. Traces and other display features may differ from the screen displays of your instrument.

14-2 easyTest Tools on the PC

The software is available from the Anritsu Web site and is compatible with Windows XP, Windows Vista, and Windows 7.

After installing and launching easyTest Tools, perform the following steps to create an easyTest (.ett) file on the PC that can be opened on the S820E Microwave Site Master.

Create an easyTest File on the PC

1. Drag the desired steps from the Command Selections pane (left side) into the command Sequence pane (center). See [Figure 14-1 on page 14-3](#).

Note Refer to the easyTest Tools Help for additional information.
--

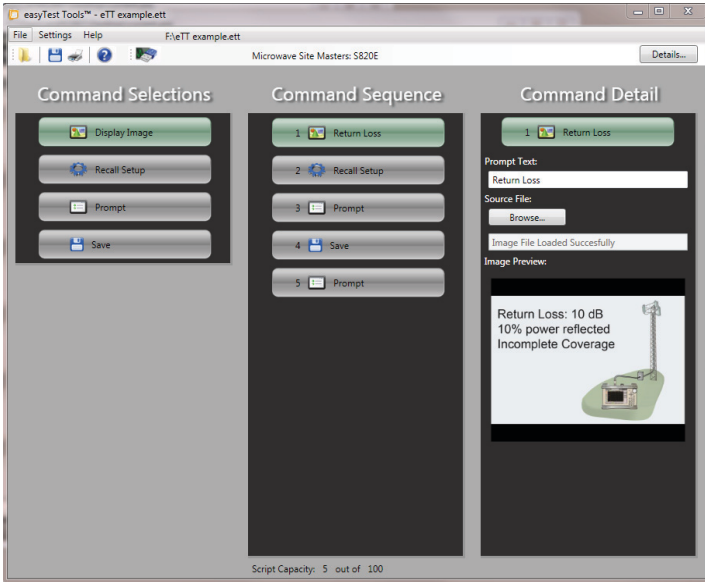

Example of Setup in easyTest Tools on the PC

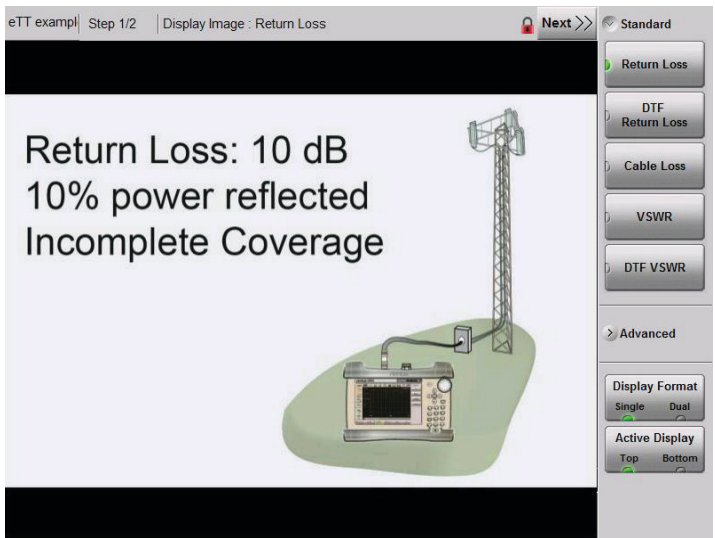

How the Setup is Displayed on the S820E Site Master

Figure 14-1. easyTest Tools on the PC and S820E

14-3 easyTest on the S820E

After an easyTest Tool test sequence has been created on a PC, use the following steps to transfer the file from a USB Memory stick into the instrument.

1. Insert the USB Memory stick with the easyTest (.ett) file in the S820E Site Master.
2. Press the **Menu** button.
3. Press the easyTest icon in the lower-right corner to display the easyTest Recall dialog box.



Figure 14-2. easyTest Icon

4. Select the file on the USB Memory stick and press **Recall** or **Enter** (Figure 14-3). Alternatively, copy the file to internal memory and recall the file from that location. Immediately after the .ett file is recalled, the test sequence is executed.

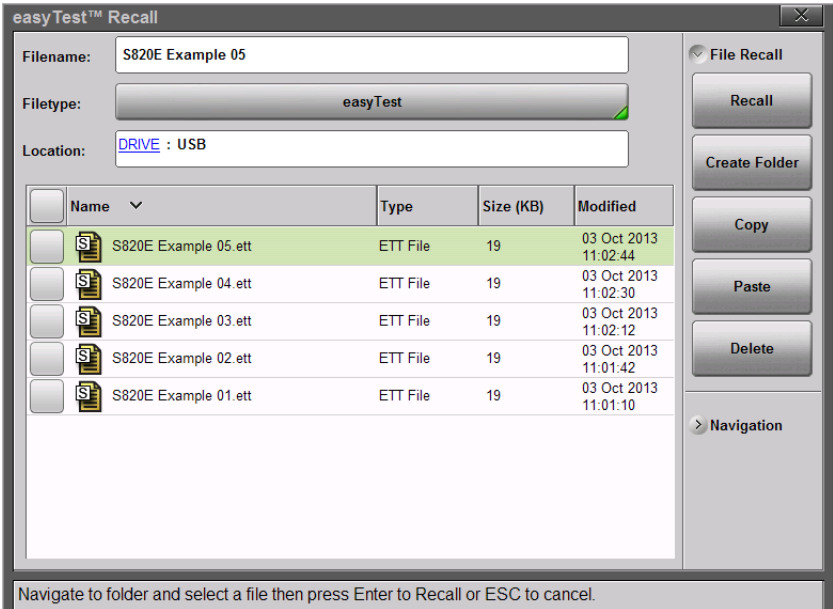

Figure 14-3. Recalling an easyTest File

5. Press **Next >>** to step through the file, or press **Esc** to abort.
6. Follow the instruction prompts on the Status/Instruction bar. Press either the “Next Step” button on the touchscreen or the **Right Arrow** key on the instrument to continue to the next step.
7. After completing the last step, an Attention dialog box informs you that the easyTest file sequence is completed and closing.

Chapter 15 — Video Inspection Probe (VIP)

15-1 Introduction

Signal degradation may occur as a result of a dirty or damaged optic fiber ferrule endface. The Site Master S820E supports an application that lets you inspect fiber optic terminations, using a Video Inspection Probe (VIP) such as Anritsu Model G0306A. See [Figure 15-1](#). The captured image and analysis results help determine if a connector should be cleaned or replaced. Pass/Fail evaluations are made in accordance with the IEC61300-3-35 standard. You can also save the data to file and generate test reports.



Figure 15-1. Anritsu G0306A Video Inspection Probe

15-2 Setup and Operation Summary

1. Attach to the VIP a probe tip, or ferrule adapter, that is compatible with the type of fiber optic connector you wish to test. Refer to [“Connect the VIP” on page 15-3](#).
2. Connect the probe to the fiber optic endface and to the USB port on the Site Master S820E.
3. On the Site Master, select VIP Mode. Refer to [“Launch the VIP Application” on page 15-4](#). The instrument screen will display a live image of the fiber edge surface.
4. Press the **Setup** main menu key and verify or change the VIP test settings, which include the probe model, tip type, and test profile. Refer to [“VIP Test Settings” on page 15-4](#).
5. If needed, use the Focus Control knob on the probe to adjust the image focus.
6. Press the **Measurement** key on the Site Master screen, then press the **Captured** key to capture the displayed image.
7. Turn the rotary knob to zoom the captured image. Use the arrow keys to pan.
8. Press the **Analyze** key to execute analysis of the current VIP image. Detailed analysis results are displayed in tabular form if Auto is selected with the **Results Table** key.
9. To quickly save the captured image and test results using the current auto filename settings, press the Save icon on the [“System Function Tool Bar” on page 2-23](#). You can also press the **Save/Recall** main menu key, then press **Save** to manually enter a file name and select its location.
10. Press **Report** if you wish to generate a report, in PDF format, on either the current or previously saved analysis results, or both.

15-3 VIP Setup

Follow the instructions in this section to connect the Video Inspection Probe, set the Site Master to VIP Mode, and select the VIP test settings. You can change these settings anytime via the Setup menu.

Connect the VIP

The Anritsu G0306A Video Inspection Probe comes with seven changeable probe tips: four standard tips (SC, LC, and FC) and three universal tips (1.25 mm and 2.5 mm). See [Table 15-1](#). The standard tips are compatible with common types of bulkhead adapters. The universal tips are typically used for inspecting patch cords.

Table 15-1. Probe Tip Types

Tip Type	Description
SC_APC_F	SC Angled Physical Contact, Female
SC_PC_F	SC Physical Contact, Female
LC_PC_F	LC Physical Contact, Female
FC_PC_F	FC Physical Contact, Female
2.5APC_M	Universal 2.5 mm Angled Physical Contact, Male
2.5PC_M	Universal 2.5 mm Physical Contact, Male
1.25PC_M	Universal 1.25 mm Physical Contact, Male

1. Depending on the connector type you wish to test, attach the appropriate probe tip to the Video Inspection Probe.
2. Connect the probe to the bulkhead or patch cord to be tested.
3. Insert the USB connector at the end of the coiled cord into the S820E USB port.

Launch the VIP Application

If the S820E is currently running a different application, or measurement mode, press the **Menu** key, then press the VIP Mode application icon. See [Figure 15-2](#).



Figure 15-2. Menu Screen

VIP Test Settings

To access the VIP test settings, press the Setup main menu key. Refer to [“Setup Menu” on page 15-12](#) for a description of the submenu keys.

1. The Probe Model submenu key shows the currently selected VIP model. The Site Master currently supports only the Anritsu Model G0306A probe.
2. Press the Tip Type submenu key to display the selection box. Use the rotary knob or the **Up/Down** arrow keys to highlight the appropriate probe tip, then press **Enter** to save the setting. [Table 15-1 on page 15-3](#) lists the available tip types.

To close the Tip Type dialog without making a change, press the **Esc** key.

3. Press the **Test Profile** key to open the selection box. Use the rotary knob or the **Up/Down** arrow keys to highlight the desired profile, then press **Enter** to save the setting.

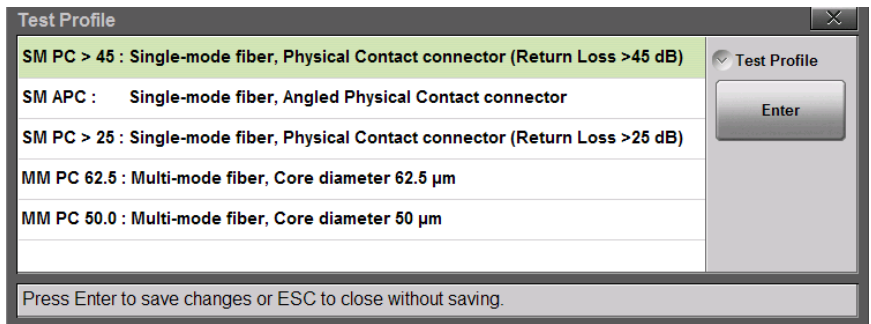

Figure 15-3. VIP Test Profile Selection Box

4. If needed, press the **Auto Analyze** key to set it On or Off. When On, the VIP image is immediately analyzed when captured. Auto analysis is not performed if the setting is Off.
5. The **Auto Filename** key determines if a file name is automatically generated when saving a measurement or image to file. When this setting is On, the saved file name and location are taken from the auto filename settings.
6. Press the **Auto Filename Settings** submenu key to open the dialog box shown in Figure 15-4. Press the **Location** bar to change the save location. To edit the file prefix or the starting number, press the appropriate text box. You may also include the current date.

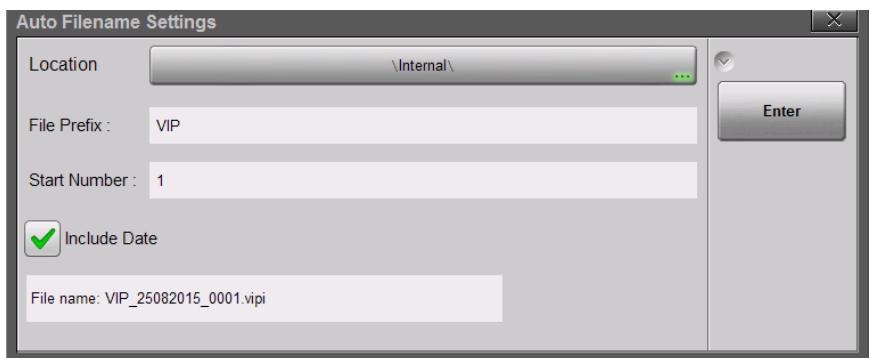

Figure 15-4. Auto Filename Settings Dialog

15-4 Operation

Once the Video Inspection Probe is properly connected and you have started the VIP application on the Site Master, a live view of the optical fiber endface should display on the instrument screen. See [Figure 15-5](#).



Figure 15-5. VIP Image Live View

Note

Instead of capturing and analyzing a live VIP image, you can recall a previously saved image and perform VIP analysis on it. Refer to [“Recall a VIP Image \(VIP Mode Only\)”](#) on page 10-18.

VIP Image Analysis

Skip the first three steps below if the displayed VIP image is a recalled image.

1. While the display is in Live view, adjust the image focus if needed.
2. Press the **Measurement** main menu key to display the Measurement menu, shown in [Figure 15-5](#).
3. Press the **Captured** key to capture the VIP image.

- Optionally, use the rotary knob and arrow keys to zoom and pan the image, respectively. The Zoom Control Help key displays the related Help message.
- To execute the VIP image analysis, press the Analyze submenu key. Skip this step if the Auto Analyze setting is On, in which case the image is automatically analyzed when captured (refer to the “Setup Menu” on page 15-12).

After the analysis completes, the overall Pass/Fail indicator is displayed in the lower left corner of the screen.

- Press the Results Table submenu key to show or hide the detailed analysis results. See Figure 15-6. For each of the analysis areas, or zones (core, cladding, adhesive, contact), the table shows the count of scratches and contaminations or defects, and their Pass/Fail evaluation results. The table will not appear if there are no analysis results to display.

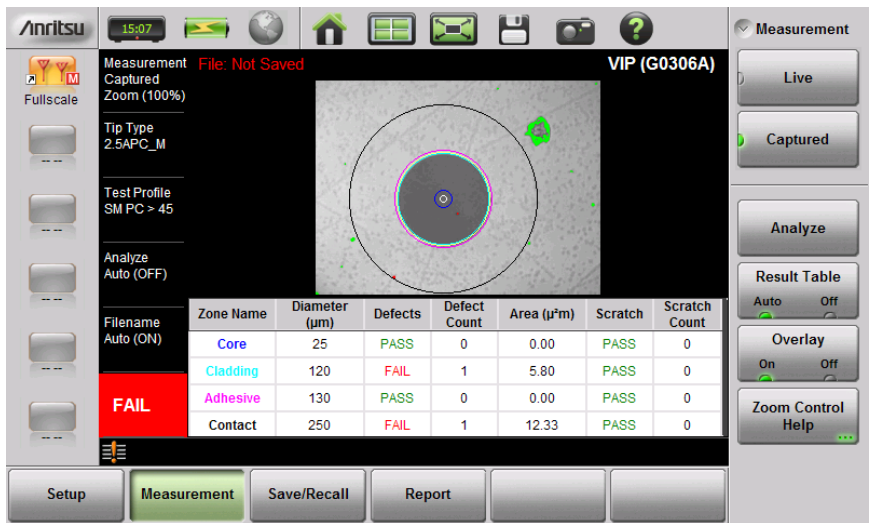

Figure 15-6. VIP Image Captured and Analyzed

- Press the Overlay submenu key to turn on and off the colored circles around the analysis areas, and the red and green highlights showing the defects and scratches found on the connector endface. Defects of an acceptable size are green (Pass). Defects that are large enough to potentially cause a problem are highlighted in red (Fail).

8. To save the VIP data to file with one press of the touchscreen, press the Save icon in the “System Function Tool Bar”. The current auto filename settings are applied to the saved file, provided the Auto Filename submenu key is set to On. Refer to “VIP Test Settings” on page 15-4.

If Auto Filename is Off, or if you press the **Save/Recall** main menu key followed by **Save**, or press **Save** (7) on the numeric keypad, the Save dialog is displayed. See [Figure 10-1](#) on page 10-4.

9. Enter the file name. Refer to “Choose the File Name” on page 10-9.
10. To select the type of file to save, press the Filetype button, then press the desired submenu key. See [Figure 15-7](#).

Measurement (.vpi) – Saves the VIP image and analysis results

VIP Image (.png) – Saves the VIP image only

ScreenShot (.png) – Saves a screen capture of the current display

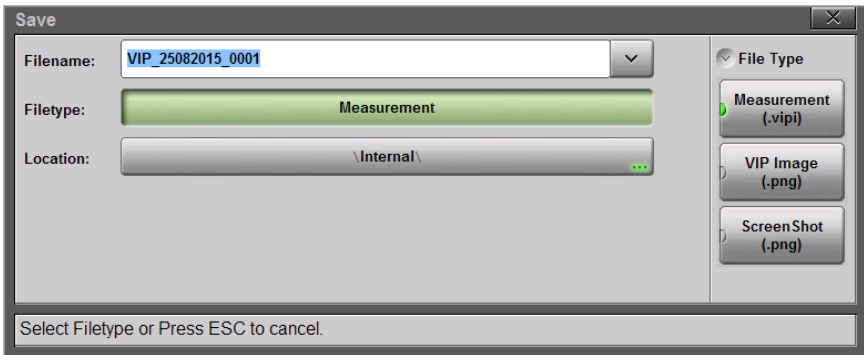

Figure 15-7. VIP File Type

11. Optionally, press the Location button and select the destination folder as described in “Set the Save Location” on page 10-5.
12. Press the Save button in the Save dialog.

If the overall analysis result is a Fail, follow standard practices to clean or replace the fiber optic connector.

VIP Reporting

You can output the captured VIP image and analysis results to a PDF-formatted file, using the **Report** main menu key. The report may include current or previously saved data, or both.

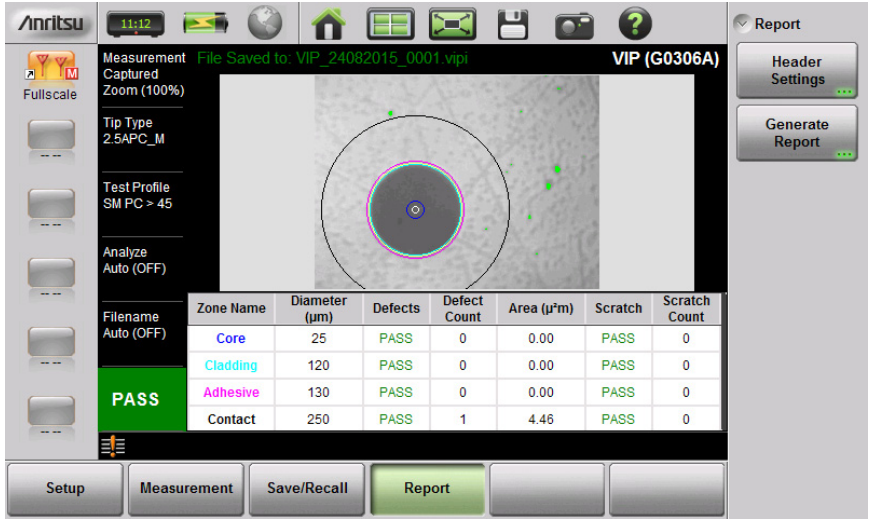

Figure 15-8. VIP Report Menu

1. Press Header Settings to enter or change the report header data.

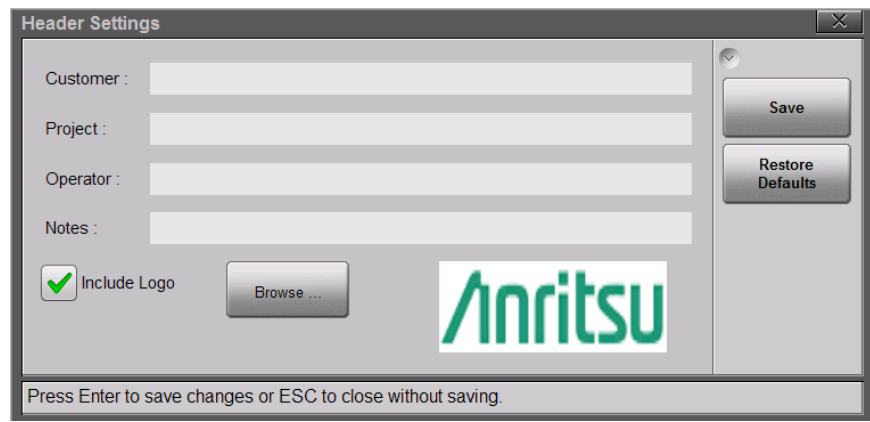

Figure 15-9. VIP Report Header Settings Dialog

2. In the Header Settings dialog box, press the text field to be edited and use the touchscreen keyboard to enter the information.
3. If you want the report to show your company logo, select the **Include Logo** checkbox and browse to the location of the desired logo image. This image must be in PNG format, and will be resized automatically.
4. Press **Save** to save the header information, which is retained until modified.
5. Press the **Generate Report** submenu key to open the dialog box in [Figure 15-10](#).

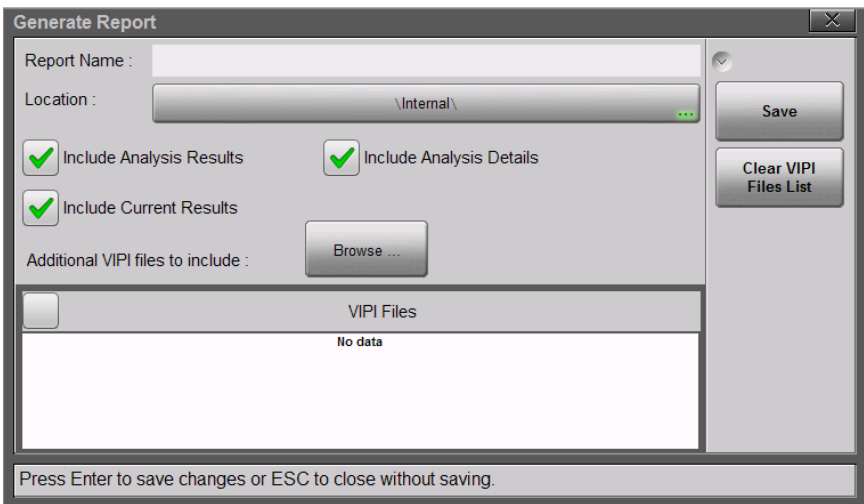

Figure 15-10. Generate Report Dialog

6. Enter the report name and select the destination folder as needed.
7. Optionally, press the **Clear VIPI Files List** button to remove saved files from the list included in the report.
8. Select or deselect the checkboxes as appropriate:
 - Analysis Results** – Overall Pass/Fail result
 - Analysis Details** – Detailed results by analysis area
 - Current Results** – Image and analysis results of currently displayed VIP measurement
 - Additional VIPI Files** – Previously saved measurement data
9. Press **Save** to generate the report.

15-5 VIP Menu

Figure 15-11 illustrates the menus available in VIP Mode. The main menu keys appear at the bottom of the display screen. The **Save/Recall** key brings up the same File menu as does the keypad menu key **File (1)**.



Figure 15-11. VIP Menu Map

Setup Menu

Key Sequence: **Setup**

	<p>Probe Model: This submenu key shows the currently selected probe model. Press the key to display the list of supported VIP models from which you can select.</p> <p>Tip Type: Press this submenu key to display the Tip Type selection box. Use the rotary knob or the Up/Down arrow keys to highlight the appropriate probe tip, then press Enter to save the setting. See Table 15-1 on page 15-3 for a list and description of possible selections.</p> <p>To close the Tip Type dialog without making a change, press the Esc key.</p> <p>Test Profile: Press this submenu key to select a profile that matches the type of fiber being tested. Use the rotary knob or the Up/Down arrow keys to highlight the appropriate probe tip, then press Enter to save the setting. See Figure 15-3 on page 15-5.</p> <p>Auto Analyze On/Off: When set to On, the fiber endface image is automatically analyzed following capture. Select Auto Analyze Off if you want to view the image before manually executing the analysis.</p> <p>Auto Filename On/Off: If Auto Filename is On, the file naming scheme currently defined in the Auto Filename Settings dialog is applied when you press the Save icon. With Auto Filename Off, pressing the Save icon opens the Save dialog the same way as pressing Save under the File menu would.</p> <p>Auto Filename Settings: Press this submenu key to open a dialog box where you can preset the location and name of files to be saved. See Figure 15-4 on page 15-5. You can define a prefix (VIP is the factory default) and set the starting number from which file numbering will increment. You may also choose to include the current date in the file name, in the format DDMMYYYY. For example:</p> <p style="padding-left: 40px;">VIP_0001.vipi VIP_21082015_0001.vipi</p>
--	--

Figure 15-12. VIP Setup Menu

Measurement Menu

Key Sequence: **Measurement**

<p>Measurement</p>	<p>Live: In Live mode, the instrument displays a live view of the connector endface. Use the control on the probe to adjust the focus. The image cannot be panned or zoomed until it is captured.</p>
<p>Live</p>	<p>Captured: Press this submenu key to capture the currently displayed image, which you may then zoom and pan, using the rotary knob and arrow keys. The message “File Not Saved” is displayed at the top of the screen until you save the image and/or the measurement results.</p>
<p>Captured</p>	<p>Analyze: Press this submenu key to start analysis of the VIP image. The overall Pass/Fail result is displayed in the lower left corner of the screen. If the Results Table setting is Auto, a table showing detailed results of the VIP test is also displayed.</p>
<p>Analyze</p>	<p>Results Table Auto/Off: This submenu key toggles on and off the table of detailed VIP test results. When set to Auto, the table will appear only when there are analysis results to display.</p>
<p>Results Table Auto Off</p>	<p>Overlay On/Off: Press this submenu key to turn on and off the colored circles showing the analysis areas and to highlight any scratches and defects on the connector endface:</p>
<p>Overlay On Off</p>	<p>Green – Unimportant scratches and contaminations Red – Serious scratches and contaminations that may impact signal quality</p>
<p>Zoom Control Help</p>	<p>Zoom Control Help: Press this submenu key to display a Help message with instructions on how to zoom and pan the image. Press Dismiss to close the message box.</p>

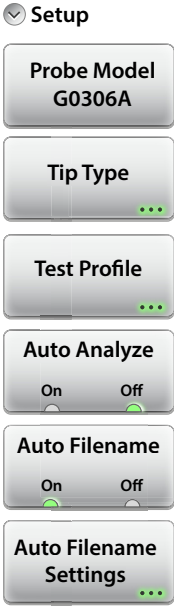
Figure 15-13. VIP Measurement Menu

File Menu

Key Sequence: **Save/Recall**

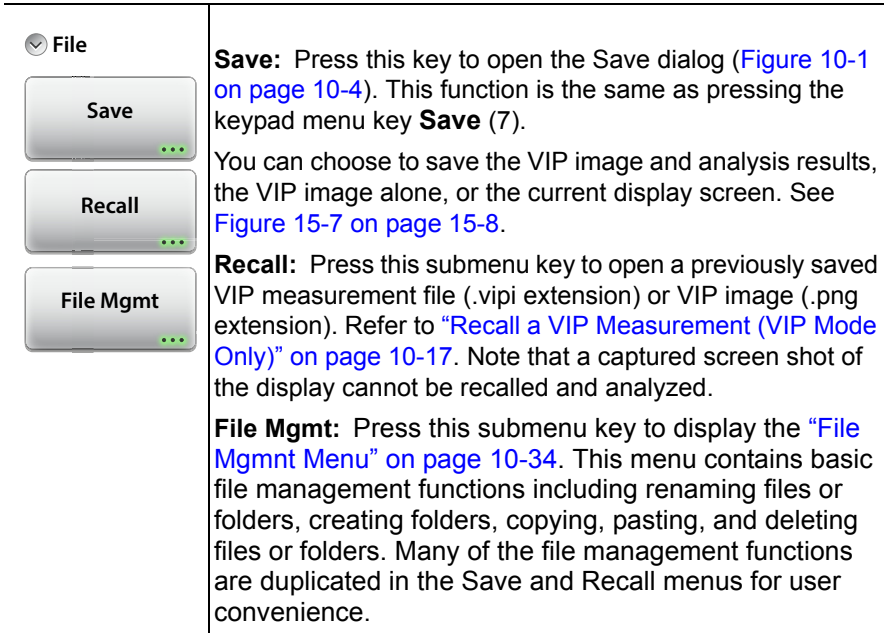

Figure 15-14. File Menu

Report Menu

Key Sequence: **Report**

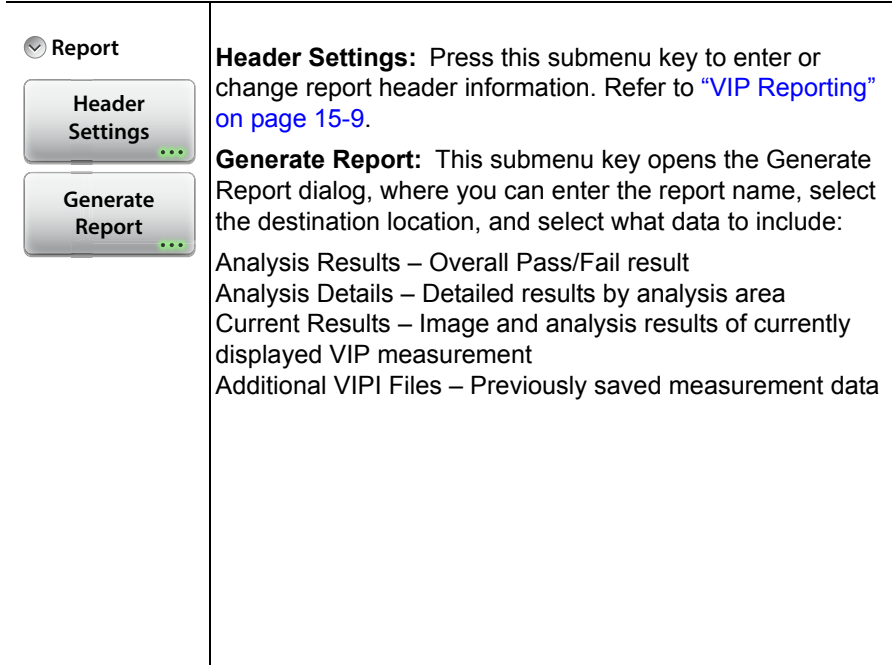

Figure 15-15. VIP Report Menu

Appendix A — Instrument Messages

A-1 Introduction

This appendix provides additional details regarding messages displayed on the S820E Site Master. The text of the dialog boxes is shown below, listed in alphabetical order.

Example Message:

Message Shown in Instrument: Additional details or suggestions regarding the message.

- 1. Command to USB device returns error or invalid data:** Check the connection to the USB device and try again.
- 2. Device not ready:** Device being accessed is not ready or responding. Try to access again.
- 3. EEPROM corrupted:** EEPROM device being accessed has been corrupted. Perform a Factory Reset under the [“Preset Menu” on page 11-27](#) and then cycle the instrument power. If the error message persists, call your Anritsu Service Center.
- 4. Encountered error in loading cable list. Default file restored:** The cable list file has been corrupted and will not be loaded. The default file has been used.
- 5. Encountered error in loading keyboard settings. Default file restored:** The onscreen keyboard file has been corrupted and will not be loaded. The default file has been used.
- 6. Encountered error in loading shortcut icon settings. Default file restored:** The menu shortcut file has been corrupted and will not be loaded. The default file has been used.
- 7. Encountered error in restoring last setup. Default file restored:** The last setup file has been corrupted and will not be loaded. The default file has been used.
- 8. Error executing remote command:** The remote command sent to the instrument has generated an unexpected error. Perform a Factory

Reset and then cycle the power to the instrument. If error message persists, call your Anritsu Service Center.

9. **Error executing remote query command:** The remote query command sent to the instrument has generated an unexpected error. Perform a Factory Reset and then cycle the power to the instrument. If error message persists, call your Anritsu Service Center.
10. **Error occurred while zeroing. Please zero sensor without RF input:** When zeroing a USB power sensor, the RF input connector of the sensor must not be connected to any source of RF power. If RF power is detected during the zeroing, then the calibration will fail and the zeroing will not be applied.
11. **File cannot be recalled:** File being recalled failed because the instrument model used when the file was saved does not match the current instrument model.
12. **File missing:** File being accessed cannot be found. The file has either been deleted or moved to a different location.
13. **Forward relative not applicable:** For the USB In-line power sensor, relative readings do not apply when making forward measurements of CCDF.
14. **Hardware driver failed to load:** One of the hardware drivers required has not loaded correctly. Perform a Factory Reset and then cycle the power to the instrument. If error message persists, call your Anritsu Service Center.
15. **Loading USB Sensor ... :** The USB power sensor has been detected and a connection is being established to this sensor.
16. **Model Mismatch:** When recalling a setup file or measurement file, this message is displayed if the file being recalled was generated by an instrument that is not the same model as the one being used to recall the file.
17. **PLL Lock failed:** Phase Lock Loop hardware has failed to lock. Perform a Factory Reset and then cycle the power to the instrument. If error message persists, call your Anritsu Service Center.
18. **Recalling File...Failed:** An error was encountered while recalling the file. The recall process was aborted. Try again. If the error persists, then the file may be corrupted.
19. **Reverse relative not applicable:** For the USB In-line power sensor, relative readings do not apply when making reverse measurements of Reflection Coefficient, Return Loss, or VSWR.

- 20. Saving File...Failed:** An error was encountered while saving the file. The save process was aborted. Check that the destination location is accessible and try again. If the problem persists, then the current setup may have corrupted parameters or data. Preset the instrument and try saving the file again.
- 21. USB drive missing. Please connect one to either USB port:** No USB flash drive was found while copying log files. Check that the USB drive is installed correctly and try again.
- 22. Verifying easyTest File ... :** When an easyTest file is first opened, a check is performed to ensure that the file is compatible with the instrument and that the file is not corrupted. After the verification passes the file is recalled. If it fails, then a message box is displayed with more specific information about the failure.
- 23. Zero Sensor completed:** The zeroing function performed on the attached USB power sensor has been completed.

Appendix B — Measurement Review

B-1 Introduction

This appendix provides additional data about typical cable and antenna measurements.

B-2 Measurement Overview

What is Measured?

Line sweeping is a quality measure of the transmission lines or antenna system or both. Systems may include cables, connectors, lightning protectors, tower mounted amplifiers, and antennas ([Figure B-1](#)). Line sweeping can measure the power losses in the system at the functional frequencies. Line sweeping measures system impedance and confirms whether the system meets carrier specifications.

If the system does not meet specification, then line sweeping can also locate components that are reflecting power above specified levels.

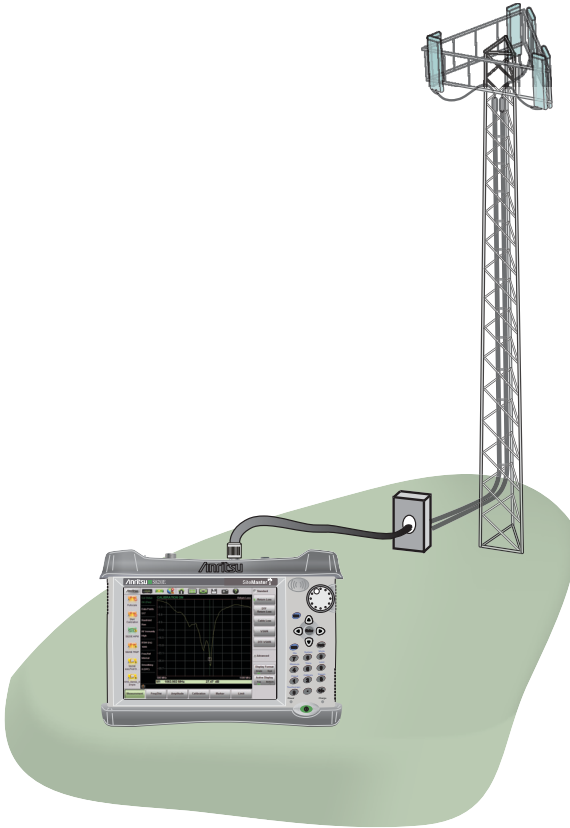

Figure B-1. Cable and Antenna Line Sweeping

Note

The Site Master does not measure system linearity (PIM Testing). Anritsu also sells the PIM Master, which is available in several carrier bands. The PIM Master tests for passive inter-modulation.

Why Measure?

The basic goal of a wireless communication system is to transfer the maximum amount of RF energy to achieve coverage (Figure B-2). Wireless communication systems require good integration of all components from the ground to the antenna. Problems such as dented shielding, bad connectors, water ingress, or over-torque will cause a mismatch and reflect power in a manner that reduces RF energy transfer.

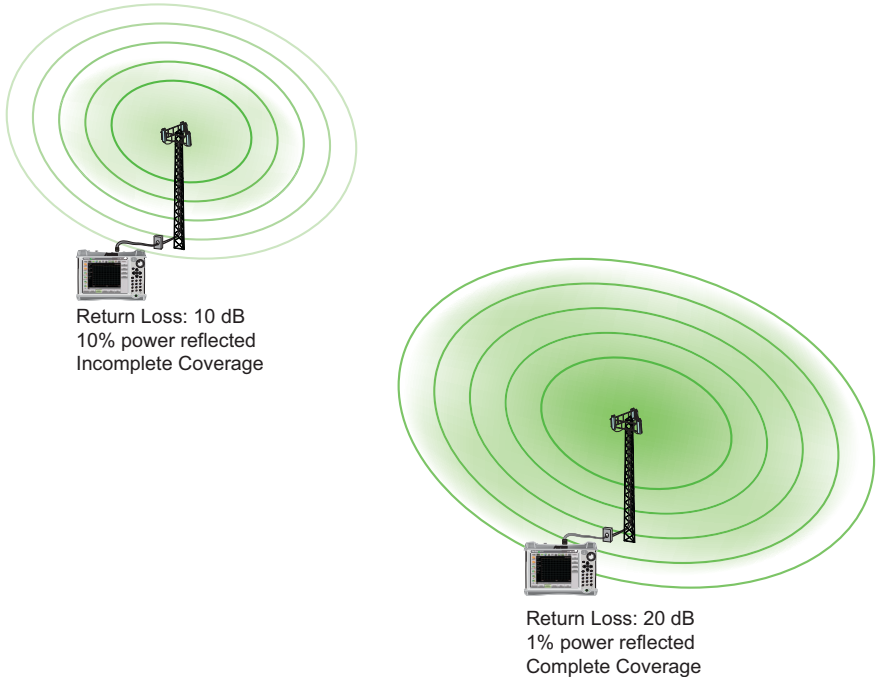

Figure B-2. Coverage Area

Line Sweeping

System performance issues are seen in two ways: excessive reflections (more common) caused by impedance mismatches, or excessive insertion losses (less common) caused by energy dissipated in the connectors or cables.

The two measurements that are used to determine communication system performance are:

- Return Loss or Standing Wave Ratio (SWR) for reflections.
- Cable Loss (Insertion Loss) for insertion losses.

Remember that Return Loss and VSWR are typically Pass/Fail tests. They both measure reflection, but they display the results in different ways. For either measurement, set a limit line to the specification determined by the carrier and make the measurement. If the *ENTIRE* swept frequency range is below the limit line, then the test passes. If *ANY* part of the sweep is at or above the limit line, then the test fails.

With a failed test, one or more components is at fault. Distance to Fault mode is used to find the problem. [Figure B-3](#) shows a failed Return Loss measurement (part of the trace is above the limit line). [Figure B-4 on page B-5](#) is a Distance to Fault measurement of the same system.

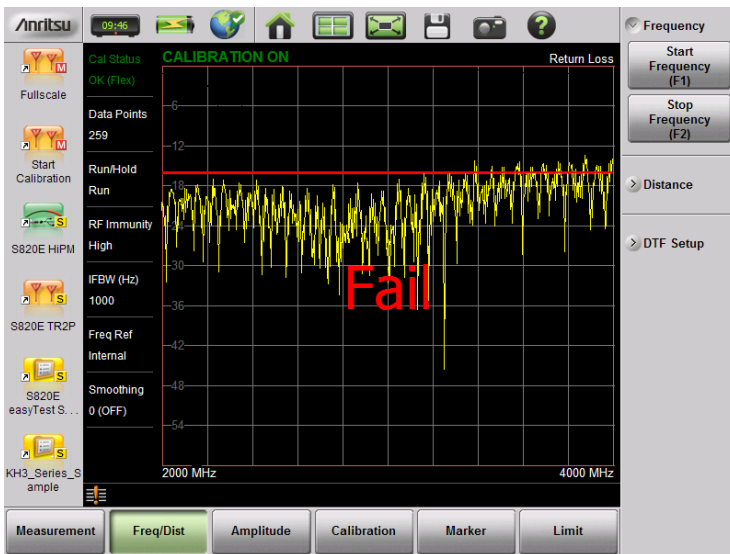
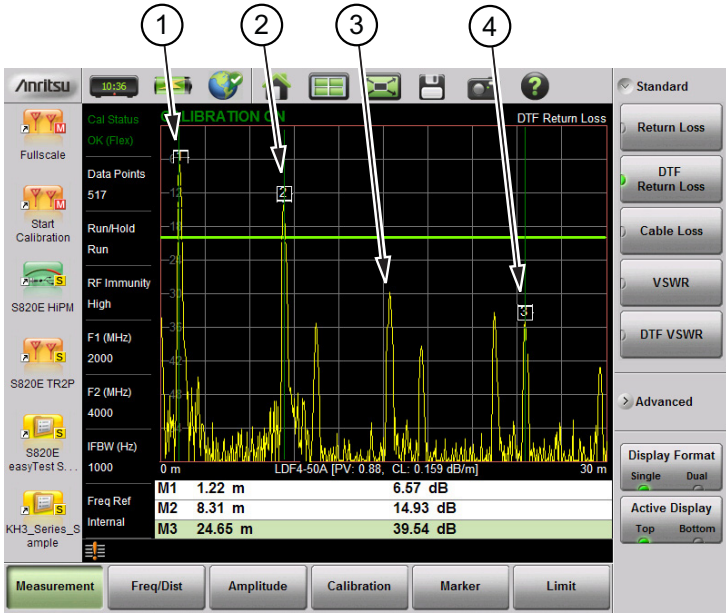

Figure B-3. Failed Return Loss Measurement



1.	Failure at Jumper (1.22 m)
2.	Possible Failure at 8.31 m
3.	Example of Good Connector (~30 dB)
4.	Precision Load Connected at End of Cable (24.65 m)

Figure B-4. Distance to Fault Measurement Shows Failing Components

The second common Line Sweeping measurement is Cable Loss (Figure B-5 on page B-6). This is a measure of signal output power compared to input power. If output power is smaller than input power, then the loss comes from heat and leakage. Cable manufacturers will specify the loss per foot or meter at different frequencies and may call it attenuation. The Site Master has loss specifications preinstalled for many cable types.

The Cable Loss measurement is typically a Pass/Fail measurement. It requires a short or open at the cable end. This is a typical measurement specified on new installations or main transmission line replacement, but it is not typically tested on existing systems.

Note Cable Loss cannot be measured with an antenna connected.

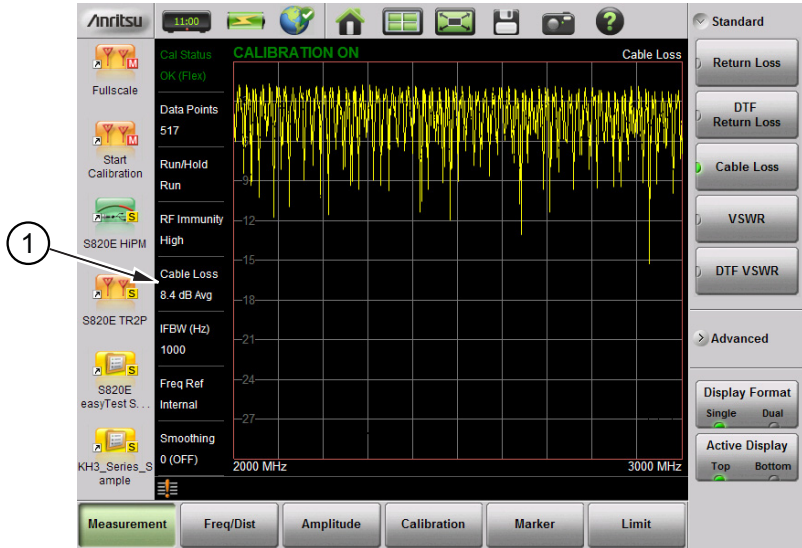

1 | Average Cable Loss

Figure B-5. Cable Loss Measurement

Calibration

For accurate results, the instrument must be calibrated before making any measurements.

The Cable and Antenna Analyzer mode requires calibration standards or external sensors, which are sold separately.

The instrument must be re-calibrated whenever the temperature exceeds the calibration temperature range window or whenever the test port extension cable is removed or replaced. The instrument must also be re-calibrated every time the setup frequency changes. Refer to [Chapter 4](#) for details on how to perform a calibration and the various calibration options available for coaxial cable and waveguide measurements.

Note

Anritsu recommends allowing the S820E to warm up for at least 10 minutes to typical operation temperature before calibrating. The instrument will require a new calibration if the internal instrument temperature changes more than ± 10 °C after calibration.

The external InstaCal Calibration Module is *NOT* compatible with the Microwave Site Master S820E.

B-3 Measurement Review

Table B-1 provides a summary of the typical measurements and required cable end tool. The typical values are for general information purposes. The carriers will provide final values in the acceptance testing specification.

Table B-1. Cable and Antenna Measurement Overview

Measurement	Mode	End Tool	Marker
TYPICAL PASS/FAIL MEASUREMENTS			
Pass/Fail Test of Cable & Connectors	Freq Return Loss or (Freq, SWR)	Load	Peak
Pass/Fail Test of System Including Antenna	Freq Return Loss or (Freq, SWR)	Antenna	Peak
Frequency Range of Antenna	Freq Return Loss or (Freq, SWR)	Antenna	Valley
Cable Loss	Freq Cable Loss	Short or Open	Peak & Valley
Cable Loss (High Accuracy)	Freq Cable Loss (Open and Short) / 2 using trace memory function	Short and Open	Peak
Return Loss	Freq Return Loss	Load	Peak
TROUBLESHOOTING MEASUREMENTS			
Cable Length	DTF Return Loss or (DTF SWR)	Short or Open	Peak
Good Cable & Connectors	DTF Return Loss or (DTF SWR)	Load	Peak
Good System Including Antenna	DTF Return Loss or (DTF SWR)	Antenna	Peak

B-4 Common RF Terms

Refer to [Appendix C, “Glossary”](#) for additional definitions of common RF terms that may be associated with the use of an S820E Site Master.

3 dB rule: A 3 dB gain means twice (x2) the power. A 3 dB loss means half the power. A system with 40 watts of input power and a 6 dB insertion loss will have only 10 watts of output power.

dB: Decibel, a logarithm ratio of the difference between two values (a logarithm ratio is equal to 10 times). The Site Master uses dB to measure the ratio of sent signal energy to reflected signal energy.

Common values of dB to ratios: 0 dB = 1:1, 10 dB = 10:1, 20 dB = 100:1, 30 dB = 1,000:1, -30 dB = 0.001:1, or (1/1000):1.

dBm: An absolute measurement of power relative to 1 milliwatt.

0 dBm = 1.0 milliwatt,
10 dBm = 10 milliwatt,
30 dBm = (1 mW x 1,000) = 1 watt.

DTF (Distance to Fault): Measures the location and reflection size of impedance mismatches. This is typically a diagnostic measurement, not a pass/fail judgment measurement. DTF is used to identify and locate faults within an antenna system when the system is failing to meet the specified return loss or VSWR limits. DTF is also useful to verify the total length of a coaxial cable assembly.

Impedance: A measure of RF component electrical resistance, measured in ohms (Ω). In most cable and antenna systems, the standard impedance is 50 Ω .

Insertion Loss (Cable Loss): Measures the total amount of signal energy absorbed (lost) by the cable assembly. Measured in dB. S_{21} is another name for this measurement. This is often a pass/fail measurement.

Return Loss: Measurement in dB of reflected energy caused by impedance mismatch. May also be referred to as S_{11} . Although S_{11} values are expressed as negative numbers, Return Loss values are expressed as positive numbers because by definition the “Loss” expression implies a negative sign. The higher the value, the better the impedance match (*think of a large negative number being less than a smaller negative number*). 40 dB is nearly ideal. Only 0.01 % of the total transmitted power is reflected if the Return Loss measurement value is 40 dB. A measured value of 0 dB would be a complete reflection, or stated another way, 100 % of the transmitted power is reflected back. Return Loss is typically a pass/fail measurement.

RF (Radio Frequency): Frequency of radio sine waves. The RF range is 3 kHz to 300 GHz.

VSWR (Voltage Standing Wave Ratio): Another method to measure reflected energy caused by impedance mismatch. Expressed as a ratio of X:1. VSWR measures the voltage peaks and valleys. A ratio of 1:1 would be a perfect match. A typical cable and antenna system would be around 1.43:1 (VSWR) or 15 dB Return Loss. The Site Master can measure either Return Loss or VSWR. Some carriers require that Return Loss is measured in VSWR. This is typically a pass/fail measurement.

Watt: Unit of measure for power.

B-5 Standard Line Sweep Measurements

To verify the performance of the transmission feed line system and to analyze typical problems, three types of line sweeps are required:

- Return Loss
- Cable Loss
- Distance-To-Fault

The measurements for these sweeps are defined as

- Return Loss — System Sweep
- Cable Loss — Cable Loss Sweep
- DTF — Load Sweep

Return Loss / VSWR Measurement

Return Loss measures the reflected power of the system in decibels (dB). This measurement can also be taken in the Standing Wave Ratio (SWR) mode, which is the ratio of voltage peaks to voltage valleys, as caused by reflections.

Cable Loss Measurement

Cable Loss measures the energy absorbed, or lost, by the transmission line in dB/meter or dB/ft. Different transmission lines have different losses, and the loss is both frequency-specific and distance-specific. The higher the frequency or longer the distance, the greater the loss.

Distance-To-Fault (DTF) Measurement

A DTF measurement reveals the precise fault location of components in the transmission line system. This test helps to identify specific problems in the system, such as connector transitions, jumpers, kinks in the cable, moisture intrusion, or mechanical damage.

Line Sweep Measurement Types

Return Loss – System Sweep

Return Loss is the measurement made when the antenna is connected at the end of the transmission line. This measurement provides an analysis of how the various components of the system are interacting. It provides an aggregate return loss of the entire system.

Distance To Fault – Load Sweep

A measurement is made with the antenna disconnected. The antenna is replaced with a $50\ \Omega$ precision load at the end of the transmission line. This measurement allows analysis of the various components of the transmission feed line system in the DTF mode.

Cable Loss – Cable Loss Sweep

A Cable Loss Sweep is a measurement made when a short is connected at the end of the transmission line. This condition allows analysis of the signal loss through the transmission line. This measurement identifies problems in the system. High insertion loss in the feed line or jumpers can contribute to poor system performance and loss of coverage.

This whole process of measurements and of testing the transmission line system is called Line Sweeping.

Advanced measurements are described in [Section 3-6 “Advanced Measurements” on page 3-23](#). They including Transmission (2-Port), Transmission (External Sensor), Smith Chart, and 1-Port Phase.

Appendix C — Glossary

C-1 Introduction

This glossary provides definitions for common RF terms that may be associated with the use of an S820E Site Master.

C-2 Glossary Terms

3 dB rule : The 3 dB rule provides a means to estimate relative power values. A 3 dB gain indicates that power increases to twice the power (a multiple of 2). A 3 dB loss indicates that power decreases to half the power (a multiple of 1/2). A system with 40 watts of input power and a 6 dB insertion loss will have only 10 watts of output power (a multiple of 1/2 for each 3 dB loss, or 1/4 of 40 watts).

Adapter : A fitting that supplies a passage between two sets of equipment when they cannot be directly interconnected.

Adaptive Array

Antenna : Adaptive array antenna is a type of advanced 'smart' antenna technology that continually monitors a received signal and dynamically adapts signal patterns to optimize wireless system performance. The arrays use signal processing algorithms to adapt to user movement, to changes in the radio-frequency environment, and to multi-path and co-channel interference.

ADC : Analog-to-Digital Converter (ADC, A/D or A to D) is an electronic device that converts continuous signals to discrete digital numbers. The reverse operation is performed by a digital-to-analog converter (DAC). ADC can uniquely represent all analog input values within a specified total input range by a limited number of digital output codes. Refer also to DAC.

Analog System : An Analog system uses an analog transmission method to send voice, video and data-using analog signals, such as electricity or sound waves, that are continuously variable rather than discrete units as in digital transmissions. Mobile analog systems include AMPS, NMT and ETACS.

Analog

Transmission : Analog Transmission refers to signals propagated through the medium as continuously varying electromagnetic waves.

Antenna Gain : Antenna gain, also known as antenna directivity, is the relative gain of the main beam of an antenna pattern to a reference antenna, usually an isotropic or standard dipole. Antenna Gain is the effectiveness of a directional antenna expressed as the ratio of input power of the directional antenna to input power of an isotropic radiator to provide the same field strength in the desired direction. Sometimes related to a dipole antenna.

Attenuation : Attenuation refers to decreasing in signal magnitude between two points. These points may be along a radio path, transmission line or other devices.

Attenuator : Attenuator is a device specifically designed to decrease the magnitude of a signal transmitted through it.

- Average power :** Average power is the peak power averaged over time and is usually applied to pulsed systems where the carrier power is switched on and off.
- Backhaul :** In wireless technology, backhaul refers to transporting voice and data traffic from a cell site to the switch.
- Band Pass Filter :** A Band Pass Filter is a radio wave filter with a specific range of frequencies in which it is designed to pass. It rejects frequencies outside the pass-band range. A resistor-inductor-capacitor circuit is an example of a Band Pass Filter.
- Bandwidth :** Bandwidth usually identifies the capacity of a circuit or amount of data that can be sent through a given circuit. It may be user-specified in a PVC. It is an indication of the amount of data that is passing over a medium. Also, bandwidth is the portion of the frequency spectrum required to transmit desired information. Each radio channel has a center frequency and additional frequencies above and below this carrier frequency which is used to carry the transmitted information. The range of frequencies from the lowest to the highest used is called the bandwidth.
- Bandwidth Ratio :** Bandwidth Ratio is the ratio of two devices having differing bandwidths, not necessarily in the same frequency spectrum.

- BER :** Bit Error Rate or Bit Error Ratio (link quality specification/testing) (BER) is a measure of transmission quality. The ratio of error bits to the total number of bits transmitted. A bit error rate of 10^{-6} refers to an average of one error per million bits. It is generally shown as a negative exponent, (for example, 10^{-7} which means 1 out of 10⁷ bits are in error or 1 out of 10,000,000 bits are in error). Bit Error Rate is the fraction of a sequence of message bits that are in error.
- BERT :** Bit Error Rate Test/Tester (BERT) is a test that gauges the quality of the T1 or digital line. By sending a known pattern to another device across the span, the far end device can compare incoming pattern to its own, thereby indicating bit errors on the line.
- Broadband :** Broadband refers to telecommunication that provides multiple channels of data over a single communications medium, typically using some form of frequency or wave division multiplexing. It is a service or system requiring transmission channels capable of supporting rates greater than the Integrated Services Digital Network (ISDN) primary rate.
- CCDF :** Complementary Cumulative Distribution Function (CCDF) is a method used to characterize the peak power statistics of a digitally modulated signal. The CCDF curve can be used to determine design parameters for CDMA systems (such as the amount of back-off to run in a power amplifier).

Cell : In wireless communication, a Cell is the geographic area encompassing the signal range from one base station (a site containing a radio transmitter/receiver and network communication equipment). Wireless transmission networks are composed of many hexagonal, overlapping cell sites to efficiently use radio spectrum for wireless transmissions. Also, cell is the basis for the term 'cellular phone.'

Cell Delineation : Cell Delineation is the process for recognizing the beginning and end of ATM cells within the raw serial bit stream.

Cell Site : Cell Site, also called Base Station, is the local cellular tower and radio antenna (including the radios, controller, switch interconnect, etc.) that handles communication with subscribers in a particular area or cell. A cellular network is made up of many cell sites, all connected back to the switch via landline or microwave.

Cellular : In wireless communications, cellular refers most basically to the structure of the wireless transmission networks which are comprised of cells or transmission sites. Cellular is also the name of the wireless telephone system originally developed by Bell Laboratories that used low-powered analog radio equipment to transmit within cells. The terms 'cellular phone' or 'cell phone' are used interchangeably to refer to wireless phones. Within the wireless industry, cellular is also used to refer to non-PCS products and services.

Coaxial Cable : Coaxial Cable (Coax) is a type of electrical communications medium used in the LAN environment. This cable consists of an outer conductor concentric to an inner conductor, separated from each other by insulating material, and covered by some protective outer material. This medium offers large bandwidth, supporting high data rates with high immunity to electrical interference and a low incidence of errors. Coax is subject to distance limitations and is relatively expensive and difficult to install.

Configuration

Commands : Configuration Commands are commands that are issued to an instrument and that change a specific instrument configuration.

COW : Cell site On Wheels (COW) is a mobile site placed at a location to fill in or increase coverage.

CPLT : Cell Site on Light Truck (CPLT) is a mobile site on a vehicle placed at a location to fill in or increase coverage.

CPM : Continuous Phase Modulation (CPM) is a phase modulation technique employing smooth transitions between signal states. This reduces sidelobe spectral energy and improves co-channel performance.

CW : Continuous Wave (CW)

DANL : Displayed Average Noise Level (DANL): Displayed average noise level is sometimes confused with the term Sensitivity. While related, these terms have different meanings. Sensitivity is a measure of the minimum signal level that yields a defined signal-to-noise ratio (SNR) or bit error rate (BER). It is a common metric of radio receiver performance. Spectrum analyzer specifications are always given in terms of the DANL. One of the primary uses of a spectrum analyzer is to search out and measure low-level signals. The limitation in these measurements is the noise generated within the spectrum analyzer itself. This noise, generated by the random electron motion in various circuit elements, is amplified by multiple gain stages in the analyzer and appears on the display as a noise signal. On a spectrum analyzer, this noise is commonly referred to as the Displayed Average Noise Level, or DANL. While there are techniques to measure signals slightly below the DANL, this noise power ultimately limits our ability to make measurements of low-level signals.

dB : Decibel or deciBel (dB) is a logarithmic ratio of the difference between two values (a logarithm ratio is equal to 10 times). dB is a unit for measuring relative power ratios in terms of gain or loss. The units of dB are expressed in terms of the logarithm to base 10 of a ratio and typically are expressed in watts. For example, a -3dB loss indicates a 50% loss in power; a +3dB reading is a doubling of power; 10 dB indicates an increase (or a loss) by a factor of 10; 20 dB indicates an increase (or a loss) of a factor of 100; 30 dB indicates an increase (or a loss) by a factor of 1000. Common values of dB expressed in ratios: 0 dB = 1:1, 10 dB = 10:1, 20 dB = 100:1, 30 dB = 1000:1, -30 dB = 0.001:1 [or (1/1000):1].

- dBc** : Decibels referenced to the carrier (dBc) is a technique for expressing a power measurement in logarithmic form using the carrier power as a reference. The units are used to describe how far down signals and noise are relative to a known signal. Typical use of this term is to describe spurious signals and noise compared to a desired transmit signal.
- dBd** : Decibels referenced to a dipole antenna (dBd) is a technique for expressing a power gain measurement in logarithmic form using a standard dipole antenna as a reference. dBd is a measurement of signal gain used in radio antenna design. Pecifically, dBd refers to signal gain in a dipole radiator.
- dBm** : dBm is an absolute measurement of power relative to 1 milliwatt. In other words, dBm is a decibel value referenced to a milliWatt (dBm). This is a technique for expressing a power measurement in logarithmic form using 1 mW as a reference. dBm is a decibel ratio (log 10) of Watts (W) to one milliwatt (1mW). dBm, therefore, represents absolute power. Examples are: 0 dBm = 1.0 milliwatt, 10 dBm = 10 milliwatt, 30 dBm = 1000 milliwatt = 1 watt.
- DHCP** : Dynamic Host Configuration Protocol (DHCP)
- DSP** : Digital Signal Processing (DSP)
- DSRC** : Dedicated Short Range Communications (DSRC):
DSRC is a system that is intended for communications between two vehicles, or from one vehicle to a roadside network. Efer to IEEE 802.11p.

DTF : Distance-To-Fault (DTF) is the distance from the instrument output connector (or the end of a test lead) to a problem area, as indicated by a peak in the displayed signal. DTF measures the location and reflection size of impedance mismatches. This is typically a diagnostic measurement, not a pass/fail judgement measurement. DTF is used to identify and locate faults within an antenna system when the system is failing to meet the specified return loss or VSWR limits. DTF is also useful to verify the total length of a coaxial cable assembly.

FFT : Fast Fourier Transform (FFT) is an efficient algorithm to compute the Discrete Fourier transform (DFT) and its inverse. FFTs are of great importance to a wide variety of applications, from digital signal processing to solving partial differential equations to algorithms for quickly multiplying large integers.

Flash Memory : Flash memory is a non-volatile solid state storage device that is packaged as a chip. It can be electrically erased and reprogrammed. It is primarily used in memory cards, USB flash drives, MP3 players, and solid-state drives for general storage and transfer of data between computers and other digital products. It is a specific type of EEPROM (electrically erasable programmable read-only memory) that is erased and programmed in large blocks.

GPS : The Global Positioning System (GPS) is a space-based global navigation satellite system (GNSS) that provides reliable location and time information in all weather and at all times when and where an unobstructed line of sight is available to four or more GPS satellites. The system is maintained by the United States government and is freely accessible by anyone with a GPS receiver. The Global Positioning System is making it possible for people using ground receivers to determine their geographic location within 10 to 100 meters. The satellites use simple mathematical calculations to broadcast information that is translated as longitude, latitude, and altitude by Earth-based receivers.

Impedance : Impedance is a measure of RF component electrical resistance, measured in ohms. In most cable and antenna systems, the standard impedance is 50 ohms.

Insertion Loss : Insertion Loss (or Cable Loss) is a measure of the total amount of signal energy absorbed (lost) by the cable assembly. It is measured in dB. S21 (an S-Parameter) is another name for this measurement. This is often a pass/fail measurement.

NF : Noise Figure (NF) is a measure of degradation of the signal-to-noise ratio (SNR) that is caused by components in a radio frequency (RF) device. The noise factor (F) of a system is defined as the signal-to-noise ratio of the input power of the system divided by the signal-to-noise ratio of the output power of that system. F (the noise figure) is defined as the decibel value of the noise factor. $F = 10 \log (F)$ where log uses the base 10, or common log. This formula is valid only when the input termination is at standard noise temperature.

OBW : Occupied Bandwidth (OBW) is a measure of the bandwidth containing 99% of the total integrated power of the transmitted spectrum, centered on the assigned channel frequency. Interference to other channels or to other systems can occur if OBW is too large.

OTA : Over The Air (OTA): OTA refers generally to any transfer of information or signal that takes place in a wireless environment, rather than using a wired connection. OTA is usually used in connection with a standard defining the provisioning of mobile devices and applications, such as downloading or uploading content or software, and commonly used in conjunction with the Short Messaging Service (SMS). SMS OTA Messages contain information that is used to configure the settings of a WAP browser in a mobile phone (refer to SMS and WAP).

RF : Radio Frequency (RF) is the frequency of radio sine waves. RF generally refers to wireless communications within a frequency range of 3 kHz to 300 GHz. Formally, according to the Article 2 of the Radio Law, radio frequency is below 3,000 GHz. Radio frequencies can be used for communications between a mobile telephone and an antenna mast.

VSWR : Voltage Standing Wave Ratio (VSWR). VSWR is another method to measure reflected energy caused by impedance mismatch. It is expressed as a ratio of X:1. VSWR measures the voltage peaks and valleys. A ratio of 1:1 would be a perfect match. A typical cable and antenna system would be around 1.43:1 (VSWR) or 15 dB Return Loss. The Site Master can measure either Return Loss or VSWR. Some carriers require that Return Loss is measured in VSWR. This is typically a pass/fail measurement.

Watt : Watt (w) is a unit of measure for power.

:

Index

Numerics

- 1-port
 - 1-port phase
 - submenu key 3-57
 - measurement at Port-1 . . . 2-3
 - phase of reflection meas . 3-28
 - VVM reflection meas 8-2
- 2-port
 - calibration considerations 7-2
 - measurement at Port-2 . . . 2-3
 - S-parameters, VNA mode . 6-4
 - transmission meas 3-24
 - VVM transmission meas . 8-2
- 3 dB rule description B-9

A

- A/B ratio meas, VVM 8-20
- accuracy
 - best, 2-port attenuation . 3-24
 - cut off freq of waveguide . 3-11
 - hi accuracy pwr meter . . . 9-1
 - of cable loss B-8
 - propagation velocity,
 - cable 3-11
- active trace
 - defined 6-15
- adapter
 - battery 1-5
 - calibration 4-1, 7-1
 - calibration required 4-14, 7-16
- address
 - Ethernet 11-26
 - IP or MAC 11-18
- Advanced mode
 - menu map 3-53
- advantages of VNA mode . . . 6-3
- alarm, limit line fail 3-38
- amplitude
 - scale setting 3-30
 - setting 9-5

amplitude menu

- cable + antenna analyzer 3-61
- HAPM 9-22
- power sensor MA24105A 9-31
- reference impedance 3-61, 6-28
- scale preset, CAA 3-61
- scale preset, VNA 6-28
- Smith Chart 3-61, 6-28
- VNA mode 6-28
- VVM 8-26
- annual verification 1-7

Anritsu

- contacting 1-2
- application
 - Video Inspection Probe . 15-1
- arrow cursor control 2-21
- auto-dimming the display . 11-21
- autoscale submenu key 3-61, 6-28
- average menu
 - HAPM 9-24
 - HAPM, MA24105A 9-33

B

- B/A ratio meas, VVM 8-20
- battery
 - and chargers . . 1-5, 2-21, 12-2
 - replacement 12-2

C

- cable list 3-11
- cable loss
 - 1 port vs 2 port 3-23
 - measurement 3-7
 - submenu key 3-55
- cal correction invalidated . . . 3-31

D to D

calibration

- 2 port, considerations7-2
 - cal correction invalidated 3-31
 - Cal Line setting4-7, 7-7
 - coefficients4-16, 7-17
 - errors corrected (table) . .4-5
 - inaccuracy caution .4-12, 7-13
 - interpolation, VNA .7-3, 7-19
 - menu, CAA4-18
 - menu, HAPM9-23, 9-32
 - menu, VNA7-18
 - menu, VVM8-27
 - multiple7-3
 - of instrument4-1, 7-1
 - Port 1 DUT, Cal Kit4-8
 - Port 1, 2 DUT, Cal Kit . . .7-9
 - procedures4-14, 7-16
 - reducing data points7-3
 - setup4-3, 7-5
 - stored with setup . . .7-3, 7-17
 - symbols2-29
 - temperature window . . .4-16
 - touchscreen keys11-18
 - type, CAA mode4-4
 - type, VNA mode7-6
 - VVM mode8-19
- capacitance, Smith Chart . .3-28
- capture screen image11-12
- carrying case2-30
- cautions
- air flow and fan ports . . .2-30
 - automotive
 - adapter1-5, 2-2, 12-3
 - avoid cleaning damage . . .1-6
 - batteries and chargers . .2-21
 - deleted files11-27
 - electrostatic discharge . . .1-6
 - inaccurate calibration 4-12, 7-13
- charging battery1-5, 12-2
- Classic mode
- menu map5-4
 - Limit menu5-8
 - Marker menu5-6

- coefficients of calibration 4-16, 7-17
- common RF termsB-9
- connectivity info key11-18
- connector panel2-3
- contacting Anritsu1-2
- create
 - custom cable, in list3-11
 - custom waveguide3-12
 - easyTest file14-2
 - filenames10-13
 - folder10-6, 10-32, 10-34
 - folder, main topic10-25
 - folder, submenu key . . .10-30
 - menu shortcut2-6
 - reports, LST13-4
 - self test text file11-2
 - status text file11-18
 - test sequence1-4, 14-1
 - user shortcut2-5
- custom cable, in list3-11
- custom waveguide, in list . .3-12

D

- damage, ESD cautions1-6
- data points
 - calibration considerations 7-3
 - setting3-30
 - versus cal correction . . .3-31
- date11-20
- dBm descriptionB-9

- default
 - amplitude scale 3-30
 - cal kit selection 4-8, 7-9
 - data points setting 3-30
 - EEPROM parameters 1-8
 - external USB 1-13
 - file matrix names 10-12
 - file name 10-9
 - file type 10-8
 - language, submenu key 11-15
 - preset menu 11-27
 - preset the Site Master . . . 2-9
 - RF immunity 3-32
 - running average HAPM . 9-11
 - save location, internal . . 10-5
 - save location, setting . . . 10-5
 - Site Master settings 2-9
 - delta marker 3-41
 - DHCP 11-26
 - diagnostics self test 11-2
 - dimming the display 11-22
 - display
 - display/audio menu 11-21
 - setup menu
 - HAPM MA24105A . . 9-27
 - submenu key 11-21
 - units, setting 9-7
 - distance resolution 3-14
 - distance to fault
 - description B-9
 - main topic 3-9
 - submenu key 3-55
 - dmax 3-17
 - DTF aid 3-18
 - dynamic range, 2-port 3-24
- E**
- easyTest Tools
 - main topic 14-1
 - uses 1-4
 - EEPROM memory 1-8
 - electrostatic discharge 1-6
 - erasing memory 1-9
- F**
- Ethernet
 - setup 11-26
 - Ethernet IP address 11-18
 - example
 - DTF measurement 3-18
 - feed line with antenna . . . 3-4
 - S-parameters 6-4
 - trace math
 - compare cables 3-49
 - VVM splitter B/A 8-6
 - external USB memory 1-8
 - EZ name matrix 10-10
- F**
- FAQ button, help menu 11-7
 - file
 - management 10-4
 - management menu 10-34
 - menu 10-28, 15-14
 - name, choosing 10-9
 - names 10-10
 - type, setting and default 10-8
 - types, by extension 10-3
 - firmware
 - updating 11-10
 - version 11-6, 11-18
 - firmware version, help menu 11-6
 - folder, create 10-6
 - formula
 - group delay 6-7
 - log magnitude 6-5
 - log magnitude/2 6-6
 - $S_{\text{Imaginary}}$ 6-6
 - Smith Chart 6-7
 - S_{Real} 6-6
 - SWR 6-7
 - forward reflection 6-4
 - forward transmission 6-4
 - freq menu
 - CAA 3-58
 - VNA 6-23
 - frequency
 - calibration considerations 7-2

G to I

frequency menu
CAA 3-58
HAPM 9-21
HAPM MA24105A 9-30
VNA 6-23
VVM 8-26

full 2-port calibration
calibration considerations . 7-2
full-reversing VNA 6-3
fullscale submenu key 3-61

G

GPS
icon description 2-20
in status tool bar 2-19
info dialog box image 2-21, 11-24
last fix vs current data . 11-25
menu 11-24
submenu key 11-16
time and date settings . 11-20
graph type, VNA mode 6-22, 6-26

H

help menu
main topic 11-5
FAQ button 11-7
firmware version 11-6
system information 11-6
user guide 11-9

high accuracy power meter HAPM
ampl menu, MA24105A . 9-31
amplitude menu 9-22
average menu 9-24
avg menu, MA24105A . . 9-33
calibration menu . . 9-23, 9-32
display setup MA24105A 9-27
forward menu 9-28
freq menu, MA24105A . . 9-30
frequency 9-5
frequency menu 9-21
limit menu 9-25
limit menu, MA24105A . 9-34
limits 9-9
menu map 9-20
reverse menu 9-29
setup 9-4

I

IFBW
C&A measurements 3-33
range vs sweep speed ... 3-33
impedance
data, Smith Chart 3-28
description B-9
inaccurate cal caution . 4-12, 7-13
inductance, Smith Chart ... 3-28
insertion loss, description ... B-9
internal memory 1-3
internal temperature 11-18
interpolation
regenerating cal coefficients 7-3
VNA cal extension 7-19
invalidating cal correction . . 3-31

L

- limit
 - limit state menu, VNA . . 6-32
 - menu HAPM 9-25
 - menu HAPM MA24105A 9-34
 - menu, Advanced mode 3-65, 3-66
 - menu, Classic mode 5-8
 - menu, edit segments 6-33
 - menu, segments 3-66
 - menu, VNA 6-31
 - pass/fail, message . . 3-39, 5-9
 - pass/fail, setting, HAPM . . 9-9
 - segments 3-35
 - upper or lower 3-34
- Line Sweep Tools (LST) 1-3
- line sweeping B-4
- links
 - contacting Anritsu 1-2
 - S820E product page 1-2
- list
 - cable 3-11
 - waveguide 3-12
- live trace vs recalled trace . . 3-48
- lock touchscreen 2-21

M

- MA24105A
 - amplitude menu 9-31
 - average menu 9-33
 - calibration menu 9-32
 - display setup menu 9-27
 - forward menu 9-28
 - frequency menu 9-30
 - limit menu 9-34
 - menu map 9-26
 - reverse menu 9-29
- MAC address 11-18, 11-26
- magnifying glass, VNA trace 6-15
- main board temp, help menu 11-6
- maintenance 1-6
- marker
 - menu, Classic 5-6, 5-7
 - menu, search 3-64
 - menu, setup, CAA 3-63
 - menu, setup, VNA 6-29
 - setup 3-40
 - table 3-42
 - tracking 3-44
- master reset 1-9
- master reset submenu key . 11-28
- matrix names, changing . . . 10-12
- maximum usable distance . . 3-17
- measurement
 - advanced 3-23
 - menu, Advanced 3-55
 - menu, VNA 6-20
 - return loss and VSWR . . . 3-4
 - VVM 8-9
- memory
 - erasing 1-9
 - security 1-8
 - Site Master memory
 - types 1-8
- menu map 15-11
 - Advanced mode 3-53
 - Classic mode 5-4
 - HAPM 9-20
 - MA24105A, HAPM 9-26
 - VNA mode 6-17
 - VVM mode 8-21
- menu shortcut, creating 2-6
- menu, VNA 6-42
 - Amplitude 6-28
 - Calibration 7-18
 - Freq/Dist 6-23
 - Limit 6-31
 - Limit State 6-32
 - Marker 6-29
 - Measurement 6-20
 - Sweep 6-35
 - Windowing 6-27

N to S

- menu, VVM
 - amplitude 8-26
 - calibration 8-27
 - frequency 8-26
 - measurement 8-22
 - sweep 8-29
- menus
 - Advanced mode 3-53
 - Classic mode 5-4
 - HAPM 9-20
 - MA24105A 9-26
 - VNA mode 6-17
 - VVM mode 8-21
- multiple calibrations 7-3

N

- nonfunctional shortcut 2-6
- number of traces, VNA 6-21

O

- offset value, amplitude 9-5
- option configuration
 - dialog box 11-17
 - submenu key 11-15

P

- package version
 - firmware, help menu ... 11-6
 - firmware, status menu . 11-18
- pass/fail
 - limit alarm 3-38
 - message 3-39, 5-9
 - setting limits 9-9
- phase
 - matching, VVM setup ... 8-9
 - reflection measurements
 - 1-port 3-28
 - trace math comparison . 3-28
- phase vs unwrapped phase
 - description and image ... 6-8
 - formula and applications . 6-6
- points, data points setting . . 3-30

- Port 1
 - DUT, Cal Kit 4-8, 7-9
 - restriction 3-55
- Port 2
 - DUT, Cal Kit 7-9
- power meter, high accuracy . . 9-1
- power supply 2-2
- preset
 - menu 11-27
 - the Site Master 2-9
- preventing invalid
 - cal correction 3-31

R

- RAM Memory 1-8
- recall menu 10-32
- reference impedance
 - submenu key 3-61, 6-28
- reflection parameters 6-4
- relative power
 - setting 9-7, 9-18
- reset
 - factory default values ... 1-9
 - factory reset 11-27
 - master reset 1-9
 - resetting memory 1-9
- restriction for Port 1 3-55
- return loss
 - description B-9
 - measurement 3-4
 - submenu key 3-55
- reverse reflection or transmission
6-4
- RF immunity 3-32
- RF terms, common B-9

S

- S_{11} , S_{21} , S_{12} , S_{22} descriptions . 6-4
- S820E product page
 - (URL) 1-2
- save menu 10-29
- save screen image 11-12

- scale preset
 - default values, CAA 3-61
 - default values, VNA 6-28
 - submenu key, CAA 3-61
 - submenu key, VNA 6-28
 - screen
 - touch lock 2-21
 - touch unlock 2-21
 - screen shot menu 11-12
 - secure environment
 - workplace 1-8
 - segments
 - limit lines 3-35
 - limit menu 3-66, 6-33
 - self test
 - at start up 11-2
 - submenu key 11-15
 - serial number
 - System Info 11-6
 - setting
 - date 11-20
 - display units 9-7
 - pass/fail limits 9-9
 - relative power 9-7, 9-18
 - time 11-20
 - setup
 - high accy power meter . . . 9-4
 - setup file contains cal data . . 7-17
 - shortcut
 - customize 2-6
 - deleting 2-7
 - for setup file 2-6
 - for submenu key 2-6
 - icons 2-7
 - nonfunctional 2-6
 - tool bar 2-13
 - tool bar image 2-12
 - user-created 2-5
 - Site Master memory types . . . 1-8
 - Smith Chart
 - formula 6-7
 - graphical tool 3-28
 - impedance data 3-28
 - ref impedance
 - submenu key . . 3-61, 6-28
 - submenu key 3-56
 - source power
 - Adv CAA, power levels . . 3-33
 - VNA, cal correction On . . 7-3
 - VVM, sweep menu 8-29
 - S-parameters
 - calibration 7-2
 - defined 6-4
 - examples 6-4
 - stand 2-30, 2-31
 - status menu 11-18, 11-20
 - stylus 11-4
 - sweep averaging 3-33
 - sweep menu
 - CAA 3-67
 - VNA 6-35
 - VVM 8-29
 - sweep trigger
 - description 3-31
 - menu, CAA 3-68
 - menu, VNA 6-36
 - system
 - menu 11-15, 11-16
 - self test 11-2
- ## T
- table display format (VVM)
 - clearing reference 8-11
 - main description 8-12
 - temperature
 - status menu 11-18
 - system info 11-6
 - window, calibration 4-16
 - terms, common to RF B-9
 - thru device, VNA mode 7-15
 - tilt bail 2-31
 - time 11-20

U to V

time zone11-20
touchscreen
 keys2-15
 lock2-21
 unlock2-21
Trace6-42
trace
 active, VNA mode6-15
 format, VNA6-21
 menu3-69, 6-43
 menu, VNA6-42
 overlay, examples3-48
 sweep averaging3-33
trace math
 main topic3-47
 operations3-48
 phase measurements ...3-28
 submenu key3-69, 6-43
tracking markers3-44
transmission 2-port
 submenu key3-56
transmission ext. sensor
 submenu key3-56
transmission parameters ...6-4
trigger sweep, CAA3-31

U

units
 setting display units9-7
unlock touchscreen2-21
unwrapped phase vs phase
 description and image ...6-8
 formula and applications .6-6
update firmware11-28
USB
 connectors2-4
 external, default memory 1-13
 memory1-8
user guide, help menu11-9

V

vector-corrected, 2-port3-24

version
 package, firmware 11-6, 11-18
Video Inspection Probe. See VIP
VIP15-1
 analysis15-6
 connection15-3
 Measurement menu ...15-13
 menus15-11
 report15-9, 15-15
 setup15-3
 Setup menu15-12
 test settings15-4
VNA menu
 amplitude6-28
 calibration7-18
 freq/dist6-23
 marker setup6-29
 measurement6-20
 start calibration7-21
 sweep6-35
 trace6-42

VNA mode

 advantages6-3
 full-reversing6-3
 graph type6-22, 6-26
 interpolation7-19
 menu map6-17
 thru device7-15
 trace format and number 6-21
 trace magnifying glass ..6-15
 unwrapped phase, appl ..6-6
 unwrapped phase, image .6-8
volume submenu key11-21

VSWR

 descriptionB-10
 measurement3-4
 submenu key3-55

VVM example splitter B/A ...8-6

VVM menu

 amplitude8-26
 calibration8-27
 frequency8-26
 sweep8-29

VVM mode

- A/B, B/A measurements . 8-20
- block diagram, B/A 8-5
- block diagram, reflection . 8-3
- block diagram, trans meas 8-4
- calibration 8-19
- how it works 8-2
- IFBW dialog box 8-30
- menu map 8-21
- relative measurements . . . 8-9
- table display format 8-12

W**warnings**

- deleting files 10-24
- instrument damage 11-11

Watt description B-10**waveguide**

- automotive power outlet . . 2-2
- list 3-12

web links

- S820E product page 1-2

web site

- contacting Anritsu 1-2

windowing 3-16**windowing menu 3-60, 6-27**

Anritsu



10580-00343



K



Anritsu utilizes recycled paper and environmentally conscious inks and toner.

Anritsu Company
490 Jarvis Drive
Morgan Hill, CA 95037-2809
USA

<http://www.anritsu.com>