

R&S® Spectrum Rider FPH Handheld Spectrum Analyzer User Manual



1321101102
Version 13



This manual describes the following R&S®FPH models and options with firmware version 2.30 and higher:

- R&S®FPH (1321.1111.02)
- R&S®FPH (1321.1111.06)
- R&S®FPH (1321.1111.13)
- R&S®FPH (1321.1711.23)
- R&S®FPH (1321.1111.26)
- R&S®FPH (1321.1711.36)
- R&S®FPH (1321.1711.44)
- R&S®FPH (1321.1711.54)
- R&S®FPH-B3 (1321.0667.02), R&S®FPH-B4 (1321.0673.02)
- R&S®FPH-B8 (1321.0767.02), R&S®FPH-B20 (1321.0773.02)
- R&S®FPH-B22 (1321.0680.02), R&S®FPH-B23 (1321.0867.02)
- R&S®FPH-B24 (1321.0850.02), R&S®FPH-B25 (1321.0873.02)
- R&S®FPH-B26 (1334.6600.02) R&S®FPH-B31 (1321.0780.02)
- R&S®FPH-K7 (1321.0696.02), R&S®FPH-K9 (1321.0709.02)
- R&S®FPH-K15 (1321.0715.02), R&S®FPH-K16 (1321.0615.02)
- R&S®FPH-K19 (1321.0721.02), R&S®FPH-K29 (1321.0738.02)
- R&S®FPH-K35 (1321.1563.02), R&S®FPH-K43 (1321.0621.02)
- R&S®FPH-K57 (1321.1586.02), R&S®FPH-K105 (1334.6946.02)
- R&S®FPH (1321.1111.52, equivalent to 1321.1111.02)
- R&S®FPH (1321.1111.56, equivalent to 1321.1111.06)
- R&S®FPH (1321.1111.63, equivalent to 1321.1111.13)
- R&S®FPH (1321.1111.76, equivalent to 1321.1111.26)

© 2022 Rohde & Schwarz GmbH & Co. KG
Muehldorfstr. 15, 81671 Muenchen, Germany
Phone: +49 89 41 29 - 0
Email: info@rohde-schwarz.com
Internet: www.rohde-schwarz.com

Subject to change – data without tolerance limits is not binding.

R&S® is a registered trademark of Rohde & Schwarz GmbH & Co. KG.

Trade names are trademarks of the owners.

1321.1011.02 | Version 13 | R&S®Spectrum Rider FPH

Throughout this manual, products from Rohde & Schwarz are indicated without the ® symbol, e.g. R&S®Spectrum Rider is indicated as R&S Spectrum Rider.

Contents

1	Preface	17
1.1	Safety information	17
1.2	Korea certification class B	17
1.3	Documentation overview	17
1.3.1	Manuals.....	17
1.3.2	Data sheet.....	18
1.3.3	Calibration certificate.....	18
1.3.4	Release notes, open source acknowledgment.....	19
1.3.5	Application notes, application cards, videos.....	19
1.4	Conventions used in the documentation	19
1.4.1	Typographical conventions.....	19
1.4.2	Conventions for procedure descriptions.....	19
1.4.3	Notes on screenshots.....	20
2	Welcome to the R&S Spectrum Rider	21
3	Getting started	22
3.1	Preparing for use	22
3.1.1	Putting into operation.....	22
3.1.1.1	Unpacking and checking the instrument.....	23
3.1.1.2	Accessory list.....	24
3.1.1.3	Setting up the R&S Spectrum Rider.....	24
3.1.1.4	Using the AC adapter.....	25
3.1.1.5	Battery operation.....	26
3.1.1.6	Battery maintenance.....	28
3.1.2	Switching the instrument on and off.....	29
3.1.3	Checking the supplied options.....	30
3.2	Instrument tour	31
3.2.1	Front view.....	32
3.2.2	Top view.....	33
3.2.3	Left view.....	35
3.2.4	Right view.....	36
3.2.5	Rear view.....	36

3.2.6	Touchscreen display.....	37
3.2.6.1	Title bar.....	38
3.2.6.2	Measurement result view.....	39
3.2.6.3	Measurement trace window.....	40
3.2.6.4	Parameter view.....	40
3.2.7	On-screen keyboard.....	44
3.2.8	Front panel keys.....	45
3.2.8.1	POWER key.....	45
3.2.8.2	Screenshot key.....	45
3.2.8.3	Softkey.....	45
3.2.8.4	System keys.....	45
3.2.8.5	Function keys.....	46
3.2.8.6	Keypad.....	47
3.2.8.7	Navigation controls.....	48
3.2.9	Managing options.....	49
3.2.9.1	Enabling options.....	49
3.2.9.2	Checking options.....	50
3.2.9.3	Managing options with R&S license manager.....	50
3.2.10	Configuring the R&S Spectrum Rider.....	52
3.2.10.1	Configuring the hardware.....	52
3.2.10.2	Configuring antennas.....	53
3.2.10.3	Using the GPS receiver.....	57
3.2.10.4	Configuring date and time.....	59
3.2.10.5	Selecting regional settings.....	60
3.2.10.6	Configuring the display.....	61
3.2.10.7	Configuring the audio output.....	63
3.2.10.8	Configuring power supply.....	65
3.2.10.9	Internal alignment.....	66
3.2.10.10	Resetting the R&S Spectrum Rider.....	68
3.2.11	Connecting the R&S Spectrum Rider to a PC.....	69
3.2.11.1	LAN connection.....	69
3.2.11.2	USB connection.....	75
3.3	Trying out the instrument.....	76

3.3.1	Using the spectrum analyzer.....	76
3.3.1.1	Attenuating the signal.....	77
3.3.1.2	Using the preamplifier.....	78
3.3.1.3	Measuring CW signals.....	79
3.3.1.4	Measuring harmonics.....	82
3.3.2	Using a power sensor.....	84
3.3.2.1	Measuring the power with a power sensor.....	84
3.3.2.2	Measuring power and return loss.....	87
3.3.3	Saving and recalling results and settings.....	89
4	Instrument functions.....	90
4.1	Screen layout and elements.....	90
4.1.1	Configuration overview screen layout.....	91
4.2	Touchscreen gesture element.....	92
4.2.1	Change center frequency.....	92
4.2.2	Change reference level.....	93
4.2.3	Change span.....	94
4.2.4	Add marker.....	94
4.2.5	Move marker.....	95
4.2.6	Delete all markers.....	96
4.2.7	Hide or unhide measurement result view display.....	96
4.2.8	Preview screenshot.....	97
4.2.9	Skip wizard measurement.....	97
4.3	Presetting the R&S Spectrum Rider.....	98
4.4	Configuring measurements.....	99
4.5	Working directory.....	99
4.6	Taking screenshots.....	100
4.7	Saving on events.....	102
4.8	Managing datasets.....	105
4.8.1	Saving datasets.....	106
4.8.1.1	Alternative ways to save datasets.....	108
4.8.1.2	Renaming filename.....	108
4.8.2	Restoring datasets.....	109
4.8.2.1	Previewing a dataset.....	110

4.8.2.2	Loading a dataset.....	111
4.8.3	Deleting datasets.....	111
4.8.4	Export datasets.....	112
4.9	Updating the firmware.....	112
4.10	Installing firmware options.....	112
4.11	Device documentation.....	112
5	Working with the measurement wizard.....	114
5.1	Performing and configuring measurements.....	114
5.2	Evaluating results.....	121
6	Spectrum analyzer mode.....	123
6.1	Performing spectrum measurements.....	123
6.1.1	Measuring basic signal characteristics.....	123
6.1.1.1	Using an audio signal to locate signal.....	124
6.1.2	Measuring the channel power of continuously modulated signals.....	125
6.1.2.1	Selecting the standard.....	126
6.1.2.2	Setting the reference level.....	127
6.1.2.3	Setting the channel bandwidth.....	127
6.1.2.4	Changing the span.....	128
6.1.2.5	Configuring and triggering the sweep.....	128
6.1.2.6	Measuring the maximum channel power.....	128
6.1.2.7	Unit for power display.....	129
6.1.3	Measuring the occupied bandwidth.....	129
6.1.3.1	Selecting a standard.....	130
6.1.3.2	Setting the reference level.....	131
6.1.3.3	Setting the channel bandwidth.....	132
6.1.3.4	Defining the percentage of occupied bandwidth.....	132
6.1.3.5	Changing the span.....	132
6.1.3.6	Configuring and triggering the sweep.....	133
6.1.3.7	Using a trigger.....	133
6.1.4	Power measurements on TDMA signals.....	133
6.1.4.1	Selecting a standard.....	134
6.1.4.2	Setting the burst length.....	134
6.1.4.3	Setting the reference level.....	135

6.1.4.4	Using a trigger.....	135
6.1.5	Measuring the spectrum emission mask.....	136
6.1.5.1	Selecting a standard.....	138
6.1.5.2	Optimizing measurement settings.....	138
6.1.5.3	Viewing the results in a table.....	138
6.1.5.4	Configuring and triggering the sweep.....	139
6.1.5.5	Using a trigger.....	139
6.1.6	Measuring the adjacent channel leakage ratio (ACLR).....	139
6.1.6.1	Selecting a standard.....	142
6.1.6.2	Configuring the measurement.....	142
6.1.6.3	Normalization of measurement results.....	145
6.1.6.4	Displaying absolute and relative results.....	145
6.1.6.5	Selecting the reference channel.....	146
6.1.6.6	Setting and checking the limits.....	146
6.1.6.7	Configuring and triggering the sweep.....	147
6.1.6.8	Using a trigger.....	147
6.1.7	Measuring the harmonic distortion.....	148
6.1.7.1	Defining the number of harmonics.....	149
6.1.7.2	Optimizing the display of harmonics.....	149
6.1.7.3	Activating the harmonics list.....	149
6.1.7.4	Using a trigger.....	150
6.1.8	Measuring the AM modulation depth.....	150
6.1.8.1	Setting a threshold.....	151
6.1.8.2	Optimizing the settings.....	151
6.1.8.3	Activating the marker list.....	152
6.1.8.4	Using a trigger.....	152
6.1.9	Working with the spectrogram result display.....	152
6.1.9.1	Controlling the spectrogram update.....	154
6.1.9.2	Browsing through the signal history.....	154
6.1.9.3	Configuring the display.....	155
6.1.9.4	Recording a spectrogram.....	159
6.1.9.5	Playback of a spectrogram.....	163
6.1.9.6	Configuring and triggering the sweep.....	165

6.1.10	Using isotropic antennas.....	165
6.1.11	Measuring the effective isotropic radiated power.....	168
6.2	Configuring spectrum measurements.....	172
6.2.1	Configuration overview.....	172
6.2.2	Configuring the horizontal axis.....	173
6.2.2.1	Defining the center frequency.....	174
6.2.2.2	Defining a frequency step size.....	174
6.2.2.3	Setting a frequency offset.....	175
6.2.2.4	Defining a start and stop frequency.....	175
6.2.2.5	Setting the span.....	176
6.2.3	Configuring the vertical axis.....	177
6.2.3.1	Setting the reference level.....	177
6.2.3.2	Setting a display range.....	178
6.2.3.3	Selecting the display unit.....	179
6.2.3.4	Setting a reference offset.....	179
6.2.3.5	Setting the RF attenuation.....	179
6.2.3.6	Using the preamplifier.....	181
6.2.3.7	Setting the input impedance.....	181
6.2.3.8	Using transducer factors.....	181
6.2.4	Configuring the tracking generator.....	182
6.2.5	Setting bandwidths.....	183
6.2.5.1	Setting the resolution bandwidth.....	183
6.2.5.2	Setting the video bandwidth.....	184
6.2.6	Configuring and triggering the sweep.....	186
6.2.6.1	Setting the sweep time.....	186
6.2.6.2	Selecting the sweep mode.....	187
6.2.6.3	Working with trigger functionality.....	187
6.2.7	Working with traces.....	191
6.2.7.1	Selecting the trace mode.....	192
6.2.7.2	Selecting the detector.....	193
6.2.7.3	Working with a second trace.....	194
6.2.7.4	Working with memory traces.....	195
6.2.7.5	Using trace mathematics.....	196

6.2.8	Using markers.....	196
6.2.8.1	Using markers and deltamarkers.....	196
6.2.8.2	Positioning markers.....	197
6.2.8.3	Positioning a delta marker.....	198
6.2.8.4	Selecting the marker type.....	199
6.2.8.5	Automatic positioning of markers.....	199
6.2.8.6	Removing markers.....	200
6.2.8.7	Using marker search limits.....	201
6.2.8.8	Using marker functions.....	202
6.2.9	Using display lines.....	208
6.2.10	Using limit lines.....	208
6.2.10.1	Selecting a limit line.....	209
6.2.10.2	Performing limit checks.....	210
6.3	Working with channel tables.....	211
6.4	Using transducer factors.....	212
6.4.1	Unit for measurements with transducers.....	214
6.4.2	Setting the reference level.....	215
6.4.3	Frequency range of transducer.....	215
6.4.4	Data sets containing transducer factors.....	215
7	Power meter.....	216
7.1	Using a power sensor.....	216
7.1.1	Connecting a power sensor.....	217
7.1.2	Performing and configuring measurements.....	218
7.2	Using a directional power sensor.....	221
7.2.1	Connecting a directional power sensor.....	222
7.2.2	Performing and configuring measurements.....	223
8	Using the internal power meter.....	226
9	Performing pulse power measurements.....	229
9.1	Configuring the numerical result display.....	232
9.2	Configuring the power vs time result display.....	232
9.2.1	Determining pulse characteristics.....	233
9.2.2	Selecting the video bandwidth.....	234

9.2.3	Averaging traces.....	234
9.2.4	Triggering measurements.....	235
9.2.5	Selecting the result unit.....	236
9.2.6	Scaling the y-axis.....	236
9.2.7	Using markers.....	236
10	Modulation analysis.....	237
10.1	Analog demodulation.....	237
10.1.1	Demodulation bandwidth.....	240
10.1.2	Sample rate, measurement time and audio lowpass filter.....	240
10.1.3	Performing and configuring measurements.....	243
10.1.3.1	Analog modulation.....	243
10.1.3.2	Defining the horizontal axis.....	244
10.1.3.3	Defining the vertical axis.....	244
10.1.3.4	Defining demodulation bandwidth and audio lowpass filter.....	245
10.1.3.5	Defining FM broadcast.....	246
10.1.3.6	Limit settings.....	246
10.2	Digital demodulation.....	247
10.2.1	Measurement configuration.....	250
10.2.2	Frequency configuration.....	253
10.2.3	Amplitude configuration.....	254
10.2.4	Sweep and trigger configuration.....	254
11	Interference analyzer.....	256
11.1	Interference analysis.....	256
11.2	Signal strength mapping.....	256
11.3	Working with maps.....	257
11.3.1	Transferring maps.....	258
11.3.2	Transferring Indoor maps.....	258
11.3.3	Displaying maps.....	260
11.3.3.1	Adding and removing elements.....	261
11.3.3.2	Zooming in and out of the map.....	262
11.3.3.3	Aligning the triangulation and outdoor mapping mode.....	262
11.3.3.4	Aligning the indoor mapping mode.....	263
11.3.3.5	Selecting colors for map locations.....	264

11.3.4	Measuring interference.....	267
11.3.4.1	Selecting an antenna model.....	267
11.3.4.2	Using an audio signal to locate interferers.....	268
11.3.4.3	Using limits.....	269
11.3.5	Collecting map data.....	270
11.3.5.1	Outdoor mapping.....	270
11.3.5.2	Triangulation.....	275
11.3.5.3	Indoor mapping.....	277
11.3.6	Analyzing geographic data.....	281
11.3.7	Analyzing indoor data.....	282
12	Receiver mode.....	283
12.1	Selecting the measurement mode.....	283
12.1.1	Performing single frequency measurements.....	283
12.1.1.1	Defining the receive frequency.....	285
12.1.1.2	Customizing the bargraph aspects.....	285
12.1.2	Performing frequency scans.....	287
12.1.2.1	Defining the scan range.....	289
12.1.2.2	Using markers.....	290
12.2	Configuring measurements in receiver mode.....	290
12.2.1	Selecting detectors for EMI measurements.....	291
12.2.2	Selecting the measurement bandwidths for EMI measurements.....	292
12.2.3	Defining the measurement time.....	292
12.2.4	Working with traces.....	293
12.2.5	Using transducers.....	293
12.2.6	Using limit lines.....	293
12.2.7	Using isotropic antenna.....	293
12.2.8	Save measurements.....	294
13	EMF measurement.....	295
13.1	Preparing an EMF measurement.....	296
13.1.1	Configuring measurements.....	296
13.1.2	Compiling a measurement set.....	299
13.2	Running the EMF measurement.....	301
13.2.1	Loading a measurement set.....	302

13.2.2	Measurement specification.....	303
13.2.3	Performing a sequence of measurements.....	304
13.2.4	Contents of the result displays.....	306
13.2.5	Graphical results.....	306
13.2.6	Numeric results.....	307
13.3	Evaluating results.....	308
14	Remote commands.....	311
14.1	Interfaces and protocols.....	311
14.1.1	LAN interface.....	312
14.1.2	USB interface.....	312
14.1.3	Protocols.....	313
14.2	Setting up the remote control connection.....	314
14.2.1	Preparing for remote control.....	314
14.3	Instrument model and command processing.....	315
14.3.1	Input unit.....	316
14.3.2	Command recognition.....	316
14.3.3	Data base and instrument hardware.....	317
14.3.4	Status reporting system.....	317
14.3.5	Output unit.....	317
14.4	SCPI command structure and syntax.....	318
14.4.1	Structure of a command.....	318
14.4.1.1	Common commands.....	318
14.4.1.2	Device-Specific commands.....	319
14.4.1.3	Overview of syntax elements.....	322
14.4.2	Parameters.....	323
14.4.2.1	Numeric values.....	323
14.4.2.2	Special numeric values.....	324
14.4.2.3	Boolean parameters.....	324
14.4.2.4	Text.....	324
14.4.2.5	Strings.....	325
14.4.2.6	Block data.....	325
14.4.3	Structure of a program message.....	325
14.4.4	Responses to queries.....	326

14.5	Command sequence and command synchronization.....	327
14.6	Remote control - commands.....	327
14.6.1	Common commands.....	329
14.6.2	Remote commands of the spectrum analyzer.....	332
14.6.2.1	Configuring the horizontal axis.....	332
14.6.2.2	Configuring the vertical axis.....	336
14.6.2.3	Configuring the tracking generator.....	341
14.6.2.4	Setting the bandwidth.....	343
14.6.2.5	Performing and triggering measurements.....	345
14.6.2.6	Working with traces.....	349
14.6.2.7	Using markers.....	354
14.6.2.8	Using display lines and limit lines.....	368
14.6.2.9	Configuring and using measurement functions.....	375
14.6.3	Remote commands of the analog modulation.....	405
14.6.3.1	Setting the frequency.....	406
14.6.3.2	Defining the vertical axis.....	406
14.6.3.3	Defining the bandwidth.....	407
14.6.3.4	Defining the FM broadcast.....	408
14.6.3.5	Defining the sweep mode.....	409
14.6.3.6	Configuring the limit line.....	409
14.6.3.7	Setting the measurement mode.....	410
14.6.3.8	Reading measurement results.....	411
14.6.4	Remote commands of the digital modulation.....	414
14.6.4.1	Setting the frequency.....	415
14.6.4.2	Setting the amplitude.....	415
14.6.4.3	Defining the sweep control.....	415
14.6.4.4	Configuring the trigger.....	416
14.6.4.5	Setting the marker.....	416
14.6.4.6	Setting the measurement mode.....	417
14.6.4.7	Setting measurement configuration.....	417
14.6.4.8	Reading measurement results.....	419
14.6.5	Remote commands of the power meter.....	422
14.6.5.1	Setting the frequency.....	423

14.6.5.2	Setting the wavelength.....	423
14.6.5.3	Configuring power level readout.....	424
14.6.5.4	Defining the measurement time.....	425
14.6.5.5	Zeroing of the power sensor.....	425
14.6.5.6	Forward power display.....	426
14.6.5.7	Defining the video bandwidth.....	426
14.6.5.8	Reading measurement results.....	427
14.6.5.9	Selecting a telecommunication standard.....	428
14.6.6	Remote commands of the receiver mode.....	429
14.6.6.1	Configuring the horizontal axis.....	429
14.6.6.2	Configuring the vertical axis.....	430
14.6.6.3	Setting the bandwidth.....	431
14.6.6.4	Performing and triggering the measurement.....	432
14.6.6.5	Working with traces.....	433
14.6.6.6	Using markers.....	434
14.6.6.7	Using limit lines.....	435
14.6.7	File management.....	435
14.6.8	Making and storing screenshots.....	442
14.6.9	Configuring data capture.....	443
14.6.10	Saving events.....	445
14.6.11	Configuring the instrument.....	447
14.6.11.1	Mode selection.....	447
14.6.11.2	Controlling the GPS receiver.....	448
14.6.11.3	Display configuration.....	451
14.6.11.4	Audio settings.....	453
14.6.11.5	Setting up a network connection.....	454
14.6.11.6	System settings.....	455
14.6.12	Status reporting system.....	463
14.6.12.1	Structure of a SCPI status register.....	463
14.6.12.2	Overview of the status register.....	465
14.6.12.3	Status byte (STB) & service request enable register (SRE).....	466
14.6.12.4	Event status register (ESR) and event status enable register (ESE).....	467
14.6.12.5	Application of the status reporting systems.....	470

14.6.12.6	Reset values of the status reporting system.....	472
14.6.12.7	Remote commands of the status reporting system.....	472
15	Menu and softkey overview.....	480
15.1	General functions.....	480
15.1.1	General R&S Spectrum Rider setup.....	480
15.1.2	File management.....	484
15.1.3	Operating mode selection.....	486
15.2	Functions of the spectrum analyzer.....	486
15.2.1	Measurement selection.....	487
15.2.2	Frequency parameters.....	497
15.2.3	SPAN selection.....	497
15.2.4	AMPT parameters.....	497
15.2.5	SWEEP parameters.....	498
15.2.6	BW parameters.....	499
15.2.7	Trace functionality.....	499
15.2.8	Limit lines.....	500
15.2.9	Markers.....	501
15.3	Functions of the power meter.....	502
15.3.1	Power meter measurements.....	502
15.3.2	Frequency parameters.....	505
15.3.3	BW parameters.....	506
15.3.4	Amplitude parameters.....	507
15.3.5	Sweep configuration.....	508
15.3.6	Limits line parameters.....	508
15.3.7	Trace parameters.....	509
15.3.8	Marker parameters.....	509
15.4	Functions of the wizard.....	510
15.4.1	Measurement wizard.....	510
15.5	Functions of the modulation analysis.....	513
15.5.1	Analog demodulation measurements.....	513
15.5.2	Digital demodulation measurements.....	514
15.5.3	Frequency parameters.....	514
15.5.4	BW parameters.....	515

15.5.5	Amplitude parameters.....	515
15.5.6	Sweep configuration.....	516
15.5.7	Limits line parameters.....	516
15.5.8	TRACE parameters.....	517
15.5.9	MARKER parameters.....	517
15.6	Functions of the receiver.....	517
15.6.1	Receiver mode measurement.....	518
15.6.2	Frequency parameters.....	518
15.6.3	Amplitude parameters.....	519
15.6.4	BW parameters.....	520
15.6.5	Sweep configuration.....	520
15.6.6	Trace functionality.....	520
15.6.7	Markers.....	521
15.6.8	Limits line parameters.....	522
15.7	Functions of the maps.....	522
15.7.1	Maps measurement.....	522
15.7.2	Frequency parameters.....	528
15.7.3	Amplitude parameters.....	528
15.7.4	BW parameters.....	529
15.7.5	Sweep configuration.....	529
15.7.6	Trace functionality.....	529
15.7.7	Limits line parameters.....	530
16	Contacting customer support.....	531
17	Appendix.....	532
17.1	How a spectrum analyzer works.....	532
	List of commands.....	537
	Index.....	545

1 Preface

1.1 Safety information

The product documentation helps you use the R&S Spectrum Rider safely and efficiently. Follow the instructions provided here and in the printed "Basic Safety Instructions". Keep the product documentation nearby and offer it to other users.

Intended use

The R&S Spectrum Rider is intended for the development, production and verification of electronic components and devices in industrial, administrative, and laboratory environments. Use the R&S Spectrum Rider only for its designated purpose. Observe the operating conditions and performance limits stated in the data sheet.

Where do I find safety information?

Safety information is part of the product documentation. It warns you about the potential dangers and gives instructions how to prevent personal injuries or damage caused by dangerous situations. Safety information is provided as follows:

- The printed "Basic Safety Instructions" provide safety information in many languages and are delivered with the R&S Spectrum Rider.
- Throughout the documentation, safety instructions are provided when you need to take care during setup or operation.

1.2 Korea certification class B



이 기기는 가정용(B급) 전자파 적합기기로서 주로 가정에서 사용하는 것을 목적으로 하며, 모든 지역에서 사용할 수 있습니다.

1.3 Documentation overview

This section provides an overview of the R&S Spectrum Rider user documentation.

1.3.1 Manuals

You find the documents on the R&S Spectrum Rider product page at:

<http://www.rohde-schwarz.com/manual/fph>

Getting started manual

Introduces the R&S Spectrum Rider and describes how to set up and start working with the product. The printed document is delivered with the instrument.

User manual

Contains the description of all instrument modes and functions. It also provides an introduction to remote control, a complete description of the remote control commands with programming examples, and information on maintenance and instrument interfaces. Includes the contents of the getting started manual.

The *online version* of the user manual provides the complete contents for immediate display on the internet.

Basic safety instructions

Contains safety instructions, operating conditions and further important information. The printed document is delivered with the instrument.

Instrument security procedures manual

Deals with security issues when working with the R&S Spectrum Rider in secure areas.

Service manual

Describes the performance test for checking the rated specifications, module replacement and repair, firmware update, troubleshooting and fault elimination, and contains mechanical drawings and spare part lists. The service manual is available for registered users on the global Rohde & Schwarz information system (GLORIS, <https://gloris.rohde-schwarz.com>).

1.3.2 Data sheet

The data sheet contains the technical specifications of the R&S Spectrum Rider. It also lists the options and their order numbers as well as optional accessories.

The brochure provides an overview of the R&S Spectrum Rider and shows its specific characteristics.

<http://www.rohde-schwarz.com/brochure-datasheet/fph>

1.3.3 Calibration certificate

The document is available on <https://gloris.rohde-schwarz.com/calcert>. You need the device ID of your instrument, which you can find on a label on the rear panel.

1.3.4 Release notes, open source acknowledgment

The release notes list new features, improvements and known issues of the current firmware version, and describe the firmware installation.

The open source acknowledgment document provides verbatim license texts of the used open source software.

<http://www.rohde-schwarz.com/firmware/fph>

1.3.5 Application notes, application cards, videos

These documents contain information about possible applications and background information on various topics, see www.rohde-schwarz.com/apnotes

1.4 Conventions used in the documentation

1.4.1 Typographical conventions

The following text markers are used throughout this documentation:

Convention	Description
"Graphical user interface elements"	All names of graphical user interface elements on the screen, such as dialog boxes, menus, options, buttons, and softkeys are enclosed by quotation marks.
[Keys]	Key and knob names are enclosed by square brackets.
Filenames, commands, program code	Filenames, commands, coding samples and screen output are distinguished by their font.
<i>Input</i>	Input to be entered by the user is displayed in italics.
Links	Links that you can click are displayed in blue font.
"References"	References to other parts of the documentation are enclosed by quotation marks.

1.4.2 Conventions for procedure descriptions

When operating the instrument, several alternative methods may be available to perform the same task. In this case, the procedure using the touchscreen is described. Any elements that can be activated by touching can also be clicked using an additionally connected mouse. The alternative procedure using the keys on the instrument or the on-screen keyboard is only described if it deviates from the standard operating procedures.

The term "select" may refer to any of the described methods, i.e. using a finger on the touchscreen, a mouse pointer in the display, or a key on the instrument or on a keyboard.

1.4.3 Notes on screenshots

When describing the functions of the product, we use sample screenshots. These screenshots are meant to illustrate as many as possible of the provided functions and possible interdependencies between parameters. The shown values may not represent realistic usage scenarios.

The screenshots usually show a fully equipped product, that is: with all options installed. Thus, some functions shown in the screenshots may not be available in your particular product configuration.

2 Welcome to the R&S Spectrum Rider

The R&S Spectrum Rider is a new generation Rohde & Schwarz signal and spectrum analyzer developed to meet demanding customer requirements. Offering touchscreen input, the analyzer enhances user experience in making measurements fast and easy.

This user manual contains a description of the functionality that the instrument provides. The latest version is available for download at the product homepage (<http://www.rohde-schwarz.com/product/fph.html>).

3 Getting started

The following chapters are identical to those in the printed R&S Spectrum Rider Getting Started manual.

- [Preparing for use](#).....22
- [Instrument tour](#).....31
- [Trying out the instrument](#)..... 76

3.1 Preparing for use

3.1.1 Putting into operation

This chapter describes the basic steps to be taken when setting up the R&S Spectrum Rider for the first time.

WARNING

Risk of injury due to disregarding safety information

Observe the information on appropriate operating conditions provided in the data sheet to prevent personal injury or damage to the instrument. Read and observe the basic safety instructions provided with the instrument, in addition to the safety instructions in the following sections. In particular:

- Do not open the instrument casing.

NOTICE

Risk of instrument damage due to inappropriate operating conditions

Specific operating conditions are required to ensure accurate measurements and to avoid damage to the instrument. Observe the information on appropriate operating conditions provided in the basic safety instructions and the instrument's data sheet.

NOTICE

Instrument damage caused by electrostatic discharge

Electrostatic discharge (ESD) can damage the electronic components of the instrument and the device under test (DUT). Electrostatic discharge is most likely to occur when you connect or disconnect a DUT or test fixture to the instrument's test ports. To prevent electrostatic discharge, use a wrist strap and cord and connect yourself to the ground, or use a conductive floor mat and heel strap combination.

NOTICE**Risk of instrument damage during operation**

An unsuitable operating site or test setup can cause damage to the instrument and to connected devices. Ensure the following operating conditions before you switch on the instrument:

- The instrument is dry and shows no sign of condensation.
- The instrument is positioned as described in the following sections.
- The ambient temperature does not exceed the range specified in the data sheet.
- Signal levels at the input connectors are all within the specified ranges.
- Signal outputs are correctly connected and are not overloaded.

**EMI impact on measurement results**

Electromagnetic interference (EMI) may affect the measurement results.

To suppress generated electromagnetic interference (EMI):

- Use suitable shielded cables of high quality. For example, use double-shielded RF and LAN cables.
- Always terminate open cable ends.
- Note the EMC classification in the data sheet.

3.1.1.1 Unpacking and checking the instrument

Check the equipment for completeness using the delivery note and the accessory lists for the various items. Check the instrument for any damage. If there is damage, immediately contact the carrier who delivered the instrument. Make sure not to discard the box and packing material.

**Packing material**

Retain the original packing material. If the instrument needs to be transported or shipped later, you can use the material to protect the control elements and connectors.

NOTICE**Risk of damage during transportation and shipment**

Insufficient protection against mechanical and electrostatic effects during transportation and shipment can damage the instrument.

- Always make sure that sufficient mechanical and electrostatic protection is provided.
- When shipping an instrument, the original packaging should be used. If you do not have the original packaging, use sufficient padding to prevent the instrument from moving around inside the box. Pack the instrument in antistatic wrap to protect it from electrostatic charging.
- Secure the instrument to prevent any movement and other mechanical effects during transportation.

3.1.1.2 Accessory list

The instrument comes with the following accessories:

- Power supply cable and adapter set
- Li-ion rechargeable battery
- USB2.0 cable A-Mini
- Side strap
- "Getting Started" printed manual
- Document folder containing safety instructions, KC and CE certificate

Optional accessories and their order numbers are listed in the data sheet.

3.1.1.3 Setting up the R&S Spectrum Rider

The R&S Spectrum Rider is designed for lab operation as well as for service and maintenance applications on-site.

Depending on the environment, you can adjust the viewing angle of the display and either lay it out horizontally or prop it up using the support on the back of the R&S Spectrum Rider.

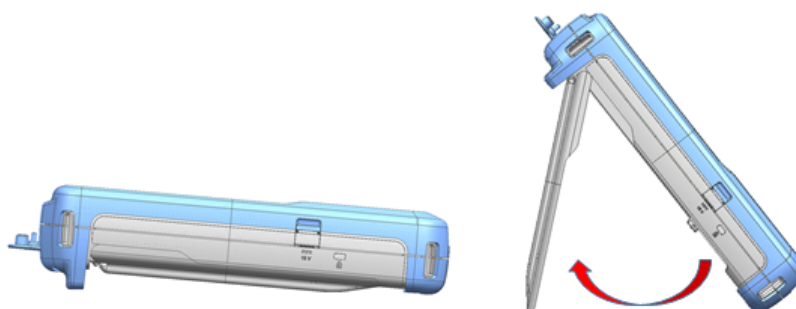

When laid out horizontally for operation from above, the R&S Spectrum Rider is tilted slightly due to the micro-stand at the back. This position provides the optimum viewing angle for the display.

To allow easy operation from the front and still be able to read the display, you can swing out the support on the back of the R&S Spectrum Rider.

Before you turn on the R&S Spectrum Rider, you should insert the lithium ion battery included in the delivery into the battery compartment located at the back of the R&S Spectrum Rider.

Insert battery

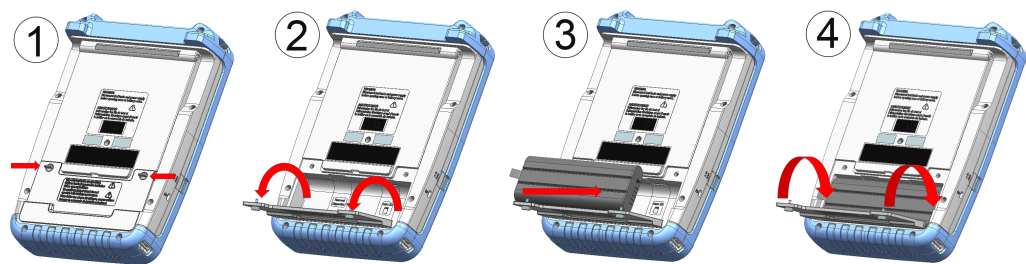

1. Unscrew the two thumb screws located on the battery compartment.
2. Open the cover.
3. Insert the battery into the R&S Spectrum Rider.
4. Close the cover and screw back the thumb screws.

You can operate the R&S Spectrum Rider with the AC adapter or the battery. Both are included in the delivery.

3.1.1.4 Using the AC adapter

NOTICE

Risk of instrument damage

To avoid instrument damage:

- Only use the power supply (R&S HA-Z301, order number 1321.1386.02) included in the delivery.
- Make sure that the AC supply voltage is compatible to the voltage specified on the power supply unit.
- Attach the appropriate adapter to the power supply.

Connect the AC adapter to the DC port on the left side of the R&S Spectrum Rider (item 1 of [Figure 3-1](#)). Make sure to fully insert the AC adapter plug into the DC port.

Depending on the system you need, firmly connect the appropriate power cable included in the delivery to the AC adapter (item 2 of [Figure 3-1](#)).

Finally, connect the power cable plug to an AC power outlet.



Figure 3-1: AC adapter

- 1 = AC adapter
- 2 = Power cable

The voltage range of the AC power supply is 100 V to 240 V AC.

After the R&S Spectrum Rider is connected to the power supply, you can turn it on with the [Power] key on the front panel.

3.1.1.5 Battery operation

The R&S Spectrum Rider has a smart battery indicator which displays the battery charging status on the [Power] key as well as the battery icon shown at the top right corner of the display screen. See [Chapter 3.2.6.1, "Title bar"](#), on page 38.

The lithium ion battery has a capacity of 6.4 Ah and it allows operation of up to eight hours when it is fully charged.

The actual operation time depends on the current charged status (see [Figure 3-2](#)), the ambient temperature and the operating mode of the R&S Spectrum Rider.

For a summary of the LED indication of the [Power] key, see [Table 3-1](#).

The battery charging and discharging process of the battery icon indicated in the display screen is illustrated below:

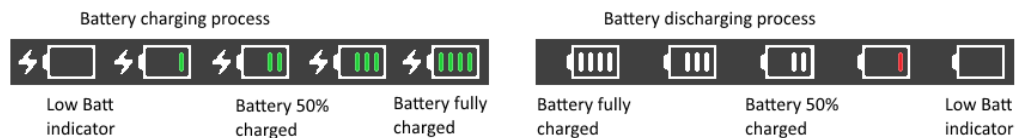

Figure 3-2: Battery charging and discharging process

Charging time is about three hours when the R&S Spectrum Rider is in inactive mode (i.e. R&S Spectrum Rider is switched off). If the instrument is in active mode (i.e. R&S

Spectrum Rider is switched on), the charging time is extended to about four hours because the charging current is reduced as the power is partially drained by the usage of the R&S Spectrum Rider.

During operation in the field, you can also charge the battery with the car adapter (R&S HA-Z302, order number 1321.1340.02). You can connect the car adapter to the DC port. With the car adapter, you are able to charge the R&S Spectrum Rider via the car's cigarette lighter socket. A replacement battery (R&S HA-Z306, order number 1321.1334.02) with the same capacity and charging time as the battery included in the standard delivery is also available if necessary.



Battery dispatched during delivery is not fully charged, for battery operation you have to charge it first.

To charge the battery, connect the charger to AC power adapter included in the delivery. For more information, see ["Using an external battery charger"](#) on page 27.

Using an external battery charger

You can also use an external battery charger (R&S HA-Z303, order number 1321.1328.02) to charge the battery.

To charge the battery externally, put the battery into the external charger and supply it with power via the AC power adapter.

An amber LED on the charger indicates the charging process. The LED turns to green when the battery is fully charged. A red LED on the charger indicates that the battery is not charging or the charging failed.

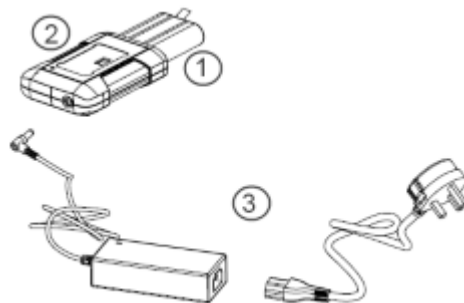

Figure 3-3: External battery charger

- 1 = Lithium ion battery R&S HA-Z306
- 2 = External charger R&S HA-Z303
- 3 = Power supply unit R&S HA-Z301 or car adapter R&S HA-Z302

⚠ WARNING**Risk of traffic accidents, physical injury and property damage**

- Turn off the R&S Spectrum Rider while driving or while the engine is on.
- Operation of the R&S Spectrum Rider via the cigarette lighter socket while driving or while the engine on is prohibited.

3.1.1.6 Battery maintenance

The R&S Spectrum Rider comes with a lithium-ion battery. In general, these batteries are easy to handle. When you handle the battery, follow the instruction mentioned in the safety instructions and in the following chapters.

Handling

- The battery has been designed for a specific application. Do not use it for any other applications.
- Do not connect batteries in series or parallel as it can cause serious damage.
- Observe correct polarities during installation and charging.
- Do not heat over 70°C. The battery contains thermal fuses that could activate and render the battery inoperable.
- The battery contains an electronic device for protection against deep discharge, overcharge and short-circuiting between the terminals.
 - If you cannot discharge the battery, it may be deep discharged. Charge the battery for 0.5 hours and check again.
 - If you cannot charge the battery, it may be overcharged. Discharge the battery and check again.
 - If the battery has been short-circuited, charge it to reset the electronics.
 - If the battery still does not work, contact the Rohde & Schwarz customer support.
- Do not allow metallic objects to come into contact with the terminals.
- Do not solder directly to the battery.

Storage

The battery self-discharges while not in use. When storing the battery for an extended period of time, make sure to

- Handle the battery carefully to avoid short circuits. Make sure that leads and terminals are insulated.
- Keep the battery in the supplied packaging before use. The temperature should be between -20°C to 50°C.
- Store the battery at an initial state of charge between 15% and 50% of its capacity. When calculating the initial state of charge, consider
 - The maximum consumption of electronic devices

- The self-discharge of the battery - the higher the state of charge, the higher the rate of self-discharge
- Avoid a deep discharge of the battery. A deep discharge occurs when the state of charge falls below 5% of the battery's capacity.
- Recharge the battery at least every six months.

Should the battery voltage be low or even 0 V, the battery protection circuit may have gone into a sleep mode. In that case, reset the battery with an approved charger.

Transportation

No special regulations apply for transporting the battery. The battery cells contain no metallic lithium.

End of life

The capacity of the battery decreases after it has gone through numerous charge cycles and nearing its end of life. When the battery is dead, do not open the battery. Do not dispose battery in fire.

3.1.2 Switching the instrument on and off

The instrument can be powered with an AC or DC (battery operated or via car adapter) input. See [Chapter 3.1.1.4, "Using the AC adapter"](#), on page 25.

- ▶ Press [Power] key to switch on the instrument.
During booting, the R&S Spectrum Rider displays a splash screen to indicate the operable frequency range of the instrument. Depending on the frequency upgrade option installed, the respective splash screen is loaded.
After booting, the instrument is ready for operation.
Refer to the instrument brochure for the list of options available.
- ▶ Press [Power] key to switch off the instrument.

NOTICE





Risk of losing data

If a running instrument (without battery) is disconnected directly from the power cord, the instrument loses its current settings. Furthermore, program data may be lost.

Press [Power] key first to shut down the application properly.

The following shows the [POWER] key behavior in different operation modes.

Table 3-1: Summary of LED indication on POWER key

LED indication on [Power] key		Descriptions
Green LED		Instrument is in operation mode.
Blue LED		Instrument is in switch off mode with a fully charged battery. A blinking blue LED indicates that the battery charging is in process.
Amber LED		Instrument is in switch off mode with AC supply and there is no battery in it.
Red LED		There is an error in the battery charging.
LED "OFF"		This is an indication that there is no AC or DC supply to the instrument. The instrument is in a switch off mode.

3.1.3 Checking the supplied options

The instrument can be equipped with different hardware and installed options. For a list of R&S Spectrum Rider supported hardware and installed options, refer to the instrument brochure for the list of options available.

In order to check whether the installed options correspond to the options indicated in the delivery note, proceed as follows.

1. Press [SETUP] key.
2. Select "Installed Options" softkey.

A list of all available options and the current status of the options are displayed.



3. Check the availability of the installed options as indicated in the delivery note.
4. Check the availability of the hardware options as indicated in the delivery note.
5. Press "HW/SW Info" softkey.

A list with hardware and firmware information is displayed.

Spectrum		
Hardware		
Instrument Model	FPH	
Instrument Serial Number	101053	
Mainboard Part Number	1320.8841.02	
Mainboard Revision	02.00	
Mainboard Serial Number	100581	
Frontboard Part Number	1320.8993.02	
Frontboard Revision	05.03	
Frontboard Serial Number	100977	
Controller Version	V4.0.0.0	
Software		
Software Version	X0.09.1097	
Config Overview	Instrument Setup	User Preference
HW/SW Info	Installed Options	Exit

3.2 Instrument tour

This chapter describes the instrument in different views, including all function keys and connectors.

It also contains general system configuration on the R&S Spectrum Rider as well as the connectivity of the instrument to PC.

- [Front view](#).....32
- [Top view](#)..... 33
- [Left view](#)..... 35
- [Right view](#).....36
- [Rear view](#)..... 36
- [Touchscreen display](#).....37
- [On-screen keyboard](#).....44
- [Front panel keys](#).....45
- [Managing options](#).....49
- [Configuring the R&S Spectrum Rider](#)..... 52
- [Connecting the R&S Spectrum Rider to a PC](#).....69

3.2.1 Front view



Figure 3-4: Front panel of R&S Spectrum Rider

- 1 = RF input (N-type, PC 3.5 mm or PC 2.92 mm connector)
- 2 = BNC connectors
- 3 = Headphone jack
- 4 = USB ports
- 5 = RF output (N-type, PC 3.5 mm or PC 2.92 mm connector)
- 6 = Touch-sensitive screen area
- 7 = Softkey labels (on display)
- 8 = Softkey
- 9 = System keys
- 10 = DC port (behind protective cap)
- 11 = Kensington lock
- 12 = Function keys
- 13 = Power key
- 14 = Alphanumeric key
- 15 = Unit keys
- 16 = Back key
- 17 = Cancel key
- 18 = Rotary knob
- 19 = Screenshot key
- 20 = LAN and mini USB ports (behind protective cap)
- **21 = SD card slot (not visible as it is located behind the battery compartment)

For a detailed description of the front panel keys, see [Chapter 3.2.8, "Front panel keys"](#), on page 45.

NOTICE**Instrument damage caused by cleaning agents**

Cleaning agents contain substances that may damage the instrument. For example, cleaning agents that contain a solvent may damage the front panel labeling, plastic parts, or the display.

Never use cleaning agents such as solvents (thinners, acetone, etc.), acids, bases, or other substances.

The outside of the instrument can be cleaned sufficiently using a soft, lintfree dust cloth.

3.2.2 Top view

- 1 = RF input
- 2 = BNC connector
- 3 = Headphone jack
- 4 = USB type A connector
- 5 = RF output

RF input**R&S Spectrum Rider option**

R&S FPH-B100 option (order number: 1321.0596.02) is a hardware rework to change the RF input to N type connector upon order with an FPH model 26.

Upgrade of frequency extension with R&S FPH-B31 option (order number: 1321.0780.02) cannot be combined with R&S FPH-B100 option.

Depending on the instrument models, different RF connector is used.

Table 3-2: Types of RF connectors

Instrument models	Type of RF connector, 50 Ω
Model 02, model 06, model 13 and model 23	N type
Model 26 ¹ and model 36	RPC 3.5 mm
Model 44 and model 54	RPC 2.9 mm

¹With the installation option of R&S FPH-B100, N-type connection is possible, see "[R&S Spectrum Rider option](#)" on page 33.

Connect a cable or DUT to the RF input. Use a cable to connect the DUT to the R&S Spectrum Rider, if necessary.

Make sure not to overload the R&S Spectrum Rider when a DUT is connected. The maximum power that is permissible at the RF input is 20 dBm (or 100 mW).

The RF input is protected from static discharges and voltage pulses by a limiting circuit.

NOTICE**RF power overload**

The R&S Spectrum Rider may be loaded with up to 30 dBm (or 1 W) for up to three minutes. If you apply 1 W for a longer period, the R&S Spectrum Rider may be destroyed.

⚠ WARNING**Risk of electric shock**

To avoid electrical shock the DC input voltage, you must never exceed the value specified on the housing.

NOTICE**Risk of damage of the R&S Spectrum Rider**

To avoid damage to the coupling capacitor, input attenuator or the mixer, the DC input voltage must never exceed the value specified in the data sheet.

BNC connector

You can connect the BNC connector for various applications. It supports an external trigger signal or an external reference signal.

When the BNC connector is configured as a trigger input, it controls the start of a measurement. The trigger mode is selected in the "Sweep" menu, see [Chapter 3.2.8.5, "Function keys"](#), on page 46. The trigger threshold is similar to that of TTL signals.

When the BNC connector is configured as reference input, you can apply a 10 MHz external reference signal to it for frequency synchronization. The external reference label **Ext Ref** is displayed at the top right corner of the trace window to indicate that the reference signal is supplied via external signal input. The label turns green when the reference signal is detected.

The level of the reference signal must be larger than 0 dBm. If there is no reference signal present at the BNC connector, the R&S Spectrum Rider displays an appropriate message. Thus, measurements without a valid reference can be avoided.

For more information on configuring the BNC connector for the appropriate signal, see ["Configuring the BNC connector"](#) on page 53 and [Chapter 3.2.10.3, "Using the GPS receiver"](#), on page 57.

Headphone jack

The 3.5 mm connector for headphones has an internal impedance of approximately 10 Ω .

USB type A connector

There are two USB ports located on top of the R&S Spectrum Rider.

You can use the USB interface to connect a memory stick and store data sets or screenshots. The USB connector can also be used to control the operation of the external power sensor and GPS receiver.

See [Chapter 3.3.2, "Using a power sensor"](#), on page 84 and [Chapter 3.2.10.3, "Using the GPS receiver"](#), on page 57.

RF output

Applicable for model 23, model 36 and model 54, the RF output connector provides the following ways to generate a signal source output power at -10.00 dBm nominal.

- Tracking generator output
- Continuous signal source output
- Coupled continuous signal source output

For types of RF output connectors, see [Table 3-2](#).

For more information on configuring the RF output for signal source, see [Chapter 6.2.4, "Configuring the tracking generator"](#), on page 182.

3.2.3 Left view

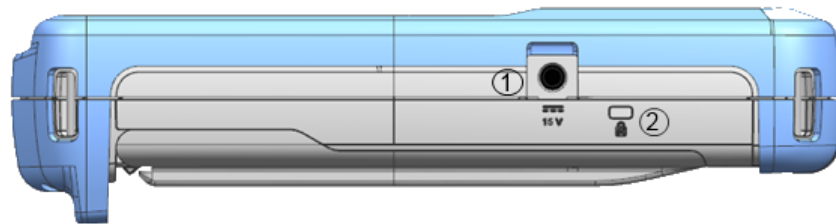

1 = DC port

2 = Kensington lock slot

DC port

The R&S Spectrum Rider is supplied with power by the AC/DC transformer power supply via the DC connector. You can also use the DC connector to charge the battery.

Kensington lock slot

A Kensington lock can be anchored to the R&S Spectrum Rider housing to secure it to a workstation mechanically.

3.2.4 Right view

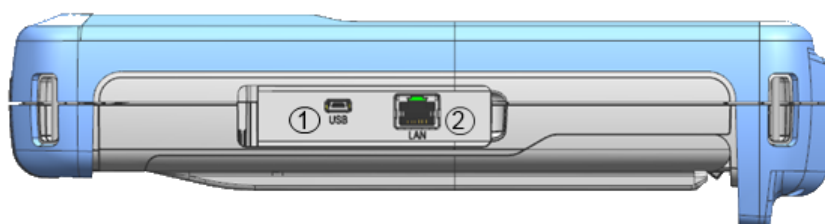

1 = Mini USB

2 = LAN port

Mini USB

Mini USB connector to connect a computer for remote control of the instrument and transfer data in both directions.

LAN port

RJ-45 connector to connect the instrument to a Local Area Network (LAN) and transfer data in both directions. It supports up to 100 Mbit/s.

3.2.5 Rear view

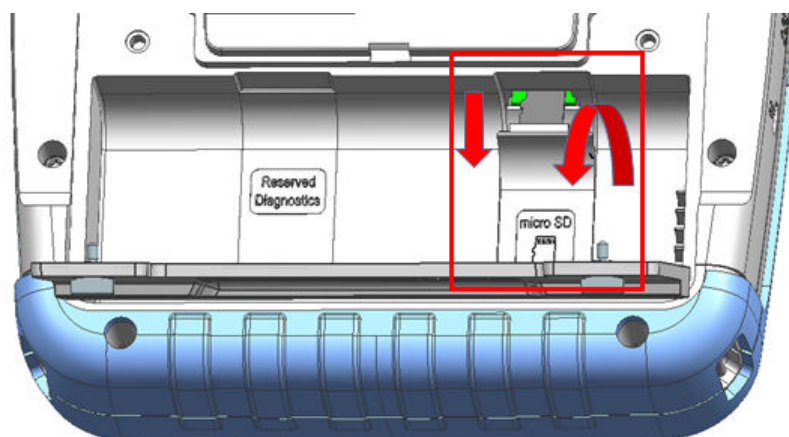

SD card slot

The micro-SD card slot is located behind the battery compartment of the R&S Spectrum Rider.

Peel open the SD card protective cap to access to the SD card slot. You can use the SD card to store data sets or screenshots.

3.2.6 Touchscreen display

All measurement results are displayed on the screen. Additionally, the screen display provides status and setting information and you can change the parameters setting with touchscreen gesture.

The touch-sensitive screen offers an alternative means of user interaction for quick and easy handling of the instrument.

NOTICE

Risk of touchscreen damage during operation

The touchscreen may be damaged by inappropriate tools or excessive force.

Observe the following instructions when operating or cleaning the touchscreen:

- Never touch the screen with ball point pens or other pointed objects with sharp edges.
- It is recommended that you operate the touchscreen by finger only. As an alternative, you may use a stylus pen with a smooth soft tip.
- Never apply excessive force to the screen. Touch it gently.
- Never scratch the screen surface, e.g. with a finger nail. Never rub it strongly, for example with a dust cloth.

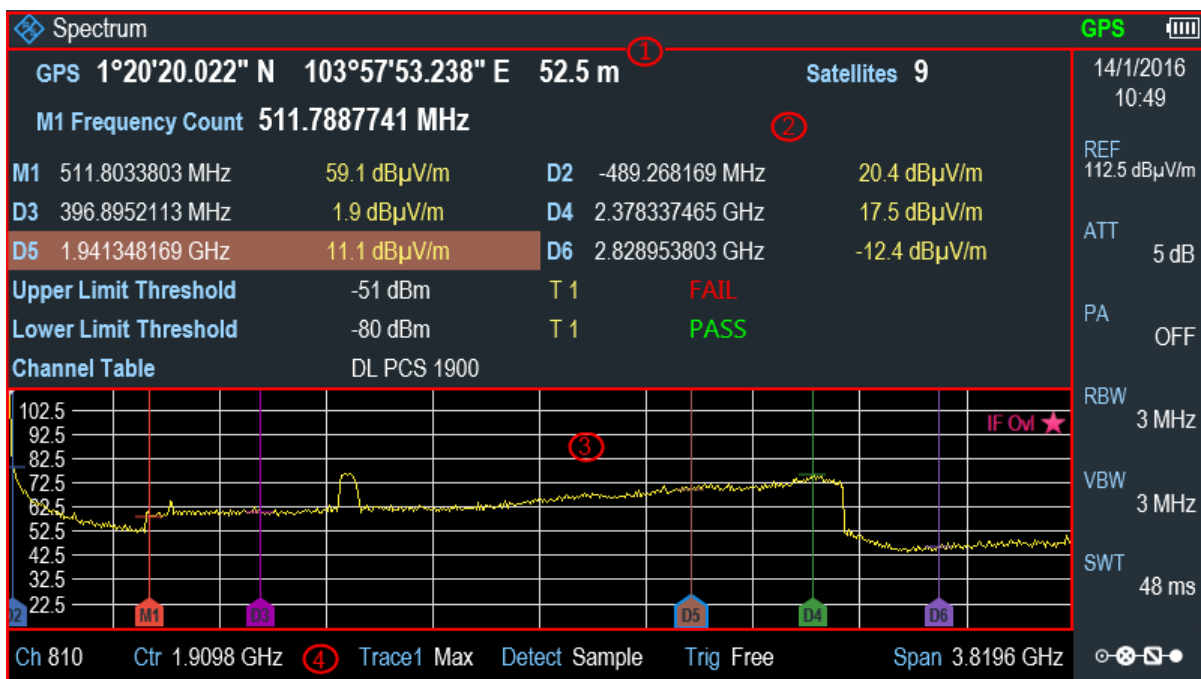

Figure 3-5: R&S Spectrum Rider touchscreen element

The touchscreen display can be divided into several sections:

1. Title bar

2. [Measurement result view](#)
3. [Measurement trace window](#)
4. [Parameter view](#)

A touchscreen is a screen that is touch-sensitive, i.e. it reacts in a specified way when a particular element on the screen is tapped by a finger.



Touchscreen gesture

Special touchscreen features are provided to enhance user experience in using the instrument:

- Swipe horizontally in the trace window, the gesture is used to change the center frequency.
- Swipe vertically in the trace window, the gesture is used to change reference level.
- Pinch and stretch to change the span parameter.
- Double tap on the trace window to add a new marker.
- Tap and drag on the marker icon, the gesture is used to change the marker position.
- Draw a "x" to delete all markers.
- Swipe up or down vertically in the "[Measurement Result View](#)" to hide or unhide the measurement result view display.
- In the file manager dialog, swipe horizontally to the left or right direction to preview screenshots.
- In the wizard measurement mode, swipe horizontally to the left direction to skip a wizard measurement.

3.2.6.1 Title bar

The "Title bar" is located on top of the layout.



It is used to display static content:

- Basic information such as R&S logo, measurement mode name (i.e. "Spectrum", "Power Meter") and battery status.
- Accessories name connected to the instrument, i.e power sensor, GPS receiver.
- Standard information such as measurement standard name and channel table name.

3.2.6.2 Measurement result view



Special touchscreen gesture

You can swipe vertically up or down in the "Measurement result view" to hide or unhide the measurement result view display.

See [Chapter 4.2.7, "Hide or unhide measurement result view display"](#), on page 96.

The "Measurement result view" is located below the "Title bar".

GPS	1°20'20.022" N	103°57'53.238" E	52.5 m	Satellites	9
M1 Frequency Count	511.7887741 MHz				
M1	511.8033803 MHz	59.1 dB μ V/m	D2	-489.268169 MHz	20.4 dB μ V/m
D3	396.8952113 MHz	1.9 dB μ V/m	D4	2.378337465 GHz	17.5 dB μ V/m
D5	1.941348169 GHz	11.1 dB μ V/m	D6	2.828953803 GHz	-12.4 dB μ V/m
Upper Limit Threshold	-51 dBm	T 1	FAIL		
Lower Limit Threshold	-80 dBm	T 1	PASS		
Channel Table	DL PCS 1900				

It displays measurement results of the followings:

- [GPS information](#)
- Marker values
 - Including marker function such as marker noise measurement, frequency counter and N dB down bandwidth measurement when activated.
- Display line
- Limit lines
- Channel table

When the marker measurement is enabled and selected in the "Measurement result view", an entry box for marker positioning is displayed. On the selected marker, you can also see that the function measurement result is displayed in the "Measurement result view", e.g. "Frequency Count".

The selected marker is highlighted in the "Measurement result view", it is also reflected on the marker in the "Measurement trace window".

Table 3-3: Highlighted marker

Highlighted marker in the "Measurement result view"	Highlighted marker in the "Measurement trace window"
	<p>Note: There is a blue frame on the highlighted "M1" marker.</p>

For more information on marker measurement, see ["Using markers"](#) on page 80.

3.2.6.3 Measurement trace window

The "Measurement trace window" is the main user interface window in R&S Spectrum Rider. It displays the measurement traces where markers and limit lines are also displayed.

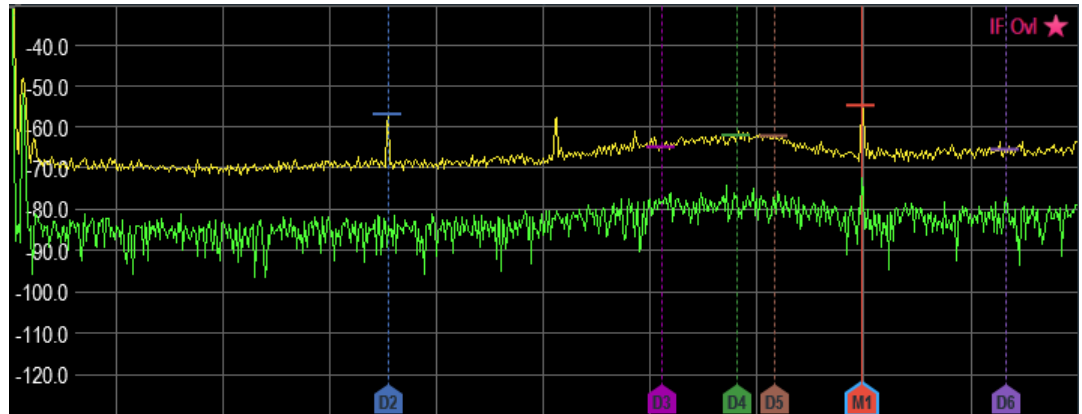

Device warning messages (e.g IF Ovl) are displayed at the top right-hand corner of the window.

NOTICE

Device warning message

- IF Ovl: This message indicates that the downconverter of the intermediate frequency (IF) is overloaded in R&S Spectrum Rider.
- In general, a star ★ indicates that the measurement is still in progress.

3.2.6.4 Parameter view



The "Parameter view" contains the important trace setting parameters for the spectrum measurement.

It is located at the right side and bottom section of the layout . See [Figure 3-5](#).

You can select any parameter in the "Parameter view" to adjust the configurations of the spectrum measurement. See details of each of the parameter in the R&S Spectrum Rider user manual.

Parameter settings	Description
"Center", "Start", "Stop" 	This display setting is function-specific depending on the softkey ("Center Freq", "Start Freq", "Stop Freq") indicated in the softkey label. See Chapter 3.2.8.3, "Softkey" , on page 45. It displays an entry box to configure the center frequency, start or stop frequency for the spectrum measurement.

<p>"Trace"</p> 	<p>Select "Trace" to display the trace menu with a list of settings ("Clear/Write", "Average", "Min Hold", "Max Hold").</p>
<p>"Detect"</p> 	<p>Select "Detect" to display the trace detector menu with a list of settings ("Auto Peak", "Max Peak", "Min Peak", "Sample", "RMS").</p>
<p>"Trig"</p> 	<p>Select "Trig" to display the gate trigger menu with a list of settings ("Free Run", "Ext. Rise", "Ext". "Fall").</p>
<p>"Span"</p> 	<p>Select "Span" to display an entry box to configure the span of the spectrum measurement.</p>
<p>"Time & Date"</p> 	<p>Time and date of the instrument. This field is a read-only field. See Chapter 3.2.10.4, "Configuring date and time", on page 59.</p>
<p>"REF"</p> 	<p>Select "REF" to display an entry box to configure the reference level for the spectrum measurement.</p>
<p>"ATT"</p> 	<p>Select "ATT" to display an entry box to configure the attenuation setting for the spectrum measurement.</p>
<p>"PA"</p> 	<p>Depending on the instrument models, optional pre-amplifier such as R&S FPH-B22 / B23 / B24 / B25 / B26 is available for installation.</p> <p>Select "PA" to toggle between the "ON" and "OFF" status for the optional preamplifier of the spectrum measurement.</p> <p>Note: When the optional preamplifier is absent, this menu is not available.</p>
<p>"RBW"</p> 	<p>Select "RBW" to display an entry box to configure the resolution bandwidth of the spectrum measurement.</p>
<p>"VBW"</p> 	<p>Select "VBW" to display an entry box to configure the video bandwidth of the spectrum measurement.</p>

<p>"SWT"</p> 	<p>Select "SWT" to display an entry box to configure the sweep time of the spectrum measurement.</p>
<p>"Config Overview"</p> 	<p>Select "Config Overview" to display the configuration overview window for more configuration options for the spectrum measurement. See "Configuration overview" on page 42.</p>

Configuration overview

The "Config Overview" is a dedicated button located at the bottom of the "Parameter View", it is operation mode dependent. See [Figure 3-5](#).

When you select this button, it opens the "Config Overview" window. Accessing it without the touchscreen input is possible via the [SETUP] key. See [Chapter 3.2.8.4, "System keys"](#), on page 45.



The "Config Overview" illustrates the flow of spectrum measurement at different stages and the relevant parameters which have impact on the measurement at each stage.



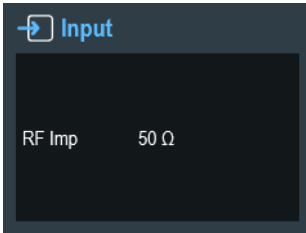
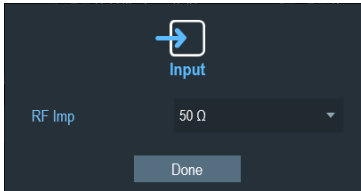

The "Config Overview" window is divided into six categories:

Table 3-4: Corresponding dialog box of "Config Overview" window

"Config Overview" block	Corresponding dialog box	Description
		<p>Select "Input" to configure RF impedance.</p>

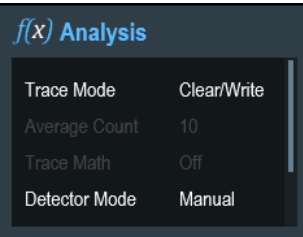
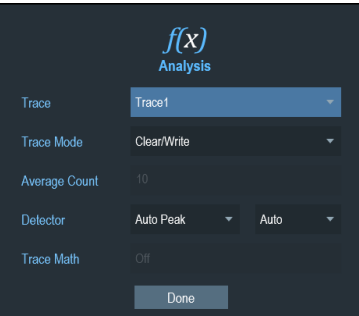
		<p>Select "Amplitude" to configure reference level, reference offset, optional preamplifier, RF attenuation level and mode.</p> <p>It also provides configuration to set the transducer table used in the signal measurement.</p> <p>Note: When the optional preamplifier is absent, the menu item "RF Preamp" is not available.</p>
		<p>Select "Frequency" to configure the center frequency, frequency offset and span of the spectrum measurement.</p>
		<p>Select "Bandwidth" to configure resolution bandwidth, video bandwidth and sweep time for the spectrum measurement.</p>

		<p>Select "Analysis" to configure trace mode, trace detector and the number of count used to average up the measurement for the trace display.</p> <p>It also provides configuration to set the "Trace Math" method used to calculate the differences in the current trace measurement and measurement saved in the memory.</p>
		<p>Select "Trigger" to configure the trigger source, trigger level and the trigger delay setting on the spectrum measurement.</p>

3.2.7 On-screen keyboard

The on-screen keyboard is an additional means of interacting with the instrument. It provides convenience of usage with the touchscreen input.

Accessing the on-screen keyboard is only available for text-based entry, e.g. save or open a filename.



Touchscreen interface

If the [touchscreen interface](#) is not activated, the on-screen keyboard is disabled.

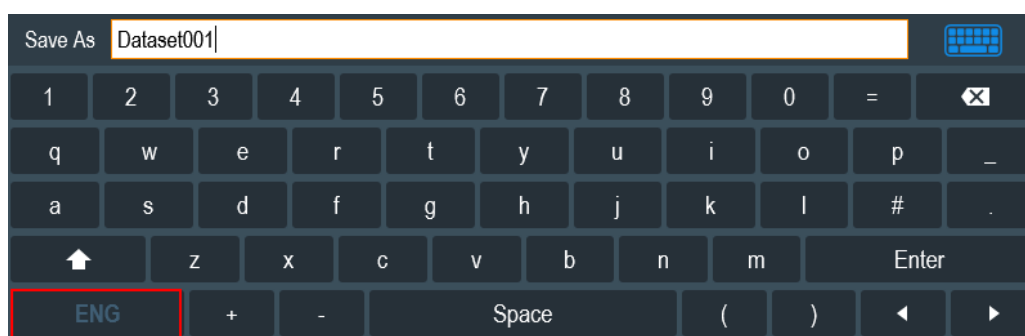

The on-screen keyboard display can be switched on and off using the on-screen keyboard  icon highlighted at the top right-hand corner.

3.2.8 Front panel keys

The following chapters illustrate the function of the front panel keys.

3.2.8.1 POWER key

The [POWER]  key is located on the lower left of the front panel. It starts up and shuts down the instrument.

See [Chapter 3.1.2, "Switching the instrument on and off"](#), on page 29.

See also [Chapter 3.2.1, "Front view"](#), on page 32.

3.2.8.2 Screenshot key

The screenshot  key provides a quick way to capture screenshot of the current screen at anytime.

For more information, see [Chapter 4.6, "Taking screenshots"](#), on page 100.

3.2.8.3 Softkey

The six softkeys on the front panel are used to access the softkey label. See [Chapter 3.2.1, "Front view"](#), on page 32.



The softkey label is function-specific depending on the key selected on the front panel of the instrument. See [Chapter 3.2.8.5, "Function keys"](#), on page 46.

3.2.8.4 System keys

System keys provide settings affecting the general instrument settings, result evaluation settings and save and recall functions.



For more information, see the corresponding functions in the R&S Spectrum Rider user manual.

SYSTEM keys	Descriptions
[PRESET]	Resets the instrument to the default state.
[SETUP]	Provides basic instrument configuration functions: <ul style="list-style-type: none"> • Reference frequency (external/internal) and hardware selection • Date, time, display, audio and regional configuration • Battery low indicator • LAN interface • Disabling and enabling of options • Information about instrument configuration including firm-ware version and system error messages • Internal alignment
[MODE]	Provides the selection between applications. <ul style="list-style-type: none"> • "Spectrum" • "Digital Demo" • "Analog Demo" • "Receiver" • "Power Meter" • "Maps"
[LINES]	Configures display line and limit lines.
[SAVE RECALL]	Provides a file manager function to facilitate the saving and recalling of result and instrument settings.

3.2.8.5 Function keys

Function keys provide access to the most common measurement settings and functions in the instrument.

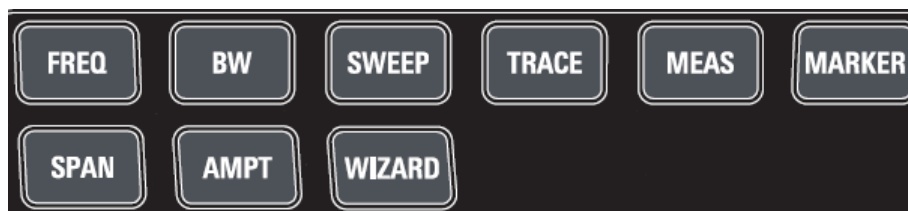

For more information, see the corresponding functions in the R&S Spectrum Rider user manual.

FUNCTION keys	Descriptions
[FREQ]	Sets the center frequency, frequency step size, frequency offset as well as the start and stop frequencies for the frequency range under consideration.
[SPAN]	Sets the frequency span to be analyzed.
[AMPT]	Sets the reference level, the displayed dynamic range, the RF attenuation and the unit for the level display. Sets the level offset and the input impedance. Activates the optional preamplifier. Sets transducer tables to compensate primary and secondary RF path losses.

FUNCTION keys	Descriptions
[WIZARD]	Performs a sequence of standardized and recurring measurements. See Chapter 5, "Working with the measurement wizard" , on page 114.
[BW]	Sets the resolution bandwidth and the video bandwidth.
[SWEEP]	Sets the sweep time. Sets the trigger mode, trigger threshold and the trigger delay of the external trigger signal. Selects continuous measurement or single measurement.
[TRACE]	Configures the measured data acquisition and the analysis of the measurement data.
[MEAS]	Mode-dependent button. This key provides functionality to select and configure measurements in the available measurement modes. For more information, see the corresponding measurement modes in the R&S Spectrum Rider user manual.
[MARKER]	Mode-dependent button. Sets and positions the absolute and relative measurement markers (markers and delta markers). Marker positioning using peak, next peak, minimum level, reference level and center frequency. Marker search limit function. Enables or disables checkbox for "View List" function. Provides the following marker functions: <ul style="list-style-type: none"> • Marker mode function which provides capability to measure noise, measure frequency using frequency counter and measure bandwidth using the N dB down setting. • Marker display setting using the frequency or channel table. • AM and FM marker demodulation. For more information, see Chapter 6.2.8, "Using markers" , on page 196.

3.2.8.6 Keypad

The keypad is used to enter alphanumeric parameters, including the corresponding units.



It contains the following keys:

Type of key	Description
Alphanumeric keys	Enter numbers and (special) characters in edit dialog boxes.
Decimal point	Inserts a decimal point "." at the cursor position.
Sign key	Changes the sign of a numeric parameter. In the case of an alphanumeric parameter, inserts a "-" at the cursor position.
Unit keys (GHz/-dBm MHz/ dBm, kHz/dB and Hz/dB)	These keys add the selected unit to the entered numeric value and complete the entry. In the case of level entries (e.g. in dB) or dimensionless values, all units have the value "1" as multiplying factor. Thus, they also act like an enter key function.
CANCEL key	Closes all kinds of dialog boxes, if the edit mode is not active. Quits the edit mode, if the edit mode is active. In dialog boxes that contain a "Cancel" button, it activates that button. For "Edit" dialog boxes the following mechanism is used: <ul style="list-style-type: none"> • If data entry has been started, it retains the original value and closes the dialog box. • If data entry has not been started or has been completed, it closes the dialog box.
BACK key	If an alphanumeric entry has already been started, this key deletes the character to the left of the cursor. Note: If an entry is confirmed with enter key, this key restores the value entered before. This action can be used to toggle, for example, between two frequencies.

3.2.8.7 Navigation controls

The rotary knob provides navigation controls in the display or within dialog boxes.



The rotary knob has several functions:

- Increments (clockwise direction) or decrements (counter-clockwise direction) the instrument parameters at a defined step width in the case of a numeric entry
- Shifts markers, limit lines and display line on the screen
- Acts like a cursor key in dialog boxes or softkey submenus.
- Moves the scroll bar vertically if the scroll bar is in focused
- Acts as an enter key when pressed

3.2.9 Managing options

For special measurement tasks, you can equip the R&S Spectrum Rider with various firmware options.

3.2.9.1 Enabling options

To enable options, you have to enter a key code. The key code is based on the unique serial number of the R&S Spectrum Rider.

1. Press [SETUP] key.
2. Select "Installed Options" softkey.
A list of all available options and the current status of the options is displayed. See [Chapter 3.1.3, "Checking the supplied options"](#), on page 30.
3. Select the "Install Option" menu item from the dialog box.
The R&S Spectrum Rider opens an entry field to enter the option key.
4. Enter in the appropriate option key.
5. Confirm the entry with the rotary knob.
If you have entered the correct code, the instrument displays a "installation successful" message.
If incorrect code is entered, the instrument displays a "invalid key code!" message.
6. Enter the correct code again.

3.2.9.2 Checking options

In the "Setup" menu, the R&S Spectrum Rider shows all options that are currently installed.

1. Press [SETUP] key.

2. Select "Installed Options" softkey.

The R&S Spectrum Rider shows a list of all available options and the current status of the option:

- "Installed": This means that the option is installed and working.
- "Demo": This means that the option is for demo purposes and it has an expiry date.
- "Removed:<option key>": This indicates that a portable license has been removed and is ready to be transferred to another R&S Spectrum Rider.

3.2.9.3 Managing options with R&S license manager

If you are using the R&S Spectrum Rider in a local area network (LAN), you can manage the firmware options with a web browser (e.g. Microsoft Internet Explorer or Mozilla Firefox).

For more information on connecting the R&S Spectrum Rider to a LAN, see [Chapter 3.2.11.1, "LAN connection"](#), on page 69.

After you have connected the R&S Spectrum Rider, open your web browser.

1. Enter the IP address of the R&S Spectrum Rider in the address bar of the web browser.



The browser accesses the R&S License Manager. In this part of the R&S License Manager, you can install and activate licenses on the R&S Spectrum Rider.

This page features three areas:

- The first area shows the details of the connected device including the device ID and the IP address.

Connected Device

FPH	Device ID:	1321.1111 K02-900188-nK
FPH	IP Address:	10.113.10.184
Version: V1.00	Host Name:	localhost

- The second area provides functionality to install and activate licenses.

What do you want to do?

- [Install Registered License Keys and Activate Licenses](#) ⓘ
- [Register Licenses, Install License Keys and Activate Licenses](#) ⓘ
- [Reboot Device](#) ⓘ

- "Install Registered License Keys and Activate Licenses"

- Follow this link if you have purchased a registered license. Registered licenses only work in combination with a specific device ID.
- "Register Licenses, Install License Keys and Activate Licenses"
Follow this link if you have purchased an unregistered license. Unregistered licenses are not connected to a specific device ID.
- "Reboot Device"
Follow this link to reboot the R&S Spectrum Rider.
- Online help icon 
Opens a detailed online help to the corresponding topic.
- The third area provides hints on using the license manager when you move the mouse over one of the options.

Help**Reboot Device:**

Many devices need to be rebooted, before newly installed license keys can activate the licenses on these devices. Use "Reboot Device" to allow the R&S License Manager to remotely reboot a device, which is accessible via LXI. You will be requested to select the Device ID of the applicable device.

If you already have one or more R&S Spectrum Rider equipped with options, you can manage the licenses of these options on the license manager web page.

2. Select the **Manage Licenses** button.

The browser accesses another part of the R&S License Manager. In this part of the license manager, you can manage licenses already installed on your R&S Spectrum Rider.

This page features two areas:

- The first area provides functionality to manage licenses already installed on a device.

What do you want to do?

- [Register Licenses](#) 
- [Unregister License](#) 
- [Move Portable License](#) 

- "Register Licenses"
Follow this link if you have purchased an unregistered license. Unregistered licenses only work in combination with a specific device ID.
- "Unregister License"
Follow this link if you have installed a portable license. Portable licenses work in combination with several device IDs. However, you have to unregister it on one device before you can use it on another.
- "Move Portable License"
Follow this link if you want to move a portable license. Moving a portable license is possible without unregistering the license.
- Online help icon 
Opens a detailed online help to the corresponding topic.
- The second area provides hints on using the R&S License Manager when you move the mouse over one of the options.

After you have followed one of the links, follow the instructions displayed in the browser. If you encounter any problems during the licensing procedure, you can access the online help at any time with the online help icon . The online help contains an extensive description of all functionality that the license manager features.

3.2.10 Configuring the R&S Spectrum Rider



In the "Instrument Setup" dialog box, the R&S Spectrum Rider provides various general settings that are independent of the operating mode of the R&S Spectrum Rider.

1. Press [SETUP] key.
2. Select "Instrument Setup" softkey.
A corresponding dialog box to configure the instrument opens.
3. Select the item you want to modify.
 - [Configuring the hardware](#).....52
 - [Configuring antennas](#).....53
 - [Using the GPS receiver](#).....57
 - [Configuring date and time](#).....59
 - [Selecting regional settings](#).....60
 - [Configuring the display](#).....61
 - [Configuring the audio output](#).....63
 - [Configuring power supply](#).....65
 - [Internal alignment](#).....66
 - [Resetting the R&S Spectrum Rider](#).....68

3.2.10.1 Configuring the hardware

The hardware settings provide settings that control internal and connected hardware.

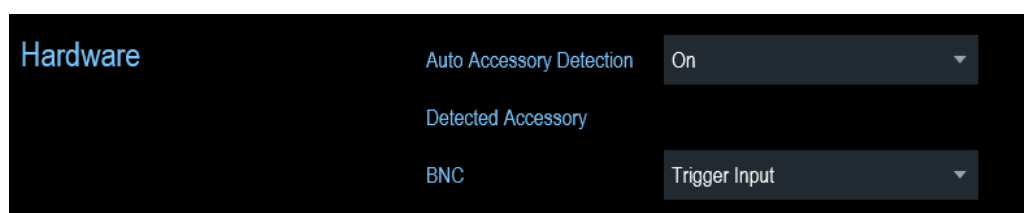

Using auto accessory detection

If you are using any accessories while working with the R&S Spectrum Rider, the instrument is able to identify the connected hardware. To enable this setting:

1. In the "Instrument Setup" dialog box, select the "Auto Accessory Detection" item.
A drop-down menu to select the accessory detection opens.
2. Set "Auto Accessory Detection" to "On".
When this feature is on, the name of the connected accessory is displayed in the "Detected Accessory" field.

Configuring the BNC connector

You can use the BNC connectors for various applications. For more information on the supported applications, see ["BNC connector"](#) on page 34.

1. In the "Instrument Setup" dialog box, select the "BNC" item.
A drop-down menu to select the BNC connector application opens.

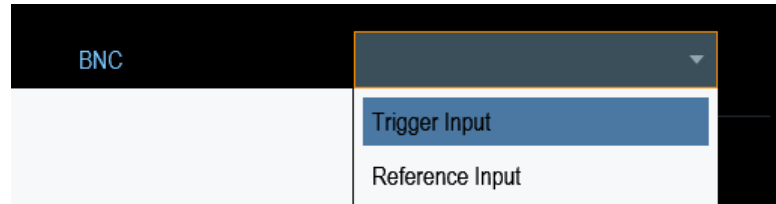

2. Select the required application.

3.2.10.2 Configuring antennas

You can use the log-periodic antenna (R&S HL300, order number 4097.3005.02) , active directional antenna (R&S HE300, order number 4067.5900.02) or the directional antenna (R&S HE400, order number 4104.6000.02) with the R&S Spectrum Rider to locate potential interfering sources. For a list of other antennas supported by the instrument, refer to data sheet for details.

For comprehensive description of the antennas and their functionality, refer to the respective user manuals delivered with the product.

For antennas embedded with a GPS receiver and electronic compass, you can control the GPS receiver of the antennas as described in [Chapter 3.2.10.3, "Using the GPS receiver"](#), on page 57.

If necessary, you may need a USB adapter (R&S HE300USB, order number 4080.9440.02) to connect the antennas control cable to the USB interface of the R&S Spectrum Rider.

The "Instrument Setup" dialog box provides all settings necessary to control the antenna.

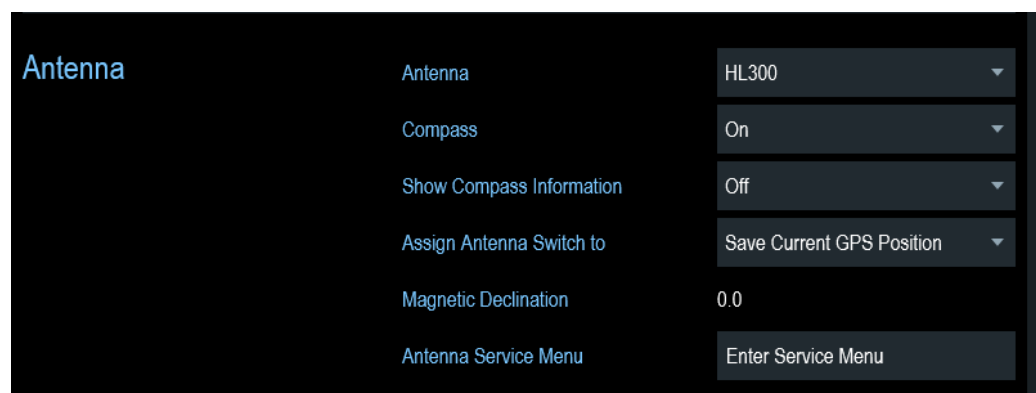

Enabling the antenna

1. In the "Instrument Setup" dialog box, select the "Antenna" menu item. A drop-down menu to select the antenna opens.

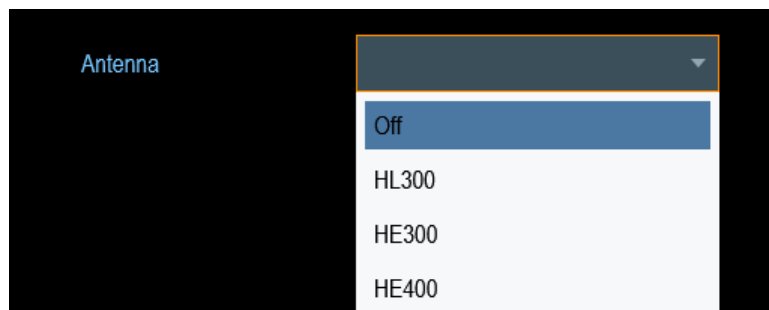

2. Select the required antenna. The R&S Spectrum Rider enables the selected antenna. Note: The "Auto Accessory Detection" menu item in the "Hardware" section turns off when an antenna is selected.

Enabling the compass

The antennas feature an electronic compass to determine directions precisely.

1. In the "Instrument Setup" dialog box, select the "Compass" item. A drop-down menu to enable or disable the compass opens.

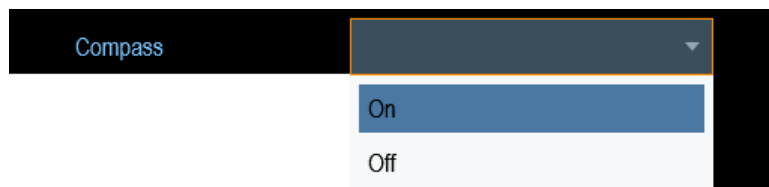

2. Select "On" to enable the compass. The R&S Spectrum Rider shows the magnetic declination of your current position in the "Magnetic Declination" menu item when you turn on the compass.

Showing compass information

1. In the "Instrument Setup" dialog box, select the "Showing Compass Information" menu item. A drop-down menu to enable or disable the display of compass information opens.

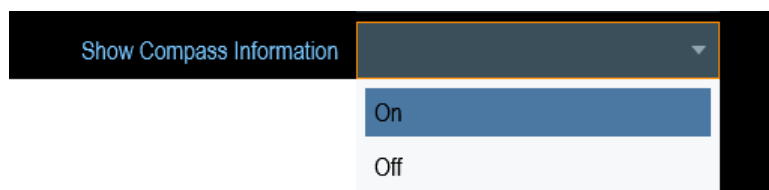

2. Select "On" to enable the display of compass information.

The R&S Spectrum Rider displays the compass information at the top of the map display.

Assigning functions to the toggle switch

Some antennas (e.g. R&S HL300 and R&S HE400) are equipped with a toggle switch on its handle that you can assign to one of the following functions:

1. In the "Instrument Setup" dialog box, select the "Assign Antenna Switch" menu item.

A drop-down menu to select the function of the antenna toggle switch opens.

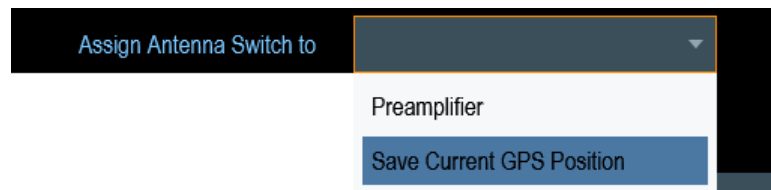

- a) "Preamplifier"
Using the toggle switch turns the preamplifier on and off.
- b) "Save current GPS position"
Using the toggle switch tags your current position in the map material.

2. Select the required function.

Calibrating the antenna



If you need to know technical specification about the antenna, for example for service or support, you can get the necessary information from the "Antenna Service Menu" provided in the R&S Spectrum Rider.

The "Antenna Service Menu" contains functionality to calibrate the antenna.

1. In the "Instrument Setup" dialog box, select the "Antenna Service Menu" item to activate the antenna service menu.

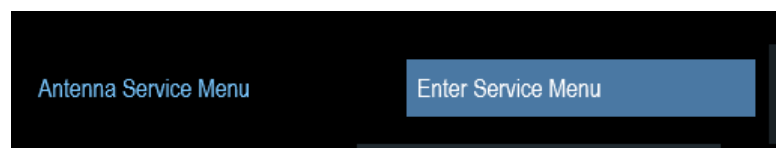

The R&S Spectrum Rider informs you that the antenna is disabled to determine the antenna information.

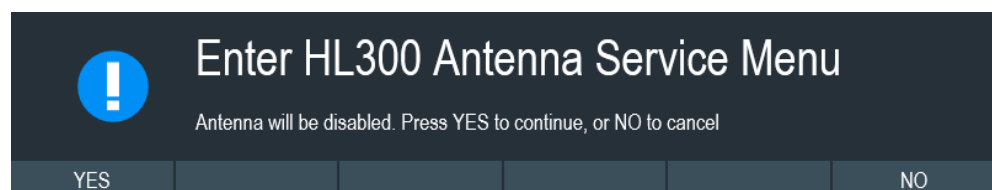

2. Select "YES" softkey.

The R&S Spectrum Rider tries to determine the antenna characteristics. It shows the results in a dialog box.

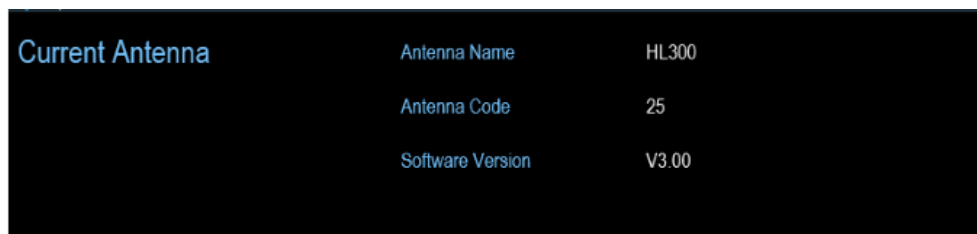

Current Antenna	Antenna Name	HL300
	Antenna Code	25
	Software Version	V3.00

3. Select the "Calibrate" softkey.

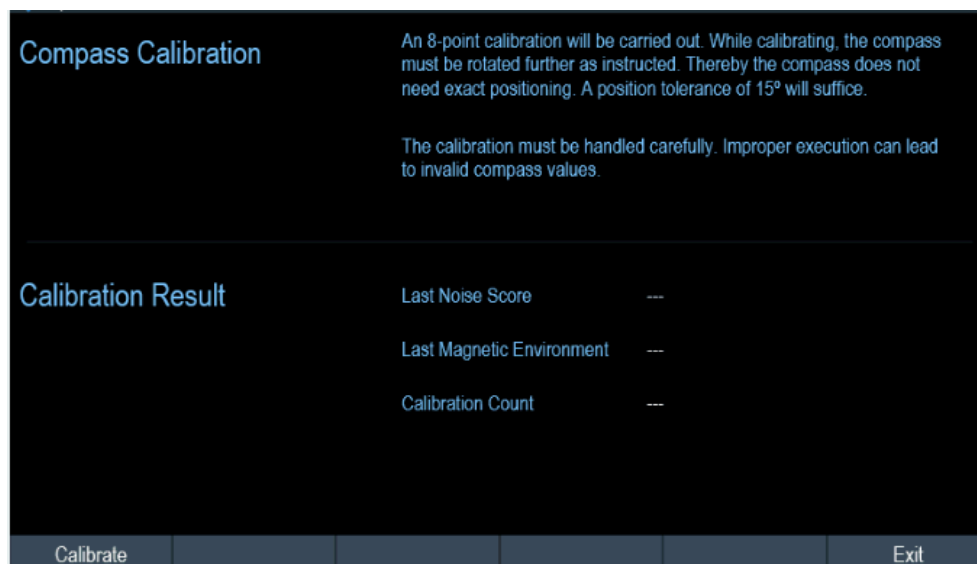

Compass Calibration	An 8-point calibration will be carried out. While calibrating, the compass must be rotated further as instructed. Thereby the compass does not need exact positioning. A position tolerance of 15° will suffice.	
	The calibration must be handled carefully. Improper execution can lead to invalid compass values.	
Calibration Result	Last Noise Score	---
	Last Magnetic Environment	---
	Calibration Count	---
Calibrate		Exit

The R&S Spectrum Rider starts the calibration.

For antenna calibration, it is necessary to move the antenna according to the direction as instructed on the screen.

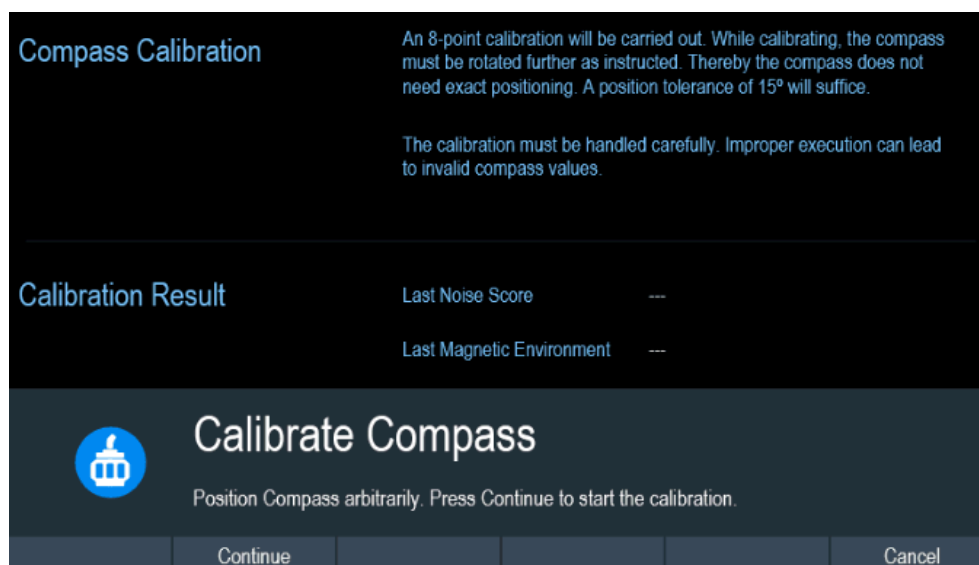

- When calibration completes, the R&S Spectrum Rider displays a "Calibration Successful" message.

The R&S Spectrum Rider displays the calibration result.

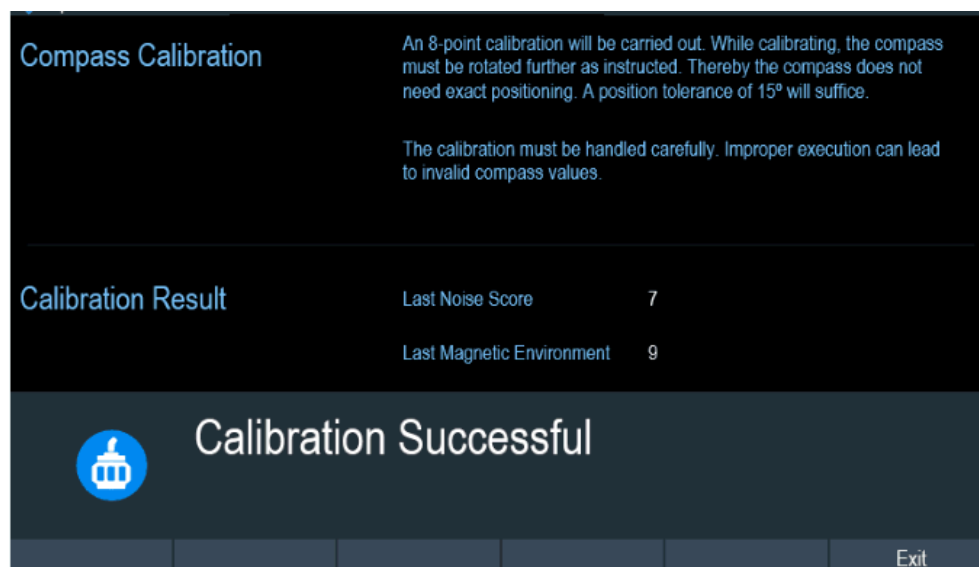

3.2.10.3 Using the GPS receiver

The R&S Spectrum Rider can locate your exact position if you connect the GPS receiver (R&S HA-Z340, order number 1321.1392.02) to the USB connector.



Location to secure GPS receiver (R&S HA-Z340)

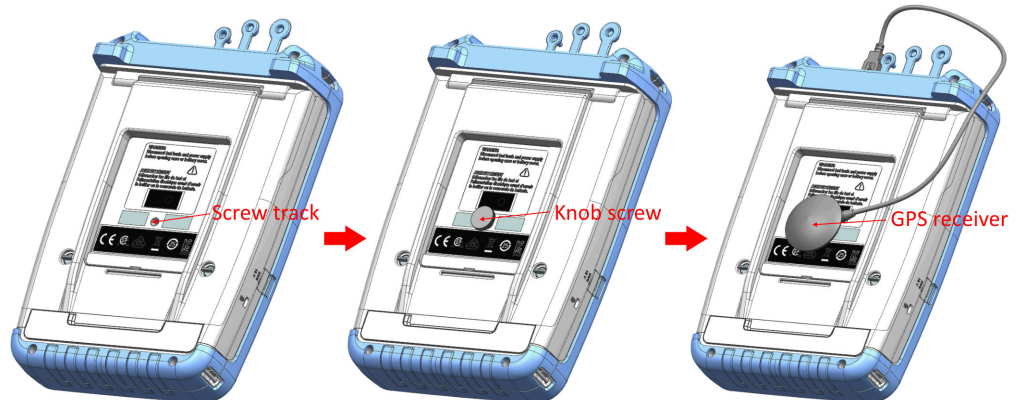
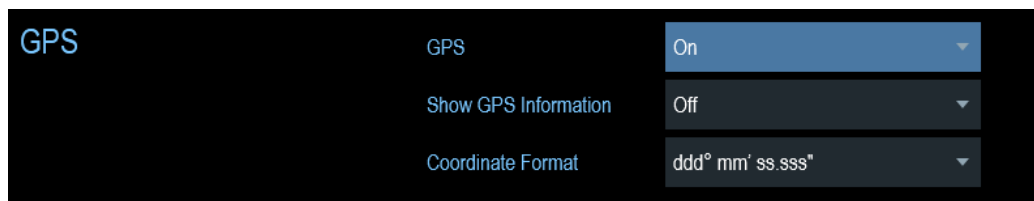

Figure 3-6: Location of GPS receiver

- Tighten the knob screw supplied with the GPS receiver to the screw track at the back of R&S Spectrum Rider.
- The GPS receiver can be conveniently attached to the knob screw as shown in [Figure 3-6](#).

The "Instrument Setup" dialog box provides all settings necessary to configure the GPS receiver.



Enabling the GPS receiver

1. In the "Instrument Setup" dialog box, select the "GPS" item.
A drop-down menu opens to turn the GPS receiver on or off.
2. Turn the GPS receiver on or off as required.

When "GPS" item is turned on, the R&S Spectrum Rider is ready to receive GPS data.

Displaying GPS information

1. In the "Instrument Setup" dialog box, select the "Show GPS Information" item.
A drop-down menu opens to turn the display of the GPS information on and off.
2. Turn the display of GPS information on or off as required.

When the "Show GPS Information" item is set on, the R&S Spectrum Rider displays the GPS coordinates and number of satellites in the [Measurement result view](#) when sufficient connection is established to the GPS satellites.

GPS 1°20'20.022" N 103°57'53.238" E 52.5 m Satellites 9

When the satellite connection is lost, the GPS coordinates and number of satellites are displayed with a white bar.

GPS --- Satellites ---

When the GPS receiver is not connected or enabled, a message "GPS Not Connected" is displayed in the [measurement result view](#).

GPS Not Connected

State of GPS receiver

The state of the GPS receiver locking to satellite is shown in the title bar is illustrated as follows.

- **GPS** indicates that the GPS receiver is enabled and that there is a fix connection with enough satellites for the GPS receiver to provide the coordinates.
- **GPS** indicates that the GPS receiver is enabled but that there is no fix connection to a satellite.
- **GPS** indicates that the GPS receiver is enabled but that there is no GPS receiver connection.
- The title bar shows no symbol if the GPS receiver is not enabled

Selecting the coordinate format

1. In the "Instrument Setup" dialog box, select the "Coordinate Format" item. A drop-down menu opens to select the coordinate format.

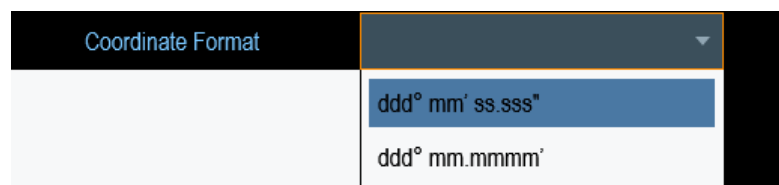

2. Select the coordinate format from the drop-down menu.

3.2.10.4 Configuring date and time

The R&S Spectrum Rider has an internal clock that can apply a date and timestamp. In the "Instrument Setup" dialog box, you can set both date and time.

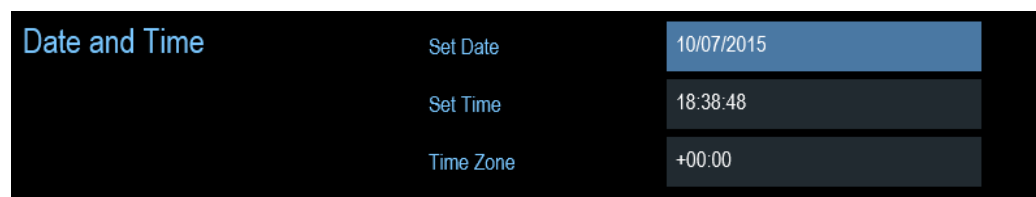

Setting the date

1. In the "Instrument Setup" dialog box, select the "Set Date" item.
2. Enter the date you want with the numeric keys. The sequence depends on the selected date format. See "[Setting the date format](#)" on page 61.



3. Confirm the entry with the rotary knob.

Setting the time

1. In the "Instrument Setup" dialog box, select the "Set Time" item.
2. Enter the time you want with the numeric keys.



3. Confirm the entry with the rotary knob.
After you have entered the time, the R&S Spectrum Rider verifies the validity of the time. If it is not a valid time, it sets to the next valid time.

Selecting the time zone

1. In the "Instrument Setup" dialog box, select the "Time Zone" item.
2. Enter a positive or negative time offset relative to the system time with the numeric keys.



3. Confirm the entry with the rotary knob.
After you have confirmed the time zone, the R&S Spectrum Rider adjusts the displayed time accordingly without changing the system time.

3.2.10.5 Selecting regional settings

The regional setting allows you to select a different language and date format.

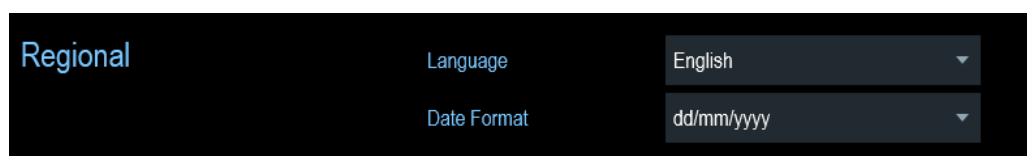

Setting the language

The R&S Spectrum Rider supports several languages for the user interface.

The following is a list of languages that the instrument supports:

English	Spanish	Japanese	Russian
French	Italian	Chinese	Hungarian
German	Portuguese	Korean	Traditional Chinese

1. In the "Instrument Setup" dialog box, select the "Language" item. A drop-down menu opens to select the language.



2. Select the desired language from the drop-down menu.
3. Reboot the device to activate the choice of selected language.

Setting the date format

The R&S Spectrum Rider provides two different formats to display the date.

1. In the "Instrument Setup" dialog box, select the "Date Format" item. A drop-down menu opens to select the date format.



2. Select the required date format from the drop-down menu.

3.2.10.6 Configuring the display

The display setting configures the display characteristics and the touch interface.

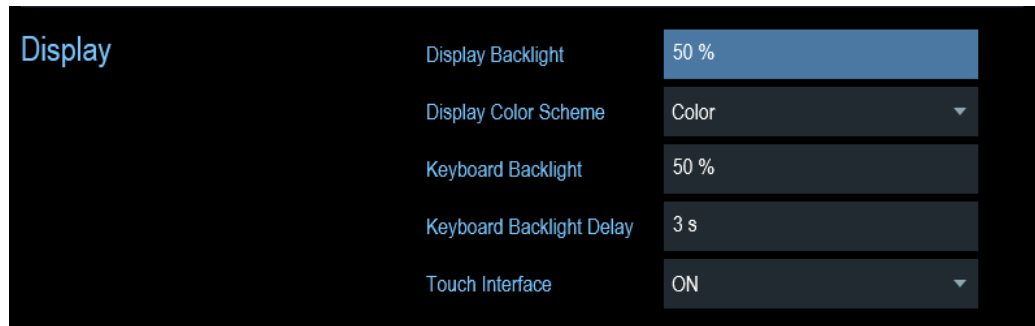

The display of the R&S Spectrum Rider is a TFT color LCD display.

The ideal brightness of the display depends on the intensity of the backlight. To strike a balance between battery operating time and screen display quality, set the backlight intensity to the minimum brightness needed.

To optimize the viewing angle, adjust the display color scheme settings. To achieve the maximum contrast, the screen can be switched from color display to black-and-white display.

The intensity of the keyboard backlight is adjustable with a time delay setting to turn off the backlight. The keyboard backlight remains on until the time specified by the "Keyboard Backlight Delay" or a subsequent key is pressed.

Adjusting the display backlight

1. In the "Instrument Setup" dialog box, select the "Display Backlight" item.
2. Enter the backlight intensity you want with the numeric keys.



The backlight intensity is a percentage from 0% to 100% with 100% being the brightest.

3. Confirm the entry with the rotary knob.

Adjusting the display color scheme

1. In the "Instrument Setup" dialog box, select the "Display Color Scheme" item. A drop-down menu opens to select the display color scheme.

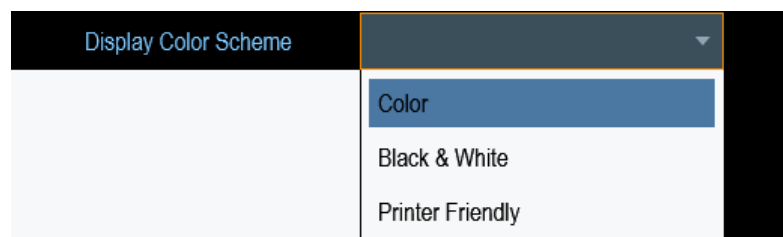

2. Select the color scheme from the drop-down menu.

- a) "Color" selects a color display.
- b) "Black & White" selects monochrome display.
- c) "Printer Friendly" inverts the colors.

Adjusting the keyboard backlight

1. In the "Instrument Setup" dialog box, select the "Keyboard Backlight" item.
2. Enter the backlight intensity you want with the numeric keys.



The backlight intensity is a percentage from 0% to 100% with 100% being the brightest.

3. Confirm the entry with the rotary knob.

Adjusting the keyboard backlight delay

1. In the "Instrument Setup" dialog box, select the "Display Backlight" item.
2. Enter the time you want to turn off the keyboard backlight with the numeric keys.



The time delay has a range of 1s to 10s.

3. Confirm the entry with the rotary knob.

Activating the touchscreen interface

1. In the "Instrument Setup" dialog box, select the "Touch Interface" item.
2. Select "ON" to activate the touchscreen interface with R&S Spectrum Rider.

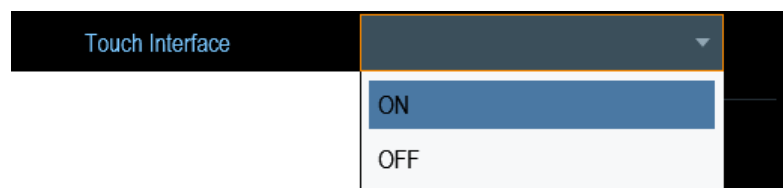

3. Select "OFF" to deactivate the touchscreen interface.
Note: If the touch interface is not activated, the [On-screen keyboard](#) is disabled.

3.2.10.7 Configuring the audio output

The audio settings control the audio output of the system.

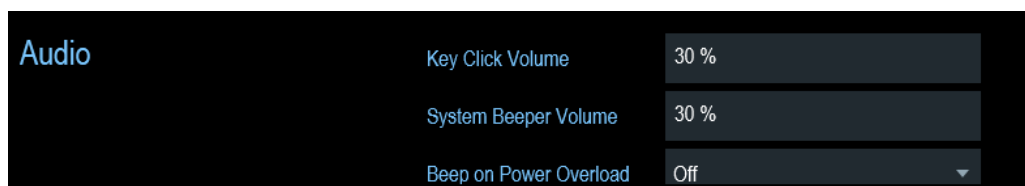

Setting the key click volume

The key click volume sets the volume of the sound that the R&S Spectrum Rider produces when you press a key or select a softkey.

1. In the "Instrument Setup" dialog box, select the "Key Click Volume" item.
2. Enter the volume you want with the numeric keys.



The key click volume is a percentage from 0% to 100% with 100% being the loudest.

3. Confirm the entry with the rotary knob.

Setting the system beeper volume

The system beeper volume sets the volume of the system beeper of the R&S Spectrum Rider used, i.e. if a message box pops up.

1. In the "Instrument Setup" dialog box, select the "System Beeper Volume" item.
2. Enter the volume you want with the numeric keys.



The system beeper volume is a percentage from 0% to 100% with 100% being the loudest.

3. Confirm the entry with the rotary knob.

Activating / Deactivating audio alert for power overload

In case the R&S Spectrum Rider detects an overload at one of its inputs, you can configure the alert audible.

1. In the "Instrument Setup" dialog box, select the "Beep on Power Overload" item.
2. Select "Beep on Power Overload" to "On".
When this beeper turns on, the R&S Spectrum Rider makes a sound every time it detects an overload.



Beep on Power Overload Off

3.2.10.8 Configuring power supply

The "Current Power Source" shows the source that the R&S Spectrum Rider is powered by.

When you are using the battery to power up the R&S Spectrum Rider, the remaining "Battery Level" is displayed as a percentage with 100 % representing a full charge.

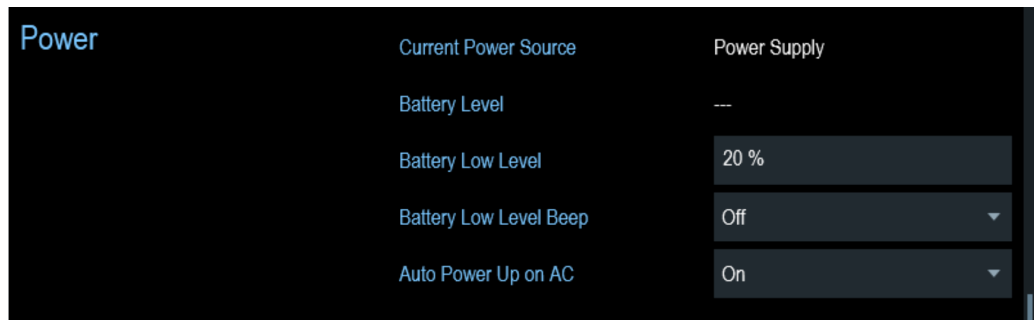

Setting the battery low level

The battery low level is a reminder that the remaining battery charge might be used up soon.

When the battery low level is reached, the battery symbol in the [title bar](#) turns red and starts blinking. See [Chapter 3.1.1.5, "Battery operation"](#), on page 26.

1. In the "Instrument Setup" dialog box, select the "Battery Low Level" item.
2. Enter the charge level in percent of a fully charged battery with the numeric keys.



Battery Low Level 20 %

3. Confirm the entry with the rotary knob.

Activating / Deactivating audio alert for battery low-level state

The R&S Spectrum Rider also allows you to turn on an audio signal that indicates that the battery has reached its low-level state.

1. In the "Instrument Setup" dialog box, select the "Battery Low Level Beep" item.

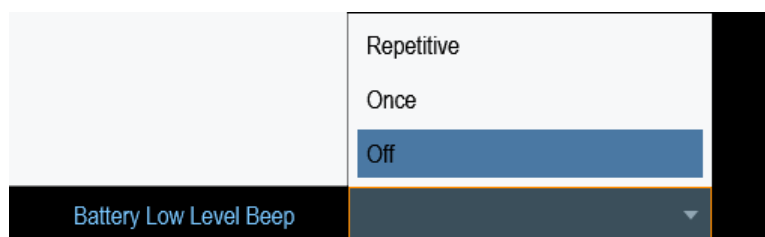

2. Select either "Repetitive" or "Once" to turn on the audio signal.
If you have selected "Once", the R&S Spectrum Rider beeps once if the battery runs out of power. For a continuous beep, select "Repetitive".
3. Select "Off" to turn off the beeper.

Auto power up

The R&S Spectrum Rider allows you to auto power up the instrument when supplying with an AC power, without pressing the [POWER] key button.

1. In the "Instrument Setup" dialog box, select the "Auto Power Up on AC" menu item.



2. Select "On" to turn on the auto power up mode.
On the next power up cycle, the R&S Spectrum Rider goes into the auto power up mode when supplying with an AC power.

3.2.10.9 Internal alignment



R&S Spectrum Rider option

R&S FPH-K35 (order number: 1321.1563.02) option is required to operate the R&S Spectrum Rider internal frequency clock and reference level adjustment.



Operating mode

The frequency clock and reference level alignment can only be performed in "Spectrum" mode. If wrong operating mode is detected, a warning message is displayed before alignment is performed.

For more information on the operating mode of the R&S Spectrum Rider, see [Chapter 3.2.8.4, "System keys"](#), on page 45.

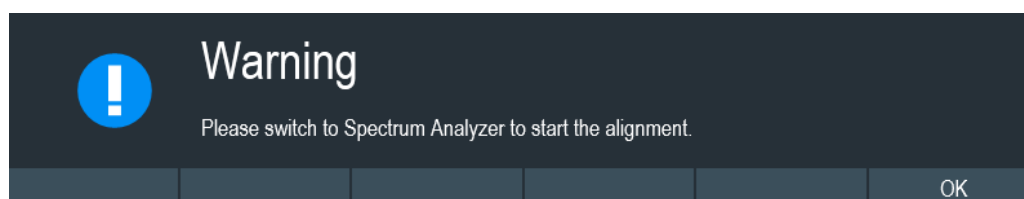

1. In the "Instrument Setup" dialog box, select frequency clock or reference level "Align" item to perform alignment.

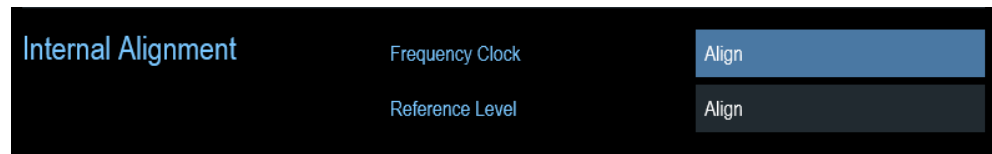

2. The R&S Spectrum Rider displays the "Perform Alignment" dialog.

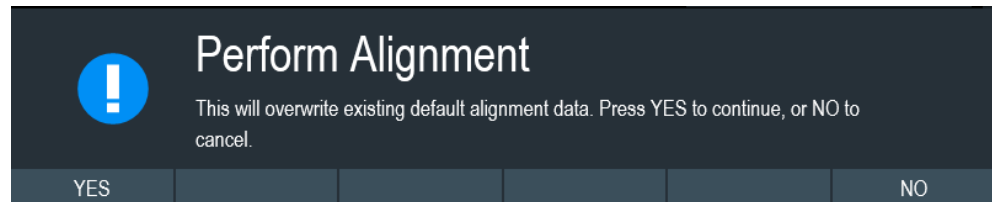

3. Select "Yes" to overwrite existing default alignment data and proceed to perform alignment. The R&S Spectrum Rider displays the "Alignment" dialog. Depending on the selected alignment item, different input signal is required. See [Figure 3-7](#) and [Figure 3-8](#).

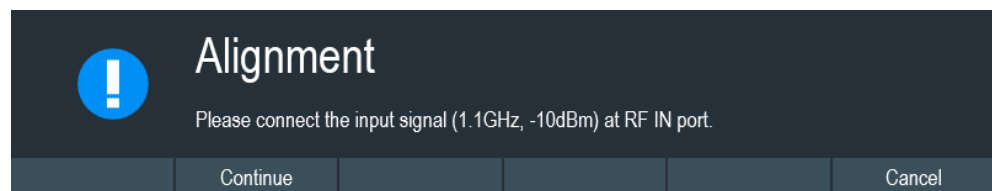

Figure 3-7: Input signal for frequency clock alignment

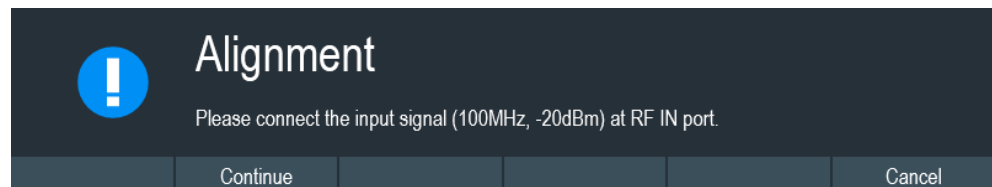
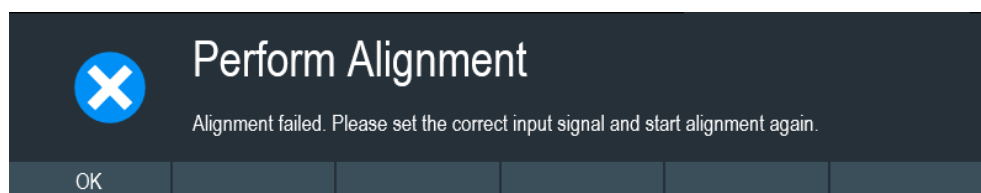

Figure 3-8: Input signal for reference level alignment

4. Connect an input signal of 1.1 GHz, -10dBm at the "RF IN" port for frequency alignment or 100 MHz, -20 dBm at the "RF IN" port for reference level alignment.
5. Select "Continue" to start the internal alignment on the instrument. The R&S Spectrum Rider overwrites existing adjustment data and performs the internal alignment. If wrong input signal is detected, the R&S Spectrum Rider displays a message of a failed alignment dialog.



3.2.10.10 Resetting the R&S Spectrum Rider

You can either preset the R&S Spectrum Rider or reset it to factory settings.

Presetting the R&S Spectrum Rider

The [PRESET] key resets the R&S Spectrum Rider to the default setup of the currently active operating mode.

This default setup allows you to define the instrument with a new configuration based on a defined measurement parameter without using parameters from a previous measurement unintentionally still being active.

- ▶ Press the [PRESET]  key.

Resetting the R&S Spectrum Rider

A "Reset to Factory Settings" resets the R&S Spectrum Rider to the factory defaults.

During a reset, the R&S Spectrum Rider restores the original configuration. It also deletes all customized datasets (limit lines, standards, channel tables, transducer tables etc.). Instead, it will reinstall all the datasets that have been available after delivery.



Risk of data loss

All datasets you have saved are deleted during a factory reset.

1. In the "Instrument Setup" dialog box, select the "Reset to Factory Settings" item.
2. Confirm the entry with the rotary knob.



The R&S Spectrum Rider initiates the reset procedure and shows a warning message box.

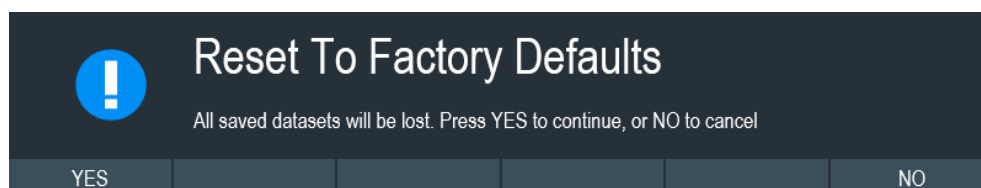

3. A corresponding dialog box opens for selection.

- Select "Yes" to perform the reset. During the reboot, it shows a corresponding message.
- Select "No" to cancel the reset.

3.2.11 Connecting the R&S Spectrum Rider to a PC

The R&S Spectrum Rider comes with the R&S InstrumentView software package. This software package features several tools that allow you to document measurement results, create and edit the different datasets necessary for the instrument. For more information, see the R&S InstrumentView software manual.

The .NET Framework 2.0 (or higher) is required to run the software properly.

You can set up a connection between the R&S Spectrum Rider and R&S InstrumentView either via its [LAN port](#) or its [mini USB port](#).

You have to install the R&S InstrumentView software on the PC before you are able to establish a connection.

Download the latest R&S InstrumentView from <http://www.rohde-schwarz.com/product/fph.html>.



Firewall settings

If no connection can be established between the software and the R&S Spectrum Rider after successful configuration, check the firewall settings on your PC.

- [LAN connection](#).....69
- [USB connection](#)..... 75

3.2.11.1 LAN connection

You can connect the R&S Spectrum Rider directly to the PC with a LAN cable. The [LAN port](#) is located behind a protective cap on the right side of the R&S Spectrum Rider.

You can set up the LAN connection in the "Instrument Settings" dialog box.

LAN	
MAC Address	00-0a-35-00-01-22
DHCP	Off
IP Address	172.17.75.1
Subnet Mask	255.255.255.0
Gateway	0.0.0.0

For a direct connection between the PC and R&S Spectrum Rider, the DHCP (Dynamic Host Configuration Protocol) of the R&S Spectrum Rider has to be turned off (which is the default state).

1. In the "Instrument Settings" dialog box, select the "DHCP" item. A drop-down menu opens to select the DHCP state.
2. Select "DHCP" to "On" or "Off" as required.

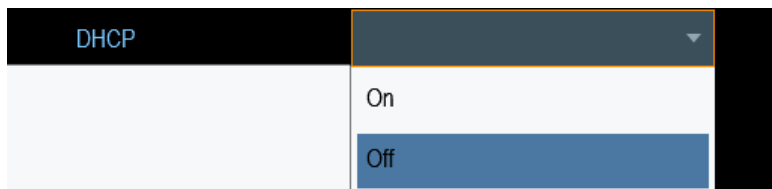

Setting an IP address and subnet mask

To establish a connection, the PC and R&S Spectrum Rider have to be in the same subnet.

Subnet mask

1. Identify the subnet mask of your PC, i.e. in the Microsoft Windows "TCP/IP Properties".

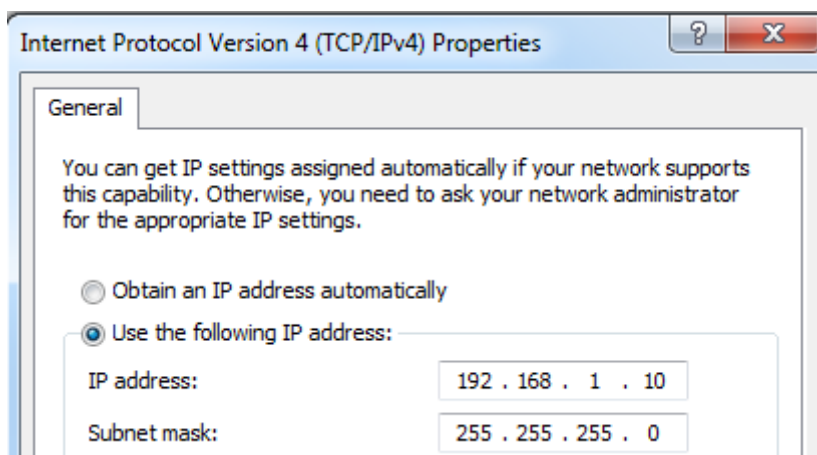

2. In the "Instrument Settings" dialog box, select the "Subnet Mask" item.
3. Enter the subnet mask of the PC with the numeric keys.



After you have matched the subnet mask, you can define the IP address. When both devices are in the same subnet, the first three digits of the IP address are usually the same. See example below:

Example:

IP address for PC: 192.168.1.10

IP address for R&S Spectrum Rider: 192.168.1.20

IP address

1. Identify the IP address of your PC, i.e. in the Microsoft Windows "TCP/IP Properties".

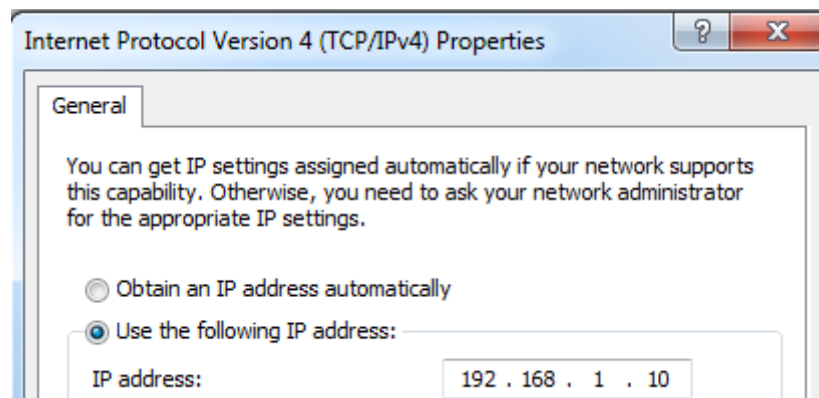



2. In the "Instrument Settings" dialog box, select the "IP Address" item.
3. Confirm the entry with the rotary knob.
4. Enter the IP address of the PC with the numeric keys.

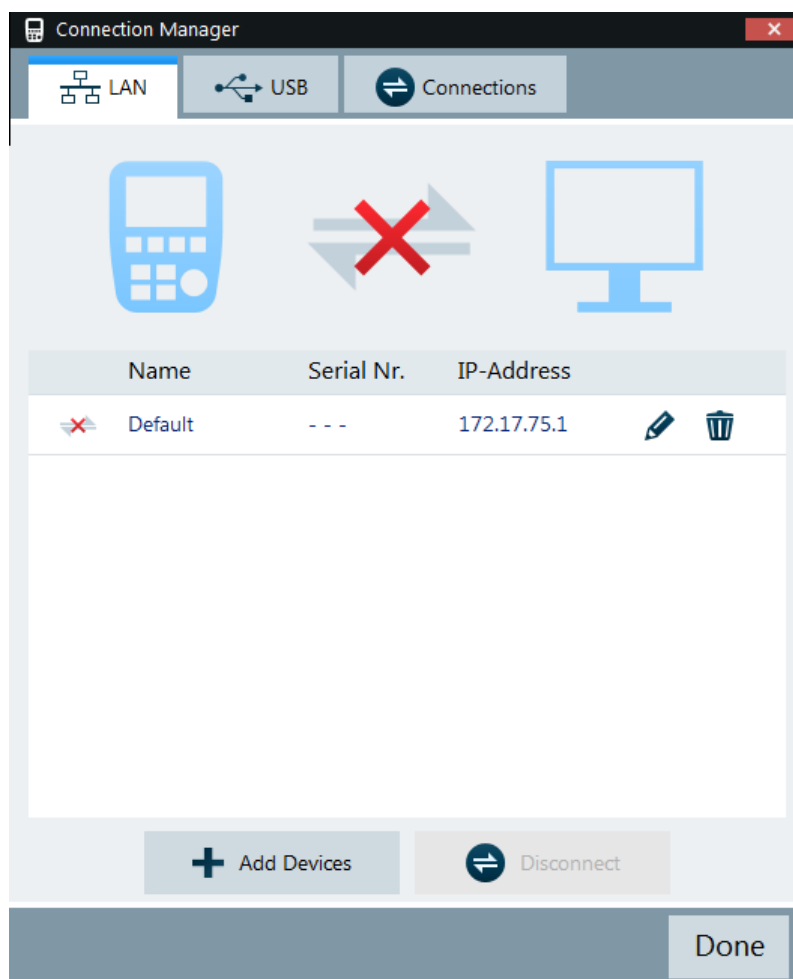

Configuring the R&S InstrumentView software package

1. Start the R&S InstrumentView software.
2. Select the "LAN" tab in the screen layout.



3. During the initial startup, the "IP-Address" field is set to default "172.17.75.1". You can edit the IP address using the   icons
4. Select the "Add Devices" button to create a new network connection.

Add Single Device

Name: Demo



IP Address: 192.168.1.20 **Default**

Discover Network Devices

Network Adapter: Local Area Connection

- Wireless Network Connection 2
- Bluetooth Network Connection
- Wireless Network Connection
- Local Area Connection
- VirtualBox Host-Only Network

Ok **Cancel**

5. Specify a name and the IP address for the new network connection.
6. Select "Local Area Connection" for the "Network Adapter".
7. Confirm the entry with the "OK" button to add the new instrument to the connection manager list.
8. Depending on the connection status icon,   you can connect or disconnect an instrument from the connection manager list

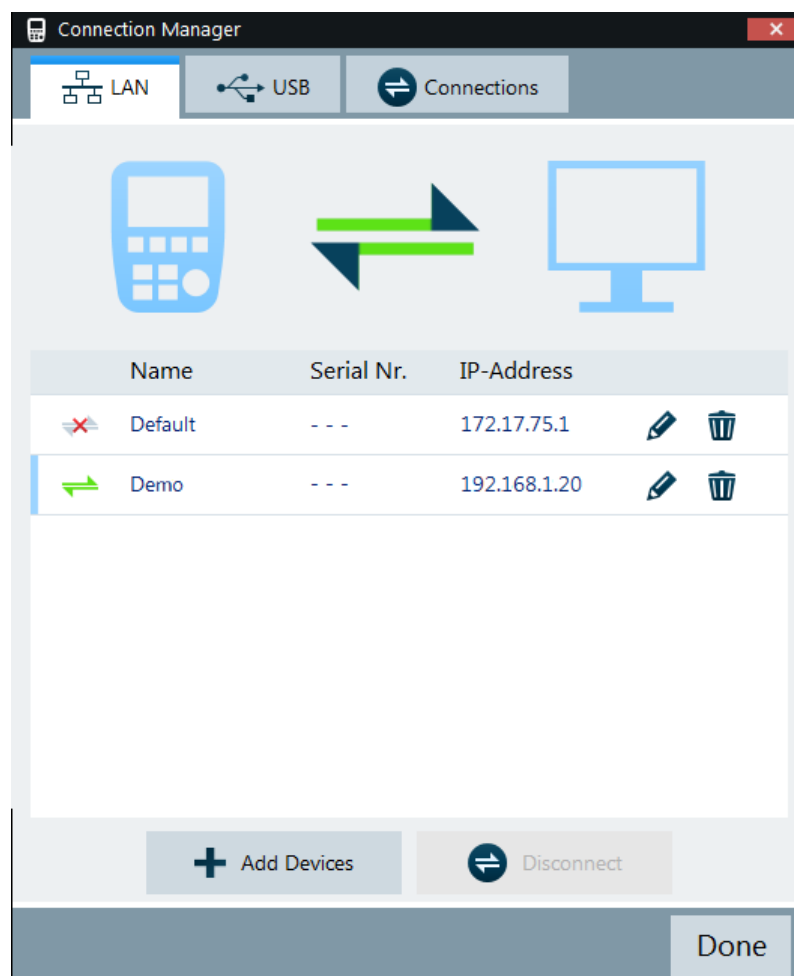

Connecting the R&S Spectrum Rider in an existing LAN

You can either get the R&S Spectrum Rider IP address automatically from the DHCP server or manually assign a fixed address.

With manual allocation, a fixed IP address and subnet mask must be assigned to the R&S Spectrum Rider as described in [Chapter 3.2.11.1, "LAN connection"](#), on page 69. After setting up the R&S Spectrum Rider, configure the R&S InstrumentView software with the assigned IP address as described in ["Configuring the R&S InstrumentView software package"](#) on page 71.



Free IP address

Contact your IT system administrator to get a free IP address.

In networks with a DHCP server, the DHCP permits automatic allocation of the network configuration to the R&S Spectrum Rider connected via LAN cable. For this purpose, the DHCP has to be active on the R&S Spectrum Rider.

The DHCP is off by default. Turn it on like this:

1. In the "Instrument Setup" dialog box, select the "DHCP" item.
2. Select "DHCP" to "On" to activate the DHCP.

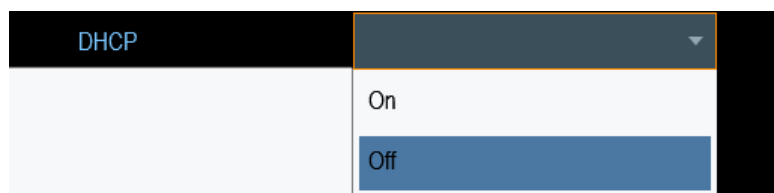

The R&S Spectrum Rider is now allocated an IP address and the subnet mask by the DHCP server. This can take several seconds.

The IP address and subnet mask are automatically set in the corresponding input fields and are no longer available for editing.



Configure the R&S InstrumentView software with the IP address and subnet mask as defined by the DHCP server. For more information, see [Chapter 3.2.11.1, "LAN connection"](#), on page 69.

3.2.11.2 USB connection

Alternatively, you can connect the R&S Spectrum Rider to the PC with a USB cable. The [mini USB interface](#) is located behind a protective cap on the right side of the R&S Spectrum Rider.

When you connect the R&S Spectrum Rider to a computer for the first time, Windows tries to install the new hardware automatically. The required drivers are installed along with the R&S InstrumentView software package.

When the drivers have been found on your system and the hardware has been successfully installed, Windows shows a corresponding message.

1. Connect the R&S Spectrum Rider via the mini USB port to your computer.
2. Start the R&S InstrumentView on the PC.
3. There is only one USB instance in the connection manager list. See [Figure 3-9](#). Depending on the connection status icon,   you can connect or disconnect an instrument from the connection manager list

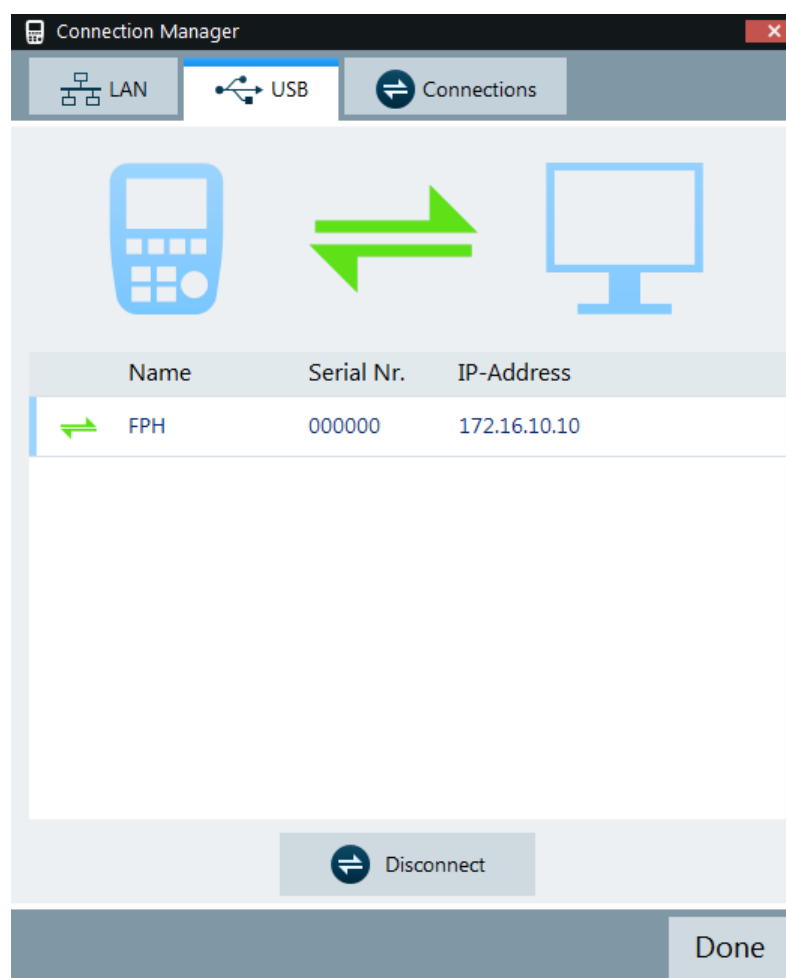

Figure 3-9: USB connection

3.3 Trying out the instrument

This chapter provides a short overview of the first steps of the measurements you can perform with the R&S Spectrum Rider.

- [Using the spectrum analyzer](#).....76
- [Using a power sensor](#)..... 84
- [Saving and recalling results and settings](#).....89

3.3.1 Using the spectrum analyzer

This chapter provides a short overview of the first steps of the measurements you can perform with the R&S Spectrum Rider.

3.3.1.1 Attenuating the signal

You can attenuate the signal to a suitable level either manually or automatically.

In case of automatic attenuation, the level of attenuation at the RF input depends on the current reference level. The R&S Spectrum Rider provides two ways of automatic attenuation.

For the highest possible sensitivity, it provides the "Auto Low Noise" attenuation mode. For the lowest possible intermodulation, it provides the "Auto Low Distortion" mode.

The main difference between the two modes is that the attenuation level is 5 dB to 10 dB higher in case of "Auto Low Distortion" than it is for "Auto Low Noise". In the default state, "Auto Low Distortion" is active.

1. Press [AMPT] key.
2. Select "Att/Amp/Imp" softkey.
3. Select either the "Auto Low Noise" or "Auto Low Distortion" menu item.
The R&S Spectrum Rider shows the current attenuation level in the "Parameter view". The currently active menu item has a blue background and the selected parameters is indicated with a blue dot in the menu item.

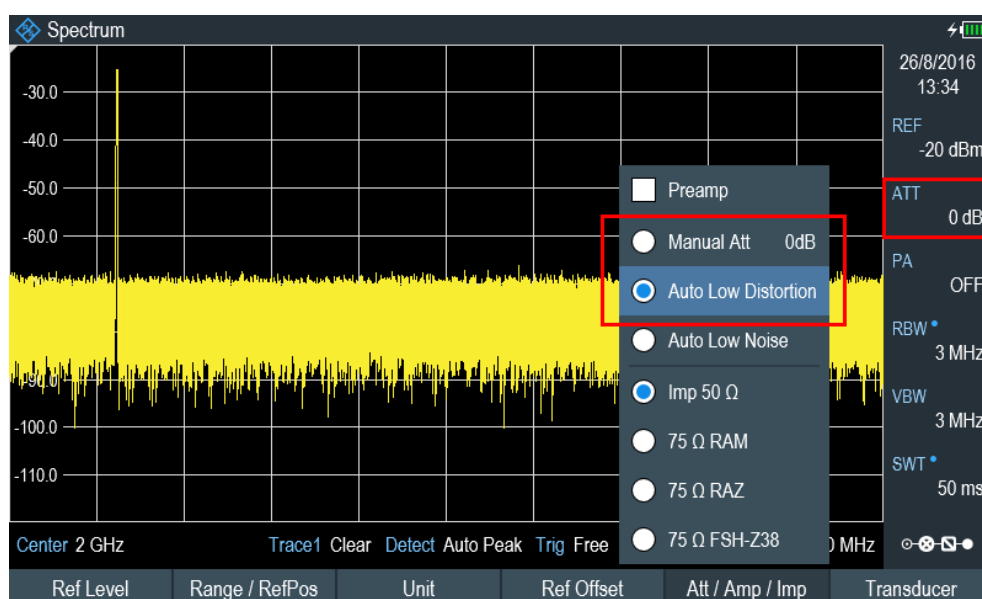

You can also set the attenuation manually. The R&S Spectrum Rider provides attenuation in the range from 0 dB to 40 dB in 5 dB steps.

4. Press [AMPT] key.
5. Select "Att/Amp/Imp" softkey.
6. Select the "Manual Att" menu item.
The R&S Spectrum Rider opens an entry box to define the attenuation. Two methods are provided to fill in the input fields:
 - Directly with the number keys

- Using rotary knob

While you can enter any number you want with the number keys, using the rotary knob is coupled to a certain step size in most cases.

If you use the rotary knob to change the attenuation, i.e. the step size is 5 dB.

7. Enter the attenuation you need.

The R&S Spectrum Rider shows the current attenuation level in the "Parameter View".

3.3.1.2 Using the preamplifier

The R&S Spectrum Rider has an optional preamplifier (R&S FPH-B22, order number 1321.0680.02) to increase sensitivity. Depending on the frequency, the gain of the amplifier is in the range from 15 dB to 20 dB and increases the sensitivity by 10 dB to 15 dB.

In the signal path, the preamplifier comes after the input protection circuit and before the RF attenuator of the R&S Spectrum Rider to provide excellent sensitivity when the preamplifier is switched on.

1. Press [AMPT] key.
2. Select "Att/Amp/Imp" softkey.
3. Enable or disable the "Preamp" checkbox to turn on or off the preamplifier of the R&S Spectrum Rider.

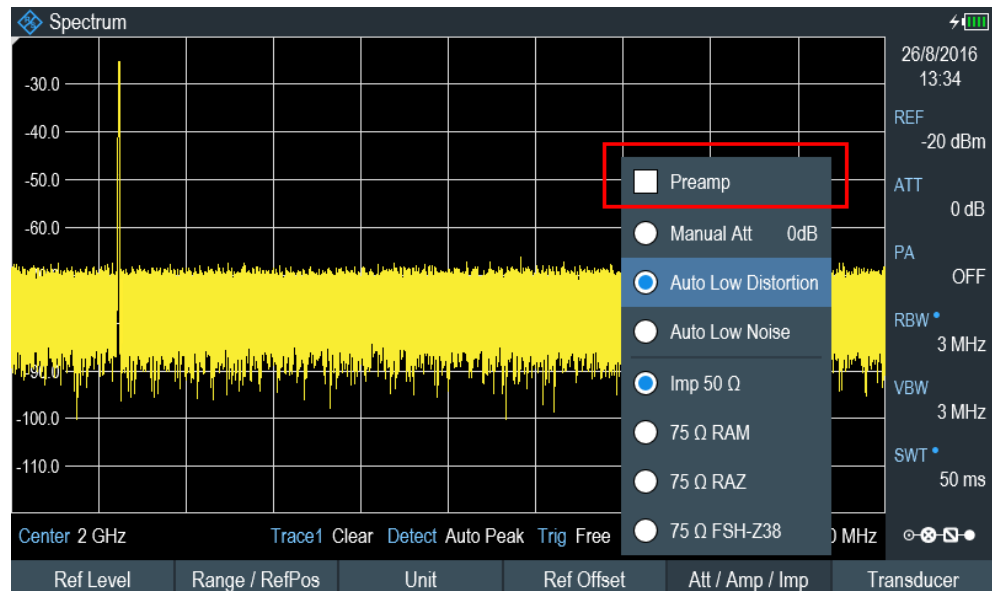

The magnitude of amplification depends on the reference level. This coupling to the reference level makes sure that the dynamic range is at an optimum.

3.3.1.3 Measuring CW signals

A basic task for spectrum analyzers is to measure the level and frequency of sinewave signals. The following examples illustrate an effective way of performing these measurements.

A signal generator, e.g. R&S SMBV provides the signal source.

Test setup

Connect the RF output of the signal generator to the RF input of the R&S Spectrum Rider.

Signal generator settings:

- Frequency: 500 MHz
- Level: -25 dBm

Measuring the level

1. Press [PRESET] key.
The R&S Spectrum Rider is reset to its default state.
After the preset, the R&S Spectrum Rider displays the frequency spectrum over its full frequency span.
At 500 MHz, the generator signal is displayed as a vertical line. To analyze the generator signal at 500 MHz in more detail, reduce the frequency span.
2. Select the "Center" softkey at the "Parameter view".
The R&S Spectrum Rider opens an entry box to define the center frequency.
3. Enter a center frequency of 500 MHz.
The signal is now in the center of the display.
4. Select the "Span" softkey at the "Parameter view".
The R&S Spectrum Rider opens an entry box to specify the span.
5. Enter a span of 20 MHz.
The R&S Spectrum Rider now displays the generator signal with a higher resolution.



Setting the reference level

The level at the top of the measurement diagram is called the reference level. To obtain the best dynamic range from the R&S Spectrum Rider, you should use its full level range. That means that the maximum level value should be at or close to the top of the measurement diagram (= reference level).

1. Press "REF" softkey at the "Parameter view".
The R&S Spectrum Rider opens an entry box to enter the reference level.
2. Enter a reference level of -25 dBm.
The R&S Spectrum Rider reduces the reference level by 5 dB.

The maximum trace value is close to the maximum scale value of the measurement diagram. The increase in the displayed noise floor is minimal. The difference between the signal maximum and the displayed noise (i.e. the dynamic range) has, however, been increased.

Using markers

The R&S Spectrum Rider has markers to read out signal levels and frequencies. Markers are always positioned on the trace. Both the level and frequency at their current positions are displayed on the screen.

- ▶ Press [MARKER] key.
The R&S Spectrum Rider activates a marker and puts it on the maximum value on the trace. The coordinates of the marker are shown in a table above the measurement diagram.
A red vertical line represents the position of the marker on the horizontal axis (i.e. the frequency). A small red horizontal dash represents the marker position on the vertical axis (i.e. the level).

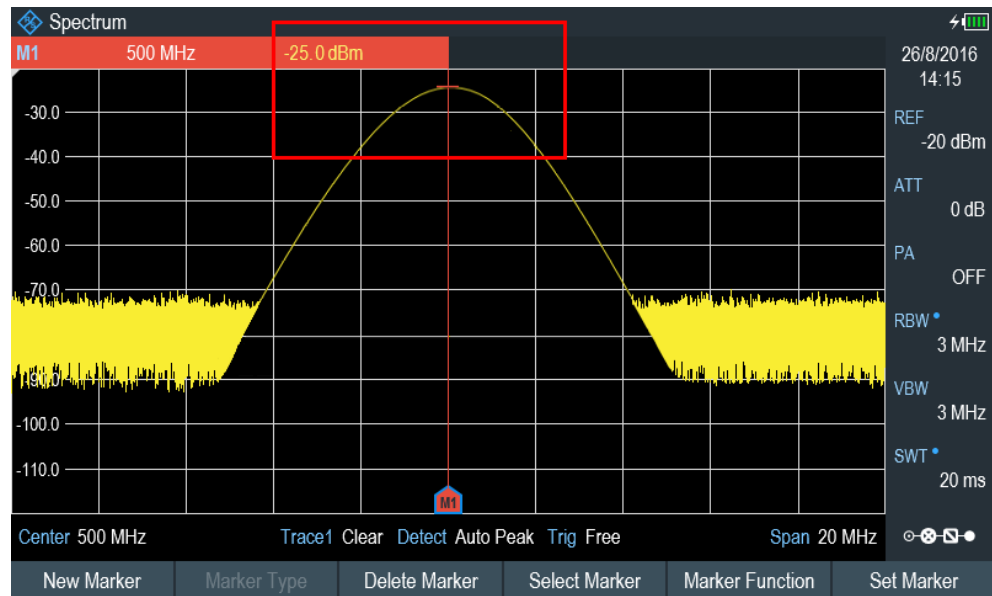

Measuring the frequency

The trace consists of 711 measurement points (frequency points). The marker is always positioned on one of these measurement points. The R&S Spectrum Rider calculates the marker frequency from the frequency of the measurement point, the center frequency and the frequency span that have been set. The measurement-point resolution, and consequently the accuracy of the marker frequency readout, therefore depend on the frequency span that has been selected.

The R&S Spectrum Rider has a frequency counter to increase the accuracy of the marker-frequency readout. It completes the sweep, then counts the frequency at the marker position.

1. Press the "Marker Function" softkey at the "Parameter view".
2. Select the "Frequency Count" from the menu item.

The measurement result of the frequency counter is displayed at the "Measurement result view". When the frequency counter is active, the highest resolution of the frequency readout that can be achieved is 0.0001 Hz. The accuracy is determined by the internal reference frequency which is far more exact than the pixel-oriented marker readout.

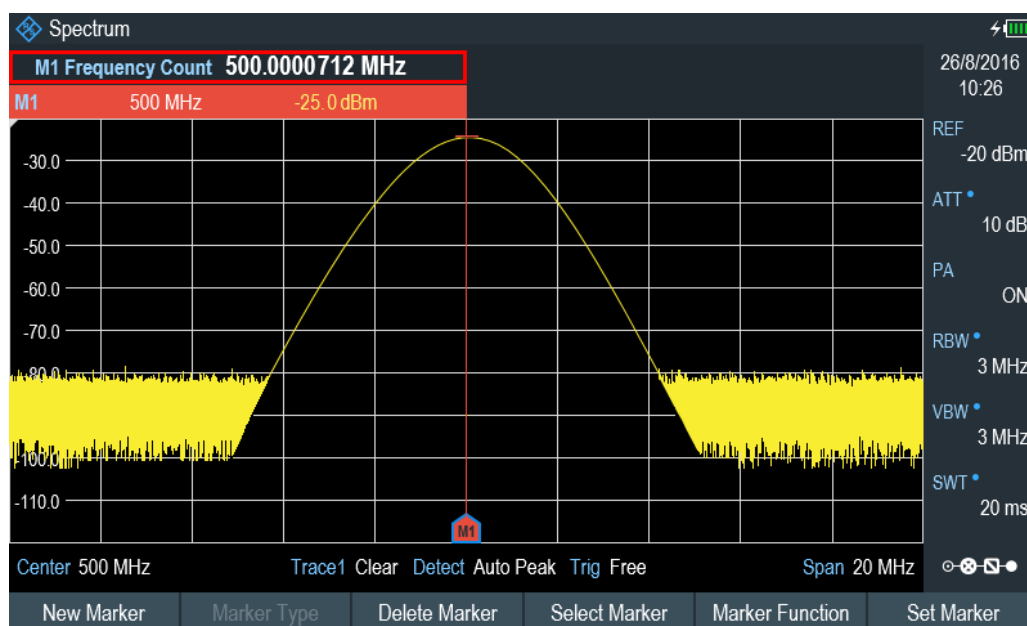

3.3.1.4 Measuring harmonics

A spectrum analyzer is ideal to measure harmonic levels or harmonic ratios, because it can resolve different signals in the frequency domain.

With marker functions, you can speed up the measurement tasks.

A signal generator, e.g. R&S SMBV provides the signal source.

Test setup

Connect the RF output of the signal generator to the RF input of the R&S Spectrum Rider.

Signal generator settings:

- Frequency: 100 MHz
- Level: -20 dBm

Detecting harmonics

1. Press [PRESET] key.
The R&S Spectrum Rider is reset to its default state.
After the preset, the R&S Spectrum Rider displays the frequency spectrum over its full frequency span.
At 100 MHz, the generator signal is displayed as a vertical line. In addition, you can see the harmonics as smaller vertical lines at frequencies that are multiples of 100 MHz. To measure the second harmonic ratio, decrease the span.
2. Press [FREQ] key.
3. Select the "Start" softkey at the "Measurement footer bar".

The R&S Spectrum Rider opens an entry box to enter the start frequency.

4. Enter a start frequency of 50 MHz.
5. Confirm the entry with one of the unit keys.
6. Select the "Stop" softkey at the "Measurement footer bar".
The R&S Spectrum Rider opens an entry box to enter the stop frequency.
7. Enter a stop frequency of 250 MHz.
8. Confirm the entry with one of the unit keys.
The R&S Spectrum Rider displays the frequency spectrum in the range from 50 MHz to 250 MHz. This frequency range visualizes the signal itself at 100 MHz and the second harmonic at 200 MHz.

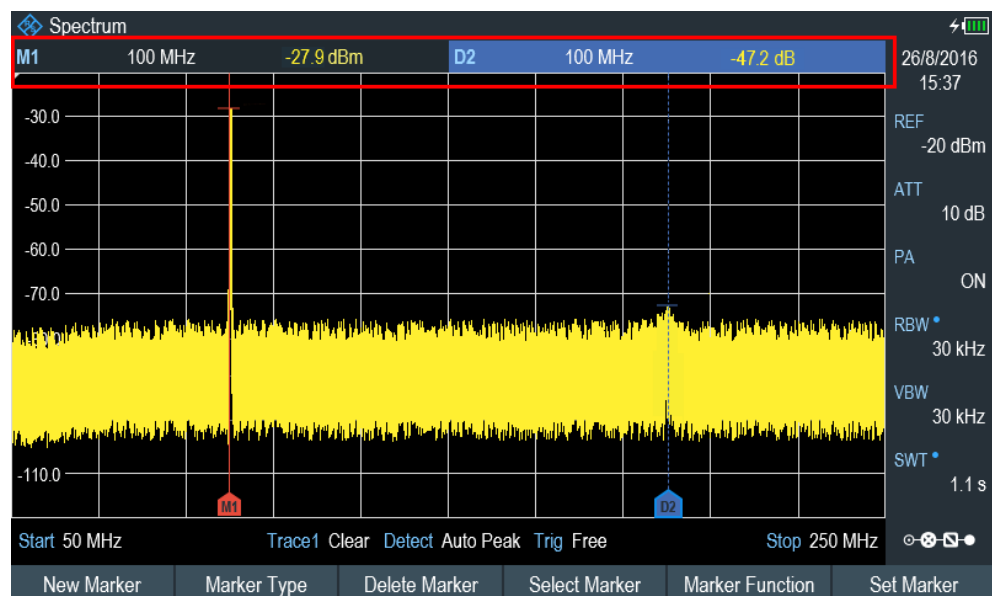

To measure the harmonic ratio, set the marker on the signal and a delta marker on the second harmonic.

9. Press [MARKER] key.
The R&S Spectrum Rider sets a marker on the trace maximum. The trace maximum corresponds to the signal.
10. Select the "New Marker" softkey at the "Measurement footer bar".
The R&S Spectrum Rider activates a delta marker and places it on the next trace maximum. This corresponds to the second harmonic.
The harmonic ratio is the vertical distance of the marker and the delta marker. The R&S Spectrum Rider displays this value in the "Measurement result view".

3.3.2 Using a power sensor



R&S Spectrum Rider option

R&S FPH-K9 (order number: 1321.0709.02) option is required to operate the R&S Spectrum Rider in the power sensor mode.

For highly accurate power measurements, you can connect one of the power sensors that are supported by the R&S Spectrum Rider.

For a list of R&S Spectrum Rider supported power sensors, see the datasheet of the R&S Spectrum Rider.

You can connect the list of supported power sensors to the USB port of the R&S Spectrum Rider. This connector allows you to control the power sensor and supplies it with power. For more information, see "[Mini USB](#)" on page 36.

3.3.2.1 Measuring the power with a power sensor

For more information about the characteristics of the supported power sensors, refers to their datasheet.

NOTICE

Risk of damaging the power sensor

Because of high input power,

- The continuous power applied to the power sensor's input must not exceed 400 mW (26 dBm).
- Use an attenuator for measurements on high-power transmitters.

However, brief power peaks $\leq 10 \mu\text{s}$ up to 1 W (30 dBm) are permissible.

Test setup

Connect the power sensor cable to the USB port of R&S Spectrum Rider. If the power sensor is having the binder connector (i.e R&S FSH-Z1, R&S FSH-Z18), the FSH-Z101 adaptor cable is needed.



- 1 = Supported power sensor (e.g R&S FSH-Z1, R&S NRP-Z11)
- 2 = Power sensor connector (DUT)
- 3 = USB binder adaptor (R&S FSH-Z101)
- 4 = USB port connector

Measuring the power

1. Press [MODE] key.
2. Select "Power Meter" softkey.
The R&S Spectrum Rider switches its operating mode.

If the R&S Spectrum Rider recognizes a power sensor, it sets up a connection via the USB interface. After a few seconds, the R&S Spectrum Rider shows the measured power.

If no power sensor has been connected or is not connected appropriately, the R&S Spectrum Rider shows nothing.

If there are communication problems between the R&S Spectrum Rider and the power sensor, the R&S Spectrum Rider displays an error message that indicates a possible cause.

For more information on the error messages, see [Table 7-1](#).

Zeroing the power sensor

To compensate internal offsets of the power meter, a **zeroing** for the power sensor is required before starting the measurement.

1. Select "Zero" softkey.
Do not to apply any signals to the power sensor while zeroing is active.
A popup message box is displayed to provide instructions during the zeroing of the power sensor.



Please Remove All Signals

From the sensor input and press Continue to start zeroing

2. Disconnect the power sensor from any signal sources.
3. Select "Continue" softkey to start zeroing.
The R&S Spectrum Rider starts the zeroing process.



Zeroing Power Sensor

Please wait while the system is zeroing the power sensor

4. Wait for the zeroing process to finish.
After zeroing, the R&S Spectrum Rider displays the message "Power sensor zero done" and again shows the power sensor softkey menu.



Power sensor zero done

5. Connect the DUT to the power sensor.
The R&S Spectrum Rider shows the measured power level in dBm. For more information on the power meter measurement, see [Chapter 7, "Power meter"](#), on page 216l.

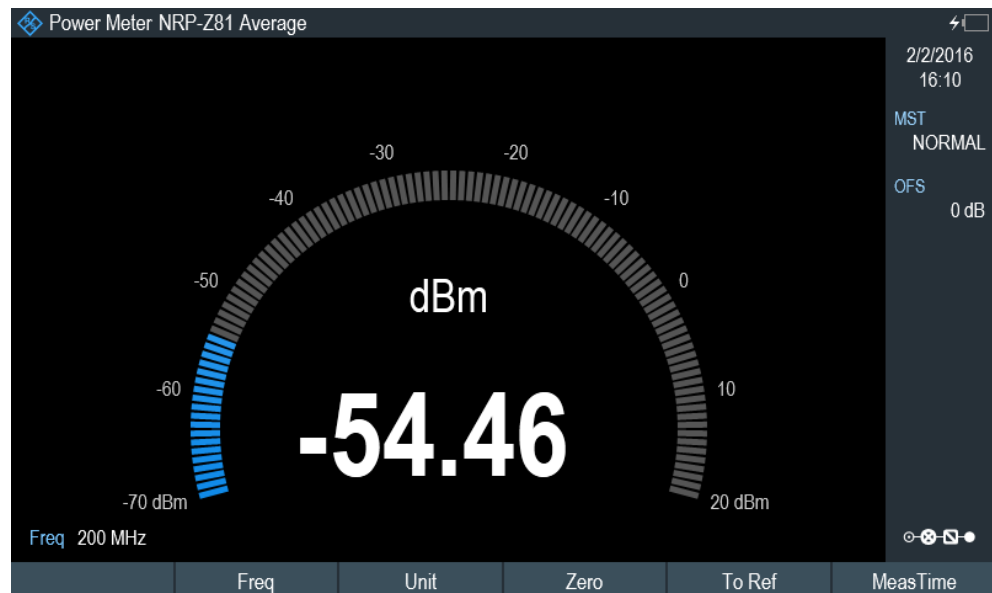

Set the frequency

To get the best results, enter the frequency of the signal under test.

1. Select "Freq" softkey.

The R&S Spectrum Rider opens an entry box to enter the frequency.

2. Enter the frequency of the signal.
3. Confirm the entry with one of the unit keys.

The R&S Spectrum Rider transfers the new frequency to the power sensor which then corrects the measured power readings.

3.3.2.2 Measuring power and return loss

With the directional power sensors R&S FSH-Z14 and R&S FSH-Z44, you can measure the power in both directions.

When you connect the directional power sensor between the source and the load, the R&S Spectrum Rider measures the power from the source to load (forward power) and from the load to source (reverse power).

The ratio between the forward and reverse power is a measure of the load matching. The R&S Spectrum Rider displays it as the return loss or standing wave ratio.

The power sensors for the R&S Spectrum Rider have an asymmetrical design. Therefore, they have to be inserted into the test setup in such a way that the "Forward" arrow on the sensor points toward the load (in the direction of the power flux).

When measuring high powers, pay strict attention to the following instructions to avoid personal injury and to prevent the power sensor from being destroyed.

CAUTION

Danger of skin burns and damage to the instrument

- Never exceed the permissible continuous power.
- See diagram on the rear of the sensor for the permissible continuous power.
- Turn off the RF power to connect the sensor.
- Screw the RF connectors tightly.

Test setup

Connect the power sensor cable to the USB port of R&S Spectrum Rider. If the power sensor is having the binder connector (i.e R&S FSH-Z14, R&S FSH-Z44), the FSH-Z144 adaptor cable is needed. Insert the directional power sensor between the source and the load.

The power sensors for the R&S Spectrum Rider have an asymmetrical design. Hence, you have to insert them into the test setup in such a way that the "Forward" arrow (1→2) on the sensor points toward the load (= in the direction of the power flux).

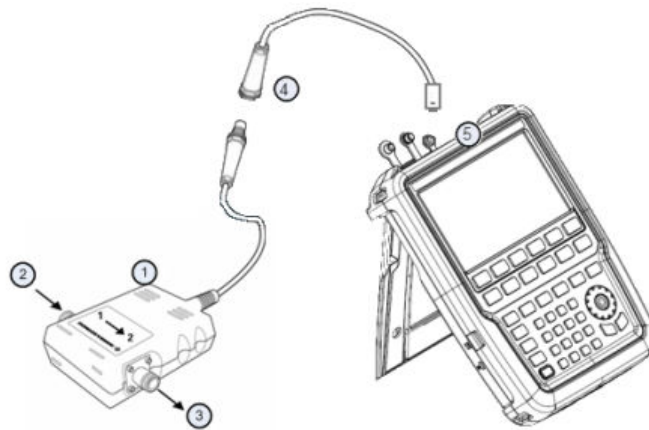

- 1 = Directional power sensor R&S FSH-Z14 or Z44
- 2 = Source
- 3 = Load
- 4 = USB binder adaptor (R&S FSH-Z144)
- 5 = USB port connector

Measuring the power

1. Press [MODE] key.
2. Select "Power Meter" softkey.

As soon as the R&S Spectrum Rider recognizes the power sensor, it displays the type of the directional power sensor that is connected in the "Title bar" (see [Figure 3-5](#)). After a few seconds, it also shows the forward power and return loss currently measured at the load.

Zeroing the power sensor

Before performing the power measurement, you should zeroing the power sensor.

After zeroing is done, the R&S Spectrum Rider displays the message "Power sensor zero done" and again shows the power sensor softkey menu.

- ▶ Connect the R&S FSH-Z14 or R&S FSH-Z44 between the source and the load. The R&S Spectrum Rider displays the measured forward power in dBm and the SWR of the load. For more information on using the directional power sensor, see [Chapter 7, "Power meter"](#), on page 216.

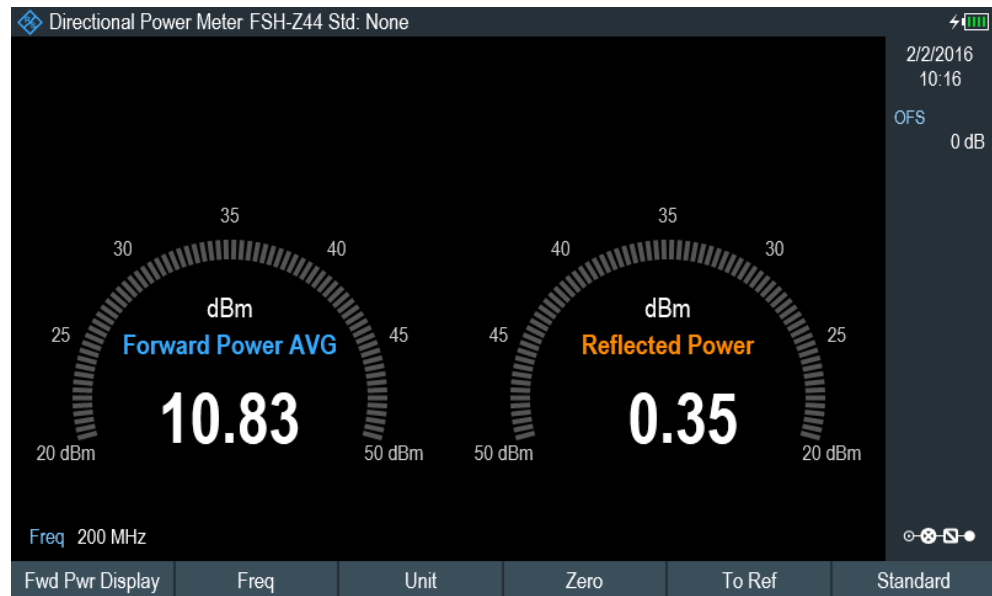

To get the best results, you should also define the frequency of the signal. For more information on the measuring power and return loss, see [Chapter 7, "Power meter"](#), on page 216.

3.3.3 Saving and recalling results and settings



Storage device

If both USB flash drive and micro-SD card are connected to the instrument, the USB flash drive takes precedent over SD card as a storage device.

If both storage devices are not connected, the internal memory of the instrument is used for storage.

The R&S Spectrum Rider can store measurement results and settings in the internal memory, removable micro-SD card or on a USB flash drive via the USB interface.

Results and settings are always stored together, allowing them to be interpreted in context when recalled. The R&S Spectrum Rider can store at least 100 data records in the internal memory which are differentiated by their names.

The R&S Spectrum Rider provides two [USB ports](#) and one [micro-SD card slot](#).

For more information on saving measurement results and settings, see [Chapter 4.8.1, "Saving datasets"](#), on page 106.

For more information on recalling measurement results and settings, see [Chapter 4.8.2, "Restoring datasets"](#), on page 109.

4 Instrument functions

This chapter provides information about the basic functionality and the user interface of the R&S Spectrum Rider.

- [Screen layout and elements](#).....90
- [Touchscreen gesture element](#).....92
- [Presetting the R&S Spectrum Rider](#).....98
- [Configuring measurements](#).....99
- [Working directory](#).....99
- [Taking screenshots](#).....100
- [Saving on events](#).....102
- [Managing datasets](#).....105
- [Updating the firmware](#).....112
- [Installing firmware options](#).....112
- [Device documentation](#).....112

4.1 Screen layout and elements

The following figure shows the screen layout in spectrum mode. It shows all elements that are the same for all operating modes of the R&S Spectrum Rider. Screen layouts that show specifics for each operating mode or measurement are provided in the corresponding sections of this manual.

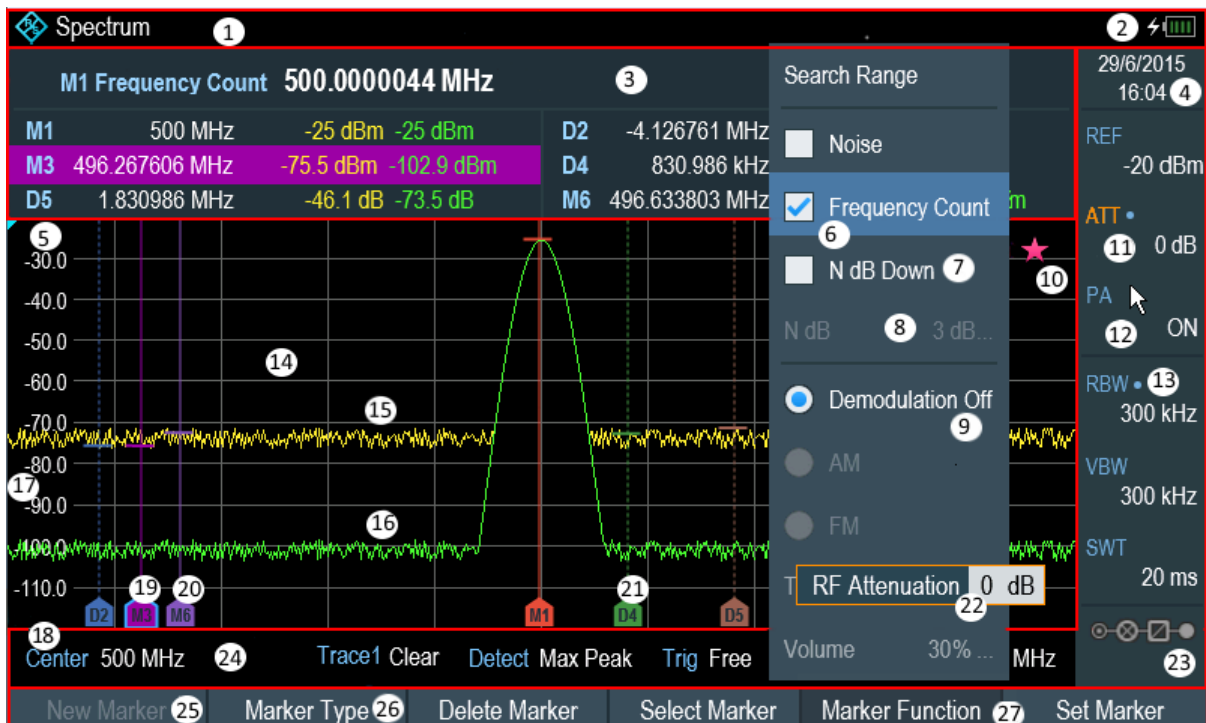

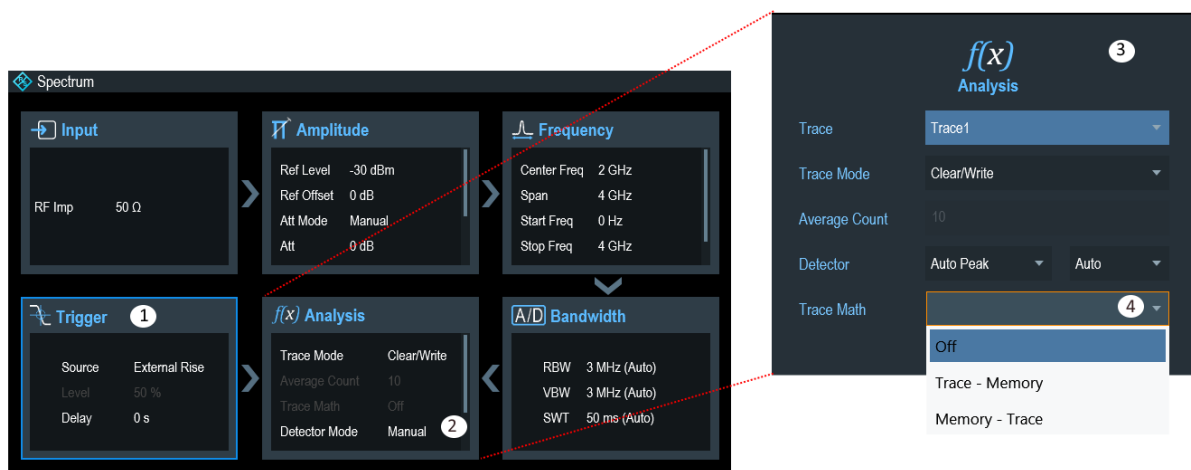

Figure 4-1: Screen layout and elements

- 1 = Title bar
- 2 = Battery status
- 3 = Measurement result view
- 4 = Date and time
- 5 = Reference position
- 6 = Currently selected menu item
- 7 = Available menu item
- 8 = Unavailable menu item
- 9 = Active menu item
- 10 = Invalid trace indicator and overload information
- 11 = Currently selected button
- 12 = Selectable toggle button
- 13 = Blue dot implies setting not coupled to another hardware setting
- 14 = Measurement trace window
- 15 = Trace 1
- 16 = Trace 2
- 17 = Horizontal axis labeling
- 18 = Vertical axis labeling
- 19 = Currently selected maker
- 20 = Marker
- 21 = Delta marker
- 22 = Entry box
- 23 = Configuration overview
- 24 = Parameter view
- 25 = Unavailable softkey function
- 26 = Available softkey function
- 27 = Currently selected softkey function

4.1.1 Configuration overview screen layout

The "Configuration Overview"  is an operation mode dependable function. When selected, it opens the "Config Overview" window which consists of six configuration blocks to configure the relevant parameters at each stage of the measurement. The button is located at the bottom right-hand corner of the display. The following illustrates the screen layout of the "Config Overview" window.



- 1 = Current selected block
- 2 = Scroll bar
- 3 = Associated block (see [Table 3-4](#))
- 4 = Drop down list

When a block is selected in the "Config Overview" window, a blue frame is displayed around the selected block. Alternatively, you can use the rotary knob to navigate the block for configuration.

The parameters displayed in the block are current parameters applied to the spectrum measurement. To configure these parameters, select the desired block for configuration. Alternatively, press the rotary knob to select the block for configuration.

Depending on the instrument operation mode, parameters or blocks that are not available in the operation mode are dimmed.

See details of each block configuration in "[Configuration overview](#)" on page 42 for spectrum analyzing mode.

4.2 Touchscreen gesture element

To enhance greater flexibility and user experience in the user interaction with R&S Spectrum Rider, special touchscreen gestures are introduced. The following illustrated the list of special gestures that R&S Spectrum Rider provides.

• Change center frequency	92
• Change reference level	93
• Change span	94
• Add marker	94
• Move marker	95
• Delete all markers	96
• Hide or unhide measurement result view display	96
• Preview screenshot	97
• Skip wizard measurement	97

4.2.1 Change center frequency

Swipe left or right horizontally in the trace window to adjust the center frequency of the spectrum measurement. Alternatively, select the "Center" softkey in the [Parameter view](#) to adjust the center frequency or press the [FREQ] key on the front panel to display the "Center Freq" softkey label for adjustment.

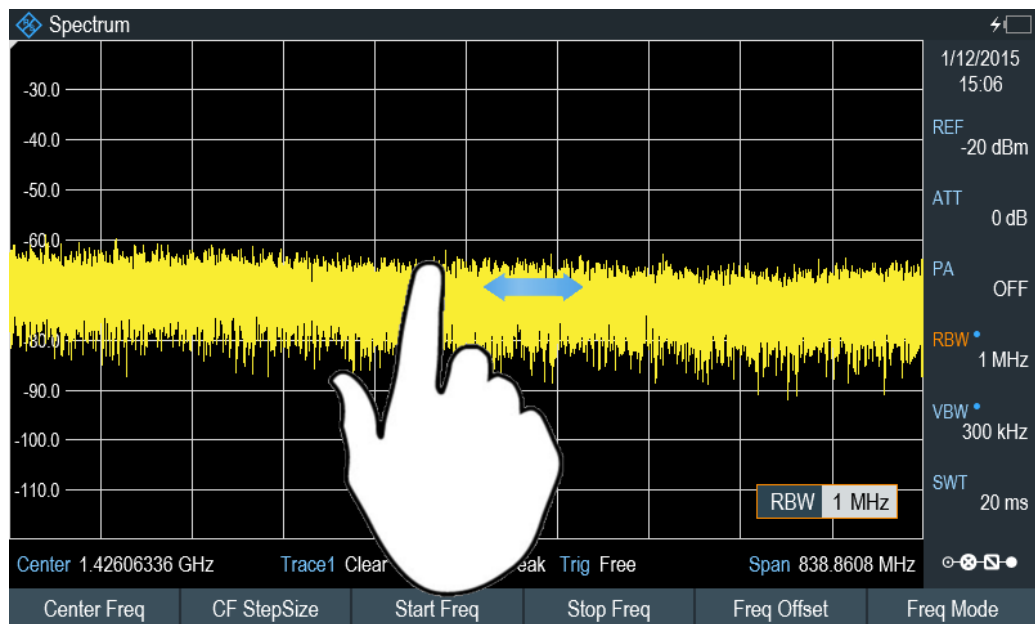

4.2.2 Change reference level

Swipe up or down vertically in the trace window to adjust the reference level of the spectrum measurement. Alternatively, select the "REF" softkey in the [Parameter view](#) to adjust the reference level or press the [AMPT] key on the front panel to display the "Ref Level" softkey label for adjustment.

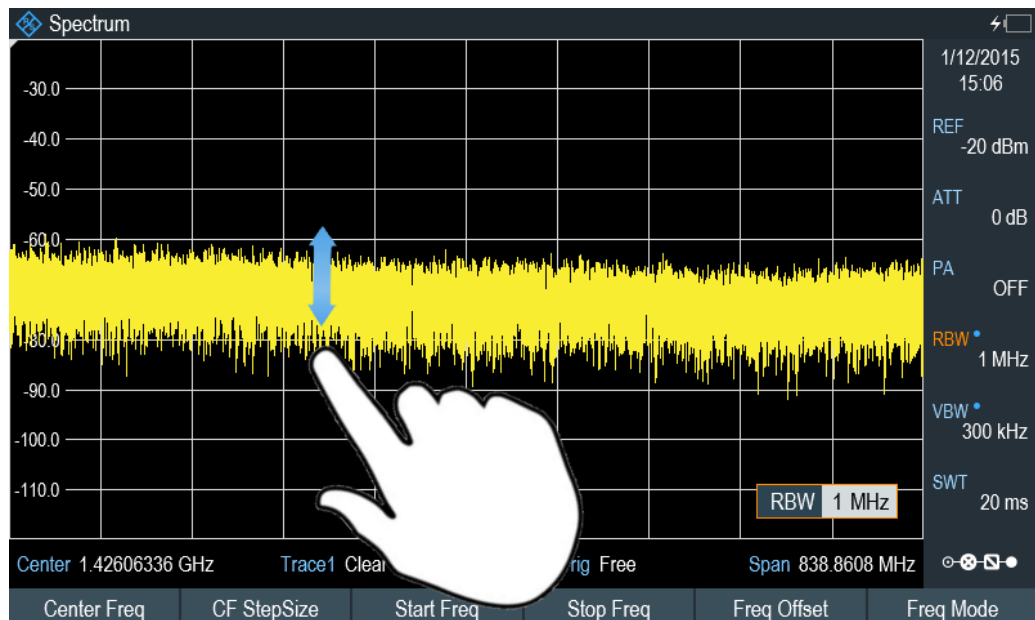

4.2.3 Change span

Pinch or stretch two fingers horizontally to adjust the span of the spectrum measurement. Alternatively, select the "Span" softkey in the [Parameter view](#) to adjust the span of the spectrum measurement or press the [SPAN] key on the front panel and select the "Manual Span" softkey label for adjustment.

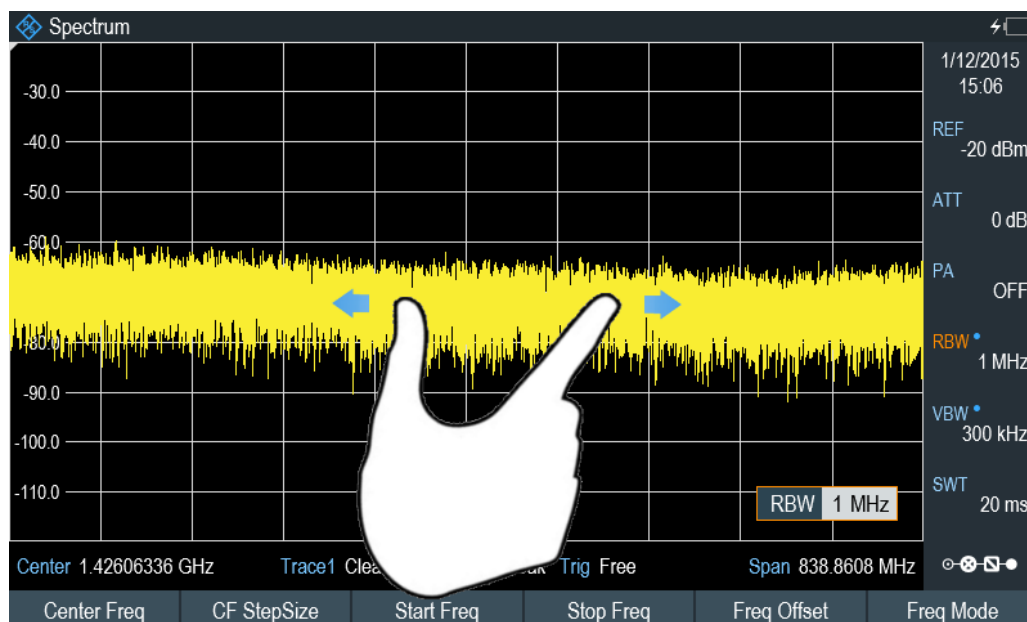

4.2.4 Add marker

Double tap in the trace window to create a marker on the spectrum measurement. The marker is placed on the trace where the double tap gesture is performed.

Alternatively, press the [MARKER] key on the front panel and select the "New Marker" softkey to create a marker on the spectrum measurement.

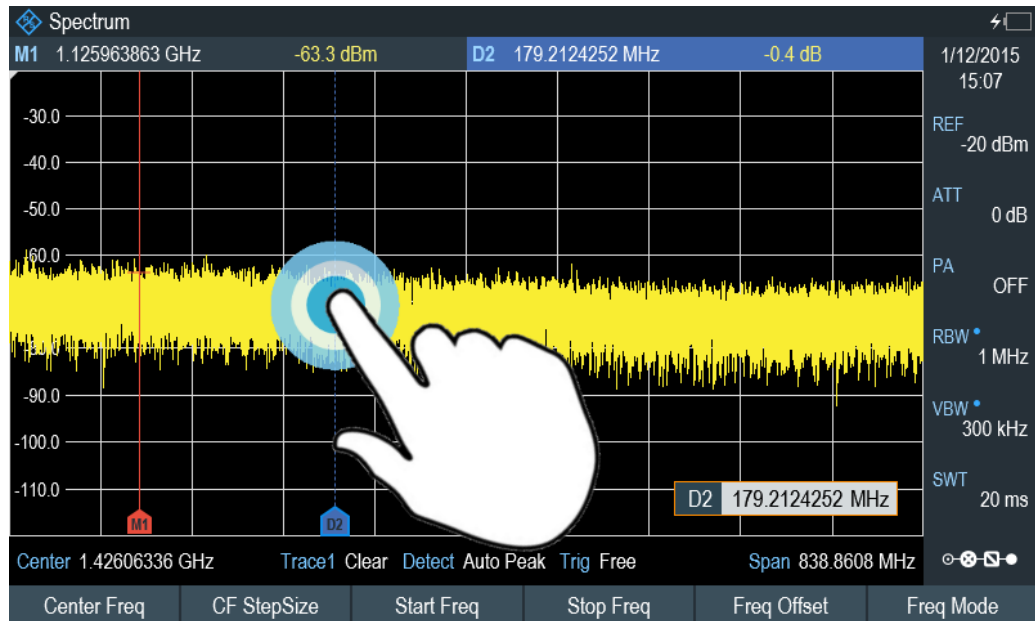

4.2.5 Move marker

Tab and drag on the marker icon to change the marker position in the trace window. Alternatively, select the marker label in the [Measurement result view](#) to adjust the marker position on the spectrum measurement or press the [MARKER] key on the front panel and select the "Select Marker" softkey for adjustment.

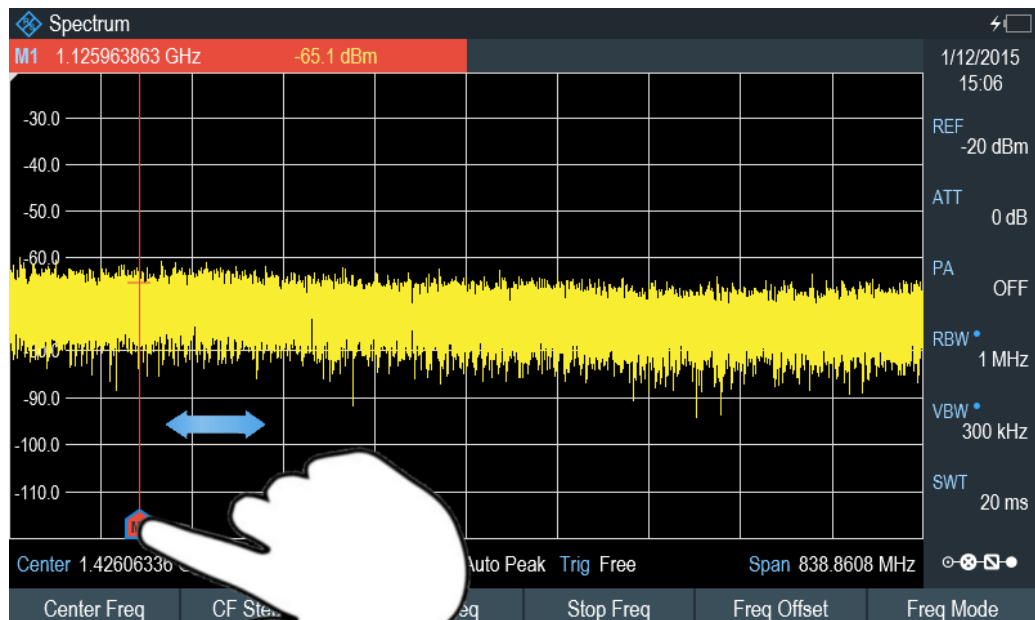

4.2.6 Delete all markers

Draw an "X" on the trace window to delete all markers from the spectrum measurement. Alternatively, press the [MARKER] key on the front panel and select the "Delete Marker" softkey to delete all markers from the spectrum measurement.

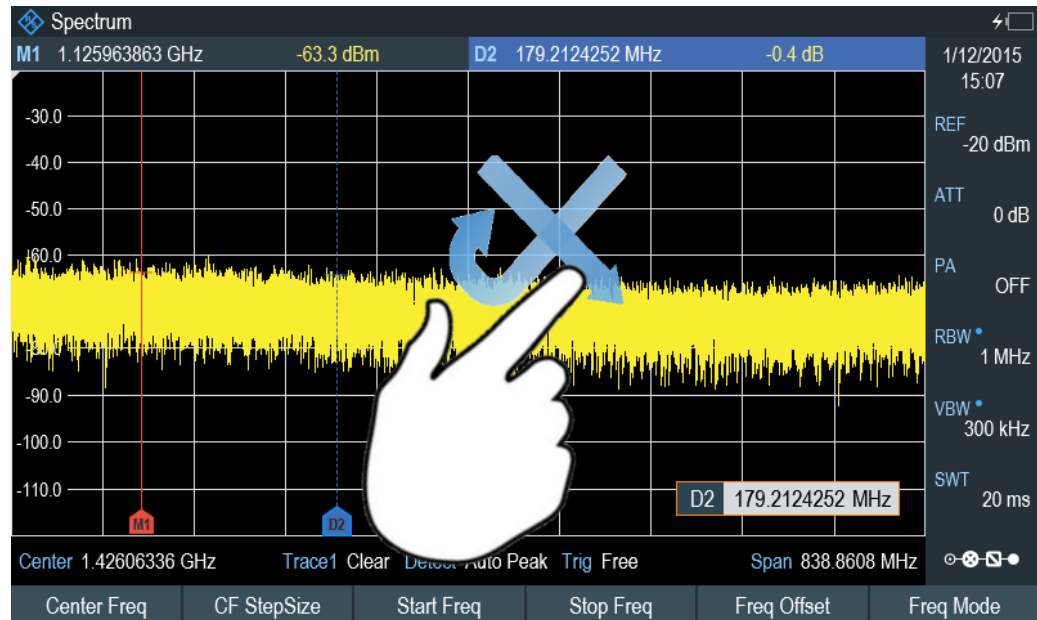

4.2.7 Hide or unhide measurement result view display

Swipe up or down vertically on the [Measurement Result View](#) window to hide or view the results display window.

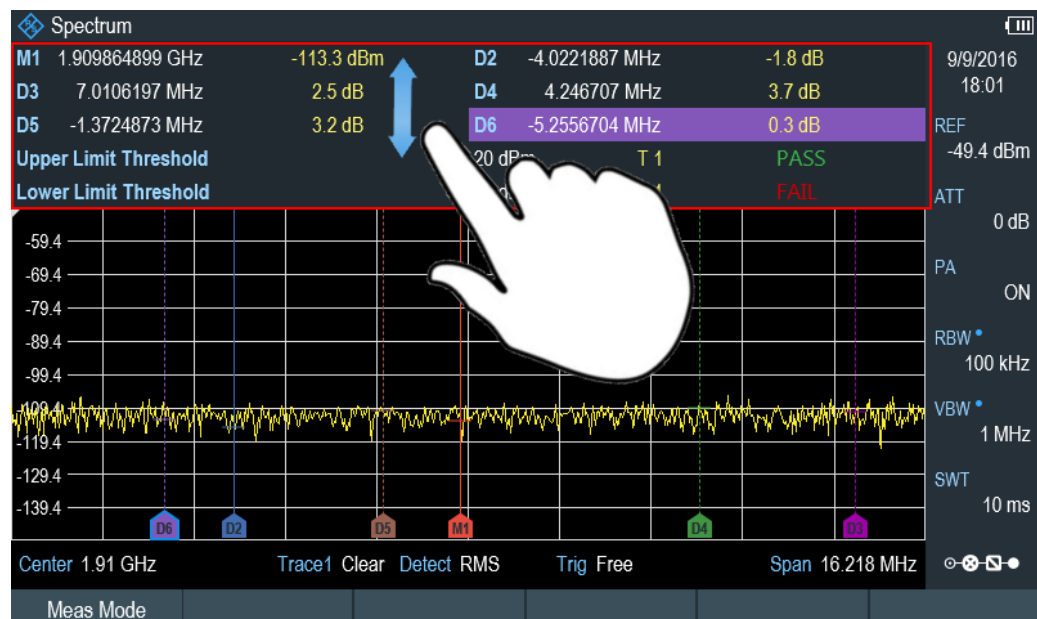

4.2.8 Preview screenshot

Swipe horizontally to the left or right direction in the trace window to preview the screenshot. Alternatively, select the "Prev" or "Next" softkey to preview the screenshot.

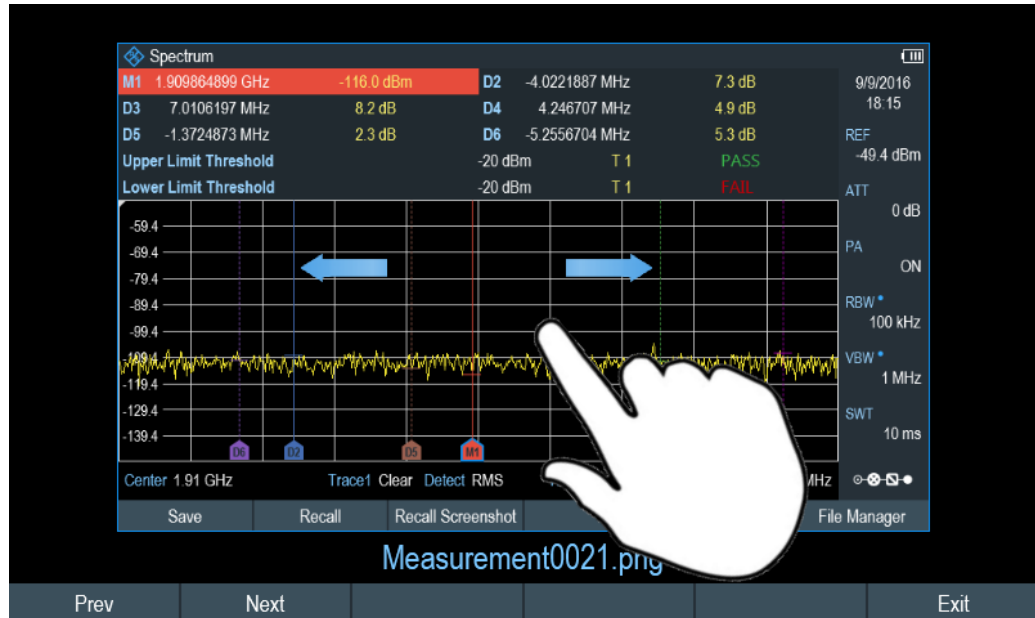

4.2.9 Skip wizard measurement

Swipe horizontally to the left direction to skip a wizard measurement. Alternatively, select the "Skip" softkey to skip the measurement.

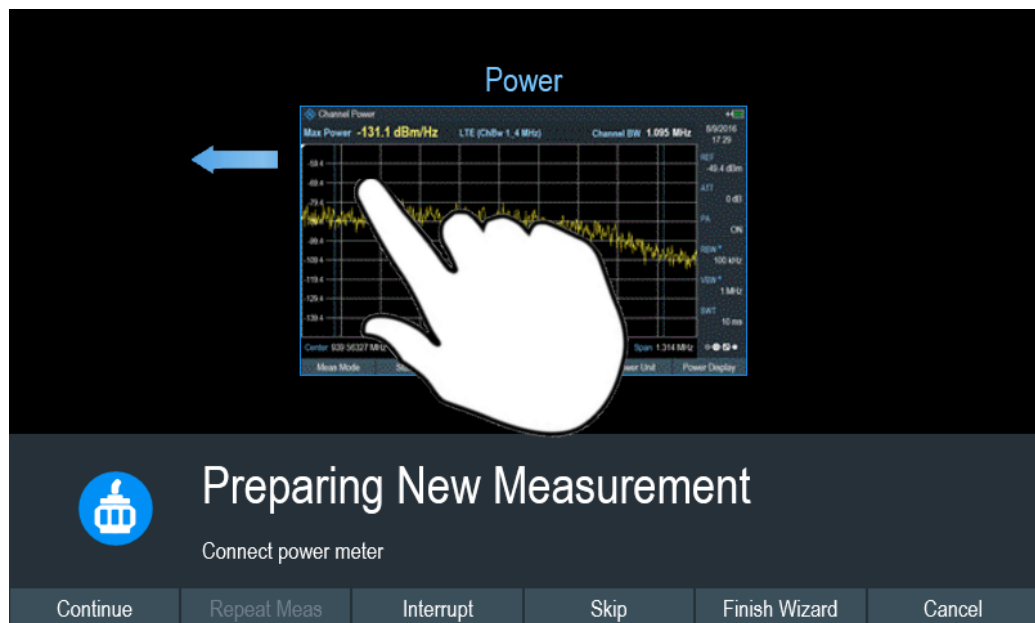

4.3 Presetting the R&S Spectrum Rider



Before you prepare a measurement, it is recommended to preset the R&S Spectrum Rider. During a preset, the R&S Spectrum Rider resets all settings to their default state. Restoring the default configuration has the advantage that old settings do not affect measurements.

The default setup is specific to the operating mode.

- ▶ Press [PRESET] key.
The R&S Spectrum Rider restores its default setup.

You can also define your own default settings via a dataset. This dataset is then loaded after pressing the [PRESET] key instead of the factory default.

1. Press [SETUP] key.
2. Select "User Preference" softkey.
3. In the "User Preferences" dialog box, select the "Preset Dataset" item.
The R&S Spectrum Rider displays the file manager dialog box to select the dataset that contains the settings you would like to have as the preset settings.

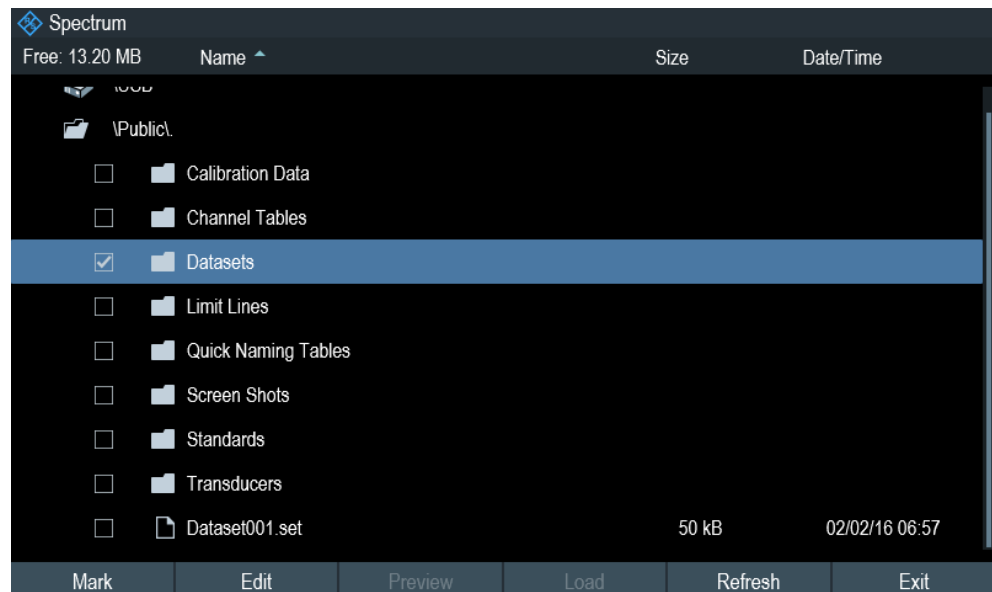

4. Select the dataset with the settings you want and press "Load" softkey.
5. In the "User Preferences" dialog box, select the "Preset Mode" item.
A drop-down menu opens to select the preset mode.
6. Select "User Defined" to load the dataset defined in the "Preset Dataset".
The R&S Spectrum Rider now loads the settings of the dataset after you press [PRESET.]

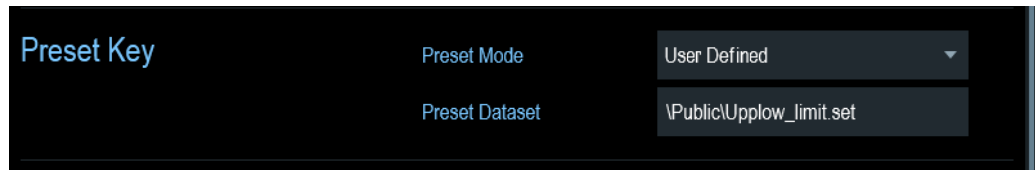

4.4 Configuring measurements



The [Measurement result view](#) dialog box provides an overview of the current configuration of the R&S Spectrum Rider. In addition, you can also change the configuration in this dialog box.

1. Press [SETUP] key.
2. Select "Config Overview" softkey.
3. Select one of the dialog boxes and change the settings as you like.

Note that the contents of the "Config Overview" dialog box are customized for each operating mode of the R&S Spectrum Rider. Therefore, the order and number of displayed settings are different in each mode.

4.5 Working directory

Using the "Working Directory", you can customize the folder directory to save the screenshots and datasets captured during measurement.

1. Press [SETUP] key.
2. Select "User Preference" softkey.
3. In the "User Preferences" dialog box, select the "Using working directory" item.
4. Select "On" to activate the customize folder directory or "Off" to use the default storage device in the R&S Spectrum Rider. See ["Data storage devices"](#) on page 107.
5. Define the folder name in the "Working directory" item.

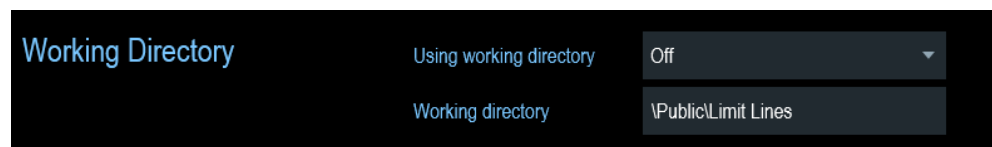

4.6 Taking screenshots



You can take and store a screenshot of the current screen anytime with the screenshot key.

- ▶ Press the screenshot key.
The R&S Spectrum Rider takes the screenshot.

If available, the R&S Spectrum Rider stores the screenshot on an external storage device (USB flash drive or micro-SD card). If both are connected, the R&S Spectrum Rider uses the USB flash drive.

If no external device is available, the R&S Spectrum Rider stores the screenshot in its internal memory until the internal memory is full. In that case, you can transfer the screenshots with the R&S InstrumentView software to your computer.



Saving screenshot and dataset at the same time

Depending on the "Capture" settings configured in the "User Preference" menu, using the screenshot key also saves a dataset in addition to the screenshot.

For more information, see [Chapter 4.8, "Managing datasets"](#), on page 105.

Screenshot filename and file format

All screenshots get a default filename "Screenshot#####". The files also get numbers (#####) in an ascending order, beginning with 0000. You can select a default filename and a starting number in the "User Preference" menu.

The file format of screenshots is either *.png or *.jpg, depending on your configuration in the "User Preference" menu.

1. Press [SETUP] key.
2. Select "User Preference" softkey.
3. Select the "Default Filename" and "Filename Counter Starts At" items and assign a filename and number as you wish.
4. Select the "Capture Screen Format" items to select the screenshot file format.

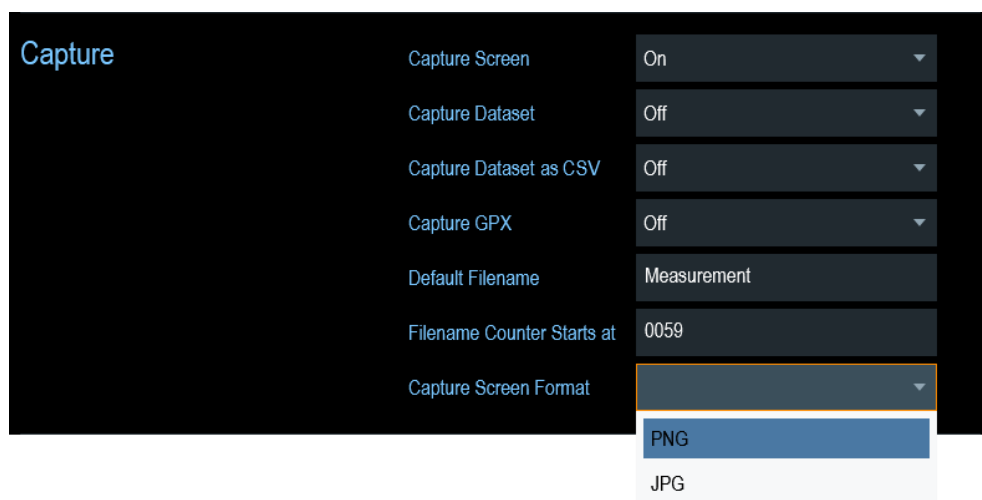

Previewing screenshots

The R&S Spectrum Rider provides functionality to preview screenshot.



Special touchscreen gesture

You can swipe horizontally to the left or right direction to preview the screenshot. See [Chapter 4.2.8, "Preview screenshot"](#), on page 97.

1. Press [SAVE/RECALL] key.
2. Select "File Manager" softkey.
The R&S Spectrum Rider opens the file manager to select a screenshot for the preview.
3. Select the screenshot for preview.
4. Select "Preview" softkey to preview the screenshot.
5. Select the "Prev" or "Next" softkey to preview the screenshots available in the selected folder.
The filename of the previewed screenshot is displayed below the screenshot. See [Figure 4-2](#) and [Chapter 4.8.2.1, "Previewing a dataset"](#), on page 110.
6. Select "Exit" softkey to return to the file manager.

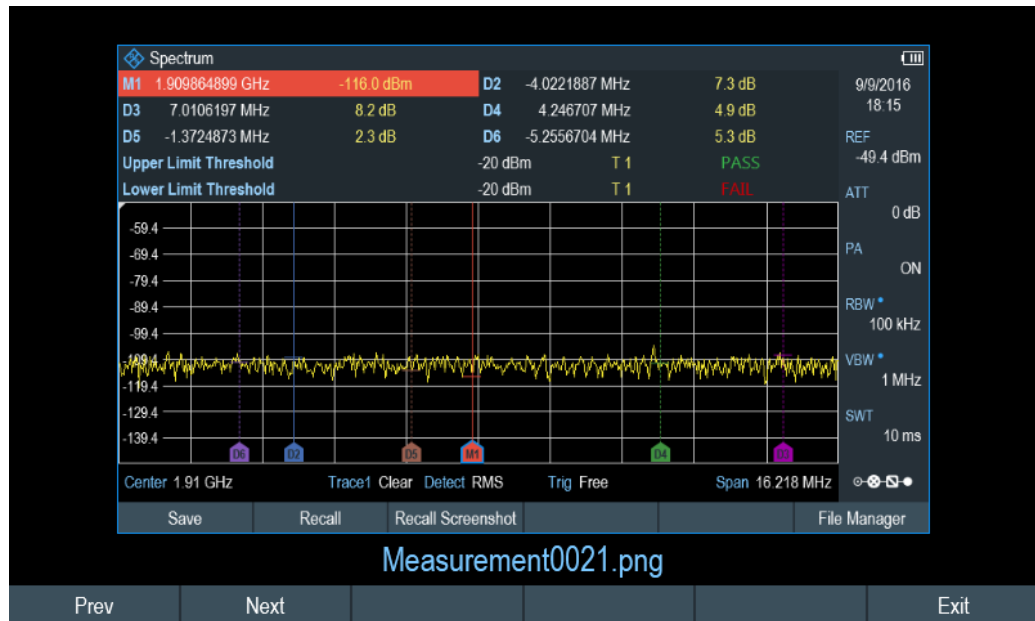

Figure 4-2: Preview screenshot

4.7 Saving on events



"Save On Event" is not available in the power meter and modulation analysis measurement mode.

The R&S Spectrum Rider provides functionality that automatically saves measurement information if a certain situation or event occurs.

1. Press [SETUP] key.
2. Select "User Preference" softkey.
3. Select the "Save On Event" menu item.
A drop-down menu to disable or enable the "Save On Event" opens.

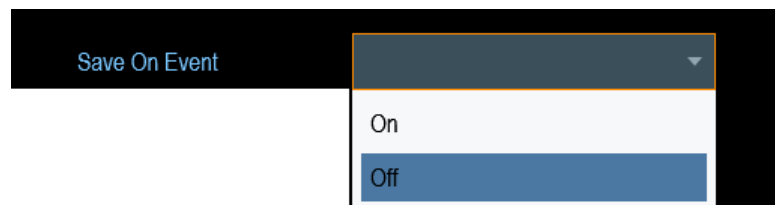

4. Select "On" to enable the "Save On Event" menu item.
The R&S Spectrum Rider turns on automatic event recognition. You can select one of several events that trigger the storage of measurement data. See ["Event types"](#) on page 103.

Data types

You can select several data types to save when an event occurs.

- A screenshot of the sweep that contains the event (.png or .jpg file)
- A dataset of the sweep that contains the event (.set file)
- A dataset of the sweep that contains the event saved as CSV format (.csv file)
- The GPS coordinates of the location where the event happens (.gpx file).

1. Press [SETUP] key.
2. Select "User Preference" softkey.
3. Select the "Capture Screen", "Capture Dataset", "Capture Dataset as CSV" or "Capture GPX" menu item and turn it on or off.

If the setting is turns "On", the corresponding information is included in the saved data.

See [Chapter 4.6, "Taking screenshots"](#), on page 100.



Timing of the data capture

The R&S Spectrum Rider evaluates the measured data after a sweep is done and thus detects and saves an event only after a sweep has been completed.

Event types

To use the "Save on Event" functionality, you have to select an event type that triggers the capture of the selected data. The R&S Spectrum Rider supports several event types.



Single sweeps and sweep time

It is not possible to save measurement data in single sweep mode because the R&S Spectrum Rider only performs one sweep and then stops.

The time interval must be longer than the sweep time. If the time interval is shorter, the R&S Spectrum Rider is not able to save data because a sweep has to be complete before the R&S Spectrum Rider is able to save the data.

1. Press [SETUP] key.
2. Select "User Preference" softkey.
3. Select the "Event Source" menu item.
A drop-down menu to select the event trigger source opens.

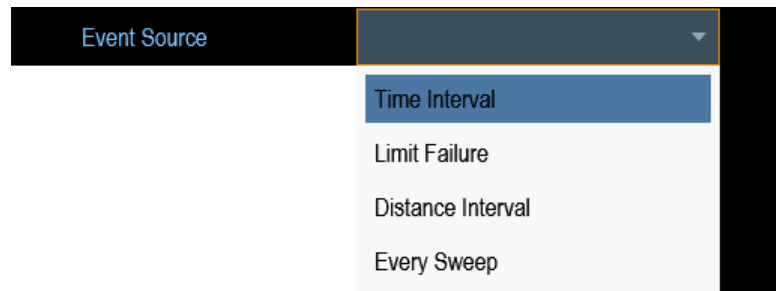

a) "Time interval"

You can define the duration of the time interval via the "Time Interval" menu item.

b) "Limit failure"

Saves measurement data if a limit line is violated.

The R&S Spectrum Rider provides different modes for handling limit check failures. You can select one via the "Limits Save Mode".

- "Start On Failure": starts to save measurement data if a limit line is violated.
- "Stop On Failure": stops to save measurement data if a limit line is violated.
- "Save Only Failure": saves only the sweeps that actually fail a limit check.

c) "Distance interval"

Saves measurement data after you have covered a certain distance.

You can define the distance that is covered before the measurement data is saved via the "Distance Interval" menu item.

d) "Every sweep"

Saves the data of all measurement sweeps that are performed.

Storage device



To use the "Save on Event" functionality, you need either an SD card or a USB stick to store the data. The internal memory is probably not sufficient.

1. Press [SETUP] key.
2. Select "User Preference" softkey.
3. Select the "Recording Storage" menu item.
A drop-down menu to select the recording storage media opens.

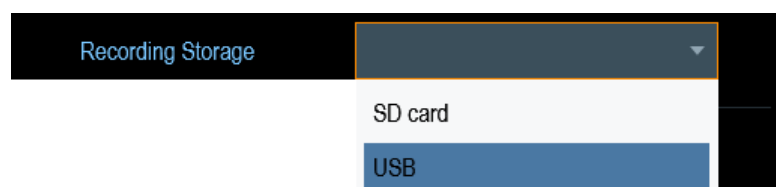

4. Select the desired storage media.

4.8 Managing datasets



The R&S Spectrum Rider provides functionality to manage (e.g. save, restore, delete and export) datasets available in its internal memory or an external storage device.

Datasets

The R&S Spectrum Rider supports various types of datasets. The instructions below primarily describe the management of datasets that you create on the R&S Spectrum Rider during measurements, for example measurement results and configurations. Note that these datasets have the file extension `.set`.

Datasets with the file extension `.set` are an image of measurement results and configurations. Thus, you can subsequently reproduce the context of the measurement.

Using the R&S InstrumentView software, you can use the datasets for documentation purposes or post-processed it for a more detailed analysis later on. Note that datasets also contain calibration data if calibration has been performed.

Templates



The R&S Spectrum Rider also supports various other types of datasets or templates. Such templates mainly contain additional requirements for a particular measurement, like limit lines or channel tables.

Creating and editing of these templates are only possible with the functionality provided by the R&S InstrumentView software package. Note that the file extension depends on the application of the template (for example, a template containing a channel table has the extension `.chntab`).

For more information on working with templates and datasets, refer to the documentation of the R&S InstrumentView software package.

Data synchronization

The R&S InstrumentView features data synchronization that matches the data available between the R&S Spectrum Rider and the PC.

1. Select "File Transfer" from the "Instrument" menu.
The software opens the "File Transfer" dialog box.
2. Select the "Template & Result"  synchronization button to process data synchronization between the computer and instrument.
This data synchronization updates all files that have been created or edited with the R&S InstrumentView software package to the instrument and vice versa. (Note that template can only be created and edited in the PC, see ["Templates"](#) on page 105).
3. Alternatively, data can be transferred in a single direction using the  direction button between the PC and instrument and vice versa.

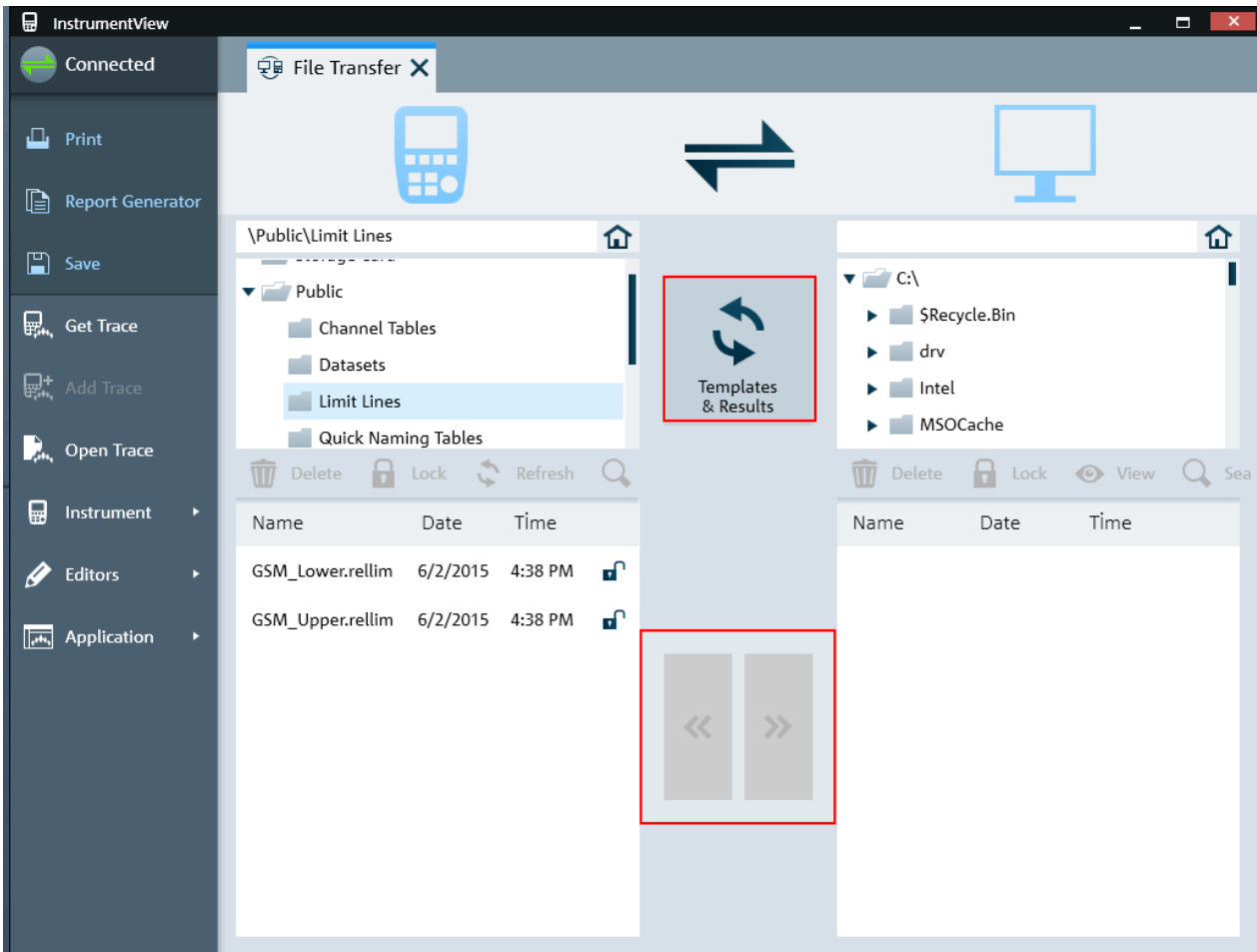

- [Saving datasets](#).....106
- [Restoring datasets](#)..... 109
- [Deleting datasets](#)..... 111
- [Export datasets](#)..... 112

4.8.1 Saving datasets

The R&S Spectrum Rider allows you to save the data that is analyzed at any time.

1. Press [SAVE/RECALL] key.
2. Select "Save" softkey.
The R&S Spectrum Rider opens the "Save Dataset" dialog box.

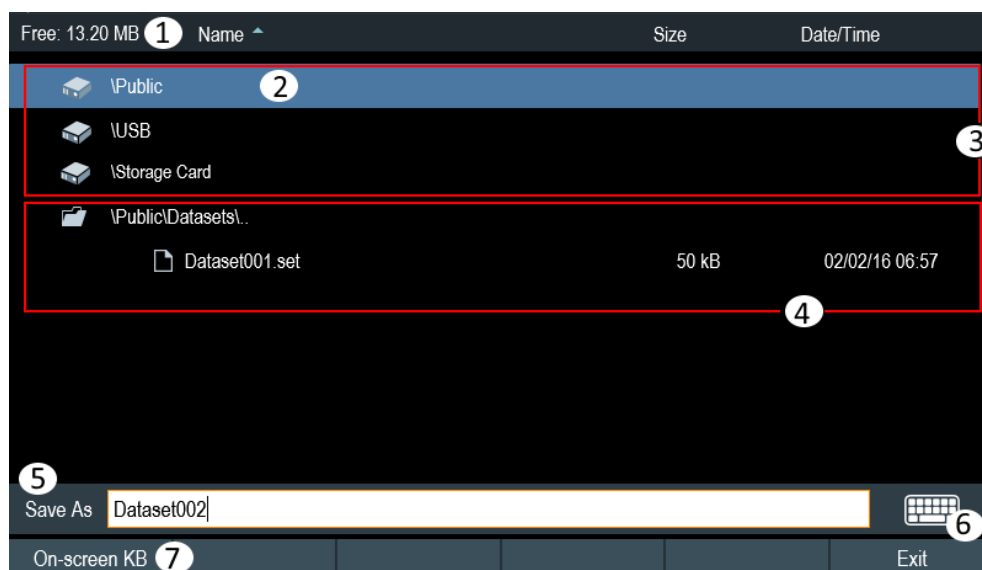

Figure 4-3: Save Dataset dialog box

- 1 = Remaining memory on selected data storage device
- 2 = Currently selected data storage
- 3 = Available data storage
- 4 = Currently folder structure of the selected data storage
- 5 = Dataset name input field
- 6 = [On-screen keyboard](#) icon
- 7 = File manager softkey menu

Data storage devices



Storage device

If both USB flash drive and micro-SD card are connected to the instrument, the USB flash drive takes precedent over SD card as a storage device.

If both storage devices are not connected, the internal memory of the instrument is used for storage.

The folder structure shows all the available data storage devices. Possible storage devices are the internal memory of the R&S Spectrum Rider, micro-SD card or USB flash drive.

The default storage device depends on which devices are connected to the R&S Spectrum Rider. See "[Storage device](#)" on page 107.

The internal memory provides approximately 20 MB of data, therefore the number of datasets you save on the R&S Spectrum Rider is limited. Each dataset needs about 100 kB of memory, but this value can vary.

If you are using an external storage device, the number of datasets you can save is limited only by the size of the storage device.

R&S Spectrum Rider shows the remaining memory on the storage device in the dialog box.

1. Select the storage device you want to save the data.
2. Select the folder you want to save the data.
3. Enter a filename in the corresponding input field.
The default filename for datasets is `Dataset###.set` with a new number in ascending order for each new dataset. The file extension for datasets is `.set`.
If you enter another name, the R&S Spectrum Rider uses that name and assigns a new number to the filename if you save the data set the next time. This function allows you to assign consecutive dataset filename without entering a new name every time you want to save a dataset.
You can define the dataset filename at the "User Preference" dialog box. Select the "Default Dataset Name" and enter the filename in the entry box.
4. Press the rotary knob to confirm the entry.
The R&S Spectrum Rider saves the dataset.

4.8.1.1 Alternative ways to save datasets

Using the screenshot key , the R&S Spectrum Rider provides an alternative and more convenient way to save dataset.

1. Press [SETUP] key.
2. Select "User Preference" softkey.
3. Configure the "Default Filename", "Filename Counter Starts at" and "Capture Screen Format" menu items.
The screenshot key  saves a screenshot of the display and the selected data of the current measurement based on the filename syntax defined in the "Default File-name", "Filename Counter Starts at" and "Capture Screen Format" menu items.

Saving events

You can configure the R&S Spectrum Rider to save a dataset when an event occurs.

1. Press [SETUP] key.
2. Select "User Preference" softkey.
3. Select the "Capture Dataset" menu item and set it "On".
If the "Capture Dataset" menu item is set "On", the R&S Spectrum Rider saves a dataset of the current measurement if an event occurs.
For more information on events, see [Chapter 4.7, "Saving on events"](#), on page 102.

4.8.1.2 Renaming filename

If necessary, you can rename files or file directories directly on the R&S Spectrum Rider.

1. Press [SAVE/RECALL] key.
2. Select "File Manager" softkey.
The R&S Spectrum Rider opens the file manager.
3. Select the files or file directories in the file manager.
Alternatively, press the "Mark" softkey to select the desired files or files directories.
4. Select "Edit" softkey.
The R&S Spectrum Rider displays a submenu for selection.
5. Select "Rename" menu item to rename the files or file directories.
The R&S Spectrum Rider opens an input field to change the name of the selected files or file directories.

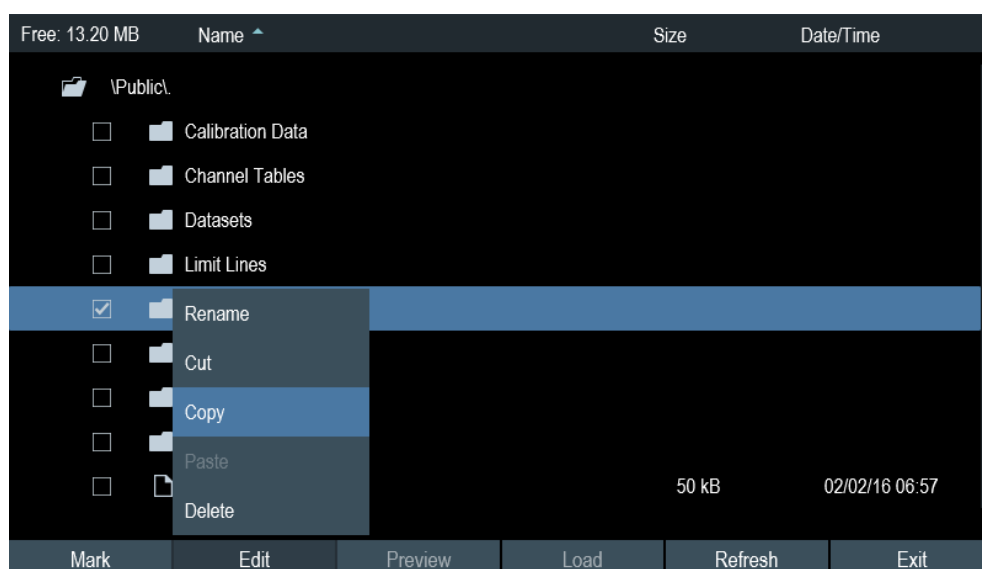

4.8.2 Restoring datasets

You can preview and load previous saved measurement results with the recall function of the R&S Spectrum Rider. This function also provides easy access to previous measurement settings so that you do not have to set up the R&S Spectrum Rider again.

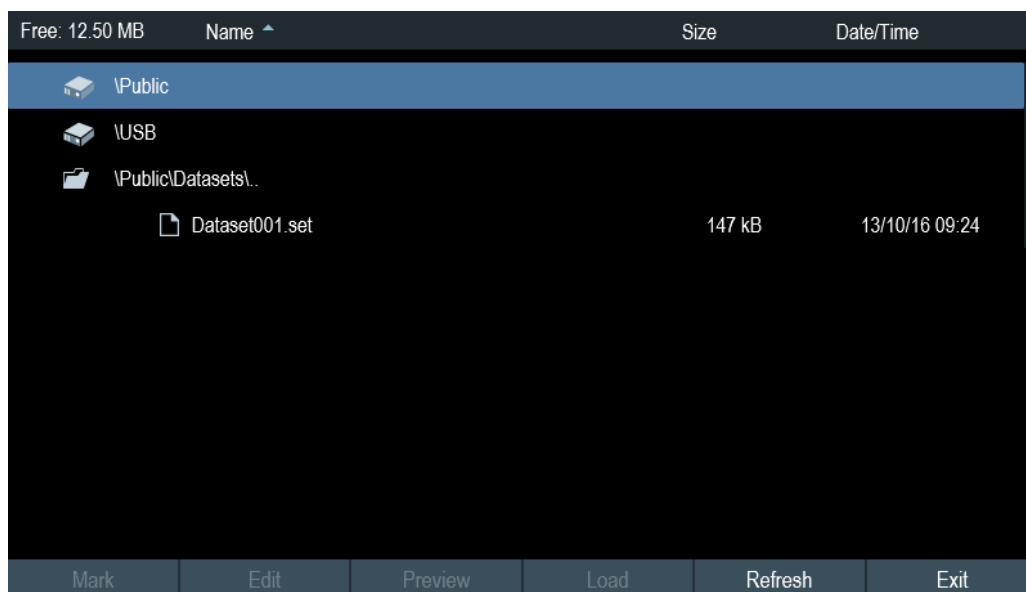

1. Press [SAVE/RECALL] key.
2. Select "Recall" softkey.
The R&S Spectrum Rider opens the "Recall Dataset" dialog box.
3. Select the storage device and file directory you want to load the dataset.
The R&S Spectrum Rider restores the configuration that the dataset contains.

By default, the most recently saved dataset is highlighted. If you need another dataset, navigate to the file directory or storage device that contains the dataset you need.

4.8.2.1 Previewing a dataset

The R&S Spectrum Rider provides the function to preview datasets. The preview function allows you to take a quick look at the screenshot and its corresponding measurement settings. During preview, the R&S Spectrum Rider does not yet activate the measurement settings of that dataset.

1. Press [SAVE/RECALL] key.
2. Select "File Manager" softkey.
3. Browse through the available datasets and select the desired dataset.
4. Select "Preview" softkey.
The R&S Spectrum Rider shows a preview of the measurement results and the measurement settings contained in the selected dataset.
5. Select the "Prev" or "Next" softkey to preview the datasets available in the selected folder.
The filename of the previewed dataset is displayed at the bottom of the screen layout. See [Figure 4-4](#).

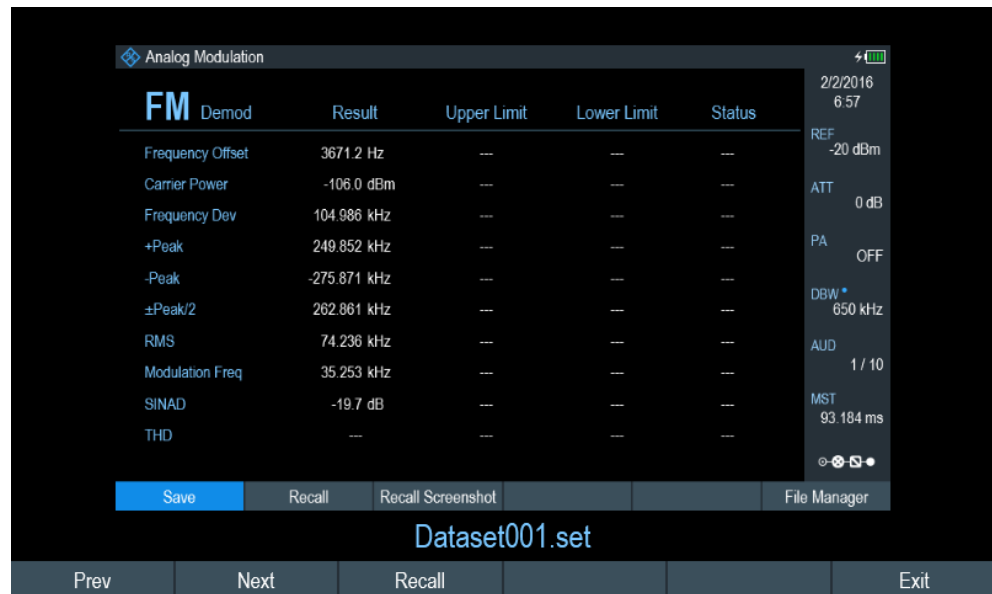

Figure 4-4: Preview dataset

6. Select "Recall" softkey to load the dataset
Alternatively, select the "Exit" softkey to return to the file manager.

4.8.2.2 Loading a dataset

If you find a dataset whose settings you need for your current measurement task, you can load it.

- ▶ Select "Load" softkey.
The R&S Spectrum Rider loads the dataset and adjusts its measurement settings according to the dataset.
See also [Chapter 4.8.2.1, "Previewing a dataset"](#), on page 110.

4.8.3 Deleting datasets

If you have to delete a dataset, you can do so with the file manager.

1. Press [SAVE/RECALL] key.
2. Select "File Manager" softkey.
The R&S Spectrum Rider opens the file manager.
3. Select the desired files or file directories in the file manager.
Alternatively, press the "Mark" softkey to select the desired files or files directories.
4. Select "Edit" softkey.
The R&S Spectrum Rider displays a submenu for selection.
5. Select the "Delete" menu item to delete the files or file directories.

Before deleting, the R&S Spectrum Rider shows a warning message that you need to confirm.

6. Select "Yes" to delete the selected files or file directories.
The R&S Spectrum Rider deletes the selected files or file directories from its memory.

4.8.4 Export datasets

You can export a dataset to CSV format. It works in all modes except spectrogram and spectrogram playback.

1. Press [SAVE/RECALL] key.
2. Select "Export CSV" softkey to save dataset as CSV format.
The R&S Spectrum Rider opens the "Export Data" dialog box.
3. Select the desired file storage location to save the dataset in CSV format.
See also [Chapter 4.8.1, "Saving datasets"](#), on page 106.

4.9 Updating the firmware

You can download new firmware versions from the R&S Spectrum Rider website.

<http://www.rohde-schwarz.com/product/fph.html>

The website also provides release notes for each new firmware version. The release notes include instructions on how to perform a firmware update.

4.10 Installing firmware options

You can equip the R&S Spectrum Rider with several firmware options to enable additional operating modes or special measurements.

For more information, see [Chapter 3.2.9, "Managing options"](#), on page 49.

4.11 Device documentation

You can export the R&S Spectrum Rider OSA document from the instrument.

1. Press [SETUP] key.
2. Select "User Preference" softkey.
3. In the "User Preferences" dialog box, select the "Export" menu item.

The R&S Spectrum Rider displays the file manager window to export the documentation.

4. Select the desired file location in the file manager window to export the documentation.



5. Select "Export" to export documentation from the instrument.
The R&S Spectrum Rider export the documentation into the selected file location.

5 Working with the measurement wizard



When testing antennas and making measurement which involves complex signals, it is often necessary to perform a sequence of standardized and recurring measurements, often in an environment that is not easily accessible. To make sure that measurements are performed as required and to avoid a constant adjustment of parameters, the R&S Spectrum Rider features a measurement wizard.

The measurement wizard allows you to combine several individual measurement configurations to a sequence of measurements (or measurement set). As all relevant parameters have been set before the actual measurement and cannot be changed once the measurement procedure has begun, the wizard is a good way to avoid mistakes and save time when setting up measurements. You can use the wizard for measurements in all the operating modes.

Note that it is necessary to install and use the R&S InstrumentView software package if you want to configure the measurement steps and parameters in the measurement wizard.

For details on the individual measurements you can perform with the wizard, refer to the corresponding chapters.

- [Chapter 6, "Spectrum analyzer mode"](#), on page 123
- [Chapter 7, "Power meter"](#), on page 216
- [Chapter 8, "Using the internal power meter"](#), on page 226
- [Chapter 9, "Performing pulse power measurements"](#), on page 229
- [Chapter 10, "Modulation analysis"](#), on page 237
- [Chapter 12, "Receiver mode"](#), on page 283
- [Chapter 11, "Interference analyzer"](#), on page 256

You can use the wizard for measurements in all operating modes.

The following chapters illustrates the wizard measurements used in the "Spectrum Analyzer" mode.

Note: It is necessary to install and use the R&S InstrumentView software package if you want to access the measurement wizard.

5.1 Performing and configuring measurements

Before you can use the measurement wizard, you have to define a measurement set using the "Wizard Set Editor" in the R&S InstrumentView software package.

The R&S InstrumentView software package is delivered with the R&S Spectrum Rider. The latest version is also available for download on the R&S Spectrum Rider website at <http://www.rohde-schwarz.com/product/fph.html>.

After creating the measurement wizard set using the R&S InstrumentView, transfer the file to the R&S Spectrum Rider.

For more information of the "Wizard Set Editor", see the R&S InstrumentView manual.

Load the measurement wizard

Now that the measurement set is available on the R&S Spectrum Rider, you can perform the measurement wizard.

1. Press [Wizard] key.
The R&S Spectrum Rider opens the wizard dialog box. See [Figure 5-1](#).

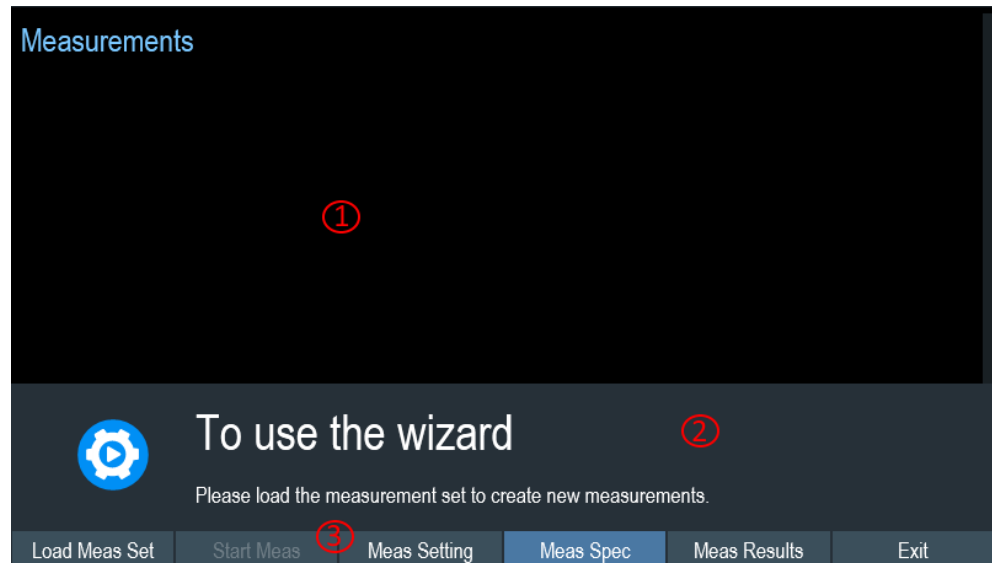

Figure 5-1: Wizard dialog box

- 1 = Measurement wizard dialog box
- 2 = Measurement wizard message box
- 3 = [Softkeys](#) menu of measurement wizard application

2. Select "Load Meas Set" softkey.
The R&S Spectrum Rider opens the file manager to select the measurement wizard set.
3. Select the desired measurement wizard set from the file manager.
4. Select "Load" softkey to confirm the selection.
The R&S Spectrum Rider loads the measurement wizard set.

Measurement setting

The parameters highlighted in the measurement setting dialog are configurable during the start of the measurement. See [Figure 5-2](#).

1. Select "Meas Setting" softkey.
The R&S Spectrum Rider opens the "Meas Setting" dialog box.
2. Select the desired menu item in the "Meas Setting" dialog box.
Note that some of the parameters are read-only information. See [Table 5-1](#).

The screenshot shows a 'Measurement setting dialog' with two main sections: 'General' and 'Site'.
General section:
 - 'Measurement Definition': A text field.
 - 'User': A text field.
 - 'No. of Steps to Perform': A numeric field with the value '0'.
 - 'Description': A text field.
Site section:
 - 'Site Name': A text field.
 - 'Comments': A text area.
 - 'GPS Position': A status indicator showing 'not connected'.

Figure 5-2: Measurement setting dialog

Table 5-1: Measurement setting parameters

Measurement parameters		Descriptions
"General"	User	Name of the person that performs the measurement.
	Measurement Definition	Name of the measurement wizard set. This field is a read-only field that shows the measurement name as defined in the R&S InstrumentView software package.
	Number of Steps to Perform	Number of individual measurements in the measurement sequence as defined with the R&S InstrumentView software package. The field allows you to reduce the number of individual measurements and perform only those measurements that are necessary. If you reduce the number of measurements, the R&S Spectrum Rider omits the last measurement in the sequence. You can edit this field only if you turned on the "Allow Variable Number of Sequence Steps" in the "Wizard Set Editor" of the R&S InstrumentView software.
	Descriptions	Short description of the measurement task. This field is a read-only field that shows the description as defined with the R&S InstrumentView software.
"Site"	Site Name	Location of the measurement.
	Comments	Comments about the measurement, e.g. the external conditions during the measurement.
	GPS Position	Displays the GPS information. See Chapter 3.2.10.3, "Using the GPS receiver" , on page 57.

Measurement specification

The measurement specification dialog box displays the measurement step sequences and the individual performed measurement status. See [Figure 5-3](#).

- ▶ Select "Meas Spec" softkey.

The R&S Spectrum Rider opens the "Meas Spec" dialog box.

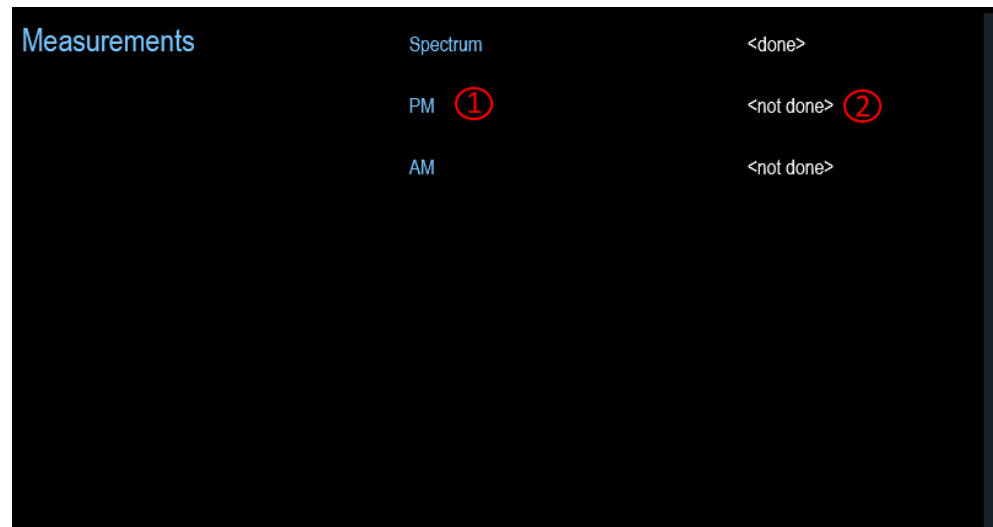

Figure 5-3: Measurement specification dialog box

- 1 = Measurement step in a wizard set
- 2 = Individual measurement step status

Performing a sequence of measurements

Now that you have updated all [measurement setting parameters](#) concerning the measurement task, you can start the measurement procedure.

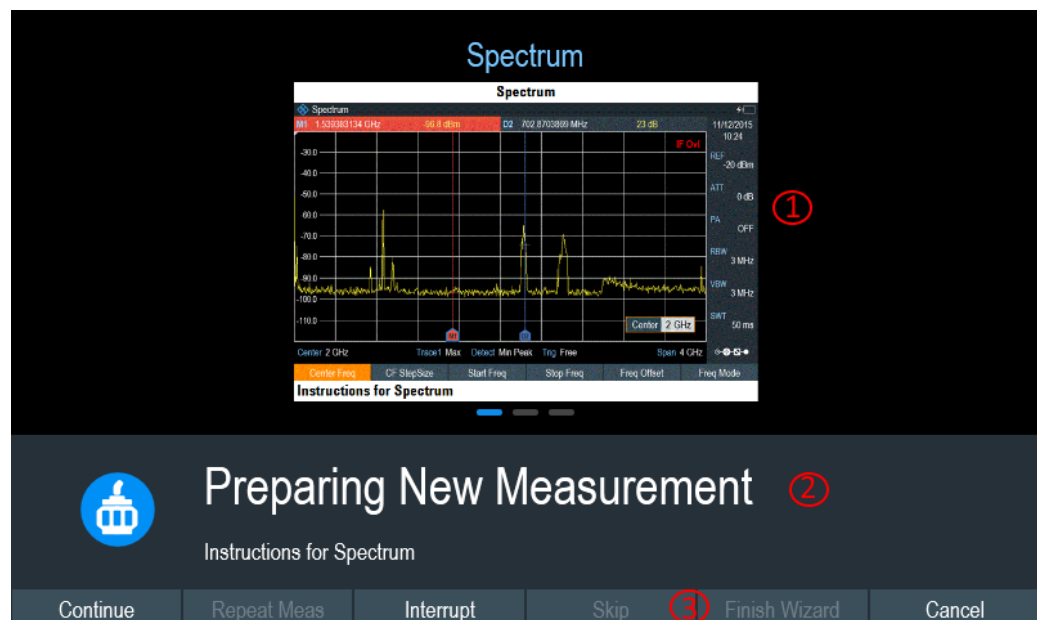

Figure 5-4: Perform wizard measurement dialog box

- 1 = Image of a measurement step defined in the R&S InstrumentView software package.
 2 = Wizard message box
 3 = See [Table 5-2](#)

1. Select "Start Meas" softkey.

The R&S Spectrum Rider starts to go through the measurements that are part of the measurement wizard set. The sequence of the measurements is defined in the R&S InstrumentView.

Before the start of each measurement, the R&S Spectrum Rider displays a message "Preparing New Measurement" in the wizard message box.

The message box contains information and instructions on how to prepare and perform the measurement that you have defined in the R&S InstrumentView software.

2. At each measurement step, you have several options:

- Select "Continue" softkey.

The R&S Spectrum Rider finishes the current measurement and opens the measurement wizard dialog box. See [Figure 5-5](#)

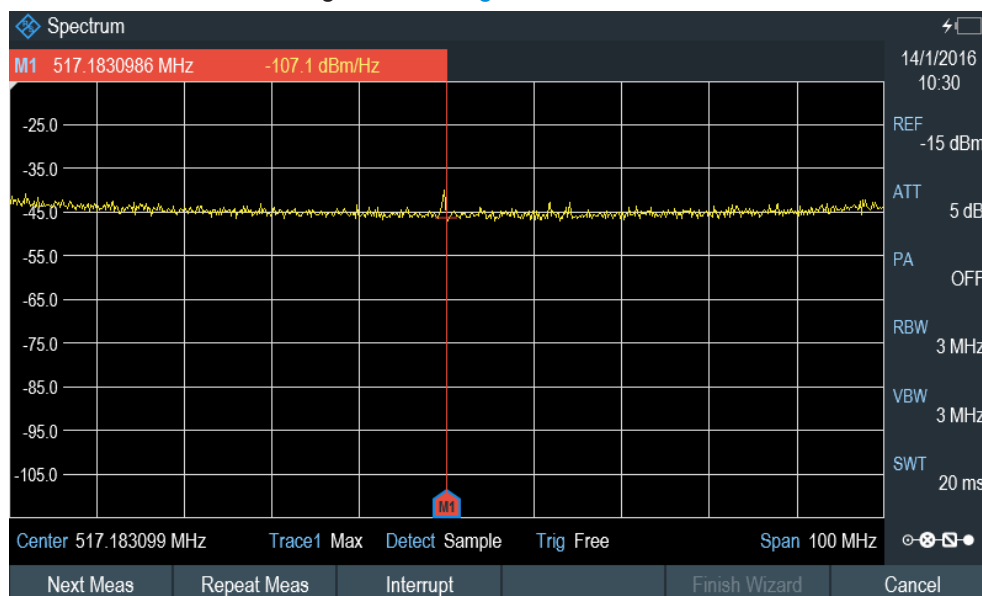

Figure 5-5: Measurement wizard dialog

- Select "Next Meas" softkey to proceed to the next measurement step in the measurement sequence.
- Select "Repeat Meas" softkey if the result does not match your expectation and you want to validate the result again.
- Select "Interrupt" softkey if the result does not match your expectation and you want to find the origin of the problem by using a different settings or measurement than those defined in the wizard.
- Select "Finish Wizard" softkey to end the measurement sequence.
- Select "Cancel" softkey if at any time the result does not match your expectation and you want to abort the measurement.

The R&S Spectrum Rider prompts you to save measurement result and exit the wizard measurement.

- Select "Interrupt" softkey.

The R&S Spectrum Rider opens the wizard interrupt dialog box.

There are three selections in the wizard interrupt dialog box, you can either:

- Select "Leave Menu" softkey to proceed and perform the necessary reconfiguring of the measurement. The R&S Spectrum Rider goes to the current measurement environment which you can analyze the measurement settings and make the necessary reconfiguration on the measurements.

After you have completed the reconfiguration on the measurement, press [WIZARD] key to return back to the wizard interrupt dialog box

- Select "Resume Sequence" softkey to resume back to the measurement.
- Select "Cancel" softkey to abort the wizard measurement.

- Select the "Skip" softkey.

The R&S Spectrum Rider skips a single measurement step and continue the subsequent measurement step.

Note: Alternatively, you can swipe horizontally to the left direction to skip a wizard measurement. See [Chapter 4.2.9, "Skip wizard measurement"](#), on page 97.

- Select "Cancel" softkey.

The R&S Spectrum Rider displays a message "Cancel Incomplete Wizard Sequence" in the wizard message box.

Select "YES" to abort the wizard measurement or "NO" to continue.

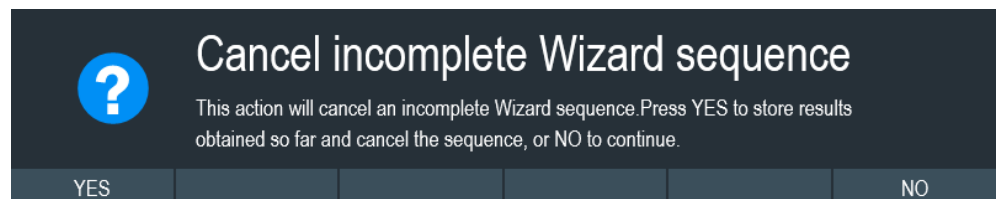

This is followed with a message prompt to save measurement result. The R&S Spectrum Rider displays a message "Save Wizard Measurement Results" in the wizard message box.

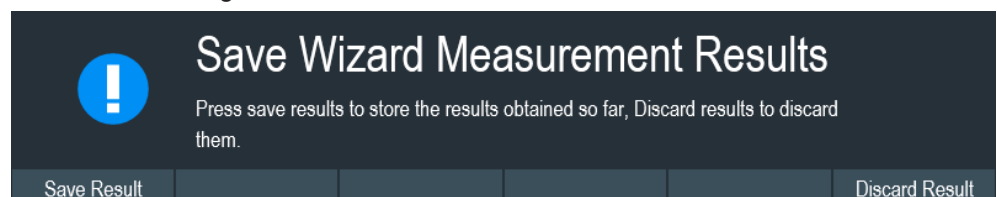

Select "Save Result" to save the measurement results or "Discard Result" to discard the measurement results.

3. After each measurement is completed, the R&S Spectrum Rider displays a message "Measurement Done" in the wizard message box.

Select "Continue" softkey to proceed to the next measurement step (if any).



4. After all the measurements are completed, the R&S Spectrum Rider displays a message "All Measurements Done" in the wizard message box.
Select "Continue" softkey. The R&S Spectrum Rider prompts you to save or discard the measurement results.
Select "Save Result" softkey to save the results on the selected storage device or "Discard Result" softkey to discard all the measurement results.



All Measurements Done

Table 5-2: Softkey in the measurement wizard

Softkey	Description
"Next Meas"	The R&S Spectrum Rider proceeds to perform the measurement.
"Continue"	The R&S Spectrum Rider finishes the current measurement and begins with the next measurement by showing the necessary preparation instruction.
"Repeat Meas"	Repeat the current measurement
"Interrupt"	If you interrupt the measurement sequence, you can change the different settings or measurements as if wizard is not in used. The R&S Spectrum Rider keeps the results of measurement you have already performed. When you finished reconfigured the measurement, you can resume back to the measurement sequence.
"Skip"	Skip a single measurement step and continue the subsequent measurement step Skipping individual measurements is possible when you turn on "Allow to skip measurements and finish wizard sequence" in the "Wizard Set Editor" of the R&S InstrumentView software package.
" Cancel"	Abort wizard measurement. The R&S Spectrum Rider displays a message "Cancel Immediate Wizard Sequence" in the message box. If wizard measurement is aborted, the R&S Spectrum Rider displays a message "Save Wizard Measurement Results" in the message box. If wizard measurement result is saved, the R&S Spectrum Rider returns to the last saved measurement result trace window. If the result is discarded, the R&S Spectrum Rider returns to the measurement dialog box .
"Exit"	Exit wizard measurement.

Softkey	Description
"Finish Wizard"	Ends the measurement sequence and returns to the "Measurement Wizard" dialog box. The results of the measurements you have already finished are kept in the memory of the R&S Spectrum Rider. Ending the sequence is possible when you turn on "Allow to skip measurements and finish wizard sequence" in the "Wizard Set Editor" of the R&S InstrumentView software package.
"Save Result"	Save result of the measurements performed in the wizard set. See "Measurements result" on page 121
"Discard Result"	Discard measurement results.

Measurements result



Limited internal memory

If you have to store the results on the internal memory, make sure that there is enough space left to store them or else the results might get lost. If the space is not enough, you can delete old data with the file manager.

For more information, see [Chapter 4.8.3, "Deleting datasets"](#), on page 111.



Measurement wizard results

All the measurement wizard results are stored in the wizard result folder during the process of the measurement wizards. These stored results will not be saved until you do a [Save Result](#) at the end of the wizard measurement.

The results for a measurement set consist of several files, each file corresponding to one of the performed measurements. For easy evaluation, the R&S Spectrum Rider includes the name of the measurement as defined in the wizard dialog or R&S InstrumentView.

All result files that belong to a measurement set are stored in the same directory. The directory is named after the measurement name and site. The syntax is 'site-name_measurement_#'.

The R&S Spectrum Rider adds numbers in ascending order to the files and directories if you perform a measurement or measurement set more than once.

5.2 Evaluating results

The R&S InstrumentView software package provides functionality to evaluate results and compile measurement reports. However, before you can start to evaluate the results you have to download the results to your computer. See ["Data synchronization"](#) on page 105.

The report generator function in R&S InstrumentView allows you to create measurement reports for the full measurement set or a selection of dataset only. You can also

perform simple tasks like activating or deactivating markers that have been set during the measurement.

1. Select "Report Generator" menu item in the R&S InstrumentView
The R&S InstrumentView opens the "Report Generator" dialog box that provides all functionality to manage measurement sets.
2. Select the measurement sets that you want to include in the report.
3. Select the reporting parameters checkmarks that you want to show in the report, e.g. checkmark to show marker data.
4. Select "Generate" button to create the report.

For more information on the report generator function, see the R&S InstrumentView user manual.

6 Spectrum analyzer mode

MODE

The default operating mode of the R&S Spectrum Rider is the spectrum analyzer. The spectrum analyzer provides the functionality to perform measurements in the frequency domain, e.g. to identify the power of signals.

- [Performing spectrum measurements](#)..... 123
- [Configuring spectrum measurements](#)..... 172
- [Working with channel tables](#).....211
- [Using transducer factors](#)..... 212

6.1 Performing spectrum measurements

MEAS

In addition to basic spectrum measurements, the R&S Spectrum Rider provides several specific measurements. These measurements, also in combination with one of the available accessories, allow you to perform advanced and more complex measurement tasks.

6.1.1 Measuring basic signal characteristics

Basic spectrum measurements determine the spectrum of a signal in the frequency domain or keep track of a signal in the time domain. They provide a basic overview of the input signal characteristics.

Frequency domain

In the frequency domain, the R&S Spectrum Rider analyzes the input signal characteristics over a particular span. You can use it, for example, to obtain basic measurement results like peak levels and the shape of the spectrum.

The horizontal axis shows the frequency, the vertical axis shows the signal levels.

The measurement in the frequency domain is the default measurement mode.

Time domain

In the time domain, the R&S Spectrum Rider analyzes the characteristics of a signal at a particular frequency over time. The span during time domain measurements is zero (zero span mode). You can use time domain measurements, for example to monitor the characteristics of a signal.

The horizontal axis shows the time, the vertical axis shows the signal levels.

To perform a time domain measurement, you have to set the span to zero manually.

6.1.1.1 Using an audio signal to locate signal

You can configure the R&S Spectrum Rider to play back an audio signal when it receives a signal. The audio signal changes its volume and frequency, depending on the strength of the received signal.

1. Press [MEAS] key.
2. Select "Tone" softkey.
The R&S Spectrum Rider opens a submenu to select the tone measurement mode.

Activate the tone measurement mode

- ▶ Select the "Tone" menu item.
The R&S Spectrum Rider turns the audio signal on.
You will also see a marker, M1 display on the frequency spectrum. Position the marker to the signal of interest for tone measurement mode.

The R&S Spectrum Rider allows you to define the various aspects of this audio signal.

Defining a squelch level

The squelch level defines the signal level above which the audio signal starts to play.

1. Select the "Squelch Level" menu item.
The R&S Spectrum Rider opens an input field to define the squelch level.
2. Enter a squelch level in dBm as required.

Defining the threshold of the audio signal

The audio signal has a specific frequency that is coupled to a specific signal level, the threshold. As the signal you are receiving during a measurement becomes stronger or weaker, the audio signal changes its frequency:

- When the signal becomes stronger, the frequency of the audio signal gets higher
- When the signal becomes weaker, the frequency of the audio signal gets lower

You can define the threshold of the base tone as necessary.

1. Select the "Threshold Tone Frequency" menu item.
The R&S Spectrum Rider opens an input field to define the threshold.
2. Enter a threshold level in dBm as required.

Note that it may be possible that the audio signal frequency becomes so high or low that it is no longer audible.

Defining the gain of the audio signal

The change of frequency of the audio signal is a constant change of frequency. It is either one octave per 20 dB or one octave per 40 dB.

1. Select the "Tone Gain" menu item.
The R&S Spectrum Rider opens a submenu.
2. Select the gain setting you prefer.

Defining the volume of the audio signal

The R&S Spectrum Rider allows you to adjust the volume of the audio signal.

1. Select the "Tone Volume" menu item.
The R&S Spectrum Rider opens an input field to define the volume.
2. Define a volume you are comfortable with.

The volume is a percentage from 0% to 100% with 100% being the loudest.

6.1.2 Measuring the channel power of continuously modulated signals

The channel power measurement selectively measures the power of modulated signals. Unlike a power meter that performs measurements over its entire frequency range, the channel power measurement measures the power of a specific transmission channel. Other signals in the frequency spectrum do not show in the results.

When measuring the spectrum within a channel, the R&S Spectrum Rider uses a resolution bandwidth that is small compared to the channel bandwidth. It then determines the total power of the channel by integrating the results on the trace. The R&S Spectrum Rider takes the following parameters into account:

- display mode (absolute or relative)
- detector
- resolution bandwidth

That means that you can compare the result to the result that would have been obtained from a thermal power meter. The small resolution bandwidth acts like a narrow channel filter and so prevents out-of-channel emissions from affecting the result.

1. Press [MEAS] key.
2. Select "Meas Mode" key.
The R&S Spectrum Rider opens a submenu to select the measurement mode.
3. Select the "Channel Power" menu item.
The R&S Spectrum Rider starts to measure the channel power.
4. By default, the 3GPP WCDMA standard is active. Two vertical lines show the channel bandwidth.

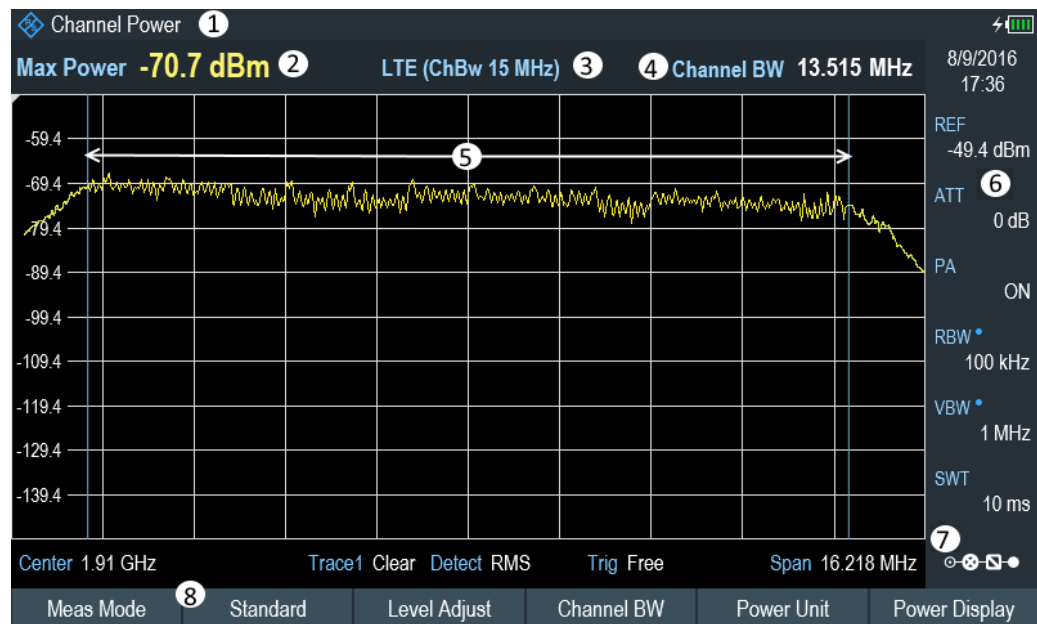

Figure 6-1: Screen layout for channel power measurements

- 1 = Measurement mode
- 2 = Channel power numerical
- 3 = Measurement standard
- 4 = Channel bandwidth
- 5 = Channel bandwidth graphical (blue lines)
- 6 = [Parameter view](#)
- 7 = [Configuration overview](#)
- 8 = Channel power measurement softkey menu

6.1.2.1 Selecting the standard

If you need to perform measurements that are conformed to a telecommunications standard, you can activate one of the predefined standards that are already stored in the R&S Spectrum Rider memory. However, you can create new configurations to perform measurements on other standards as well.

1. Press [MEAS] key.
2. Select "Standard" softkey.
The R&S Spectrum Rider opens a file manager dialog box to select the standard.
3. Select one of the available standards.
The R&S Spectrum Rider loads the configuration of the selected standard. It automatically sets the optimal span, resolution bandwidth, video bandwidth, sweep time and detector for the standard.

You can create and edit standards with the R&S InstrumentView software and transfer them to the R&S Spectrum Rider via the USB or the LAN interface. The number of standards the R&S Spectrum Rider can store in its memory depends on the number of other data sets stored on the R&S Spectrum Rider.

For more information, see [Chapter 4.8, "Managing datasets"](#), on page 105.

6.1.2.2 Setting the reference level

The reference level is the power level that the R&S Spectrum Rider expects at the RF input. When selecting the reference level, make sure that you do not overload the R&S Spectrum Rider by applying a signal whose power exceeds the maximum reference level.

As the power is measured with a small resolution bandwidth compared to the signal bandwidth, it is still possible to overload the R&S Spectrum Rider, even if the trace is within the measurement diagram. To prevent an overload, perform the measurement with the largest resolution bandwidth possible using the peak detector. If you set these parameters, it is not possible for the trace to exceed the reference level.

To simplify operation and to prevent incorrect measurements, the R&S Spectrum Rider has an automatic routine for setting the reference level.

1. Press [MEAS] key.
2. Select "Level Adjust" softkey.
The R&S Spectrum Rider performs a measurement to determine the optimal reference level.
It uses a resolution bandwidth of 3 MHz, a video bandwidth of 3 MHz and the peak detector. After finishing the automatic measurement, the R&S Spectrum Rider sets the optimal reference level.



Adjusting level for measurement.

6.1.2.3 Setting the channel bandwidth

The channel bandwidth specifies the frequency range around the center frequency, over which the R&S Spectrum Rider performs the power measurement.

1. Press [MEAS] key.
2. Select "Channel BW" softkey.
The R&S Spectrum Rider opens an input field to specify the channel bandwidth.
3. Enter the channel bandwidth you required.
The R&S Spectrum Rider sets the appropriate span for the channel bandwidth that you have entered (span = 1.2 x channel bandwidth). This ensures that no incorrect channel power measurements are made.
The minimum channel bandwidth that you can set is 833 Hz at a span of 1 kHz.

6.1.2.4 Changing the span

Usually, the span the R&S Spectrum Rider sets yields optimal results. But sometimes you also need to see the spectrum outside the current span to detect other signal components that you need to include in the measurement. Therefore, you can adjust the span to up to 10 times the channel bandwidth and hence still be able to see the spectrum outside the measurement channel.

1. Press [SPAN] key.
2. Select "Manual Span" softkey.
The R&S Spectrum Rider opens an input field to define the span manually.
3. Enter the span you need.
The largest possible span for the channel power measurement is ten times the channel bandwidth. At larger spans, the result of the channel power measurement would be increasingly imprecise, because too few points of the trace would be in the channel you are measuring.

6.1.2.5 Configuring and triggering the sweep

For more information on setting the sweep, see [Chapter 6.2.6.1, "Setting the sweep time"](#), on page 186 in frequency domain.

For more information on the trigger functionality, see [Chapter 6.2.6.3, "Working with trigger functionality"](#), on page 187 in frequency domain.

6.1.2.6 Measuring the maximum channel power

If signal levels fluctuate significantly, you can define the maximum channel power with the "Max Hold" function.

1. Press [MEAS] key.
2. Select "Power Display" softkey.
The R&S Spectrum Rider opens a submenu to select channel power measurement mode.
3. Select the "Max Hold" menu item.
The power display (see item 2 of [Figure 6-1](#)) switches from [Power] to "Max Power".
If you want to deactivate the "Max Hold" function and return to the normal power display, activate "Clear/Write".
4. To deactivate the "Max Hold" function, press the "Power Display" softkey.
5. Select the "Clear/Write" menu item.
The power display returns to "Power" display.

6.1.2.7 Unit for power display

The R&S Spectrum Rider can apply different units to the power output. The default unit is dBm.

1. Press [MEAS] key.
2. Select "Power Unit" softkey.
The R&S Spectrum Rider opens a submenu to select the power unit.
3. Select the unit you require from the submenu.
The R&S Spectrum Rider displays the power level in the selected unit.

6.1.3 Measuring the occupied bandwidth

The proper operation of a transmission network requires that all transmitters adhere to the bandwidths assigned to them. The occupied bandwidth is defined as the bandwidth that contains a specified percentage of the entire power of the transmitter.

Numerous standards require an occupied bandwidth of 99 which is also the default setting. If you need another percentage for the occupied bandwidth, you can set values from 10 % to 99.9 %.

After entering the channel bandwidth, the R&S Spectrum Rider automatically selects the measurement parameters so that you can attain the best result.

1. Press [MEAS] key.
2. Select "Meas Mode" softkey.
3. The R&S Spectrum Rider opens a submenu to select the measurement mode.
4. Select the "Occupied BW" menu item.
The R&S Spectrum Rider starts to measure the occupied bandwidth.
Two vertical lines show the occupied bandwidth.

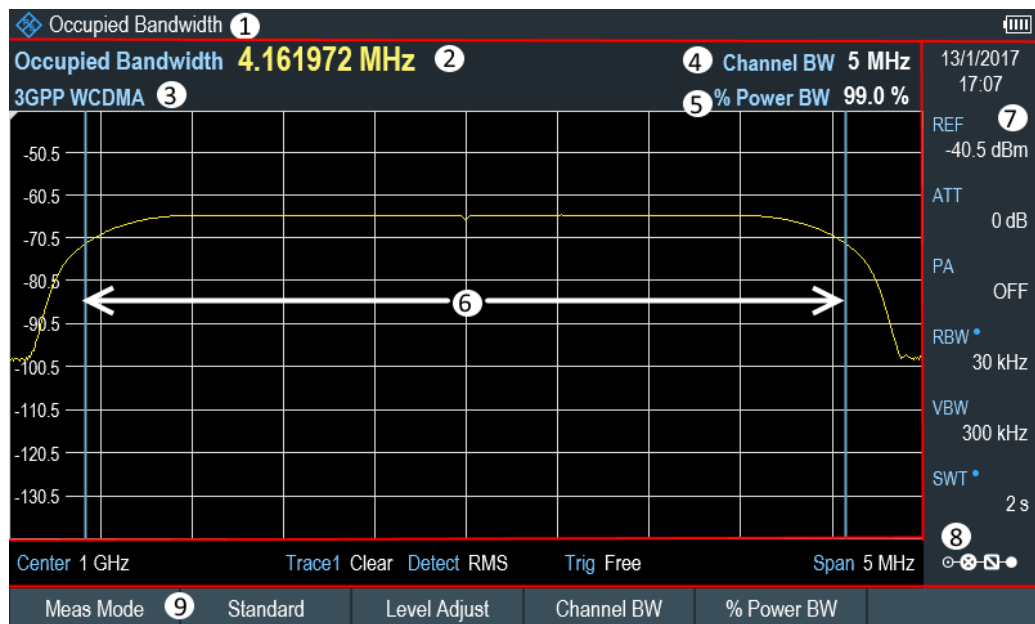

Figure 6-2: Screen layout for the occupied bandwidth

- 1 = Occupied bandwidth measurement mode
- 2 = Occupied bandwidth numerical
- 3 = Measurement standard
- 4 = Channel bandwidth
- 5 = Power percentage
- 6 = Occupied bandwidth graphical (blue lines)
- 7 = [Parameter view](#)
- 8 = [Configuration overview](#)
- 9 = Occupied bandwidth measurement softkey menu

6.1.3.1 Selecting a standard

If you need to perform measurements that are conformed to a telecommunications standard, you can activate one of the predefined standards that are already stored in the R&S Spectrum Rider memory. However, you can also use the R&S InstrumentView to create new configurations to perform measurements on other standards as well. For more information on creating new configurations, see "Using Standards" in the R&S InstrumentView.

1. Press [MEAS] key.
2. Select "Standard" softkey.
The R&S Spectrum Rider opens the "File Manager" dialog to select the standard.
3. Select one of the available standards.
4. Confirm the selection with the "Load" softkey.
The R&S Spectrum Rider loads the configuration of the selected standard. It automatically sets the optimal span, resolution bandwidth, video bandwidth, sweep time and detector for the standard.

You can create and edit standards with the R&S InstrumentView and transfer them to the R&S Spectrum Rider via the USB or the LAN interface. The number of standards the R&S Spectrum Rider can store in its memory depends on the number of other data sets stored on the R&S Spectrum Rider.

For more information, see the [Chapter 4.8, "Managing datasets"](#), on page 105.

If you make changes to the settings or create datasets, note that:

- The span is always coupled to the channel bandwidth. Changes to either of those automatically adjust the other (= 5 x channel bandwidth).
- The resolution bandwidth should be between 1 % and 4 % of the channel bandwidth. This ensures that the occupied bandwidth is measured with high accuracy.
- The video bandwidth must be at least three times the resolution bandwidth. This prevents incorrect results due to the compression of signal peaks by the video filter.
- You use the RMS detector if possible. This ensures that the power measurement is always correct irrespective of the waveform being investigated.
- The sweep time must be set so that the result is stable. If you increase the sweep time, the R&S Spectrum Rider also increases the integration time for the RMS detector and thus ensures more stable measured values.

6.1.3.2 Setting the reference level

The reference level is the power level that the R&S Spectrum Rider expects at the RF input. When selecting the reference level, make sure that you do not overload the R&S Spectrum Rider by applying a signal whose power exceeds the maximum reference level.

As the power is measured with a small resolution bandwidth compared to the signal bandwidth, it is still possible to overload the R&S Spectrum Rider, even if the trace is within the measurement diagram.

To prevent an overload, perform the measurement with the largest resolution bandwidth possible using the peak detector. If you set these parameters, it is not possible for the trace to exceed the reference level.

To simplify operation and to prevent incorrect measurements, the R&S Spectrum Rider has an automatic routine for setting the reference level.

1. Press [MEAS] key.
2. Select "Level Adjust" softkey.

The R&S Spectrum Rider performs a measurement to determine the ideal reference level.

It uses a resolution bandwidth of 1 MHz, a video bandwidth of 1 MHz and the peak detector. After finishing the automatic measurement, the R&S Spectrum Rider sets the ideal reference level.

6.1.3.3 Setting the channel bandwidth

The channel bandwidth specifies the frequency range around the center frequency, over which the R&S Spectrum Rider performs the power measurement.

1. Press [MEAS] key.
2. Select "Channel BW" softkey.
The R&S Spectrum Rider opens an input field to define the channel bandwidth.
3. Enter the channel bandwidth you need.
The R&S Spectrum Rider sets the appropriate span for the channel bandwidth that you have entered (span = 5 x channel bandwidth). This ensures that no incorrect channel power measurements are made.
The minimum channel bandwidth that you can set is 2 kHz at a span of 1 kHz.

6.1.3.4 Defining the percentage of occupied bandwidth

By default, the power percentage inside the occupied bandwidth is 99 %, a number most standards require. If you measure standards that specify another power percentage you can change that value.

1. Press [MEAS] key.
2. Select "% Power BW" softkey.
The R&S Spectrum Rider opens an input field to define the power percentage.
3. Enter the power percentage you need.
The value you enter here is the power percentage that has to be inside the channel bandwidth relative to the power over the total span (the percentage of the total power).
The R&S Spectrum Rider now displays the occupied bandwidth graphically in the trace window and numerically above the trace window.

6.1.3.5 Changing the span

The span that the R&S Spectrum Rider usually sets yields optimal results. But sometimes you also need to see the spectrum outside the current span to detect other signal components that you need to include in the measurement. Therefore, you can adjust the span to up to ten times the channel bandwidth and still be able to see the spectrum outside the measurement channel.

1. Press [SPAN] key.
In the default configuration, "Auto Span" is active. The R&S Spectrum Rider automatically sets the optimal span for the channel power measurement.
2. Select "Manual Span" softkey.
The R&S Spectrum Rider opens an input field to define the span manually.
3. Enter the span you need.

The largest possible span for the channel power measurement is ten times the channel bandwidth. At larger spans, the result of the channel power measurement would be increasingly imprecise, because too few points of the trace occur in the channel to be measured.

4. Select "Auto Span" softkey.
The R&S Spectrum Rider again calculates the span automatically.

6.1.3.6 Configuring and triggering the sweep

For more information on setting the sweep, see [Chapter 6.2.6.1, "Setting the sweep time"](#), on page 186 in frequency domain.

Equipped with option R&S Spectrum Rider-K57 (order number: 1321.1586.02), you can now perform gated trigger measurement. For more information on the trigger functionality, see [Chapter 6.2.6.3, "Working with trigger functionality"](#), on page 187 in frequency domain.

6.1.3.7 Using a trigger

For more information on using external trigger to trigger measurements, see ["External trigger"](#) on page 135.

6.1.4 Power measurements on TDMA signals

When TDMA (time division multiple access) methods are used, e.g. for GSM, several users share a channel. Each user is assigned a period of time or timeslot. With the TDMA power measurement, you can determine the power over one of the timeslots allocated to the user.

The TDMA power measurement is a measurement in the time domain (span = 0 Hz). You can start it on an external or video trigger and specify the power measurement time.

To prevent incorrect power measurements in the time domain, make sure that the whole signal is within the selected resolution bandwidth. If the resolution bandwidth is too small, the displayed power will be lower than the actual power.

1. Press [MEAS] key.
2. Select "Meas Mode" softkey.
The R&S Spectrum Rider opens a submenu to select the measurement mode.
3. Select the "TDMA Power" menu item.
The R&S Spectrum Rider starts to measure the TDMA power.
Two vertical lines define the measurement range.

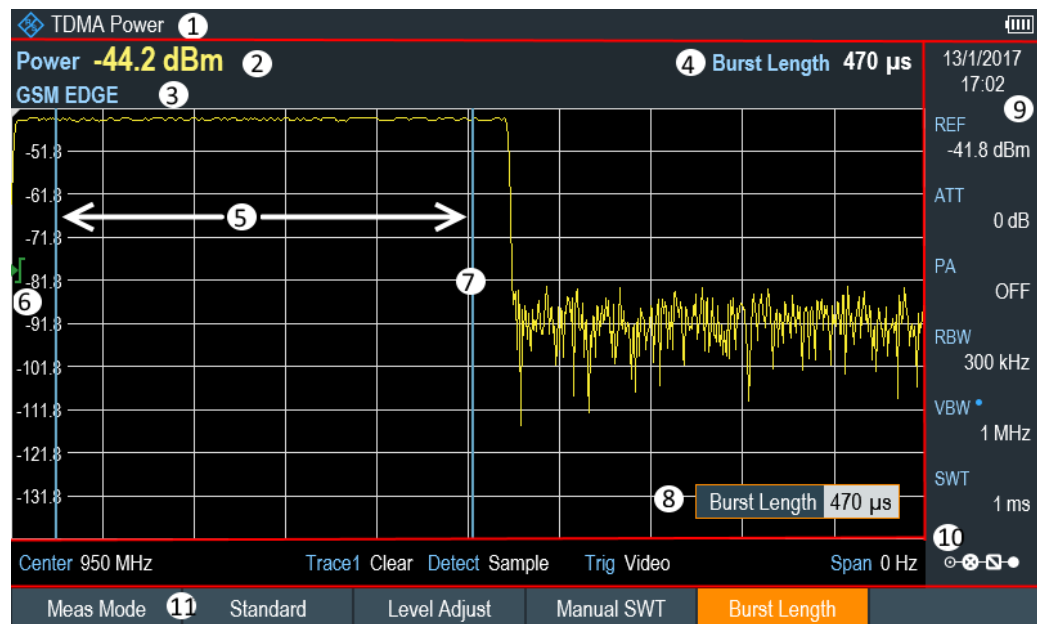

Figure 6-3: Screen layout for TDMA power measurements

- 1 = TDMA power measurements mode
- 2 = TDMA power
- 3 = Measurement standard
- 4 = Measurement time
- 5 = Measurement limits
- 6 = Trigger level
- 7 = Trigger delay
- 8 = Measurement time entry input
- 9 = [Parameter view](#)
- 10 = [Configuration overview](#)
- 11 = TDMA power measurement softkey

6.1.4.1 Selecting a standard

For more information on selecting a standard, see [Chapter 6.1.3.1, "Selecting a standard"](#), on page 130.

6.1.4.2 Setting the burst length

The burst length is the measurement time that the R&S Spectrum Rider used to perform the TDMA power measurement. The burst length can be equal or less than the sweep time.

1. Press [MEAS] key.
2. Select "Burst Length" softkey.
The R&S Spectrum Rider opens an input field to define the burst length.
3. Enter the length of the burst you need.

The R&S Spectrum Rider performs the measurement over the time you have entered.

If the measurement time you have entered was greater than the sweep time, the R&S Spectrum Rider sets a burst length equal to the sweep time. To work with a greater burst length, you have to increase the sweep time first.

The minimum burst length is the time corresponding to one trace pixel (= sweep time / 711).

6.1.4.3 Setting the reference level

The reference level is the power level that the R&S Spectrum Rider expects at the RF input. When selecting the reference level, make sure that you do not overload the R&S Spectrum Rider by applying a signal whose power exceeds the maximum reference level.

As the resolution bandwidths of the R&S Spectrum Rider are implemented digitally after the A/D converter, the signal level at the A/D converter can be higher than the level indicated by the trace, depending on the selected resolution bandwidth.

To prevent the A/D converter from being overloaded, the signal must be measured at the widest resolution bandwidth and video bandwidth with the peak detector. The trace maximum then determines the best reference level.

To simplify operation and to prevent incorrect measurements, the R&S Spectrum Rider has an automatic routine for setting the reference level.

1. Press [MEAS] key.
2. Select "Level Adjust" softkey.

The R&S Spectrum Rider performs a measurement to determine the ideal reference level.

It uses a resolution bandwidth of 3 MHz, a video bandwidth of 3 MHz and the peak detector. After finishing the automatic measurement, the R&S Spectrum Rider sets the ideal reference level.

6.1.4.4 Using a trigger

When measuring a burst, it is often to set a trigger before measurement is taken.

Video trigger

If a trigger is active, the R&S Spectrum Rider uses the video trigger for TDMA measurements by default. The video trigger level is at 50 % of the range of the vertical axis but is variable. This means, the R&S Spectrum Rider triggers a measurement if the rising edge of the burst exceeds this 50 % line.

External trigger

If the DUT features some sort of trigger equipment, you can also use an external trigger to trigger measurements.

1. Connect the DUT trigger output to the R&S Spectrum Rider trigger input.
2. Press [SWEEP] key.
3. Select "Trigger" softkey.
The R&S Spectrum Rider opens a submenu to select the trigger setting.
4. Select either the "External Rise" or "External Fall" menu item (rising or falling edge).
The R&S Spectrum Rider activates the trigger and shows the results of the measurement.

It may be that the burst is not completely visible on the display. To correct that and make the whole burst visible, you can set a trigger delay.

1. Select "Trigger" softkey.
The R&S Spectrum Rider opens a submenu to select the trigger setting.
2. Select "Trigger Delay" softkey.
The R&S Spectrum Rider opens an input field to define the trigger delay.
3. Adjust the trigger delay until the burst is visible inside the vertical lines that show the measurement range.

6.1.5 Measuring the spectrum emission mask

The Spectrum Emission Mask (SEM) measurement is a method to detect spurious emissions or intermodulation products of a signal. When performing a SEM measurement, the R&S Spectrum Rider checks the signal against a spectral mask to see whether the signal complies with a specific standard or not. Therefore, the R&S Spectrum Rider provides predefined spectrum emission masks for various telecommunications standards.

However, you can define your own spectral masks with the R&S InstrumentView software to perform measurements in frequency ranges other than the predefined ones. To learn how to define Spectrum Emission Masks, refer to the R&S InstrumentView manual.

1. Press [MEAS] key.
2. Select "Meas Mode" softkey.
3. The R&S Spectrum Rider opens a submenu to select the measurement mode.
4. Select the "Spectrum Emission Mask" menu item.
The R&S Spectrum Rider starts to measure the spectrum emission mask.

Note that the frequency range of the actual measurement depends on the start and stop frequency you have set on the R&S Spectrum Rider. Correct measurement results are therefore only possible if the frequency ranges of the SEM are inside the current span of the R&S Spectrum Rider.

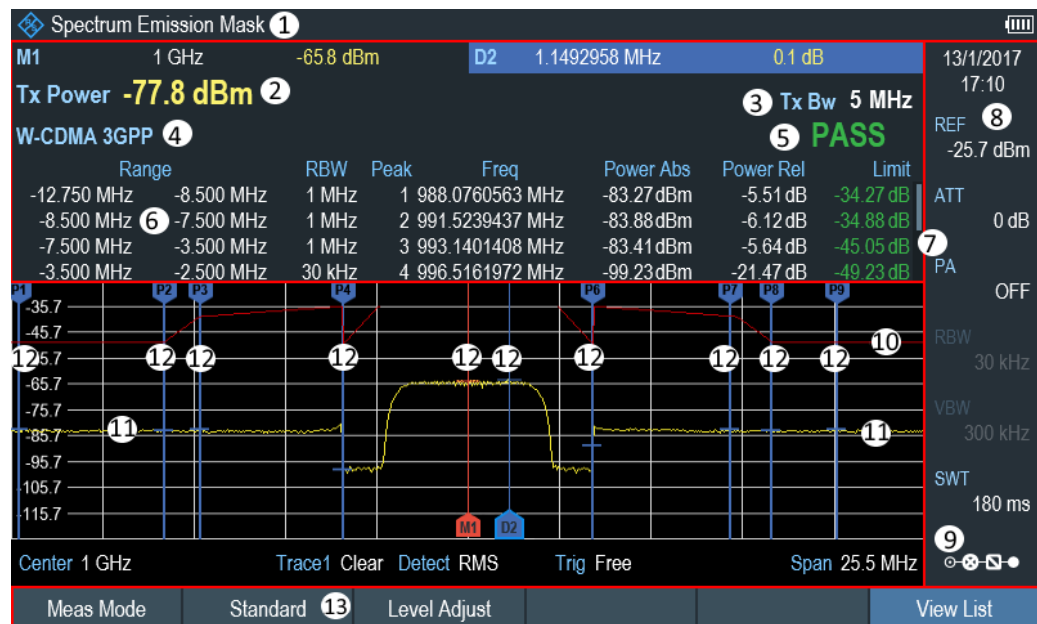

Figure 6-4: Screen layout for the SEM measurement

- 1 = SEM measurement mode
- 2 = Tx power measurement
- 3 = Tx bandwidth
- 4 = Measurement standard
- 5 = Limit check result
- 6 = SEM measurement list
- 7 = Scroll bar for SEM measurement list
- 8 = [Parameter view](#)
- 9 = [Configuration overview](#)
- 10 = Spectrum emission mask (red line)
- 11 = Trace (yellow line)
- 12 = Peak (P<x>) and normal marker (M<x> and D<y>)
- 13 = SEM softkey menu

Markers in the SEM measurement

In addition to the normal marker functionality of the R&S Spectrum Rider, the SEM measurement provides special markers labeled P1 to Px.

The R&S Spectrum Rider activates and positions these special markers automatically after displaying the trace. Each of these markers marks the peak level in each SEM subrange. Thus, the number of markers depends on the number of subranges defined for the Spectrum Emission Mask and in turn depends on the standard you are measuring against.

The numerical marker information (frequency and level) for these markers is part of the SEM list.

Markers P1 to Px are fix and always remain on the peak level of the corresponding subrange. If you would like to analyze other locations on the trace, use normal marker and deltamarker functionality. For more information, see [Chapter 6.2.8, "Using markers"](#), on page 196.

6.1.5.1 Selecting a standard

For more information on selecting a standard, see [Chapter 6.1.3.1, "Selecting a standard"](#), on page 130.

6.1.5.2 Optimizing measurement settings

After selecting the standard and applying the signal to the R&S Spectrum Rider, you can optimize measurement settings to avoid overloading the R&S Spectrum Rider.

- ▶ Select the "Level Adjust" softkey.
The R&S Spectrum Rider performs a measurement to determine the ideal reference level and span.

6.1.5.3 Viewing the results in a table

You can add a table to the display that shows the measurement results in numerical form.

1. Press [MEAS] key.
2. Select "View List " softkey.

The R&S Spectrum Rider displays the [Measurement result view](#).

Note: You can select "View List" to hide or unhide the [Measurement result view](#)

If the list contains more than four entries, you can pan through the list or use the rotary to navigate the other results. Note that scrolling works only if there is no active input field.

Range	RBW	Peak	Freq	Power Abs	Power Rel	Limit
-12.750 MHz - 8.500 MHz	1 MHz	1	987.4654930 MHz	-83.14 dBm	-39.08 dB	-34.14 dB
-8.500 MHz - 7.500 MHz	1 MHz	2	991.5239437 MHz	-83.76 dBm	-39.69 dB	-34.76 dB
-7.500 MHz - 3.500 MHz	1 MHz	3	992.5295775 MHz	-83.26 dBm	-39.19 dB	-44.26 dB
-3.500 MHz - 2.500 MHz	30 kHz	4	996.5161972 MHz	-99.22 dBm	-55.15 dB	-49.22 dB

Measurement items	Descriptions
Tx Power	Power level of the transmission channel.
Tx Bandwidth	Bandwidth of the transmission channel.
PASS / FAIL information	If the signal is within the limits of the spectral mask, the R&S Spectrum Rider shows PASS , if not, it shows FAIL .
Range [Hz]	Frequency range. The first number is the start frequency, the second number the stop frequency of each defined frequency range. The character following the number indicates the unit (k = kHz, M = MHz, G = GHz)
RBW [Hz]	Resolution bandwidth the corresponding frequency range is measured with.
Peak	Number of the peak marker (Px).

Measurement items	Descriptions
Freq [Hz]	Frequency of the peak level that has been measured in each frequency range
Power Abs	Absolute peak power in the corresponding frequency range.
Power Rel	Relative peak power in relation to the channel power of the reference channel.
Δ Limit	Minimum distance from the limit line to the trace in the corresponding frequency range. Negative values or a zero indicate a passed SEM limit check, positive values indicate a violation of the limit check.

6.1.5.4 Configuring and triggering the sweep

For more information on setting the sweep, see [Chapter 6.2.6.1, "Setting the sweep time"](#), on page 186 in frequency domain.

Equipped with option R&S Spectrum Rider-K57 (order number: 1321.1586.02), you can now perform gated trigger measurement. For more information on the trigger functionality, see [Chapter 6.2.6.3, "Working with trigger functionality"](#), on page 187 in frequency domain.

6.1.5.5 Using a trigger

For more information on using external trigger to trigger measurements, see ["External trigger"](#) on page 135.

6.1.6 Measuring the adjacent channel leakage ratio (ACLR)

The Adjacent Channel Leakage Ratio (ACLR) measurement is a method to measure the power over more than one transmission channel and also evaluate the power of the adjacent (or alternate) channels of the transmission channel. The ACLR performs measurements according to a specific channel configuration, e.g. a particular radio-communications standard.

1. Press [MEAS] key.
2. Select "Meas Mode" softkey.
The R&S Spectrum Rider opens a submenu to select the measurement mode.
3. Select the "ACLR" menu item.
The R&S Spectrum Rider starts to measure the adjacent channel leakage ratio.

In principle, the ACLR measurement works like the channel power measurement in that it determines the spectrum within the channel using a resolution bandwidth that is small compared to the channel bandwidth. In addition to the channel bandwidth, the

ACLR measurement is also defined by the channel spacing, the bandwidth of adjacent channels and the adjacent channel spacing.

The R&S Spectrum Rider supports measurements on up to 12 carrier channels and 12 adjacent channels to either side of the carrier. When measuring more than one carrier or adjacent channels, the R&S Spectrum Rider shows the powers of each channel in a list below the marker list. The channel itself is marked by red (transmission channels) or green (adjacent channels) vertical lines.

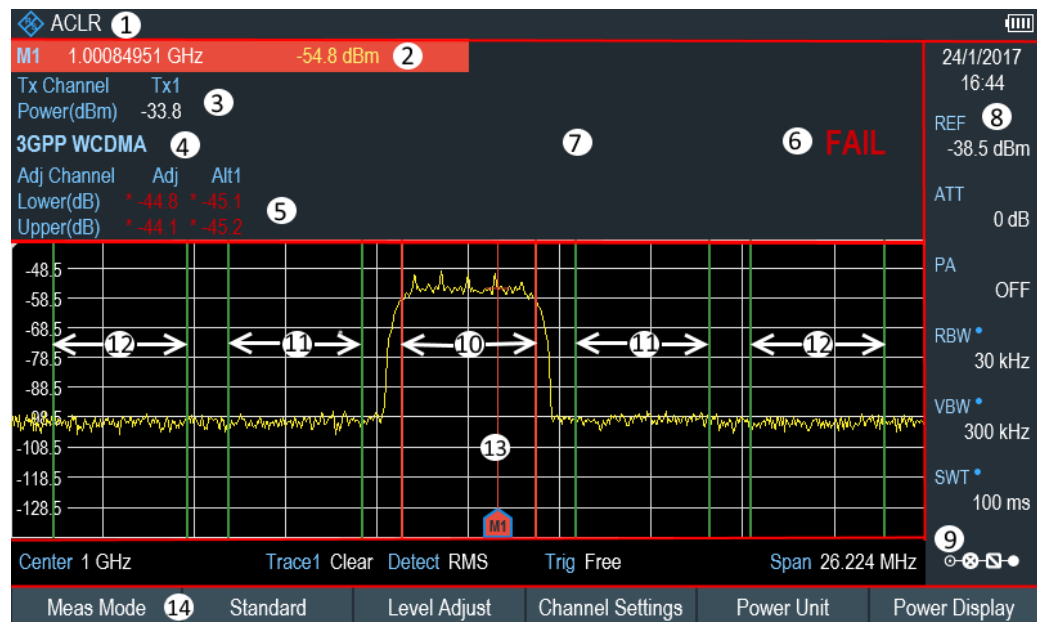

Figure 6-5: Screen layout for ACLR measurements

- 1 = ACLR measurement mode
- 2 = Marker information
- 3 = Tx channel power measurement
- 4 = Measurement standard
- 5 = Adjacent channel power measurement
- 6 = Limit check information
- 7 = [Measurement result view](#)
- 8 = [Parameter view](#)
- 9 = [Configuration overview](#)
- 10 = Tx channel (red line)
- 11 = Adjacent channel (green line)
- 12 = Alternate channel (green lines)
- 13 = Marker
- 14 = ACLR softkey menu

The predefined standards are the same as for channel power measurements (3GPP WCDMA, cdmaOne and CDMA2000 1x systems). However, you can also customize the settings to set up the R&S Spectrum Rider for other radiocommunication standards. You can define the settings directly on the R&S Spectrum Rider or define and manage them using the R&S InstrumentView software.

When customizing settings, make sure to consider the following points to get valid and accurate measurement results:

- Reference level

Make sure not to overload the R&S Spectrum Rider as the power is measured with a resolution bandwidth that is small in comparison with the signal bandwidth. As with channel power measurements, automatically set the reference to an optimal level with the "Level Adjust" softkey.

- **Setting the span**
The frequency span must at least cover the carriers and the adjacent channels plus a measurement margin of about 10 % to get valid results.
If the span is automatically calculated by the R&S Spectrum Rider with the "Auto Span" function, the span is calculated as follows:
 - (No. of transmission channels - 1) x transmission channel spacing + 2 x transmission channel bandwidth + measurement margin
 with the measurement margin being approx. 10 % of the value obtained by adding the channel spacing and the channel bandwidth.



Selecting the frequency span

If the frequency span is too large in comparison to the channel bandwidth (or the adjacent-channel bandwidths) being examined, only a few points on the trace are available per channel. This reduces the accuracy of the waveform calculation for the channel filter used, which has a negative effect on the measurement accuracy. It is therefore strongly recommended that the formulas mentioned be taken into consideration when selecting the frequency span.

- **Setting the resolution bandwidth:**
The RBW should not be too high or too small to get both an acceptable measurement speed and a suppression of spectral components outside the channels. As a rule of thumb, it is recommended to set it to about 1 % to 4 % of the channel bandwidth.
You can select a larger resolution bandwidth if the spectrum within the channel to be measured and around it has a flat characteristic. In the standard setting, e.g. for standard cdmaOne at an adjacent channel bandwidth of 30 kHz, a resolution bandwidth of 30 kHz is used. This yields correct results since the spectrum in the neighborhood of the adjacent channels normally has a constant level.
For standard NADC/IS136 this would not be possible, for example, since the spectrum of the transmit signal penetrates into the adjacent channels and a too large resolution bandwidth causes a too low selection of the channel filter. The adjacent-channel power would thus be measured too high.
If the RBW is automatically calculated by the R&S Spectrum Rider with the "Auto RBW" function, the RBW is calculated as follows:
 - $RBW \geq 1 / 40$ of channel bandwidth
 The R&S Spectrum Rider then selects the maximum possible resolution bandwidth resulting from the available RBW steps (1, 3).
- **Setting the video bandwidth**
To obtain correct power measurements, the video signal must not be limited in bandwidth. A restricted bandwidth of the logarithmic video signal would cause signal averaging and thus result in a too low indication of the power (-2.51 dB at very low video bandwidths). Therefore, the VBW should be at least three times the resolution bandwidth.

If the VBW is automatically calculated by the R&S Spectrum Rider with the "Auto VBW" function, the VBW is calculated as follows:

$$- \text{VBW} \geq 3 \times \text{RBW}$$

The R&S Spectrum Rider then selects the smallest possible VBW with regard to the available step size.

- **Selecting the detector:**
It is best to use the RMS detector. This detector correctly indicates the power irrespective of the characteristics of the signal to be measured. The whole IF envelope is used to calculate the power for each measurement point. The IF envelope is digitized using a sampling frequency which is at least five times the resolution bandwidth which has been selected. Based on the sample values, the power is calculated for each measurement point using the following formula:

$$P_{RMS} = \sqrt{\frac{1}{N} \cdot \sum_{i=1}^N S_i^2}$$

with

S_i = linear digitized video voltage at the output of the A/D converter

N = number of A/D converter values per measurement point

P_{RMS} = power represented by a measurement point

When the power has been calculated, the power units are converted into decibels and the value is displayed as a measurement point.

In principle, the sample detector would be possible as well. Due to the limited number of measurement points used to calculate the power in the channel, the sample detector would yield less stable results.

6.1.6.1 Selecting a standard

For more information on selecting a standard, see [Chapter 6.1.3.1, "Selecting a standard"](#), on page 130.

6.1.6.2 Configuring the measurement

In addition to creating and editing standards with the R&S InstrumentView software, the R&S Spectrum Rider also provides functionality to set up a measurement configuration.

Setting the number of transmission channels

1. Press [MEAS] key.
2. Select "Channel Settings" softkey.
The R&S Spectrum Rider opens a submenu to select the channel settings.
3. Select the "Tx Channels" menu item.
The R&S Spectrum Rider opens an input field to define the number of transmission channels.

4. Enter the number of transmission channels you need for the measurement.

Setting the number of adjacent channels

1. Select "Channel Settings" softkey.
The R&S Spectrum Rider opens a submenu to select the channel settings.
2. Select the "Adj Channels" menu item.
The R&S Spectrum Rider opens an input field to define the number of adjacent channels.
3. Enter the number of adjacent / alternate channels you need for the measurement.
The borders of Tx channels are displayed red in the trace diagram, the borders of adjacent and alternate channels are displayed green.

Setting the channel bandwidth

The channel bandwidth specifies the frequency range around the center frequency, over which the R&S Spectrum Rider performs the power measurement.

1. Press [MEAS] key.
2. Select "Channel BW" softkey.
The R&S Spectrum Rider opens a dialog box to specify the channel bandwidth for all channels.



3. Select the desired channel input field to change the bandwidth setting.
4. Enter the channel bandwidth you need.

5. Select "Done" to apply the changes.

The R&S Spectrum Rider sets the appropriate span for the channel bandwidth that you have entered according to the criteria described above. This ensures that no incorrect channel power measurements are made.

The minimum channel bandwidth that you can set is 833 Hz at a span of 1 kHz.

Setting the channel spacing

In the R&S Spectrum Rider, the channel spacing is defined as the distance between the center frequency of the transmission channel and the center frequency to the next transmission channel or the distance between the center frequency of the transmission channel and the center frequency of the adjacent channel.



Specific channel spacing definitions

Note that some radiocommunication standards, e.g. CDMA2000 DS / MC1 / MC3 and IS95 B / C, IS97 B / C, IS98 B / C, define the channel spacing differently, namely the distance from the center of the transmission channel to the closest border of the adjacent channel. The R&S Spectrum Rider does not consider these specifics. It always regards the channel spacing as the distance between the center of a channel and the center of its neighboring channel.

1. Press [MEAS] key.
2. Select "Channel Tx Spacing" softkey to define the transmission channel spacing or "Channel Adj Spacing" softkey to define the adjacent / alternative channel spacing.

The R&S Spectrum Rider opens a dialog box to define the spacing for all transmission channels or adjacent / alternate channels.

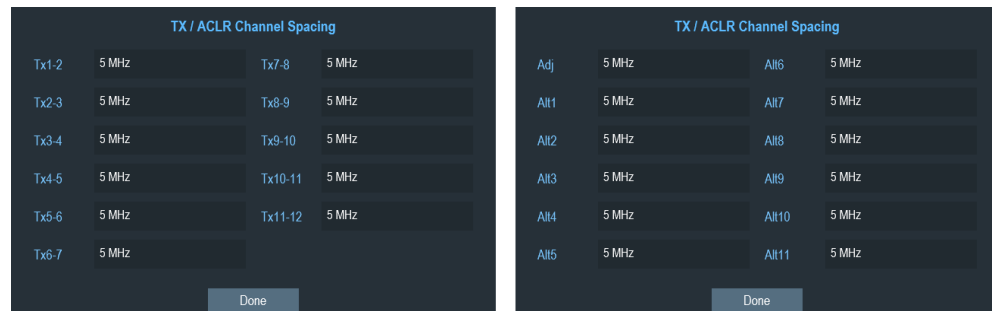

3. Select the desired channel input field to change the spacing bandwidth.
4. Enter the channel spacing you need.
5. Select "Done" to apply the changes.
The R&S Spectrum Rider now takes the new values into account for future measurements.

When performing measurements on multi-carrier signals, you can define the spacing of the transmission (Tx) channels to one another. By default, the R&S Spectrum Rider

assumes equal spacing between all Tx channels in the system. Therefore, the spacing you enter for the first two Tx channels is automatically applied to all other Tx channels.

If you do measurements on systems with a different channel spacing for each Tx channel, you can also set the channel spacing for each Tx channel separately by entering the respective number in the fields.

If the spacings are not equal, the channel distribution according to the center frequency is as follows:

- Odd number of TX channels
The middle TX channel is centered to center frequency.
- Even number of TX channels
The two TX channels in the middle are used to calculate the frequency between those two channels. This frequency is aligned to the center frequency.

Adjacent or alternate channel spacing is also available for single-carrier measurements. The R&S Spectrum Rider can perform measurements on up to 12 adjacent channels. Usually the first adjacent channel to the Tx channel is referred to as the adjacent channel (ADJ). All others are called alternate channels (ALT1 to ALT11).

By default, the R&S Spectrum Rider assumes that the distance of the adjacent channels to each other is the same. In that case, you only have to enter the first spacing value. The R&S Spectrum Rider then calculates all higher adjacent channels from that value. If you change the spacing of one of the higher channels, the R&S Spectrum Rider only updates the channel spacings above the one you have changed, but not those below.

6.1.6.3 Normalization of measurement results

By default, the power of the channels and adjacent channels is displayed in the unit dBm. It is also possible to display the power density of the signal to, for example, measure the signal/noise power density or obtain the signal to noise ratio.

1. Press [MEAS] key.
2. Select "Power Display" softkey
The R&S Spectrum Rider opens a submenu to select the power display settings.
3. Enable the "Channel Pwr/Hz" checkbox.
The R&S Spectrum Rider activates normalization and switches the unit from dBm to dBm/Hz.
The channel power density in dBm/Hz corresponds to the power inside a bandwidth of 1 Hz and is calculated as follows:
 - a) channel power density = channel power - log₁₀(channel bandwidth)

6.1.6.4 Displaying absolute and relative results

You can set up the result display to either show the absolute power of the adjacent channels or the power relative to one of the transmission channels.

1. Select "Power Display" softkey
The R&S Spectrum Rider opens a submenu to select the power display settings.
2. Select either the "Absolute" menu item to display the absolute results or the "Relative" menu item to display the power relative to one of the transmission channels.

6.1.6.5 Selecting the reference channel

When determining relative power values for the adjacent channels, you can set a specific transmission channel as the reference channel.

1. Press "Channel Settings" softkey.
The R&S Spectrum Rider opens a submenu to select the power display settings.
2. Select the "ACLR Ref Setting" menu item.
The R&S Spectrum Rider displays new softkeys to determine the reference channel.
The following methods are available:
 - "Tx Channel"
Select a specific transmission channel by entering its number as the reference.
 - "Min Pwr Tx Ch"
The channel with the lowest power level is the reference channel.
 - "Max Pwr Tx Chan"
The channel with the highest power level is the reference channel.
 - "Low High Chan"
The outer left-hand transmission channel is the reference channel for the lower adjacent channels. The outer right-hand transmission channel is the reference channel for the upper adjacent channels.
3. Select the desired softkey to determine the reference channel.

6.1.6.6 Setting and checking the limits

Limit checks in ACLR measurement mode are independent of limit line handling. You can define a limit for each of the adjacent channels. Limits for adjacent channels can be set either in absolute or relative terms.

Defining relative and absolute limits

1. Press [MEAS] key.
2. Select "Channel Settings" softkey.
The R&S Spectrum Rider opens a submenu to select the channel settings.
3. Select the "Channel Limit Relative" or the "Channel Limit Absolute" menu item.
The R&S Spectrum Rider opens a dialog box to define the relative or absolute limits for each adjacent channel.

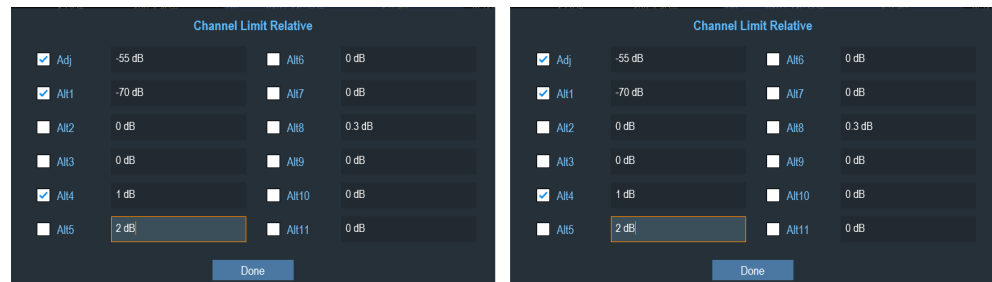

4. Select the desired channel input field to change the limit.
5. Enter the limit value you need.
6. Select the channel checkbox to activate the channel limit.
7. Select "Done" to apply the changes.
The R&S Spectrum Rider applies the limit checks on the ACLR measurement.
8. To deactivate the limit check for a specific channel, select the desired channel checkbox to deactivate it.

Performing a limit check

1. Select "Channel Settings" softkey.
The R&S Spectrum Rider opens a submenu to select the channel settings.
2. Select the checkbox for "Check Channel Limits" menu item.
The R&S Spectrum Rider automatically performs limit checks.
The results of the limit check are displayed in the [Measurement result view](#). If a result fails the limit check, the power level reading turns red and has an asterisk (*) in front of its power level.

```
Lower(dB)  * -44.8 * -45.1
Upper(dB)  * -44.1 * -45.2
```

6.1.6.7 Configuring and triggering the sweep

For more information on setting the sweep, see [Chapter 6.2.6.1, "Setting the sweep time"](#), on page 186 in frequency domain.

Equipped with option R&S Spectrum Rider-K57 (order number: 1321.1586.02), you can now perform gated trigger measurement. For more information on the trigger functionality, see [Chapter 6.2.6.3, "Working with trigger functionality"](#), on page 187 in frequency domain.

6.1.6.8 Using a trigger

For more information on using external trigger to trigger measurements, see ["External trigger"](#) on page 135.

6.1.7 Measuring the harmonic distortion

The Harmonic Distortion measurement is an easy way to identify the harmonics of a DUT. In addition to the graphic display of the harmonics, this measurement mode also calculates the Total Harmonic Distortion (THD) and shows the results.

You can perform a Harmonic Distortion measurement in frequency sweep (span > 0) and zero span mode (span = 0). When starting the measurement, the R&S Spectrum Rider looks for the first harmonic of the signal (= the highest signal) in the defined frequency range. It then adjusts the frequency axis so that all harmonics are visible. In zero span mode, the center frequency remains the same.

1. Press [MEAS] key.
2. Select "Meas Mode" softkey.
The R&S Spectrum Rider opens a submenu to select the measurement mode.
3. Select the "Harmonic Distortion" menu item.
The R&S Spectrum Rider starts to measure the harmonic distortion.

The search for harmonics starts as soon as you enter the Harmonic Distortion measurement. Upon entering the measurement, the R&S Spectrum Rider automatically adjusts the settings in order to display the selected number of harmonics (default = 2) on the screen.

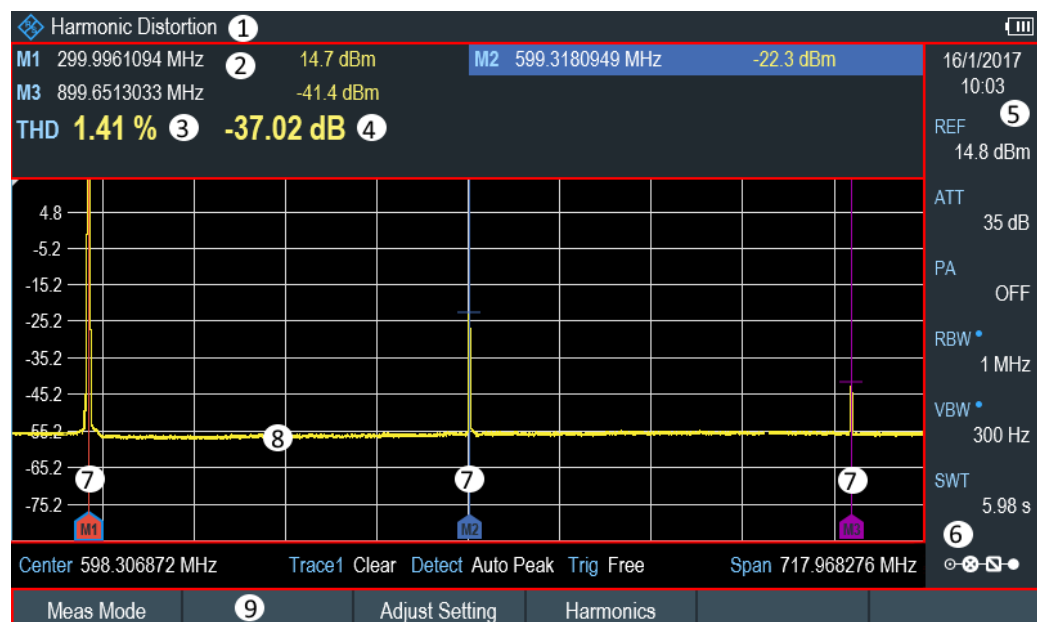

Figure 6-6: Screen layout for the harmonic distortion measurement

- 1 = Harmonics measurement mode
- 2 = Harmonics list
- 3 = Total harmonics distortion in %
- 4 = Total harmonics distortion in dB
- 5 = [Parameter view](#)
- 6 = [Configuration overview](#)

- 7 = Markers indicating harmonics (blue lines)
- 8 = Trace
- 9 = Harmonic distortion softkey menu

6.1.7.1 Defining the number of harmonics

By default, the R&S Spectrum Rider shows the signal and its first harmonic. Each harmonic is indicated by a marker that the R&S Spectrum Rider places on the harmonic (here M1 and M2). Note that all of the markers that have been set are normal markers that show the absolute frequency of the harmonic.

At the same time, the R&S Spectrum Rider also calculates the values for the total harmonic distortion (THD) and shows the results in a box above the trace diagram. The values are output in % and dB.

If you want to see more than one harmonic, the R&S Spectrum Rider can show up to six harmonics.

1. Press [MEAS] key.
2. Select "Harmonics" softkey.
The R&S Spectrum Rider opens an input field to define the number of harmonics.
3. Enter the number of harmonics you would like to see.

6.1.7.2 Optimizing the display of harmonics

The R&S Spectrum Rider places the markers on the other harmonics even if they are outside of the display range.

1. Press [MEAS] key.
2. Select "Adjust Settings" softkey.
The R&S Spectrum Rider performs a measurement to determine the ideal reference level, frequency and span in order to display all harmonics.

6.1.7.3 Activating the harmonics list

To see the exact frequency of the harmonic, you can activate the marker list that shows the value for each harmonic or marker.

1. Press [MARKER] key.
2. Select "Set Marker" softkey.
The R&S Spectrum Rider opens a submenu to set the view list.
3. Select the checkbox for the "View List" menu item.
The R&S Spectrum Rider displays the marker list that contains the values for each harmonic.

6.1.7.4 Using a trigger

For more information on using external trigger to trigger measurements, see ["External trigger"](#) on page 135.

6.1.8 Measuring the AM modulation depth

The AM Modulation Depth measurement analyzes AM modulated signals and calculates the modulation depth of the signal using the measurement results. Note that the measurement works properly only if you apply an AM modulated signal.

1. Press [MEAS] key.
2. Select "Meas Mode" softkey.
The R&S Spectrum Rider opens a submenu to select the measurement mode.
3. Select the "AM Modulation Depth" menu item.
The R&S Spectrum Rider starts to measure the AM modulation depth.

After you have started the measurement, the R&S Spectrum Rider places three markers on the trace. The first marker is placed on the peak power level. The R&S Spectrum Rider assumes that position as the level of the carrier. The second and third markers are delta markers. These are placed symmetrically on the adjacent peak values to the left and right of the carrier.

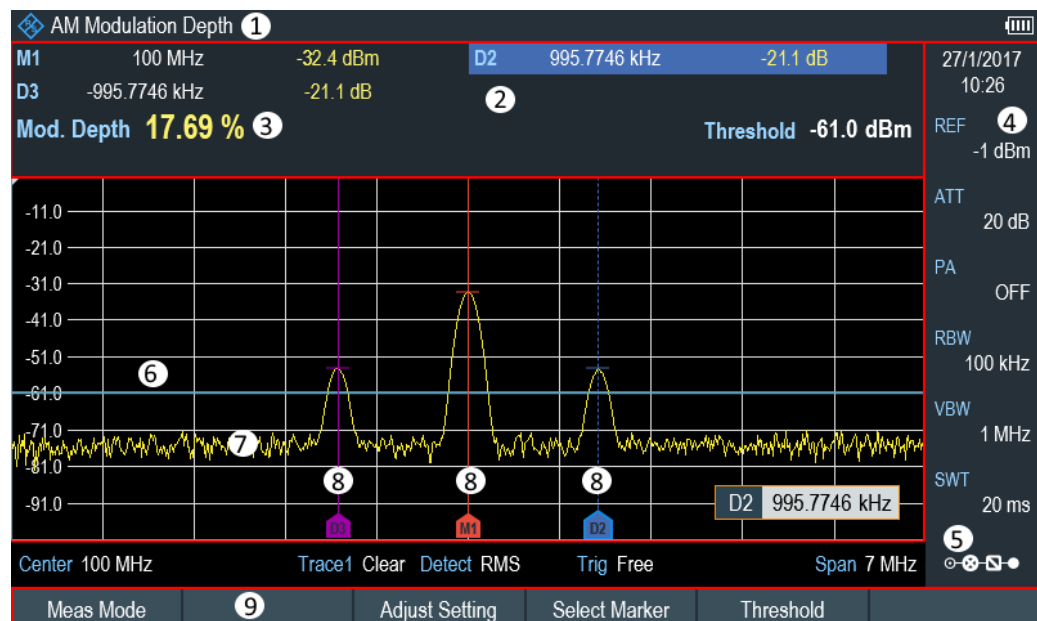

Figure 6-7: Screen layout for the AM modulation depth measurement

- 1 = AM modulation depth measurement mode
- 2 = [Measurement result view](#)
- 3 = Modulation depth
- 4 = [Parameter view](#)
- 5 = [Configuration overview](#)

- 6 = Threshold line (blue line)
- 7 = Trace
- 8 = Markers
- 9 = AM modulation depth softkey menu

By default, delta marker 2 is active for editing. If you move the delta marker to another position, the other delta marker will be moved by the same distance relative to the normal marker. Note that this happens only if you move delta marker 2 (D2). When moving delta marker 3 (D3), only this marker is repositioned.

From the values of the markers, the R&S Spectrum Rider then calculates the AM modulation depth. The AM modulation depth is the ratio between the power values at the reference marker and at the delta markers. When the powers of the two AM side bands are not the same, the R&S Spectrum Rider uses the mean value of the two sideband values.

If the R&S Spectrum Rider is unable to find any AM modulated carriers, it shows the message:



No AM modulated carrier found.

6.1.8.1 Setting a threshold

You can set a threshold that defines the minimum power level the signal must have. If the power of the signal is below the threshold, the R&S Spectrum Rider will not set the markers and therefore will not calculate the modulation depth.

1. Press [MEAS] key.
2. Select "Threshold" softkey.
The R&S Spectrum Rider opens an input field to set the threshold.
3. Enter the threshold value you need.
The threshold is represented as a horizontal blue line in the diagram area.

6.1.8.2 Optimizing the settings

To get the best results, you can use the automatic adjustment routine that the R&S Spectrum Rider offers.

1. Press [MEAS] key.
2. Select "Adjust Setting" softkey.
The R&S Spectrum Rider performs a sweep and repeats the peak search sequence for the three markers.

6.1.8.3 Activating the marker list

To see the exact frequency of the carrier and its sidebands, you can activate the marker list that shows the value for each marker.

1. Press [MKR] key.
2. Select "Set Marker" softkey.
The R&S Spectrum Rider opens a submenu to select the marker function.
3. Select the checkbox for "View List" menu item.
The R&S Spectrum Rider displays the marker list that contains the values for carrier and sideband.

6.1.8.4 Using a trigger

For more information on using external trigger to trigger measurements, see ["External trigger"](#) on page 135.

6.1.9 Working with the spectrogram result display



R&S Spectrum Rider option

R&S FPH-K15 (order number: 1321.0715.02) option is required to operate the R&S Spectrum Rider in the interference analysis mode.

For more information, see [Chapter 11, "Interference analyzer"](#), on page 256.

Equipped with option R&S FPH-K15, you can view measurement results in a spectrogram.

The spectrogram result display shows the spectral density of a signal in the frequency domain and over time simultaneously.

Like other result displays, the horizontal axis represents the frequency span. The vertical axis represents time. Time in the spectrogram runs chronologically from top to bottom. Therefore, the top of the diagram is the present. A third dimension shows the amplitude for each frequency by mapping different colors to every power level. The result is therefore a two-dimensional diagram.

The color the R&S Spectrum Rider assigns to a power level that was measured depends on:

- Color table
- Spectrogram reference level
- Spectrogram level range

The spectrogram consists of horizontal lines, each of one pixel height, which is called frames. In the default state, a frame is added to the spectrogram after each sweep. This means that the amount of data in a frame depends on the sweep time. As the spectrogram in the R&S Spectrum Rider runs from top to bottom, the outdated time-

line moves down one position, so that the present frame is always on top of the diagram.

Therefore, the sequence of frames is chronological.

1. Press [MEAS] key.
2. Select "Meas Mode" softkey.
The R&S Spectrum Rider opens a submenu to select the measurement mode.
3. Select the "Spectrogram" menu item.
The R&S Spectrum Rider starts the spectrogram result display.

By default, the spectrogram result display consists of two windows. The upper window shows the measured spectrum as a trace line. The lower window shows the measurement results in a spectrogram. The chronological information in the spectrogram is restricted by the internal memory of the R&S Spectrum Rider. The R&S Spectrum Rider stores 1024 frames or spectrums that have been measured in its memory. As the height of the display is smaller, some of the data becomes invisible after a time.

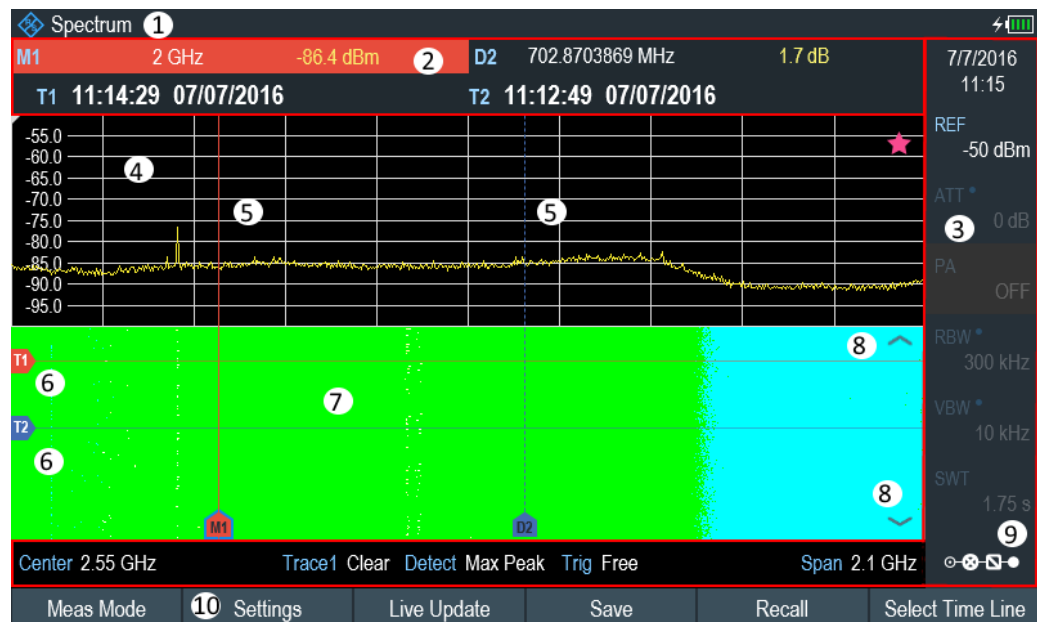

Figure 6-8: Screen layout for the spectrogram

- 1 = Operating mode
- 2 = [Measurement result view](#)
- 3 = [Parameter view](#)
- 4 = Spectrum result display (optional)
- 5 = Marker / delta marker (vertical lines)
- 6 = Time lines T1 and T2 (horizontal lines)
- 7 = Spectrogram
- 8 = Scroll direction
- 9 = [Configuration overview](#)
- 10 = Spectrogram softkey menu

6.1.9.1 Controlling the spectrogram update

The spectrogram starts running when you enter the spectrogram mode. By default, the spectrogram is running in a continuous sweep mode.

If you are in single sweep mode, the R&S Spectrum Rider does not add a line to the spectrogram until you initiate the next single sweep.

You can stop the update of the spectrogram in continuous sweep mode.

1. Press [MEAS] key.
2. Select "Hold" softkey.
Note that in continuous sweep mode, the measurement in the spectrum result display does not stop. The trace in the upper window still updates continuously but the spectrogram view stops.
3. Select "Hold" softkey again.
The R&S Spectrum Rider resumes updating the spectrogram.

The spectrogram result display is filled with results until you change a measurement setting. When a setting is changed, the spectrogram clears the existing result and starts to fill again.

You can also clear the spectrogram manually.

1. Press [MEAS] key.
2. Select "Clear" softkey.

Couple spectrogram level and range settings to spectrum

Changes in the spectrogram level and range can also be reflected in the spectrum mode and vice versa.

1. Press [MEAS] key.
2. Select "Settings" softkey.
3. Select "Display" softkey.
4. Select "Couple to Spectrum" menu item to enable the checkbox.
The R&S Spectrum Rider menu item is marked by an [X].
The spectrogram reference level and level range are now coupled to the spectrum.

6.1.9.2 Browsing through the signal history

There are two ways to view parts of the measurement result history that have moved outside the visible area of the spectrogram.

1. Press [MEAS] key.
2. Select "Settings" softkey.

3. Select "Display" softkey.
The R&S Spectrum Rider opens a submenu that contains the display settings for selection.
4. Select the "Full Screen" menu item to enable the checkbox.
The R&S Spectrum Rider menu item is marked by an [X].
The R&S Spectrum Rider now uses the full diagram area of the screen for the spectrogram. The number of lines in the spectrogram and therefore the displayed time period now becomes more than doubles.
5. To evaluate the measurement result, scroll up and down on the spectrogram scrollbar icon (see index 8 of [Figure 6-8](#)) to the frame that you are interested to view.

Scrolling through the spectrogram

Swipe up or down vertically in the spectrogram window to view the spectrogram history.

Alternatively, you can use the keypad [2] and [8] on the R&S Spectrum Rider to scroll through the spectrogram history.

The scrollbar icon on the right side of the spectrogram indicates the position of the spectrogram part currently displayed on the screen:

- A single down arrow in the right lower corner of the spectrogram indicates that the uppermost frame still represents the most recently recorded trace.
- Two arrows (one up, one down) indicate that the spectrogram area displayed is somewhere in the middle of the available history.
- A single up arrow in the upper right corner of the spectrogram indicates that the lowest line of the spectrogram represents the end of the history buffer.

6.1.9.3 Configuring the display

As colors are an important part of the spectrogram, the R&S Spectrum Rider offers various ways to customize the display for best viewing results.

The first and most obvious way to configure the display is to select a different color scheme.

1. Press [MEAS] key.
2. Select "Settings" softkey.
3. Select "Display" softkey.
The R&S Spectrum Rider opens a submenu that contains the display settings for selection.
4. Select the "Color Table" menu item.
The R&S Spectrum Rider opens a submenu that contains several color schemes.
 - "Default"
 - "Green-Yellow"
 - "Green-Blue"

- "Black-White"
- "Red-Purple"
- "Blue-Black"

The following examples are based on the "Green-Blue" color scheme.

1. Select the color scheme that you are most comfortable with.

The R&S Spectrum Rider adjusts the screen colors according to your selection.

It is possible that the color distribution is not ideal in the current configuration.

There are two important parameters that are required to adjust for an optimal spectrogram display.

- Reference level

By adjusting the reference level, you can eliminate amplitudes from the color map that are not part of the signal.

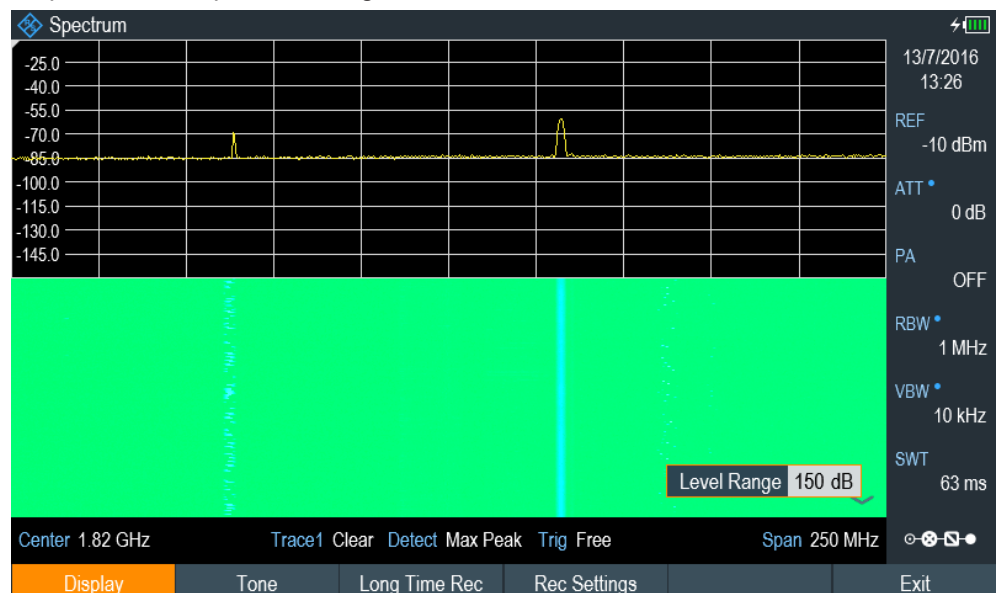

Example: If a spectrogram reference level is at -10 dBm, the signal parts with an amplitude of -10 dBm would be blue in the spectrogram. For signal parts with a very small amplitude, it is dark green. Everything in between is a shade of the colors between. As the colors are distributed over a very large range (150dBm), it is likely that you cannot distinguish details in the signal that you have measured.

Therefore, you should adjust the color map to the overall shape of the signal that you are measuring. With the maximum amplitude of about -45 dBm and the minimum amplitude of about -85 dBm, the amplitude range is about 40 dB. With these settings in a "Green-Blue" color scheme, the spectrogram is made up exclusively of green colors and it's not easy to distinguish amplitude levels. To get a better result, change the spectrogram reference level to a level near the maximum power level that has been measured first.

2. Select "Display" softkey.

The R&S Spectrum Rider opens a submenu that contains the display settings for selection.

3. Select the "Reference Level" menu item.

The R&S Spectrum Rider opens an input field to define the reference level.

The reference level should be near the maximum level that has been measured while the spectrogram was running. In the example, the reference level should be at about -40 dBm.

4. Enter the reference level.

The R&S Spectrum Rider now shifts the reference level of the spectrogram to the value that you have entered.

Note that the spectrogram reference level does not affect the spectrum result display, and the spectrum reference level ("Amplitude" menu) does not affect the spectrogram. In the screenshot, the spectrum trace is therefore exactly the same as in the previous picture.

The result however, still does not show signal differences in detail. The only thing that happened is that the colors have shifted, in the example to yellow, because the color that corresponds to the reference level has shifted from green to blue. All other colors that are part of the color scheme are still unused, because the spectrogram level range is still the same (150 dB).

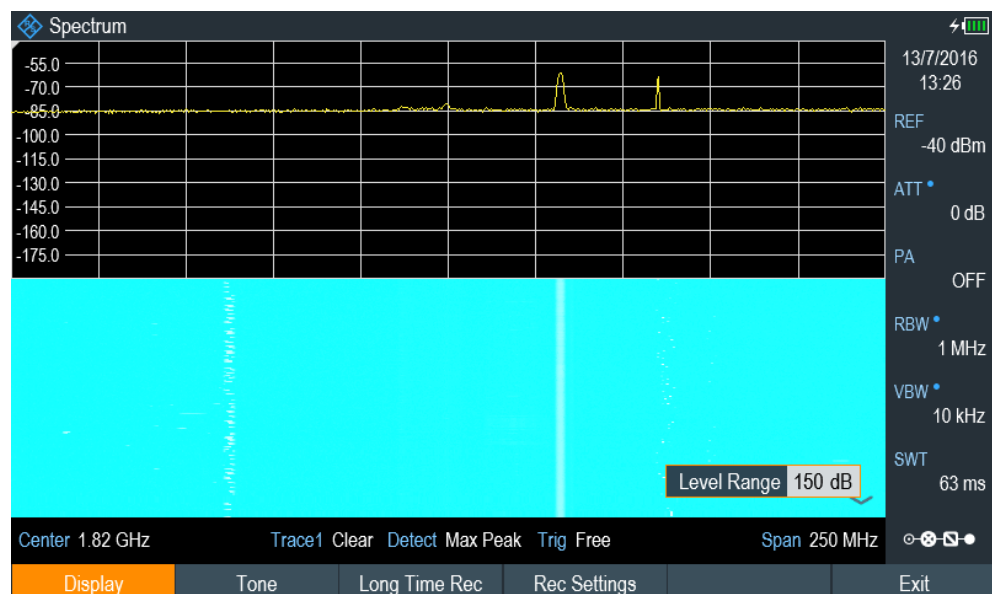

5. Select "Display" softkey.

The R&S Spectrum Rider opens a submenu that contains the display settings for selection.

6. Select the "Level Range" menu item.

The R&S Spectrum Rider opens an input field to define the level range.

In this example, the level range of the signal is from about -45 dBm to about -85dBm which is about 40dB to 45dB.

7. Set "Level Range" to 45 dB.

The level range is now adjusted, the R&S Spectrum Rider is able to map its complete color range to the level range of the signal.

The USB signal parts with a low amplitude are in a shade of green while signal parts with a high amplitude are blue.

The best way to display a spectrogram is therefore to reduce the level range until the lowest signal part is mapped to the lower end of the color map and the highest signal part to the upper end of the color map.

In a last step, you can configure the spectrogram in a way that it only shows signal peaks in color and the noise floor in black. To get such a result, you have to reduce the level range, until the noise floor is outside the displayed range.

8. Instead of entering a level range of 45 dB, enter a level range of 40 dB.

This level provides a high contrast between signal parts that are above the noise floor that is drawn in black.

To show details of the noise floor and exclude the peak levels, you have to lower the spectrogram reference level until it is just above the noise floor.

The R&S Spectrum Rider will then display the signal parts that are above the reference level in only one color, which is the color at the upper border of the color map.

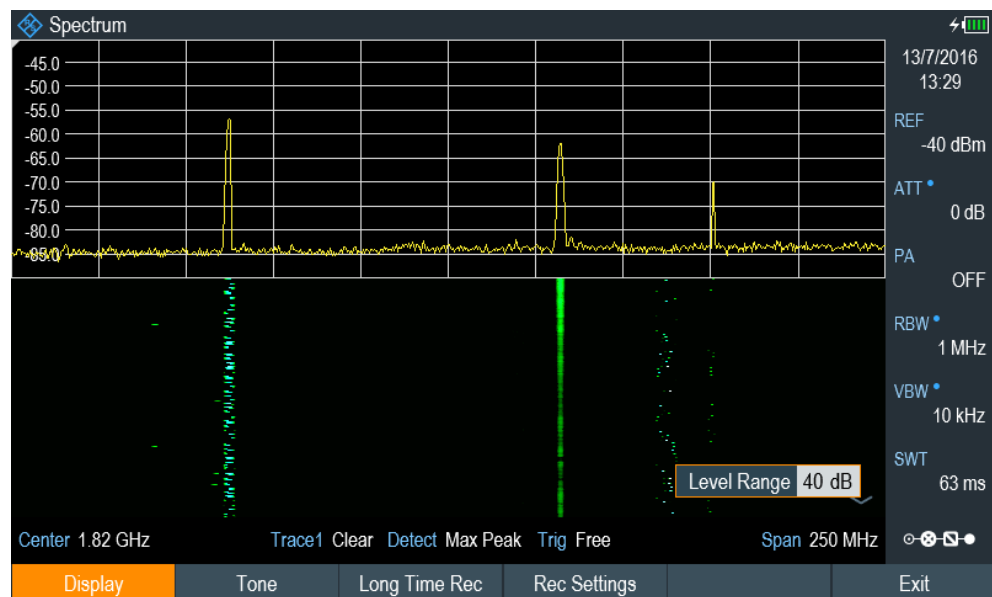

Auto range

Alternatively, you can perform an auto range action to adjust the reference range and the reference level of the spectrogram for optimal display.

1. Press [MEAS] key.
2. Select "Settings" softkey.
3. Select "Display" softkey.

The R&S Spectrum Rider opens a submenu that contains the display settings for selection.

4. Select "Auto Range" softkey.

The R&S Spectrum Rider performs an auto range to adjust the reference range and the reference level of the spectrogram for optimal display.

Note: The auto range function shows a reference level of -18.8dBm and level range of 84.3581dB for the above example.

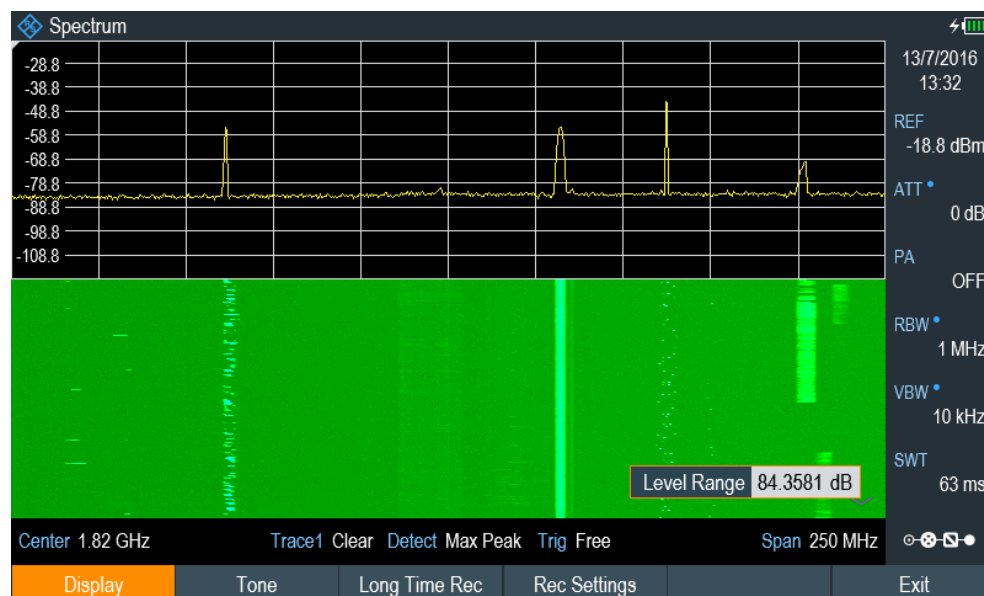

6.1.9.4 Recording a spectrogram

You can save the data of the spectrogram for documentation or for further analysis of the recorded data.

1. Press [MEAS] key.
2. Select "Settings" softkey.
3. Select "Rec Settings" softkey.

The R&S Spectrum Rider displays a dialog box to configure the recording parameters for spectrogram.

Long Time Recording Settings

Recording Mode	Immediately	Limits Save Mode	Start on Failure
Recording Speed	Max	Recording Interval	13 ms
Start Date	07/07/2016	Start Time	17:14
Stop Date	07/07/2016	Stop Time	17:15
Storage	USB	Duration (hhh:mm) up to 003:41	000:01
Stop Recording if Battery Low	On		

OK Start

Figure 6-9: Long time recording settings dialog box

Long time recording settings	Descriptions
"Recording Mode"	<p>There are three selections for the recording mode: "Timer", "Immediately" and "Limits Failure"</p> <p>When "Long Time Recording Settings" is enabled with recording mode "Timer", the configured "Start Date"/ "Start Time" and "Stop Date"/ "Stop Time" and "Duration" determine the time window in which the spectrogram data is recorded. The setting for "Limits Save Mode" is disabled.</p> <p>When "Long Time Recording Settings" is enabled with recording mode "Start Immediately", spectrogram data recording starts immediately and "Duration" determines when the recording of the spectrogram data stopped. The settings of "Start Date", "Start Time" and "Stop Date" and "Stop Time" is disabled.</p> <p>When "Long Time Recording Settings" is enabled with recording mode "Limits Failure", the "Limits Save mode" determines when data is recorded. The settings for "Start Date", "Start Time" and "Stop Date" and "Stop Time" is disabled.</p> <p>By default, "Timer" is selected.</p>
"Recording Speed"	<p>There are two selections for the recording speed: "Max" and "Manual".</p> <p>If recording speed is set to "Manual", the recording interval is configurable.</p> <p>By default, "Max" is selected.</p>
"Start Date"	Start date format: dd/mm/yy.
"Stop Date"	Stop date format: dd/mm/yy.
"Storage"	<p>Two storage types are supported: "Storage Card" and "USB".</p> <p>By default, "USB" is selected.</p>

Long time recording settings	Descriptions
"Stop Recording if Battery Low"	The recording of the spectrogram data is stopped and an automatic save of the recorded spectrogram data is performed when a battery low detection is triggered. By default: "On" is selected.
"Limits Save Mode"	There are three selections for the limits save mode: "Start on Failure", "Stop on Failure" and "Save only Failures". By default, "Start on Failure" is selected. When "Start on Failure" is selected, the spectrogram data recording starts with the first detected failure and stops when manually stopped or storage is full. When "Stop on Failure" is selected, the spectrogram data recording starts immediately and the detection of a failure determines the moment the recording is stopped. The failure trace is the last trace stored in the spectrogram file. When "Save on Failures" is selected, the spectrogram data recording of only failures starts immediately and stops when manually stopped.
"Recording Interval"	This is only configurable when the "Recording Speed" is set to "Manual". It is the time difference taken between two traces of saved spectrogram data. The minimum recording interval is the current sweep time and maximum recording interval is 1000s.
"Start Time"	This is only configurable when the "Recording Mode" is set to "Timer". When the "Recording Mode" is set to "Immediately", the "Start Time" is set to current time. Start time format: "hhh:mm".
"Stop Time"	This is only configurable when the "Recording Mode" is set to "Timer". When the "Recording Mode" is set to "Immediately", the "Stop Time" is set to current time + duration. Stop time format: "hhh:mm".
"Duration (hhh:mm) up to 003:41"	This is only configurable when the "Recording Mode" is set to "Timer" or "Immediately". The maximum duration is displayed before the recording is started. The maximum value for the duration is 999:59 or the maximum duration possible on the storage medium if there is insufficient memory is available for this maximum value. Duration format: "hhh:mm" (e.g. 072:00 for 72 hours).
"OK"	Press "OK" to apply the configuration for spectrogram recording.
"START"	Press "START" to apply the configuration and immediately starts the spectrogram recording.

4. Select "OK" to apply the configurations for the spectrogram recording.
5. If you want to start the spectrogram recording immediately, select the "Start" button.

The R&S Spectrum Rider immediately starts the spectrogram recording.

Note1: There is a recording icon  on the top right corner of the spectrum to indicate that the spectrogram recording is in process.

Note2: The recording of the spectrogram data stops according to the settings configured in [Figure 6-9](#).

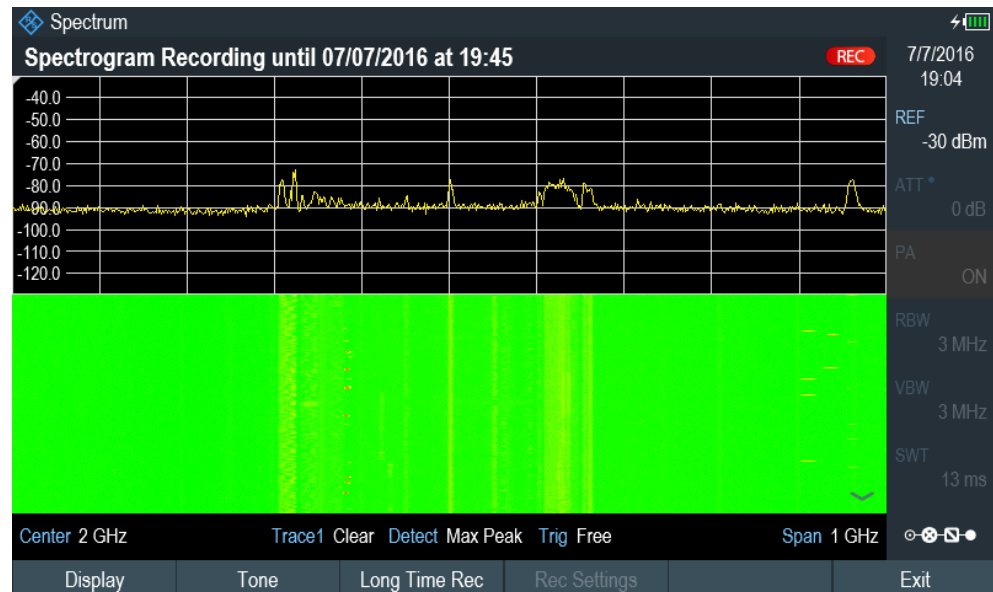

Figure 6-10: Spectrogram recording

6. If you want to stop the spectrogram recording prematurely, press the "Long Time Rec" softkey.
7. When the recording completes, the spectrogram recording data is automatically saved in the folder:
Spectrogram Recording results>SPG_yyyymmdd_hhmmss>SPG_###.spm
with ascending numbers.
The R&S Spectrum Rider displays "Recording successfully completed" with information of the recorded spectrogram data stored.

Storing spectrogram SPG_001.spm



Recording successfully completed

Results saved in \USB\Spectrogram Recording Results\SPG_20160711_142526

After the spectrogram is saved, you can replay it any time you want. The number of spectrograms that you can store on the R&S Spectrum Rider internal memory depends on the other datasets that are currently on the R&S Spectrum Rider.

8. Alternatively, you can start a spectrogram recording at anytime. Press [MEAS] key.
9. Select "Settings" softkey.

10. Select "Long Time Rec" softkey to start a spectrogram recording.

6.1.9.5 Playback of a spectrogram

If you have recorded a spectrogram and save it in the internal memory of the R&S Spectrum Rider , a USB stick or an SD card, you can view the results of that measurement later.

1. Select "Playback" or "Meas Mode " softkey.
2. Select "Spectrogram Playback" menu item.

Recalling a previously stored spectrogram

1. Select "Recall" softkey.
A list of all saved data sets open.
Go to the "storage media > Spectrogram Recording Results" and select the spectrogram recorded data ending with a *.spm filename extension.
2. Confirm your selection with "Load" softkey.
The R&S Spectrum Rider loads the spectrogram and shows the data in the display. In general, you can perform the same things on a recalled spectrogram as in the spectrogram recording mode, e.g. customize the display to your needs. In addition to that functionality, it is possible to view not only the spectrum that belongs to the currently selected spectrogram frame, but also the spectrum of all frames that are in the memory.

Working with time lines in playback mode

To find a particular point in time and display the corresponding spectrum, you can use two time-lines (T1 and T2):

When entering the playback mode, the R&S Spectrum Rider displays the two time-lines in the spectrogram.

The first time-line (T1) corresponds to an absolute time value, the second time-line (T2) is a time relative to the first time-line. Both time-lines are positioned on the most recent spectrogram line at the top of the result display. (Note in this example that the second time-line (T2) is hidden behind the first time-line (T1)).

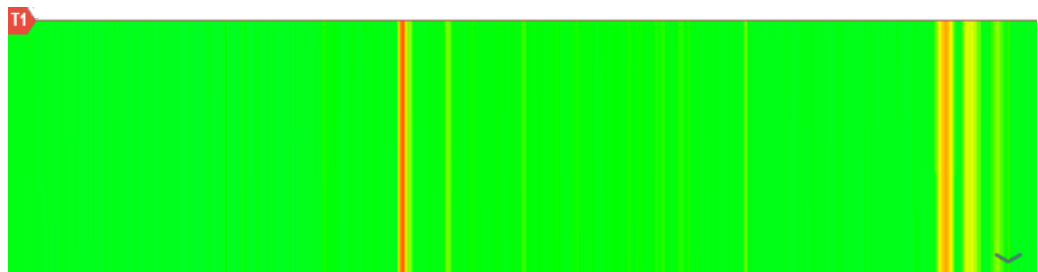

You can now select a specific spectrogram frame that is in the memory of the R&S Spectrum Rider.

1. Select "Select Time Line" softkey.
The R&S Spectrum Rider opens an input field to define the position of the first time-line (T1).
2. Position the time line by entering a number or moving it with the rotary knob.
Entering the value "0" sets the time line marker on the most recent frame. The maximum value that you can enter is "1024". This is the maximum number of frames that the R&S Spectrum Rider can store in its memory.
Note that not all frames are visible on the screen. If a frame is part of the history outside the visible area, the time line is also not visible and you have to scroll through the spectrogram to be able to see it again. See "[Scrolling through the spectrogram](#)" on page 155.

The upper window displays the spectrum of the frame at the time-line position. By moving the time-line, you can thus browse through the history of spectra stored in memory.

In the marker information field, the R&S Spectrum Rider shows the timestamp of the time-line.

The timestamp of the first time-line (T1) is always referred to the top-most frame (e.g. a timestamp of 00:00:50:000 means that the data was measured 50 seconds before the topmost frame).

1. Select "Select Time Line" softkey again.
The R&S Spectrum Rider opens an input field to define the position of the second time-line (T2).
2. Enter a number with the number keys or use the rotary knob to adjust the time line.
The R&S Spectrum Rider positions the second time line on the selected frame. Again it shows the timestamp of the time line in the marker information field (ΔT value). For the second time line (T2), the information is relative to the first one (T1). This means that the timestamp of the second time line can be negative, if you have set it on a frame above the first time-line.

If you scroll the time line through the frames of the spectrogram with the rotary knob, the R&S Spectrum Rider shows the spectrum corresponding to the selected frame in the upper window of the display.

You can use the spectrogram playback for a detailed analysis of the signal levels over time and compare signal details in the spectrum result display, e.g. with the help of markers.

In addition to the time line (horizontal marker), you can also use (vertical) markers in the spectrogram.

With the help of the marker and the time line, you are able to find the exact moment when a specific event has occurred in the spectrum.

1. Press [MARKER] key.
The R&S Spectrum Rider activates a marker and sets it on the peak level of the currently displayed spectrum.

- Use the rotary knob to move the marker on the horizontal axis to the frequency you want to analyze or enter the frequency directly with the number keys.
- Select "Select Time Line" softkey and browse through the spectrums using the rotary knob until the spectrum of interest is displayed in the upper window. The timestamp of the selected time-line gives you a precise indication on when the event shown in the spectrum occurred.

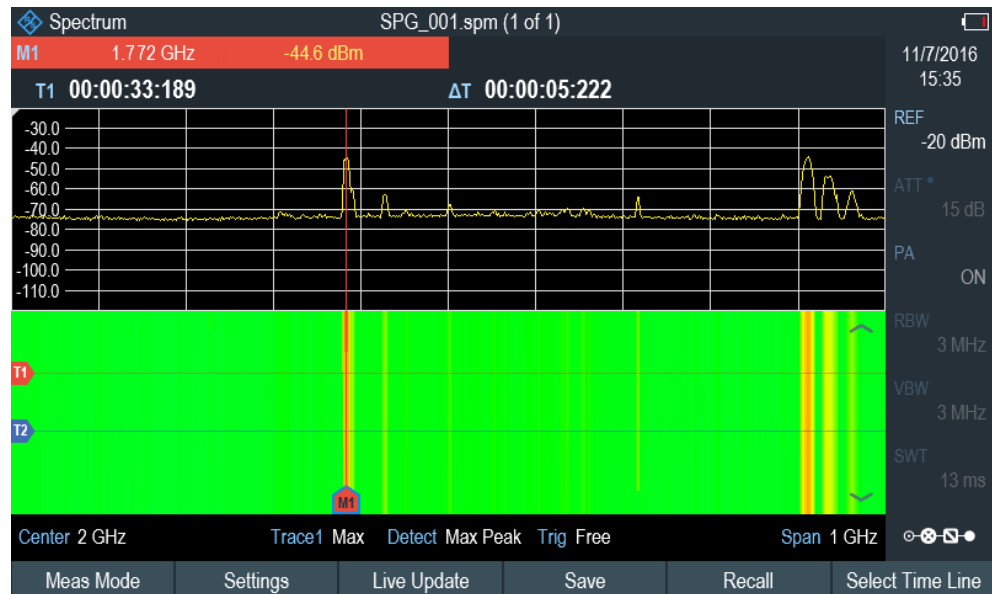

For more information on marker functionality, see [Chapter 6.2.8, "Using markers"](#), on page 196.

Switching back to active spectrogram recording

To resume recording of a new spectrogram:

- ▶ Select "Live Update" softkey at any time you are in playback mode. The R&S Spectrum Rider switches back to perform live measurements.

6.1.9.6 Configuring and triggering the sweep

For more information on setting the sweep, see [Chapter 6.2.6.1, "Setting the sweep time"](#), on page 186.

For more information on the trigger functionality, see [Chapter 6.2.6.3, "Working with trigger functionality"](#), on page 187.

6.1.10 Using isotropic antennas

The R&S Spectrum Rider supports measurements with an isotropic antenna.

Depending on the measuring frequency requirement, you can order the isotropic antenna in the following list:

- R&S TSEMF-B1, 30 MHz to 3 GHz (order number: 1074.5719.02)
- R&S TSEMF-B2, 700MHz to 6 GHz (order number: 1074.5702.02)
- R&S TSEMF-B3, 9kHz to 200 MHz (order number: 1074.5690.02)

To work with the isotropic antenna, you need a USB adapter (TSEMF-CV, order number 1158.9250.02) to connect the antennas control cable via the USB interface of the R&S Spectrum Rider.

Test setup

The test setup consists of an R&S Spectrum Rider and one of the isotropic antennas. The necessary cables are provided with the antennas.

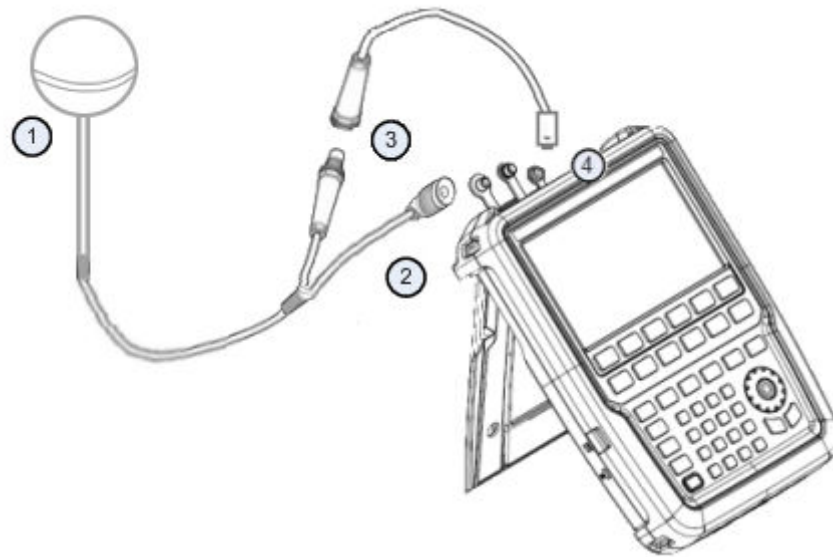

- 1 = Supported isotropic antenna (e.g. R&S TSEMF-B12)
- 2 = Isotropic RF connector
- 3 = USB adapter TSEMF-CV connecting to the isotropic antenna control cable
- 4 = USB port connector

1. Connect the RF cable with the N coaxial connector to the RF input port.
2. Connect the antenna control cable to the USB interface of the R&S Spectrum Rider via the USB adapter TSEMF-CV.
If the R&S Spectrum Rider detects the isotropic antenna, the accessory name "Isotropic Antenna" is displayed in the [title bar](#).

Start the measurement

1. Press [MEAS] key.
2. Select "Meas Mode" softkey.
The R&S Spectrum Rider opens a submenu to select the measurement mode.
3. Scroll down the submenu to select the "Iso Direction [Auto]" menu item.

If you have turned on the isotropic antenna before selecting the "Iso Direction [Auto]" menu item, the R&S Spectrum Rider uses the isotropic antenna for all measurements.

If the isotropic antenna is connected after the selection of "Iso Direction [Auto]" menu item, select "Enabled" to load and initialize the driver and establish communication with the antenna.

Note: When you turn on the isotropic antenna without selecting a transducer factor, the R&S Spectrum Rider displays the file manager dialog to select a transducer factor. When the isotropic antenna is turned off, the transducer factor is unloaded.

Using transducer factors

The isotropic antenna is like a transducer. It has a characteristic frequency response and it is necessary to correct the measurement results by these characteristics.

The transducer factors (*.isotrd) for each of the supported isotropic antennas are provided with the R&S Spectrum Rider. The factors contain typical correction values for all three antenna elements and the correction values for the cable.

1. Press [AMPT] key.
2. Select "Transducer" softkey.
3. Select the "Select Primary" menu item.
The R&S Spectrum Rider opens a file manager dialog box to select the transducer factor.
4. Select the transducer factor you need.
The R&S Spectrum Rider shows the name of the active transducer on the display (e.g. "Pri Tran TSEMF-B2_typical").

If you are using the extension cable (R&S TS-EMFZ2, order number: 1166.5708.04), you have to take this into account as a secondary transducer.

1. Press [AMPT] key.
2. Select "Transducer" softkey.
3. Select the "Select Secondary" menu item.
The R&S Spectrum Rider opens a file manager dialog box to select the transducer factor with the unit dB.
4. Select the transducer factor for the extension cable.
The R&S Spectrum Rider shows the name of the active transducer on the display (e.g. "Sec Tran TSEMFZ2").

For more information, see [Chapter 6.4, "Using transducer factors"](#), on page 212.

You can create and edit transducer factor with the R&S InstrumentView software package and then transfer them into the internal memory of the R&S Spectrum Rider. Each transducer factor can consist of up to 1000 reference values.

Display of the antenna directions

An isotropic antenna consists of three orthogonal elements. Each of these elements measures the field strength from a different direction (x-, y- and z-axis).



Decrease of measurement speed

The R&S Spectrum Rider performs a measurement on each of the three antenna axes, the update rate of the results decreases slightly.

You can select to display different aspects of the measurement.

1. Select "Meas Mode" softkey.
2. Select the "Isotropic Antenna" menu item.
The R&S Spectrum Rider opens a new menu to select the measurement aspect.
 - "Auto"
Shows the total field strength over all three antenna axes.
The displayed result is a combination of the results for each antenna element. After measuring each of the three directions individually, the R&S Spectrum Rider calculates the total field strength (E_r) based on the results for each antenna element.
$$E_r = \sqrt{(E_x^2 + E_y^2 + E_z^2)}$$
 - "X"
Shows the field strength measured on the antenna's x-axis only.
 - "Y"
Shows the field strength measured on the antenna's y-axis only.
 - "Z"
Shows the field strength measured on the antenna's z-axis only.

6.1.11 Measuring the effective isotropic radiated power

The R&S Spectrum Rider supports EIRP measurement. Using the directional antenna (e.g. R&S HE300 or R&S HE400), the R&S Spectrum Rider is capable to calculate the EIRP measurement for antennas. For a list of supported directional antennas, refer to the data sheet.

EIRP calculation

With the given parameters, it is possible to calculate the EIRP using the following simplified equation:

$EIRP_{dB} = \text{Measured channel power (excluding antenna gain and cable loss)} - \text{received antenna gain} + \text{received cable loss} + FSPL_{dB}$ (free space path loss)

FSPL calculation

$FSPL_{dB}$

$$\begin{aligned}
 &= 10 \log_{10} ((4\pi df / c)^2) \\
 &= 20 \log_{10} (d) + 20 \log_{10} (f) + 20 \log_{10} (4\pi/c) \\
 &= 20 \log_{10} (d) + 20 \log_{10} (f) - 147.55
 \end{aligned}$$

Test setup

The following illustrates the typical test setup to conduct the EIRP measurement.

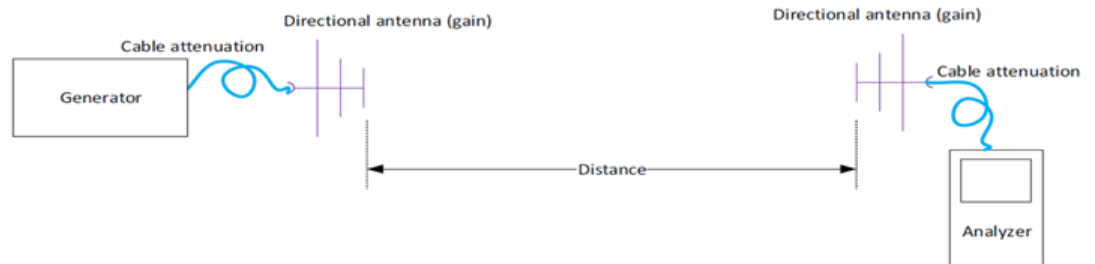
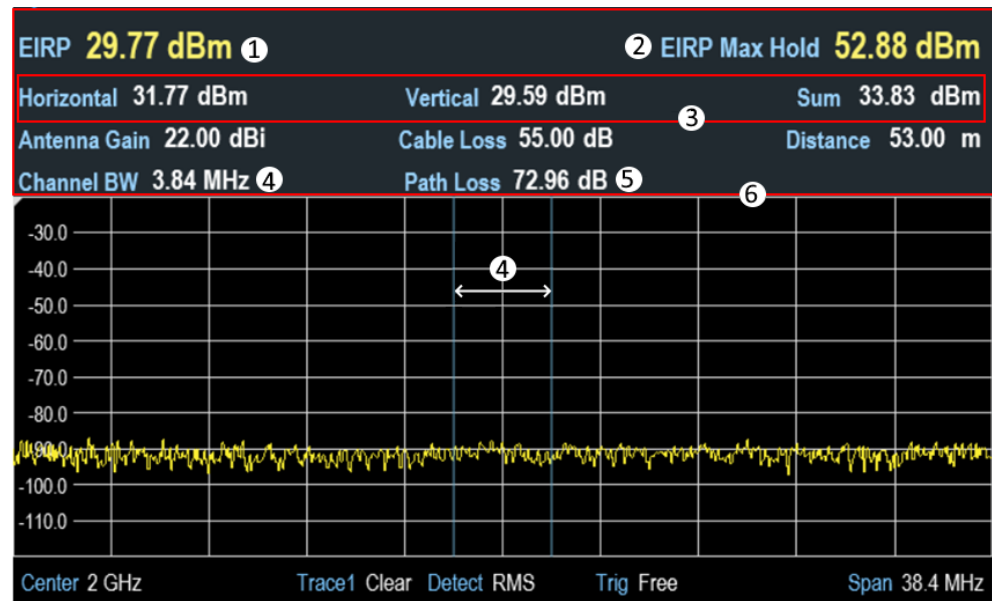

Figure 6-11: Test setup for EIRP measurement

1. Connect the RF cable with the N coaxial connector to the RF input port.
2. Connect the antenna control cable to the USB interface of the R&S Spectrum Rider via the USB adapter R&S HE300USB.
For a list of supported directional antennas, see [Chapter 3.2.10.2, "Configuring antennas"](#), on page 53.
If the R&S Spectrum Rider detects the directional antenna, the accessory name e.g. "HE300" is displayed in the [title bar](#).

Start the measurement

1. Press [MEAS] key.
2. Select "Meas Mode" softkey.
The R&S Spectrum Rider opens a submenu to select the measurement mode.
3. Select the "EIRP" menu item.
The R&S Spectrum Rider performs the EIRP measurement and displays the result in the EIRP info bar.



- 1 = EIRP measurement result
- 2 = EIRP max hold value which updates when a new higher value is found
- 3 = [Advanced EIRP measurement](#)
- 4 = [Channel bandwidth](#)
- 5 = Path loss ([Free space path loss](#))
- 6 = EIRP info bar

After you have turned on the directional antenna, the R&S Spectrum Rider uses the directional antenna for all measurements.

Note: When you turn on the directional antenna without selecting a transducer factor, the R&S Spectrum Rider displays the file manager dialog to select a transducer factor. When the directional antenna is turned off, the transducer factor is unloaded.

For more information on using transducer factors for antenna, see ["Using transducer factors"](#) on page 167.

Selecting standard

The R&S Spectrum Rider provides predefined telecommunication standards, however, you can also customize your own standard for measurements.

For more information, see [Chapter 6.1.2.1, "Selecting the standard"](#), on page 126.

Adjusting reference level

The R&S Spectrum Rider provides a "Level Adjust" function to optimize the dynamic range of the measurement with expectation of the power level at the RF input.

For more information, see [Chapter 6.1.2.2, "Setting the reference level"](#), on page 127.

Setting channel bandwidth

The channel bandwidth defines the frequency range around the center frequency, over which the R&S Spectrum Rider performs the power measurement.

1. Press [MEAS] key.
2. Select "EIRP Settings" softkey.
The R&S Spectrum Rider opens a submenu to select the input parameters for EIRP settings.
3. Select the "Channel BW" menu item.
The R&S Spectrum Rider opens an input field to specify the channel bandwidth.
4. Enter the channel bandwidth you required.
The R&S Spectrum Rider sets the appropriate span for the channel bandwidth that you have entered (span = 1.2 x channel bandwidth). This ensures that no incorrect channel power measurements are made.
The minimum channel bandwidth that you can set is 833 Hz at a span of 1 kHz.

Setting input parameters for EIRP

The input parameters such as antenna gain (dB) , cable loss (dB) and distance (meter or feet) are taken into consideration during the calculation of EIRP measurement. See "[EIRP calculation](#)" on page 168 and "[Test setup](#)" on page 169.

1. Press [MEAS] key.
2. Select "EIRP Settings" softkey.
The R&S Spectrum Rider opens a submenu to select the input parameters for EIRP settings.
 - "Antenna Gain": Input parameter in dB, value is displayed in dBi in the EIRP info bar
 - "Cable Loss": Input parameter in dB, value is displayed in dB in EIRP info bar
 - "Distance": Input parameter in meter or feet, value is displayed in meter or feet in EIRP info bar
3. Select the required settings.
4. Enter the value according to the selected settings.

Max hold for EIRP

The "EIRP Max Hold" displays the maximum hold value in the EIRP info bar. To reset the max hold value, do the following:

1. Press [MEAS] key.
2. Select "Reset Max Hold" softkey.
The R&S Spectrum Rider reset the "EIRP Max Hold" value.

Advanced EIRP measurement

With advanced EIRP measurement, the R&S Spectrum Rider can performs dual polarization.

1. Press [MEAS] key.

2. Select "Advanced Setting" softkey.

The R&S Spectrum Rider displays the following softkey for selection:

- "Capture Horizontal": Capture the current EIRP horizontal value
- "Capture Vertical": Capture the current EIRP vertical value
- "Clear Meas": Clear horizontal and vertical value, the sum becomes "---"

3. Select the required measurement.

The R&S Spectrum Rider added the selected measurement in the EIRP info bar.

6.2 Configuring spectrum measurements

Basic measurement settings that are common to many measurement tasks, regardless of the application or operating mode, are described here. If you are performing a specific measurement task, using an operating mode other than Signal and Spectrum Analyzer mode, or an application other than the Spectrum application, check the specific application or mode description for settings that may deviate from these common settings.

• Configuration overview	172
• Configuring the horizontal axis	173
• Configuring the vertical axis	177
• Configuring the tracking generator	182
• Setting bandwidths	183
• Configuring and triggering the sweep	186
• Working with traces	191
• Using markers	196
• Using display lines	208
• Using limit lines	208

6.2.1 Configuration overview

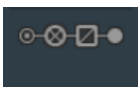

The "Configuration Overview" provides an overview on the most important currently defined settings for the spectrum measurement. See "[Configuration overview](#)" on page 42. It is displayed when you select the "Config Overview" icon, which is available at the bottom of "Parameter View". See [Chapter 3.2.6.4, "Parameter view"](#), on page 40.



The "Configuration Overview" provides quick access and allows easy configuration on the parameters that affect the spectrum measurement from input to signal processing to output and signal analysis by stepping through each of the following dialog boxes:

- "Input"
See [Chapter 6.2.3.7, "Setting the input impedance"](#), on page 181.
- "Amplitude"
See [Chapter 6.2.3, "Configuring the vertical axis"](#), on page 177.
- "Frequency"
See [Chapter 6.2.2, "Configuring the horizontal axis"](#), on page 173.
- "Bandwidth"
See [Chapter 6.2.5, "Setting bandwidths"](#), on page 183.
- "Analysis"
See [Chapter 6.2.7, "Working with traces"](#), on page 191.
- "Trigger"
See [Chapter 6.2.6.3, "Working with trigger functionality"](#), on page 187

To configure settings

Select any of the six configuration dialog boxes to open the corresponding dialog box. See [Table 3-4](#).

6.2.2 Configuring the horizontal axis



The [FREQ] key contains all necessary functions to configure the horizontal axis for spectrum measurements.

The contents of the menu depend on the currently selected measurement.

Usually, the horizontal axis contains frequency information in spectrum mode. You can specify the frequency in terms of the center frequency or by defining a start and stop frequency for a particular span.

If you know the frequency of the signal you are measuring, it is best to match the center frequency to the signal's frequency. If you are investigating signals, e.g. harmonics, that are within a particular frequency range, the best option is to enter a start and stop frequency to define the span.

- [Defining the center frequency](#)..... 174
- [Defining a frequency step size](#)..... 174
- [Setting a frequency offset](#)..... 175
- [Defining a start and stop frequency](#)..... 175
- [Setting the span](#)..... 176

6.2.2.1 Defining the center frequency

The center frequency represents the frequency at the center of the horizontal axis in the diagram area.

1. Press [FREQ] key.
2. Select "Center Freq" softkey.
The R&S Spectrum Rider opens an input field to define the center frequency.
3. Enter the center frequency you need.
The frequency you have entered becomes the new center frequency.



Special touchscreen gesture

Alternatively, define the center frequency by swiping horizontally across the touchscreen to change the center frequency.

See [Chapter 4.2.1, "Change center frequency"](#), on page 92.

While adjusting the center frequency, you may obtain a value that is outside the R&S Spectrum Rider maximum span. If this happens, the R&S Spectrum Rider automatically reduces the span.

6.2.2.2 Defining a frequency step size

If you set the center frequency with the rotary knob, the distance of each step that you take depends on the span. With the rotary knob, the smallest possible step is a pixel. As the trace consists of 711 pixels, each step is equal to 1/711 of the span.

You can set another step size.

1. Press [FREQ] key.
2. Select "CF Step Size" softkey.
The R&S Spectrum Rider opens a submenu that contains possible step sizes.
 - "0.1 x Span"
The step size equals 10 % of the span or 1 division of the horizontal axis.
 - "step = Center"
The step size equals the center frequency.

This step size is ideal for measurements on harmonics. When you increase or decrease the center frequency, the center frequency automatically moves to the next harmonic.

- "Manual"

An entry box is displayed to define the value.

This step size makes it easy to investigate a spectrum with frequencies at constant intervals.

3. Select the step size you need from the menu.
The R&S Spectrum Rider adjusts the step size accordingly.

If you set the step size to 10 % of the span or to the center frequency, the R&S Spectrum Rider sets the step size internally. Manually defining the step size opens an input field to define the step size.

6.2.2.3 Setting a frequency offset

For measurements on frequency converters such as satellite downconverters, it is often convenient to reference the results to the frequency before conversion. For this purpose, the R&S Spectrum Rider offers a frequency offset that arithmetically shifts the center frequency to higher or lower frequencies. Thus, the R&S Spectrum Rider displays the input frequency of the DUT.

Positive frequency offset is possible in the range from 1 Hz to 100 GHz, in steps of 1 Hz. The maximum negative frequency offset depends on the start frequency you have set. The start frequency, taking into account the frequency offset, is always ≥ 0 Hz.

1. Press [FREQ] key.
2. Select "Freq Offset" softkey.
The R&S Spectrum Rider opens an input field to set the frequency offset.
3. Enter the frequency offset you need.
The R&S Spectrum Rider adds the frequency offset to the center frequency you have set. A blue dot at the center frequency display indicates that a frequency offset has been set.

6.2.2.4 Defining a start and stop frequency

Defining a start and a stop frequency is best suited for example, for measurements on harmonics or signals whose exact frequency is unknown.

1. Press [FREQ] key.
2. Select "Start Freq" softkey.
The R&S Spectrum Rider opens an input field to define the start frequency.
3. Enter the start frequency you need.
4. Set a stop frequency with the "Stop Freq" softkey.

The R&S Spectrum Rider adjusts the horizontal axis according to your input, beginning with the start frequency and ending with the stop frequency.

If you have entered a stop frequency that is outside the maximum frequency range, the R&S Spectrum Rider sets the stop frequency to the possible maximum.

The softkey label of the "Parameter View" changes from "Center" and "Span" to "Start" and "Stop".

6.2.2.5 Setting the span



The span is the frequency range around the center frequency that a spectrum analyzer displays on the screen. The span you should select depends on the signal and the measurement that you are performing. A rule of thumb is that it should be at least twice the bandwidth occupied by the signal.

The available span for frequency domain measurements depends on the instrument model and installed option.

Model	Frequency upgrade option	Order number for frequency upgrade option
Model 02 - 5 kHz to 2.0 GHz	R&S FPH-B3, 2 GHz to 3 GHz	1321.0667.02
	R&S FPH-B4, 3 GHz to 4 GHz	1321.0673.02
Model 06 - 5 kHz to 6.0 GHz	R&S FPH-B8, 6 GHz to 8 GHz	1321.0767.02
Model 13 - 5 kHz to 13.6 GHz Model 23 - 5 kHz to 13.6 GHz with Tracking Generator	R&S FPH-B20, 13.6 GHz to 20 GHz	1321.0773.02
Model 26 - 5 kHz to 26.5 GHz Model 36 - 5 kHz to 26.5 GHz with Tracking Generator	R&S FPH-B31, 26.5 GHz to 31 GHz See " R&S Spectrum Rider option " on page 33.	1321.0780.02
Model 44 - 5 kHz to 44 GHz Model 54 - 5 kHz to 44 GHz with Tracking Generator	-	-

If you set a span of 0 Hz (zero span), the R&S Spectrum Rider performs measurements in the time domain.

1. Select the "Span" softkey on the "Parameter view" to define the span.
Alternatively, press the [SPAN] key.
The R&S Spectrum Rider opens an input field to define the span.
2. Enter the span you need.
The R&S Spectrum Rider adjusts the span of the horizontal axis.



Special touchscreen gesture

Alternatively, pinch and stretch on the touchscreen to change the span parameter. See [Chapter 4.2.3, "Change span"](#), on page 94.

If you have to switch between full span and a smaller span, you can do so without having to enter the numeric values.

1. Press [SPAN] key.
2. Select "Full Span" softkey.
The R&S Spectrum Rider displays the spectrum over its entire frequency range.
3. Select "Last Span" softkey.
The R&S Spectrum Rider restores the span that you have set just before displaying the entire frequency range.

Time domain measurements

You can also activate time domain measurements without having to enter the value manually. When measuring in the time domain, the span is 0 Hz. In that state, the R&S Spectrum Rider measures the signal at the current center frequency only. Instead of displaying the spectrum, the R&S Spectrum Rider shows the signal power over a certain time period. The horizontal axis becomes the time axis. The display always starts at 0 s and stops after the currently set sweep time.

1. Press [SPAN] key.
2. Select "Zero Span" softkey.
The R&S Spectrum Rider sets a span of 0 Hz and performs the measurement in the time domain.

6.2.3 Configuring the vertical axis



All relevant settings to configure the vertical axis are available in the amplitude menu. You can access it via the [AMPT] key.

- [Setting the reference level](#)..... 177
- [Setting a display range](#)..... 178
- [Selecting the display unit](#)..... 179
- [Setting a reference offset](#)..... 179
- [Setting the RF attenuation](#)..... 179
- [Using the preamplifier](#)..... 181
- [Setting the input impedance](#)..... 181
- [Using transducer factors](#)..... 181

6.2.3.1 Setting the reference level

The reference level is represented graphically by the grid line at the top of the diagram.

The reference level sets the input signal gain up to the display stage. If the reference level is low, the gain is high. That means that even weak signals are displayed clearly.

If you are measuring strong signals, you have to set a high reference level to prevent an overload of the signal path of the analyzer and to keep the signal within the display

range. If you are measuring the spectrum of a composite signal, make sure that the reference level is high enough to cover all signals and that all signals are within the measurement diagram.

1. Press [AMPT] key.
2. Select "Ref Level" softkey.
The R&S Spectrum Rider opens an input field to define the reference level.
3. Enter the reference level you require.
If you change the reference level, the R&S Spectrum Rider adjusts the position of the trace as you make the changes.



Special touchscreen gesture

Alternatively, define the reference level by swiping vertically across the touchscreen to change the reference level.

See [Chapter 4.2.2, "Change reference level"](#), on page 93.

By default, the reference level corresponds to the grid line at the top of the diagram. You can also change the position of the reference level to another grid line if you have a signal that would otherwise overlap with the top of the diagram area. The R&S Spectrum Rider indicates the current reference level position with a triangle at the corresponding grid line on the vertical axis. See index 5 on [Figure 4-1](#).

1. Press [AMPT] key.
2. Select "Range / Ref Pos" softkey.
The R&S Spectrum Rider opens a submenu.
3. Select the "Ref Position 10..." menu item.
The R&S Spectrum Rider opens an input field to define the reference position.
4. Enter the number of the grid line you want the reference level to position at.
The range is from 0 to 10. "0" corresponds to the lowest grid line, "10" corresponds to highest grid line.

6.2.3.2 Setting a display range

The display range determines the scaling or resolution of the vertical axis. In the default state, the display range is a logarithmic scaling over a 100 dB. This corresponds to 10 dB per grid division. The R&S Spectrum Rider provides other display ranges that either increase or decrease the resolution of the vertical axis.

However, increasing resolution does not increase the accuracy of, for example, the marker level readout, but only makes it easier to read values off the trace.

You can also select a linear scale for the vertical axis. In that case, the power levels are expressed as a percentage of the reference level. Linear scaling is useful to display AM modulated carriers in the time domain, for example.

1. Press [AMPT] key.

2. Select "Range / Ref Pos" softkey.
The R&S Spectrum Rider opens a submenu to select the display range.
3. Select the display range you need.
The R&S Spectrum Rider adjusts the vertical axis accordingly.

6.2.3.3 Selecting the display unit

By default, the vertical axis (and therefore the reference level) is scaled in dBm. However, the units dBmV, dBV, Watt and Volt are also available. Selecting the right unit is relevant for the marker level display because the unit of the marker level is the same as the reference level.

1. Press [AMPT] key.
2. Select "Unit" softkey.
The R&S Spectrum Rider opens a submenu to select the display unit.
3. Select one of the available units.
The R&S Spectrum Rider adjusts the vertical axis accordingly.

6.2.3.4 Setting a reference offset

You can define a reference offset for the reference level. With a reference offset, you can increase the reference level by a certain amount. This is useful, for example, if an attenuator or amplifier has been inserted before the RF input. The R&S Spectrum Rider automatically takes the loss or gain into account when the level is displayed and no manual calculations are necessary. A loss introduced at the RF input must be entered as a positive number and a gain as a negative number.

1. Press [AMPT] key.
2. Select "Ref Offset" softkey.
The R&S Spectrum Rider opens an entry box to define input field.
3. Enter the offset you need.
The R&S Spectrum Rider includes the offset in puts in the measurement.
To indicate an offset other than 0, the R&S Spectrum Rider puts a blue dot at the "REF" field displays in the "Parameter View".

6.2.3.5 Setting the RF attenuation

RF attenuation adjusts the input range inside the analyzer. It is coupled directly to the reference level. If you have set a high reference level, RF attenuation is turned on in 10 dB steps according to the table below so that the input mixer always remains in the linear range.

The R&S Spectrum Rider provides three attenuation modes.

- "Auto Low Distortion"

If this mode is active, the R&S Spectrum Rider sets the RF attenuation 10 dB higher according to the table below, making the stress of the input mixer 10 dB less at the specified reference level. If the spectrum is densely occupied with signals, e.g. in a television cable network, the input mixer reduces the R&S Spectrum Rider inherent spurious products. However, the inherent noise display of the R&S Spectrum Rider increases due to the increased attenuation in front of the input mixer.

- "Auto Low Noise"
If this mode is active, the R&S Spectrum Rider sets the RF attenuation 10 dB lower. This increases the sensitivity of the R&S Spectrum Rider, which means that the inherent noise display decreases due to the lower attenuation in front of the input mixer.
- "Manual"
Manual selection of the attenuation.

You can check the status of the RF attenuation and the preamplifier in the "Configuration Overview" dialog and in the "Parameter View" area.

Reference Level	Preamplifier OFF RF attenuation		Preamplifier ON RF attenuation	
	Low noise	Low distortion	Low noise	Low distortion
<=-40 dBm	0 dB	0 dB	0 dB	0 dB
-39 dBm to -35 dBm	0 dB	0 dB	0 dB	5 dB
-34 dBm to -30 dBm	0 dB	0 dB	0 dB	10 dB
-29 dBm to -25 dBm	0 dB	0 dB	0 dB	15 dB
-24 dBm to -20 dBm	0 dB	0 dB	0 dB	20 dB
-19 dBm to -15 dBm	0 dB	5 dB	5 dB	25 dB
-14 dBm to -10 dBm	0 dB	10 dB	10 dB	30 dB
-9 dBm to -5 dBm	5 dB	15 dB	15 dB	35 dB
-4 dBm to 0 dBm	10 dB	20 dB	20 dB	40 dB
1 dBm to 5 dBm	15 dB	25 dB	25 dB	40 dB
6 dBm to 10 dBm	20 dB	30 dB	30 dB	40 dB
11 dBm to 15 dBm	25 dB	35 dB	35 dB	40 dB
16 dBm to 20 dBm	30 dB	40 dB	40 dB	40 dB
21 dBm to 25 dBm	35 dB	40 dB	40 dB	40 dB
26 dBm to 30 dBm	40 dB	40 dB	40 dB	40 dB

1. Press [AMPT] key.
2. Select "Att / Amp / Imp" softkey.
3. Select either the "Auto Low Distortion" or the "Auto Low Noise" menu item.
The R&S Spectrum Rider sets the attenuation according to the table above.
4. Select the "Manual Att" for manual entry of the RF attenuation.

Alternatively, you can select the "ATT" softkey on the "Parameter View" to enter manually for the RF attenuation.

The R&S Spectrum Rider opens an entry box to set the RF attenuation. You can set the attenuation from 0 dB to 40 dB in 5 dB steps.

To indicate a manual attenuation, the R&S Spectrum Rider puts a blue dot at the "ATT" displays on the "Parameter View".

6.2.3.6 Using the preamplifier

To increase the input sensitivity, the optional preamplifier provides an integrated 20 dB preamplifier after the input mixer.

For a list of preamplifier option supported for the different instrument models, refer to the data sheet.

In the default state of the R&S Spectrum Rider, the preamplifier is turned off. If you want to measure signals with low powers, you can turn it on.

1. Press [AMPT] key.
2. Select "Att / Amp / Imp" softkey.
3. Enable or disable the checkbox to turn on or off the "Preamp" menu item.
The R&S Spectrum Rider turns the preamplifier on and off.

6.2.3.7 Setting the input impedance

In the default state, the input impedance is 50 Ω .

The R&S Spectrum Rider can also handle 75 Ω systems. The R&S Spectrum Rider does not select a 75 Ω RF input. Instead it selects a 75 Ω matching pad connected at the RF input. The 50/75 Ω matching pad R&S RAZ is recommended for 75 Ω matching (see recommended accessories). The R&S Spectrum Rider automatically considers the conversion factor when a value of 75 Ω is set.

1. Press [AMPT] key.
2. Select "Att / Amp / Imp" softkey.
3. Select the impedance you need.
You can also use other matching pads (e.g. R&S RAM or R&S FSH-Z38) by activating transducer factors.

6.2.3.8 Using transducer factors

For more information, see [Chapter 6.4, "Using transducer factors"](#), on page 212.

6.2.4 Configuring the tracking generator



Tracking generator is only available for model .23, model 36 and model 54 of the R&S Spectrum Rider.



If signal source is set to "Tracking", "CW" or "Coupled CW", the [demodulator function](#) is disabled in the [Marker Function](#).

The tracking generator provides a stimulus signal in the spectrum measurement mode.

Configuring the signal source

You can select the type of generator source in three different ways.

- "Tracking"
Output frequency depends on current measurement frequency.
 - "CW"
Output frequency can be defined.
 - "Coupled CW"
Output frequency is coupled to the current measurement center frequency.
1. Press [MEAS] key.
 2. Select "Source" softkey.
The R&S Spectrum Rider opens the signal source menu.
 3. Select "Source Mode" softkey.
The R&S Spectrum Rider opens the submenu that contains the signal source selection.
 4. Select the required signal source.
 - If selected signal source is "Tracking", the R&S Spectrum Rider opens an input field to specify the tracking generator offset frequency, "TG Offset"
The R&S Spectrum Rider displays the "TG" indicator at the top right-hand corner of the trace window.
 - If selected signal source is "CW", the R&S Spectrum Rider opens an input field to specify the continuous waveform frequency, "CW Freq".
The R&S Spectrum Rider displays the "CW" indicator at the top right-hand corner of the trace window.
 - If selected signal source is "Coupled CW", the R&S Spectrum Rider coupled the output signal source frequency with the current measurement center frequency
The R&S Spectrum Rider displays the "CW" indicator at the top right-hand corner of the trace window.

Defining the level of the stimulus signal

You can define the level of the stimulus signal an absolute level in terms of dBm.

1. Select the "Source Level" softkey.
The R&S Spectrum Rider opens an input field to specify the source level.
2. Enter the required source level.

The actual output level measured can deviate from the value you enter and may not be linear over the frequency range of the measurement. It is recommended to normalize or calibrate a measurement to compensate for any level variations caused by the tracking generator.

For more information about compensating level via transducer factor, see [Chapter 6.4, "Using transducer factors"](#), on page 212.

Turning the tracking generator on and off

1. Select the "Source Mode" softkey.
The R&S Spectrum Rider opens the submenu that contains the signal source selection.
2. Select "Off" menu item.
The R&S Spectrum Rider turns off the signal source.

6.2.5 Setting bandwidths

The bandwidth menu contains all settings to set up filter bandwidths available in the R&S Spectrum Rider. You can access it with the [BW] key.

- [Setting the resolution bandwidth](#)..... 183
- [Setting the video bandwidth](#)..... 184

6.2.5.1 Setting the resolution bandwidth



The resolution bandwidth in a spectrum analyzer determines the frequency resolution for frequency domain measurements and therefore determines how well it can separate adjacent frequencies. The measurement result observed depends on the pass-band of a resolution filter.

The resolution bandwidth (RBW) has several effects on measurements.

- To be able to display two or more signals whose frequencies are close together separately, you need a (resolution) filter whose bandwidth is small enough. The frequency difference between two sinusoidal carriers cannot be less than the selected resolution bandwidth if the carriers are to be resolved, for example.
- The bandwidth of the resolution filter also affects the noise that is displayed by the R&S Spectrum Rider. The smaller the bandwidth, the less noisy the results are. The rule is, that if you increase or decrease the bandwidth by a factor of 3, the noise goes down or up by 5 dB. If you change the bandwidth by a factor of 10, the displayed noise changes by 10 dB.
- The resolution bandwidth affects the speed of the measurement. If you want to display the true spectrum, the resolution filters have to settle at all frequencies that

are of interest. Narrow band filters have a longer settling time compared to wide ones. Therefore the sweep time increases the smaller the resolution bandwidth gets. The rule is, that if you reduce the bandwidth by a factor of 3, the sweep time goes up by a factor of 9. If you reduce the bandwidth by a factor of 10, the sweep time goes up by a factor of 100.

The R&S Spectrum Rider has resolution bandwidths from 1 Hz to 3 MHz in a 1-3-10 sequence.

In the R&S Spectrum Rider's default state, the resolution bandwidth is coupled to the span, i.e. if you change the span, the R&S Spectrum Rider adjusts the resolution bandwidth. Therefore, you do not have to set the resolution bandwidth manually in many cases, because the R&S Spectrum Rider automatically sets the resolution bandwidth if you change the span.

1. Press [BW] key.
By default, the resolution bandwidth is coupled to the span.
2. Select "Manual RBW" softkey.
The R&S Spectrum Rider opens an input field to define the resolution bandwidth.
3. Enter the resolution bandwidth you need.
The R&S Spectrum Rider uses the resolution bandwidth you have entered for the measurement.
If the resolution bandwidth is no longer coupled to the span, the R&S Spectrum Rider puts a blue dot at the "RBW" displays on the "Parameter View".
4. Select the "Auto RBW" softkey again to couple the resolution bandwidth to the span.



Automatic adjustment of the sweep time

In its default mode, the R&S Spectrum Rider automatically adjusts the sweep time as soon as you change the resolution bandwidth. This adjustment makes sure that the settling time required for the selected resolution filter is properly taken into account. The maximum allowed sweep time is 1000 s. For narrow resolution filters this value would be exceeded for large spans. To avoid this situation, the R&S Spectrum Rider adjusts the span automatically as soon as the maximum sweep time is reached.

6.2.5.2 Setting the video bandwidth

The video bandwidth (VBW) basically smoothes the trace by reducing the noise and therefore making power levels easier to see.

The noise reduction is a result of the video filter. This lowpass filter defines the video bandwidth and filters the higher frequency parts of the voltage from the signal. Video voltage is the (DC) voltage that results from the IF signal passing through the envelope detector which removes the IF components and outputs the envelope only. This output is also known as the video signal.

The figure below shows that process on an AM modulated signal in the time domain.

In case of an AM modulated signal, the envelope (or video) signal contains a DC component that corresponds to the level of the carrier. The video signal also contains an AC component whose frequency is the same as the AM frequency.

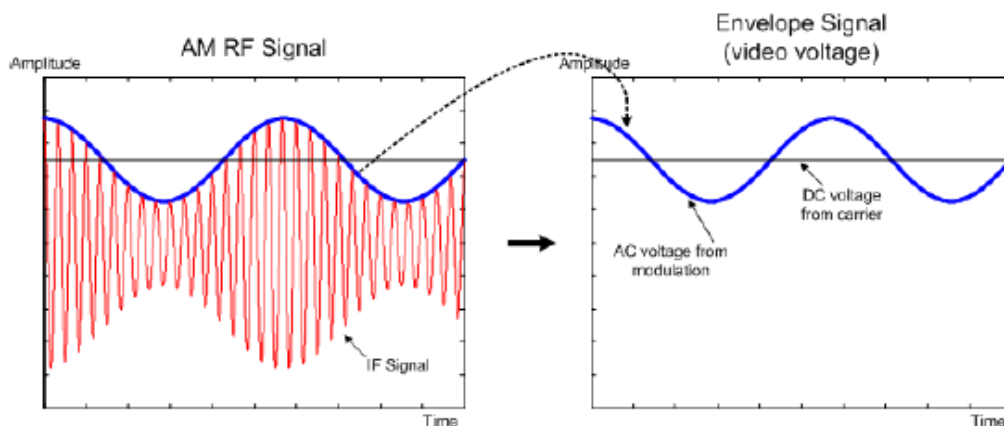

If the bandwidth of the video filter is less than the frequency of the AC component, it is suppressed depending on its maximum frequency. If the AM component should be displayed truly, the cutoff frequency of the filter has to be greater than the modulation frequency.

If there is noise on the sine signal, the modulation signal can be thought of as noise. If the video bandwidth is reduced, the high-frequency noise components above the cutoff frequency of the video filter is rejected. The smaller the video bandwidth, the smaller the noise amplitude at the video filter output.

The R&S Spectrum Rider provides video bandwidths from 1 Hz to 3 MHz in a 1-3-10 sequence. In its default state, the video bandwidth is coupled to the resolution bandwidth and is the same as the resolution bandwidth. If you change the resolution bandwidth, the R&S Spectrum Rider adjusts the video bandwidth accordingly.

The effects of the video bandwidth on measurements are as follows.

- If you are performing measurements on modulated signals, the video bandwidth must be sufficiently large so that significant modulation components are not rejected ($\geq \text{RBW}$)
- If you want to keep signals free of noise, you should select the smallest video bandwidth possible ($\leq 0.1 \times \text{RBW}$)
- If you are performing measurements on pulsed signals, the video bandwidth should be at least three times greater than the resolution bandwidth so that the pulse edges are not distorted

Like the resolution bandwidth, the video bandwidth has an effect on sweep speed. Before each measurement, the video filter has to settle.

1. Press [BW] key.
By default, the resolution bandwidth is coupled to the span.
2. Select "Manual VBW" softkey.
The R&S Spectrum Rider opens an input field to define the video bandwidth.

3. Enter the video bandwidth you need.
The R&S Spectrum Rider uses the video bandwidth you have entered for the measurement. If the video bandwidth is no longer coupled to the resolution bandwidth, the R&S Spectrum Rider puts a blue dot at the "VBW" displays on the "Parameter View".
4. Select the "Auto VBW" softkey again to couple the video bandwidth to the RBW.

6.2.6 Configuring and triggering the sweep

You can find all necessary settings to configure the sweep itself in the sweep menu. To access it, press the [SWEEP] key.

- [Setting the sweep time](#)..... 186
- [Selecting the sweep mode](#)..... 187
- [Working with trigger functionality](#)..... 187

6.2.6.1 Setting the sweep time



The sweep time is the time it takes the R&S Spectrum Rider to get the results that are contained in one trace.

In the frequency domain (span > 0), the sweep time is the time it takes the R&S Spectrum Rider to measure the spectrum in the specified span. To avoid the display of spurs in the spectrum, the sweep time has to meet some conditions.

- The sweep time depends on the resolution bandwidth. If the sweep time is too short, the resolution filter has no time to settle. In that case, the displayed level is too low. For more information, see [Chapter 6.2.5.1, "Setting the resolution bandwidth"](#), on page 183.
- The sweep depends on the span. If you increase the span, you also have to increase the sweep time.

In its default state, the R&S Spectrum Rider couples the sweep time to the span and the resolution bandwidth to avoid invalid settings. If the coupling is active, the R&S Spectrum Rider always sets the shortest possible sweep time to make sure that the display of the spectrum is correct and valid.

The R&S Spectrum Rider requires a minimum sweep time of 20 ms for every 600 MHz of span. If you increase the span, the R&S Spectrum Rider will also increase the sweep time.

In the time domain (span = 0), the R&S Spectrum Rider shows the video voltage over time. The horizontal axis becomes a time axis that starts at 0 s and ends at the sweep time that you selected. The range of the sweep time in the time domain is from 34 us to 1000 s.

1. Press [SWEEP] key.
In the default state, "Auto SWT" is active.
2. Select "Manual SWT" softkey.

The R&S Spectrum Rider opens an input field to set the sweep time.

3. Enter the sweep time you need.
If the video bandwidth is no longer coupled to the span or the resolution bandwidth, the R&S Spectrum Rider puts a blue dot at the "SWT" displays on the "Parameter View".

6.2.6.2 Selecting the sweep mode

The sweep mode is the way the R&S Spectrum Rider performs the measurement.

In its default state, the R&S Spectrum Rider measures continuously. In this mode, the R&S Spectrum Rider automatically repeats the sweep in the defined range of the horizontal axis (frequency or time) and updates the trace accordingly after it has finished with one sweep.

In some cases, it may be sufficient to get the results over a single sweep only, e.g. if a particular trigger condition is met. In single sweep mode, the R&S Spectrum Rider performs the sweep a certain number of times (depending on the number of averages you have set) over the defined range of the horizontal axis (frequency or time) and then stops measuring. It performs another sweep only after you tell it to. For more information on setting the number of sweeps included in a single sweep, see [Chapter 6.2.7.1, "Selecting the trace mode"](#), on page 192.

1. Press [SWEEP] key.
2. Select "Single Sweep" softkey.
The R&S Spectrum Rider activates single sweep mode.
3. Select "Cont Sweep" softkey.
The R&S Spectrum Rider again starts to measure continuously.

6.2.6.3 Working with trigger functionality



Gated trigger

If [gated trigger](#) is activated, the R&S Spectrum Rider disables the [demodulator function](#) in [Marker Function](#).

If you have to perform measurements according to certain signal conditions, you can use a trigger. A trigger responds to certain events. If a trigger is active, the R&S Spectrum Rider starts to measure if the trigger conditions are met. The trigger can be generated either externally or internally. The R&S Spectrum Rider provides the following trigger functions.

Selecting the trigger source

1. Press [SWEEP] key.

2. Select "Trigger" softkey.
The R&S Spectrum Rider opens a submenu to select the trigger source.
3. Select the trigger source you need.
The R&S Spectrum Rider activates the trigger.

The R&S Spectrum Rider provides the following trigger functions.

- **Free Run**
A new sweep starts on completion of the previous sweep. This sweep mode is the default state of the R&S Spectrum Rider.
- **Video Trigger**
A sweep starts when the video voltage exceeds a particular level. The video trigger is available only in the time domain (span = 0).
In the frequency domain, the R&S Spectrum Rider would never start a measurement with the video trigger because there is no guarantee that there is a signal that generates video voltage present at the start frequency.
- **External Trigger** (rising or falling slope)
A sweep starts on the rising edge (RISE) or on the falling edge (FALL) of an external trigger signal. The external trigger signal is fed in via the BNC connector "Ext Trigger". See details of connector in "[BNC connector](#)" on page 34. The switching threshold is 1.4 V, i.e. a TTL signal level.
- **Gated Trigger**
When the gated trigger is active, a gate signal that is applied to the R&S Spectrum Rider trigger input controls the sweep. The R&S Spectrum Rider starts measuring when the applied gate signal becomes active and the set gate delay has expired, and it interrupts the measurement as soon as the defined gate length is reached. With the gate signal becoming active the next time the measurement is resumed etc.
Pulsed signals can be measured by this method, if the gate delay and gate length are selected in a way that the measurement is only performed while the pulse is active. Gated measurements are possible in the frequency domain (span > 0) and the time domain (span = 0), but it is available only in combination with an external gate signal.

Including a delay time

When you are using a video trigger in the time domain or an external trigger, you can delay the start of the measurement with respect to the trigger event by entering a delay time. In this way, you can include time differences between the trigger event and the measurement.

The range of the trigger delay is from 0 s to 100 s. The resolution depends on the sub-range.

Trigger delay	Resolution
0 ms to 1 ms	10 μ
1 ms to 10 ms	100 μ
10 ms to 100 ms	1 ms

Trigger delay	Resolution
100 ms to 1 s	10 ms
1 s to 10 s	100 ms
10 s to 100 s	1 s

1. Press [SWEEP] key.
2. Select "Trigger" softkey.
3. Select the "Trigger Delay" menu item.
The R&S Spectrum Rider opens an input field to define the trigger delay.
4. Enter the delay time you need.

Defining the trigger level

When you are using the video trigger, you have to define a trigger level. The trigger level is a percentage of the reference level. A trigger level of 100 % is the same as the reference level. A trigger level of, e.g. 50 % corresponds to the middle of the vertical axis. The R&S Spectrum Rider indicates the video trigger level with a triangle.

1. Press [SWEEP] key.
2. Select "Trigger" softkey.
3. Select the "Video" menu item.
The R&S Spectrum Rider opens an input field to define the trigger level.
4. Enter the trigger level.
The R&S Spectrum Rider shows the trigger level by adding a horizontal line to the diagram area.

Performing gated sweeps

After the gate settings are configured, it is possible to perform a gated sweep measurement.

To get appropriate results, you have to set the gate delay and gate length in a way that the measurement is active during the interesting part of the signal. You can also modify the sweep time to match the horizontal axis to the length of the signal and thus set the gate delay and gate length parameters more accurately. Alternatively, you can also perform an auto gate setting to determine the gate delay and gate length of the signal automatically.

The gate delay parameter defines the time between the trigger event and the beginning of the actual measurement. The gate length defines the duration of the measurement, before it is interrupted and the next gate signal is anticipated to resume the measurement.

The minimum requirement for RBW is 30 kHz for gated trigger. The R&S Spectrum Rider configures the RBW to 30 kHz if a lower value is used.

Sweep time is set at an integer multiple of frame duration (e.g. a multiple settings of 10 ms for LTE frame duration). Default sweep time is set to 10 ms and minimum sweep time allowed is 5 ms.

In case of gate settings conflict, the R&S Spectrum Rider will set the trigger to free run. Before re-enabling the gated trigger, you need to perform one of the following:

- revert to previous settings and correct the gate setting
- perform gate setting with adjusted gate length

Gate setting should be done at least once before performing gated sweep.

Example:

Using a signal source, i.e R&S SMU to generate an EUTRA/LTE signal (TDD duplexing, downlink (OFDMA)) at 1 GHz, -40 dBm. Connect the signal source RF output to the RF input connector of the R&S Spectrum Rider.

The example performs a gated trigger measurement using "AutoGate High" function to determine the gate length and gate delay of the desire part of the signal. The measurement starts after the delay time has passed and measurement take places over the period of the gate length. The result is a stable LTE signal for measurement.

1. Press [SWEEP] key.
2. Select "Trigger" softkey.
3. Select the "Gate Settings" menu item.
The R&S Spectrum Rider opens a softkey submenu to control the gate settings. At the same time, the R&S Spectrum Rider switches into time domain, as indicated in the display. See [Figure 6-12](#) (time domain with initial gate setting).
4. Select "Manual SWT" softkey and set the sweep time in a way that the portion of interest of the signal is visible on the screen.
5. Select "AutoGate High" softkey to determine the "Gate Delay" and "Gate Length" automatically for the desire part of the signal.
The R&S Spectrum Rider display the gate delay and length at the top right corner of the trace display. See [Figure 6-12](#) (time domain after gate setting).
6. Alternatively, you can manually set the gate delay and gate length. Select "Gate Delay" or "Gate Length" softkey to determine the setting manually.
The R&S Spectrum Rider opens an input field to define the setting.
7. Enter the required settings you need.
8. Press any of the [function keys](#) to exit the gate settings menu.
The R&S Spectrum Rider returns to the frequency domain provided it was active before setting up the gated trigger. The original span is restored. The R&S Spectrum Rider is ready to perform measurements with an accurate gate setting. See [Figure 6-12](#) (frequency domain).

The measurement starts after the delay time has passed and takes place over the period of the gate length. After the gate has closed, the R&S Spectrum Rider waits with the measurement until the next gate signal happens.

The delay time and gate length are represented by vertical blue lines in the diagram area. See Figure 6-12 (time domain).

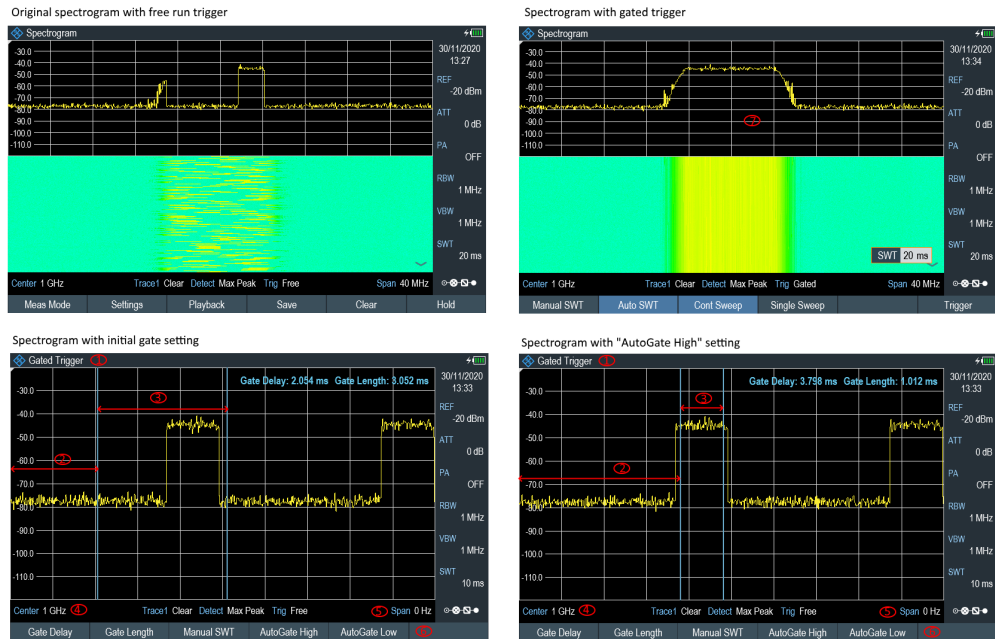

Figure 6-12: Gated trigger measurement

- 1 = Gated trigger mode
- 2 = Gate delay
- 3 = Gate length
- 4 = RF frequency
- 5 = Span 0 Hz (time domain)
- 6 = Gate trigger softkeys menu
- 7 = Measurement of LTE signal within the gate length

6.2.7 Working with traces

The trace menu contains all functions available to customize the trace display.

- [Selecting the trace mode](#)..... 192
- [Selecting the detector](#)..... 193
- [Working with a second trace](#)..... 194
- [Working with memory traces](#)..... 195
- [Using trace mathematics](#)..... 196

6.2.7.1 Selecting the trace mode



The R&S Spectrum Rider provides several trace modes. The trace mode defines the way the R&S Spectrum Rider writes the trace.

1. Press [TRACE] key.
2. Select "Trace Mode" softkey to set the trace mode.
3. Select the trace mode you want to work with.
If you have selected the average trace mode ("Average: 10" menu item), the R&S Spectrum Rider opens an input field to set the number of sweeps the R&S Spectrum Rider includes in the averaging.
4. Enter the number of sweeps to include in the averaging.
In continuous sweep mode, the R&S Spectrum Rider now calculates the moving average over the number of sweeps you have specified. In single sweep mode, it stops the measurement after finishing the sweeps and averages the traces.

The R&S Spectrum Rider provides the following trace modes.

- **Clear/Write**
In its default state, the R&S Spectrum Rider overwrites the trace after each sweep. You can apply all detectors in this mode.
- **Average**
The trace is the result of the moving average over several sweeps.
The R&S Spectrum Rider calculates the (moving) average of the power levels for each pixel over a particular number of sweeps in the range from 2 to 999.
Averaging reduces the effects of noise, but has no effects on sine signals. Using the trace averaging therefore is a good way to detect signals in the vicinity of noise. You can apply all detectors in this mode.
- **Max Hold**
The trace shows the maximum power levels that have been measured at each pixel.
To overwrite a max hold trace, change a parameter in a way that the results cannot be compared any more (e.g. the span). Using the max hold trace mode is a good way to detect intermittent signals or the maximum values of fluctuating signals, for example.
Using the max hold trace mode automatically activates the max peak detector.
- **Min Hold**
The trace shows the minimum power levels that have been measured at each pixel.
To overwrite a min hold trace, change a parameter in a way that the results cannot be compared any more (e.g. the span). Using the min hold trace mode is a good way to highlight signals within noise or suppress intermittent signals.
Using the min hold trace mode automatically activates the min peak detector.
- **View**
The view trace mode freezes the current trace and aborts the measurement.
Using the view trace mode is a good way to evaluate the trace, for example with markers.

6.2.7.2 Selecting the detector

The number of measurement results collected in a single sweep usually is very high, especially if the span is large. However, the display of the R&S Spectrum Rider can display only 711 results in horizontal direction, as it is limited by the number of pixels that are available on the display. Therefore, it has to combine measurement results to fit them on the display. In that case, one pixel represents a frequency range = span / 711.

The detector determines the way the R&S Spectrum Rider combines and displays the results for one pixel. The data base is the video voltage of the analyzer.

1. Press [TRACE] key.
2. Select "Detector" softkey.
The R&S Spectrum Rider displays the submenu to select the trace detector.
3. Select the detector you want to use.
If the "Auto Detector" selection is active, the selection of the trace detector follows [Table 6-1](#).

The R&S Spectrum Rider provides several types of detectors.

- **Auto Peak**
If the auto peak detector is active, the R&S Spectrum Rider displays both the maximum and the minimum power levels that were measured in the frequency range covered by a pixel.
Therefore, the auto peak detector loses no information. If a signal power level fluctuates (e.g. noise), the width of the trace depends on the magnitude of the signal fluctuation. The auto peak detector is the default detector.
- **Max Peak**
If the max peak detector is active, the R&S Spectrum Rider displays only the maximum power levels that were measured in the frequency range covered by a pixel. The max peak detector is useful for measurements on pulse or FM signals, for example.
- **Min Peak**
If the max peak detector is active, the R&S Spectrum Rider displays only the minimum power level that were measured in the frequency range covered by a pixel. The min peak detector displays sine signals with the correct level and suppresses noise. Therefore it is useful to find sine signals in the vicinity of noise.
- **Sample**
If the sample detector is active, the R&S Spectrum Rider shows one random power level that was measured in the frequency range covered by a pixel.
The sample detector is useful for measurements in the time domain (span = 0 Hz) as it provides the only way to represent the timing of the video signal correctly. In the frequency domain, the sample detector is a good way to measure noise power because noise usually has a uniform spectrum with a normal amplitude distribution.
Signals may get lost if you are using the sample detector for measurements with a span that is greater than "RBW * 711".

- **RMS**

If the RMS detector is active, the R&S Spectrum Rider measures the spectral power over one pixel. In case of power measurements, the RMS detector always shows the true power of a signal, regardless of the shape of the signal.

The RMS detector is best for measurements on digitally modulated signals because it provides stable and true power readings. In combination with a high sweep time, you can increase the display stability even more because the measurement time for each pixel increases.

Noise measurements also provide stable results if you apply the RMS detector in combination with a high sweep time.

However, the bandwidth occupied by the signal to be measured should at least equal the frequency covered by a trace pixel or the selected resolution bandwidth (whichever is larger). Otherwise, the power the R&S Spectrum Rider shows is too low because there are spectral components within the frequency range covered by the pixel that do not originate from the signal you want to observe (e.g. noise).

To get the true power, the video bandwidth (VBW) should also be greater than the resolution bandwidth (RBW). Otherwise, an averaging effect caused by video bandlimiting comes into play before the RMS value is calculated.

The R&S Spectrum Rider provides automatic selection of the detector. In that case, the R&S Spectrum Rider selects the detector that is most suitable for the current trace mode.

Table 6-1: Auto selection of trace detector

Trace mode	Detector
"Clear/Write"	"Auto Peak"
"Average"	"Sample"
"Max Hold"	"Max Peak"
"Min Hold"	"Min Peak"

If you select the detector manually, the detector is independent of the trace mode.

6.2.7.3 Working with a second trace

In spectrum mode, you can use up to two traces. All two traces are based on the same settings, except the trace settings like the trace mode or the detector. You can use the second trace to compare, for example, four different detector settings.

In the default state, only trace 1 is active.

1. Press [TRACE] key.
2. Select "Show" softkey.
3. Select the "Enable Trace 2" menu item.
The R&S Spectrum Rider shows the second trace. The second trace is in a different color. To show that the second trace is active, the R&S Spectrum Rider displays the current active trace "Trace 1" or "Trace 2" on the "Parameter View".

Trace1 Min

Trace2 Clear

After you have activated the second trace, this trace becomes the active one. All actions (like changing the detector or trace mathematics) apply to the active trace.

4. Select "Select Trace" softkey.
Trace 1 becomes the active trace.



You can put both traces into the internal memory of the R&S Spectrum Rider and restore them later. Note that the memory trace 1 and memory trace 2 have a lighter tone color.

6.2.7.4 Working with memory traces

You can save the image of both traces to the memory of the R&S Spectrum Rider and later restore it and compare it to a live trace. The memory trace is always colored white to distinguish it from the live trace.



Measurement settings

Because the memory trace is just a bitmap, any modifications to measurement settings like span or reference level are not reflected in the memory trace.

When you save a data set, the R&S Spectrum Rider also stores the associated trace in the trace memory. If you restore it at a later time, you can display the memory trace as if it is a normal memory trace.

1. Press [TRACE] key.
2. Select the trace you want to store in the trace memory with the "Select Trace" softkey.
3. Select "Trace►Memory" softkey.
The R&S Spectrum Rider saves the active trace.
4. Select "Show" softkey.
5. Select the "Enable Memory 1 " menu item.
The R&S Spectrum Rider shows the corresponding memory trace. If active, it labels the "Memory <x>" menu item with an active radio button.

6.2.7.5 Using trace mathematics

Trace mathematics subtract the memory trace from the live trace and vice versa and then display the results.

1. Press [TRACE] key.
2. Select "Trace►Memory" softkey.
3. Select "Show" softkey.
4. Select "Trace Math" softkey.
5. Select the "Trace-Memory" or ""Memory-Trace"" menu item.
6. The R&S Spectrum Rider calculates and shows the resulting trace.
7. To turn off trace mathematics, select the "Off" menu item.

6.2.8 Using markers

The spectrum analyzer mode provides marker and deltamarker functionality. In addition, you can use several marker functions.

- [Using markers and deltamarkers](#)..... 196
- [Positioning markers](#).....197
- [Positioning a delta marker](#).....198
- [Selecting the marker type](#)..... 199
- [Automatic positioning of markers](#)..... 199
- [Removing markers](#).....200
- [Using marker search limits](#).....201
- [Using marker functions](#)..... 202

6.2.8.1 Using markers and deltamarkers



The R&S Spectrum Rider has six markers, five of which can be used as either markers or delta markers.

The markers cannot leave the trace and indicate the horizontal and vertical coordinates of the point they are positioned on. The horizontal position of a marker is shown by a vertical line which extends from the top to the bottom of the measurement diagram. The marker list above the diagram area shows the exact coordinates of all markers in use.

The position of a delta marker is indicated by a dashed line to distinguish it from a normal marker. The delta marker level is always a relative to the main marker level and so the delta marker level unit is always dB. The delta marker frequency is always relative to the main marker. The delta marker frequency is the frequency difference between the frequency at the point marked by the main marker and the frequency at the point marked by the delta marker.

To measure complex signals, you can activate up to six markers. Marker 1 is always a normal marker and the reference of all delta markers. Markers 2 to 6 are either markers or delta markers depending on your setup.

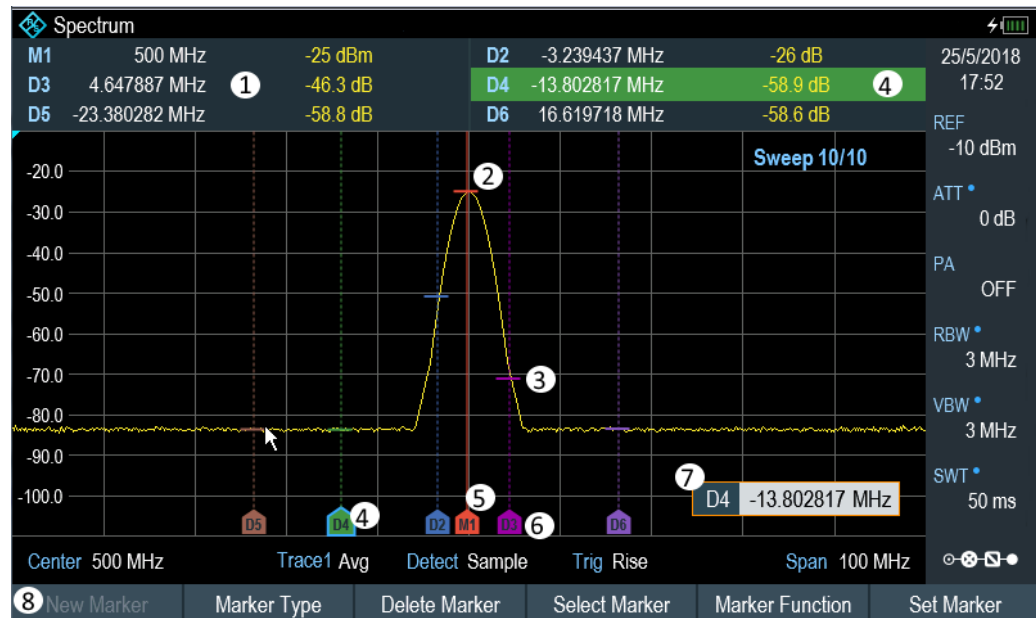

Figure 6-13: Screen layout with active markers

- 1 = Measurement result view
- 2 = Marker (solid line)
- 3 = Delta marker (dotted line)
- 4 = Active marker label (see highlighted line on the marker list as well as the marker label)
- 5 = Marker label: M(x)
- 6 = Delta marker label: D(x)
- 7 = Marker input field
- 8 = Marker menu

6.2.8.2 Positioning markers

1. Press [MARKER] key.
The marker menu opens.

If no marker has been activated, the R&S Spectrum Rider automatically activates the main marker and positions it on the maximum level that has been measured. In addition, the marker frequency input field opens.

You can perform the following actions:

- Position the marker with the rotary knob
When positioning the marker with the rotary knob, the step size is one pixel.
- Enter a marker position with the number keys and confirm the entry with one of the unit keys.

2. Confirm the marker position by pressing the rotary knob.

The [Measurement result view](#) shows the horizontal position of all markers and the corresponding vertical value. You can select any marker in the [Measurement result view](#) for further marker function using the marker softkey menu. You can also use rotary knob to select any of the markers displayed in the [Measurement result view](#).



Special touchscreen gesture

Alternatively, double tap on the touchscreen to position the marker on the trace window. The first marker that is positioned on the trace window is the main marker, the following markers added on the trace window are the delta markers.

See [Chapter 4.2.4, "Add marker"](#), on page 94.

6.2.8.3 Positioning a delta marker

When a normal marker is already in use, you can add delta markers.

1. Press [MARKER] key.
The marker menu opens.
2. Select "New Marker" softkey.
The R&S Spectrum Rider activates a delta marker and positions it on the next maximum level that has been measured. In addition, the delta marker input field opens. The R&S Spectrum Rider adds the delta marker to the marker list and shows the marker position relative to the normal marker (M1).
You can perform the following actions:
 - Enter a delta marker position with the number keys and confirm the entry with one of the unit keys.
 - Change the delta marker position with the rotary knob.
3. Confirm the delta marker position by pressing the rotary knob.
The delta marker input field closes.
4. To add more markers, press the "New Marker" softkey several times until you have the number of markers you want in the display.



Special touchscreen gesture

Alternatively, double tap on touchscreen to position the delta marker on the trace window.

See [Chapter 4.2.4, "Add marker"](#), on page 94.

6.2.8.4 Selecting the marker type

When you add new markers, they are delta markers by default. Their coordinates are relative to the first marker (M1). You can turn delta markers into normal markers if you need absolute information about the marker position.

1. Select the delta marker you want to convert in the [Measurement result view](#).
The selected marker is highlighted in the [Measurement result view](#) and its corresponding label in the trace window turns focus with a blue frame around the marker label. The R&S Spectrum Rider opens a marker input field.
Alternatively, you can press the [MARKER] key to select the delta marker you want to convert with the "Select Marker" softkey
2. Select "Marker Type" softkey.
The delta marker turns into a normal marker. Its label changes accordingly (e.g. D2 to M2) and its coordinates are now absolute values.

6.2.8.5 Automatic positioning of markers

The R&S Spectrum Rider offers functions that make setting the markers easier or allow to make instrument settings on the basis of the current marker position:

1. Press [MARKER] key.
2. Select the "Set to Peak", "Set to Next Peak" or "Set to Minimum" softkey.
The R&S Spectrum Rider positions the marker accordingly.

The R&S Spectrum Rider provides the following selections for automatic positioning of markers:

- "Set to Peak"
The peak function places the active marker or the delta marker on the highest level value of the trace.
- "Set to Next Peak"
The next peak function places the active marker or delta marker on the next highest level value of the trace, relative to its current position.
- "Set to Minimum"
The minimum function places the active marker or delta marker on the lowest value of the trace.

6.2.8.6 Removing markers

Remove markers any time you want from the trace window.

Removing selected markers

1. Select the marker you want to delete in the [Measurement result view](#).
Alternatively, you can select the marker you want to delete with the "Select Marker" softkey
The selected marker is highlighted in the [Measurement result view](#) and its corresponding label in the trace window turns focus with a blue frame around the marker label. The R&S Spectrum Rider opens a marker input field.
2. Select "Delete Marker" softkey.
3. Select "Delete Selected" menu item.
4. Confirm the selection by pressing the rotary knob.
The R&S Spectrum Rider deletes the marker.



Deactivating markers

If you delete marker 1 (M1), all delta markers that are relative to that marker are also deleted.

Removing delta markers only

1. Select the delta marker you want to delete in the [Measurement result view](#).
Alternatively, press the [MARKER] key.
2. Select "Delete Marker" softkey.
3. Select the "Delete All Delta" menu item.
4. Confirm the selection by pressing the rotary knob.
The R&S Spectrum Rider deletes all delta markers.

Removing all markers at the same time.

1. Press [MARKER] key.
2. Select "Delete Marker" softkey.
3. Select the "Delete All" menu item.
4. Confirm the selection by pressing the rotary knob.
The R&S Spectrum Rider deletes all markers and delta markers.

**Special touchscreen gesture**

Alternatively, draw an "x" on the trace window to delete all markers and delta markers on the trace window.

See [Chapter 4.2.6, "Delete all markers"](#), on page 96.

6.2.8.7 Using marker search limits

The R&S Spectrum Rider allows you to use only a limited section of the trace for the "Set to Peak", "Set to Next Peak" and "Minimum" functions.

1. Press [MARKER] key.
2. Select "Set Marker" softkey.
3. Select the "Search Range" menu item.
The R&S Spectrum Rider opens the marker search limits softkey menu.
4. Select "Select Marker" to define the marker position.
The R&S Spectrum Rider opens an input field to define the marker position.
5. Enter a desire marker position.
6. Confirm the entry with one of the unit keys.
7. Select "Selected Marker" if you want to apply the marker search limit on the selected marker.
The R&S Spectrum Rider displays the "Selected Marker" menu.
8. Select the "Search Range Off" menu item.
The R&S Spectrum Rider activates the marker search limits for the selected marker.
By default, the search limit range is over the whole span.
9. Select the "Lower Limit" menu item from "Search Range 1" section item.
The R&S Spectrum Rider opens an input field to define the lower limit of the search range for "Search Range 1" section item.



10. Enter the lower limit.
11. Confirm the entry with one of the unit keys.
12. Define the upper search limit the same way for "Search Range 1" section item.
13. Define the lower and upper search limit the same way for "Search Range 2" section item.
14. Select "Search Range 1" or "Search Range 2" section item.
The R&S Spectrum Rider activates the selected search range limit of the selected marker.
15. To perform auto update of new search peak in the [measurement result view](#), enable the "Marker Tracking" checkbox in the "Set Marker" softkey.

Deactivating marker search limits

1. Press "Selected Marker" softkey.
2. Select the "Search Range Off" menu item.
3. Confirm the selection by pressing the rotary knob.
The R&S Spectrum Rider turns off the marker search limit function for the selected marker.
4. To turn off the marker search limits function for all markers, select "All Markers" softkey and repeat the above steps

6.2.8.8 Using marker functions

In addition to the frequency and level readout, the R&S Spectrum Rider provides several, more complex, marker functions in spectrum analyzer mode.



Marker function frequency

Marker functions are only applied to the marker position at center frequency.



Deactivating marker functions

Selecting a marker function again while it is still active will turn that marker function off.

Measuring the noise power density

The marker noise function calculates the noise power density at the marker position in dBm/Hz. The R&S Spectrum Rider includes several variables in the calculation of the noise power density, including the trace pixel values, the resolution bandwidth, the detector and the level display mode (absolute or relative). To stabilize the noise power display, the R&S Spectrum Rider uses the pixel the marker is on and four pixels to the right and four pixels to the left of the marker pixel.

Noise power density can provide useful information when you are measuring noise or digitally modulated signals. However, you get valid results only if the spectrum in the vicinity of the marker has a flat frequency response. When measuring the noise power density on discrete signals, results are not valid.

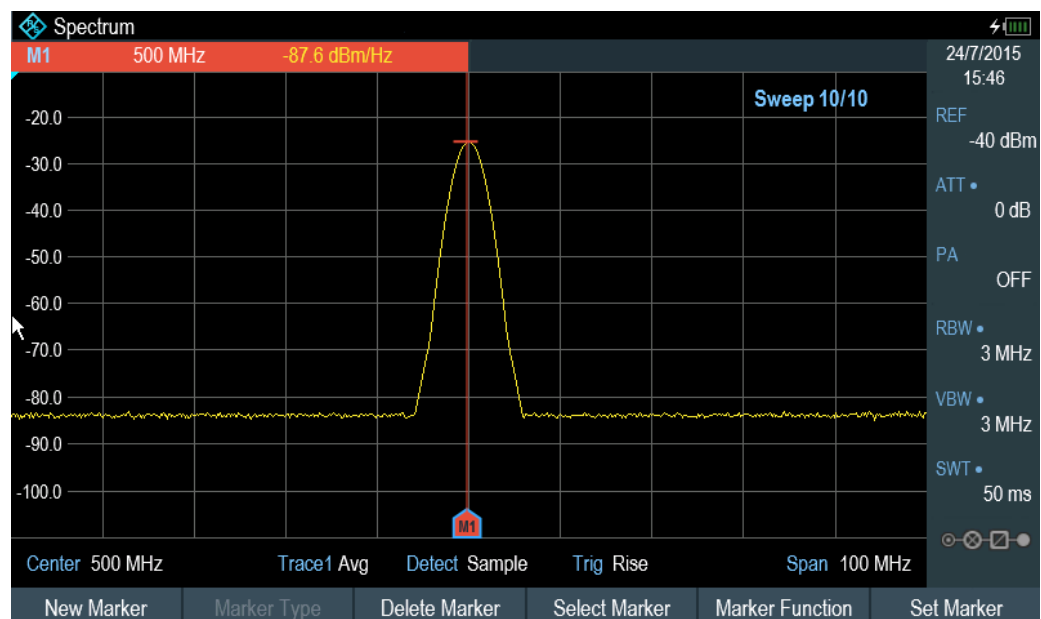

1. Press [MARKER] key
2. Select "Marker Function" key
3. Enable the "Noise" checkbox menu item.
The R&S Spectrum Rider shows the level at the marker frequency in dBm/Hz. If you are using a delta marker for the measurement, the results have the unit dBc/Hz with marker 1 being the reference.

Measuring the frequency

The R&S Spectrum Rider provides a frequency counter. The frequency counter accurately measures the frequency at the marker position.

When calculating the horizontal position of the marker, the R&S Spectrum Rider includes the current span, center frequency and the frequency of the pixel the marker is on. As the trace only has 711 pixels, the marker position is just an approximation, especially if the span is very wide.

With the frequency counter, however, you can get a more accurate result of the horizontal marker position. If the frequency counter is active, the R&S Spectrum Rider stops the measurement at the marker position for a short time and measures the frequency using the internal reference frequency.

The accuracy of the results therefore depends only on the accuracy of the internal reference frequency (TCXO). The frequency counter has a resolution of 0.1 Hz and therefore provides far more accurate results. Despite the accuracy, the measurement is still fast (because of a special algorithm for the I/Q baseband signal).

The frequency counter only gives accurate readings for sine signals that are at least 20 dB above the noise floor. If the S/N ratio is less, noise affects the results.

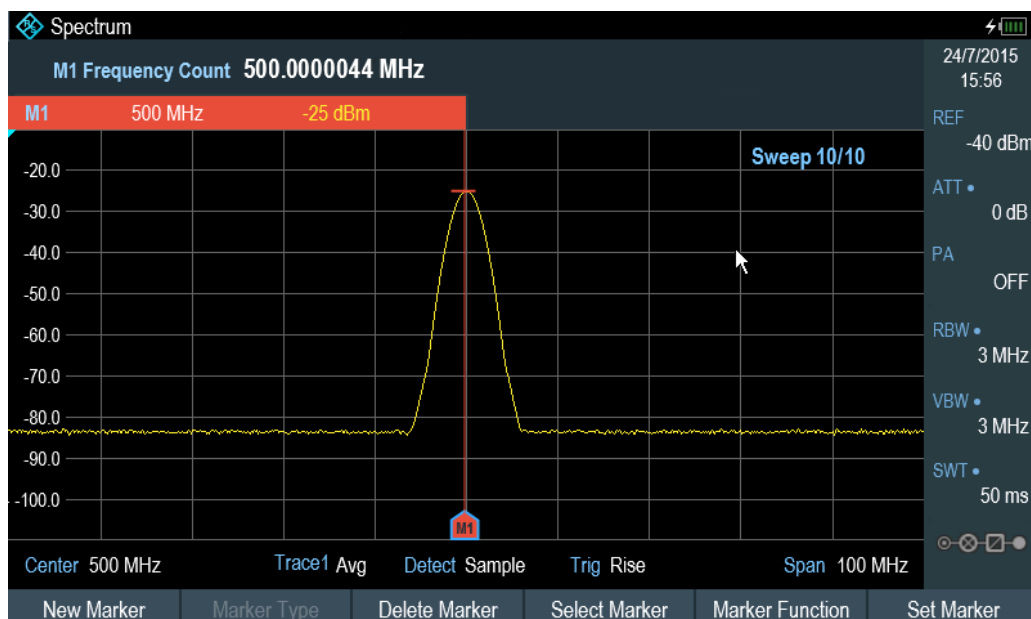

1. Press [MARKER] key.
2. Select "Marker Function" softkey.
3. Select the "Frequency Count" checkbox menu item.
The R&S Spectrum Rider displays the counted marker frequency with a resolution of 0.1 Hz.
4. To achieve high resolution (0.0001Hz) frequency counter, select "High Resolution" checkbox menu item.

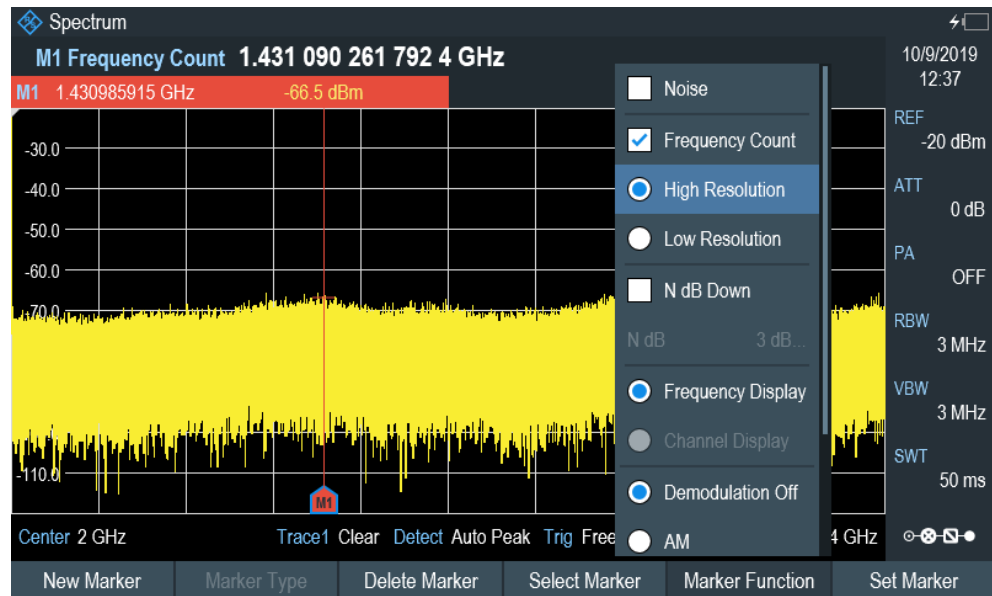

Measuring the signal bandwidth

The "n dB Down" marker function places two temporary markers to the left and to the right of the reference marker and measures the bandwidth between the two temporary markers. The function therefore is a good way to measure the bandwidth of a signal or the bandwidth of a filter, for example. The temporary markers are represented as two vertical lines.

The distance to the reference marker is by default 3 dB below the reference marker. You can also adjust this value manually. Entering a positive value sets the temporary markers below the reference marker. If it is, for any reason, not possible to calculate the frequency spacing, dashes are displayed instead of a value.

Upon entering a negative value, the function turns into an "n dB Up" function. You can use an "n dB Up" function, for example, for measurements on notch filters.

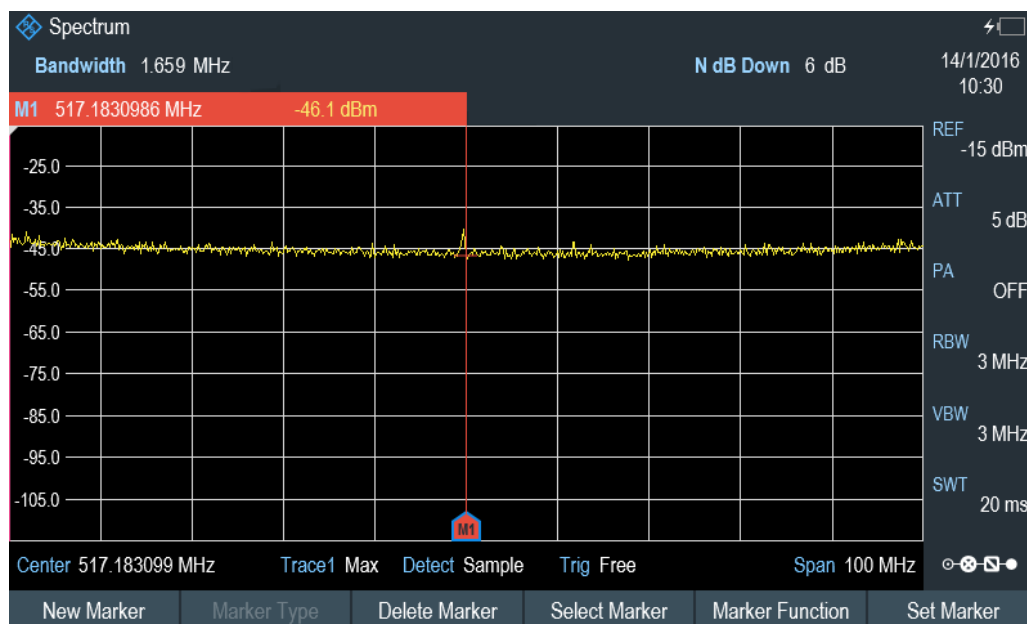

1. Press [MARKER] key.
2. Select "Marker Function" softkey.
3. Select the "n dB Down" menu item.
The R&S Spectrum Rider displays two temporary markers on the left and on the right of the reference marker, "M1". It also shows the bandwidth between the n dB down markers. You can then adjust the distance of the temporary markers.
4. Select "Marker Function" softkey.
5. Select the "n dB Down" menu item.
The R&S Spectrum Rider opens an input field.
6. Enter a different distance of 6 dB.
The R&S Spectrum Rider again shows the temporary markers, this time with a broader bandwidth.

Demodulating signals



If [gated trigger](#) is activated, the R&S Spectrum Rider disables the demodulator function in the [Marker Function](#).

If [signal source](#) is set to "Tracking", "CW" or "Coupled CW", the R&S Spectrum Rider disables the demodulator function in the [Marker Function](#).

The R&S Spectrum Rider features an AM and FM demodulator to demodulate and monitor audio signals. It demodulates the signal at the marker frequency.

You can listen to the demodulated signal with the internal speaker or headphones that you can connect to the 3.5 mm headphone jack on the top of the R&S Spectrum Rider. See ["Headphone jack"](#) on page 35.

When demodulating an AM modulated signal, the R&S Spectrum Rider turns the video voltage into an audible sound. You should therefore set the reference level to about the level of the signal that you are demodulating.

If you perform measurements in the time domain, the R&S Spectrum Rider demodulates continuously. In the frequency domain, you can define a time period the R&S Spectrum Rider demodulates the signal at the marker frequency. The frequency sweep then stops at the marker frequency for that time before finishing the sweep.

1. Press [MARKER] key.
2. Select "Marker Function" key.
3. Select the "AM" or "FM" demodulation scheme you require from the menu.
The R&S Spectrum Rider starts to demodulate the signal.



Defining the demodulation time period

1. Press [MARKER] key.
2. Select "Marker Function" softkey.
3. Select the "Time" menu item.
The R&S Spectrum Rider opens an input field to define the demodulation time.
4. Enter the demodulation time you need.
The range is from 100 ms to 500 s. In time domain, the R&S Spectrum Rider demodulates continuously, i.e. the demodulation time is not relevant.

Controlling the volume

1. Press [MARKER] key.
2. Select "Marker Function" softkey.
3. Select the "Volume" menu item.
The R&S Spectrum Rider opens an input field to define the demodulation volume.
4. Enter the volume you are comfortable with.
The demodulation volume is a percentage (0 % to 100 %) with 100 % being full volume.
For more information on general volume control, see [Chapter 3.2.10.7, "Configuring the audio output"](#), on page 63.

Mute function

- ▶ Select the speaker icon to mute  or unmute  the volume.
The speaker icon is located at the top right-hand corner of the trace window. It appears only when "Marker Function" is set to "AM" or "FM" demodulation scheme.

6.2.9 Using display lines

LINES

Like markers, display lines help you to determine the level of the signal.

A display line is a straight line that runs horizontally and corresponds to a certain level value. You can move the display line to each pixel in the display. This means that the accuracy and exact vertical position of the display line depends on the resolution of the vertical axis. With a display range of 100 dB, for example, each pixel corresponds to 0.3 dB. In that case, the accuracy of the display line is 0.3 dB. If you enter a value with a higher resolution, the R&S Spectrum Rider rounds that value.

You can also move the display line with the rotary knob. The step size for movement with the rotary knob is one pixel.

1. Press [LINES] key.
2. Select "Display Line" softkey.
The R&S Spectrum Rider displays the display line as a blue horizontal line. It shows the vertical position of the line in a table above the diagram area. When you activate the display line, the R&S Spectrum Rider also opens an input field to define the vertical position of the line.
3. Enter the level value you need.
The R&S Spectrum Rider positions the display line accordingly. Alternatively, you can also move the display line with the rotary knob.

6.2.10 Using limit lines

Limit lines help you to identify if a signal complies with certain level characteristics.

A limit line is made up out of two or more points that are connected to a line. Each of the points that define the shape of the limit line consists of two coordinates. One coordinate defines the horizontal position (e.g. frequency), the other one the vertical position. With the R&S Spectrum Rider, you can build limit lines that consist of up to 1000 points.

Values that define the horizontal characteristics of the limit line can be either absolute values (e.g. frequency in MHz) or relative values whose reference is the center of the measurement trace (e.g. the center frequency). Relative values are of advantage if you, for example, measure modulated output signals and you change the center frequency but need the limit line to remain the same. Absolute limit lines have the file extension ".abslim" while relative limit lines have the file extension ".rellim"

Values that define the vertical characteristics are always level values in dB. If the scaling of the vertical axis is currently a linear one (units V or W), the R&S Spectrum Rider automatically switches to a logarithmic scaling after you turn on the limit line.

After turning on a limit line, the R&S Spectrum Rider checks if the signal violates the shape of the limit line. If one or more signal levels exceed the limit value, the R&S Spectrum Rider features several indicators that the limit check has failed.

- A general message in the diagram header that indicates if the signal violates the limit line, including the trace that violates the limit: 

- An audio signal that sounds every time a limit is violated

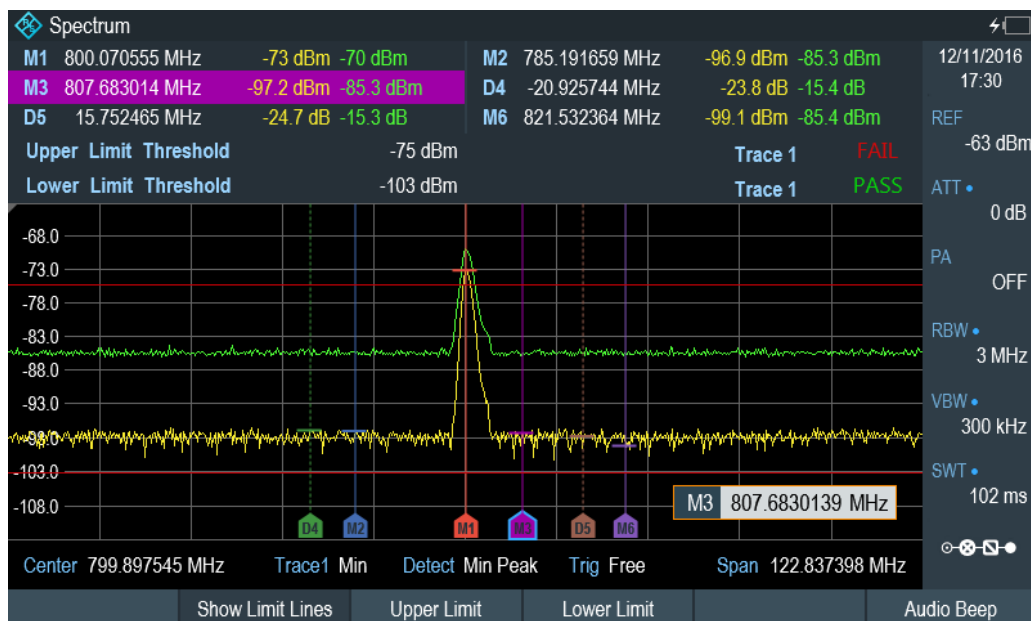

Figure 6-14: Upper and lower Limit Lines

You can create and edit limit lines with the R&S InstrumentView software and then transfer them into the internal memory of the R&S Spectrum Rider. The number of limit lines you can store in the memory depends on other datasets available on the R&S Spectrum Rider or if you are using an external storage device (e.g. memory stick).

For more information on limit lines, see [Chapter 4.8, "Managing datasets"](#), on page 105.

- [Selecting a limit line](#)..... 209
- [Performing limit checks](#)..... 210

6.2.10.1 Selecting a limit line

Before selecting a limit line, you need to decide if you want to use it as an upper or lower limit line. In case of upper limit lines, the R&S Spectrum Rider checks if the signal is above the limit line. In case of lower limit lines, the R&S Spectrum Rider checks if the signal is below the limit line.

You also have to make sure that the limit line is compatible to the scale of the horizontal axis.

1. Press [LINES] key.
2. Depending on the application, press the "Upper Limit" or "Lower Limit" softkey.
3. Select the "Load From File" menu item.
The R&S Spectrum Rider opens the "File Manager" dialog to select the limit line.
4. Select one of the available limit lines.

5. Select "Load" softkey.

The R&S Spectrum Rider activates the limit line. In the diagram, the limit line is displayed as a red line. See [Figure 6-14](#).

If you have already selected a limit line, you can turn the limit line on and off with the "Show Limit Lines" softkey.

Alternatively, you can define a threshold that works like a limit line. A threshold is a simple horizontal limit line.

1. Select the "Upper Limit" or "Lower Limit" softkey.

2. Select the "Set Threshold" menu item.

The R&S Spectrum Rider opens an input field to define the threshold.

3. Enter the threshold you need.

The R&S Spectrum Rider displays the line and performs a limit check for that threshold.



Threshold line and display line

Like the display line, a threshold line is a straight horizontal line. The difference is that the R&S Spectrum Rider performs a limit check for threshold lines, but not for display lines.

A failed limit check may be an issue if you want to create a measurement report, because measurements with failed limits are not included in this report.

Using a display line, you can use a line and are able to create a measurement report at the same time, regardless if any limits have been violated or not.

The process of turning off a limit line completely is similar to that of selecting a line.

1. Press "Show Limit Lines" softkey.

The R&S Spectrum Rider hides the limit line.

2. To remove the limit lines, select the "Upper Limit" or "Lower Limit" softkey.

3. Select "Remove" softkey.

The R&S Spectrum Rider removes the limit line.

6.2.10.2 Performing limit checks

If limit lines are active, the R&S Spectrum Rider automatically checks the trace for limit violations after each frequency sweep. As long as the signal does not violate the limit line, the R&S Spectrum Rider shows a "Pass" message in the measurement diagram. As soon as one single value (i.e. one pixel) is outside of the limits, the R&S Spectrum Rider displays a "Fail" message in the diagram area and, in addition, sounds a beep.

A limit check relates only to the frequency range defined by the limit line, not the span.

Audio signal

You can turn the acoustic signal that sounds in case of a limit violation on and off.

- ▶ Select the "Audio Beep" menu item.
Once selected, the audio beep is active, the R&S Spectrum Rider beeps each time a limit is violated.



Limit violation

Note that a limit check fails only if the signal exceeds the limit line. If the signal level is the same as the limit value, the limit check passes.

6.3 Working with channel tables

Almost all transmission systems divide their assigned frequency ranges into channels. Each channel corresponds to a specific frequency. To keep the handling of such systems simple, you can use channel tables instead of entering frequencies manually.

The R&S Spectrum Rider already comes with an assortment of channel tables that you can use without doing anything. If you want to test transmission standards that are not listed, you can also build channel tables manually with the "Channel Table Editor" of the R&S InstrumentView software package that is delivered with the R&S Spectrum Rider. To use one of the edited channels, you have to copy the channel table to the R&S Spectrum Rider.

For more information on channel table, see [Chapter 4.8, "Managing datasets"](#), on page 105.

Selecting a channel table

1. Press [FREQ] key.
2. Select "Freq Mode" softkey.
The R&S Spectrum Rider opens a submenu that contains the channel menu items.
3. Select the "Channel Downlink" or "Channel Uplink" menu item.
The R&S Spectrum Rider opens the "File Manager" dialog to select a channel table.
4. Select one of the available channel tables.
After activating the channel table, the R&S Spectrum Rider is set up according to the information contained in the channel table. Instead of a center frequency, the R&S Spectrum Rider shows the currently active channel number including the name of the channel. The center frequency of a channel is defined in the channel table and is the frequency corresponding to the selected channel.

Defining a downlink or uplink channel

It is important to note whether the channel number is assigned in the uplink or downlink channel.

1. Press [FREQ] key.

2. Select "Freq Mode" softkey.
The R&S Spectrum Rider opens a submenu that contains the channel menu items.
3. Select the "Set to Downlink " or "Set to Uplink" menu item.
The R&S Spectrum Rider maps the channel number to the appropriate uplink or downlink channel table.

Selecting a channel

Entering a center, start or stop frequency is not possible anymore. Instead you select a channel. The R&S Spectrum Rider then adjusts the center, start and stop frequency according to the channel table.

1. Press [FREQ] key.
2. Select "Center Frequency" softkey.
The R&S Spectrum Rider opens an input field to select the channel.
3. Enter the channel you want to perform measurements on.
The R&S Spectrum Rider changes the channel according to the channel table.
Channel numbers are assigned to frequencies as follows:
 - The first channel is assigned a channel number and a frequency.
 - All subsequent channels have ascending numbers.
 - The frequency spacing between channels is fixed. It can also be negative, i.e. the center frequency of the R&S Spectrum Rider decreases with ascending channel number.
 - In transmission systems containing gaps in the frequency range (as in the case of television, for example), a channel table can comprise multiple ranges.

6.4 Using transducer factors

The frequency-dependent transducer factor of transducers and antennas can be directly considered in the measurement result. A transducer factor consists of a numeric value and a unit. The R&S Spectrum Rider corrects the level values of the trace by the values of the transducer. At the same time, the unit of the transducer is assigned to the level axis. When field-strength measurements are performed with the aid of antennas, for instance, the electrical field strength is directly indicated in dB μ V/m on the R&S Spectrum Rider. A transducer factor can also be used to correct a frequency-dependent attenuation, e.g. of a cable between DUT and RF input of the R&S Spectrum Rider.

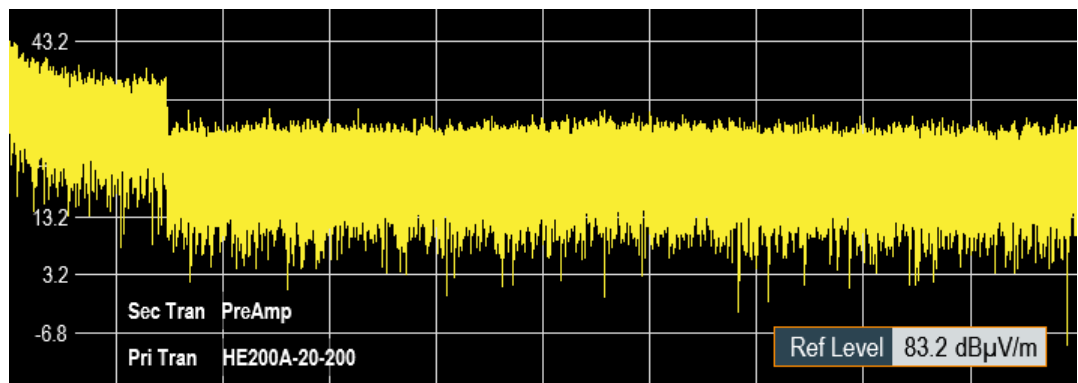

Figure 6-15: Transducer factors displayed

You can create and edit transducer factor with the R&S InstrumentView software package and then transfer them into the internal memory of the R&S Spectrum Rider. Each transducer factor may consist of up to 1000 reference values.

For more information on transducer factors, see [Chapter 4.8, "Managing datasets"](#), on page 105.

Interpolation between the values is performed with the aid of a modified spline algorithm. Even if only relatively few values such as maxima, minima and turning points are available, this algorithm can easily simulate the correction factors of common transducers. Two transducers can be switched on at a time. The second transducer must be assigned the unit dB. The R&S Spectrum Rider adds the two transducers to a total transducer.

Units supported for transducer factors:

- dB
- dBµV/m
- dBµA/m
- W/m²

The unit dB does not change the unit set on the R&S Spectrum Rider. It can be used, for instance, to compensate for frequency-dependent loss and gain at the input of the R&S Spectrum Rider. The units dBµV/m and dBµA/m convert the output power of an antenna into electric or magnetic field strength. The unit W/m² is used to calculate and display the power flux density.

For example, to compensate for the cable loss between the transducer and the RF input, the R&S Spectrum Rider can use two transducers at the same time. One of them must have the unit dB, however, i.e. it must correspond to one loss or gain value.

1. Press [AMPT] key.
2. Select "Transducer" softkey.



Transducer factor availability

Transducer factors are not available for measurements with the tracking generator or the Power Sensors. The "Transducer" softkey is therefore inactive.

You can select two transducer factors, a primary transducer and a secondary transducer. If a transducer factor is active, the checkbox next to the "Primary" or "Secondary" menu is enabled.

1. Select the "Select Primary" menu item.
The R&S Spectrum Rider opens the "File Manager" to select the transducer factor.
2. Select the transducer factor you need.
The R&S Spectrum Rider shows the name of the active transducer on the display (e.g. "Sec Tran PreAmp", "Pri Tran HE200A-20-200").
See [Figure 6-15](#).

An example would be the transducer factor of the R&S HE200-A antenna that is defined between 200 MHz and 500 MHz. The R&S Spectrum Rider therefore displays the noise in this frequency range as a function of frequency incremented by the transducer factor. Outside the transducer range, the R&S Spectrum Rider sets the transducer factor at zero, i.e. measurements in this range do not yield conclusive results.

You can select a second transducer factor with the "Select Secondary" menu item. The secondary transducer factor in that case is added to the first. The unit of the second transducer factor must always be the relative unit dB as otherwise an addition would not be useful. When you select a secondary transducer factor, the dialog box shows only those transducer factors that have dB as their unit.

- [Unit for measurements with transducers](#).....214
- [Setting the reference level](#)..... 215
- [Frequency range of transducer](#).....215
- [Data sets containing transducer factors](#).....215

6.4.1 Unit for measurements with transducers

If the unit of the transducer is dB, the units dBm, dBmV or dB μ V remain unchanged. The linear units Volt and Watt are not permissible. They are deactivated in the units menu.

If the unit of the transducer is dB μ V/m or dB μ A/m, this unit is also used for the R&S Spectrum Rider level display. This means that both the level axis of the diagram and the level at the marker position are assigned the unit of the transducer. If dB μ V/m is selected as the transducer unit, a switch to absolute level indication in V/m is possible.

1. Press [AMPT] key.
2. Select "Unit" softkey.
3. Select the "V" menu item.
If you are using a transducer with the unit dB μ A/m, it is not possible to select another unit. Level indication is entirely in dB μ A/m.

6.4.2 Setting the reference level

The transducer shifts the trace by its value as a function of frequency. Positive transducer values increase the level, negative values reduce it. To ensure that the trace is always within the diagram, the R&S Spectrum Rider adjusts the reference level accordingly. The reference level is shifted by the maximum transducer value in the positive or negative direction.

6.4.3 Frequency range of transducer

If the set frequency range is wider than the span in which a transducer is defined, the R&S Spectrum Rider assumes the transducer values outside the defined range to be zero.

6.4.4 Data sets containing transducer factors

The R&S Spectrum Rider stores data sets together with any transducer factors that may have been active for the measurement in question. When such a dataset is recalled, the associated transducer factor(s) are switched on as well. Transducer factors recalled as part of a data set do however not appear in the list of transducer factors.

7 Power meter



R&S Spectrum Rider option

R&S FPH-K9 (order number: 1321.0709.02) option is required to operate the R&S Spectrum Rider in the power meter mode.

For highly accurate power measurements, you can connect a power sensor to the R&S Spectrum Rider and perform measurements.

- [Using a power sensor](#)..... 216
- [Using a directional power sensor](#)..... 221

7.1 Using a power sensor

The power sensor function turns the R&S Spectrum Rider into a wideband power meter. It then always measures the power of the whole signal in the frequency range of the power sensor. In most cases, the signal shape has no effect on the measurement.

The power sensor measures the power in the frequency range defined in the data sheet of the power sensor. This means that you can measure both sine signals and modulated signals precisely over a large dynamic range.

For a complete list of supported power sensors, refer to the data sheet.

If you are using one of the NRP power sensors, you also need a passive USB adapter (R&S NRP-Z4) to connect the power sensor to the R&S Spectrum Rider.

For more information on the characteristics of the supported power sensors, see the following:

- The datasheet of the R&S Spectrum Rider.
- The website for R&S power sensors.

http://www.rohde-schwarz.com/en/products/test_and_measurement/power_volt_meter/NRPZ.html

1. Press [MODE] key.
2. Select "Power Meter" softkey
The R&S Spectrum Rider activates the mode for power meter measurement.



Figure 7-1: Screen layout of the power meter mode

- 1 = Connected power sensor model
- 2 = Reference for relative power measurements
- 3 = Measurement time
- 4 = Power offset
- 5 = Power measurement unit
- 6 = Analog readout of the measured power
- 7 = Readout of the measured power
- 8 = Measurement frequency
- 9 = Configuration overview icon
- 10 = Power sensor softkey menu

7.1.1 Connecting a power sensor

The R&S Spectrum Rider controls and powers the power sensors via the USB interface on the top of the instrument. See "[USB type A connector](#)" on page 35.

If you are using the R&S FSH-Z1 and R&S-FSH-Z18 power sensors, connect the power sensor cable to the FSH-Z144 (USB to binder adapter) before connecting it to the USB interface of the R&S Spectrum Rider.

For the test setup of the power sensor, see "[Test setup](#)" on page 84.

After connecting the power sensor to the R&S Spectrum Rider, you can connect the DUT to the N-connector of the power sensor.

NOTICE**Risk of damage to the power sensor**

Before you start to work with the power sensor, make sure that the continuous power applied to the input of the power sensor does not exceed a certain level.

Refer to the documentation of the power sensor for more information on the maximum input power.

If the R&S Spectrum Rider recognizes a power sensor, it sets up a connection via the interface and after a few seconds shows the measured power. It displays the type of the power sensor in the display header.

If no power sensor has been connected or it is not connected appropriately, the R&S Spectrum Rider shows nothing.

If there are communication problems between the R&S Spectrum Rider and the power sensor, the R&S Spectrum Rider displays one of the following error messages that indicate the possible cause.

Table 7-1: Error message for power sensor

Message	Cause	Remedy
Error in zeroing: signal at sensor	A signal was present at the power sensor when zeroing was performed.	Unscrew the power sensor from the device under test and repeat zeroing.
Warning: Input overloaded	The power at the input of the power sensor exceeds the permitted power (23 dBm = 200 mW).	Reduce the power at the sensor input.
Power sensor hardware error	Communication error between the R&S Spectrum Rider and the power sensor.	Unscrew the sensor from the R&S Spectrum Rider and check the connectors. If the problem persists, contact a Rohde & Schwarz service center.
Power sensor error	The power sensor signals an error to the R&S Spectrum Rider	Contact a Rohde & Schwarz service center.
Unknown power sensor model connected	The R&S Spectrum Rider cannot identify the device connected to the power sensor interface.	

7.1.2 Performing and configuring measurements

After you have connected a power sensor, the R&S Spectrum Rider immediately starts to measure the signal power.

Defining the center frequency or wavelength

Power sensors have a memory containing correction values that are dependent on the frequency or wavelength. Hence, measurement results are the most accurate for signals whose frequency or wavelength you know.

Center frequency

Note that the R&S Spectrum Rider maintains the center frequency that you have set in another operating mode. In that case, it uses that frequency as the power sensor frequency.

If you want to perform measurements on another known signal, you can change the power sensor frequency manually.

1. Select "Freq" softkey.
The R&S Spectrum Rider opens an input field to define the frequency.
2. Enter the frequency of the signal.
The R&S Spectrum Rider transfers the new frequency to the power sensor which then corrects the measured power readings.

Wavelength

Wavelength is typically used in the measurement result for optical power sensor measurement. The R&S Spectrum Rider supports the wavelength: 850 nm, 1300 nm, 1310 nm, 1490 nm, 1550 nm, 1610 nm, 1625 nm for measurement.

1. Select "wavelength" softkey.
The R&S Spectrum Rider opens a submenu for the selection of wavelength settings.
2. Select the required wavelength for measurement.
The R&S Spectrum Rider transfers the new wavelength to the power sensor which then corrects the measured power readings.

Zeroing the power sensor

Offset voltages and currents have most effect on the power readout when measuring low powers. You can compensate for these offsets by zeroing the power sensor.

Do not apply power during the zeroing process, as the power sensor cannot distinguish between external powers and internal offsets.



1. Select "Zero" softkey.
2. The R&S Spectrum Rider asks you not to apply any signals to the power sensor during the zeroing process.
3. Disconnect the power sensor from any signal sources.
4. Select "Continue" softkey to start zeroing.

5. Select "Cancel" softkey to abort zeroing, for example, if you cannot disconnect the signal source.

The R&S Spectrum Rider immediately starts power sensor zeroing.

While zeroing is in progress, the R&S Spectrum Rider shows the message "Zeroing power sensor, please wait while the system is zeroing the power sensor".

When zeroing is over, the R&S Spectrum Rider displays the message "✓ Power sensor zero done".

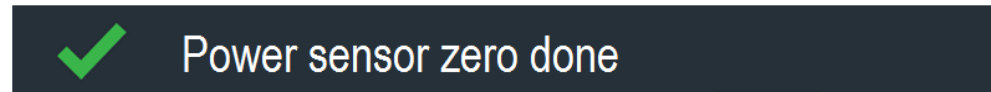

Selecting the unit for the power readout

The R&S Spectrum Rider can display measured power in relative units (dBm) or in absolute units (W, mW, μ W, nW and ρ W). It is also possible to set a reference level in dB.

1. Select "Unit" softkey.
A submenu to select the unit opens.
2. Select the unit you require.
The R&S Spectrum Rider adjusts the result display accordingly.

Setting the reference level

If you have selected the unit dB Rel, the R&S Spectrum Rider opens an input field to set the reference level. The R&S Spectrum Rider shows the currently set reference level in the diagram header.

1. Enter the reference level you require.
Alternatively, you can set the current level readout as the reference level.
2. Select "To Ref" softkey.
The R&S Spectrum Rider sets the current result as the reference level.
It then displays the measured level relative to the reference level in dB. The unit is automatically set to dB Rel.

Setting the averaging time

The averaging time determines the length of the measurement. The longer the averaging time, the more stable the display, particularly if signals have low power or are noisy.

The averaging time is either "Short", "Normal" or "Long".

- A short measurement time provides stable and accurate results for stationary sine signals with high levels (> -40 dBm). It is also appropriate for measurements that require a high repetition rate.
- A normal measurement time increases the stability of results for signals with low levels or modulated signals.
- A long measurement time is appropriate for signals with very low-power levels (< -50 dBm)

To eliminate noise and the effects of noise on the measurement effectively, use the R&S FSH-Z1 power sensor.

1. Select "MeasTime" softkey.
2. Select the measurement time most suitable for your test setup.

Taking additional loss or gain into account

At high powers that cause the power sensor maximum input level to be exceeded or at very low levels that are below the R&S Spectrum Rider minimum sensitivity, the R&S Spectrum Rider can take additional loss or gain between the DUT and the power sensor into account. These differences are defined in terms of an offset in dB relative to the measured level. A positive offset corresponds to a loss and a negative offset corresponds to a gain.

The R&S Spectrum Rider shows the current offset in the diagram header.

1. Select "OFS" softkey.
The R&S Spectrum Rider opens an input field to define the reference offset.
2. Enter the offset you require.
The R&S Spectrum Rider takes the offset value into account in the power or level display.

7.2 Using a directional power sensor

For power measurements in both directions (forward and reverse), you can connect directional power sensors to the R&S Spectrum Rider. The R&S Spectrum Rider supports the following directional power sensors:

- R&S FSH-Z14
- R&S FSH-Z44

With a directional power sensor, the R&S Spectrum Rider measures the power of a signal from source to load (forward power) and from load to source (reverse power). The ratio of forward and reverse power is a measure of the load matching. The R&S Spectrum Rider displays the results as the return loss or the standing wave ratio.

1. Press [MODE] key.
2. Select "Power Meter" softkey
The R&S Spectrum Rider activates the mode for power measurements.

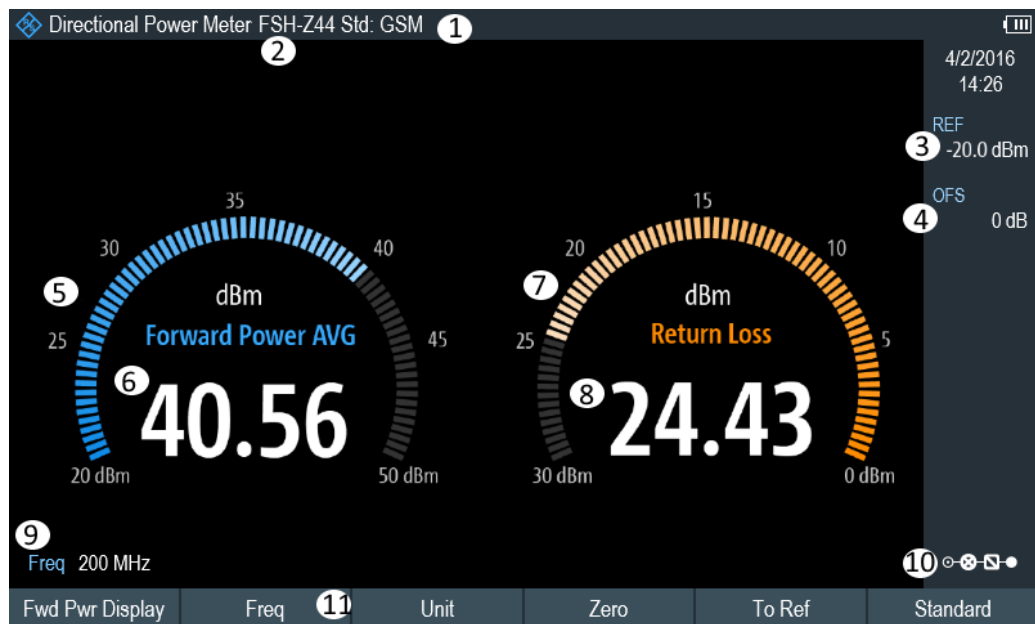

Figure 7-2: Screen layout of the directional power mode

- 1 = Selected transmission standard
- 2 = Connected power sensor model
- 3 = Reference for relative power measurements
- 4 = Power offset
- 5 = Readout of the forward power
- 6 = Analog readout of the forward power
- 7 = Readout of the matching value
- 8 = Analog readout of the matching value
- 9 = Measurement frequency
- 10 = Configuration overview icon
- 11 = Directional power sensor "MEAS" softkey menu

7.2.1 Connecting a directional power sensor

The R&S Spectrum Rider controls and powers the directional power sensors via a special interface on the top of the instrument.

Connect the power sensor cable via the USB to binder adapter to the USB port of R&S Spectrum Rider. The power sensor itself is located between the source and the load of the test setup.

For the test setup of the directional power sensor, see ["Test setup"](#) on page 84.

If the R&S Spectrum Rider recognizes a power sensor, it sets up a connection via the interface and after a few seconds shows the results. It displays the type of the power sensor in the display header. If an error occurs, the R&S Spectrum Rider shows a corresponding message.

For more information, see [Chapter 7.1.1, "Connecting a power sensor"](#), on page 217.

7.2.2 Performing and configuring measurements

After you have connected a power sensor, the R&S Spectrum Rider immediately starts to measure the signal power.

When measuring high powers, pay strict attention to the following instructions to avoid personal injury and to prevent the power sensor from being destroyed.

CAUTION

Risk of skin burns and / or damage to the R&S Spectrum Rider

Measuring high powers may lead to skin burns and / or damage to the R&S Spectrum Rider. You can avoid it by:

- Never exceeding the permissible continuous power. The permissible continuous power is indicated on a diagram on the back of the power sensor.
- Turning off the RF power when connecting the power sensor.
- Connecting the RF connectors tightly.

Defining the center frequency

To get the most accurate results, you should synchronize the frequency to that of the signal.

Note that the R&S Spectrum Rider maintains the center frequency that you have set in another operating mode. In that case, it uses that frequency as the power sensor frequency.

If you want to perform measurements on another known signal, you can change the power sensor frequency manually.

1. Select "Freq" softkey.
The R&S Spectrum Rider opens an input field to define the frequency.
2. Enter the frequency of the signal.
The R&S Spectrum Rider transfers the new frequency to the power sensor which then corrects the measured power readings.

Zeroing the power sensor

For more information, see ["Zeroing the power sensor"](#) on page 219.

Setting the power measurement weighting mode

For forward power display, the R&S Spectrum Rider provides both average power and peak envelope power.

1. Press [MEAS] key.
2. Select "Fwr Pwr Display" softkey.
3. Select the weighting mode you require.

The R&S Spectrum Rider indicates the weighting mode at the forward power heading.

- "Average" = average power
- "Peak Envelope" = peak envelope power

Selecting the unit for the power readout

When using a directional power sensor, the R&S Spectrum Rider displays the forward power as a logarithmic level value in dBm (relative value) or as a linear value in W or mW (absolute value). In addition, you can define a reference level relative to which the R&S Spectrum Rider indicates the level difference in dB. Load matching is indicated as return loss in dB or as voltage standing wave ratio (VSWR). In addition, the absolutely reflected power can be displayed in W, or the reflected level in dBm.

For more information, see ["Selecting the unit for the power readout"](#) on page 220.

Setting the reference level

If you have selected the unit dB Rel for the forward power, the R&S Spectrum Rider opens an input field to set the reference level. The R&S Spectrum Rider shows the currently set reference level in the diagram header.

For more information, see ["Setting the reference level"](#) on page 220.

Selecting a standard

To ensure that true results are output when measuring modulated signals, the R&S Spectrum Rider offers the possibility of taking correction values into account for several common telecommunications standards.

1. Select "Standard" softkey.
A menu to select a standard opens.
2. Select the standard you require.
The R&S Spectrum Rider takes the selected standard into account. The currently active standard is displayed in the display header.

Taking additional attenuation into account

When the directional power sensor is connected to a test point not directly but via a cable, the influence of cable attenuation can be taken into account. For this purpose, the cable attenuation for the measurement frequency in question is to be entered is based on the following condition:

Condition for setting cable attenuation

- As a positive dB value if the power and matching are to be measured at the source and the cable is connected between the source and the power sensor
- As a negative dB value if the power and matching are to be measured at the load and the cable is connected between the load and the power sensor

The directional power sensor then corrects the power and matching values to produce the results that would have been obtained if it had been directly connected to the test point.

1. Select "OFS" softkey.
The R&S Spectrum Rider opens an input field to define the reference offset.
2. Enter the offset you require.
The R&S Spectrum Rider takes the offset value into account in the power (level) and matching results.

If high powers are applied that exceed the maximum input level of the R&S FSH-Z14 or R&S FSH-Z44, a directional coupler or an attenuator has to be connected ahead of the power sensor.

In such cases, the coupling attenuation of the directional coupler or the attenuation value of the attenuator are entered as positive dB values (see [condition to set cable attenuation](#)) into the R&S Spectrum Rider to ensure true measured power readout. In both cases, a termination or an attenuator of sufficient power-handling capacity has to be connected to the power sensor at the load end. The matching readout is irrelevant in such case since it is likewise corrected by taking into account the attenuation value of the termination or attenuator.

8 Using the internal power meter



R&S Spectrum Rider option

R&S FPH-K19 (order number: 1321.0721.02) option is required to operate the R&S Spectrum Rider in the internal power mode.

With the installation of internal power meter option, the R&S Spectrum Rider also supports power measurements without using a power sensor. In that case, you can connect the DUT directly to the R&S Spectrum Rider and still perform accurate channel power measurements.

Test setup

Connect the DUT to the RF input shown below:

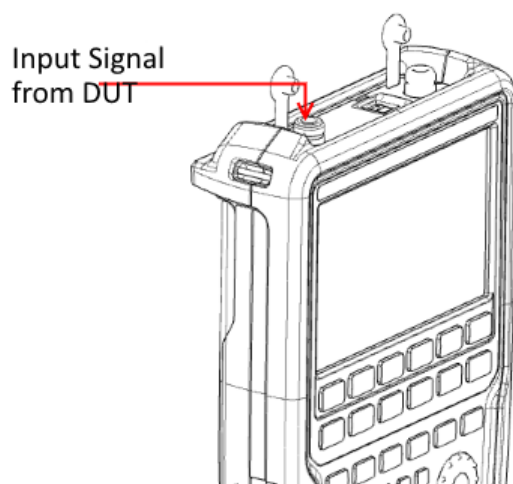

Measuring the power

1. Press [MODE] key.
2. Select "Power Meter" softkey.
The R&S Spectrum Rider switches its operating mode and shows the measured power level in dBm.

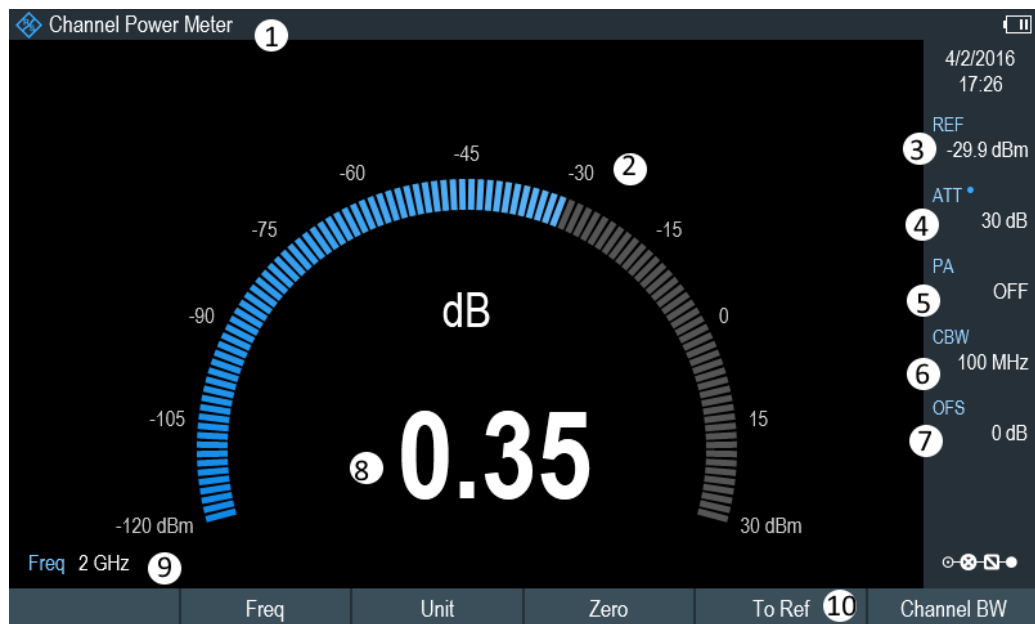

Figure 8-1: Channel power meter measurement

- 1 = Channel power meter mode
- 2 = Readout of the measured power
- 3 = Reference for relative power measurements
- 4 = RF attenuation setting
- 5 = Preamplifier state
- 6 = Measurement channel bandwidth
- 7 = Power offset
- 8 = Analog readout of the measured power
- 9 = Measurement frequency
- 10 = Channel power softkey menu

Performing and configuring power measurements

The configuration of power measurements without a power sensor is similar to measurement with a power meter.

The following features are available:

- Defining the frequency
- Zeroing the measurement
- Selecting the unit
- Defining the reference level
- Taking additional loss or gain into account

For more information, see [Chapter 7.1.2, "Performing and configuring measurements"](#), on page 218.

Defining the channel bandwidth

In addition, you can select the channel bandwidth.

1. Press [MEAS] key.

2. Select "Channel BW" softkey.
The R&S Spectrum Rider opens an input field to define the channel bandwidth.
3. Enter the channel bandwidth you require.
The R&S Spectrum Rider performs a measurement on the selected channel. Note that it is not possible to change the measurement time, resolution bandwidth and frequency span.

9 Performing pulse power measurements



R&S Spectrum Rider option

R&S FPH-K29 (order number: 1321.0738.02) option is required to operate the R&S Spectrum Rider in the pulse power meter mode.

When you equip the R&S Spectrum Rider with the pulse power measurement option and connect one of the wideband power sensors available from Rohde & Schwarz (R&S NRP-Z81, -Z85 or -Z86), you can perform pulse power measurements with your R&S Spectrum Rider.

Like the normal power meter application, the pulse power application measures the power of the whole signal in the frequency range of the (wideband) power sensor.

1. Press [MODE] key.
2. Select "Power Meter" softkey
The R&S Spectrum Rider activates the mode for power measurements.

Connecting the power sensor

You can connect the wideband power sensors to the USB port of the R&S Spectrum Rider. For more information, see [Chapter 7.1.1, "Connecting a power sensor"](#), on page 217.

The measurement starts as soon as the power sensor is connected.

Numerical result display

1. Press [MEAS] key.
2. Select "Meas Mode" softkey.
3. Select the "Average" menu item.

The layout and contents of the numerical result display are the same as those described in [Figure 7-1](#).

Graphical result display (Power vs Time)

The graphical representation of the results is a special feature only available with the firmware option R&S FPH-K29.

1. Press [MEAS] key.
2. Select "Meas mode" softkey.
3. Select the "Power vs Time" menu item.

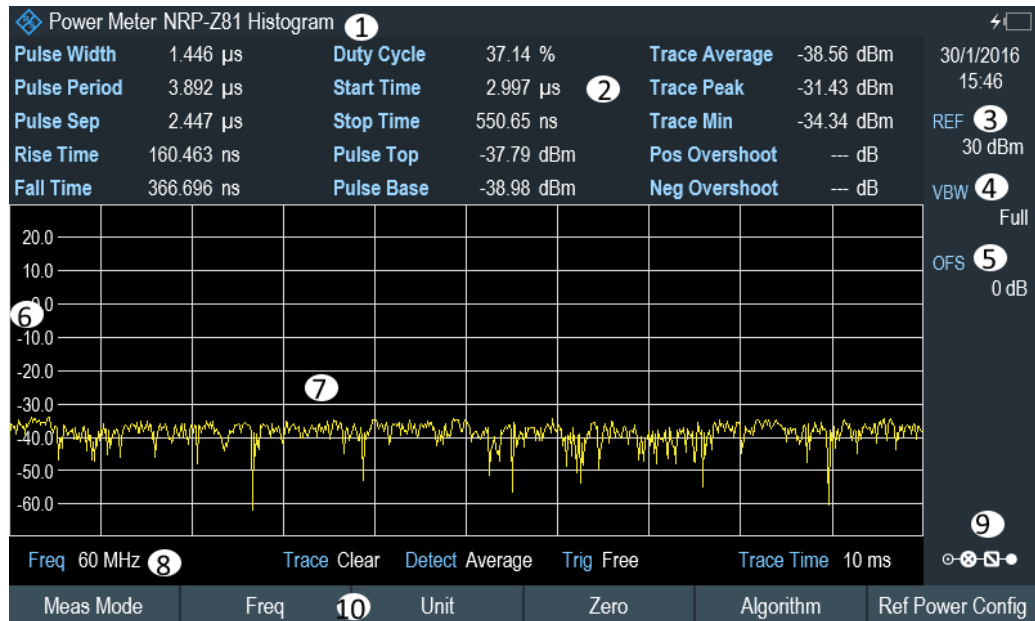

Figure 9-1: Power vs time display

- 1 = Connected power sensor model and type of algorithm for power calculation
- 2 = Numerical results showing the pulse characteristics
- 3 = Reference for relative power measurements
- 4 = Power offset
- 5 = Video bandwidth
- 6 = Scale of the x-axis
- 7 = Diagram showing the pulse characteristics in a graphical format (trace display)
- 8 = Measurement frequency
- 9 = Configuring overview icon
- 10 = Softkey menu of the pulse power measurement application

The following power characteristics are calculated and displayed as numerical values. See [Figure 9-2](#) for a graphical representation of the parameters.

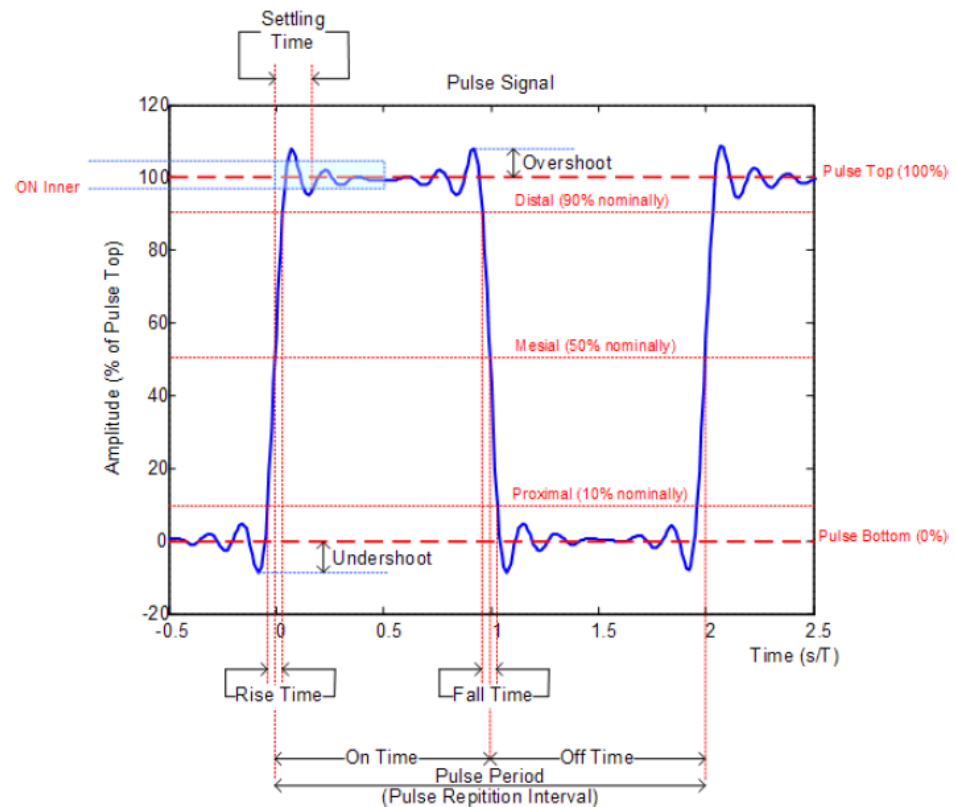

Figure 9-2: Graphical representation of pulse characteristic

Pulse characteristic	Description
"Pulse Width"	Time that the pulse remains at the top level ("ON"). This is the time between the first positive edge and the subsequent negative edge of the pulse in seconds, where the edges occur at crossings of the mid threshold.
"Pulse Period"	Time that is elapsing from the beginning of one pulse to the beginning of the next pulse.
"Pulse Off Time"	Time in the displayed trace that is not occupied by the pulse.
"Rise Time"	Time required for the pulse to transition from the base to the top level. This is the difference between the time at which the pulse exceeds the lower and upper thresholds.
"Fall Time"	Time required for the pulse to transition from the top to the base level. This is the difference between the time at which the pulse drops below the upper and lower thresholds.
"Duty Cycle"	Ratio of the "Pulse Width" to "Pulse Repetition Interval" expressed as a percentage (requires at least two measured pulses).

Pulse characteristic	Description
"Start Time"	Time offset, relative to the beginning of the trace (0 sec), where the pulse begins (start of the rise time).
"Stop Time"	Time offset, relative to the beginning of the trace (0 sec), where the pulse stops (end of the fall time).
"Pulse Top"	Median pulse ON power. The value of this parameter is used as a reference (100%) to determine other parameter values such as the rising / falling thresholds.
"Pulse Base"	Median pulse OFF power. The value of this parameter is used as a reference (0 %) to determine other parameter values such as the rising / falling thresholds.
"Trace Avg"	Average power of the signal displayed in the diagram.
"Trace Peak"	Maximum power of the signal displayed in the diagram.
"Trace Min"	Minimum power of the signal displayed in the diagram.
"Positive Overshoot"	Height of the local maximum after a rising edge, divided by the pulse amplitude. The result is a percentage of the pulse amplitude.
"Negative Overshoot"	Height of the local minimum after a rising edge, divided by the pulse amplitude. The result is a percentage of the pulse amplitude.

9.1 Configuring the numerical result display

The functions available for the numerical result display are the same as those available for normal power sensor measurements.

For more information, see [Chapter 7.1.2, "Performing and configuring measurements"](#), on page 218.

9.2 Configuring the power vs time result display

The R&S Spectrum Rider allows you to configure several aspects of the power vs time result display and the way the pulse is measured.

- [Determining pulse characteristics](#)..... 233
- [Selecting the video bandwidth](#)..... 234
- [Averaging traces](#)..... 234
- [Triggering measurements](#)..... 235

- [Selecting the result unit](#).....236
- [Scaling the y-axis](#).....236
- [Using markers](#).....236

9.2.1 Determining pulse characteristics

Selecting an algorithm for base and top power calculation

The R&S Spectrum Rider provides several methods (or algorithms) to calculate the base and top power of a pulse.

- "Histogram"
Calculates the top and base power of the pulse by analyzing the histogram of the trace data. The level of the pulse top calculated by the mean value of all points representing the pulse top. Similarly the level of the pulse base is calculated by the points representing the pulse base.
This algorithm is recommended for analyzing most of the pulse signals
- "Integration"
Calculates the top power of the pulse by fitting a rectangle pulse of the same energy into the pulse signal as a reference.
This algorithm is recommended for modulated pulse signals or when the pulse energy must be taken into account, for example when you want to compare the measurement result with that of a thermal power sensor.
- "Peak"
Assumes that the peak power of the pulse is also the top level of the pulse.

The top and base power is also the reference point for the calculation of pulse timing characteristics.

1. Press [MEAS] key.
2. Select "Algorithm" softkey.
3. Select the algorithm you prefer for your measurement.
The R&S Spectrum Rider adjusts the results accordingly.

Defining reference levels for pulse timing calculation

To calculate pulse timing parameters, like the rise and fall time of the pulse, you have to define several reference levels. All reference levels are a percentage of the pulse amplitude, either expressed in terms of power (Watt) or voltage (Volt).

The "Low Reference Power" and "High Reference Power" are required to calculate the fall and rise times of the measured pulse. The "Low Reference Power" defines the level at the start of the rising edge and the level at the end of the falling edge of the pulse. The "High Reference Power" defines the level at end of the rising edge and the level at the start of the falling edge.

The "Reference Power" is required to calculate the pulse width, its start time and its stop time.

1. Press [MEAS] key.
2. Select "Ref Power Config" softkey.
3. Define the reference levels as required.

You can always reset the reference levels to their default value with the "Set to Default" menu item.

All the reference levels can be relative to the power or the voltage of the signal. Depending on this selection, different measurement points are being analyzed, so the results may be different.

1. Press [MEAS] key.
2. Select "Ref Power Config" softkey.
3. Select either the "Related to Power" or the "Related to Voltage" menu item as the reference.

9.2.2 Selecting the video bandwidth

When you are using a wideband power sensor, you can change the video bandwidth used for the measurement. The main effect of using a small video bandwidth is that it reduces the displayed inherent noise.

Using a small video bandwidth thus increases the measurement sensitivity and allows you to accurately determine the pulse peak power even for weak pulses. Reducing the video bandwidth also increases the trigger sensitivity of the power sensor.

Note that the video bandwidth should not be smaller than the RF bandwidth of the measured signal. Otherwise, measurement results may become invalid.

9.2.3 Averaging traces

Selecting the trace mode

The "Power" vs "Time" result display provides two trace modes.

- The "Clear / Write" mode overwrites the trace data after each measurement.
- The "Average" mode forms an average over several measurements and displays the data according to the selected detector.

When you select this mode, you can define the number of measurements over which the trace data is calculated. When you select this mode, you can define the number of measurements over which the trace data is calculated.

1. Select "Trace" softkey
2. Select the trace mode you prefer for the measurement.

Selecting the detector

When you are averaging traces, you can also select a detector. The detector defines the way the measured data is evaluated and which data is displayed.

In the "Power" vs "Time" result display, you can select the "Average" detector or the "Max Peak" detector. The "Average" detector displays the averaged measurement data, while the "Max Peak" detector displays the highest values that have been measured on each pixel.

1. Select "Detect" softkey.
2. Select the detector you prefer.

9.2.4 Triggering measurements

In its default state, the R&S Spectrum Rider starts a measurement on completion of the previous measurement ("Free Run" measurements).

However, you can also perform triggered measurements with the power sensor. When you choose to do so, the trigger event (the moment when the actual measurement starts) is either a rising slope in the signal or a falling slope ("Positive" or "Negative" trigger).

1. Press [SWEEP] key.
2. Select "Trigger" softkey.
3. Select either the "Positive" or "Negative" menu item.
The R&S Spectrum Rider stops measuring the signal until a trigger event occurs.

In case of triggered measurements, you have to define a trigger level by which the signal must rise or fall in order to be recognized.

1. Press [SWEEP] softkey.
2. Select "Trigger" softkey.
3. Select either the "Trigger Level" menu item and define a trigger level.

In addition, you can define a trigger delay time. The trigger delay time defines a time that must pass after the trigger event has occurred before the measurement starts. A negative trigger delay time is called a pre-trigger.

1. Press [SWEEP] softkey.
2. Select "Trigger" softkey.
3. Select either the "Trigger Delay" menu item and define a delay time.
When a trigger event occurs, the R&S Spectrum Rider takes the delay time into account when drawing the trace.

9.2.5 Selecting the result unit

In the pulse measurement application, the R&S R&S Spectrum Rider can display measured power in relative units (dBm) or in absolute units (W).

1. Press [AMPT] key.
2. Select "Unit" softkey.
3. Select the unit you prefer.
The R&S Spectrum Rider adjusts the y-axis accordingly.

9.2.6 Scaling the y-axis

The functionality to scale the y-axis is similar to that of the spectrum application.

For more information, see [Chapter 6.2.3.2, "Setting a display range"](#), on page 178.

9.2.7 Using markers

The "Power" vs "Time" diagram supports markers. The functionality is similar to that of the spectrum application.

For more information, see [Chapter 6.2.8, "Using markers"](#), on page 196 (note that the marker functions are not available in the "Power vs Time" measurement mode).

10 Modulation analysis



R&S Spectrum Rider option

R&S FPH-K7 (order number: 1321.0696.02) option is required to operate the R&S Spectrum Rider in both analog and digital demodulation mode..

10.1 Analog demodulation

The Analog Demodulation measurement analyzes the AM or FM modulated signals and calculates the [analog modulation parameters](#) using the measurement results. Note that the measurement works properly only if you apply an amplitude or frequency modulated signal. This firmware option provides the necessary measurement functions to analyze amplitude and frequency modulated signals.

The digital signal processing in the R&S Spectrum Rider is used for demodulating amplitude and frequency modulated signals.

By sampling (digitization) already at the IF and digital down-conversion to the base-band (I/Q), the demodulator achieves maximum accuracy and temperature stability. There is no evidence of typical errors of an analog down-conversion and demodulation like AM to FM conversion and vice versa, deviation error, frequency response or frequency drift at DC coupling.

1. Press [MODE] key.
The R&S Spectrum Rider opens the mode menu.
2. Select "Analog Demod" softkey
The R&S Spectrum Rider activates the mode for analog demodulation.
See index 1 of [Figure 10-1](#).
3. Press [MEAS] key.
The R&S Spectrum Rider opens the analog demodulation measurement menu.
The measurements are performed in two analog demodulation domains: "AM Domain" or "FM Domain" and the measurement readings are available in two different selections: "Mod Trace" and "Mod Summary".
4. Select the analog demodulation domain you require and measurement selection to view the measurement readings.
The R&S Spectrum Rider displays the respective analog demodulation measurement. See examples in [Figure 10-1](#)

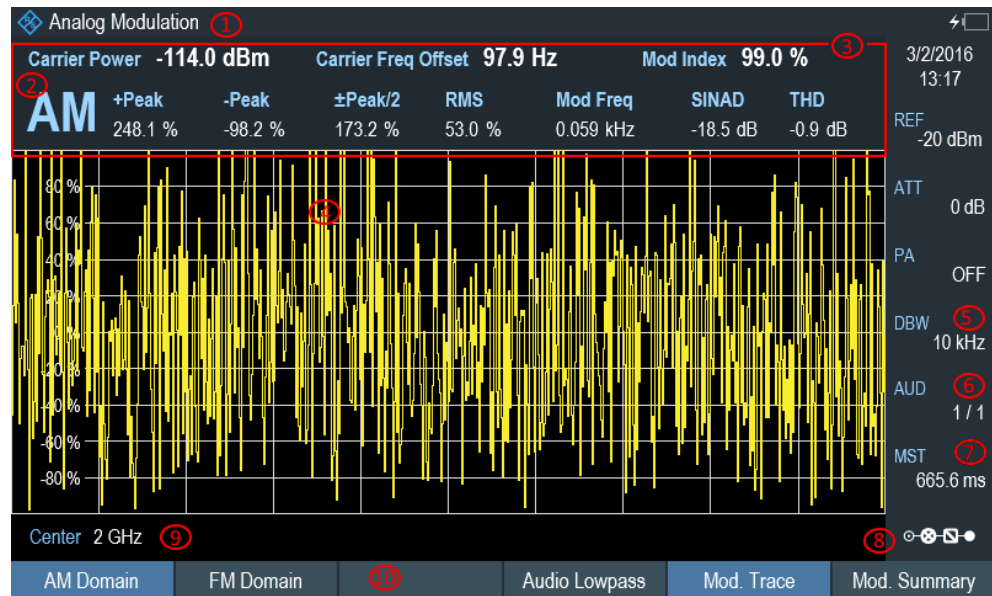

Figure 10-1: AM domain

- 1 = Title bar
- 2 = AM or FM modulation
- 3 = Analog modulation parameters
- 4 = Modulation trace window
- 5 = Demodulation bandwidth
- 6 = Audio lowpass filter
- 7 = Measurement time
- 8 = "Configuration overview" on page 42
- 9 = Carrier frequency
- 10 = Softkey menu of analog modulation measurement. See Chapter 10.1.3.1, "Analog modulation", on page 243.

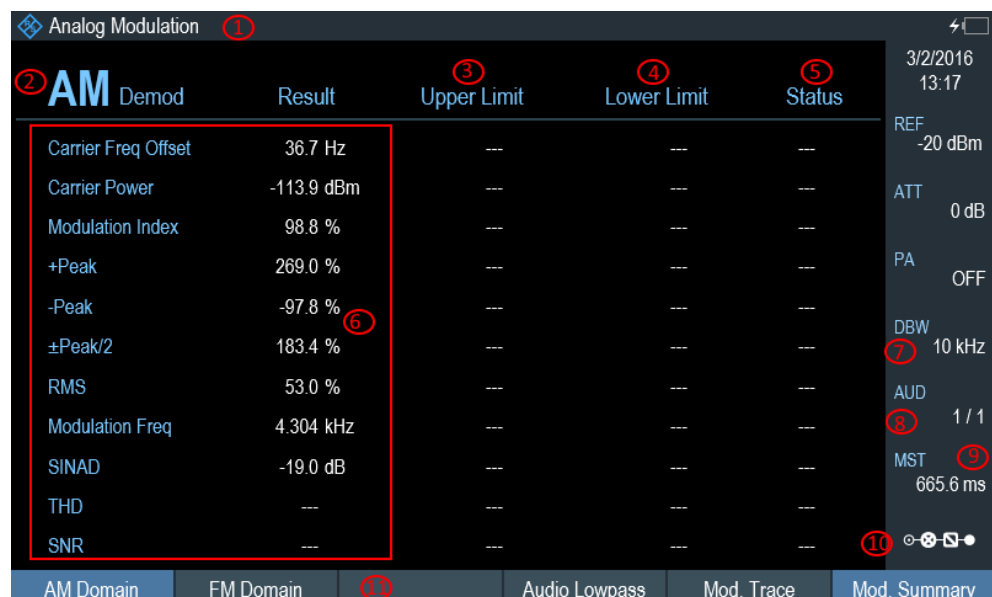

Figure 10-2: AM summary

- 1 = [Title bar](#)
- 2 = AM or FM modulation
- 3 = [Upper Limit](#)
- 4 = [Lower Limit](#)
- 5 = "PASS" or "FAIL" result of the limit test
- 6 = [Analog modulation parameters](#)
- 7 = [Demodulation bandwidth](#)
- 8 = [Audio lowpass filter](#)
- 9 = [Measurement time](#)
- 10 = [Configuration overview](#)
- 11 = [Softkey](#) menu of analog modulation measurement. See [Chapter 10.1.3.1, "Analog modulation"](#), on page 243.

The following analog modulation parameters are calculated:

Table 10-1: Analog modulation parameters

Label	Description
Carrier Power	Shows the power of the carrier without modulation in dBm.
Carrier Freq Offset	Shows the deviation of the calculated carrier frequency to the ideal carrier frequency in Hz.
Mod Index (AM domain)	Shows the difference in amplitude the carrier signal is modulated with.
Freq Deviation (FM domain)	Shows the frequency deviation that the carrier signal is modulated with.
Modulation Rate	Shows the modulation rate in %. Modulation rate = (Frequency Deviation / Reference Deviation) * 100 %
+Peak -Peak	Shows the minimum and maximum frequency deviation (FM signals) or modulation depth (AM signals).
±Peak/2	Shows the average frequency deviation (FM signals) or modulation depth (AM signals). (+Peak + -Peak) / 2
RMS	Shows the root mean square of the frequency deviation (FM signals) or modulation depth (AM signals).
Mod Freq	Shows the modulation frequency.
SINAD	Signal-to-noise and distortion Measures the ratio of the total power to the power of noise and harmonic distortions. The noise and harmonic power is calculated inside the AF spectrum span. The DC offset is removed before the calculation. $SINAD[dB] = 20 \cdot \log \left[\frac{\text{total power}}{\text{noise + distortion power}} \right]$

Label	Description
THD	<p>Total harmonic distortion</p> <p>Measures the ratio of the harmonics to the fundamental and harmonics. All harmonics inside AF spectrum are considered up to the tenth harmonic.</p> $THD[dB] = 20 \cdot \log \left[\frac{\sqrt{\sum_{i=2}^{\infty} U_i^2}}{\sqrt{\sum_{i=1}^{\infty} U_i^2}} \right]$
SNR	Shows the ratio of the total power to the power of noise in dB.

10.1.1 Demodulation bandwidth

The demodulation bandwidth is not the 3 dB bandwidth but the useful bandwidth which is distortion-free for phase and amplitude. See [Table 10-2](#).

Therefore the following formulas apply:

- AM: demodulation bandwidth $\geq 2 \times$ modulating frequency
- FM (CARSON's rule): demodulation bandwidth $\geq 2 \times$ (frequency deviation + highest modulating frequency)



If the center frequency of the analyzer is not set exactly to the signal frequency, the demodulation bandwidth must be selected larger by the carrier offset, in addition to the requirement described above.

In general, the demodulation bandwidth should be as narrow as possible to improve the S/N ratio. The residual FM caused by noise floor and phase noise increases dramatically with the bandwidth, especially with FM.

10.1.2 Sample rate, measurement time and audio lowpass filter

Depending on the sample rate, the maximum demodulation bandwidths listed in the [Table 10-2](#) can be obtained during the measurement. The permissible value range of the measurement time depends on the selected demodulation bandwidth and audio lowpass filter.

Example: AM modulation with a modulating frequency of 1kHz

1. Calculate the demodulation bandwidth you require.
Demodulation bandwidth = $2 \times 1 \text{ kHz}$
2. Select the minimum demodulation bandwidth from table [Table 10-2](#).

As a result, the demodulation bandwidth of "3000" is selected from the table. This shows that a minimum measurement time of 1.31 seconds is required to capture 3125 of sample rate.

3. Select the appropriate audio lowpass filter from [Table 10-3](#).
4. Depending on the sample rate and modulating frequency range, "DBW/1" is selected as the audio lowpass filter.
5. If a faster measurement time is desired, e.g. 6 ms, the audio lowpass, "DBW/10" should be selected to fulfill the requirement on the modulating frequency.

Table 10-2: Relationship on demodulation bandwidth, sample rate and measurement time

Demodulation bandwidth <= (kHz), "Manual DBW"	Output sample rate	Measurement time (ms), "MST"
2000000	2500000	1
989000	1250000	3
650000	964000	4
500000	625000	6
300000	391000	10
200000	250000	16
100000	125000	32
50000	62500	65
30000	36250	112
20000	25000	163
10000	12500	327
5000	6250	655
3000	3125	1310

Table 10-3: Selection of audio lowpass filter

Selection of audio lowpass, DPD (Digital Predistortion) filter	Output sample rate	Modulating frequency (Hz)	
		Maximum frequency	Minimum frequency
"DBW/1"	2500000	1000000	6100
	1250000	500000	3050
	964000	325000	2350
	625000	250000	1520
	391000	150000	950
	250000	100000	610
	125000	50000	300
	62500	25000	150

Selection of audio lowpass, DPD (Digital Predistortion) filter	Output sample rate	Modulating frequency (Hz)	
		Maximum frequency	Minimum frequency
	36250	15000	80
	25000	10000	60
	12500	5000	30
	6250	2500	10
	3125	1500	0
"DBW/10"	250000	100000	60
	125000	50000	300
	96400	32500	230
	62500	25000	150
	39100	15000	90
	25000	10000	60
	12500	5000	30
	6250	2500	10
	3625	1500	0
	2500	1000	0
	1250	500	0
	625	250	0
"DBW/30"	75757	30303	180
	37878	15152	90
	29212	9848	70
	18939	7576	40
	11848	4545	20
	7575	3030	10
	3787	1515	0
	1893	758	0
	1098	455	0
	757	303	0
	378	152	0
	189	76	0
"DBW/100"	25000	10000	60

Selection of audio lowpass, DPD (Digital Predistortion) filter	Output sample rate	Modulating frequency (Hz)	
		Maximum frequency	Minimum frequency
	12500	5000	30
	9640	3250	20
	6250	2500	10
	3910	1500	0
	2500	1000	0
	1250	500	0
	625	250	0
	362	150	0
	250	100	0
	125	50	0
	62	25	0
	31	15	0

10.1.3 Performing and configuring measurements

After the "Analog Modulation" mode is activated, the R&S Spectrum Rider immediately starts to measure the modulated signals.

10.1.3.1 Analog modulation

The analog modulation is performed in the AM Domain or FM Domain and the measurement readings are selectable in the "Mod Trace" and "Mod Summary" setting.

- **AM Domain**
Measurement is performed on the amplitude modulated signal monitors at the carrier frequency.
 - Modulation Trace
Measurement is performed and displayed in the trace window.
 - Modulation Summary
Measurement is performed and displayed in the summary window.
- **FM Domain**
Measurement is performed on the frequency modulated signal monitors at the carrier frequency.
 - Modulation Trace
Measurement is performed and displayed in the trace window.
 - Modulation Summary
Measurement is performed and displayed in the summary window.

1. Press [MEAS] key.

The R&S Spectrum Rider opens the analog modulation menu.

2. Select the analog modulation domain you require ("AM Domain" or "FM Domain") and the required measurement setting ("Mod. Trace" or "Mod. Summary") softkey to perform the measurement.

See index 9 of [Figure 10-1](#).

10.1.3.2 Defining the horizontal axis

The frequency defines the carrier frequency of the modulated signals.

Carrier Frequency

For more information, see [Chapter 6.2.2.1, "Defining the center frequency"](#), on page 174.

Carrier Frequency Step Size

For more information, see [Chapter 6.2.2.2, "Defining a frequency step size"](#), on page 174.

10.1.3.3 Defining the vertical axis

Reference level

For more information, see [Chapter 6.2.3.1, "Setting the reference level"](#), on page 177.

Modulation depth

The vertical axis of the AM Domain displays the modulation depth of the amplitude modulated signal.

1. Press [MEAS] key.
2. Select "AM Domain" softkey
3. Press [AMPT] key
4. Select "Dev per Division" softkey.
A drop-down menu to select the step interval on the modulation depth opens.
5. Select the step interval on the modulation depth you require.

Frequency deviation

The vertical axis of the FM Domain displays the frequency deviation of the frequency modulated signal.

1. Press [MEAS] key.
2. Select "FM Domain" softkey

3. Press [AMPT] key
4. Press the "Dev per Division" softkey.
A drop-down menu to select the step interval on the frequency deviation opens.
5. Select the step interval on the frequency deviation you require.

Scale adjustment

The scale adjustment is only available in the "FM Domain" of "Mod Trace" measurement.

1. Press [BW] key.
2. Select "Scale Adjust" softkey.
The R&S Spectrum Rider performs an auto adjustment on the vertical axis in the FM Domain of "Mod Trace" measurement.

RF attenuation

For more information, see [Chapter 6.2.3.5, "Setting the RF attenuation"](#), on page 179.

Preamplifier

For more information, see [Chapter 6.2.3.6, "Using the preamplifier"](#), on page 181.

10.1.3.4 Defining demodulation bandwidth and audio lowpass filter

Demodulation bandwidth

The demodulation bandwidth defines the useful bandwidth used in the modulated signals.

1. Press [BW] key.
2. Select "Manual DBW" softkey.
The R&S Spectrum Rider opens an input field to select the demodulation bandwidth.
3. Rotate the rotary knob to select the demodulation bandwidth you require.
See [Chapter 10.1.1, "Demodulation bandwidth"](#), on page 240 and [Table 10-2](#).

Reference deviation

The reference deviation is available only in the FM domain, the maximum of reference deviation setting is (demodulation bandwidth) /2.

1. Press [BW] key.
2. Select "Reference Deviation" softkey.
The R&S Spectrum Rider opens an input field to select the reference deviation.
3. Select the reference deviation you require.

See [Table 10-1](#) .

Audio lowpass

The "Audio Lowpass", a DPD (Digital Predistortion) designed filter is used to fine-tuned the measurements demodulated signals.

1. Press [MEAS] key.
The R&S Spectrum Rider opens the analog modulation measurement menu.
2. Select the analog modulation domain you require, "AM Domain" or "FM Domain" softkey.
3. Select "Audio Lowpass" softkey
A drop-down menu to select the audio lowpass filter opens.
4. Select the audio lowpass filter you require.
See [Table 10-3](#).

10.1.3.5 Defining FM broadcast

Depending on the country-specific requirements, it maybe necessary to suppress the display of higher frequency component of the modulation signal.



FM broadcast

The FM broadcast is only enabled with the [demodulation bandwidth](#) setting at 200 kHz or 300 kHz.

1. Press [BW] key.
2. Select "FM Broadcast" softkey.
A drop-down menu to select the filter opens.
3. Select the filter setting you require.

10.1.3.6 Limit settings

The limit line available in the AM and FM summary measurement allows you to perform limit check on the measurements.

The limit line file is created using the "Ama AM Limits" or "Ama FM Limits" editor in the R&S InstrumentView software package.

For information on the analog modulation limit line editor, see R&S InstrumentView software manual.

1. Press [LINES] key.
2. Select "Select Limits" softkey.
The R&S Spectrum Rider opens the "File Manager" dialog to select the limit line file.

3. Select the limit line file you require from the file manager.
Note: The limit line is edited using the Ama AM or FM limit line editor from R&S InstrumentView software package.
4. Select "Load" softkey.
The R&S Spectrum Rider activates and loads the limit line values in the table.
See [Figure 10-2](#).
5. Select the "Audio Beep" softkey to turn on or off the acoustic audio signal for the limit line check status.
See index 5 of [Figure 10-2](#).
See also "Audio signal" on page 210.
6. Select "Clear Limits" softkey to unload the limit line file.

10.2 Digital demodulation

The Digital Demodulation measurement analyzes the Amplitude Shift Keying (ASK) and Frequency Shift Keying (FSK) modulated signals and calculates the digital modulation parameters. The results are displayed in four different [display mode](#) diagrams: "Eye Diagram", "Symbols", "Modulation Depth" for ASK or "Modulation Deviation" for FSK and "Modulation Error".

The firmware option R&S FPH-K7 provides the necessary measurement functions to analyze ASK and FSK modulated signals.

Example:

ASK signal modulated with a carrier frequency 500MHz, using root cosine filter with roll factor of 0.5 and symbol rate of 10ksym/s is generated. External reference signal from the generator is connector to the R&S Spectrum Rider.

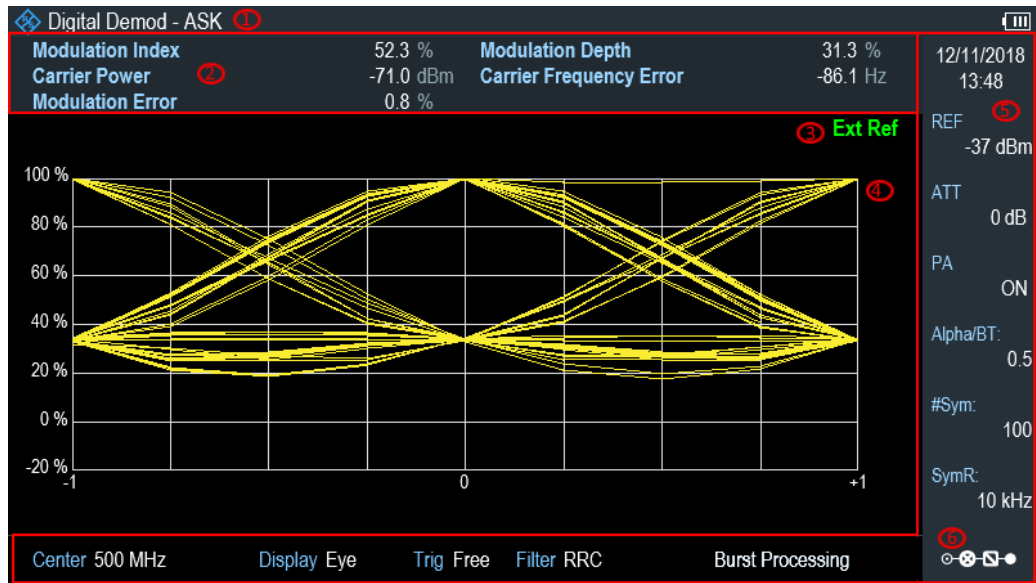

Figure 10-3: Eye diagram of an ASK modulated signal

- 1 = Operating mode domain
- 2 = ASK or FSK modulated parameters
- 3 = External reference signal
- 4 = Trace diagram displaying the selected display mode in ASK or FSK modulation domain
- 5 = Parameter view
- 6 = Configuration overview

Table 10-4: ASK and FSK modulation parameters

Label	Description
Frequency Deviation	Frequency deviations between the measured signal and reference signal.
Carrier Frequency Drift	Drift in the carrier frequency of the measured signal.
Magnitude Error	Difference between the measured magnitude and the magnitude of the reference signal.
Modulation Index	See modulation depth in Table 10-5.
Carrier Power	Measured carrier power signal.
Modulation Error	Modulation deviation between measured signal and reference signal.
Modulation Depth	See modulation depth in Table 10-5.
Carrier Frequency Error	Mean carrier frequency offset in Hz.

1. Press [MODE] key.
The R&S Spectrum Rider opens the mode menu.
2. Select "Digital Demod" softkey.
The R&S Spectrum Rider activates the mode for digital demodulation.
3. Press [MEAS] key.
The R&S Spectrum Rider opens the digital demodulation measurement menu.

The measurements are performed in two digital demodulation domains:

- "ASK": Demodulates 2ASK signals.
ASK is a digital modulation scheme that changes the amplitude of the carrier to transmit different values (or symbols). Each value corresponds to a different amplitude. In the case of 2ASK signal, the binary values of 1 and 0 are transmitted with a certain fixed amplitude and reduced amplitude respectively. Often the amplitude of the "1" and "0" signal is respectively at 100 % and close to 0 % of the nominal carrier amplitude (OOK = on-off-keying).
The R&S Spectrum Rider detects the different amplitudes, demodulates the signal and retrieves the original sequences of the digital symbols. For proper demodulation, you have to match the center frequency of the R&S Spectrum Rider to the ASK carrier frequency.
 - "FSK": Demodulates 2FSK signals.
FSK is a digital modulation scheme that changes the frequency of the carrier to transmit different values (or symbols). Each value corresponds to a different frequency. In the case of 2FSK signal, the binary values of 0 and 1 are transmitted with a certain frequency f_1 and f_2 respectively. For proper demodulation, you have to set a center frequency that is the arithmetic mean of f_1 and f_2 .
4. Select the modulation domain of the signal you want to demodulate ("ASK" or "FSK" softkey).
 5. Select "Display Mode" softkey to view the measurement readings.
The R&S Spectrum Rider opens a submenu to select the display mode. See [Table 10-5](#).
 6. The R&S Spectrum Rider demodulates the signal and displays the measurement results in the selected display mode. See [Table 10-5](#) and [Table 10-4](#).

Table 10-5: Display mode for ASK and FSK demodulation

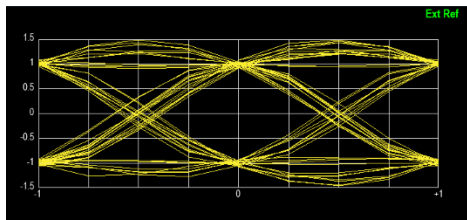
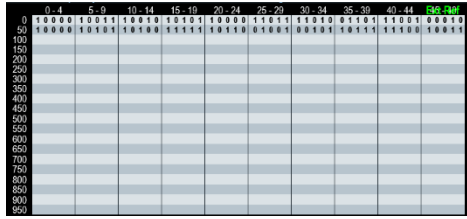
Display mode	Description
	<p>Eye diagram shows the modulation accuracy, it analyzes the transitions from one modulation state to the other.</p> <p>An open "eye" indicates little distortion in the signal transmission. A closed "eye" indicates poor signal quality with signal due to clock jitter, interference, poorly synchronized of the phase-locking circuitry or reflection due to imperfect termination. With bit rate increases, timing error also increases, reducing the size of the eye opening which increases the potential of data error.</p>
	<p>Symbol diagram shows the streams of symbols of binary digits transmitted in the signal.</p>

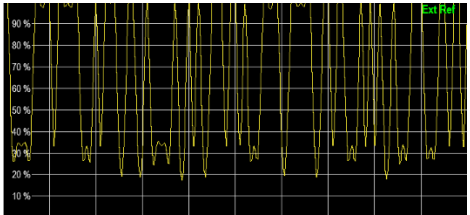
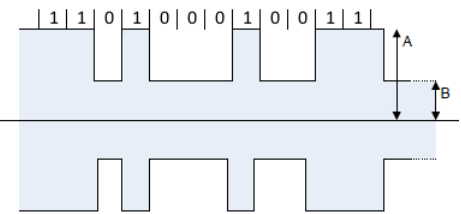
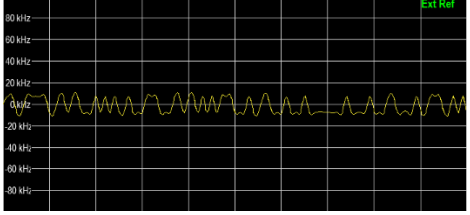
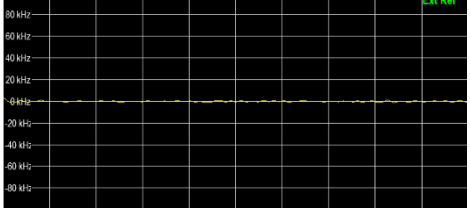
Display mode	Description
	<p>The modulation depth diagram displays the modulation depth of the signal.</p> <p>The modulation depth indicates the amplitude drop during low state amplitudes (binary 1 = high state or modulated signal, binary 0 = low state or unmodulated signal).</p> <p>The high state amplitude is normalized to 100%. The modulation depth is the amount that the amplitude drops during the low state in %. The modulation depth is therefore a value < 100 %.</p> <p>Another way to express the amplitude variations of an ASK modulated signal is the modulation index. The R&S Spectrum Rider displays the modulation index as a numeric result in the measurement result view.</p>  $\text{Modulation index} = \frac{(A - B)}{(A + B)}$ $\text{Modulation depth} = \frac{B}{A}$
	<p>The modulation deviation diagram shows the frequency shift of the FSK signal. The frequency shift (or frequency deviation) is the frequency difference between the mark (binary 1) and space (binary 0) frequencies representing the binary digits.</p>
	<p>The modulation error diagram shows the modulation error over time (% for ASK and Hz for FSK). The modulation error shows the deviation of the measured symbols from the ideal symbol locations. The ideal symbol locations are defined in a reference signal.</p>

10.2.1 Measurement configuration

A digital modulation system needs a transmit filter to limit the bandwidth of the transmitted signal. The receiver needs to know the characteristics of that filter to demodulate the signal. Sometimes, an additional receive filter is necessary for proper demodulation. Other demodulation parameters like the symbol rate, roll factor of the filter and frequency deviation in the case for FSK modulated signal are also required for a proper demodulation of the signal. Demodulation parameters like oversampling factor, refer-

ence filter or measurement filter, are automatically selected by the R&S Spectrum Rider.

1. Press [MEAS] key.
The R&S Spectrum Rider opens the measurement menu.
2. Select "Demod Parameters " softkey.
The R&S Spectrum Rider opens a submenu that contains the demodulation parameters.

Selecting the filter type and roll-off factor of the measurement filter

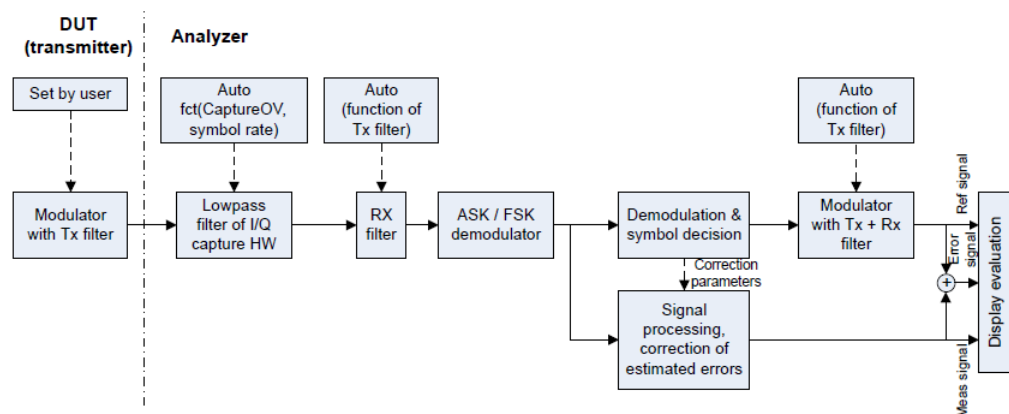

Figure 10-4: Block diagram of measurement filter

1. Select "Filter Type" softkey.
Alternatively, select "Filter" in the [Parameter view](#) to select the filter.
The R&S Spectrum Rider opens a submenu that contains the different type of filter for selection.
 - "Root Raised Cosine" - Frequently used in the transmitter and receive filter to perform matched filtering. It helps to remove the Inter-symbol interferences and also to improve the use of spectral efficiency
 - "Raised Cosine" - The combined response of two RRC is the result of a raised cosine filter
 - "Gaussian" - Typically used in the FSK modulation
 - "Unfiltered" - No filter used
2. Select the required filter type.
3. Select the "Demod Parameters " softkey.
The R&S Spectrum Rider opens a submenu that contains the demodulation parameters.
4. Select the "Alpha/BT" to define the roll-off factor of the filter.
Alternatively, select "Alpha/BT" on the [Parameter view](#) to define the roll-off factor of the filter.
The R&S Spectrum Rider opens an entry box to enter the roll-off factor.

For Raised Cosine or Root Raised Cosine filter, the filter bandwidth is defined in term of the alpha value.

For Gaussian filter, the filter bandwidth is defined in terms of the BT value.

Defining the symbol rate and number of signal symbols

The symbol rate defines the number of symbols that are transmitted per time unit (Hz) from the transmitter. See [Figure 10-4](#).

1. Select "Demod Parameters " softkey.
The R&S Spectrum Rider opens a submenu that contains the demodulation parameters.
2. Select "Symbol Rate" to define the symbol rate of the measuring signal.
Alternatively, select the "SymR" item on the [Parameter view](#) to define the symbol rate.
The R&S Spectrum Rider opens an entry box to enter the symbol rate.
3. Select the "Demod Parameters " >"Number of symbols" to view the number of modulated symbols.
Alternatively, select "#Sym " on the [Parameter view](#) to view the number of modulated symbols.
The R&S Spectrum Rider displays the number of modulated symbols in the "Symbols" display mode. See [Table 10-5](#).

Turning burst processing on and off

Burst processing is a tool similar to a trigger that automatically detects the beginning and end of a burst in the capture buffer.

A burst is not detected in the following conditions:

- If the burst power is below a certain threshold
- If the burst is too short
- If the time between bursts is too short

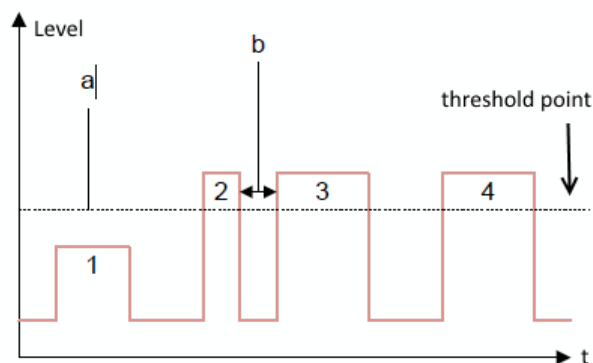

Figure 10-5: Burst signal conditions

- a = Minimum required signal level
 b = Time between bursts
 1 = No burst detected as the signal level is below threshold point
 2 = No burst detected as the burst period is too short
 3 = No burst detected as the burst interval is too short
 4 = Burst detected as the signal level is above threshold point, burst period and time interval between burst is long enough

When the burst is detected, the R&S Spectrum Rider tries to demodulate the signal based on the demodulation parameters that you have set and display the results.

1. Select "Demod Parameters " softkey.
 The R&S Spectrum Rider opens a submenu that contains the demodulation parameters.
2. Select "Burst Processing" menu item to activate the burst processing of the measuring signal.
 The R&S Spectrum Rider looks for probable bursts in the capture buffer and demodulates the signal.
 Alternatively, select the "Burst Processing" item on the [Parameter view](#) to activate the burst processing of the measuring signal.
 When the burst processing is activated, the R&S Spectrum Rider changes the font color of the "Burst Processing" from white to blue.

Selecting a standard

Two measuring standards are available for FSK modulation with the following modulation parameters:

Measuring standards	Filter characteristics	Symbol rate, Number of symbols
Bluetooth LE	Gaussian filter, BT 0.5	1 Mhz, 400 symbols
Tire pressure	No filter	18.9 kHz, 500 symbols

1. Select "Standard" softkey to open the measurement menu.
 The R&S Spectrum Rider opens a submenu that contains the measurement standards.
2. Select the required standard.
 - "Bluetooth LE" - Measurements on bluetooth low energy devices
 - "Tire Pressure" - Measurements on devices that check the tire pressure of cars
 - "Off" - Measurements on other signals

10.2.2 Frequency configuration

For proper demodulation of signals, the carrier frequency of the modulation signal should be set correctly on the R&S Spectrum Rider. If carrier frequency is unknown, a search can be performed on the frequency spectrum supported by the R&S Spectrum Rider and zoom into the area where the carrier maybe located.

For more information frequency configuration, see [Chapter 6.1.1, "Measuring basic signal characteristics"](#), on page 123, [Chapter 6.1.2, "Measuring the channel power of continuously modulated signals"](#), on page 125 and [Chapter 6.2, "Configuring spectrum measurements"](#), on page 172.

1. Press [FREQ] key.
2. Select "Center Freq" softkey.
The R&S Spectrum Rider opens an input field to define the center frequency input.

10.2.3 Amplitude configuration

For more information on the amplitude configuration, see [Chapter 6.2.3, "Configuring the vertical axis"](#), on page 177.

Defining the position of the reference for ASK signals

In the graphical result displays, the reference position on the y-axis can be adjusted to see the signal in greater details. By default, the maximum reference position is set to 100%.

1. Press [AMPT] key.
The R&S Spectrum Rider opens the amplitude menu.
2. Select the "Ref Position" menu item.
The R&S Spectrum Rider opens an input field to define the reference position in term of percentage.
3. Enter the required value.
The R&S Spectrum Rider adjusts the y-axis and the position of the trace accordingly.

Adjusting the display range for ASK and FSK signals

The R&S Spectrum Rider display range is divided into 10 grid sections, you can define the deviation per grid section.

1. Press [AMPT] key.
The R&S Spectrum Rider opens the amplitude menu.
2. Select the "Deviation Per Division" menu item.
The R&S Spectrum Rider opens an input field to define the deviation.
3. Enter the required deviation.
The R&S Spectrum Rider adjusts the scale of the y-axis accordingly.

10.2.4 Sweep and trigger configuration

The sweep and trigger menu provides settings to control the measurement and the way data is captured.

For more information, see [Chapter 6.2.6, "Configuring and triggering the sweep"](#), on page 186.

Selecting the sweep mode

In its default state, the R&S Spectrum Rider measures continuously. In this mode, the R&S Spectrum Rider demodulates the signal until you stop it deliberately. The measurement results are updated accordingly.

In single mode, the R&S Spectrum Rider demodulates the signal over one sweep. Subsequent update of measurement results starts only when you deliberately initiate it.

1. Press [SWEEP] key.
The R&S Spectrum Rider opens the sweep menu.
2. Select the sweep mode.
 - "Cont Sweep": Demodulates signal continuously
 - "Single Sweep": Demodulates signal over one sweep
3. Select the required sweep mode.

Selecting the trigger settings

In addition to the trigger settings available in the spectrum mode, the Digital Demodulation measurement provides an I/Q power trigger source.

The I/Q power trigger initiates a measurement when the magnitude of the sampled I/Q data exceeds a certain level.

1. Press [SWEEP] key.
The R&S Spectrum Rider opens the sweep menu.
2. Select the "Trigger" menu item.
The R&S Spectrum Rider opens a submenu to select the trigger settings.
3. Select the "Trigger" menu item.
The R&S Spectrum Rider opens a submenu to select the trigger settings.
4. Select the "IQ Power" menu item.
The R&S Spectrum Rider opens an input field to define the trigger level.
5. Define an appropriate trigger level.
To make sure that the trigger initiates a measurement, it is recommended to set a trigger level 6 dB lower than the actual expected trigger level.
Take note also on the detection of burst signal. See [Turning burst processing on and off](#).

11 Interference analyzer



R&S Spectrum Rider option

R&S FPH-K15 (order number: 1321.0715.02) option is required to operate the R&S Spectrum Rider in the interference analysis mode.

R&S FPH-K16 (order number: 1321.0615.02) option is required to operate the R&S Spectrum Rider in the signal strength mapping mode.

In wireless systems, interference causes low data rates, dropped calls and poor voice quality, often making it impossible to establish or maintain a connection.

Equipped with firmware option R&S FPH-K15 and R&S FPH-K16, you can track down the source of interferences with your R&S Spectrum Rider. These options provide tools and mean to make the search for interferers as comfortable as possible.

To measure interferences, you need a directional antenna e.g. R&S HE400. For a list of supported directional antennas, refer to the data sheet.

The interference analyzer provides several measurement modes.

11.1 Interference analysis

In the interference analysis mode, you can perform both spectrogram and triangulation measurement functions.

For more information, see [Working with the spectrogram display](#) and [Triangulation](#).

Triangulation

If only R&S FPH-K15 is installed, the "Triangulation" measurement is available when [MODE] key is pressed.

If both R&S FPH-K15 and R&S FPH-K16 are installed, the "Triangulation" measurement is available when [MODE] key followed by "Maps" softkey is pressed.

1. Press "Meas Mode" softkey if R&S FPH-K16 is installed.
2. Select the "Triangulation" menu item.
The R&S Spectrum Rider enters the triangulation measurement mode.

For more information, see [Chapter 11.3, "Working with maps"](#), on page 257.

11.2 Signal strength mapping

In the signal strength mapping mode, the R&S Spectrum Rider provides two map measurements for selection: [Outdoor mapping](#) and [Indoor mapping](#).

1. Press [MODE] key.
2. Select "Maps" softkey.
The R&S Spectrum Rider enters the map application.
3. Press [MEAS] softkey.
4. Select "Meas Mode" softkey.
The R&S Spectrum Rider opens a submenu that contains the two map measurements for selection.

Outdoor mapping

- ▶ Select the "Outdoor Mapping" menu item.
The R&S Spectrum Rider enters the outdoor mapping mode.
For more information , see [Chapter 11.3, "Working with maps"](#), on page 257 and [Chapter 11.3.5.1, "Outdoor mapping"](#), on page 270.

Indoor mapping

- ▶ Select the "Indoor Mapping" menu item.
The R&S Spectrum Rider enters the indoor mapping mode.
For more information , see [Chapter 11.3, "Working with maps"](#), on page 257 and [Chapter 11.3.5.3, "Indoor mapping"](#), on page 277.

11.3 Working with maps

Equipped with option R&S FPH-K16, you can make spectrum measurements and save the position of these measurements on the map. Using the triangulation method, you can determine the source of interference on the map.

To make full use of the functions available in map mode, you need a GPS receiver and an antenna (e.g. R&S HE400, which contains a GPS receiver).

To work with smaller scale map like floor plan, the "Indoor Mapping" provides the functionality to measure the signal strength indoors using an antenna (for example R&S HL300). See [Chapter 11.3.5.3, "Indoor mapping"](#), on page 277.

• Transferring maps	258
• Transferring Indoor maps	258
• Displaying maps	260
• Measuring interference	267
• Collecting map data	270
• Analyzing geographic data	281
• Analyzing indoor data	282

11.3.1 Transferring maps



Map folder

The map folder contains the individual map data. You can create an arbitrary map folder name to store the map data, otherwise the R&S Spectrum Rider may not be able to find the map data.

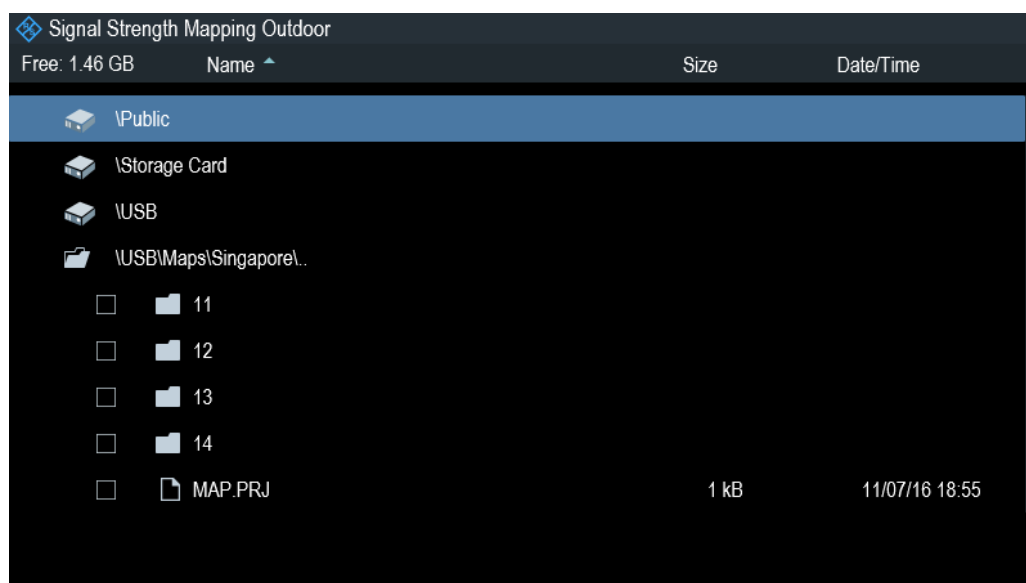

The R&S Spectrum Rider contains only a world map. If you want to make measurements on a more detailed map, you have to download and install the maps on the R&S Spectrum Rider. The R&S Spectrum Rider supports the map material supplied by the OpenStreetMap project (<http://www.openstreetmap.org>).

The easiest way for you to transfer the maps to the R&S Spectrum Rider is to use the R&S OpenStreetMap Wizard (OSM Wizard) application. The OSM Wizard is available for download at the product homepage <http://www.rohde-schwarz.com/product/fph.html>.

The OSM Wizard establishes a connection to the Open Street Maps database on the Internet and thus it needs an Internet connection. The tool allows you to select the area that you need for your measurements and download the corresponding maps. After the corresponding maps are downloaded, copy the map data and stored it to an **arbitrary folder name** in the USB stick.

For more information on how to download and save maps, refer to the documentation of the OSM Wizard. The documentation is written as part of the software.

11.3.2 Transferring Indoor maps

Before you can use the features of the indoor mapping application, you have to create an indoor map (for example a floor plan). These maps are created with features available in the R&S InstrumentView software package, and are based on an image of the

area you would like to measure. The image source can be one of the common file formats (for example ".jpg", ".png" or ".tif").

1. Start the R&S InstrumentView software.
2. Start the "Map Creator" menu item in the "Preparation" menu.
The R&S InstrumentView opens the indoor map editor.
3. Select the "Open Image" button in the map editor to open the image file.
The R&S InstrumentView opens a dialog box to select an image file.

Note: You can zoom in and out of the indoor map using the mouse wheel.

4. Select the image file of the area you want to measure.
If you need a small part of the image, you have to edit it with an image manipulation program before loading it into the R&S InstrumentView software.
5. Select the "Generate Map" button.
The R&S InstrumentView creates a map data from the image you used.

6. Select a new folder to save the map data.

Note: When generating a new map data, a new folder should be created to avoid deleting the existing content of the folder.

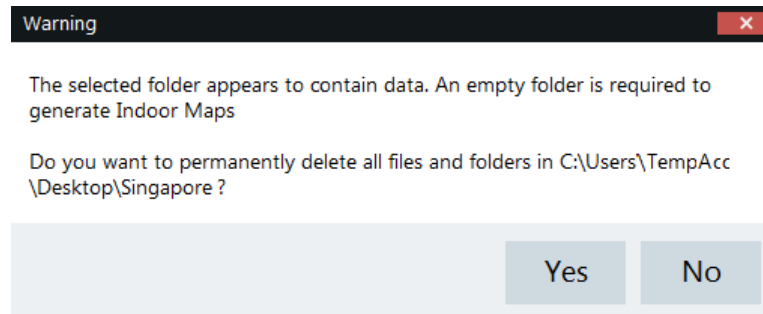

7. Copy the folder containing the map data to the USB stick.
8. Insert the USB stick to the USB connector of the R&S Spectrum Rider.

In addition to creating a map, you can also specify the exact geographical location of the area you are measuring. To do so, you have to specify three GPS reference points of the area. Enter the corresponding latitude and longitude data in the corresponding fields available in the "Create Map" dialog box and move these three GPS reference icons,  displayed in the preview of the map to the corresponding locations. For more information, see "Map Creator" in the R&S InstrumentView.

When you create a GPS referenced map, it provides some useful features:

- The map created is automatically rotated with the north side faces up.
- The R&S Spectrum Rider calculates and displays the distance between measurement points (in meters or feet, depending on the regional settings).
- You are able to embed the collected data into maps with a larger scale. Thus, you are able to, for example, combine measurement data recorded with the "Outdoor Mapping" application and data recorded with the "Indoor Mapping" application in a single map.

For more information, see [Chapter 11.3.5, "Collecting map data"](#), on page 270.

11.3.3 Displaying maps

After you have downloaded or created the maps, save them to a USB flash drive, which you can use with the R&S Spectrum Rider.

1. Press [MEAS] key.
2. Select "Meas Mode" softkey.
The R&S Spectrum Rider opens a submenu that contains the measurement function for selection.
3. Select the "Outdoor Mapping" menu item.
The R&S Spectrum Rider provides the outdoor mapping measurement functions.
4. Select "Map" softkey.
The R&S Spectrum Rider opens a menu that contains all the maps that you have stored on the USB flash drive. (The map names correspond to the folder names for every area you have saved, see ["Map folder"](#) on page 258).

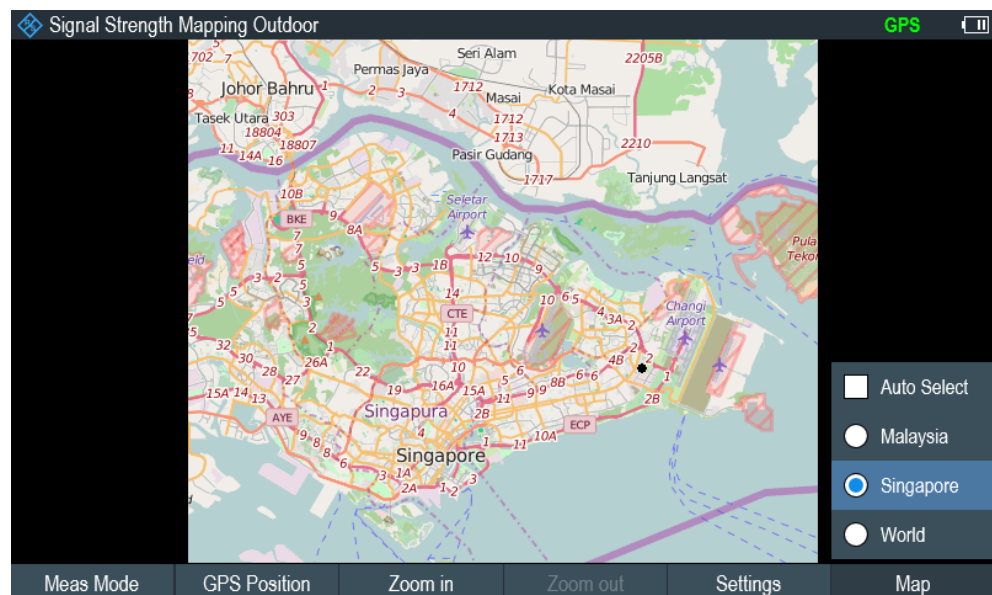

5. Select the maps of the area you need.
In the "Outdoor Mapping" operating mode, the "Auto Select" menu item automatically selects the map that is most fitting to your current location. Using the automatic selection requires a GPS receiver.
In the "Indoor Mapping" operating mode, the "Auto Select" menu is only available if the R&S Spectrum Rider could not find any indoor maps. After the indoor map is loaded, it is necessary to bring the map to the crosshair cursor  located in the display center before you can zoom in or zoom out the map area. See [Chapter 11.3.3.2, "Zooming in and out of the map"](#), on page 262.

Screen layout of the map display

The screen layout of the map display is customizable. You can customize the screen layout and display information that you need.

- ▶ Select the "Settings" softkey.

The R&S Spectrum Rider opens a menu that contains the screen elements ("Power Bar ", "Power Result" and "Hardware Settings") to display in the screen layout. If no screen element is selected, the R&S Spectrum Rider shows the map only. The following illustrates the screen layout of the map display.

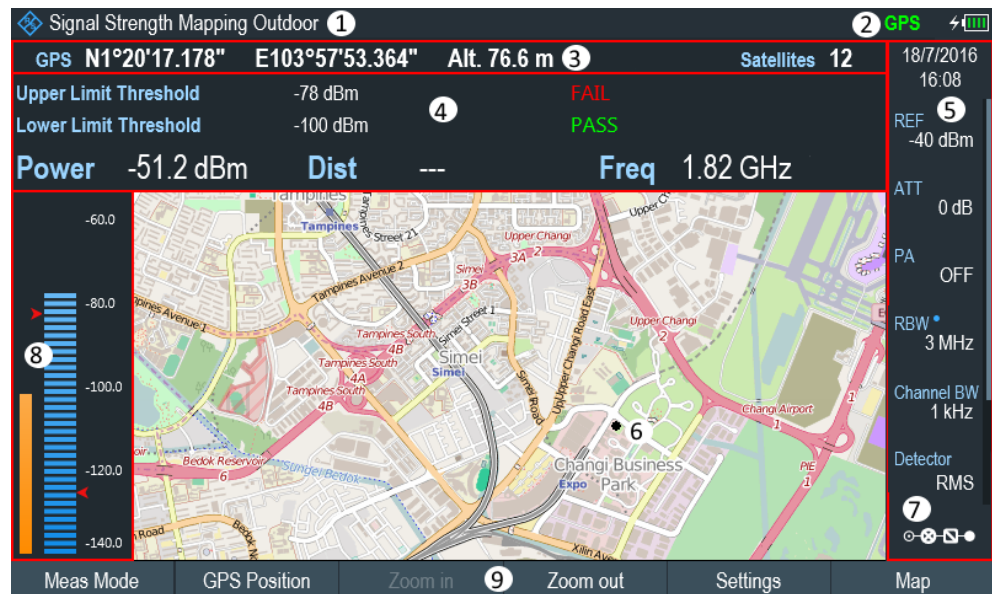

Figure 11-1: Map display

- 1 = Current type of measurement mode
- 2 = Connected device information. See also "State of GPS receiver" on page 59.
- 3 = GPS information including compass information, GPS connection quality and triangulation results.
- 4 = Power results (including distance between measurement locations and carrier frequency display) and limit results
- 5 = [Parameter view](#)
- 6 = Map area including tags representing the current measurement locations.
- 7 = [Configuration overview](#)
- 8 = Power bar including the noise squelch level and limits threshold indicator
- 9 = Current measurement mode softkey menu.

- [Adding and removing elements](#).....261
- [Zooming in and out of the map](#)..... 262
- [Aligning the triangulation and outdoor mapping mode](#).....262
- [Aligning the indoor mapping mode](#).....263
- [Selecting colors for map locations](#)..... 264

11.3.3.1 Adding and removing elements

The result display is made up out of several elements that you can add or remove as you like.

1. Press [MEAS] key.
2. Select "Settings" softkey.
3. Select "Show" softkey.
The R&S Spectrum Rider opens a submenu that contains the result display settings for selection.
4. Select the element you want to add or remove.
 - "GPS Information"
Enable or disable the display of "GPS" menu item ("GPS information", "Satellites", "Compass")
 - "Compass Information"
Enable or disable the display of "Compass" information.
 - "Power Bar"
Enable or disable the power bar information (including the noise squelch level)
 - "Power Result"
Enable or disable the power result
 - "Hardware Settings"
Enable or disable the display of the [Parameter view](#)

11.3.3.2 Zooming in and out of the map

If you have downloaded different zoom levels of your maps, or if you have created a large (or very small) indoor map, you can change the scale of the map to get a more detailed view or a more general overview. For smaller indoor map, you need to position the map to the crosshair cursor  located in the display center before you can zoom in or zoom out the map area.

Note that the original size of indoor maps depends on the size of the image these maps are based on.

1. Press [MEAS] key.
2. Select "Zoom In" softkey to decrease the scale of the map.
3. Select "Zoom Out" softkey to decrease the scale of the map.

11.3.3.3 Aligning the triangulation and outdoor mapping mode

The R&S Spectrum Rider provides several tools to align the map. These tools are useful if you want your current location to be in the center of the display or if you have moved out of the visible map area.

Using the touchscreen gesture

Use the touchscreen gesture to navigate on the map area:

- Swipe in your desired direction (horizontally, vertically or diagonally) to navigate the position on the map.

- Pinch or stretch two fingers horizontally to adjust the zoom span of the map area and use.

Manual alignment

Alternatively, you can use the keypad keys on the R&S Spectrum Rider to navigate the position in the map.

- Press [2] key to navigate the position upward on the map.
- Press [4] key to navigate the position to the left side on the map.
- Press [6] key navigate the position to the right side on the map.
- Press [8] key navigate the position downward on the map.

You can move the maps until you reach the borders of the downloaded content. Note that the borders of the maps might be different for different scales.

Automatic alignment



"GPS Position" is available only if a USB stick is detected on the R&S Spectrum Rider.

For most automatic map alignment functions, you have to establish a GPS connection.

1. Press [MEAS] key.
2. Select "GPS Position" softkey.
The R&S Spectrum Rider displays a softkey menu that provides various functions to control and work with GPS data.
 - Select "Go To" softkey (Outdoor Mapping Mode).
 - "Current Position"
Moves your current position to the center of the display once.
 - "Saved Position"
Moves your saved position to the center of the display once.
 - "Go To Triangulation" softkey (Triangulation Mode)
Moves the location of the triangulation result to the center of the display.

11.3.3.4 Aligning the indoor mapping mode

The R&S Spectrum Rider automatically aligns the map when you move the crosshair cursor  displayed on the map. The crosshair cursor represents your current position on the map.

Moving the crosshair cursor is necessary to define another measurement location. This is only possible by manually changing the position of the crosshair cursor.

Using the touchscreen gesture

For more information on the touchscreen gesture, see ["Using the touchscreen gesture"](#) on page 262.

You can use the touchscreen gesture to move large steps on the current position of the map and fine-tuning the position further with the keypad keys (see ["Manual alignment"](#) on page 263).

Using the keypad

See ["Manual alignment"](#) on page 263.

You can move the crosshair cursor representing your position until you reach the borders of the indoor map.

When you are using the keypad to move the crosshair cursor, you can also specify the distance (pixels) the cursor moves on a single press of the cursor key.

1. Select "Settings" softkey.
2. Select the "Cursor Sensitivity" menu item.
The R&S Spectrum Rider opens an entry field for input.
3. Enter a number between 1 and 64 in the input field.
The number you enter corresponds to the number of pixels each movement of the crosshair cursor covers (for example "1" moves the crosshair cursor one pixel in the selected direction).

11.3.3.5 Selecting colors for map locations

For more information on measurements performance on maps in general, see [Chapter 11.3.5, "Collecting map data"](#), on page 270.

Default behavior of geotags in triangulation

By default, all geotags (including all the labels associated with that geotag) have the same color (black). Depending on the type of geotag, you can assign different colors to the geotags.

Note that changing the color of a geotag also changes the color of the azimuth line.

To differentiate your current and saved position, you can define a different color to that geotag.

1. Press [MEAS] key.
2. Select "Settings" softkey.
3. Select "Colors" softkey.
The R&S Spectrum Rider opens a submenu that contains the different types of geotag ("Current Position Color", "Saved Positions Color", "Triangulation") for selection.
4. Select the geotag of your choice.
The R&S Spectrum Rider opens a submenu to select the color.
5. Select the color of your choice.
The R&S Spectrum Rider applies the selected color to the associated geotag.

In addition to the geotag, you can also define a custom color for the triangulation results. The R&S Spectrum Rider displays triangulation results as circle with a dot in the middle. See [Figure 11-2](#).

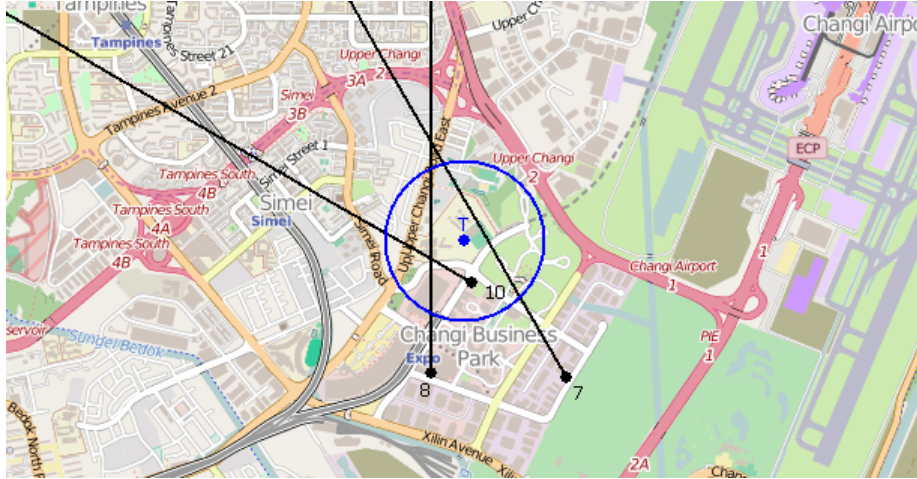

Figure 11-2: Display the geotag of triangulation result

By default, the circles and dot are blue. You can change the color of the triangulation tag as follows.

1. Press [MEAS] key.
2. Select "Settings" softkey.
3. Select the "Triangulation Color" menu item.
The R&S Spectrum Rider opens a submenu to select the color.
4. Select the color of your choice.
The R&S Spectrum Rider applies the selected color to the triangulation tag.

Default behavior of geotag in indoor and outdoor mapping



By default, the current position tag is displayed as black. This color is the only color selectable for the current position tag.

In indoor and outdoor mapping, a colored dot is added to the map when you make a measurement and save the result at that location. The color represents the signal level at that location.

The following shows the default color of the geotag signal strength on the map.

- Red color: Signal reception is bad.
- Yellow color: Signal reception is average.
- Green color: Signal reception is good.

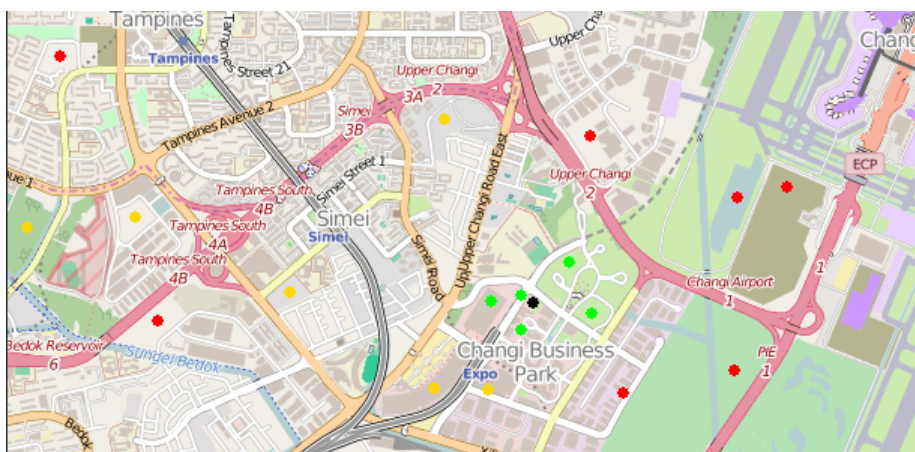

Figure 11-3: Display the geotag in outdoor mapping

To change the default color of the geotag signal strength, do the following:

1. Press [MEAS] key.
2. Select "Settings" softkey.
3. Select "Colors" softkey.
The R&S Spectrum Rider opens a submenu to select the different coverage conditions and its associate level definition.
4. Select the "Good Coverage Color", "Average Coverage Color" or "Bad Coverage Color" menu item to change the color representation of these coverage conditions.
The R&S Spectrum Rider opens a submenu to select the color.
5. Select a color of your choice.
6. Select "Colors" softkey.
7. Select the "Good Coverage Level", "Average Coverage Level" or "Bad Coverage Level" menu item to change the level representation of these coverage conditions.
The R&S Spectrum Rider opens an input field to define the level entry associated with the coverage conditions.



Superimposed geotags

If one or more geotags superimpose each other, you can define rules as to which tag (or its color) is displayed.

- Press [MEAS] key.
- Select "Settings" softkey.
- Select "Colors" softkey.
- Select the "Default indicator " menu item.
The R&S Spectrum Rider opens a submenu to select the rule for displaying the tag:
 - Best: the tag with the best signal level is displayed.
 - Average: the tag with the average level is displayed.
 - Worst: the tag with the lowest signal level is displayed.

11.3.4 Measuring interference

To perform interference measurements, you will need an antenna to localize the source of interferers. For a list of supported antennas, refer to the data sheet.

Connected the antenna to the R&S Spectrum Rider at the USB interface and the RF input.

You can control the antenna functionality in several ways in the general setup of the R&S Spectrum Rider. For more information, see the [Chapter 3.2.10.2, "Configuring antennas"](#), on page 53.

- [Selecting an antenna model](#).....267
- [Using an audio signal to locate interferers](#).....268
- [Using limits](#).....269

11.3.4.1 Selecting an antenna model

There are two ways to select the antenna model for interference measurement.

- Configure the antenna model in the instrument setup dialog, see [Chapter 3.2.10.2, "Configuring antennas"](#), on page 53.
- Configure the antenna model in the "Triangulation" mode. See ["Setup antenna model in the triangulation mode"](#) on page 267

Setup antenna model in the triangulation mode

1. Press [MEAS] key.
2. Select "Meas Mode" softkey.
The R&S Spectrum Rider opens a submenu to select the measurement mode.
3. Select the "Traingulation" mode.
The R&S Spectrum Rider enters the triangulation measurement mode.

4. Select "Settings" softkey.
5. Select "GPS Settings" softkey.
The R&S Spectrum Rider opens a submenu to select the different GPS settings.
6. Enable or disable the GPS or compass setting associated with the antenna type.

The currently selected antenna model is displayed in the [title bar](#). The color of the label indicates the state of the satellite lock of the GPS receiver of the antenna model.

For more information on the GPS receiver states, ["Displaying GPS information"](#) on page 58.

11.3.4.2 Using an audio signal to locate interferers

You can configure the R&S Spectrum Rider to play back an audio signal when it receives a signal. The audio signal changes its volume and frequency, depending on the strength of the received signal.

1. Press [MEAS] key.
2. Select "Settings" softkey.
3. Select "Tone" softkey.
The R&S Spectrum Rider opens a submenu to select the different tone parameters settings.
4. Select the "Tone" checkbox.
The R&S Spectrum Rider turns on the audio signal.

The R&S Spectrum Rider allows you to define various aspects of this audio signal.

Defining a squelch level

The squelch level defines the signal level above which the audio signal starts to play.

1. Press [MEAS] key.
2. Select "Settings" softkey.
3. Select "Squelch Level" softkey.
The R&S Spectrum Rider opens an input field to define the squelch level.
4. Enter a squelch level in dBm.
The R&S Spectrum Rider displays the squelch level graphically in the power bar element of the user interface.

Defining the threshold of the audio signal

The audio signal has a specific frequency that is coupled to a specific signal level, the threshold. As the signal you are receiving during a measurement becomes stronger or weaker, the audio signal changes its frequency:

- When the signal becomes stronger, the frequency of the audio signal gets higher

- When the signal becomes weaker, the frequency of the audio signal gets lower

You can define the threshold of the base tone.

1. Press [MEAS] key.
2. Select "Settings" softkey.
3. Select "Threshold Tone Frequency" softkey.
The R&S Spectrum Rider opens an input field to define the threshold.
4. Enter a threshold level in dBm as required.

Note that it may be possible that the audio signal frequency becomes so high or low that it is no longer audible.

Defining the gain of the audio signal

The change of frequency of the audio signal is a constant change of frequency. It is either one octave per 20 dB or one octave per 40 dB.

1. Press [MEAS] key.
2. Select "Settings" softkey.
3. Select "Tone Gain" softkey.
The R&S Spectrum Rider opens a submenu to define the octave settings.
4. Select the gain setting you prefer.

Defining the volume of the audio signal

The R&S Spectrum Rider allows you to adjust the volume of the audio signal.

1. Press [MEAS] key.
2. Select "Settings" softkey.
3. Select "Tone Volume" softkey.
The R&S Spectrum Rider opens an input field to define the volume.
4. Define a volume.
The volume is a percentage from 0% to 100% with 100% being the loudest.

11.3.4.3 Using limits

The R&S Spectrum Rider allows you to define limits within which the signal level must be in order to be recognized as a signal.

1. Press [LINE] key.
2. Select the "Upper Limit" or "Lower Limit" softkey.

The R&S Spectrum Rider opens an input field to define the limits. Signals that are above the upper limit and below the lower limit are ignored. Only the signals within these boundaries are considered in the analysis.

The limits that you have defined are displayed in the power bar as red triangles.

See item 8 of [Figure 11-1](#).

11.3.5 Collecting map data



Geotag

A geotag is a tag for a particular location that contains information about that location. This information includes, for example, GPS coordinates, the time of the measurement or level that has been measured. You can evaluate the geotag information directly onsite or save the information for later evaluation.

With the geotagging functionality, you can mark locations where you have performed a measurement. Thus, you are able to analyze the geographical distribution of the received signal strength. This allows you to analyze, for example, the coverage conditions around a base station's coverage area.

In the map display, a geotag is displayed as a dot with [color indication](#) to show the signal strength measured in that location. Equipped with option R&S FPH-K15, the geotag provides also an azimuth reading which shows a straight line. This straight line represents the direction you are facing.

The azimuth is the deviation from the direction you are facing and the north. It is a number in degrees. For example, if you are looking east, the azimuth would be 90°. The application shows the azimuth as a straight black line, beginning at your location and pointing in the direction you are facing. The azimuth line is always displayed when you are using the functionality of the R&S FPH-K15, even if you are just walking around without saving any data.

The R&S Spectrum Rider provides three map applications: [triangulation](#), [outdoor mapping](#) and [indoor mapping](#). The following chapters describe the various ways how map data can be collected and display in these map applications.

- [Outdoor mapping](#)..... 270
- [Triangulation](#)..... 275
- [Indoor mapping](#)..... 277

11.3.5.1 Outdoor mapping



"GPS Position" is available only if a USB stick is detected on the R&S Spectrum Rider.

In the outdoor mapping application, you perform the collection of geographical data with directional antenna and R&S HA-Z340 GPS receiver. The GPS receiver is not

required if antenna such as R&S HE400 antenna is used. For a list of supported directional antennas, refer to the data sheet.

You can save a geotag of your current position or create a geotag of any other position that you would like to save.

Creating geotags manually

1. Press [MEAS] key.
2. Select "GPS Position" softkey.
3. Select "Save" softkey.
The R&S Spectrum Rider opens a submenu to select the different geotags saving options.
4. Select the "Current Position" menu item.
The R&S Spectrum Rider creates a geotag of your current position. A geotag created this way is based on the coordinates of the GPS receiver and it includes the azimuth.

Alternatively, create a geotag of an arbitrary location.

1. Select the "Manual Position and Azimuth" menu item.
The R&S Spectrum Rider displays the "GPS Position" dialog box.



The screenshot shows a dark-themed dialog box titled "GPS Position". It contains the following fields and values:

Field	Value
Latitude	N 0° 0' 0.000"
Longitude	E 0° 0' 0.000"
Azimuth	0°
Name	
Description	

At the bottom of the dialog are two buttons: "Cancel" and "Save".

2. Enter the GPS data and location information.
The R&S Spectrum Rider creates a geotag with the geographic data you have entered.

Creating geotags automatically

The R&S Spectrum Rider is able to save geographic information automatically if you are using the "Save on Event" functionality. Depending on the trigger event (time, limit

failure, distance, every sweep event), geographic information with measurement are saved on the map for further analysis. See [Figure 11-4](#).

For more information, see [Chapter 4.7, "Saving on events"](#), on page 102.

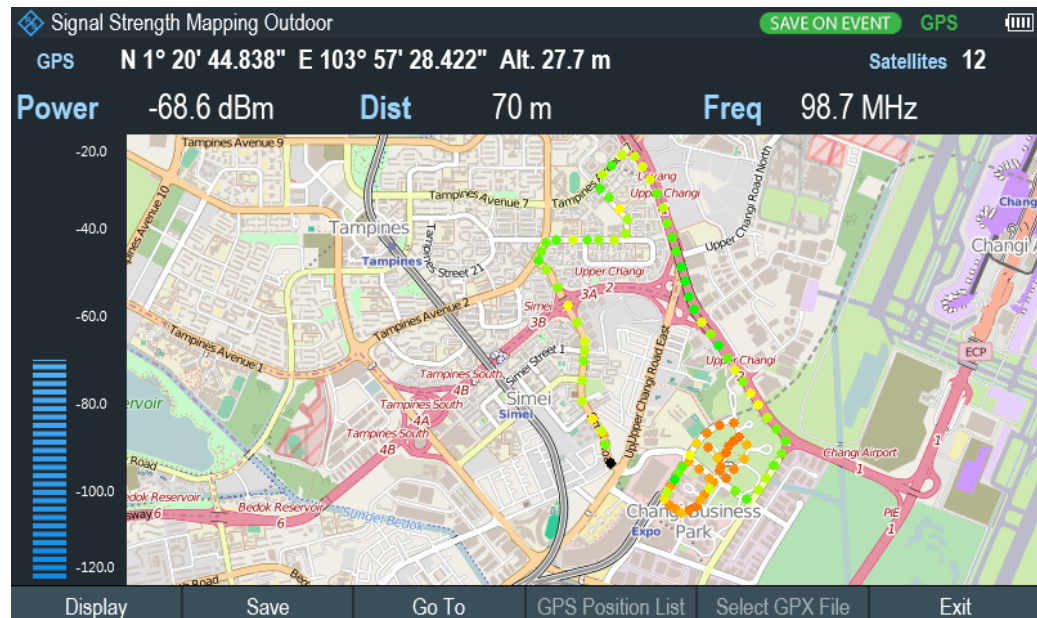

Figure 11-4: Save On Event map measurement

The R&S Spectrum Rider adds all geotags that you create to the "GPS Position List", see ["Managing geotags"](#) on page 272.

1. Press [MEAS] key.
2. Select "Settings" softkey
3. Select "Save on Event" softkey.
The R&S Spectrum Rider opens a submenu to activate the "Save on Event" function and define the "Event Source".
4. Select the "Event Source" menu item to define the event that triggers data storage.
The R&S Spectrum Rider opens a submenu to select the different event types. For more information, see ["Event types"](#) on page 103.
5. Activate the "Save on Event" menu item.
The R&S Spectrum Rider turns on the "Save on Event" functionality.

Managing geotags

The application features a "GPS Position List" that allows you to manage and edit geotags. The "GPS Position List" contains all geotags that you have created.

1. Select "GPS Position" softkey.
2. Select "GPS Position List" softkey.
The R&S Spectrum Rider opens the GPS position list dialog box.

The R&S Spectrum Rider opens a list of geotags that you have saved. In this list, the R&S Spectrum Rider shows some basic information about the geotag.

Signal Strength Mapping Outdoor 1					
Nr	Include 2	Latitude	Longitude 3	Level 4	Name 5
1	<input type="checkbox"/>	N 1° 20' 19.70016"	E 103° 57' 51.90012"	-76.2 dBm	rs
2	<input checked="" type="checkbox"/>	N 1° 20' 0.20004"	E 103° 57' 45.10008"	-76.5 dBm	cbp
3	<input checked="" type="checkbox"/>	N 1° 19' 59.70000"	E 103° 58' 12.79992"	-76.4 dBm	goodyear-co
4	<input type="checkbox"/>	N 1° 20' 19.70016"	E 103° 57' 51.90012"	-54.2 dBm	rs
5	<input checked="" type="checkbox"/>	N 1° 20' 17.46600"	E 103° 57' 52.83000"	-62.1 dBm	6

7

Include 8 View 9 Delete 10 Delete All 11 Exit 12

Figure 11-5: GPS position list

- 1 = Outdoor mapping measurement mode
- 2 = Checkbox to include the geotag on the map display
- 3 = GPS information ("Latitude", "Longitude") of the geotag location
- 4 = Signal strength of the measurement
- 5 = Name of the geotag location
- 6 = Selected geotag in the GPS position list
- 7 = GPS position list
- 8 = Select "Include" softkey to enable or disable the geotag checkbox
- 9 = Select "View" softkey to display complete information of the geotag, see [Figure 11-6](#)
- 10 = Select "Delete" softkey to remove the selected geotag
- 11 = Select "Delete all" softkey to remove all the listed geotag
- 12 = Select "Exit" softkey to quit from the GPS position list

In addition to the basic information, the geotag also consists information e.g. the antenna model used, timestamp of the measurement saved, frequency, bandwidth and level saved.

1. Select one of the geotags available in the list.
2. Select "View" softkey.
The R&S Spectrum Rider opens a dialog box that consists the complete information of the selected geotag.



Figure 11-6: Complete geotag information dialog box

- 1 = Outdoor mapping measurement mode
- 2 = Item number in the GPS position list
- 3 = Complete information of the selected geotag
- 4 = Select "Previous" softkey to view the previous item number in the GPS position list
- 5 = Select "Next" softkey to view the next item number in the GPS position list
- 6 = Select "Edit" softkey to edit the "Name" and "Description" of the geotag information
- 7 = Select "Exit" softkey to quit from the view

The R&S Spectrum Rider allows you to change the name and description anytime you want. All other geotag information is unchangeable after it has been saved.

1. Select "Edit" softkey.
The R&S Spectrum Rider opens a dialog box to change the geotag information.
Note: Only the "Name" and "Description" field are editable in the dialog box, all other information saved are locked.

2. Enter the "Name" or "Description" in the input field.

Displaying geotags

You can also display as many geotags as you want on the map. See [Figure 11-3](#).

1. Select "GPS Position" softkey.
2. Select "GPS Position List" softkey.
The R&S Spectrum Rider opens the "GPS position list" dialog box.
3. Select the geotag you want to display or remove from the map.
The R&S Spectrum Rider highlights the geotag selected. See item 6 in [Figure 11-5](#).
4. Select the "Include" softkey to check or uncheck the selected geotag.
The R&S Spectrum Rider displays or removes the geotag items accordingly on the map.

11.3.5.2 Triangulation

With option R&S FPH-K15, the R&S Spectrum Rider is able to locate the source of interference using the triangulation method.



"GPS Position" is available only if a USB stick is detected on the R&S Spectrum Rider.

To perform triangulation, you have to create at least two or three geotags with azimuth information. After creating the geotags (see ["Creating geotags manually"](#) on page 271), display them on the map (see [Figure 11-7](#)). Based on these geotags, the R&S Spectrum Rider calculates the point at which the azimuth lines of the geotags intersect. This intersection point represents the source of the interference.

If necessary, you can assign a different azimuth for the current position of GPS coordinates.

1. Select "GPS Position" softkey.
2. Select "Save" softkey.
The R&S Spectrum Rider opens a submenu to select the different geotags saving options.
3. Select the "Azimuth Only" menu item.
The R&S Spectrum Rider opens an input field to change the azimuth (the GPS data is not changed). Note that the azimuth line is updated in real time when you change its angle.

Perform triangulation

Triangulation is performed to calculate and determine the source of interference.

1. Select "GPS Position" softkey.
2. Select "GPS Position List" softkey.
The R&S Spectrum Rider opens the "GPS position list" dialog box.
3. Select two or three geotags and display them on the map.
See [Figure 11-7](#).
4. Select "GPS Position" softkey.
5. Select "Triangulation" softkey.
The R&S Spectrum Rider calculates the intersection point of the geotags you have selected. The result is displayed on the map as a dot that is surrounded by a circle. See [Figure 11-2](#).
By default, the dot and circle are blue. However, you can assign a different color to the triangulation results. See "[Default behavior of geotags in triangulation](#)" on page 264.

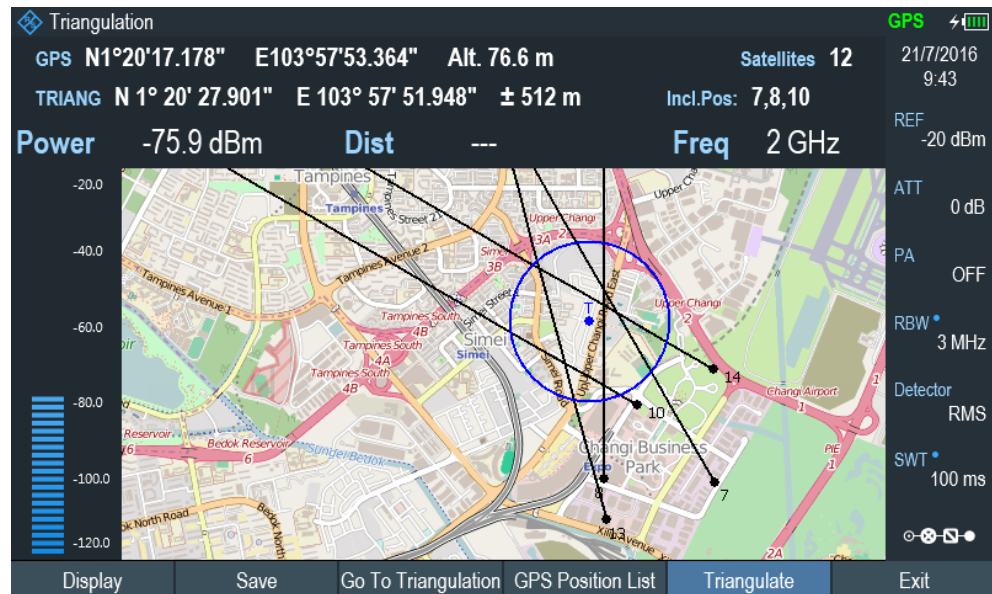

Figure 11-7: Triangulation result

Adding the triangulation result to the GPS position list

1. Select "GPS Position" softkey.
2. Select "Save" softkey.
The R&S Spectrum Rider opens a submenu to select the different geotags saving options.
3. Select the "Triangulation" menu item.
The R&S Spectrum Rider opens an input field to enter a name and description for the triangulation geotag.
4. Enter a name and description.
5. Select the "Save" button to save the new geotag.
The R&S Spectrum Rider creates a geotag in the "GPS Position List".
For more information on the "GPS Position List", see ["Managing geotags"](#) on page 272.

11.3.5.3 Indoor mapping



"Indoor Position" is available only if a USB stick is detected on the R&S Spectrum Rider.

When you enter the "Indoor Mapping" application, the R&S Spectrum Rider always shows the signal strength at the top of the display or in the power bar at the left side of the display. See [Figure 11-1](#).

The method to collect data in the indoor mapping is similar to that of collecting geotags in large-scale map mode.

When you perform a measurement at a particular spot on the map, the application creates a tag (represented by a colored dot) and draws it on the map at your current location. The color of the dot represents the signal strength received at that location, see [Chapter 11.3.3.5, "Selecting colors for map locations"](#), on page 264.

Creating tags

You can create a tag on any place of the map. To do so, you first have to move the crosshair cursor on the map display to the position you are currently at. For more information, see [Chapter 11.3.3.4, "Aligning the indoor mapping mode"](#), on page 263.



Figure 11-8: Tags on indoor mapping

When the crosshair cursor is at the correct location, proceed as follows to save the measured data.

1. Press the rotary knob to confirm the measured data.
The R&S Spectrum Rider creates a tag at your current position, represented by a colored dot on the map. This tag is saved to the "Indoor Position List".
Alternatively, you can do the following option to save the measured data.
2. Press [MEAS] key.
3. Select "Indoor Position" softkey.
The R&S Spectrum Rider opens a submenu to select the different geotags saving options.
4. Select "Capture Position" softkey.
The R&S Spectrum Rider creates a tag in the "Indoor Position List".
See ["Managing tags"](#) on page 279.

Managing tags

The application features an "Indoor Position List" that allows you to manage and edit tags in the list. The "Indoor Position List" contains all the tags that you have created.

1. Press [MEAS] key.
2. Select "Indoor Position" softkey.
3. Select the "Indoor Position List" menu item.
The R&S Spectrum Rider opens a dialog box which contains a list of tags that you have saved. In this list, the R&S Spectrum Rider shows some basic information about the geotag.

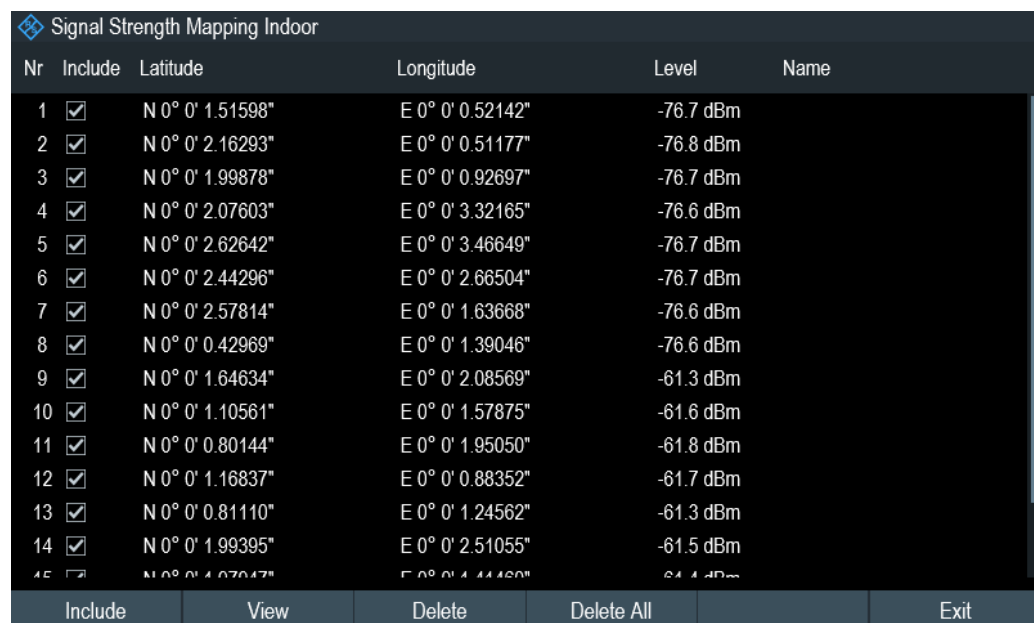

Nr	Include	Latitude	Longitude	Level	Name
1	<input checked="" type="checkbox"/>	N 0° 0' 1.51598"	E 0° 0' 0.52142"	-76.7 dBm	
2	<input checked="" type="checkbox"/>	N 0° 0' 2.16293"	E 0° 0' 0.51177"	-76.8 dBm	
3	<input checked="" type="checkbox"/>	N 0° 0' 1.99878"	E 0° 0' 0.92697"	-76.7 dBm	
4	<input checked="" type="checkbox"/>	N 0° 0' 2.07603"	E 0° 0' 3.32165"	-76.6 dBm	
5	<input checked="" type="checkbox"/>	N 0° 0' 2.62642"	E 0° 0' 3.46649"	-76.7 dBm	
6	<input checked="" type="checkbox"/>	N 0° 0' 2.44296"	E 0° 0' 2.66504"	-76.7 dBm	
7	<input checked="" type="checkbox"/>	N 0° 0' 2.57814"	E 0° 0' 1.63668"	-76.6 dBm	
8	<input checked="" type="checkbox"/>	N 0° 0' 0.42969"	E 0° 0' 1.39046"	-76.6 dBm	
9	<input checked="" type="checkbox"/>	N 0° 0' 1.64634"	E 0° 0' 2.08569"	-61.3 dBm	
10	<input checked="" type="checkbox"/>	N 0° 0' 1.10561"	E 0° 0' 1.57875"	-61.6 dBm	
11	<input checked="" type="checkbox"/>	N 0° 0' 0.80144"	E 0° 0' 1.95050"	-61.8 dBm	
12	<input checked="" type="checkbox"/>	N 0° 0' 1.16837"	E 0° 0' 0.88352"	-61.7 dBm	
13	<input checked="" type="checkbox"/>	N 0° 0' 0.81110"	E 0° 0' 1.24562"	-61.3 dBm	
14	<input checked="" type="checkbox"/>	N 0° 0' 1.99395"	E 0° 0' 2.51055"	-61.5 dBm	
15	<input type="checkbox"/>	N 0° 0' 1.07047"	E 0° 0' 1.44480"	-61.4 dBm	

Include View Delete Delete All Exit

For information of the items in the "Indoor Position List", see [Figure 11-5](#).

To view the complete information of the list:

1. Select one tag in the list.
2. Select "View" softkey.
The R&S Spectrum Rider displays the complete information of the tag. In addition to the signal information, the details of the tag also contain information about the measurement. This information includes, for example, the frequency, measured level or time of the measurement.

The R&S Spectrum Rider allows you to change the name and description anytime you want. All other tag information is unchangeable after saved.

- Select "Edit" softkey.
The R&S Spectrum Rider opens input fields to change the name and description of the location.

Displaying tags

A tag is represented by a dot on the map. You can add or remove tags as you like.

1. Select "Indoor Position" softkey.
The R&S Spectrum Rider opens a submenu to select the different tag saving options.
2. Select the "Indoor Position List" menu item.
3. Select the tag you want to remove or includes.
4. Select "Include" softkey.
The R&S Spectrum Rider unchecks / checks the checkbox at the "Include" column and removes / adds it on the map

Saving measurement data

When you are done with the measurement, you can save the measurement data in a .gpx file for later evaluation in the R&S InstrumentView or other applications like Google Earth.

1. Press [MEAS] key.
2. Select "Indoor Position" softkey.
3. Select the "Save Results" menu item.
The R&S InstrumentView stores the measurement data in a GPX file (it does not matter if you have specified any GPS data in your map). When you are done with the measurement, you can save the measurement data in a .gpx file for later evaluation in the R&S InstrumentView or other applications like Google Earth.

Restoring measurement data previously recorded

In the same way, you can also restore a GPX file that you have saved previously.

1. Press [MEAS] key.
2. Select " Indoor Position" softkey.
3. Select the "Select GPX File" menu item.
The R&S Spectrum Rider restores the measurement data saved in the selected GPX file. You can then add or remove tags as required.
If you have specified the GPS reference points for the indoor map, you can also load the measurement data into a different map. (For example, a larger scale floor plan of a building or embed the indoor data into an outdoor map).
To do so, load a different map via the "Map" softkey and load the corresponding GPX data. If the map and GPX data are not compatible, the R&S Spectrum Rider will not display the measurement data stored in the GPX file.
Note that you have to load the map first before restoring the GPX file.

If the GPX data is not compatible with the currently displayed map or does not contain any GPS information, the R&S Spectrum Rider shows a corresponding message.

11.3.6 Analyzing geographic data

The R&S InstrumentView software package provides an interface that allows you to export and review your recorded data with Google Earth. This interface transforms .gpx files into ".kmz" files (required by Google Earth). It also contains a plug-in that illustrates the signal levels measured at the GPS coordinates that you have added to the .gpx file.

For more information on the conversion of .gpx file to ".kmx" files, see "GPX Conversion" in the R&S InstrumentView.

Include	Latitude	Longitude	Level	Name	Description
<input checked="" type="checkbox"/>	1° 19.4395' N	103° 56.1076' E	-53.4 dBm		
<input checked="" type="checkbox"/>	1° 20.6597' N	103° 56.2003' E	-57.4 dBm		
<input checked="" type="checkbox"/>	1° 19.9853' N	103° 54.8356' E	-76.5 dBm		
<input checked="" type="checkbox"/>	1° 19.2593' N	103° 55.4794' E	-49 dBm		
<input checked="" type="checkbox"/>	1° 20.5104' N	103° 55.5309' E	-51.9 dBm		
<input checked="" type="checkbox"/>	1° 20.0625' N	103° 56.6947' E	-76.6 dBm		
<input checked="" type="checkbox"/>	1° 19.1049' N	103° 56.7565' E	-76.6 dBm		
<input checked="" type="checkbox"/>	1° 19.6146' N	103° 57.1891' E	-58.1 dBm		
<input type="checkbox"/>	1° 24.0267' N	103° 53.7078' E	-76.5 dBm		
<input checked="" type="checkbox"/>	1° 20.3283' N	103° 57.8650' E	-76.2 dBm	rs	ref
<input checked="" type="checkbox"/>	1° 20.0033' N	103° 57.7517' E	-76.5 dBm	cbp	
<input checked="" type="checkbox"/>	1° 19.9950' N	103° 58.2133' E	-76.4 dBm	goodyear-co	
<input type="checkbox"/>	1° 20.3283' N	103° 57.8650' E	-54.2 dBm	rs	
<input checked="" type="checkbox"/>	1° 20.2911' N	103° 57.8805' E	-62.1 dBm		
<input checked="" type="checkbox"/>	1° 19.9950' N	103° 58.2133' E	-75.4 dBm	Goodyear	

Figure 11-9: Combination of multiple GPS lists

11.3.7 Analyzing indoor data

The R&S InstrumentView software package provides an interface that allows you to export and review your recorded data with external tools. This interface transforms the measurement data into an image or a CSV file. For more information on the indoor data analysis tool, see "Map Analysis" in the R&S InstrumentView.

When you add GPS reference information to the indoor map, it is also possible to export the data collected indoors as a .kmz file and import it into Google Earth. For more information, see [Chapter 11.3.6, "Analyzing geographic data"](#), on page 281.



Figure 11-10: Indoor mapping with signal strength and indices displayed.

12 Receiver mode



R&S Spectrum Rider option

R&S FPH-K43 (order number: 1321.0621.02) option is required to operate the R&S Spectrum Rider in the receiver mode.

Equipped with firmware option R&S FPH-K43, you can perform receiver and channel measurements (or scans) with your R&S Spectrum Rider.

In receiver mode, the R&S Spectrum Rider measures the power level of a particular frequency or a customized set of frequencies instead of sweeping over (parts of) the frequency spectrum. The R&S Spectrum Rider shows the scan results in result displays that have been designed for such measurement tasks.

The receiver mode also adds the necessary functions like bandwidths or detectors to perform measurements according to CISPR.

By default, the R&S Spectrum Rider is in the last operating mode after you have turned it on. To switch to the receiver mode from another operating mode, proceed the following:

1. Press [MODE] key.
2. Select "Receiver" softkey.
The R&S Spectrum Rider starts the receiver mode in single frequency measurement mode.

- [Selecting the measurement mode](#)..... 283
- [Configuring measurements in receiver mode](#)..... 290

12.1 Selecting the measurement mode

In receiver mode, the R&S Spectrum Rider features two measurement modes.

- Fixed Frequency / Channel
- Frequency Scan / Channel Scan

Fixed measurement mode is designed for measurements on single frequencies. Scan measurement mode performs scans on a defined set of frequencies.

- [Performing single frequency measurements](#).....283
- [Performing frequency scans](#)..... 287

12.1.1 Performing single frequency measurements

The R&S Spectrum Rider shows the result of the single frequency measurement in a result display that contains three main elements.

Selecting the measurement mode

1. Measurement (or receive) frequency
2. Power level measured at the receive frequency
3. Horizontal bargraph that graphically represents the currently measured power level.

In the default state, the R&S Spectrum Rider performs the measurement on a single receive frequency. If it instead shows the result display for a frequency scan, you can access the single frequency result display manually.

1. Press [MEAS] key.
2. Select "Fixed Freq" softkey.

The R&S Spectrum Rider shows the result display for single frequency measurements.

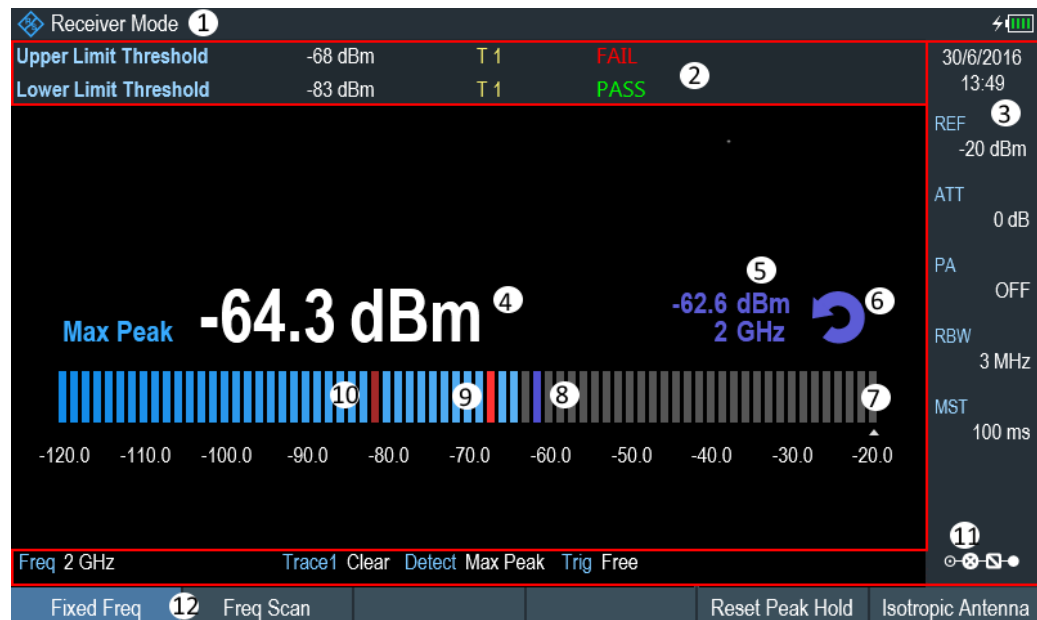

- 1 = Operating mode
- 2 = [Measurement result view](#)
- 3 = [Parameter view](#)
- 4 = Corresponding power level of the receiver frequency
- 5 = Maximum hold power level of the receiver frequency
- 6 = Refresh button to refresh peak hold power level of the receiver frequency
- 7 = Bargraph
- 8 = Maximum hold power level indicator
- 9 = Upper limit threshold indicator
- 10 = Lower limit threshold indicator
- 11 = [Configuration overview](#)
- 12 = Receiver softkey menu

12.1.1.1 Defining the receive frequency



Channel frequency scan

The R&S Spectrum Rider performs a scan of maximum 711 sweep points across the spectrum span.

In single frequency measurement mode, the R&S Spectrum Rider determines the power level of a single frequency only. The available frequency range depends on the R&S Spectrum Rider that you are using.

1. Press [FREQ] key.
2. Select "Frequency" softkey.
The R&S Spectrum Rider opens an input field to define the frequency input.

For a quick change of frequencies with the rotary knob, define a frequency stepsize.

1. Select "Freq Step" softkey.
The R&S Spectrum Rider opens a submenu that contains possible step sizes. See [Chapter 6.2.2.2, "Defining a frequency step size"](#), on page 174.
2. Select the step size you need from the menu.
The R&S Spectrum Rider adjusts the step size accordingly.

For measurements on systems that use channels instead of single frequencies, you can also load a channel table and measure the channel power. See [Chapter 6.3, "Working with channel tables"](#), on page 211.

1. Select "Freq Mode" softkey.
The R&S Spectrum Rider opens a submenu that contains the channel menu items.
2. Select the "Channel Downlink" or "Channel Uplink" menu item.
The R&S Spectrum Rider opens the "File Manager" dialog to select a channel table.
3. Select one of the available channel tables.

12.1.1.2 Customizing the bargraph aspects

The bargraph is a graphical representation of the power level with one dimension, the power level of the receive frequency. The R&S Spectrum Rider provides several ways to customize the aspects of the bargraph.

Selecting the unit

By default, the unit the R&S Spectrum Rider uses in receiver mode for the measured power levels in general is dB μ V. In addition to dB μ V, the receiver mode provides other units as well.

1. Press [AMPT] key.
2. Select "Unit" softkey.
The R&S Spectrum Rider opens a submenu that contains the possible units for selection.
3. Select the unit.





Defining the bargraph scale

The scale of the bargraph is defined by the reference level and level range.

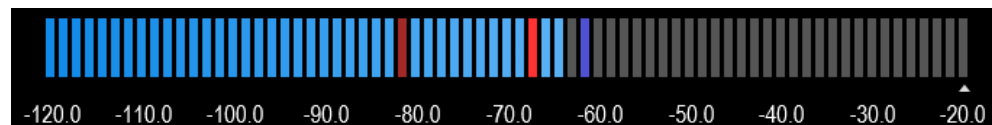
The reference level is the maximum power level that the bargraph displays. You should set the reference level in a way that the signal level does not exceed the reference level and high enough so that the signal does not disappear in the inherent noise.

1. Press [AMPT] key.
2. Select "Ref Level" softkey.
The R&S Spectrum Rider opens an input field to define the reference level.
3. Define the reference level that best fits the measurement.
In the default state, the reference level corresponds to the level at the right of the bargraph.
The reference level position is shown by a triangle ▲ in the bargraph scale label.



Bargraph icon		Descriptions
Blue bar	 	Current power level. Maximum hold power level.
Red bar	 	The red bar shows the limit line level. If the limit line is violated, the color changes to a brighter red indicator.
Triangle		Reference power level.

You can move the reference position to another position on the scale.

1. Press [AMPT] key.
2. Select "Range / RefPos" softkey.
The R&S Spectrum Rider opens a submenu that contains the range and reference position for selection.
3. Select the "Ref Position" menu item.
The R&S Spectrum Rider opens an input field to define the reference position.
4. Enter the number of the grid line you want the reference level to be at.

The range is from 0 to 10, where "0" corresponds to the left side of the bargraph and "10" corresponds to the right side of the bargraph.

You can also select the level range that the bargraph covers. In the default state, the bargraph covers 100 values of the unit you have selected (e.g. 100 dB μ V).

1. Select "Range / RefPos" softkey.
The R&S Spectrum Rider opens a submenu that contains the range and reference position for selection.
2. Select the "Range 100dB" menu item.
The R&S Spectrum Rider opens an input field to define the level range.
3. Select the level range.

12.1.2 Performing frequency scans

Compared to single frequency measurements, frequency scans perform a measurement on a particular set of receive frequencies. The scan measures only those frequencies that are defined in the frequency range. The space between the receive frequencies is not considered in the measurement.

The R&S Spectrum Rider shows the results for a frequency scan in a graphical result display. The horizontal axis in that display represents the frequency spectrum covered by the scan. The vertical axis represents the power levels.

The power levels for each frequency contained in the scan are represented by a vertical line at the receive frequencies that have been measured. This type of display emphasizes the fact that the scan measures single receive frequencies only and not the frequencies between those receive frequencies.

1. Press [MEAS] key.
2. Select "Freq Scan" softkey.
The R&S Spectrum Rider shows the scan result display. See [Figure 12-1](#).

The "Polygon" trace style shows the trace as a continuous, horizontal line. The gaps between the actual measurement frequencies are interpolated.

12.1.2.1 Defining the scan range

The scan range defines the frequency range that the scan takes place in. Therefore, you have to define a start and stop frequency for the scan range and a scan step size. The step size defines the (equidistant) space between the receive frequencies and thus, in combination with the start and stop frequency, the number of receive frequencies considered in the scan.

Example:

If you define a scan range from 100 MHz to 200 MHz with a step size of 10 MHz, the receive frequencies that are analyzed are 100 MHz, 110 MHz, 120 MHz, ..., 200 MHz. Overall, this scan range defines a set of 11 receive frequencies.

1. Press [FREQ] key.
2. Select "Start Freq" softkey.
The R&S Spectrum Rider opens an input field to define the start frequency.
3. Enter the frequency you want the scan to start at.
4. Select "Scan Stop" softkey.
The R&S Spectrum Rider opens an input field to define the stop frequency.
5. Enter the frequency you want the scan to stop at.
6. Select "Scan Step" softkey.
The R&S Spectrum Rider opens an input field to define the scan step frequency.
7. Enter the step size you want to apply. The R&S Spectrum Rider starts the scan when you have finished defining the scan range.

Performing a channel scan

Instead of a frequency scan, you can also perform a channel scan. A channel scan is based on the contents of a channel table. If there are measurements based on a channel table, the set of receive frequencies (or channels) is defined in a channel table.

In a channel table, you can define the receive frequencies as you wish. The number of receive frequencies depends on the number of channels included in the channel table and there may even be gaps between the receive frequencies.

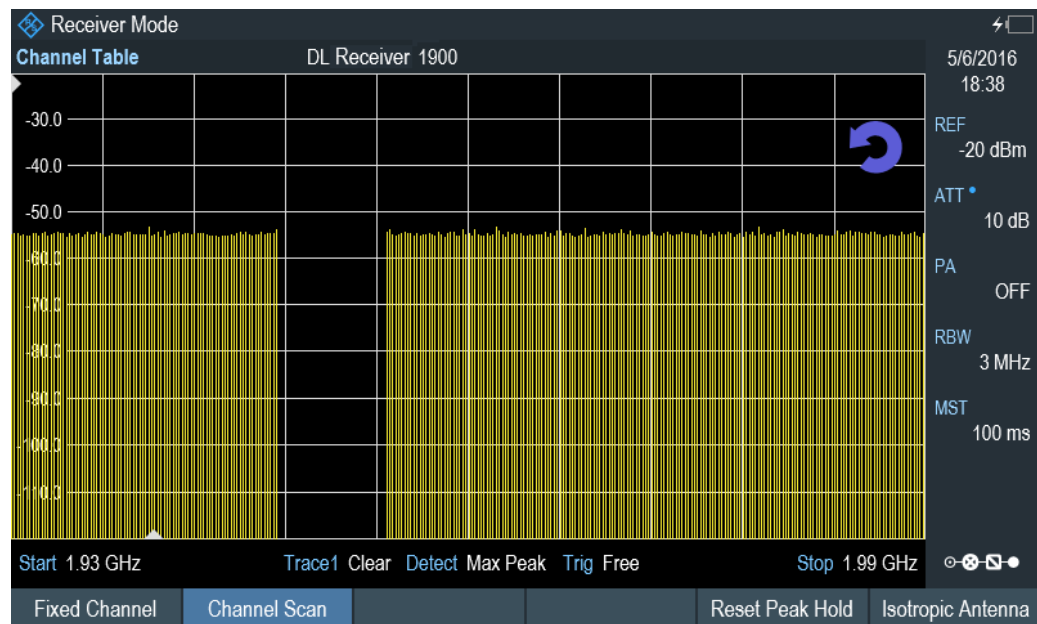

Figure 12-2: Channel scan

1. Press [FREQ] key.
2. Select "Freq Mode" softkey.
The R&S Spectrum Rider opens a submenu containing the different channel options for selection.
3. Select the "Channel Downlink" or "Channel Uplink" to define the channel table.
The R&S Spectrum Rider opens a dialog box to select the channel table.

For more information on working with channel tables, see [Chapter 6.3, "Working with channel tables"](#), on page 211.

12.1.2.2 Using markers

The scan measurement in receiver mode features the same marker functionality as that in spectrum mode.

For more information, see [Chapter 6.2.8.1, "Using markers and deltamarkers"](#), on page 196.

12.2 Configuring measurements in receiver mode

In addition to the single frequency measurement and the scan measurement, the receiver mode also adds features in accordance with EMI measurements.

- [Selecting detectors for EMI measurements](#)..... 291
- [Selecting the measurement bandwidths for EMI measurements](#)..... 292
- [Defining the measurement time](#)..... 292

• Working with traces	293
• Using transducers	293
• Using limit lines	293
• Using isotropic antenna	293
• Save measurements	294

12.2.1 Selecting detectors for EMI measurements

- **Max Peak**
If the max peak detector is active, the R&S Spectrum Rider displays only the maximum power of the signal that was measured during the measurement time.
- **Average**
If the average detector is active, the R&S Spectrum Rider calculates and displays the (linear) average power of the signal that was measured during the measurement time.
- **RMS**
If the RMS detector is active, the R&S Spectrum Rider calculates and displays the RMS power of the signal that was measured during the measurement time.
- **Quasi Peak**
If the quasi peak detector is active, the R&S Spectrum Rider evaluates the signal in a way that complies to the requirements defined by CISPR16. It is designed for EMI measurements and especially useful for the evaluation of pulse shaped spurious emissions.
When you use the quasi peak detector, the R&S Spectrum Rider uses a particular evaluation curve or bandwidth depending on the CISPR band.
 - CISPR band A (frequencies from 9 kHz to 150 kHz): 200 Hz bandwidth
 - CISPR band B (frequencies from 150 kHz to 30 MHz): 9 kHz bandwidth
 - CISPR band C/D (frequencies from 30 MHz to 1 GHz): 120 kHz bandwidth
 Note: Frequencies below 9 kHz and above 1 GHz are not allowed with "Auto CISPR BW". The R&S Spectrum Rider uses "Manual CISPR BW". With "Manual CISPR BW", you can input the CISPR bandwidth.



Bandwidth selection for the quasi peak detector

If you select the quasi peak detector, the R&S Spectrum Rider automatically selects a 6 dB filter bandwidth depending on the measurement frequency.

If you select a 3 dB bandwidth while using the quasi peak detector, the R&S Spectrum Rider deactivates the quasi peak detector.

1. Press [TRACE] key.
2. Select "Detector" softkey.
The R&S Spectrum Rider displays the submenu to select the trace detector.
3. Select the detector.
See [Chapter 6.2.7.2, "Selecting the detector"](#), on page 193

Selecting the trace mode and working with memory traces

For more information on trace modes and memory traces, see [Chapter 6.2.7.1, "Selecting the trace mode"](#), on page 192 and [Chapter 6.2.7.4, "Working with memory traces"](#), on page 195.

12.2.2 Selecting the measurement bandwidths for EMI measurements

The receiver mode adds 6 dB resolution bandwidths to the 3 dB resolution bandwidths already available in other operating modes. The 6 dB bandwidths are special bandwidths that are necessary for measurements according to CISPR16.

If automatic selection of the CISPR bandwidth is on, the R&S Spectrum Rider selects an appropriate CISPR bandwidth, depending on the receive frequency.

- Frequencies from 9 kHz to 150 kHz: 200 Hz CISPR bandwidth
- Frequencies from 150 kHz to 30 MHz: 9 kHz CISPR bandwidth
- Frequencies from 30 MHz to 1 GHz: 120 kHz CISPR bandwidth

You can also select a 3 dB or 6 dB bandwidth manually.

1. Press [BW] key.
2. Select "Manual RBW" softkey to select a 3 dB bandwidth.
3. Alternatively, select "Manual CISPR BW" softkey to select a 6 dB bandwidth. The R&S Spectrum Rider opens an input field to define the CISPR bandwidth.
4. Select the bandwidth with the rotary knob or by entering the corresponding number.
5. Select "Auto CISPR BW" to select the 6 dB bandwidth automatically according to the list above.

12.2.3 Defining the measurement time

The measurement time is the time that the R&S Spectrum Rider collects data at each measurement frequency to calculate the results for that frequency according to the detector you have selected.

You can define a measurement time between 5 ms and 1000 s.

1. Press [SWEEP] key.
2. Select "Meas Time" softkey. The R&S Spectrum Rider opens an input field to define the measurement time.
3. Define the measurement time.

Selecting the scan mode

When you enter the receiver mode, the R&S Spectrum Rider repeatedly measures the receive frequency or set of frequencies over the measurement time you have defined. If you want to perform a single measurement or scan only, select single scan mode.

1. Press [SWEEP] key.
2. Select "Single Scan" softkey to perform a single scan or measurement.
3. Select "Cont Scan" softkey to perform a continuous scan or measurement.

When you select single scan mode, the R&S Spectrum Rider performs the measurement once over the measurement time and then stops. In case of frequency scans, the R&S Spectrum Rider performs one measurement on each receive frequency in the scan range over the measurement time and stops when it has measured all frequencies that are part of the scan range.

12.2.4 Working with traces

In Receiver mode, the R&S Spectrum Rider provides several ways to configure the trace display, like the trace mode or trace mathematics.

For more information, see

- [Chapter 6.2.7.1, "Selecting the trace mode"](#), on page 192
- [Chapter 6.2.7.3, "Working with a second trace"](#), on page 194
- [Chapter 6.2.7.4, "Working with memory traces"](#), on page 195
- [Chapter 6.2.7.5, "Using trace mathematics"](#), on page 196
- [Chapter 12.1.2, "Performing frequency scans"](#), on page 287

12.2.5 Using transducers

For more information, see [Chapter 6.4, "Using transducer factors"](#), on page 212.

12.2.6 Using limit lines

For more information, see [Chapter 6.2.10, "Using limit lines"](#), on page 208.

12.2.7 Using isotropic antenna

For more information, see [Chapter 6.1.10, "Using isotropic antennas"](#), on page 165.

12.2.8 Save measurements

The R&S Spectrum Rider is able to save both [single frequency measurement](#) and [frequency scan measurement](#) if you are using the "Save on Event" functionality. Depending on the trigger event (time, limit failure, distance, every sweep event), screenshots with measurement of the receiver mode are saved for further analysis.

For more information, see [Chapter 4.7, "Saving on events"](#), on page 102.

13 EMF measurement



R&S Spectrum Rider option

R&S FPH-K105 (order number: 1334.6946.02) option is required to operate the R&S Spectrum Rider in the EMF measurement mode.

Equipped with firmware option R&S FPH-K105, you can perform electromagnetic field of (demodulated) signals with your R&S Spectrum Rider.

The option provides tools and means to check if the field strength in a certain area is within the specified limits and therefore harmless for people.

In addition to the EMF option, measuring the field strength requires:

- An isotropic antenna like the R&S TSEMF-B1, R&S TSEMF-B2 or R&S TSEMF-B3 (order no. 1074.5719.02, 1074.5702.02 or 1074.5690.02). You can connect them to the RF input of the R&S Spectrum Rider. The typical transducer factors for these antennas are already stored on the internal memory of the R&S Spectrum Rider.
- The R&S InstrumentView software package to define a measurement set. The software also features tools to review the measurements when they are done.

1. Press the [WIZARD] key.

2. Select the "EMF" softkey.

The R&S Spectrum Rider activates the mode for EMF measurement and displays the EMF measurement window which allows you to perform the following functions:

- "Load Meas Set": Loading *.emdf file of the measurement set. See [Chapter 13.2.1, "Loading a measurement set"](#), on page 302.
- "Start Meas": Available after a measurement set file is loaded. See [Chapter 13.2.3, "Performing a sequence of measurements"](#), on page 304.
- "Meas Setting": Display measurement details. See [Figure 13-3](#).
- "Meas Spec": Display measurement step sequences and individual performed measurement status included in the loaded *.emdf file. See [Chapter 13.2.2, "Measurement specification"](#), on page 303.
- "Exit": Exit EMF measurement.

Basic idea for EMF measurements

EMF measurements are similar to measurements with the measurement wizard. The actual measurement in the field is a mostly automated process with limited options. It follows a certain sequence defined in a measurement set.

A measurement set is a series of different types of measurement. These individual measurements in turn can consist of several sub-measurements.

You can configure measurements with the functionality of the R&S InstrumentView software. The R&S InstrumentView also provides functionality to review and analyze the results of the measurement after you are done in the field.

- [Preparing an EMF measurement](#)..... 296
- [Running the EMF measurement](#)..... 301
- [Evaluating results](#)..... 308

13.1 Preparing an EMF measurement

Preparing an EMF measurement consists of two steps.

- Configure measurements
- Compile a measurement set out of one or more measurements

You can do both with the functionality that comes with the R&S InstrumentView software package.

For a comprehensive description of the R&S InstrumentView software, refer to its user manual available on the internet.

- [Configuring measurements](#)..... 296
- [Compiling a measurement set](#)..... 299

13.1.1 Configuring measurements

A measurement in the context of the EMF application is the basis for the measurement set you later use for the actual measurement in the field. The main identifier of a measurement is the measurement mode. The measurement mode defines the application that the R&S Spectrum Rider uses for a measurement.

The EMF application provides several measurement modes.

- The quick scan, which is exclusive to the EMF measurement application.
A quick scan is a spectrum measurement over a certain span and resolution bandwidth over a set of frequencies. Frequencies that violate a threshold line are noted as result. You can use the quick scan as a preliminary measurement to find peaks that could indicate unwanted emissions, before running an actual EMF measurement.
The configuration of the quick scan is the same as the spectrum measurement. For a detailed analysis of the peaks, use one of the other following measurements.
- The basic spectrum measurement from the spectrum analyzer, for details see [Chapter 6.1.1, "Measuring basic signal characteristics"](#), on page 123.
- The channel power measurement from the spectrum analyzer, for details see [Chapter 6.1.2, "Measuring the channel power of continuously modulated signals"](#), on page 125.

The measurement you define can in turn consist several sub-measurements. A sub-measurement is always the same type as the measurement it belongs to, but on a different frequency.

When you configure a measurement, you have to define the basic measurement settings and the characteristics of the equipment you are using for the measurement. You can take the basic measurement settings like measurement bandwidth or reference

level from a dataset you have previously made. For more information about datasets, see [Chapter 4.8, "Managing datasets"](#), on page 105.

1. Start the R&S InstrumentView software.
2. Select the "Preparation" > "EMF Config" tool.

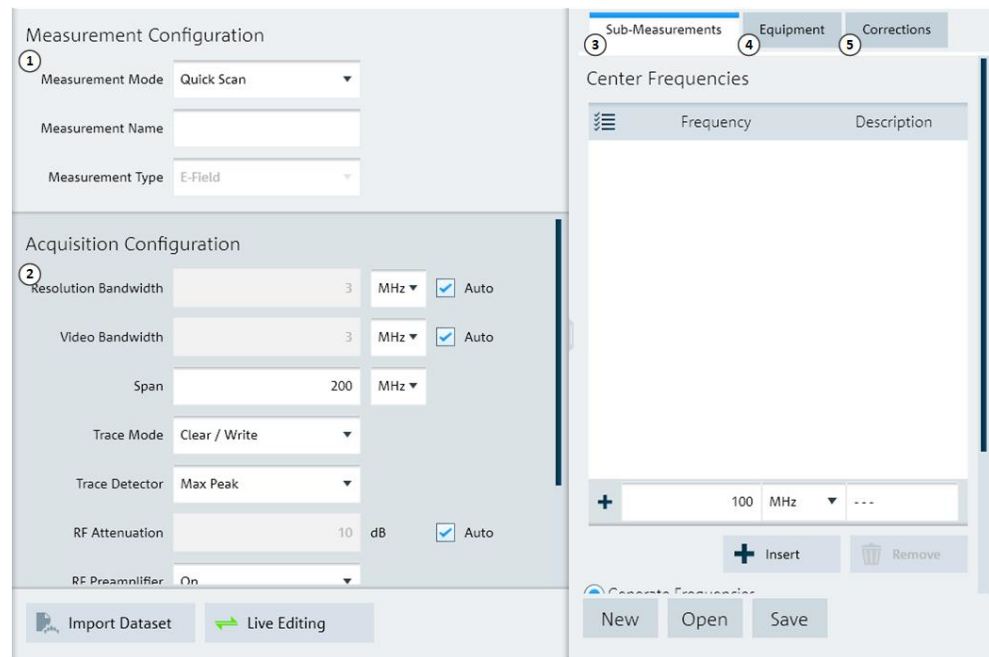

Figure 13-1: EMF config dialog

- 1 = Measurement mode selection
- 2 = Signal capture settings depending on the selected measurement mode selection
- 3 = Sub-measurement configuration
- 4 = Antenna configuration
- 5 = Configuration of correction values and extrapolation

General measurement configuration

A measurement is defined by its mode and specific measurement settings.

1. Select "Measurement Mode" menu item.
The settings available in the "Acquisition Configuration" change accordingly.
2. Define a name for the measurement.
3. Define the signal capture properties in the "Acquisition Configuration".
For more information about configuration the spectrum measurement, see [Chapter 6.2, "Configuring spectrum measurements"](#), on page 172 and [Chapter 6.1.2, "Measuring the channel power of continuously modulated signals"](#), on page 125.
You can import a dataset with measurement settings that you have previously saved, instead of defining the settings manually.

Instead of creating a new measurement, you can also load and edit a measurement that you already have with the "Open" button in the "Sub-Measurement" tab. Make sure to save the new measurement under a different name.

Live editing mode

In addition to restoring existing datasets or measurement sets, you can directly update certain measurement settings on a connected instrument.

1. Establish a LAN or USB connection to the R&S Spectrum Rider.
2. Select "Live Editing" in the R&S InstrumentView software.
Change the settings as required. R&S InstrumentView verifies the value you enter before accepting it. If the value is not allowed for any reason, R&S InstrumentView uses the default value instead.
Note that you can only enter live editing mode while configuring a measurement, and not during a measurement.
3. Select "Live Editing" again to exit the live editing mode.

Sub-measurement configuration

If you measure more than one frequency, each of those measurements is considered a sub-measurement.

You can define the frequencies that should be captured during a measurement.

1. Select the "Sub-Measurement" tab.
2. Add frequencies manually by entering a number, the unit and, optionally, a description.
Instead of entering a list of frequencies manually, you can also generate a list of frequencies by defining a start and stop frequency and a step size. The R&S InstrumentView populates the list.

You can also define the frequencies as a list of channels.

1. Select the "Generate Channel Numbers" radio button.
2. Select a channel table and define the characteristics (first and last channel, step size and frequency band you want to measure).
For a detailed description about creating channel tables, refer to the R&S InstrumentView user manual.

After the measurement is done, you can view the results for each frequency you have measured. The EMF result summary lists all measured frequencies in ascending order.

Maximum number of sub-measurement

For spectrum and channel power measurements, you can add up to 99 sub-measurements (frequencies).

Transducer configuration

Depending on the antenna, you are using for the measurement, you have to select a transducer specified for that antenna.

1. Select the "Equipment" tab.
2. Select a transducer with the "Select" button in the "Antenna" pane.
The "Comment" field shows a description of the transducer when one has been defined.
3. Select the direction the transducer applies to.
In addition, you have to define the characteristics of the cable you are using to connect the antenna to the R&S Spectrum Rider. You can define the cable characteristics either as a constant attenuation, or a transducer that contains frequency-dependent attenuation values.
For more information about measurements with transducers, see [Chapter 6.4, "Using transducer factors"](#), on page 212.

Configuration of other correction values

You can also define various other correction values, if the measurement requires them. Note that you can also correct the results later when you analyze them in the R&S InstrumentView software. For details see, [Chapter 13.2, "Running the EMF measurement"](#), on page 301.

1. Select the "Correction" tab.
2. Define correction values, if necessary. Entering a "0" means that no correction is applied.
 - a) "Antenna Anisotropy": Takes directional inequalities of an isotropic antenna into account.
 - b) "Instrument Uncertainty": Takes an instrument uncertainty into account.

13.1.2 Compiling a measurement set

A measurement set is a sequence of single measurements. After you have created one or more measurements (see [Chapter 13.1.1, "Configuring measurements"](#), on page 296), you can combine them into a measurement set.

Note that sometimes, measurement sets created with an earlier firmware are not compatible to the latest firmware version. Measurement might yield invalid results in that case.

1. Start the R&S InstrumentView software.
2. Select the "Preparation" > "EMF Sets" tool.

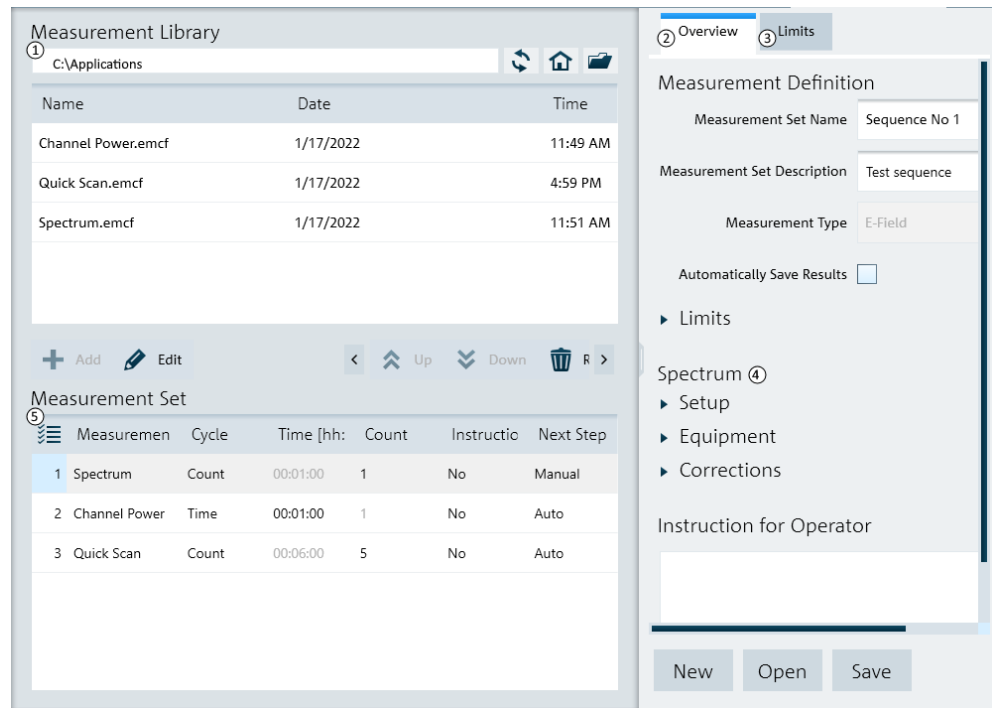

Figure 13-2: EMF measurement library

- 1 = File manager
- 2 = Measurement set properties
- 3 = Limit line selection
- 4 = Properties of the selected single measurement
- 5 = Measurement sequence table

3. Add one or more measurements to the sequence in the file manager area.
4. Rearrange the measurements if necessary with the "Up" or "Down" buttons.
5. Configure the measurement details for each measurement in the sequence table.

Table 13-1: Measurement set configuration

Measurement set parameters	Descriptions
"Cycles"	Defines if the R&S Spectrum Rider runs a sub-measurement for a certain time period or a certain number of times.
"Time"	Defines the measurement time of a sub-measurement in terms of a time period. The R&S Spectrum Rider repeats each individual sub-measurement for the specified time period. When the time is up, the currently running sub-measurement is finished before the next (sub-) measurement begins. The time it takes to finish a single sub-measurement depends on the data acquisition settings. Available for "Cycle" = "Time".
"Count"	Defines the measurement time of a sub-measurements in terms of a counter. The R&S Spectrum Rider repeats each sub-measurement a certain number of times, regardless of how long that takes. The time it takes to finish a single sub-measurement depends on the data acquisition settings. Available for "Cycle" = "Count".

Measurement set parameters	Descriptions
"Instruction"	Turns the display of a message box that contains measurement instructions on and off. If you turn it on, the R&S Spectrum Rider displays the instructions before you can start the next measurement. You can define instructions for each measurement in the "Overview" tab
"Next Step"	Defines if the next measurement is initiated automatically, or not. If you select the manual initiation, you can review the results of the last measurement before the next one begins, but have to initiate the next measurement manually.

6. Define a name for the measurement sequence in the "Overview" tab. You can also add a description.
7. Review the configuration of the selected measurement by expanding the "Setup", "Equipment" and "Corrections".
8. If you want to display instructions before a measurement starts, you can add instructions in the corresponding field. The text is displayed in a message box before the measurement it is assigned to starts.
9. Select limit lines that the results should be tested against in the "Limits" tab. This is optional, but useful, because you will immediately see if the results violate your local limits and regulations. You can select up to two limit lines.
10. "Save" the measurement set.

Uploading the measurement set

In order to perform the actual measurements, you have to upload the measurement set to the R&S Spectrum Rider with the file transfer tool.

1. Start the R&S InstrumentView software.
2. Select the "Instrument" > "File Transfer" to upload file to R&S Spectrum Rider.
3. Navigate to the directory that contains the measurement set.
4. Select the measurement set you want to upload.
5. Copy the files with the " << " button.
The software stores a copy of the measurement set in the memory of the R&S Spectrum Rider. Alternatively, you can use a memory stick or SD card to transfer and access a measurement set on the R&S Spectrum Rider.

13.2 Running the EMF measurement

Now that the measurement set is available on the R&S Spectrum Rider you can start measuring the EMF.

- [Loading a measurement set](#).....302
- [Measurement specification](#)..... 303
- [Performing a sequence of measurements](#)..... 304
- [Contents of the result displays](#).....306
- [Graphical results](#).....306
- [Numeric results](#).....307

13.2.1 Loading a measurement set

1. Press the [WIZARD] key.
2. Select the "EMF" > "Load Meas Set" softkey.
The R&S Spectrum Rider opens the file manager.
3. Navigate to the directory that contains the measurement set.
4. Select the file that contains the measurement set that you require.
5. Confirm the selection with the "Select" softkey.

If the selected measurement set is not compatible to the configuration of the R&S Spectrum Rider you are using, it displays a corresponding message. This may be the case, for example, if the measurement set contains measurements on frequencies that the R&S Spectrum Rider model you are using does not support or if a required option is not installed.

The R&S Spectrum Rider returns to the EMF "Meas Setting" dialog. It now displays information about the measurement set you have loaded.

Note that it is not possible to change the configuration of a measurement once you have copied it to the R&S Spectrum Rider.

Measurement Definition		Sequence No 1
General	User	Me
	Name	HMR
	Description	Sequence example
Site	Site Name	Office
	Comments	Test Sequence
	GPS Position	not connected

Softkeys: Load Meas Set | Start Meas | **Meas Setting** | Meas Spec | Exit

Figure 13-3: EMF setting dialog

The dialog box contains the following information:

Table 13-2: EMF information

EMF information	Description
"Measurement Definition"	Name of the EMF measurement set currently in use.
"User"	Name of the person that performs the measurement.
"Name"	Name of the measurement.
" Description"	Short description of the measurement task. This is a read-only field that shows the description as defined with the R&S InstrumentView software.
"Site Name"	Location of the measurement.
"Comments"	Comments about the measurement, e.g. the external conditions during the measurement.
"GPS Position"	Shows the GPS position, if you have connected a GPS receiver. Pressing the [ENTER] key on this field results in an update of the GPS coordinates.

13.2.2 Measurement specification

The measurement specification dialog box lists the individual measurement step that needs to be performed for successful completion of the measurement task. The list shows the measurements that have already been done as well as those that still have to be done.

- ▶ Select "Meas Spec" softkey.
For each measurement, see [Table 13-1](#) for the configured measurement set information.



Measurements	Cycle	Duration	Count	Instruction	Next Step	Status
Spectrum	Time	000:02 h	1	No	Auto	<done>
Channel Power	Time	000:04 h	1	No	Manual	<not done>
Quick Scan	Count	000:00 h	20	No	Manual	<not done>

Load Meas Set Start Meas Meas Setting Meas Spec Exit

Figure 13-4: Measurement specification dialog

13.2.3 Performing a sequence of measurements

Before you start the measurement, you can enter the information specific to the measurement like site name, name of the operator etc. It can be helpful later on when reviewing the results.

1. Start the measurement with the "Start Meas Set" softkey.
The R&S Spectrum Rider initiates the first measurement in the measurement set.
The displayed result display depends on the measurement type.

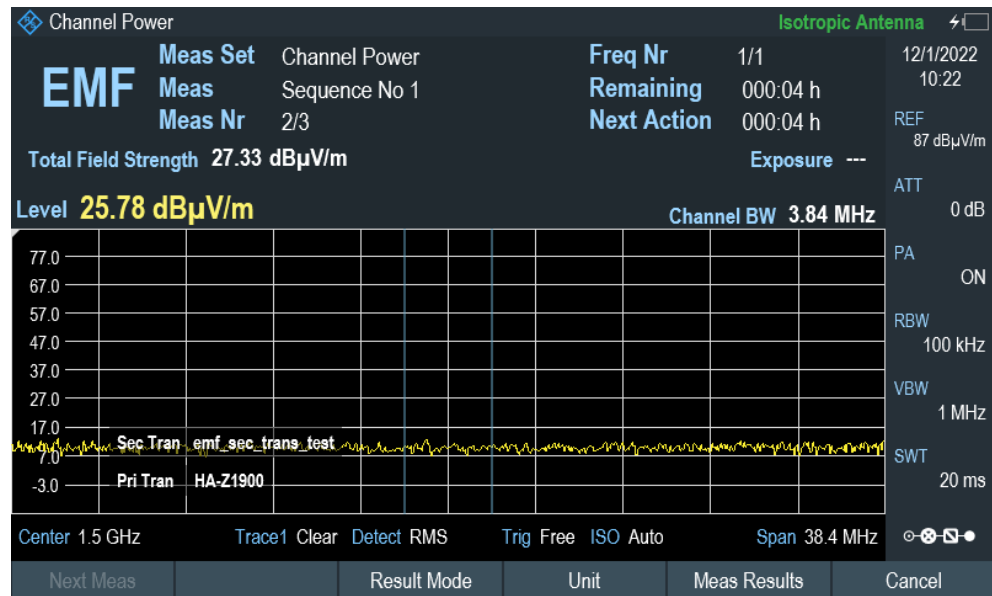

Figure 13-5: EMF measurement dialog

2. While the measurements runs, you have a few options.
 - "Result Mode": Selects the way the field strength is evaluated over the measurement time. You can display the average, minimum, maximum or RMS field strength.
 - "Unit": Selects the unit in which the field strength is displayed. By default, the unit is set to "V/m". You can display the result in "dBµV/m", "V/m" or "dBµA/m".
 - "Meas Results": Opens a numeric result summary to review the results of the currently running measurement. See [Chapter 13.2.6, "Numeric results"](#), on page 307.
 - "Cancel": Aborts the measurement sequence. When you abort the sequence, the R&S Spectrum Rider asks you if want to save the results you already have.

All other features are locked.

3. Wait until the measurement is done. When a measurement is done (it can take a while, depending on the duration you have defined), the R&S Spectrum Rider either asks you to start the next measurement or automatically starts the next measurement in the sequence.

In case of limit violations, the R&S Spectrum Rider shows a corresponding warning message.

This process repeats until all measurements are done. When all measurements are done, the R&S Spectrum Rider returns to the EMF dialog box. From there you can save the measurement results, review them or exit the EMF application. If you try to exit the application without saving the results first, the R&S Spectrum Rider asks you if you want to dismiss the results.

13.2.4 Contents of the result displays

The EMF application has three main result display types.

- The graphical result display.
- A numerical result display that summarizes the results of a measurement set.
- A numerical result display that summarizes the results of a measurement.

Note that the R&S Spectrum Rider always displays corrected results if any correction values have been defined for the measurement, for example an extrapolation factor or instrument uncertainty. See [Chapter 13.1.1, "Configuring measurements"](#), on page 296.

13.2.5 Graphical results

The contents of the graphical result display depend on the measurement mode.

- For the spectrum measurement, the R&S Spectrum Rider shows an overview of the spectrum around the center frequencies you have defined.
The spectrum measurement EMF results are based on the level measured at the center frequency.
- For the channel power measurement, the R&S Spectrum Rider shows an overview of the channel spectrum. The EMF results are based on the channel power level.

All result displays look like their counterparts in the corresponding applications. However, in the EMF measurement application, they contain some additional information.

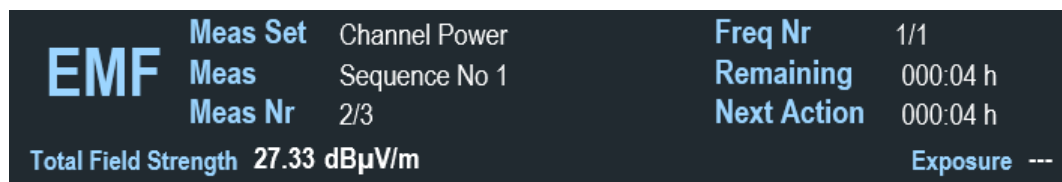

Figure 13-6: EMF measurement information

EMF measurement information	EMF results
<ul style="list-style-type: none"> • "Meas Set": Mode of the currently running measurement. • "Meas": Name of the measurement sequence you are using. • "Meas Nr": Measurement progress (current / total), e.g. "2/3" means two out of the three measurements are completed. • "Freq Nr": Sub-measurement progress (current / total), e.g. "1/1" means the only sub-measurement is completed. • "Remaining": Time remaining until complete measurement sequence is done. • "Next Action": Time remaining until a manual input is required for the next action. If "Auto" is selected for next action in the measurement set configuration, the time remaining indicates the total remaining time for un-complete measurement sequences. 	<ul style="list-style-type: none"> • The "Total Field Strength" is the sum of the field strengths measured during all sub-measurements and measurements according to: $\text{FieldStrength}_{\text{meas}} = \sqrt{(\sum_{i=1}^n \text{FieldStrength}_i^2)}$ $n = \text{number of sub-measurements}$ $\text{FieldStrength}_i = \text{Field strength of a sub-measurement}$ • $\text{FieldStrength}_{\text{total}} = \sqrt{(\sum_{i=1}^n \text{FieldStrength}_i^2)}$ $n = \text{number of sub-measurements}$ $\text{FieldStrength}_i = \text{Field strength of a measurement}$ • The "Exposure" ratio is only displayed if you are using a limit line during the measurement.

13.2.6 Numeric results

The EMF application features two numeric result summaries.

- A numerical result display that summarizes the results of a measurement set.

Measurements	Field Strength (RMS)	Exposure 1	Exposure 2
Total	21.29 dBµV/m	---	---
Spectrum	17.98 dBµV/m	---	---
Channel Power	18.56 dBµV/m	---	---
Quick Scan	---	---	---

Meas Set: Quick Scan
 Meas: Sequence No 1
 Meas Nr: 3/3
 Freq Nr: 1/13
 Remaining: 000:00 h
 Next Action: 000:00 h

Result Mode Unit Meas Sub Results Back

Figure 13-7: EMF result of a measurement set

The table header shows the same information as the graphical results. In the numeric measurement display, each row corresponds to a measurement. The columns show the following information:

- "Measurements": Name of the measurement
- "Total": Total field strength over all measurements and the corresponding exposure ratios over all measurements.
- "Field Strength (RMS)": Result mode "RMS" is selected for the total field strength that has been calculated for that measurement
- "Exposure 1", "Exposure 2": Exposure ratio against limit lines 1 and 2 (only displayed if you are using limits). The exposure ratio of a measurement is calculated as follows.

$$ER_{\text{meas}} = \sqrt{(\sum_{i=1}^n ER_i^2)} * [\text{unit}]$$

n = number of sub-measurements

ER = exposure ratio of sub-measurement i

For calculation of ER_i , see [Figure 13-8](#).

- A numerical result display that summarizes the results of a measurement.

Figure 13-8: EMF result of a sub-measurements

The table header shows the same information as the graphical results. In the table, each row corresponds to a measurement. The columns show the following information:

- "Frequency": Frequency of the sub-measurement.
- "Sub Total": Total field strength over all sub-measurements and the corresponding exposure ratios over all sub-measurements.
- "Field Strength": Result mode "RMS" is selected for the Field strength that has been measured for that sub-measurement.
- "Exposure 1", "Exposure 2": Exposure ratio against limit lines 1 and 2 (only displayed if you are using limits). The exposure ratio of a sub-measurement is the ratio between field strength and limit:

$$ER_{\text{Freq}} = (\text{FieldStrength}/\text{Limit}) * [100]$$

13.3 Evaluating results

The R&S InstrumentView software provides functionality to review results and compile measurement reports of EMF measurements. However, before you can start to evaluate the results you have to download the results to your computer.

1. Start the R&S InstrumentView software.
2. If necessary, copy the files (.emrf) you need to the computer via the file transfer workspace. See ["Uploading the measurement set"](#) on page 301.
3. Select the "Analysis" > "EMF Analysis" for the EMF analysis function.
4. Use the "Open" button to select the measurement results you want to analyze.

5. Copy the files you want to review.

Now that the results are available, you can review and evaluate the results. The EMF analysis provides the following features.

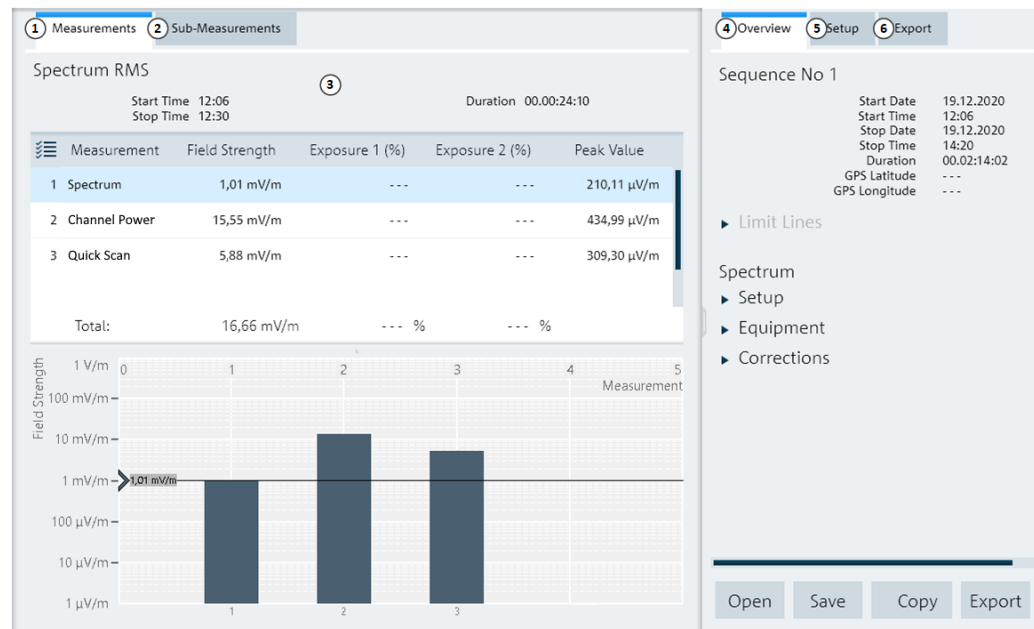

Figure 13-9: EMF measurement results

- 1 = Display of measurement results
- 2 = Display of sub-measurement results
- 3 = Display display area
- 4 = Overview of the corresponding measurement settings
- 5 = Review tools
- 6 = Report generator

Measurement results

Measurement results are presented as a numerical result table and a diagram.

The diagram shows one bar for each measurement that is part of the measurement set. Each bar represents the total field strength of the corresponding measurement. The black horizontal line indicates the field strength of the selected measurement.

The numerical result summary on measurement level in the EMF analysis tool is basically the same as that displayed on the R&S Spectrum Rider. However, it contains an additional column, the peak value. The peak value is simply the highest value measured over all sub-measurements. For a detailed description, see [Chapter 13.2.4, "Contents of the result displays"](#), on page 306.

Sub-measurement results

Measurement results are presented as a numerical result table and a diagram.

The diagram shows one bar for each sub-measurement that is part of the measurement. Each bar represents the total field strength of the corresponding measurement. The black horizontal line indicates the field strength of the selected sub-measurement.

The numerical result summary on sub-measurement level in the EMF analysis tool is basically the same as that displayed on the R&S Spectrum Rider. However, it contains an additional column, the number of cycles. The number of cycles is simply the number of data captures that have been done for the corresponding sub-measurement. For a detailed description, see [Chapter 13.2.4, "Contents of the result displays"](#), on page 306.

Overview

The "Overview" tab contains miscellaneous facts about the measurement. This includes date and time information, limit check results, measurement configuration etc.



Correcting measurement results and checking them against limits

You can define correction values like antenna anisotropy, extrapolation or instrument uncertainty during result evaluation. This can be useful, for example, if you have to consider different scenarios.

When you do so, the correction values are applied to the uncorrected measurement data. If you have already defined correction values for the individual measurements during measurement preparation, these are overwritten.

For more information, see [Chapter 13.1.1, "Configuring measurements"](#), on page 296.

You can also check the results against different limit lines to consider different scenarios.

Setup

The "Setup" tab contains tools for further analysis of the results. This includes different evaluation methods, unit selection, limit checks etc.

Export

The "Export" tab contains functionality to generate and layout a measurement report.

- Select the information to include in the report.
- Select the report format you would like.
- Create the report with the "Export" button.

Exporting measurement results

In addition to creating a measurement report, you can export the measurement data and evaluate it with an external software, for example a spreadsheet.

- Select the "Copy" button.
The R&S InstrumentView copies all information shown in the evaluation tool (results, configuration etc.) to the clipboard. The copied data has the csv format.
- Open the software of your choice.
- Paste the contents of the clipboard into the software and evaluate as you like.

14 Remote commands

The commands required to perform measurements in the Spectrum application in a remote environment are described here.

- [Interfaces and protocols](#)..... 311
- [Setting up the remote control connection](#).....314
- [Instrument model and command processing](#)..... 315
- [SCPI command structure and syntax](#).....318
- [Command sequence and command synchronization](#)..... 327
- [Remote control - commands](#)..... 327

14.1 Interfaces and protocols

The R&S Spectrum Rider supports two different interfaces for remote control.

- [LAN interface](#): The protocol is based on TCP/IP and supports the VXI-11 standard
- [USB interface](#)

The connectors are located at the side of the instrument and permit a connection to a controller for remote control via a local area network (LAN) or directly via USB.

SCPI

SCPI (Standard Commands for Programmable Instruments) commands - messages - are used for remote control. Commands that are not taken from the SCPI standard follow the SCPI syntax rules. The instrument supports the SCPI version 1999. The SCPI standard is based on standard IEEE 488.2 and aims at the standardization of device-specific commands, error handling and the status registers. The tutorial "Automatic Measurement Control - A tutorial on SCPI and IEEE 488.2" from John M. Pieper (order number 0002.3536.00) offers detailed information on concepts and definitions of SCPI.

The requirements that the SCPI standard places on command syntax, error handling and configuration of the status registers are explained in detail in the following sections. Tables provide a fast overview of the bit assignment in the status registers. The tables are supplemented by a comprehensive description of the status registers.

VISA

VISA is a standardized software interface library providing input and output functions to communicate with instruments. The I/O channel (LAN or USB) is selected at initialization time by means of a channel-specific resource string. For more information about VISA refer to its user documentation.

The programming examples for remote control, are all written in Microsoft® VISUAL BASIC®. Access to the VISA functions require the declaration of the functions and constants before their use in the project. This can be accomplished either by adding the modules VISA32.BAS and VPPTYPE.BAS or a reference to the VISA32.DLL to the project.

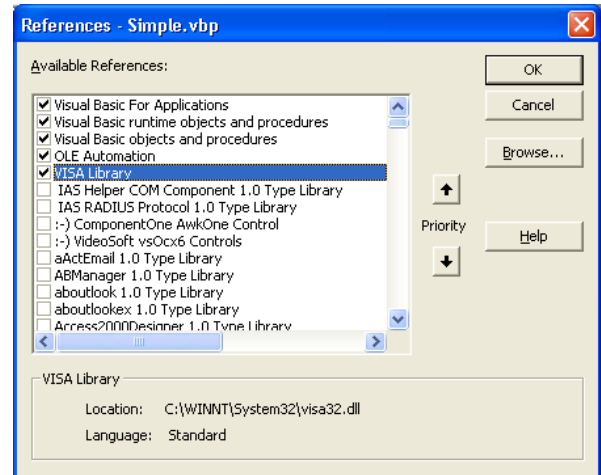
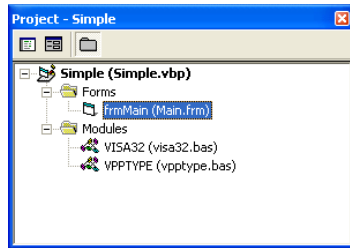

The modules VISA32.BAS and VPPTYPE.BAS can be found in the following location:
<VXIppnPath>WinNT\Include (typically C:\VXIppn\WinNt\Include).



Resetting the R&S Spectrum Rider

Manual operation is designed for maximum possible operating convenience. In contrast, the priority of remote control is the "predictability" of the device status. Therefore, control programs should always define an initial device status (e.g. with the command *RST) and then implement the required settings.

14.1.1 LAN interface

To be integrated in a LAN, the instrument is equipped with a standard LAN interface, consisting of a connector, a network interface and protocols (VXI-11).

Instrument access via VXI-11 is usually achieved from high level programming platforms by using VISA as an intermediate abstraction layer. VISA encapsulates the low level VXI-11 (LAN) or USB function calls and thus makes the transport interface transparent for the user. The necessary VISA library is available as a separate product. For details, contact your local R&S sales representative.

14.1.2 USB interface

For remote control via the USB connection, the PC and the instrument must be connected via the USB interface. The required driver comes with the R&S InstrumentView software package and is automatically installed on the PC with the software package.

The driver addressed the instrument via the USB interface with the fix IP address 172.16.10.10.

In addition, a remote control connection via the SCPI interface requires the VISA library to be installed on the PC.

14.1.3 Protocols

VXI-11 Basics

The VXI-11 standard is based on the ONC-RPC protocol which in turn relies on TCP/IP as the network/transport layer. The TCP/IP network protocol and the associated network services are preconfigured. TCP/IP ensures connection-oriented communication, where the order of the exchanged messages is adhered to and interrupted links are identified. With this protocol, messages cannot be lost.

Remote control of an instrument via a network is based on standardized protocols which follow the OSI reference model (see Fig. below).

Application	SCPI
Presentation	XDR (VXI-11)
Session	ONC-RPC
Transport	TCP / UDP
Network	IP
Data Link	Ethernet/802.3
Physical	802.3/10BASE-T

Figure 14-1: Example for LAN remote control based on the OSI reference model

Based on TCP/UDP, messages between the controller and the instrument are exchanged via open network computing (ONC) - remote procedure calls (RPC). With XDR (VXI-11), legal RPC messages are known as VXI-11 standard. Based on this standard, messages are exchanged between the controller and the instrument. The messages are identical with SCPI commands. They can be organized in four groups:

- Program messages (control command to the instrument).
- Response messages (values returned by the instrument).
- Service request (spontaneous queries of the instrument).
- Low-level control messages (interface messages).

A VXI-11 link between a controller and an instrument uses three channels: core, abort and interrupt channel. Instrument control is mainly performed on the core channel (program, response and low-level control messages). The abort channel is used for immediate abort of the core channel; the interrupt channel transmits spontaneous service requests of the instrument. Link setup itself is very complex. For more details, refer to the VXI-11 specification.

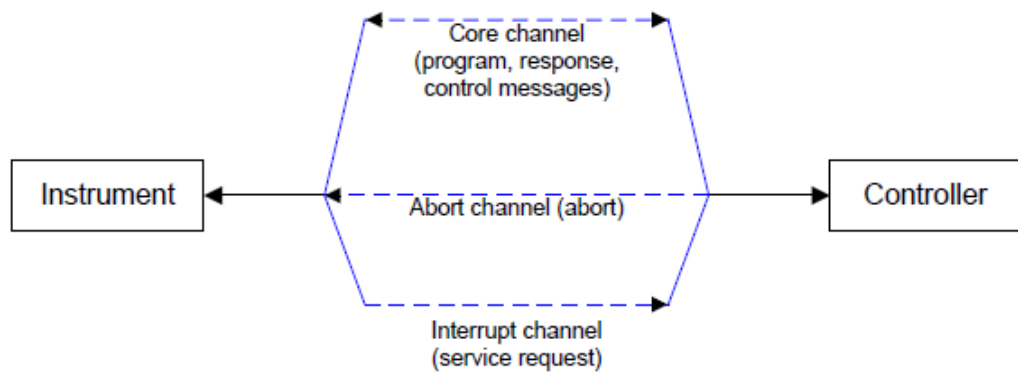

Figure 14-2: VXI-11 channels between instrument and controller

The number of controllers that can address an instrument is practically unlimited in the network. In the instrument, the individual controllers are clearly distinguished. This distinction continues up to the application level in the controller, i.e. two applications on a computer are identified by the instrument as two different controllers.

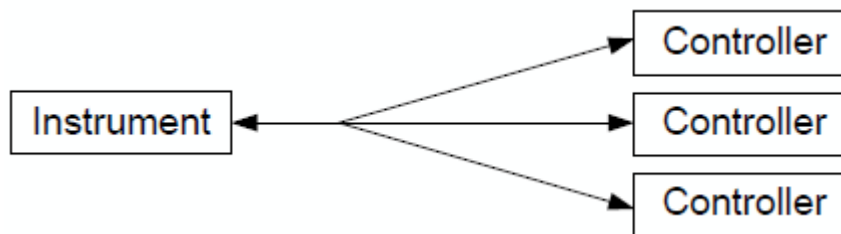

Figure 14-3: Remote control via LAN from several controllers

The controllers can lock and unlock the instrument for exclusive access. This regulates access to the instrument of several controllers.

14.2 Setting up the remote control connection

14.2.1 Preparing for remote control

The short and simple operating sequence below shows how to put the instrument into operation and quickly set its basic functions. The current IP address for LAN operation is shown in the SETUP – Instrument Setup Menu. In case of USB connection, the IP address is fixed to 172.16.10.10.

Refer [Chapter 3.2.11, "Connecting the R&S Spectrum Rider to a PC"](#), on page 69 for instructions on how to change the IP address.

- Connect the instrument to the LAN or directly to the controller via USB.
- Switch on the instruments.
- Write and start the following program on the controller:

```

- status = viOpenDefaultRM(defaultRM)
  'open default resource manager
- status = viOpen(DefaultRM, "TCPIP::172.16.10.10", 0, 0,
  vi)
  'in case of USB connection
- status = viopen(DefaultRM, "TCPIP::xxx.xxx.xxx.xxx", 0, 0,
  vi)
  'in case of a LAN connection, with xxx.xxx.xxx.xxx = IP address
- cmd = "*RST;*CLS"
- status = viWrite(vi, Cmd, Len(Cmd), retCount)
  'reset instrument and clear status registers
- cmd = "FREQ:CEN 100MHz"
- status = viWrite(vi, Cmd, Len(Cmd), retCount)
  'set center frequency to 100 MHz
- cmd = "FREQ:SPAN 10MHz"
- status = viWrite(vi, Cmd, Len(Cmd), retCount)
  'set span to 10 MHz
- cmd = "DISP:TRAC:Y:RLEV -10dBm"
- status = viWrite(vi, Cmd, Len(Cmd), retCount)
  'set reference level to -10 dBm
- viclose vi
- viclose default RM

```

The instrument now performs a sweep in the frequency range of 95 MHz to 105 MHz.

Changing the IP address

In order to operate the instrument via remote control, it must be accessed via LAN (IP address) or USB (fixed IP address). If the factory-set remote control address does not fit in the network environment, it can be changed.

Refer [Chapter 3.2.11, "Connecting the R&S Spectrum Rider to a PC"](#), on page 69 for instructions on how to change the IP address.

14.3 Instrument model and command processing

The block diagram in [Figure 14-4](#) shows how SCPI commands are serviced in the instrument. The individual components work independently and simultaneously. They communicate with each other by means of so-called "messages".

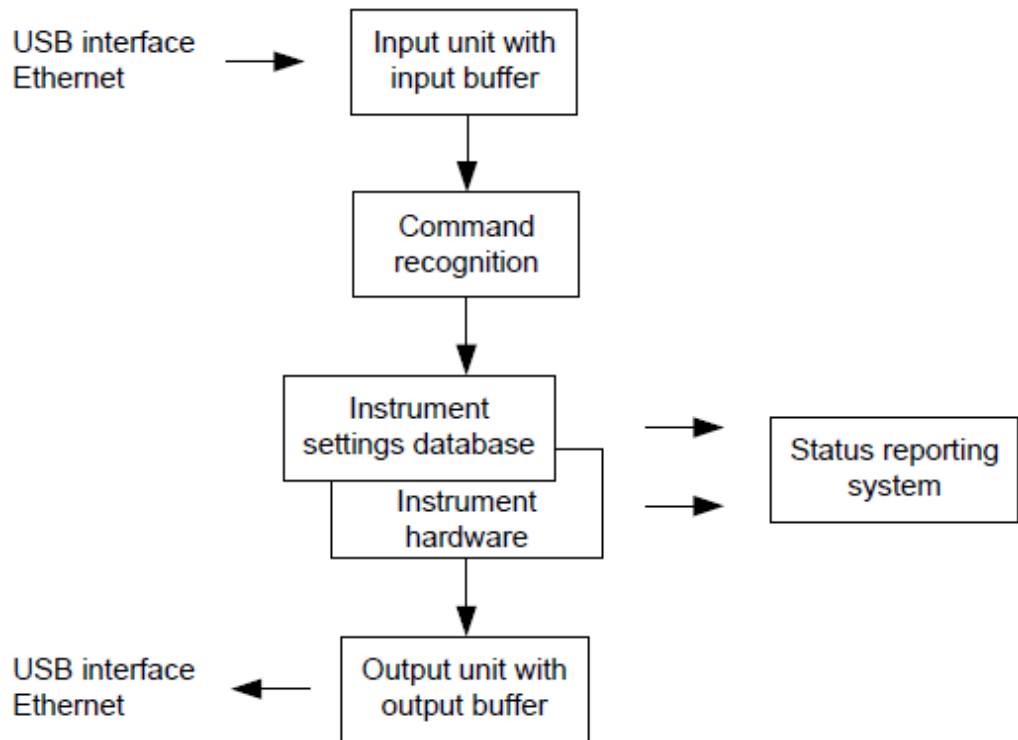

Figure 14-4: Instrument model in the case of remote control

• Input unit	316
• Command recognition	316
• Data base and instrument hardware	317
• Status reporting system	317
• Output unit	317

14.3.1 Input unit

The input unit receives commands character by character from the controller and collects them in the input buffer. The input unit sends a message to the command recognition as soon as the input buffer is full or as soon as it receives a delimiter, <PROGRAM MESSAGE TERMINATOR>, as defined in IEEE 488.2, or the interface message DCL.

If the input buffer is full, the traffic is stopped and the data received up to then are processed. Subsequently the traffic is continued. If, however, the buffer is not yet full when receiving the delimiter, the input unit can already receive the next command during command recognition and execution. The receipt of DCL clears the input buffer and immediately resets the command recognition.

14.3.2 Command recognition

The command recognition analyses the data received from the input unit. It proceeds in the order in which it receives the data. Only DCL is serviced with priority, for exam-

ple GET (Group Execute Trigger) is only executed after the commands received before. Each recognized command is immediately transferred to the internal instrument settings data base but not executed immediately.

The command recognition detects syntax errors in the commands and transfers them to the status reporting system. The rest of a program message after a syntax error is analyzed further if possible and serviced. After the syntax test, the value range of the parameter is checked, if necessary.

If the command recognition detects a delimiter, it passes the command to an execution unit that performs the instrument settings. In the meantime, the command recognition is ready to process new commands (overlapping execution). A DCL command is processed in the same way.

14.3.3 Data base and instrument hardware

Here the expression "instrument hardware" denotes the part of the instrument fulfilling the actual instrument function - signal generation, measurement etc. The controller is not included. The term "data base" denotes a database that manages all the parameters and associated settings required for setting the instrument hardware.

Setting commands lead to an alteration in the data set. The data set management enters the new values (e.g. frequency) into the data set, however, only passes them on to the hardware when requested by the command recognition. This only takes place at the end of a program message.

The data are checked for compatibility with the current instrument settings before they are transmitted to the instrument hardware. If the execution is not possible, an "execution error" is signaled to the status reporting system. The corresponding settings are discarded.

Before passing on the data to the hardware, the settling bit in the STATUS:OPERation register is set (refer to section "[STATUS:OPERation register](#)" on page 468). The hardware executes the settings and resets the bit again as soon as the new state has settled. This fact can be used to synchronize command servicing.

Queries induce the data set management to send the desired data to the output unit.

14.3.4 Status reporting system

For detailed information, refer to [Status reporting system](#).

14.3.5 Output unit

The output unit collects the information requested by the controller, which it receives from the data base management. The output unit processes the information according to the SCPI rules and makes it available in the output buffer.

If the instrument is addressed as a talker without the output buffer containing data or awaiting data from the data base management, the output unit sends error message

"Query UNTERMINATED" to the status reporting system. No data are sent to the controller, the controller waits until it has reached its time limit. This behavior is defined by IEEE 488.2 and SCPI.

14.4 SCPI command structure and syntax

SCPI describes a standard command set for programming instruments, irrespective of the type of instrument or manufacturer. The goal of the SCPI consortium is to standardize the device-specific commands to a large extent. For this purpose, a model was developed which defines the same functions inside a device or for different devices. Command systems were generated which are assigned to these functions. Thus it is possible to address the same functions with identical commands. The command systems are of a hierarchical structure.

SCPI is based on standard IEEE 488.2, i.e. it uses the same syntactic basic elements as well as the common commands defined in this standard. Part of the syntax of the device responses is defined with greater restrictions than in standard IEEE 488.2 (see [Chapter 14.4.4, "Responses to queries"](#), on page 326).



Remote command examples

Not all commands used in the following examples are implemented in the instrument.

- [Structure of a command](#).....318
- [Parameters](#).....323
- [Structure of a program message](#).....325
- [Responses to queries](#)..... 326

14.4.1 Structure of a command

The commands consist of a so-called header and, in most cases, one or more parameters. Header and parameter are separated by a "white space" (ASCII code 0 to 9, 11 to 32 decimal, e.g. blank). The headers may consist of several key words. Queries are formed by directly appending a question mark to the header.

- [Common commands](#).....318
- [Device-Specific commands](#).....319
- [Overview of syntax elements](#)..... 322

14.4.1.1 Common commands

Common commands consist of a header preceded by an asterisk "*" and one or several parameters, if any.

Table 14-1: Examples

Command	Operation	Description
*RST	RESET	Resets the device.
*ESE 253	EVENT STATUS ENABLE	Sets the bits of the EVENT STATUS ENABLE register.
*ESR?	EVENT STATUS QUERY	Queries the contents of the EVENT STATUS register.

14.4.1.2 Device-Specific commands

- Hierarchy.....319
- Multiple keywords.....320
- Optional keywords.....320
- Long and short form.....320
- Parameter.....321
- Special characters.....321
- Numeric suffix.....322

Hierarchy

Device-specific commands are of hierarchical structure. The different levels are represented by combined headers. Headers of the highest level (root level) have only one key word. This key word denotes a complete command system.

Example:

SENSE

This key word denotes the SENSE command system.

For commands of lower levels, the complete path has to be specified, starting on the left with the highest level, the individual key words being separated by a colon ":".

Example:

SENSE:FREQUENCY:SPAN 10MHZ

This command lies in the third level of the SENSE system. It sets the frequency span.

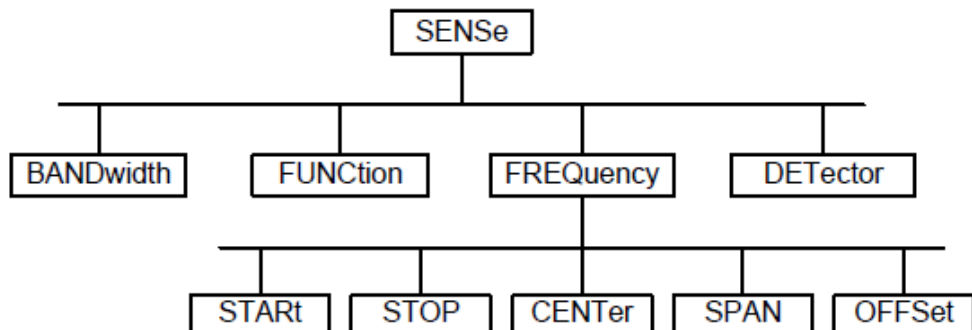

Figure 14-5: Tree structure the SCPI command systems using the SENSE system as example

Multiple keywords

Some key words occur in several levels within one command system. Their effect depends on the structure of the command, i.e. at which position in the header of a command they are inserted.

Example:

```
SOURce:FM:POLarity NORMal
```

This command contains key word `POLarity` in the third command level. It defines the polarity between modulator and modulation signal.

Example:

```
SOURce:FM:EXTernal:POLarity NORMal
```

This command contains key word `POLarity` in the fourth command level. It defines the polarity between modulation voltage and the resulting direction of the modulation only for the external signal source indicated.

Optional keywords

Some command systems permit certain key words to be inserted into the header or omitted. These key words are marked by square brackets in the description. The full command length must be recognized by the instrument for reasons of compatibility with the SCPI standard. Some commands are considerably shortened by these optional key words.

Example:

```
[SENSe]:BANDwidth[:RESolution]:AUTO
```

This command couples the resolution bandwidth of the instrument to other parameters. The following command has the same effect:

```
BANDwidth:AUTO
```



Optional keywords with numeric suffixes

Do not omit an optional keyword if it includes a numeric suffix that is relevant for the effect of the command.

Example:

```
DISPlay[:WINDow<1..4>]:MAXimize <Boolean>
```

Command `DISP:MAX ON` refers to window 1.

In order to refer to a window other than 1, you must include the optional `WINDow` parameter with the suffix for the required window.

```
DISP:WIND2:MAX ON
```

refers to window 2.

Long and short form

The key words feature a long form and a short form. Either the short form or the long form can be entered, other abbreviations are not permitted.

Example:

```
STATus:QUEStionable:ENABle 1
```

is equivalent to

```
STAT:QUES:ENAB 1
```

**Upper and lower case notation of commands**

Upper-case and lower-case notation only serves to distinguish the two forms in the manual, the instrument itself does not distinguish upper-case and lower-case letters.

Parameter

The parameter must be separated from the header by a "white space". If several parameters are specified in a command, they are separated by a comma ",". A few queries permit the parameters MINimum, MAXimum and DEFault to be entered. Refer to [Chapter 14.4.2, "Parameters"](#), on page 323 for a detailed description of the various parameters.

Example:

```
SENSe:FREQUency:STOP? MAXimum
```

Response: 3.5E9

This query requests the maximal value for the stop frequency.

Special characters

- **Vertical stroke |**

A vertical stroke in parameter definitions indicates alternative possibilities in the sense of "or". The effect of the command differs, depending on which parameter is used.

Example

```
– DISPLAY:FORMat SINGLE | SPLit
```

If parameter `SINGLE` is selected, full screen is displayed, in the case of `SPLIT`, split screen is displayed.

A selection of key words with an identical effect exists for several commands.

These keywords are indicated in the same line; they are separated by a vertical stroke. Only one of these keywords needs to be included in the header of the command. The effect of the command is independent of which of the keywords is used.

```
– SENSe:BANDwidth|BWIDth[:RESolution]
```

The two following commands with identical meaning can be created. They set the frequency of the fixed frequency signal to 1 kHz:

```
SENSe:BAND 1
```

```
SENSe:BWID 1
```

- **Square brackets []**

Key words in square brackets can be omitted when composing the header. The full command length must be accepted by the instrument for reasons of compatibility with the SCPI standards.

Example

- [SENSe:]BANDwidth|BWIDTH[:RESolution] or SENS:BAND:RES
is equivalent to

BAND

Parameters in square brackets can be incorporated optionally in the command or omitted as well

- MMEMoRY:NETWoRK:MAP<string>,<string>[,<string>,<string>,<boolean>]

Entries in square brackets are optional or can be omitted.

- **Braces { }**

Parameters in curly brackets are optional and can be inserted once or several times, or omitted.

Example

- SENSE:LIST:FREQuency <numeric_value>{,<numeric_value>}

The following are valid commands:

SENS:LIST:FREQ 10

SENS:LIST:FREQ 10,20

SENS:LIST:FREQ 10,20,30,40

Numeric suffix

If a device features several functions or features of the same kind, e.g. inputs, the desired function can be selected by a suffix added to the command. Entries without suffix are interpreted like entries with the suffix 1. Optional keywords must be specified if they select a function with the suffix.

Example:

SYSTem:COMMunicate:SERial2:BAUD 9600

This command sets the baud rate of a second serial interface.

**Suffix counting**

In case of remote control, suffix counting may differ from the numbers of the corresponding selection used in manual operation. SCPI prescribes that suffix counting starts with 1. Suffix 1 is the default state and used when no specific suffix is specified.

Some standards define a fixed numbering, starting with 0. With GSM, for instance, slots are counted from 0 to 7. In the case of remote control, the slots are selected with the suffixes 1 to 8. If the numbering differs in manual operation and remote control, it is indicated with the respective command.

14.4.1.3 Overview of syntax elements

The following table offers an overview of the syntax elements.

Syntax element	Description
:	The colon separates the key words of a command. In a program message, the separating semicolon marks the uppermost command level.
;	The semicolon separates two commands within a program message. It does not alter the path.
,	The comma separates several parameters of a command.
?	The question mark forms a query.
*	The asterisk marks a common command.
"	Quotation marks introduce a string and terminate it.
#	The hash symbol # introduces binary, octal, hexadecimal and block data. <ul style="list-style-type: none"> • Binary: #B10110 • Octal: #O7612 • Hex: #HF3A7
" "	A "white space" (ASCII-Code 0 to 9, 11 to 32 decimal, e.g. blank) separates header and parameter.

14.4.2 Parameters

For most commands, a parameter needs to be supplemented. The parameter has to be separated from the header by a "white space".

The type of parameter required for each command and the allowed range of values are specified in the command description.

- [Numeric values](#)..... 323
- [Special numeric values](#)..... 324
- [Boolean parameters](#)..... 324
- [Text](#)..... 324
- [Strings](#)..... 325
- [Block data](#)..... 325

14.4.2.1 Numeric values

Numeric values can be entered in any form, i.e. with sign, decimal point and exponent. Values exceeding the resolution of the instrument are rounded up or down. The mantissa may comprise up to 255 characters, the exponent must lie inside the value range -32000 to 32000. The exponent is introduced by an "E" or "e". Entry of the exponent alone is not permissible. In the case of physical quantities, the unit can be entered. Permissible unit prefixes are G (giga), MA (mega), MOHM and MHZ are also possible), K (kilo), M (milli), U (micro) and N (nano). If the unit is missing, the basic unit is used.

Example:

```
SENSe:FREQuency:STOP 1.5GHz = SENSe:FREQuency:STOP 1.5E9
```

14.4.2.2 Special numeric values

The texts MINimum, MAXimum, DEFault, UP and DOWN are interpreted as special numeric values. In case of a query, the numeric value is returned.

- MIN/MAX
MINimum and MAXimum denote the minimum and maximum value.
- DEF
DEFault denotes a preset value which has been stored in the EPROM. This value conforms to the default setting, as it is called by the *RST command
- UP/DOWN
UP, DOWN increases or reduces the numerical value by one step. The step width can be specified via an allocated step command for each parameter which can be set via UP, DOWN.
- INF/NINF
INFinity, Negative INFinity (NINF) Negative INFinity (NINF) represent the numerical values $-9.9E37$ or $9.9E37$, respectively. INF and NINF are only sent as device response.
- NAN
Not A Number (NAN) represents the value $9.91E37$. NAN is only sent as device response. This value is not defined. Possible causes are the division of zero by zero, the subtraction of infinite from infinite and the representation of missing values.

Example:

Setting command: `SENSe:FREQuency:STOP MAXimum`

Query: `SENSe:FREQuency:STOP?`

Response: `3.5E9`

14.4.2.3 Boolean parameters

Boolean parameters represent two states. The ON state (logically true) is represented by ON or a numerical value unequal to 0. The OFF state (logically untrue) is represented by OFF or the numerical value 0. The numerical values are provided as response for query.

Example:

Setting command: `CALCulate:MARKer:STATe ON`

Query: `CALCulate:MARKer:STATe?`

Response: `1`

14.4.2.4 Text

Text parameters observe the syntactic rules for key words, i.e. they can be entered using a short or long form. Like any parameter, they have to be separated from the header by a white space. In the case of a query, the short form of the text is provided.

Example:

Setting command: `INPut:COUPling GROund`

Query: `INPut:COUPling?`

Response: `GRO`

14.4.2.5 Strings

Strings must always be entered in quotation marks (' or ").

Example:

`SYSTem:LANGUage "SCPI" or SYSTem:LANGUage 'SCPI'`

14.4.2.6 Block data

Block data are a transmission format which is suitable for the transmission of large amounts of data. A command using a block data parameter has the following structure:

Example:

`HEADer:HEADer #45168xxxxxxxx`

ASCII character # introduces the data block. The next number indicates how many of the following digits describe the length of the data block. In the example, the four following digits indicate the length to be 5168 bytes. The data bytes follow. During the transmission of these data bytes all end or other control signs are ignored until all bytes are transmitted.

14.4.3 Structure of a program message

A program message may consist of one or several commands. It is terminated by the program message terminator which is the NL (New Line) character for LAN and USB connections.

Several commands in a program message must be separated by a semicolon ";". If the next command belongs to a different command system, the semicolon is followed by a colon. A colon ":" at the beginning of a command marks the root node of the command tree.

Example:

`CALL InstrWrite(analyzer, "SENSe:FREQUency:CENTer 100MHz;:INPut:ATTenuation 10")`

This program message contains two commands. The first one is part of the `SENSe` command system and is used to determine the center frequency of the instrument. The second one is part of the `INPut` command system and sets the input signal attenuation.

If the successive commands belong to the same system, having one or several levels in common, the program message can be abbreviated. For that purpose, the second command after the semicolon starts with the level that lies below the common levels. The colon following the semicolon must be omitted in this case.

Example:

```
CALL InstrWrite(analyzer, "SENSe:FREQuency:START 1E6;:SENSe:
FREQuency:STOP 1E9")
```

This program message is represented in its full length and contains two commands separated from each other by the semicolon. Both commands are part of the SENSe command system, subsystem FREQuency, i.e. they have two common levels.

When abbreviating the program message, the second command begins with the level below SENSe:FREQuency. The colon after the semicolon is omitted. The abbreviated form of the program message reads as follows:

```
CALL InstrWrite(analyzer, "SENSe:FREQuency:START 1E6;STOP 1E9")
```

However, a new program message always begins with the complete path.

Example:

```
CALL InstrWrite(analyzer, "SENSe:FREQuency:START 1E6")
```

```
CALL InstrWrite(analyzer, "SENSe:FREQuency:STOP 1E9")
```

14.4.4 Responses to queries

A query is defined for each setting command unless explicitly specified otherwise. It is formed by adding a question mark to the associated setting command. According to SCPI, the responses to queries are partly subject to stricter rules than in standard IEEE 488.2.

- The requested parameter is transmitted without header.

Example

```
INPut:COUPling?
```

Response: DC

- Maximum values, minimum values and all further quantities, which are requested via a special text parameter are returned as numerical values.

Example

```
SENSe:FREQuency:STOP? MAX
```

Response: 3.5E9

- Numerical values are output without a unit. Physical quantities are referred to the basic units or to the units set using the Unit command.

Example

```
SENSe:FREQuency:CENTer?
```

Response: 1E6 (for 1 MHz)

- Truth values <Boolean values> are returned as 0 (for OFF) and 1 (for ON).

Example

```
SENSe:BANDwidth:AUTO?
```

Response: 1 (for ON)

- Text (character data) is returned in a short form.

Example

```
SYSTem:COMMunicate:SERial:CONTRol:RTS?
```

Response: STAN (for standard)

14.5 Command sequence and command synchronization

What has been said above makes clear that all commands can potentially be carried out overlapping. In order to prevent an overlapping execution of commands, one of the commands `*OPC`, `*OPC?` or `*WAI` must be used. All three commands cause a certain action only to be carried out after the hardware has been set. By suitable programming, the controller can be forced to wait for the respective action to occur.

For more information, see [Table 14-2](#)

Table 14-2: Synchronization using `*OPC`, `*OPC?` and `*WAI`

Command	Action	Programming the controller
<code>*OPC</code>	Sets the Operation Complete bit in the ESR after all previous commands have been executed.	<ul style="list-style-type: none"> Setting bit 0 in the ESE Setting bit 5 in the SRE Waiting for service request (SRQ)
<code>*OPC?</code>	Stops command processing until 1 is returned. This is only the case after the Operation Complete bit has been set in the ESR. This bit indicates that the previous setting has been completed.	Sending <code>*OPC?</code> directly after the command whose processing should be terminated before other commands can be executed.
<code>*WAI</code>	Stops further command processing until all commands sent before <code>*WAI</code> have been executed.	Sending <code>*WAI</code> directly after the command whose processing should be terminated before other commands are executed.

For a couple of commands, the synchronization to the end of command execution is mandatory in order to obtain the desired result. The affected commands require either more than one measurement in order to accomplish the desired instrument setting (e.g. auto range functions), or they require a longer period of time for execution. If a new command is received during execution of the corresponding function, this may either lead to either to an aborted measurement or to incorrect measurement data.

The following list includes the commands, for which a synchronization via `*OPC`, `*OPC?` or `*WAI` is mandatory:

Table 14-3: Commands with mandatory synchronization (overlapping commands)

Command	Purpose
<code>INIT</code>	Start measurement (sweep)
<code>INIT:CONT OFF</code>	Set to single sweep
<code>CALC:MARK:FUNC:xx?</code>	All Marker function queries

14.6 Remote control - commands

The following chapters provide a detailed description of all the remote control commands currently available for the R&S Spectrum Rider and its firmware options.

Each section describes the commands for one of the operating modes available in the R&S Spectrum Rider, beginning with the description of common commands required to operate the instrument.

- [Chapter 14.6.1, "Common commands"](#), on page 329
- [Chapter 14.6.2, "Remote commands of the spectrum analyzer"](#), on page 332
- [Chapter 14.6.3, "Remote commands of the analog modulation"](#), on page 405
- [Chapter 14.6.4, "Remote commands of the digital modulation"](#), on page 414
- [Chapter 14.6.5, "Remote commands of the power meter"](#), on page 422
- [Chapter 14.6.6, "Remote commands of the receiver mode"](#), on page 429

Each section is subdivided into various tasks required to perform measurements with the R&S Spectrum Rider, also based on the structure of the R&S Spectrum Rider user manual. Some commands like those for controlling markers or configuring the frequency axis are available for all operating modes. In that case, you can find a list of these commands in the corresponding section.



Availability of commands

The spectrum mode is implemented in the basic unit. For the other modes, the corresponding options are required.

Following the remote control commands required to perform specific measurements, you can find a description of general commands used to set up and control basic instrument functions. These commands are independent of the operating mode. Therefore they are listed separately.

- [Chapter 14.6.7, "File management"](#), on page 435
- [Chapter 14.6.8, "Making and storing screenshots"](#), on page 442
- [Chapter 14.6.9, "Configuring data capture"](#), on page 443
- [Chapter 14.6.10, "Saving events"](#), on page 445
- [Chapter 14.6.11, "Configuring the instrument"](#), on page 447
- [Chapter 14.6.12, "Status reporting system"](#), on page 463

All chapters begin with a list of commands available in the context of that chapter. Following that list, you can find a detailed description of all the commands.

All individual descriptions contain:

- Complete notation and syntax of the command
- Description of the effects of the command
- A list of all parameters available for that command or the type of data the command returns in case of query commands
- An example of how a program message would look like
- The *RST value

An alphabetical list of all available commands is provided at the end of this manual.

14.6.1 Common commands

The common commands are taken from the IEEE 488.2 (IEC 625-2) standard. A particular command has the same effect on different devices. The headers of these commands consist of an asterisk "*" followed by three letters. Some of the common commands refer to the [Chapter 14.6.12, "Status reporting system"](#), on page 463.

List of common commands

*CLS.....	329
*ESE.....	329
*ESR?.....	329
*IDN?.....	330
*IST?.....	330
*OPC.....	330
*OPT?.....	330
*RST.....	331
*SRE.....	331
*STB?.....	331
*TRG.....	331
*TST?.....	331
*WAI.....	332

*CLS

Clear status

Sets the status byte (STB), the standard event register (ESR) and the `EVENT` part of the `QUESTIONABLE` and the `OPERATION` registers to zero. The command does not alter the mask and transition parts of the registers. It clears the output buffer.

Usage: Setting only

*ESE <Value>

Event status enable

Sets the event status enable register to the specified value. The query returns the contents of the event status enable register in decimal form.

Parameters:

<Value> Range: 0 to 255

*ESR?

Event status read

Returns the contents of the event status register in decimal form and then sets the register to zero.

Return values:

<Contents> Range: 0 to 255

Usage: Query only

*IDN?

Identification

Returns the instrument identification.

Return values:

<ID> "Rohde&Schwarz,<device type>,<part number>/<serial number>,<firmware version>"

Example: Rohde&Schwarz, FPH, 1321.1111.02/100001, V2.21

Usage: Query only

*IST?

Individual status query

Returns the contents of the IST flag in decimal form. The IST flag is the status bit which is sent during a parallel poll.

Return values:

<ISTflag> 0 | 1

Usage: Query only

*OPC

Operation complete

Sets bit 0 in the event status register when all preceding commands have been executed. This bit can be used to initiate a service request. The query writes a "1" into the output buffer when all preceding commands have been executed, which is useful for command synchronization.

*OPT?

Option identification query

Queries the options included in the instrument. For a list of all available options and their description, refer to the data sheet.

Return values:

<Options> The query returns a list of all installed and activated options, separated by commas, where:
B<number> describes hardware options.
K<number> describes software options.

Example: B3, K7, K9

Usage: Query only

***RST**

Reset

Sets the instrument to a defined default status. The default settings are indicated in the description of commands.

The command is equivalent to `SYSTEM:PRESet`.

Usage: Setting only

***SRE <Contents>**

Service request enable

Sets the service request enable register to the indicated value. This command determines under which conditions a service request is triggered.

Parameters:

<Contents> Contents of the service request enable register in decimal form.
Bit 6 (MSS mask bit) is always 0.
Range: 0 to 255

***STB?**

Status byte query

Reads the contents of the status byte in decimal form.

Usage: Query only

***TRG**

Trigger

Triggers all actions waiting for a trigger event. In particular, *TRG generates a manual trigger signal. This common command complements the commands of the `TRIGger` subsystem.

*TRG corresponds to the `INITiate:IMMediate` command.

Usage: Event

***TST?**

Self-test query

Initiates self-tests of the instrument and returns an error code.

Return values:

<ErrorCode> **integer > 0 (in decimal format)**
An error occurred.

0
No errors occurred.

Usage: Query only

*WAI

Wait to continue

Prevents servicing of the subsequent commands until all preceding commands have been executed and all signals have settled (see also command synchronization and *OPC).

Usage: Event

14.6.2 Remote commands of the spectrum analyzer

This section provides a detailed description of all remote control commands required to configure and perform measurements with the spectrum analyzer. These commands are available in spectrum analyzer mode only.

- [Configuring the horizontal axis](#)..... 332
- [Configuring the vertical axis](#)..... 336
- [Configuring the tracking generator](#)..... 341
- [Setting the bandwidth](#)..... 343
- [Performing and triggering measurements](#)..... 345
- [Working with traces](#)..... 349
- [Using markers](#)..... 354
- [Using display lines and limit lines](#)..... 368
- [Configuring and using measurement functions](#)..... 375

14.6.2.1 Configuring the horizontal axis

The following commands configure the horizontal (frequency) axis of the active display.

List of commands

[SENSe:]FREQUency:CENTer	333
[SENSe:]FREQUency:CENTer:STEP	333
[SENSe:]FREQUency:CENTer:STEP:LINK	333
[SENSe:]FREQUency:INPut:MODE	334
[SENSe:]FREQUency:MODE	334
[SENSe:]FREQUency:OFFSet	335
[SENSe:]FREQUency:SPAN	335
[SENSe:]FREQUency:SPAN:AUTO	335
[SENSe:]FREQUency:SPAN:FULL	335
[SENSe:]FREQUency:STARt	335
[SENSe:]FREQUency:STOP	336

[SENSe:]FREQUENCY:CENTer <CenterFrequency>

This command defines the center frequency of the R&S Spectrum Rider.

In spectrum analyzer mode, the command also defines the measuring frequency for time domain measurements (span = 0).

Parameters:

<CenterFrequency> Range: Depends on the operating mode and is specified in the data sheet.
 *RST: fmax /2 with fmax = maximum frequency
 Default unit: MHz

Example:

```
FREQ:CENT 100MHz
```

Defines a center frequency of 100 MHz.

[SENSe:]FREQUENCY:CENTer:STEP <Stepsize>

This command defines the center frequency step size.

Parameters:

<Stepsize> Range: 1 Hz to fmax
 *RST: - (AUTO 0.1*SPAN is switched on)
 Default unit: MHz

Example:

```
FREQ:CENT:STEP 120MHz
```

Defines a CF step size of 120 MHz.

[SENSe:]FREQUENCY:CENTer:STEP:LINK <CouplingState>

This command couples and decouples the center frequency step size to the span.

For time domain measurements, the command couples the step size to the resolution bandwidth.

Parameters:

<CouplingState> CENTerf | DIVTen | OFF

CENTerf
 Sets the step size equal to the center frequency.

DIVTen
 Couples the step size to the span (10 %).

OFF
 Turns off the coupling (manual step size).

*RST: DIVTen

Example:

```
FREQ:CENT:STEP:LINK DIVT
```

Couples the step size to 10% of the span.

[SENSe:]FREQuency:INPut:MODE <InputMode>

This command selects the frequency mode. Select the Channel frequency mode only if you want to work with channel tables. In this case, the input of the center frequency is not a frequency value, but a channel number.

Parameters:

<InputMode> CHANnel | FREQ

CHANnel

Sets the frequency input mode to selection of a channel.

FREQ

Sets the frequency input mode to frequency input (in Hz).

*RST: FREQ

Example:

FREQ:INP:MODE CHAN

Sets the frequency mode to work with channel tables.

[SENSe:]FREQuency:MODE <SweepMode>

This command sets the measurement domain (frequency or time).

In the time domain (CW and FIXed), set the frequency with:

[\[SENSe:\]FREQuency:CENTer](#) on page 333

In the frequency domain (SWEep), set the frequency with:

[\[SENSe:\]FREQuency:CENTer](#) on page 333

[\[SENSe:\]FREQuency:SPAN](#) on page 335

[\[SENSe:\]FREQuency:START](#) on page 335

[\[SENSe:\]FREQuency:STOP](#) on page 336

Parameters:

<SweepMode> SWEep | CW | FIXed | SCAN

SWEep

Selects the frequency domain (span > 0).

CW

Selects the time domain (span = 0).

FIXed

Selects the time domain (span = 0).

SCAN

Selects the frequency domain (span > 0).

*RST: SWEep

Example:

FREQ:MODE SWE

Activates frequency domain measurements.

[SENSe:]FREQUENCY:OFFSet <FreqOffset>

This command defines a frequency offset.

Parameters:

<FreqOffset>	Range:	-100 GHz to 100 GHz
	*RST:	0 Hz
	Default unit:	GHz

Example:

```
FREQ:OFFS 1GHZ
```

Defines a frequency offset of 1 GHz.

[SENSe:]FREQUENCY:SPAN <FrequencySpan>

This command defines the frequency span.

If you set a span of 0 Hz, the R&S Spectrum Rider starts a measurement in the time domain.

Parameters:

<FrequencySpan>	Range:	Specified in the data sheet.
	*RST:	fmax with fmax = maximum frequency
	Default unit:	GHz

Example:

```
FREQ:SPAN 10MHZ
```

Defines a span of 10 MHz.

[SENSe:]FREQUENCY:SPAN:AUTO <State>

This command turns on or off the automatic calculation of the ideal span.

Parameters:

<State>	ON OFF
	*RST: OFF

Example:

```
FREQ:SPAN:AUTO ON
```

Turns on the automatic span determination.

[SENSe:]FREQUENCY:SPAN:FULL

This command restores the full span.

This command is an event and therefore has no query and no *RST value.

Example:

```
FREQ:SPAN:FULL
```

Restores full span.

Usage:

Event

[SENSe:]FREQUENCY:START <StartFrequency>

This command defines the start frequency for measurements in the frequency domain (span > 0).

Parameters:

<StartFrequency> Range: Depends on the operating mode and is specified in the datasheet.
 *RST: 0 Hz
 Default unit: GHz

Example:

FREQ:STAR 20MHz
 Defines a start frequency of 20 MHz.

[SENSe:]FREQuency:STOP <StopFrequency>

This command defines the stop frequency for measurements in the frequency domain (span > 0).

Parameters:

<StopFrequency> Range: Depends on the operating mode and is specified in the datasheet.
 *RST: fmax
 Default unit: GHz

Example:

FREQ:STOP 2000MHz
 Defines a stop frequency of 2 GHz.

14.6.2.2 Configuring the vertical axis

The following commands configure the vertical (level) axis and level parameters of the active display.

The suffix <t> and <p> are irrelevant.

List of commands

DISPlay[:WINDow]:TRACe<t>:Y:SPACing.....	336
DISPlay[:WINDow]:TRACe<t>:Y[:SCALE].	337
DISPlay[:WINDow]:TRACe<t>:Y[:SCALE]:ADJust.....	337
DISPlay[:WINDow]:TRACe<t>:Y[:SCALE]:RLEVel.....	337
DISPlay[:WINDow]:TRACe<t>:Y[:SCALE]:RLEVel:OFFSet.....	338
DISPlay[:WINDow]:TRACe<t>:Y[:SCALE]:RPOSitioN.....	338
INPut:ATTenuation<p>.....	339
INPut:ATTenuation:AUTO.....	339
INPut:ATTenuation:MODE.....	339
INPut:GAIN:STATe.....	339
INPut:IMPedance.....	340
[SENSe:]CORRection:TRANsducer<1...2>[:STATe].....	340
[SENSe:]CORRection:TRANsducer<1...2>:SElect.....	340
[SENSe:]CORRection:TRANsducer<1...2>:UNIT?.....	341
UNIT<t>:POWer.....	341

DISPlay[:WINDow]:TRACe<t>:Y:SPACing <ScalingType>

This command selects the scaling type of the vertical axis.

Suffix:

<t> 1..n

Parameters:

<ScalingType> LINear | LOGarithmic

LINear

Selects a linear scale (%).

LOGarithmic

Selects a logarithmic scale.

*RST: LOGarithmic

Example:

DISP:TRAC:Y:SPAC LIN

Selects linear scaling of the level axis.

DISPlay[:WINDow]:TRACe<t>:Y[:SCALE] <DisplayRange>

This command defines the display range of the vertical axis.

Note that you have to set a logarithmic scaling before you can use this command with [DISPlay\[:WINDow\]:TRACe<t>:Y:SPACing](#) on page 336. For a linear scale, you cannot modify the display range as it is fixed.

Suffix:

<t> 1..n

Parameters:

<DisplayRange> Range: 1 dB to 150 dB

*RST: 100 dB

Default unit: dB

Example:

DISP:TRAC:Y 110dB

Sets the display range to 110 dB.

DISPlay[:WINDow]:TRACe<t>:Y[:SCALE]:ADJust

This command automatically scales the vertical axis for optimum display results.

This command is an event and therefore has no query and no *RST value.

Suffix:

<t> 1..n

Example:

DISP:TRAC:Y:ADJ

Adjusts the y-axis.

Usage:

Event

DISPlay[:WINDow]:TRACe<t>:Y[:SCALE]:RLEVel <RefLevel>

This command defines the reference level.

With a reference level offset $\neq 0$, the value range of the reference level is modified by the offset. You can set the offset with `DISPlay[:WINDow]:TRACe<t>:Y[:SCALe]:RLEVel:OFFSet` on page 338.

Suffix:

<t> 1..n

Parameters:

<RefLevel> Sets the reference level; the unit depends on `UNIT<t>:POWer` on page 341.

Range: Specified in the data sheet.

*RST: -20 dBm

Default unit: dBm

Example:

`DISP:TRAC:Y:RLEV -60dBm`

Sets the reference level to -60 dBm.

DISPlay[:WINDow]:TRACe<t>:Y[:SCALe]:RLEVel:OFFSet <RefLvlOffset>

This command defines a reference level offset.

Suffix:

<t> 1..n

Parameters:

<RefLvlOffset> Sets the reference level offset.

Range: -100 dB to 100 dB

*RST: 0 dB

Default unit: dB

Example:

`DISP:TRAC:Y:RLEV:OFFS -10dB`

Example:

`DISP:TRAC1:Y:RLEV:OFFS -10dB`

Set reference level offset to -10 dB.

DISPlay[:WINDow]:TRACe<t>:Y[:SCALe]:RPOStion <RefLvlPosition>

This command defines the position of the reference level on the display grid.

First, you have to set a logarithmic scale for the vertical axis with `DISPlay[:WINDow]:TRACe<t>:Y:SPACing` on page 336. For a linear scale, you cannot modify the reference position.

Suffix:

<t> 1..n

Parameters:

<RefLvlPosition> Defines the reference position in %.

Range: 0 to 10

*RST: 10

Example:

`DISP:TRAC:Y:RPOS 5`

Sets the reference position to the 5th grid line.

INPut:ATTenuation<p> <Attenuation>

This command defines the input attenuation.

The attenuation is coupled to the reference level. If you set the attenuation independently, the R&S Spectrum Rider turns off this coupling.

The R&S Spectrum Rider adjusts the reference level if it cannot be set for the current RF attenuation.

Suffix:

<p> 1..n

Parameters:

<Attenuation> Range: 0 dB to 40 dB
*RST: 0 dB (AUTO is ON)
Default unit: dB

Example:

INP:ATT 30dB
Defines RF attenuation of 30 dB and deactivates coupling to the reference level.

INPut:ATTenuation:AUTO <State>

This command couples and decouples input attenuation to the reference level.

Parameters:

<State> ON | OFF
*RST: ON

Example:

INP:ATT:AUTO ON
Couples the attenuation set on the attenuator to the reference level.

INPut:ATTenuation:MODE <AttenMode>

This command selects the attenuation mode.

Parameters:

<AttenMode> LDISTortion | LNOise
LDISTortion
Selects "Auto Low Distortion" mode.
LNOise
Selects "Auto Low Noise" mode.
*RST: LDIS

Example:

INP:ATT:MODE LNO
Sets the attenuation mode to Auto Low Noise.

INPut:GAIN:STATe <State>

This command turns the preamplifier on and off.

Parameters:

<State> ON | OFF
 *RST: OFF

Example:

INP:GAIN:STAT ON
 Activates the preamplifier

INPut:IMPedance <Impedance>

This command selects the nominal input impedance. The set impedance is taken into account in all level indications of results.

The setting 75 Ω should be selected, if the 50 Ω input impedance is transformed to a higher impedance using a 75 Ω adapter of the RAZ type (= 25 Ω in series to the input impedance of the instrument). The correction value in this case is 1.76 dB = 10 log (75 Ω / 50 Ω).

Parameters:

<Impedance> 50 | 75
 *RST: 50 Ω
 Default unit: Ohm

Example:

INP:IMP 75
 Sets the input impedance to 75 Ohms.

[SENSe:]CORRection:TRANsducer<1...2>[:STATe] <State>

This command turns a transducer factor on and off.

Before turning it on, you have to select a transducer factor with [\[SENSe:\]CORRection:TRANsducer<1...2>:SELeCt](#) on page 340.

The numeric suffix at TRANsducer specifies the primary or secondary transducer.

Parameters:

<State> ON | OFF
 *RST: OFF

Example:

CORR:TRAN1 ON
 Activates the primary transducer.

[SENSe:]CORRection:TRANsducer<1...2>:SELeCt <TransducerName>

This command selects a transducer factor.

If <name> does not exist yet, a new transducer factor is created.

The numeric suffix at TRANsducer specifies the primary or secondary transducer.

Parameters:

<TransducerName> String containing the filename of the transducer factor.
 If the file does not exist, the R&S Spectrum Rider creates a new transducer factor.

Example: `CORR:TRAN2:SEL 'FSH-Z38.sectrd'`
Selects the FSH-Z38 secondary transducer factor.

[SENSe:]CORRection:TRANsducer<1...2>:UNIT?

This command queries the unit (DB|DBVM|DBAM) of the current transducer factor.

The numeric suffix at TRANsducer specifies the primary or secondary transducer.

Example: `CORR:TRAN2:UNIT? -> DBVM`
Return unit (DBVM) of the secondary transducer.

Usage: Query only

UNIT<t>:POWer <Unit>

This command selects the unit of the vertical axis.

The availability of units depends on the operating mode and type of measurement.

Suffix:

<t> 1..n

Parameters:

<Unit> DBM | DBMV | DBUV | DUVE | DMVE | VEMF | DBUA | VOLT |
WATT | DUVM | DUAM | V | W | V_M | W_M2 | DB | RHO |
MRHO

Note that the availability of units depends on the operating mode.

*RST: DBM

Example: `UNIT:POW DBM`
Sets the power unit to dBm.

14.6.2.3 Configuring the tracking generator

The following commands configure the characteristics of the tracking generator of the R&S Spectrum Rider.

List of commands

SOURce:TG:ATTenuation	341
SOURce:TG:AUTO	342
SOURce:TG:FREQuency	342
SOURce:TG:FREQuency:AUTO	342
SOURce:TG:FREQuency:OFFSet	343
SOURce:TG:POWer	343
SOURce:TG[:STATe]	343

SOURce:TG:ATTenuation <OutputLevel>

This command defines the relative output level of the tracking generator.

Parameters:

<OutputLevel> Range: 0 to 40
 *RST: 0
 Default unit: DB

Example:

SOUR:TG:ATT 40
 Sets the attenuation to 40 dB and therefore an output level of –40 dBm

SOURce:TG:AUTO <TgSourceMode>

This command selects the generator mode (TG or CW).

Parameters:

<TgSourceMode> ON | OFF
 *RST: OFF

Example:

SOUR:TG:AUTO ON
 Selects tracking generator.

Example:

SOUR:TG:AUTO OFF
 Selects continuous wave signal generator.

SOURce:TG:FREQuency <TgSourceFrequency>

This command defines the frequency of the generated signal.

Available when zero span has been turned on, for example with [SOURce:TG:AUTO](#).

Parameters:

TgSrcFreq Frequency of the CW signal.
 *RST: OFF
 Default unit: Hz

Example:

SOUR:TG:AUTO ON
 SOUR:TG:FREQ 500MHZ
 SOUR:TG:POW -10

Generates a CW signal with 500 MHz and a power of -10 dBm in zero span.

SOURce:TG:FREQuency:AUTO <TgAutoFrequency>

This command coupled the frequency of the CW signal as the center frequency of the current measurement.

Parameters:

<TgAutoFrequency> *RST: OFF
 Default unit: Hz

Example:

SOUR:TG:AUTO ON
 SOUR:TG:FREQ:AUTO ON
 Generates a CW signal with frequency coupled to the center frequency of the current measurement.

SOURce:TG:FREQuency:OFFSet <TgSourceFrequencyOffset>

This command defines a mathematical frequency offset for the tracking generator

Parameters:

TgSrcFreqOffset Frequency offset of the TG source.
 Range: 0 to 1.95
 *RST: 0
 Default unit: GHZ

Example:

`SOUR:TG:FREQ:OFFS 1`
 Generates a tracking generator signal with an offset frequency of 1 GHz.

SOURce:TG:POWer <TgOutputLevel>

This command defines the absolute output level of the tracking generator.

Parameters:

<TgOutputLevel> Numeric value in the range from 0 dBm to -40 dBm.
 *RST: 0
 Default unit: dBm

Example:

`SOUR:TG:POW -20`
 Defines an output level of -20 dBm.

SOURce:TG[:STATe] <TgSourceState>

This command turns the tracking generator on and off.

Available when zero span has been turned on, for example with `SOURce:TG:AUTO`.

Parameters:

<TgSourceState> ON | OFF
 *RST: OFF

Example:

`SOUR:TG:AUTO ON`
`SOUR:TG OFF`
 Stops the generation of a CW signal.

14.6.2.4 Setting the bandwidth

The following commands configure the filter bandwidths of the R&S Spectrum Rider. Note that both groups of commands (`BANDwidth` and `BWIDth`) are the same.

List of commands

<code>[SENSe:]BWIDth[:RESolution]</code>	344
<code>[SENSe:]BANDwidth[:RESolution]</code>	344
<code>[SENSe:]BWIDth[:RESolution]:AUTO</code>	344
<code>[SENSe:]BANDwidth[:RESolution]:AUTO</code>	344
<code>[SENSe:]BWIDth:VIDeo</code>	344

[SENSe:]BANDwidth:VIDeo.....	344
[SENSe:]BWIDth:VIDeo:AUTO.....	344
[SENSe:]BANDwidth:VIDeo:AUTO.....	344

[SENSe:]BWIDth[:RESolution] <ResolutionBW>
[SENSe:]BANDwidth[:RESolution] <ResolutionBW>

This command defines the resolution bandwidth.

Parameters:

<ResolutionBW> Range: 1 Hz to 3 MHz
 *RST: - (AUTO is set to ON)
 Default unit: GHz

Example: BAND 100 kHz
 Sets the resolution bandwidth to 100 kHz.

[SENSe:]BWIDth[:RESolution]:AUTO <State>
[SENSe:]BANDwidth[:RESolution]:AUTO <State>

This command couples and decouples the resolution bandwidth to the span.

Parameters:

<State> ON | OFF
 *RST: ON

Example: BAND:AUTO OFF
 Decouples the resolution bandwidth from the span.

[SENSe:]BWIDth:VIDeo <VideoBW>
[SENSe:]BANDwidth:VIDeo <VideoBW>

This command defines the video bandwidth.

Parameters:

<VideoBW> Range: 1 Hz to 3 MHz
 *RST: - (AUTO is set to ON)
 Default unit: GHz

Example: BAND:VID 10kHz
 Sets the video bandwidth to 10 kHz.

[SENSe:]BWIDth:VIDeo:AUTO <State>
[SENSe:]BANDwidth:VIDeo:AUTO <State>

This command couples and decouples the video bandwidth to the resolution bandwidth.

Parameters:

<State> ON | OFF
 *RST: ON

Example: `BAND:VID:AUTO OFF`
Turns off video bandwidth coupling.

14.6.2.5 Performing and triggering measurements

The following commands control the actual measurement process, including trigger functionality.

- [Performing the measurement](#).....345
- [Triggering measurements](#)..... 347

Performing the measurement

The following commands initialize a measurement and setup the sweep.

List of commands

ABORt	345
INITiate[:IMMediate]	345
[SENSe:]SWEEp:COUNT	346
INITiate:CONTInuous	346
[SENSe:]SWEEp:POINTS	346
[SENSe:]SWEEp:TIME	347
[SENSe:]SWEEp:TIME:AUTO	347

ABORt

This command aborts the current measurement and resets the trigger system.

This command is an event and therefore has no query and no *RST value.

Example: `ABOR;`
 `INIT:IMM`
 Aborts a measurement and starts a new one.

Usage: Event

INITiate[:IMMediate]

This command initiates a new measurement sequence.

With sweep count > 0 or average count > 0, this means a restart of the indicated number of measurements. With trace functions MAXHold, MINHold and AVERage, the previous results are reset on restarting the measurement.

In single sweep mode, synchronization to the end of the indicated number of measurements can be achieved with the command *OPC, *OPC? or *WAI. In continuous-sweep mode, synchronization to the sweep end is not possible since the overall measurement never ends.

This command is an event and therefore has no query and no *RST value.

Example: `INIT:CONT OFF`
 `DISP:WIND:TRAC:MODE AVER`
 Turns on single sweep mode and trace averaging.
 `INIT;*WAI`
 Starts the measurement and waits for the end of the sweep.

Usage: Event

[SENSe:]SWEep:COUNT <#ofSweeps>

This command defines the number of sweeps included in a single sweep. It also defines the number of sweeps the R&S Spectrum Rider uses to average traces or calculate maximum values.

The R&S Spectrum Rider performs one sweep for sweep count 0 or 1.

Parameters:

<#ofSweeps> Range: 1 to 999
 *RST: 10

Example: `SWE:COUN 64`
 Defines a sweep count of 64 sweeps.
 `INIT:CONT OFF`
 `INIT;*WAI`
 Turns on single sweep mode, starts the sweep and waits for its end.

INITiate:CONTinuous <State>

This command selects the sweep mode.

Parameters:

<State> ON | OFF
 ON
 Selects continuous sweeps.
 OFF
 Selects single sweep.
 *RST: ON

Example: `INIT:CONT OFF`
 Turns on single sweep mode.

[SENSe:]SWEep:POINTs <NrofPoints>

This command queries the number of measurement points in a single sweep.

This command is a query and therefore has no *RST value.

Parameters:

<NrofPoints> Returns the number of sweep points.

Example: `SWE:POIN?`
Returns the number of sweep points.

[SENSe:]SWEep:TIME <SweepTime>

This command defines the sweep time.

If you set a sweep time with this command, the R&S Spectrum Rider decouples the sweep time from the span and the resolution and video bandwidths.

Parameters:

<SweepTime> Range: Specified in the datasheet.
 *RST: - (AUTO is set to ON)
 Default unit: s

Example: `SWE:TIME 10s`
Sets the sweep time to 10 s.

[SENSe:]SWEep:TIME:AUTO <State>

This command couples and decouples the sweep time to the span and the resolution and video bandwidths.

Parameters:

<State> ON | OFF
 *RST: ON

Example: `SWE:TIME:AUTO ON`
Switches on the coupling to frequency span and bandwidths.

Triggering measurements

The following commands set up trigger conditions if you are using a trigger for the measurement.

List of commands

[SENSe:]SWEep:EGATe.....	347
[SENSe:]SWEep:EGATe:HOLDoff.....	348
[SENSe:]SWEep:EGATe:LENGth.....	348
[SENSe:]SWEep:EGATe:TIME.....	348
TRIGger[:SEQuence]:LEVel:VIDeo.....	348
TRIGger[:SEQuence]:SLOPe.....	349
TRIGger[:SEQuence]:SOURce.....	349

[SENSe:]SWEep:EGATe <GateTrigger>

This command turns a gated trigger setting mode on and off.

Parameters:

<GateTrigger> ON | OFF
 *RST: OFF

Example: `SWE:EGAT ON`
Activates the gated trigger setting mode.

[SENSe:]SWEep:EGATe:HOLDoff <GateTriggerHoldOff>

This command defines the length of the gate delay.

Parameters:

<GateTriggerHoldOff> Range: 0 s to 100 s
*RST: 0 s
Default unit: s

Example: `SWE:EGAT:HOLD 2.5`
Sets a gate delay of 2.5 seconds.

[SENSe:]SWEep:EGATe:LENGth <GateTriggerLength>

This command defines the gate length.

Parameters:

<GateTriggerLength> Range: 10 μ s to 100 s
*RST: 400 μ s
Default unit: s

Example: `SWE:EGAT:LENG 2.5`
Sets a gate length of 2.5 seconds.

[SENSe:]SWEep:EGATe:TIME <GateTriggerLength>

This command defines the sweep time for the gated trigger.

Parameters:

<GateTriggerLength> *RST: 400 μ s
Default unit: s

Example: `SWE:GATE:TIME 4ms`
Sets a sweep time of 4 ms for the gated trigger.

TRIGger[:SEQuence]:LEVel:VIDeo <VideoTrigLevel>

This command defines the level of the video trigger.

Video trigger is available for time domain measurements (span = 0).

Parameters:

<VideoTrigLevel> Range: 0 PCT to 100 PCT
*RST: 50 PCT

Example: `TRIG:LEV:VID 50PCT`
Sets the trigger level to 50%.

TRIGger[:SEQuence]:SLOPe <TriggerSlope>

This command selects the slope of the trigger signal.

The trigger slope applies to all trigger sources.

Parameters:

<TriggerSlope> POSitive | NEGative
*RST: POSitive

Example: TRIG:SLOP NEG

TRIGger[:SEQuence]:SOURce <TriggerSource>

This command selects the trigger source.

Parameters:

<TriggerSource> IMMEDIATE | EXTERNAL | VIDEO | IQPOWER | GATED

IMMEDIATE

Selects Free Run measurements.

EXTERNAL

Selects an external trigger.

VIDEO

Selects the video trigger.

IQPOWER

Selects an IQ Power trigger.

Gated

Selects a gated trigger.

*RST: IMMEDIATE

Example: TRIG:SOUR EXT
Selects the external trigger input as source of the trigger signal.

14.6.2.6 Working with traces

The following commands set up the trace and the various functions associated with it, e.g. trace mathematics or the selection of the detector.

The suffix <t> selects the measurement trace. It is in the range of <1..2>.

List of commands

[SENSe:]DETECTOR<t>[:FUNCTION].....	350
[SENSe:]DETECTOR<t>[:FUNCTION]:AUTO.....	350
CALCulate<t>:MATH:COPY:MEMory.....	350
CALCulate<t>:MATH:STATe.....	350
CALCulate<t>:MATH[:EXPRession][:DEFine].....	351
DISPlay[:WINDow]:TRACe<t>[:STATe].....	351
DISPlay[:WINDow]:TRACe<t>:MEMory[:STATe].....	351
DISPlay[:WINDow]:TRACe<t>:MODE.....	352
FORMat:BORDER.....	352

FORMat[:DATA].....	353
TRACe<t>[:DATA]?.....	353
TRACe<t>[:DATA]:MEMory?.....	354

[SENSe:]DETEctor<t>[:FUNCTion] <Detector>

This command selects a detector function.

Suffix:

<t> 1..n

Parameters:

<Detector> POSitive | NEGative | SAMPlE | RMS | AVERAge | APEak
*RST: APE

Example:

DET POS
Sets the primary detector to "positive peak".

[SENSe:]DETEctor<t>[:FUNCTion]:AUTO <State>

This command couples and decouples the detector to the trace mode.

Suffix:

<t> 1..n

Parameters:

<State> ON | OFF
*RST: ON

Example:

DET:AUTO OFF
Turns off automatic detector selection for primary detector.

CALCulate<t>:MATH:COpy:MEMory [<MemorySlot>]

This command stores the selected trace into the memory trace of the R&S Spectrum Rider.

This command is an event and therefore has no query and no *RST value.

Suffix:

<t> 1..n

Parameters:

<MemorySlot>

Example:

CALC1:MATH:COpy:MEM

Usage:

Setting only

Copies trace1 into the memory.

CALCulate<t>:MATH:STATe <State>

This command turns trace mathematics on and off.

Suffix:
 <t> 1..n

Parameters:
 <State> ON | OFF
 *RST: OFF

Example: CALC:MATH:STAT ON
 Switches on the trace mathematics.

CALCulate<t>:MATH[:EXPRession][:DEFine] <MathExpression>

This command defines the mathematical expression for relating traces to trace 1.

You have to activate trace mathematics with [CALCulate<t>:MATH:STATe](#) on page 350 first.

Suffix:
 <t> 1..n

Parameters:
 <MathExpression> <list>

(IMPLied - memory)
 Subtracts the trace in memory from the current trace.

(memory - IMPLied)
 Subtracts the current trace from the trace in memory.

Example: CALC:MATH (memory - IMPLied)
 Selects the subtraction of the current trace from trace in the memory.

DISPlay[:WINDow]:TRACe<t>[:STATe] <State>

This command turns a trace on and off.

Suffix:
 <t> 1..n

Parameters:
 <State> ON | OFF
 *RST: ON for TRACe1, OFF for TRACe2

Example: DISP:TRAC2 ON
 Turns on the trace 2.

DISPlay[:WINDow]:TRACe<t>:MEMory[:STATe] <State>

This command turns the memory trace on and off.

Suffix:
 <t> 1..n

Parameters:

<State> ON | OFF
 *RST: OFF

Example:

DISP:TRAC:MEM ON
 Activates the memory trace.

DISPlay[:WINDow]:TRACe<t>:MODE <DisplayMode>

This command selects the trace mode.

If you are using the average, max hold or min hold trace mode, you can set the number of measurements with [SENSe:]SWEep:COUNT<SweepCount>. Note that synchronization to the end of the average count is possible only in single sweep mode.

Suffix:

<t> 1..n

Parameters:

<DisplayMode> WRITe | AVERage | MINHold | MAXHold | VIEW | FREeze | INFinite

*RST: WRITe

You can turn off the trace with [DISPlay\[:WINDow\]:TRACe<t>\[:STATe\]](#) on page 351 .

Example:

SWE:CONT OFF
 SWE:COUN 16
 Turn on single sweep mode and sets the number of measurements to 16.
 DISP:TRAC:MODE MAXH
 Activates MAXHold mode for the trace.
 INIT;*WAI
 Starts the measurement and waits for the end of the 16 sweeps.

FORMat:BORDER <TransferOrder>

This command selects the format of binary data.

Parameters:

<TransferOrder> NORMAl | SWAPped

NORMAl

The most significant byte is transferred first big endian).

SWAPped

The least significant byte is transferred first (little endian).

*RST: SWAPped

Example:

FORM:BORD NORM
 Changes the byte order to normal mode.

FORMat[:DATA] <Format>[, <>]

This command selects the data format that is used for transmission of trace data from the R&S Spectrum Rider to the controlling computer.

Note that the command has no effect for data that you send to the R&S Spectrum Rider. The R&S Spectrum Rider automatically recognizes the data it receives, regardless of the format.

Parameters:

<Format>

ASCII | REAL

ASCII

Returns the data in ASCII format, separated by commas.

REAL

Returns the data as 32-bit IEEE 754 floating point numbers in the "definite length block format".

*RST: ASCII

In REAL, 32 format, a string of return values would look like:

#42424<value 1><value 2>...<value n> with

#4 - representing the number of digits of the following number of data bytes (= 4 in this example);

2524 - representing the number of following data bytes (2524, corresponds to the 711 sweep points of the R&S Spectrum Rider.

<value> - representing 4-byte floating point value.

Example:

FORM ASC

Selects the ASCII data format.

TRACe<t>[:DATA]? [<arg0>]

This command queries the trace data of the current measurement.

It also transfers data from a file to a particular trace.

With the command **FORMat [:DATA]** on page 353, you can set the data format.

With the command **CALCulate<t>:FEED** on page 410, you can select the result display.

Suffix:

<t>

1..n

Parameters:

<arg0>

TRACe1 | TRACe2 | LIST | PHOLd | RAW

TRACe1

Queries the data of trace 1.

TRACe2

Queries the data of trace 2.

LIST

Queries the peak list of the measurement.

PHOLD

Queries the scanned peak hold list in the receiver mode measurement.

RAW

Queries the raw FSK/ASK data in the analog demodulation mode measurement.

The R&S Spectrum Rider returns 711 values. Each value corresponds to one pixel of a trace.

The unit depends on the measurement and the unit you have set with `UNIT<1..2>:POWER`.

Note: If you use the auto peak detector, the command reads out positive peak values only.

Example: `TRAC:DATA? TRACE1`
Reads out the data for trace 1.

Usage: Query only

TRACe<t>[:DATA]:MEMory? [<arg0>]

Read memory trace data.

Suffix:

<t> 1..n

Parameters:

<arg0>

Example: `CALC:MATH:COPY:MEM`
`TRAC:MEM?`
Copy trace1 to memory1 and read memory1 trace data.

Example: `CALC:MATH2:COPY:MEM`
`TRAC:MEM? TRACE2`
Copy trace2 to memory2 and read memory2 trace data.

Usage: Query only

14.6.2.7 Using markers

The following commands control the operation of marker, delta markers and marker functions.

- [Markers and delta markers](#)..... 354
- [Marker functions](#).....363

Markers and delta markers

The following commands are for setting and controlling markers and deltamarkers.

The suffix <m> selects the marker. It is in the range of <1..6>.

The suffix <t> select the measurement trace. It is in the range of <1..2>.

The suffix <l> select the limit line. It is in the range of <1..2>.

List of commands

CALCulate<t>:DELTamarker<m>[:STATe].....	355
CALCulate<t>:DELTamarker<m>:AOFF.....	355
CALCulate<t>:DELTamarker<m>:MAXimum[:PEAK].....	356
CALCulate<t>:DELTamarker<m>:MAXimum:NEXT.....	356
CALCulate<t>:DELTamarker<m>:MINimum[:PEAK].....	356
CALCulate<t>:DELTamarker<m>:X.....	357
CALCulate<t>:DELTamarker<m>:X:RELative.....	357
CALCulate<t>:DELTamarker<m>:Y?.....	358
CALCulate<t>:MARKer<m>[:STATe].....	358
CALCulate<t>:MARKer<m>:AOFF.....	359
CALCulate<t>:MARKer:FREQuency:MODE.....	359
CALCulate<t>:MARKer<m>:FUNCTion:CENTer.....	359
CALCulate<t>:MARKer<m>:FUNCTion:REFerence.....	360
CALCulate<t>:MARKer<m>:MAXimum[:PEAK].....	360
CALCulate<t>:MARKer<m>:MAXimum:NEXT.....	360
CALCulate<t>:MARKer<m>:MINimum[:PEAK].....	360
CALCulate<t>:MARKer<m>:X.....	361
CALCulate<t>:MARKer<m>:X:SLIMits<l>[:STATe].....	361
CALCulate<t>:MARKer<m>:X:SLIMits<l>:LEFT.....	362
CALCulate<t>:MARKer<m>:X:SLIMits<l>:RIGHT.....	362
CALCulate<t>:MARKer<m>:Y?.....	363

CALCulate<t>:DELTamarker<m>[:STATe] <State>

This command turns delta markers on and off.

If you set the suffix at DELTmarker to 1, or use no suffix, the R&S Spectrum Rider interprets this as delta marker 2 because the first marker has to be a normal marker. If more than one normal marker (2 to 6) is already active, the command turns these markers into delta markers. If no delta marker is active yet, the command activates the delta marker and positions it on the trace maximum.

Suffix:

<t> 1..n

<m> 1..n

Parameters:

<State> ON | OFF

*RST: OFF

Example:

CALC:DELT3 ON

Turns on delta marker 3 or turn marker 3 into a delta marker.

CALCulate<t>:DELTamarker<m>:AOFF

This command turns off all active delta markers.

This command is an event and therefore has no query and no *RST value.

Suffix:
 <t> 1..n
 <m> 1..n
Example: CALC:DELT:AOFF
 Turns off all delta markers.
Usage: Event

CALCulate<t>:DELTamarker<m>:MAXimum[:PEAK]

This command positions a delta marker on the current trace maximum.

If necessary, the corresponding delta marker is activated first.

This command is an event and therefore has no *RST value and no query.

Suffix:
 <t> 1..n
 <m> 1..n
Example: CALC:DELT3:MAX
 Moves delta marker 3 to the maximum peak.
Usage: Event

CALCulate<t>:DELTamarker<m>:MAXimum:NEXT

This command positions a delta marker on the next smaller trace maximum.

If necessary, the corresponding delta marker is activated first.

This command is an event and therefore has no *RST value and no query.

Suffix:
 <t> 1..n
 <m> 1..n
Example: CALC:DELT2:MAX:NEXT
 Moves delta marker 2 to the next smaller maximum peak.
Usage: Event

CALCulate<t>:DELTamarker<m>:MINimum[:PEAK]

This command positions a delta marker on the current trace minimum.

If necessary, the corresponding delta marker is activated first.

This command is an event and therefore has no *RST value and no query.

Suffix:
 <t> 1..n
 <m> 1..n

Example: `CALC:DELT3:MIN`
 Moves delta marker 3 to the trace minimum.

Usage: Event

CALCulate<t>:DELTamarker<m>:X <FrequencyOrTime>

This command positions a delta marker on a particular coordinate on the horizontal axis.

Note that it is possible to place the marker outside the visible trace. In that case, this value is invalid.

If necessary, the corresponding delta marker is activated first.

Suffix:

<t> 1..n

<m> 1..n

Parameters:

<FrequencyOrTime> Numeric value that indicates the coordinate on the horizontal axis.

Range: Maximum span.

Default unit: GHz

Example: `CALC:DELT:MOD REL`
 Delta marker positions are relative to marker 1.
`CALC:DELT2:X 10.7MHz`
 Positions delta marker 2 10.7 MHz to the right of marker 1.
`CALC:DELT2:X?`
`CALC:DELT2:X:REL?`
 Queries the absolute and relative position of delta marker 2.

CALCulate<t>:DELTamarker<m>:X:RELative <FrequencyOrTime>

This command positions a delta marker on a position relative to the reference marker.

If necessary, the corresponding delta marker is activated first.

Suffix:

<t> 1..n

<m> 1..n

Parameters:

<FrequencyOrTime> Defines the distance of the marker to the reference marker.

Range: Depends on the current scaling of the horizontal axis.

Default unit: GHz

Example: `CALC:DELT3:X:REL 5 kHz`
 Sets the delta marker at a distance of 5 kHz to the reference position.

CALCulate<t>:DELTaMarker<m>:Y?

This command queries the vertical position of a delta marker. The result is always a relative value in relation marker 1.

If necessary, the corresponding delta marker is activated first.

To get a valid result, you have to perform a complete sweep with synchronization to the sweep end between activating the delta marker and reading out the result. This is only possible in single sweep mode.

In spectrum analyzer mode, the unit depends on the unit you have set and the scaling of the vertical axis.

Parameter or measuring functions	Output unit
DBM DBPW DBUV DBMV DBUA	dB (lin/log)
WATT VOLT AMPere	dB (lin), % (log)

Suffix:

<t> 1..n

<m> 1..n

Example:

```
INIT:CONT OFF
```

```
CALC:DELT2 ON
```

Turns on single sweep mode and delta marker 2.

```
INIT;*WAI
```

Starts a sweep and waits for its end.

```
CALC:DELT2:Y?
```

Queries the position of delta marker 2.

Usage:

Query only

CALCulate<t>:MARKer<m>[:STATe] <State>

This command turns markers on and off.

If you do not use a suffix at MARKer, marker 1 is selected. If one or more delta markers (2 to 6) are already active, the command turns these delta markers into normal markers.

Suffix:

<t> 1..n

<m> 1..n

Parameters:

<State> ON | OFF

```
*RST: OFF
```

Example:

```
CALC:MARK3 ON
```

Turns on marker 3.

CALCulate<t>:MARKer<m>:AOFF

This command turns off all active markers, delta markers and active marker measurement functions.

This command is an event and therefore has no query and no *RST value.

Suffix:

<t> 1..n

<m> 1..n

Example:

CALC:MARK:AOFF
Switches off all markers.

Usage:

Event

CALCulate<t>:MARKer:FREQuency:MODE <Mode>

This command selects the marker frequency display mode.

Suffix:

<t> 1..n

Parameters:

<Mode> FREQuency | CHANnel

FREQuency

Sets the marker frequency mode to frequency input (in Hz).

CHANnel

Sets the marker frequency mode to channel input (as a channel number).

*RST: FREQ

Example:

CALC:MARK:FREQ:MODE FREQ
Selects the frequency display mode.

CALCulate<t>:MARKer<m>:FUNCTion:CENTer

This command matches the center frequency to the frequency of a marker.

If you use a delta marker, the R&S Spectrum Rider turns it into a normal marker.

This command is an event and therefore has no *RST value and no query.

Suffix:

<t> 1..n

<m> 1..n

Example:

CALC:MARK2:FUNC:CENT
Matches the center frequency to the frequency of marker 2.

Usage:

Event

CALCulate<t>:MARKer<m>:FUNCTion:REFerence

This command matches the reference level to the power level of a marker.

If you use a delta marker, the R&S Spectrum Rider turns it into a normal marker.

This command is an event and therefore has no *RST value and no query.

Suffix:

<t> 1..n

<m> 1..n

Example:

CALC:MARK1:FUNC:REF

Matches the reference level to the power level of marker 1.

Usage:

Event

CALCulate<t>:MARKer<m>:MAXimum[:PEAK]

This command positions a marker on the current trace maximum.

If necessary, the corresponding marker is activated first.

This command is an event and therefore has no *RST value and no query.

Suffix:

<t> 1..n

<m> 1..n

Example:

CALC:MARK2:MAX

Moves marker 2 to the maximum peak.

Usage:

Event

CALCulate<t>:MARKer<m>:MAXimum:NEXT

This command positions a marker on the next smaller trace maximum.

If necessary, the corresponding marker is activated first.

This command is an event and therefore has no *RST value and no query.

Suffix:

<t> 1..n

<m> 1..n

Example:

CALC:MARK2:MAX:NEXT

Moves marker 2 to the next smaller maximum peak.

Usage:

Event

CALCulate<t>:MARKer<m>:MINimum[:PEAK]

This command positions a marker on the current trace minimum.

If necessary, the corresponding marker is activated first.

This command is an event and therefore has no *RST value and no query.

Suffix:

<t> 1..n

<m> 1..n

Example:

CALC:MARK2:MIN

Moves marker 2 to the trace minimum.

Usage:

Event

CALCulate<t>:MARKer<m>:X <FrequencyOrTime>

This command positions a marker on a particular coordinate on the horizontal axis.

If one or more delta markers (2 to 6) are already active, the command turns these delta markers into normal markers.

Note that it is possible to place the marker outside the visible trace. In that case, this value is invalid.

If necessary, the corresponding delta marker is activated first.

Suffix:

<t> 1..n

<m> 1..n

Parameters:

<FrequencyOrTime> Indicates the coordinate on the horizontal axis.
The unit in spectrum analyzer mode depends on the measurement, e.g. Hz for measurements in the frequency domain and seconds for measurements in the time domain.

Range: Maximum span.

Default unit: GHz

Example:

CALC:MARK2:X 10.7MHz

Positions marker 2 to frequency 10.7 MHz.

CALCulate<t>:MARKer<m>:X:SLIMits<l>[:STATE] <State>

This command turns marker search limits on and off.

The search limit restricts the evaluation range of the trace when "set marker" functions are performed. For example, marker set to peak with command [CALCulate<t>:MARKer<m>:MAXimum\[:PEAK\]](#) on page 360 sets the marker only at the peak of the trace within the search limit.

Suffix:

<t> 1..n

<m> 1..n

<l> 1..n

Parameters:

<State> ON | OFF
 *RST: OFF

Example:

See [CALCulate<t>:MARKer<m>:X:SLIMits<l>:RIGHT](#) on page 362.

CALCulate<t>:MARKer<m>:X:SLIMits<l>:LEFT <SearchLimit>

This command defines the left limit of the marker search range.

To use the command, you first have to turn on search limits with [CALCulate<t>:MARKer<m>:X:SLIMits<l>\[:STATe\]](#) on page 361.

Suffix:

<t> 1..n
 <m> 1..n
 <l> 1..n

Parameters:

<SearchLimit> Sets the left marker search limit.
 The unit in the spectrum analyzer mode depends on the measurement, e.g. Hz for measurements in the frequency domain and seconds for measurements in the time domain.
 Range: Maximum span.
 *RST: – (is set to the left diagram border when switching on search limits)
 Default unit: GHz

Example:

See [CALCulate<t>:MARKer<m>:X:SLIMits<l>:RIGHT](#) on page 362.

CALCulate<t>:MARKer<m>:X:SLIMits<l>:RIGHT <SearchLimit>

This command defines the right limit of the marker search range.

To use the command, you first have to turn on search limits with [CALCulate<t>:MARKer<m>:X:SLIMits<l>\[:STATe\]](#) on page 361.

Suffix:

<t> 1..n
 <m> 1..n
 <l> 1..n

Parameters:

<SearchLimit> Sets the right marker search limit.
 The unit depends on the measurement, e.g. Hz for measurements in the frequency domain and seconds for measurements in the time domain.

Range: Maximum span.

***RST:** – (is set to the right diagram border when switching on search limits)

Default unit: GHz

Example:

```
CALC:MARK:X:SLIM ON
CALC:MARK:X:SLIM:LEFT 10MHz
CALC:MARK:X:SLIM:RIGH 100MHz
```

Turns on search limits and defines a search range from 10 MHz to 100 MHz.

CALCulate<t>:MARKer<m>:Y?

This command queries the absolute vertical position of a marker.

If necessary, the corresponding marker is activated first.

To get a valid result, you have to perform a complete sweep with synchronization to the sweep end between activating the delta marker and reading out the result. This is only possible in single sweep mode.

The unit of the return value depends on `UNIT<1...2>:POWER`.

Suffix:

<t> 1..n

<m> 1..n

Example:

```
INIT:CONF OFF
CALC:MARK2 ON
```

Turns on single sweep mode and marker 2.

```
INIT;*WAI
```

Starts a sweep and waits for the end.

```
CALC:MARK2:Y?
```

Queries the position of marker 2.

Usage: Query only

Marker functions

The following commands perform various kinds of analysis at the marker position.

The suffix `<m>` selects the marker. It is in the range of `<1..6>`.

The suffix `<t>` select the measurement trace. It is in the range of `<1..2>`.

List of commands

CALCulate<t>:MARKer:COUNT:RESolution:MODE.....	364
CALCulate<t>:MARKer<m>:COUNT:FREQuency?.....	364
CALCulate<t>:MARKer<m>:COUNT[:STATe].....	365
CALCulate<t>:MARKer<m>:FUNction:DEModulation[:STATe].....	365
CALCulate<t>:MARKer<m>:FUNction:DEModulation:HOLD.....	366
CALCulate<t>:MARKer<m>:FUNction:DEModulation:SElect.....	366
CALCulate<t>:MARKer<m>:FUNction:NDBDown.....	366
CALCulate<t>:MARKer<m>:FUNction:NDBDown:FREQuency?.....	367
CALCulate<t>:MARKer<m>:FUNction:NDBDown:RESult?.....	367
CALCulate<t>:MARKer<m>:FUNction:NDBDown:STATe.....	367
CALCulate<t>:MARKer<m>:FUNction:NOISe[:STATe].....	368
CALCulate<t>:MARKer<m>:FUNction:NOISe:RESult?.....	368

CALCulate<t>:MARKer:COUNT:RESolution:MODE <ResolutionMode>

This command sets and queries the resolution frequency counter mode.

Suffix:

<t> 1..n

Parameters:

<ResolutionMode> HIGH | LOW

HIGH

Sets high resolution frequency counter..

LOW

Sets low resolution frequency counter.

Example:

CAL:MARK1:COUNT:RES:MODE?

Return frequency counter mode for marker 1.

Example:

CAL:MARK1:COUNT:RES:MODE HIGH

Set frequency counter mode to high resolution for marker 1.

CALCulate<t>:MARKer<m>:COUNT:FREQuency?

This command performs a frequency measurement at the marker position and returns the result.

To get a valid result, you have to perform a complete sweep with synchronization to the sweep end to make sure that the R&S Spectrum Rider actually reaches the frequency you want to measure. This is only possible in single sweep mode.

Before you can use the command, you have to turn on the frequency counter with [CALCulate<t>:MARKer<m>:COUNT\[:STATe\]](#) on page 365.

Suffix:

<t> 1..n

<m> 1..n

Example:

See [CALCulate<t>:MARKer<m>:COUNT\[:STATe\]](#) on page 365.

Usage: Query only

CALCulate<t>:MARKer<m>:COUNT[:STATe] <State>

This command turns the frequency counter at the marker position on and off.

You can read out the result with [CALCulate<t>:MARKer<m>:COUNT:FREQuency?](#) on page 364.

Frequency counting is possible only for one marker at a time. If it is activated for another marker, it is automatically deactivated for the previous marker.

To get a valid result, you have to perform a complete sweep with synchronization to the sweep end to make sure that the R&S Spectrum Rider actually reaches the frequency you want to measure. This is only possible in single sweep mode.

Suffix:

<t> 1..n

<m> 1..n

Parameters:

<State> ON | OFF
*RST: OFF

Example:

```
INIT:CONT OFF
CALC:MARK ON
Turns on single sweep mode and marker 1.
CALC:MARK:COUN ON
Turns on the frequency counter for marker 1.
INIT;*WAI
CALC:MARK:COUN:FREQ?
Performs a measurement and queries the results of the frequency counter.
```

CALCulate<t>:MARKer<m>:FUNCTION:DEModulation[:STATe] <State>

This command turns the audio demodulator on and off when the measurement hits a marker position.

With span > 0, you can define a hold time at the marker position with [CALCulate<t>:MARKer<m>:FUNCTION:DEModulation:HOLD](#) on page 366.

In zero span, the demodulation is on permanently.

Suffix:

<t> 1..n

<m> 1..n

Parameters:

<State> ON | OFF
*RST: OFF

Example: `CALC:MARK3:FUNC:DEM ON`
Switches on the demodulation for marker 3.

CALCulate<t>:MARKer<m>:FUNCTion:DEModulation:HOLD <HoldTime>

This command defines the hold time at the marker position for the demodulation with span > 0.

Suffix:

<t> 1..n

<m> 1..n

Parameters:

<HoldTime> Range: 100 ms to 500 s
*RST: 0.5 (DEModulation is set to OFF)
Default unit: s

Example: `CALC:MARK:FUNC:DEM:HOLD 3s`
Sets a hold time of 3 seconds.

CALCulate<t>:MARKer<m>:FUNCTion:DEModulation:SELEct <DemodType>

This command selects the type of demodulation type for the audio demodulator.

Suffix:

<t> 1..n

<m> 1..n

Parameters:

<DemodType> AM | FM
*RST: AM

Example: `CALC:MARK:FUNC:DEM:SEL FM`
Selects FM demodulation.

CALCulate<t>:MARKer<m>:FUNCTion:NDBDown <MarkerDistance>

This command defines the distance of the n dB down markers to the reference marker.

Suffix:

<t> 1..n

<m> 1..n

Parameters:

<MarkerDistance> Distance of the temporary markers to the reference marker in dB.
*RST: 3 dB
Default unit: dB

Example: See [CALCulate<t>:MARKer<m>:FUNCTion:NDBDown:STATE](#) on page 367

CALCulate<t>:MARKer<m>:FUNCTion:NDBDown:FREQuency?

This command queries the horizontal position of the n dB down markers.

Suffix:

<t> 1..n

<m> 1..n

Example: See [CALCulate<t>:MARKer<m>:FUNCTion:NDBDown:STATE](#) on page 367

Usage: Query only

CALCulate<t>:MARKer<m>:FUNCTion:NDBDown:RESult?

This command queries the frequency spacing or bandwidth of the n dB down markers.

Suffix:

<t> 1..n

<m> 1..n

Example: See [CALCulate<t>:MARKer<m>:FUNCTion:NDBDown:STATE](#) on page 367.

Usage: Query only

CALCulate<t>:MARKer<m>:FUNCTion:NDBDown:STATE <State>

This command turns the n dB Down marker function on and off.

Suffix:

<t> 1..n

<m> 1..n

Parameters:

<State> ON | OFF

*RST: OFF

Example:

`CALC:MARK:FUNC:NDBD:STAT ON`

Turns on the n dB marker function.

`CALC:MARK:FUNC:NDBD 3`

Positions two temporary markers 3 dB below a reference marker.

`CALC:MARK:FUNC:NDBD:FREQ?`

Queries the frequency position of the n dB Down markers; would return e.g. 100000000, 200000000.

`CALC:MARK:FUNC:NDBD:RES?`

Queries the measurement result; would return e.g. 100000000.

CALCulate<t>:MARKer<m>:FUNCTion:NOISe[:STATe] <State>

This command turns the noise measurement for all markers on and off.

You can query the results of the noise power density at the marker position with [CALCulate<t>:MARKer<m>:FUNCTion:NOISe:RESult?](#) on page 368.

Suffix:

<t> 1..n

<m> 1..n

Parameters:

<State> ON | OFF

*RST: OFF

Example:

See [CALCulate<t>:MARKer<m>:FUNCTion:NOISe:RESult?](#) on page 368.

CALCulate<t>:MARKer<m>:FUNCTion:NOISe:RESult?

This command queries the result of the noise measurement.

To get a valid result, you have to perform a complete sweep with synchronization to the sweep end before reading out the result. This is only possible in single sweep mode.

This command is an event and therefore has no *RST value and no query.

Suffix:

<t> 1..n

<m> 1..n

Example:

INIT:CONT OFF

Turns on single sweep mode.

CALC:MARK2 ON

CALC:MARK2:FUNC:NOIS ON

Turns on marker 2 and assigns the noise measurement to that marker.

INIT;*WAI

CALC:MARK2:NOIS:RES?

Performs the measurement and queries the noise marker results.

Usage:

Query only

14.6.2.8 Using display lines and limit lines

The following commands define the display lines and limit lines.

Display lines

The following commands define the position of the display line.

The suffix <t> selects the measurement trace. It is in the range of <1..2>.

List of commands

CALCulate<t>:DLINe	369
CALCulate<t>:DLINe:STATe	369

CALCulate<t>:DLINe <LinePosition>

This command defines the position of a display line.

Suffix:

<t> 1..n

Parameters:

<LinePosition> Numeric value with a variable range and unit.
You can use any unit you want, the R&S Spectrum Rider then converts the unit to the currently selected unit. If you omit a unit, the R&S Spectrum Rider uses the currently selected unit.

*RST: – (STATe to OFF)

Default unit: dBm

Example:

`CALC:DLIN -20dBm`

Sets the display line threshold to -20 dBm.

CALCulate<t>:DLINe:STATe <State>

This command turns display lines on and off.

Suffix:

<t> 1..n

Parameters:

<State> ON | OFF

*RST: OFF

Example:

`CALC:DLIN:STAT OFF`

Turns on the display line.

Limit lines

The following commands define limit lines and perform the corresponding limit checks.

The suffix <t> selects the measurement trace. It is in the range of <1..2>.

The suffix <l> selects the limit line. It is in the range of <1..2>.

List of commands

- [CALCulate<t>:DLINe](#) on page 369
- [CALCulate<t>:DLINe:STATe](#) on page 369

For a detailed description of the commands not described below, see [Display lines](#) in spectrum mode.

CALCulate<t>:LIMit:BEEP[:STATe].....	370
CALCulate<t>:LIMit<l>:COMMENT?.....	370
CALCulate<t>:LIMit<l>:DEFine.....	371
CALCulate<t>:LIMit<l>:DELete.....	372
CALCulate<t>:LIMit<l>:FAIL?.....	372
CALCulate<t>:LIMit:STATe.....	372
CALCulate<t>:LIMit<l>:UNIT:X?.....	373
CALCulate<t>:LIMit<l>:UNIT[:Y]?.....	373
CALCulate<t>:LIMit<l>:LOWer:SElect.....	373
CALCulate<t>:LIMit<l>:UPPer:SElect.....	374
CALCulate<t>:LIMit<l>:LOWer:THReshold.....	374
CALCulate<t>:LIMit<l>:UPPer:THReshold.....	374

CALCulate<t>:LIMit:BEEP[:STATe] <State>

This command turns the beeper that beeps if a limit line is violated on and off.

Suffix:

<t> 1..n

Parameters:

<State> ON | OFF
*RST: OFF

Example:

CALC:LIM:BEEP ON
Activates the audio beep.

CALCulate<t>:LIMit<l>:COMMENT?

This command queries the description of a limit line.

This command is a query and therefore has no RST value.

Suffix:

<t> 1..n

<l> 1..n

Example:

CALC:LIM:COMM?
Queries the description of limit line 1.

Usage:

Query only

CALCulate<t>:LIMit<l>:DEFine <Name>, <Description>, <X-unit>, <X-scale>, <Y-unit>, <X0>, <Y0>, <X1>, <Y1>[, <X2>, <Y2>, <X3>, <Y3>, <X4>, <Y4>, <X5>, <Y5>, <X6>, <Y6>, <X7>, <Y7>, <X8>, <Y8>, <X9>, <Y9>, <X10>, <Y10>, <X11>, <Y11>, <X12>, <Y12>, <X13>, <Y13>, <X14>, <Y14>, <X15>, <Y15>, <X16>, <Y16>, <X17>, <Y17>, <X18>, <Y18>, <X19>, <Y19>, <X20>, <Y20>, <X21>, <Y21>, <X22>, <Y22>, <X23>, <Y23>, <X24>, <Y24>, <X25>, <Y25>, <X26>, <Y26>, <X27>, <Y27>, <X28>, <Y28>, <X29>, <Y29>, <X30>, <Y30>, <X31>, <Y31>, <X32>, <Y32>, <X33>, <Y33>, <X34>, <Y34>, <X35>, <Y35>, <X36>, <Y36>, <X37>, <Y37>, <X38>, <Y38>, <X39>, <Y39>, <X40>, <Y40>, <X41>, <Y41>, <X42>, <Y42>, <X43>, <Y43>, <X44>, <Y44>, <X45>, <Y45>, <X46>, <Y46>, <X47>, <Y47>, <X48>, <Y48>, <X49>, <Y49>, <X50>, <Y50>, <X51>, <Y51>, <X52>, <Y52>, <X53>, <Y53>, <X54>, <Y54>, <X55>, <Y55>, <X56>, <Y56>, <X57>, <Y57>, <X58>, <Y58>, <X59>, <Y59>, <X60>, <Y60>, <X61>, <Y61>, <X62>, <Y62>, <X63>, <Y63>, <X64>, <Y64>, <X65>, <Y65>, <X66>, <Y66>, <X67>, <Y67>, <X68>, <Y68>, <X69>, <Y69>, <X70>, <Y70>, <X71>, <Y71>, <X72>, <Y72>, <X73>, <Y73>, <X74>, <Y74>, <X75>, <Y75>, <X76>, <Y76>, <X77>, <Y77>, <X78>, <Y78>, <X79>, <Y79>, <X80>, <Y80>, <X81>, <Y81>, <X82>, <Y82>, <X83>, <Y83>, <X84>, <Y84>, <X85>, <Y85>, <X86>, <Y86>, <X87>, <Y87>, <X88>, <Y88>, <X89>, <Y89>, <X90>, <Y90>, <X91>, <Y91>, <X92>, <Y92>, <X93>, <Y93>, <X94>, <Y94>, <X95>, <Y95>, <X96>, <Y96>, <X97>, <Y97>, <X98>, <Y98>, <X99>, <Y99>]

This command defines the shape of a limit line.

After you have defined the shape of the limit line, you still have to activate it with [CALCulate<t>:LIMit<l>:UPPer:SElect](#) on page 374 before it takes effect.

Suffix:

<t> 1..n

<l> 1..n

Parameters:

<Name>	String containing the name of the limit line. Note: if a limit line with the same name already exists, it is overwritten.
<Description>	String containing a comment for the limit line.
<X-unit>	HZ S M Unit of the x-axis.
<X-scale>	ABSolute RELative Scale of the x-axis.
<Y-unit>	DB DBM DBMV DBUV DBUA V VOLT W WATT DBUVm DBUam V_M W_M2 VSWR Unit of the y-axis.
<X0>..<<X99>	Data points on the x-axis. Note: a limit line may consist of up to 100 horizontal data points.
<Y0>..<<Y99>	Data points on the y-axis.

Example: `CALC:LIM:DEF`
`'Line','Example',HZ,ABS,DBM,10000000,-10,`
`10000000,0,20000000,0`
 Defines a limit line with three data points.

Usage: Setting only

CALCulate<t>:LIMit<l>:DELEte

This command deletes a limit line.

This command is an event and therefore has no *RST value and no query.

Suffix:

<t> 1..n

<l> 1..n

Example: `CALC:LIM2:DEL`
 Deletes the second limit line.

CALCulate<t>:LIMit<l>:FAIL?

This command queries the result of a limit check.

To get a valid result, you have to perform a complete sweep with synchronization to the sweep end before reading out the result. This is only possible in single sweep mode.

Suffix:

<t> 1..n

<l> 1..n

Example: `INIT;*WAI`
`CALC:LIM1:FAIL?`
 Performs a measurement and queries the result of the check for limit line 1.
 Return value: 0 for pass and 1 for fail.

Usage: Query only

CALCulate<t>:LIMit:STATe <State>

This command turns a limit check on and off.

You can query the result of the limit check with [CALCulate<t>:LIMit<l>:FAIL?](#) on page 372.

Suffix:

<t> 1..n

Parameters:

<State> ON | OFF

*RST: OFF

Example: `CALC:LIM1:STAT ON`
Switches on the limit check for limit line 1.

CALCulate<t>:LIMit<l>:UNIT:X?

This command queries the horizontal unit of a limit line.

This command is a query and therefore has no *RST value.

Suffix:

<t> 1..n

<l> 1..n

Example: `CALC:LIM1:UNIT:X?`
Queries the x-unit of the first limit line.

Usage: Query only

CALCulate<t>:LIMit<l>:UNIT[:Y]?

This command queries the vertical unit of a limit line.

This command is a query and therefore has no *RST value.

Suffix:

<t> 1..n

<l> 1..n

Example: `CALC:LIM1:UNIT?`
Queries the y-unit of the first limit line.

Usage: Query only

CALCulate<t>:LIMit<l>:LOWer:SElect <LimitLine>

This command selects the lower limit line.

This command is an event and therefore has no *RST value and no query.

Suffix:

<t> 1..n

<l> 1..n

Parameters:

<LimitLine> String containing the filename of the lower limit line.

Example: `CALC:LIM1:LOW:SEL 'GSM_Lower.rellim'`
Selects the lower limit line.

Usage: Setting only

CALCulate<t>:LIMit<l>:UPPer:SElect <LimitLine>

This command selects the upper limit line.

This command is an event and therefore has no *RST value and no query.

Suffix:

<t> 1..n

<l> 1..n

Parameters:

<LimitLine> String containing the filename of the upper limit line.

Example:

CALC:LIM1:UPP:SEL 'GSM_Upper.rellim'

Selects the upper limit line.

Usage:

Setting only

CALCulate<t>:LIMit<l>:LOWer:THReshold <Threshold>

This command defines the level of a lower threshold limit line.

Suffix:

<t> 1..n

<l> 1..n

Parameters:

<Threshold> Numeric value whose unit depends on the unit you have currently selected for the vertical axis.

Default unit: dBm

Example:

CALC:LIM1:LOW:THR -10DBM

Defines a threshold of -10 dBm.

CALCulate<t>:LIMit<l>:UPPer:THReshold <Threshold>

This command defines the level of an upper threshold limit line.

Suffix:

<t> 1..n

<l> 1..n

Parameters:

<Threshold> Numeric value whose unit depends on the unit you have currently selected for the vertical axis.

Default unit: dBm

Example:

CALC:LIM1:UPP:THR -10DBM

Defines a threshold of -10 dBm.

14.6.2.9 Configuring and using measurement functions

The R&S Spectrum Rider provides measurement functions that allow you to perform advanced measurements and can also be controlled remotely.

• Configuring channel tables	375
• Power measurements	377
• Measuring the channel power	381
• EIRP measurement	383
• Measuring the occupied bandwidth	385
• TDMA measurements	387
• Measuring the adjacent channel leakage ratio	387
• Measuring the harmonic distortion	399
• Measuring the AM modulation depth	402
• Measuring the spectrum emission mask	402
• Measuring the spectrogram	404
• Using an isotropic antenna	404

Configuring channel tables

The following commands configure the channel tables.

List of commands

[SENSe:]CHANnel<1...3>	375
[SENSe:]CHANnel:TABLE:SElect<1...4>	375
[SENSe:]CHANnel:TABLE:SElect:DOWNlink	376
[SENSe:]CHANnel:TABLE:SElect:UPLink	376
[SENSe:]CHANnel:TABLE:SET	377

[SENSe:]CHANnel<1...3> <ChannelNumber>

This command selects the channel to be analyzed.

You have to set the frequency mode with [\[SENSe:\]FREquency:INPut:MODE](#) on page 334 to channel first.

The numeric suffix at CHANnel is irrelevant for this command.

Parameters:

<ChannelNumber> Numeric value that selects the number of the channel to be analyzed.

*RST: Depends on the channel table.

Example: See [\[SENSe:\]CHANnel:TABLE:SElect<1...4>](#) on page 375.

[SENSe:]CHANnel:TABLE:SElect<1...4> <ChannelTable>

This command selects a channel table configured for the link direction you have selected with [\[SENSe:\]CHANnel:TABLE:SET](#) on page 377.

Note that if you have previously selected a channel table with `[SENSe:]CHANnel:TABLE:SElect:DOWNlink` on page 376 or `[SENSe:]CHANnel:TABLE:SElect:UPLink` on page 376, this command replaces that file.

The numeric suffix at SElect is irrelevant for this command.

Suffix:

<1...4> 1...4

Parameters:

<ChannelTable> String containing the filename of the channel table.

*RST: ''

Example:

```
CHAN:TABL:SET UP
```

Selects channel table selection for uplink signals.

```
CHAN:TABL:SEL 'TV China.CHNTAB'
```

Loads the channel table with the name 'TV China' for the uplink.

```
CHAN:TABL:SEL 'TV Italy.chntab'
```

or

```
CHAN:TABL:SEL:UPL 'TV Italy.chntab'
```

Both commands replace the uplink channel table 'TV China' with 'TV Italy'.

Downlink channel tables are not affected by the commands sent so far.

```
FREQ:INP:MODE CHAN
```

```
CHAN 10
```

Select a particular uplink channel (e.g. #10) instead of a (center) frequency.

To select an additional downlink channel table, use either:

```
CHAN:TABL:SET DOWN
```

```
CHAN:TABL:SEL 'TV Italy.chntab'
```

or

```
CHAN:TABL:SEL:DOWN 'TV Italy.chntab'
```

[SENSe:]CHANnel:TABLE:SElect:DOWNlink <ChannelTable>

This command selects a channel table configured for downlink signals.

Parameters:

<ChannelTable> String containing the name of the channel table.

*RST: ''

Example:

See `[SENSe:]CHANnel:TABLE:SElect<1...4>` on page 375.

[SENSe:]CHANnel:TABLE:SElect:UPLink <ChannelTable>

This command selects a channel table configured for downlink signals.

Parameters:

<ChannelTable> String containing the name of the channel table.
 *RST: ''

Example:

See [SENSe:]CHANnel:TABLE:SElect<1...4>
 on page 375.

[SENSe:]CHANnel:TABLE:SET <Table>

This command selects the link direction for measurements with channel tables.

Parameters:

<Table> UP | DOWN
UP
 Selects the uplink.
DOWN
 Selects the downlink.
 *RST: UP

Example:

See [SENSe:]CHANnel:TABLE:SElect<1...4>
 on page 375.

Power measurements

The following commands configure power measurements. To perform the actual measurement, use the commands described in section [Chapter 14.6.2.5, "Performing and triggering measurements"](#), on page 345.

The suffix <m> selects the marker. It is in the range of <1..6>.

The suffix <t> is irrelevant.

List of commands

CALCulate<t>:MARKer<m>:FUNCTION:LEVEL:ONCE.....	377
CALCulate<t>:MARKer<m>:FUNCTION:POWER:PRESet.....	378
CALCulate<t>:MARKer<m>:FUNCTION:POWER:PRESet:CHECK?.....	378
CALCulate<t>:MARKer<m>:FUNCTION:POWER:RESult?.....	379
CALCulate<t>:MARKer<m>:FUNCTION:POWER:SElect.....	380
CALCulate<t>:MARKer<m>:FUNCTION:POWER[:STATE].....	381

CALCulate<t>:MARKer<m>:FUNCTION:LEVEL:ONCE

This command adjusts the reference level to the measured signal power.

This automatic routine makes sure that the signal power level does not overload the R&S Spectrum Rider or limits the dynamic range by too small an S/N ratio.

To determine the best reference level, the R&S Spectrum Rider aborts current measurements and performs a series of test sweeps. After it has finished the test, it continues with the actual measurement.

This command is an event and therefore has no *RST value and no query.

Suffix:
 <t> 1..n
 <m> 1..n

Example: CALC:MARK:FUNC:LEV:ONCE
 Initiates an automatic level adjust routine.

Usage: Event

CALCulate<t>:MARKer<m>:FUNCTion:POWer:PRESet <Standard>

This command selects one of the predefined configurations for a telecommunications standard. This command only works if you have turned on power measurements with [CALCulate<t>:MARKer<m>:FUNCTion:POWer\[:STATe\]](#) on page 381.

The configuration for a standard is in line with the specifications and includes parameters like weighting filter, channel bandwidth and spacing, resolution and video bandwidth, as well as detector and sweep time.

Suffix:
 <t> 1..n
 <m> 1..n

Parameters:
 <Standard> String containing the filename of the standard.

Example: CALC:MARK:FUNC:POW:PRES '3GPP WCDMA.chpstd'
 Selects the 3GPP WCDMA standard for channel power measurements.

Usage: Setting only

CALCulate<t>:MARKer<m>:FUNCTion:POWer:PRESet:CHECK?

This command checks if the current settings are in line with the settings defined by the standard selected with [CALCulate<t>:MARKer<m>:FUNCTion:POWer:PRESet](#) on page 378.

Note that the command only checks those parameters that are defined by the standard.

This command is a query and therefore has no *RST value.

Return Value	
0	The R&S Spectrum Rider settings violate a standard configuration
1	The R&S Spectrum Rider settings comply with the standard.

Suffix:
 <t> 1..n

<m> 1..n

Example: `CALC:MARK:FUNC:POW:PRES:CHEC?`
Queries compliance to the standard currently in use.

Usage: Query only

CALCulate<t>:MARKer<m>:FUNCTION:POWer:RESult? <arg0>

This command queries the results of power measurements.

To get a valid result, you have to perform a complete sweep with synchronization to the sweep end before reading out the result. This is only possible in single sweep mode.

Before you can use this command, you have to select the power measurement with [CALCulate<t>:MARKer<m>:FUNCTION:POWer:SElect](#) on page 380 and [CALCulate<t>:MARKer<m>:FUNCTION:POWer\[:STATe\]](#) on page 381.

This command is a query and therefore has no *RST value.

Suffix:

<t> 1..n

<m> 1..n

Parameters:

<arg0> MCACpower | ACPower | CPOWer | EIRPpower | OBANdwidth | OBWidth | TDMA

MCACpower | ACPower

Returns the results for ACLR measurements.

The number of return values depends on the number of TX and adjacent channel. The order of return values is:

- power of the transmission channel.
- power of the lower adjacent channel.
- power of the upper adjacent channel.
- power of the lower alternate channel 1.
- power of the upper alternate channel 2.
- etc.

The unit of the return values depends on the scaling of the vertical axis:

logarithmic scaling returns the power in the currently selected unit (see [UNIT<t>:POWer](#) on page 341).

linear scaling returns the power in W.

CPOWer

Returns the results for channel power measurements.

The return value is the power of the channel. The unit depends on the scaling of the vertical axis:

logarithmic scaling returns the power in the currently selected unit (see [UNIT<t>:POWer](#) on page 341).

linear scaling returns the power in W.

EIRP

Returns the results for effective isotropic radiated power measurements.

The return value is the power of EIRP measurement. The unit depends on the scaling of the vertical axis: logarithmic scaling returns the power in the currently selected unit (see [UNIT<t>:POWer](#) on page 341).

OBANdwidth | OBWidth

Returns the results for measurements of the occupied bandwidth.

The return value is the occupied bandwidth in Hz.

TDMA

Returns the results for TDMA power measurements.

The return value is the power of the signal. The unit depends on the scaling of the vertical axis:

logarithmic scaling returns the power in the currently selected unit (see [UNIT<t>:POWer](#) on page 341).

linear scaling returns the power in W.

Example:

```
POW:BAND 90PCT
```

Defines the occupied bandwidth (90%).

```
INIT:CONT OFF
```

```
INIT;*WAI
```

```
CALC:MARK:FUNC:POW:RES? OBW
```

Turns on single sweep mode, performs a measurement and queries the results.

Usage:

Query only

CALCulate<t>:MARKer<m>:FUNction:POWer:SElect <MeasType>

This command selects a power measurement and turns the measurement on.

Suffix:

<t> 1..n

<m> 1..n

Parameters:

<MeasType> MCACpower | ACPower | CPOWer | EIRPpower | OBANdwidth | OBWidth | TDMA

MCACpower | ACPower

Adjacent Channel Leakage Ratio measurement (ACLR) aka adjacent channel power or multi carrier adjacent channel.

CPOWer

Chanel power measurement.

EIRPpower

Effective Isotropic Radiated Power measurement.

OBANdwidth | OBWidth

Occupied Bandwidth measurement.

TDMA

TDMA power measurement.

Example: `CALC:MARK:FUNC:POW:SEL CPOW`
Selects the channel power measurement.

CALCulate<t>:MARKer<m>:FUNction:POWer[:STATe] <State>

This command turns a power measurement on and off.

You can select a power measurement with `CALCulate<t>:MARKer<m>:FUNction:POWer:SElect` on page 380.

Suffix:

<t> 1..n
<m> 1..n

Parameters:

<State> ON | OFF
ON
Turns the power measurement on.
OFF
Performs a basic spectrum measurement.
***RST: OFF**

Example: `CALC:MARK:FUNC:POW OFF`
Switches off the power measurement.

Measuring the channel power

The following commands configure channel power measurements. To perform the actual measurement, use the commands described in section [Chapter 14.6.2.5, "Performing and triggering measurements"](#), on page 345.

The suffix <m> selects the marker. It is in the range of <1..6>.

The suffix <t> is irrelevant.

List of commands

<code>CALCulate<t>:MARKer<m>:FUNction:CPOWer:BANDwidth</code>	381
<code>CALCulate<t>:MARKer<m>:FUNction:CPOWer:MODE</code>	382
<code>CALCulate<t>:MARKer<m>:FUNction:CPOWer:UNIT</code>	382
<code>CALCulate<t>:MARKer<m>:FUNction:POWer:RESult:PHZ</code>	382

CALCulate<t>:MARKer<m>:FUNction:CPOWer:BANDwidth <ChannelBW>

This command defines the channel bandwidth for channel power measurements.

Suffix:

<t> 1..n
<m> 1..n

Parameters:

<ChannelBW> *RST: 3.84 MHz
Default unit: GHz

Example:

CALC:MARK:FUNC:CPOW:BAND 4 MHZ

Sets the channel bandwidth to 4 MHz.

CALCulate<t>:MARKer<m>:FUNCTion:CPOWer:MODE <DisplayMode>

This command selects the display mode for channel power measurements.

Suffix:

<t> 1..n

<m> 1..n

Parameters:

<DisplayMode> CLR | MAX

CLR

Displays the currently measured value (Clear / Write).

MAX

Displays the highest measured value (Max Hold).

*RST: CLR

Example:

CALC:MARK:FUNC:CPOW:MODE CLR

Selects clear/write power display mode.

CALCulate<t>:MARKer<m>:FUNCTion:CPOWer:UNIT <Unit>

This command selects the unit of the vertical axis for channel power measurements.

Suffix:

<t> 1..n

<m> 1..n

Parameters:

<Unit> DBM | DBMV | DBUV | DUVE | DMVE | VEMF | DBUA | VOLT |
WATT | DUVM | DUAM | V | W | V_M | W_M2

*RST: dBm

Example:

CALC:MARK:FUNC:CPOW:UNIT DBM

Sets the unit to dBm.

CALCulate<t>:MARKer<m>:FUNCTion:POWer:RESult:PHZ <State>

This command turns the display of the channel power per Hertz on and off.

Suffix:

<t> 1..n

<m> 1..n

Parameters:

<State> ON | OFF
 *RST: dBm

Example:

CALC:MARK:FUNC:POW:RES:PHZ ON
 Displays the measured Channel Power / Hz.

EIRP measurement

This chapter describes all commands available to make an EIRP measurement.

The suffix <t> is irrelevant.

List of commands

[SENSe:]EIRPpower:CLOsS.....	383
[SENSe:]EIRPpower:DISTance.....	383
[SENSe:]EIRPpower:MAXHold?.....	384
[SENSe:]EIRPpower:PLOsS?.....	384
[SENSe:]EIRPpower:POWer?.....	384
[SENSe:]EIRPpower:RAGain.....	384
[SENSe:]EIRPpower:SUM?.....	384
DISPlay<t>:EIRP:HORizontal.....	385
DISPlay<t>:EIRP:MAXHold:RESet.....	385
DISPlay<t>:EIRP:VERTical.....	385

[SENSe:]EIRPpower:CLOsS <EIRPCableLoss>

This command input cable loss value in dB and value is displayed on the EIRP info bar.

Parameters:

<EIRPCableLoss> Numeric value that defines the cable loss.
 Default unit: dB

Example:

EIRP:CLOs 0
 Cable loss of 0.00 dB is displayed on the EIRP info bar.

[SENSe:]EIRPpower:DISTance <EIRPDistance>

This command input parameter distance in meter or feet and value is displayed on the EIRP info bar.

Parameters:

<EIRPDistance> Numeric value that defines the distance.
 Default unit: m

Example:

EIRP:DIST 0.95
 Distance of 950 mm is displayed on the EIRP info bar.

[SENSe:]EIRPpower:MAXHold?

This command queries the maximum hold value of the EIRP measurements.

Usage: Query only

[SENSe:]EIRPpower:PLOs?

This command queries the free space path loss calculation.

$FSPL_{dB}$

$$= 10 \log_{10} ((4\pi df / c)^2)$$

$$= 20 \log_{10} (d) + 20 \log_{10} (f) + 20 \log_{10} (4\pi/c)$$

$$= 20 \log_{10} (d) + 20 \log_{10} (f) - 147.55$$

Example: `EIRP:PLOs? -> 38.00`
Return the free space path loss of 38.00 dB.

Usage: Query only

[SENSe:]EIRPpower:POWer?

This command queries the EIRP power measurement.

$EIRP_{dB} = \text{Measured channel power (excluding antenna gain and cable loss)} - \text{received antenna gain} + \text{received cable loss} + FSPL_{dB}$

Example: `EIRP:POW? -> -39.35`
Return the EIRP power measurement of -39.35 dB.

Usage: Query only

[SENSe:]EIRPpower:RAGain <EIRPAntennaGain>

This command input antenna gain value in dB and value is displayed in dBi on the EIRP info bar.

Parameters:

<EIRPAntennaGain> Numeric value that defines the antenna gain.

Default unit: dB

[SENSe:]EIRPpower:SUM?

Return the sum of EIRP power (dBm) for horizontal and vertical of the dual polarization measurement.

Usage: Query only

DISPlay<t>:EIRP:HORizontal

This command displays the ERIP power of the horizontal polarization.

Suffix:

<t> 1..n

Usage: Event

DISPlay<t>:EIRP:MAXHold:RESet

This command performs a reset on the maximum hold function.

Suffix:

<t> 1..n

Example: Display:EIRP:MAXH:RES

Usage: Event

DISPlay<t>:EIRP:VERTical

This command displays the ERIP power of the vertical polarization.

Suffix:

<t> 1..n

Usage: Event

Measuring the occupied bandwidth

The following commands configure the measurement of the Occupied Bandwidth. To perform the actual measurement, use the commands described in section [Chapter 14.6.2.5, "Performing and triggering measurements"](#), on page 345.

The suffix <m> selects the marker. It is in the range of <1..6>.

The suffix <t> is irrelevant.

List of commands

CALCulate<t>:MARKer<m>:FUNCTion:OBAN:BANDwidth	385
CALCulate<t>:MARKer<m>:FUNCTion:OBAN:BANDwidth:PCT	386
CALCulate<t>:MARKer<m>:FUNCTion:OBW:BANDwidth	386
CALCulate<t>:MARKer<m>:FUNCTion:OBW:BANDwidth:PCT	386

CALCulate<t>:MARKer<m>:FUNCTion:OBAN:BANDwidth <ChannelBW>

This command defines the channel bandwidth for occupied bandwidth measurements.

Instead of OBANwidth, you can also use the alias OBWidth.

Suffix:

<t> 1..n

<m> 1..n

Parameters:

<ChannelBW> *RST: 3.84 MHz
Default unit: GHz

Example:

CALC:MARK:FUNC:OBW:BAND 1 MHZ
Sets the channel bandwidth to 1 MHz.

CALCulate<t>:MARKer<m>:FUNCtion:OBAN:BANDwidth:PCT <Percentage>

This command defines the percentage of the total power that defines the occupied bandwidth.

Instead of OBANwidth, you can also use the alias OBWidth.

Suffix:

<t> 1..n

<m> 1..n

Parameters:

<Percentage> Range: 10 PCT to 99.9 PCT
*RST: 99 PCT

Example:

CALC:MARK:FUNC:OBW:BAND:PCT 95
Sets the power percentage to 95%.

CALCulate<t>:MARKer<m>:FUNCtion:OBW:BANDwidth <ChannelBW>

This command defines the channel bandwidth for occupied bandwidth measurements.

Instead of OBANwidth, you can also use the alias OBWidth

Suffix:

<t> 1..n

<m> 1..n

Parameters:

<ChannelBW> Numeric value in Hz.
Default unit: GHz

Example:

CALC:MARK:FUNC:OBW:BAND 1 MHZ
Sets the channel bandwidth to 1 MHz

CALCulate<t>:MARKer<m>:FUNCtion:OBW:BANDwidth:PCT <Percentage>

This command defines the percentage of the total power that defines the occupied bandwidth.

Instead of OBANwidth, you can also use the alias OBWidth

Suffix:

<t> 1..n

<m> 1..n

Parameters:

<Percentage> The numeric suffix at CALCulate is irrelevant for this command.

Example:

CALC:MARK:FUNC:OBW:BAND:PCT 95
Sets the power percentage to 95%.

TDMA measurements

The following commands configure TDMA measurements. To perform the actual measurement, use the commands described in section [Chapter 14.6.2.5, "Performing and triggering measurements"](#), on page 345.

The suffix <m> selects the marker. It is in the range of <1..6>.

The suffix <t> is irrelevant.

List of commands

CALCulate<t>:MARKer<m>:FUNction:TDMA:BURSt..... 387

CALCulate<t>:MARKer<m>:FUNction:TDMA:BURSt <BurstLength>

This command defines the burst length of the TDMA signal.

Suffix:

<t> 1..n

<m> 1..n

Parameters:

<BurstLength> Range: Depends on the current sweep time.
*RST: 470 us
Default unit: s

Example:

CALC:MARK:FUNC:TDMA:BURS 80 US
Sets the burst length to 80 us.

Measuring the adjacent channel leakage ratio

The following commands configure Adjacent Channel Leakage Ratio (ACLR) measurements. To perform the actual measurement, use the commands described in section [Chapter 14.6.2.5, "Performing and triggering measurements"](#), on page 345.

- [Configuring and performing the ACLR measurement](#)..... 387
- [ACLR limit check](#)..... 394
- [ACLR result query](#)..... 399

Configuring and performing the ACLR measurement

The following commands configure and perform the ACLR measurements.

The suffix <m> selects the marker. It is in the range of <1..6>.

The suffix <t> is irrelevant.

List of commands

CALCulate<t>:MARKer<m>:FUNCTION:ACPower:UNIT	388
[SENSe:]POWer:ACHannel:ACPairs	388
[SENSe:]POWer:ACHannel:BANDwidth[:CHANnel]	389
[SENSe:]POWer:ACHannel:BANDwidth[:ACHannel]	389
[SENSe:]POWer:ACHannel:BANDwidth[:ALternate<1...11>]	389
[SENSe:]POWer:ACHannel:BWIDth[:CHANnel]	389
[SENSe:]POWer:ACHannel:BWIDth:ACHannel	390
[SENSe:]POWer:ACHannel:BWIDth:ALternate<1...11>	390
[SENSe:]POWer:ACHannel:MODE	390
[SENSe:]POWer:ACHannel:PRESet:RLEVel	391
[SENSe:]POWer:ACHannel:REFerence:TXCHannel:AUTO	391
[SENSe:]POWer:ACHannel:REFerence:TXCHannel:MANual	392
[SENSe:]POWer:ACHannel:SPACing[:ACHannel]	392
[SENSe:]POWer:ACHannel:SPACing:ALternate<1...11>	392
[SENSe:]POWer:ACHannel:SPACing:CHANnel<1...11>	393
[SENSe:]POWer:ACHannel:TXCHannel:COUNT	393

CALCulate<t>:MARKer<m>:FUNCTION:ACPower:UNIT <Unit>

This command selects the unit of the ACLR results.

Suffix:

<t> 1..n

<m> 1..n

Parameters:

<Unit> DBM | DBMV | DBUV | DBUA | VOLT | WATT | DUVM | DUAM |
V | W | V_M | W_M2
*RST: 1

Example:

CALC:MARK:FUNC:ACP:UNIT DBM ACLR
Results are converted into the unit dBm.

[SENSe:]POWer:ACHannel:ACPairs <#ofAdjacentChannels>

This command defines the number of pairs of adjacent channels.

Parameters:

<#ofAdjCh> The number corresponds to a pair of adjacent channels, one channel on the left and one on the right of the transmission channel.

Range: 1 to 12

*RST: 1

Example:

See [\[SENSe:\]POWer:ACHannel:TXCHannel:COUNT](#) on page 393.

[SENSe:]POWer:ACHannel:BANDwidth[:CHANnel] <TxChannelBandwidth>

This command defines the channel bandwidth of the transmission channels.

Instead of BANDwidth, you can also use the alias BWIDth.

Parameters:

<TxChBw> *RST: 14 kHz
 Default unit: GHz

Example: See [\[SENSe:\]POWer:ACHannel:TXChannel:COUNT](#)
 on page 393.

[SENSe:]POWer:ACHannel:BANDwidth[:ACHannel] <AdjChannelBandwidth>

This command defines the channel bandwidth of the adjacent channel.

The adjacent channel is the first pair of channels next to the transmission channels. If you set the channel bandwidth for these channels, the R&S Spectrum Rider sets the bandwidth of the alternate channels to the same value.

Instead of BANDwidth, you can also use the alias BWIDth.

Parameters:

<AdjChBw> *RST: 14 kHz
 Default unit: GHz

Example: See [\[SENSe:\]POWer:ACHannel:TXChannel:COUNT](#)
 on page 393.

**[SENSe:]POWer:ACHannel:BANDwidth[:ALTErnate<1...11>]
 <AltChannelBandwidth>**

This command defines the bandwidth of the alternate channels.

If you set the channel bandwidth for the first alternate channel, the R&S Spectrum Rider sets the bandwidth of the other alternate channels to the same value. The command works hierarchically: to set a bandwidth of the 10th and 8th channel, you have to set the bandwidth of the 8th channel first.

Instead of BANDwidth, you can also use the alias BWIDth.

The suffix at ALTErnate selects one of the 11 alternate channels.

Parameters:

<AltChBw> *RST: 14 kHz
 Default unit: GHz

Example: See [\[SENSe:\]POWer:ACHannel:TXChannel:COUNT](#)
 on page 393.

[SENSe:]POWer:ACHannel:BWIDth[:CHANnel] <TxChannelBandwidth>

This command defines the channel bandwidth of the transmission channels.

Instead of BWIDwidth, you can also use the alias BANDth.

Parameters:

<TxChBw> *RST: 14 kHz
Default unit: GHz

Example:

See [SENSe:]POWer:ACHannel:TXCHannel:COUNT on page 393.

[SENSe:]POWer:ACHannel:BWIDth:ACHannel <AdjChannelBandwidth>

This command defines the channel bandwidth of the adjacent channel.

The adjacent channel is the first pair of channels next to the transmission channels. If you set the channel bandwidth for these channels, the R&S Spectrum Rider sets the bandwidth of the alternate channels to the same value.

Instead of BWIDwidth, you can also use the alias BANDth.

Parameters:

<AdjChBw> *RST: 14 kHz
Default unit: GHz

Example:

See [SENSe:]POWer:ACHannel:TXCHannel:COUNT on page 393.

[SENSe:]POWer:ACHannel:BWIDth:ALternate<1...11> <AltChannelBandwidth>

This command defines the bandwidth of the alternate channels.

If you set the channel bandwidth for the first alternate channel, the R&S Spectrum Rider sets the bandwidth of the other alternate channels to the same value. The command works hierarchically: to set a bandwidth of the 10th and 8th channel, you have to set the bandwidth of the 8th channel first.

Instead of BWIDwidth, you can also use the alias BANDth.

The suffix at ALternate selects one of the 11 alternate channels.

Suffix:

<1...11> 1...11

Parameters:

<AltChBw> *RST: 14 kHz
Default unit: GHz

Example:

See [SENSe:]POWer:ACHannel:TXCHannel:COUNT on page 393.

[SENSe:]POWer:ACHannel:MODE <AdjacentChannelMode>

This command selects the way the R&S Spectrum Rider displays the power of adjacent channels.

The number of adjacent and alternate channels has to be greater than 0 for the command to work.

Parameters:

<AdjChMode> ABSolute | RELative

ABSolute

Shows the absolute power of all channels.

RELative

Shows the power of adjacent and alternate channels in relation to the transmission channel.

Example:

POW:ACH:MODE ABS

Shows absolute powers for all channels.

[SENSe:]POWer:ACHannel:PRESet:RLEVel

This command adjusts the reference level to the measured signal power.

This automatic routine makes sure that the signal power level does not overload the R&S Spectrum Rider or limit the dynamic range by too small a S/N ratio.

To determine the best reference level, the R&S Spectrum Rider aborts current measurements and performs a series of test sweeps. After it has finished the test, it continues with the actual measurement.

This command is an event and therefore has no *RST value and no query.

Example:

POW:ACH:PRESet:RLEV

Initiates an ACP measurement and adjusts the reference level.

Usage:

Event

[SENSe:]POWer:ACHannel:REFerence:TXCHannel:AUTO <TxReferenceMode>

This command automatically selects a reference channel for relative ACLR measurements.

The number of transmission channels and adjacent / alternate channels has to be greater than 0 for the command to work.

Parameters:

<TxReferenceMode> MANual | MINimum | MAXimum | LHIGHest

MANual

Defines a reference channel for relative ACLR measurements. You need at least one channel for the command to work.

MINimum

Reference is the transmission channel with the lowest power.

MAXimum

Reference is the transmission channel with the highest power.

LHIGhest

Reference is the lowest transmission channel for lower adjacent channels and highest transmission channel for upper adjacent channels.

Example:

```
POW:ACH:REF:TXCH:AUTO MIN
```

Sets the TX channel with the lowest power as reference channel.

[SENSe:]POWer:ACHannel:REFerence:TXCHannel:MANual
 <TxReferenceChannel>

This command defines a reference channel for relative ACLR measurements.

The number of transmission channels and adjacent / alternate channels has to be greater than 0 for the command to work.

Parameters:

<TxRefCh> The actual value range depends on the number of active transmission channels.

Range: 1 to 12

*RST: 1

Example:

See [\[SENSe:\]POWer:ACHannel:TXCHannel:COUNT](#) on page 393.

[SENSe:]POWer:ACHannel:SPACing[:ACHannel] <AdjChannelSpacing>

This command defines the spacing between the transmission channel and its adjacent channel.

A change of the adjacent channel spacing causes a change in the spacing of all alternate channels above the adjacent channel.

Parameters:

<AdjChannelSpacing>*RST: 14 kHz

Default unit: GHz

Example:

See [\[SENSe:\]POWer:ACHannel:TXCHannel:COUNT](#) on page 393.

[SENSe:]POWer:ACHannel:SPACing:ALTerNate<1...11> <AltChannelSpacing>

This command defines the spacing between alternate channels.

If you set the channel spacing for the first alternate channel, the R&S Spectrum Rider sets the bandwidth of the other alternate channels to the same value. The command works hierarchically: to set a spacing of the 10th and 8th channel, you have to set the spacing of the 8th channel first.

The suffix at ALTerNate selects one of the 11 alternate channels.

Parameters:

<AltChannelSpacing> *RST: ALT1: 40 kHz; ALT2: 60 kHz; ALT3: 80 kHz etc.
Default unit: GHz

Example:

See [\[SENSe:\]POWer:ACHannel:TXChannel:COUNT](#)
on page 393.

[SENSe:]POWer:ACHannel:SPACing:CHANnel<1...11> <TxChannelSpacing>

This command defines the spacing between transmission channels.

If you set the channel spacing for the first transmission channel, the R&S Spectrum Rider sets the bandwidth of the other transmission channels to the same value. The command works hierarchically: to set a spacing between the 9th and 10th and 8th and 9th channel, you have to set the spacing between the 8th and 9th channel first.

The suffix at CHANnel selects the transmission channel.

Parameters:

<TxChannelSpacing> *RST: 20 kHz
Default unit: GHz

Example:

See [\[SENSe:\]POWer:ACHannel:TXChannel:COUNT](#)
on page 393.

[SENSe:]POWer:ACHannel:TXChannel:COUNT <#ofTxChannels>

This command defines the number of transmission channels.

The command is available for measurements with span > 0.

Parameters:

<#ofTxChannels> Range: 1 to 12
*RST: 1

Example:

```
CALC:MARK:FUNC:POW:SEL CPOW
Selects the channel power measurement.
POW:ACH:TXCH:COUN 2
Defines 2 transmission channels.
POW:ACH:ACP 2
Defines 2 pairs of neighboring channels to the left and right of
the TX channel(s).
POW:ACH:SPAC:CHAN2 20KHZ
Defines a distance of 20 kHz between the first and the second
Tx channel.
POW:ACH:BAND:CHAN2 120KHZ
Defines a bandwidth of 120 kHz for the second TX channel.
POW:ACH:REF:TXCH:MAN 2
Selects the second Tx channel as reference channel.
POW:ACH:SPAC 10KHZ
Defines a distance of 10 kHz from the TX channel to the adja-
cent channel.
POW:ACH:BAND:ACH 120KHZ
Defines a bandwidth of 120 kHz for the adjacent channel.
POW:ACH:SPAC:ALT 20KHZ
Defines a distance of 20 kHz from the adjacent to the first alter-
nate channel.
POW:ACH:BAND:ALT 120KHZ
Defines a bandwidth of 120 kHz for the first alternate channel.
```

ACLR limit check

The following commands configure and perform limit checks when measuring the adjacent channel power.

The suffix <l> selects the limit line. It is in the range of <1..2>.

The suffix <t> is irrelevant.

List of commands

CALCulate<t>:LIMit<l>:ACPpower:STATe.....	394
CALCulate<t>:LIMit<l>:ACPpower:ACHannel[:RELative].....	395
CALCulate<t>:LIMit<l>:ACPpower:ACHannel[:RELative]:STATe.....	395
CALCulate<t>:LIMit<l>:ACPpower:ACHannel:ABSolute.....	396
CALCulate<t>:LIMit<l>:ACPpower:ACHannel:ABSolute[:STATe].....	396
CALCulate<t>:LIMit<l>:ACPpower:ACHannel:RESult?.....	396
CALCulate<t>:LIMit<l>:ACPpower:ALternate<1...11>[:RELative].....	397
CALCulate<t>:LIMit<l>:ACPpower:ALternate<1...11>[:RELative]:STATe.....	397
CALCulate<t>:LIMit<l>:ACPpower:ALternate<1...11>:ABSolute.....	398
CALCulate<t>:LIMit<l>:ACPpower:ALternate<1...11>:ABSolute[:STATe].....	398
CALCulate<t>:LIMit<l>:ACPpower:ALternate<1...11>:RESult?.....	398

CALCulate<t>:LIMit<l>:ACPpower:STATe <State>

This command turns the limit check for ACLR measurements on and off.

You have to use [CALCulate<t>:LIMit<l>:ACPpower:ACHannel\[:RELative\]:STATe](#) on page 395 or [CALCulate<t>:LIMit<l>:ACPpower:ALternate<1...11>\[:RELative\]:STATe](#) on page 397 in combination with this command to select the channels the limit check should be performed on.

Suffix:

<t> 1..n

<l> 1..n

Parameters:

<State> ON | OFF

*RST: OFF

Example:

CALC:LIM:ACP ON

Activates the limit check.

CALCulate<t>:LIMit<l>:ACPpower:ACHannel[:RELative] <RelativeLimit>

This command defines the relative limit of the adjacent channels. The reference value for the relative limit value is the measured channel power.

Note that the relative limit has no effect on the limit check if it is below the absolute limit value (see [CALCulate<t>:LIMit<l>:ACPpower:ACHannel:ABSolute](#) on page 396. This mechanism allows automatic checking of the absolute basic values of adjacent-channel power as defined in mobile radio standards.

Suffix:

<t> 1..n

<l> 1..n

Parameters:

<RelativeLimit> Range: 0 dB to 100 dB

Default unit: dB

Example:

CALC:LIM:ACP:ACH 30

Defines a limit of 30 dB.

CALCulate<t>:LIMit<l>:ACPpower:ACHannel[:RELative]:STATe <State>

This command turns the relative limit check for the adjacent channels on and off.

You have to activate the general ACLR limit check before using this command with [CALCulate<t>:LIMit<l>:ACPpower:STATe](#) on page 394

Suffix:

<t> 1..n

<l> 1..n

Parameters:

<State> ON | OFF

*RST: OFF

Example: `CALC:LIM:ACP:ACH:STAT ON`
Activates the relative limit check.

CALCulate<t>:LIMit<l>:ACPpower:ACHannel:ABSolute <AbsoluteLimit>

This command defines the absolute limit for the adjacent channels.

Note that the absolute limit has no effect on the limit check if it is below the relative limit (see [CALCulate<t>:LIMit<l>:ACPpower:ACHannel\[:RELative\]](#) on page 395). This mechanism allows automatic checking of the absolute basic values of adjacent-channel power as defined in mobile radio standards.

Suffix:

<t> 1..n

<l> 1..n

Parameters:

<AbsoluteLimit> Range: -500 to 500
Default unit: dBm

Example: `CALC:LIM:ACP:ACH:ABS -30`
Sets the absolute limit to -30 dBm.

CALCulate<t>:LIMit<l>:ACPpower:ACHannel:ABSolute[:STATe] <State>

This command turns the absolute limit check for the adjacent channel on and off.

You have to activate the general ACLR limit check before using this command with [CALCulate<t>:LIMit<l>:ACPpower:STATe](#) on page 394 first.

Suffix:

<t> 1..n

<l> 1..n

Parameters:

<State> ON | OFF
*RST: OFF

Example: `CALC:LIM:ACP:ACH:ABS:STAT ON`
Activates the absolute limit check.

CALCulate<t>:LIMit<l>:ACPpower:ACHannel:RESult?

This command queries the result of the limit check of the adjacent channels.

To get a valid result, you have to perform a complete sweep with synchronization to the sweep end before reading out the result. This is only possible in single sweep mode.

This command is a query and therefore has no *RST value.

Suffix:

<t> 1..n

<|> 1..n

Example: `CALC:LIM:ACP:ACH:RES?`
Queries the limit check results. The command would return, e.g. `FAILED, FAILED` Upper and lower alternate channels violate a limit.

Usage: Query only

CALCulate<t>:LIMit<l>:ACPpower:ALTernate<1...11>[:RELative] <RelativeLimit>

This command defines the relative limit of the alternate channels. The reference value for the relative limit value is the measured channel power.

Note that the relative limit has no effect on the limit check if it is below the absolute limit value (see [CALCulate<t>:LIMit<l>:ACPpower:ALTernate<1...11>:ABSolute](#) on page 398). This mechanism allows automatic checking of the absolute basic values of adjacent-channel power as defined in mobile radio standards.

The suffix at ALTernate selects one of the 11 alternate channels.

Suffix:

<t> 1..n

<l> 1..n

<1...11> 1...11

Parameters:

<RelativeLimit> Range: -500 dB to 500 dB
Default unit: dB

Example: `CALC:LIM:ACP:ALT3 30`
Defines a limit of 30 dB for the third alternate channel.

CALCulate<t>:LIMit<l>:ACPpower:ALTernate<1...11>[:RELative]:STATe <State>

This command turns the relative limit check for alternate channels on and off.

You have to activate the general ACLR limit check before using this command with [CALCulate<t>:LIMit<l>:ACPpower:STATe](#) on page 394 first.

The suffix at ALTernate selects one of the 11 alternate channels.

Suffix:

<t> 1..n

<l> 1..n

<1...11> 1...11

Parameters:

<State> ON | OFF
*RST: OFF

Example: `CALC:LIM:ACP:ALT3:STAT ON`
Activates the relative limit check for the third alternate channel.

CALCulate<t>:LIMit<l>:ACPpower:ALternate<1...11>:ABSolute <AbsoluteLimit>

This command defines the absolute limit for the alternate channels.

Note that the absolute limit has no effect on the limit check if it is below the relative limit (see [CALCulate<t>:LIMit<l>:ACPpower:ALternate<1...11>\[:RELative\]](#) on page 397). This mechanism allows automatic checking of the absolute basic values of adjacent-channel power as defined in mobile radio standards.

The suffix at ALternate selects one of the 11 alternate channels.

Suffix:

<t>	1..n
<l>	1..n
<1...11>	1...11

Parameters:

<AbsoluteLimit>	Range: -500 to 500 Default unit: dBm
-----------------	---

Example:

```
CALC:LIM:ACP:ALT3:ABS -30
```

Sets the absolute limit to -30 dBm for the third alternate channel.

CALCulate<t>:LIMit<l>:ACPpower:ALternate<1...11>:ABSolute[:STATe] <State>

This command turns the absolute limit check for an alternate channel on and off.

You have to activate the general ACLR limit check before using this command with [CALCulate<t>:LIMit<l>:ACPpower:STATe](#) on page 394 first.

The suffix at ALternate selects one of the 11 alternate channels.

Suffix:

<t>	1..n
<l>	1..n
<1...11>	1...11

Parameters:

<State>	ON OFF
*RST:	OFF

Example:

```
CALC:LIM:ACP:ALT3:ABS:STAT ON
```

Activates the absolute limit check for the third alternate channel.

CALCulate<t>:LIMit<l>:ACPpower:ALternate<1...11>:RESult?

This command queries the result of the limit check of the alternate channels.

To get a valid result, you have to perform a complete sweep with synchronization to the sweep end before reading out the result. This is only possible in single sweep mode.

This command is a query and therefore has no *RST value.

The suffix at ALternate selects one of the 11 alternate channels.

Suffix:

<t>	1..n
<l>	1..n
<1...11>	1...11

Example:

CALC:LIM:ACP:ALT2:RES?

Queries the limit check results for the second alternate channels. The command would return, e.g. FAILED, FAILED Upper and lower alternate channels violate a limit.

Usage:

Query only

ACLR result query

The following commands query results specific to the adjacent channel power measurement.

The suffix <m> selects the marker. It is in the range of <1..6>.

The suffix <t> is irrelevant.

List of commands

CALCulate<t>:MARKer<m>:FUNction:TXPower:RESult?..... 399

CALCulate<t>:MARKer<m>:FUNction:TXPower:RESult?

This command queries the total TX channel power. Use [CALCulate<t>:MARKer<m>:FUNction:POWer:RESult?](#) on page 379 to query the power of each TX channel.

Suffix:

<t>	1..n
<m>	1..n

Example:

CALC:MARK:FUNC:TXP:RES?

Queries the total channel power over all TX channels.

Usage:

Query only

Measuring the harmonic distortion

The following commands configure Harmonic Distortion measurements.. To perform the actual measurement, use the commands described in section [Chapter 14.6.2.5, "Performing and triggering measurements"](#), on page 345.

The suffix <m> selects the marker. It is in the range of <1..6>.

The suffix <t> is irrelevant.

List of commands

CALCulate<t>:MARKer<m>:FUNCTion:HARMonics[:STATe]	400
CALCulate<t>:MARKer<m>:FUNCTion:HARMonics:DISTortion?	400
CALCulate<t>:MARKer<m>:FUNCTion:HARMonics:LIST?	400
CALCulate<t>:MARKer<m>:FUNCTion:HARMonics:NHARmonics	401
CALCulate<t>:MARKer<m>:FUNCTion:HARMonics:PRESet	401

CALCulate<t>:MARKer<m>:FUNCTion:HARMonics[:STATe] <State>

This command turns the harmonic distortion measurement on and off.

Suffix:

<t> 1..n

<m> 1..n

Parameters:

<State> ON | OFF

*RST: OFF

Example: See [CALCulate<t>:MARKer<m>:FUNCTion:HARMonics:PRESet](#) on page 401.

CALCulate<t>:MARKer<m>:FUNCTion:HARMonics:DISTortion? <ThdType>

This command queries the total harmonic distortion of the signal.

To get a valid result, you have to perform a complete sweep with synchronization to the sweep end before reading out the result. This is only possible in single sweep mode.

This command is a query and therefore has no *RST value.

Suffix:

<t> 1..n

<m> 1..n

Parameters:

<ThdType> TOTAL

<Distortion%>,<DistortiondB>

Pair of values, one showing the THD in %, one in dB.

Example: See [CALCulate<t>:MARKer<m>:FUNCTion:HARMonics:PRESet](#) on page 401.

Usage: Query only

CALCulate<t>:MARKer<m>:FUNCTion:HARMonics:LIST?

This command queries the position of the harmonics.

To get a valid result, you should perform a complete sweep in single sweep mode before querying the results.

This command is a query and therefore has no *RST value.

Suffix:

<t> 1..n

<m> 1..n

Example: See [CALCulate<t>:MARKer<m>:FUNCTION:HARMonics:PRESet](#) on page 401.

Usage: Query only

CALCulate<t>:MARKer<m>:FUNCTION:HARMonics:NHARmonics <NofHarmonics>

This command sets the number of harmonics. The valid range is from 1 to 6 harmonics.

Suffix:

<t> 1..n

<m> 1..n

Parameters:

<NofHarmonics> Range: 1 to 6
*RST: 2

Example: See [CALCulate<t>:MARKer<m>:FUNCTION:HARMonics:PRESet](#) on page 401.

CALCulate<t>:MARKer<m>:FUNCTION:HARMonics:PRESet

This command optimizes the settings for the harmonic distortion measurement.

This command is an event and therefore has no query and no *RST value.

Suffix:

<t> 1..n

<m> 1..n

Example:

CALC:MARK:FUNC:HARM ON

Activates the harmonic distortion measurement.

CALC:MARK:FUNC:HARM:NHAR 4

Sets the number of harmonics to 4.

CALC:MARK:FUNC:HARM:PRES

Adjusts the settings of the measurement.

CALC:MARK:FUNC:HARM:LIST?

CALC:MARK:FUNC:HARM:DIST? TOT

Queries the position of the harmonics and the total harmonic distortion.

Usage: Event

Measuring the AM modulation depth

The following commands configure AM Modulation Depth measurements. To perform the actual measurement, use the commands described in section [Chapter 14.6.2.5, "Performing and triggering measurements"](#), on page 345.

The suffix <m> selects the marker. It is in the range of <1..6>.

The suffix <t> is irrelevant.

List of commands

CALCulate<t>:MARKer<m>:FUNction:MDEPth[:STATe]	402
CALCulate<t>:MARKer<m>:FUNction:MDEPth:RESult?	402

CALCulate<t>:MARKer<m>:FUNction:MDEPth[:STATe] <State>

This command turns the AM Modulation Depth measurement on and off.

Suffix:

<t>	1..n
<m>	1..n

Parameters:

<State>	ON OFF
*RST:	OFF

Example: `CALC:MARK:FUNC:MDEP ON`
Activates the AM modulation depth measurement.

CALCulate<t>:MARKer<m>:FUNction:MDEPth:RESult?

This command queries the results of the AM modulation depth measurement.

Suffix:

<t>	1..n
<m>	1..n

Example: `CALC:MARK:FUNC:MDEP:RES?`
Queries the AM modulation depth.

Usage: Query only

Measuring the spectrum emission mask

The following commands configure Spectrum Emission Mask (SEM) measurements. To perform the actual measurement, use the commands described in section [Chapter 14.6.2.5, "Performing and triggering measurements"](#), on page 345.

The suffix <m> selects the marker. It is in the range of <1..6>.

The suffix <t> is irrelevant.

List of commands

- [CALCulate<t>:MARKer<m>:FUNCTION:TXPower:RESult?](#) on page 399

For a detailed description of the commands not described below, see "[ACLR result query](#)" on page 399 [Configuring the horizontal axis](#) in spectrum mode.

[SENSe:]ESpectrum:PRESet[:STANdard]	403
[SENSe:]ESpectrum:PRESet:SETTings	403
[SENSe:]SWEep:MODE	403

[SENSe:]ESpectrum:PRESet[:STANdard] <FileName>

This command loads one of the predefined spectrum emission masks for a telecommunications standard.

Parameters:

<FileName> String containing the filename of the spectrum emission mask.

Example:

```
ESP:PRES 'W-CDMA 3GPP.semstd'
```

Loads the SEM for 3GPP WCDMA.

[SENSe:]ESpectrum:PRESet:SETTings <ONCE>

This command optimizes the settings for the SEM measurement.

This command is an event and therefore has no query and no *RST value.

Parameters:

<ONCE> ONCE

Example:

```
ESP:PRES:SET ONCE
```

Initializes an adjustment of the settings.

Usage:

Setting only

[SENSe:]SWEep:MODE <SweepMode>

This command turns the spectrum emission mask measurement on and off.

Parameters:

<SweepMode> LIST | ESpectrum | AUTO

LIST

Turns on the Spurious Emission measurement.

ESpectrum

Turns on the SEM measurement.

AUTO

Turns on the Spectrum mode.

*RST: AUTO

Example:

```
SWE:MODE ESP
```

Starts the SEM measurement.

Measuring the spectrogram

This chapter describes all commands available to set up a spectrogram measurement.

The suffix <t> is irrelevant.

List of commands

[CALCulate<t>:SPECtrogram\[:STATe\]](#)..... 404

CALCulate<t>:SPECtrogram[:STATe] <State>

This command turns the use of spectrogram measurement on and off.

Suffix:

<t> 1..n

Parameters:

<State> ON | OFF

Example:

CALC:SPEC ON

Activates the spectrogram measurement.

Using an isotropic antenna

This chapter describes all commands available to set up measurements with an isotropic antenna.

You can use an isotropic antenna with all measurement modes that are described above.

List of commands

[INPut:ANTenna:MEASure](#)..... 404

[INPut:ANTenna:STATe](#)..... 405

[\[SENSe:\]CORRection:TRANsducer<1...2>:ISOTropic\[:STATe\]](#)..... 405

INPut:ANTenna:MEASure <Direction>

This command selects the direction that the isotropic antenna measures.

Parameters:

<Direction> AUTO | X | Y | Z

AUTO

Automatically selects the direction.

X | Y | Z

Measures the corresponding direction only.

*RST: AUTO

Example:

INP:ANT:MEAS X

Measures in x-direction.

INPut:ANTenna:STATe <State>

This command turns the use of an isotropic antenna on and off.

Parameters:

<State> ON | OFF
*RST: OFF

Example:

INP:ANT:STAT ON
Activates the isotropic antenna.

[SENSe:]CORRection:TRANsducer<1...2>:ISOTropic[:STATe] <State>

This command queries if the currently selected transducer is an isotropic antenna.

When you use the command for 3GPP WCDMA measurements in the Digital Modulation operating mode, the command also turns the use of an isotropic antenna on and off.

The numeric suffix at TRANsducer specifies the primary or secondary transducer.

Suffix:

<1...2> 1...2

Parameters:

<State> ON | OFF
0
Transducer is not an isotropic antenna.
1
Transducer is an isotropic antenna.

Example:

CORR:TRAN:ISOT?
only an example

14.6.3 Remote commands of the analog modulation

The chapter provides information on remote commands that configure and perform analog modulation measurements.



Availability of remote commands for the analog modulation

Note that the listed remote commands take effect only if R&S FPH-K7 is installed on the R&S Spectrum Rider.

- [Setting the frequency](#)..... 406
- [Defining the vertical axis](#)..... 406
- [Defining the bandwidth](#)..... 407
- [Defining the FM broadcast](#)..... 408
- [Defining the sweep mode](#)..... 409

Parameters:

<DevPerDiv> Numeric value with the unit range of Hz | kHz| MHz| MAHz| GHz
| PCT.
Default unit: GHz

Example:

DISP:TRAC:Y:PDIV 5 PCT
Set the Y scale (deviation per division) as 5 % in the AM modulation.

14.6.3.3 Defining the bandwidth

The following chapter describes command necessary to define the demodulation bandwidth and audio lowpass filter.

List of commands

[SENSe:]ADEMod:BANDwidth:DEModulation	407
[SENSe:]ADEMod:BWIDth:DEModulation	407
[SENSe:]ADEMod:BANDwidth:RDEViation	407
[SENSe:]ADEMod:BWIDth:RDEViation	407
[SENSe:]FILTer:LPASs	408

[SENSe:]ADEMod:BANDwidth:DEModulation <Bandwidth>

[SENSe:]ADEMod:BWIDth:DEModulation <Bandwidth>

This command sets the demodulation bandwidth.

Parameters:

<Bandwidth> Range: 3 KHz to 2 MHz
Default unit: GHz

Example:

ADEM:BAND:DEM 2MHz
Defines an analog demodulation bandwidth of 2 MHz.

[SENSe:]ADEMod:BANDwidth:RDEViation <Bandwidth>

[SENSe:]ADEMod:BWIDth:RDEViation <Bandwidth>

Only available in FM domain. This command sets the reference deviation.

Maximum limitation $\leq \text{DBW} / 2$. See [\[SENSe:\]ADEMod:BWIDth:DEModulation](#) on page 407.

Parameters:

<Bandwidth> Range: 5 KHz to 1 MHz
Default unit: GHz

Example:

ADEM:BWID:RDEV 1MHz
Defines a FM reference deviation of 1 MHz.

[SENSe:]FILTer:LPASs <AudioLowpassFilterEnum>

This command sets the bandwidth of the audio lowpass filter (relative to the demodulation bandwidth): DBW/1, DBW/10, DBW/30 or DBW/100.

Parameters:

<AudioLPFilterEnum>

Example:

```
FILT:LPAS DBW10
```

Set the bandwidth of the audio lowpass filter to DBW/10.

14.6.3.4 Defining the FM broadcast

The following chapter describes command that define the FM deemphasis filter.

List of commands

[SENSe:]FILTer:DEMPHasis:TCONstant.....	408
[SENSe:]FILTer:DEMPHasis[:STATe].....	408

[SENSe:]FILTer:DEMPHasis:TCONstant <AudioLowpassFilter>

This command sets the time constant for the FM deemphasis filter.

The only supported time constants are 50us and 75us.

Parameters:

<AudioLowpassFilter> Numeric value with the unit range of s | ms | us | ns.

Default unit: s

Example:

```
FILT:DEMP:TCON 50 us
```

Sets the time constant for the FM deemphasis filter to 50 us.

[SENSe:]FILTer:DEMPHasis[:STATe] <State>

This command switches the FM deemphasis filter on or off.

Parameters:

<State>

ON | OFF

ON

Turns on the FM deemphasis filter.

OFF

Turns off the FM deemphasis filter.

*RST: OFF

Example:

```
FILT:DEMP OFF
```

Switches off the FM deemphasis filter.

14.6.3.5 Defining the sweep mode

The following chapter describes command that define the sweep mode and query measurement time.

List of commands

- `INITiate[:IMMediate]` on page 345
- `INITiate:CONTInuous` on page 346

For a detailed description of the commands not described below, see [Performing the measurement](#) in spectrum mode.

`[SENSe:]ADEMod:MTIME?`..... 409

`[SENSe:]ADEMod:MTIME?`

This command queries the measurement time in the analog modulation.

Example: `ADEM:MTIM?`
Queries the measurement time in the analog modulation

Usage: Query only

14.6.3.6 Configuring the limit line

The following chapter describes command necessary to configure the limit line and display the individual pass/fail measurement results of the analog modulation parameters.

The suffix `<t>` is irrelevant.

List of commands

- `CALCulate<t>:LIMit:BEEP[:STATe]` on page 370

For a detailed description of the commands not described below, see [Limit lines](#) in spectrum mode.

`CALCulate<t>:ADEModulation:LIMit:DELeTe`..... 409
`CALCulate<t>:ADEModulation:LIMit:FAIL?`..... 410
`CALCulate<t>:ADEModulation:LIMit:SELeCt`..... 410

`CALCulate<t>:ADEModulation:LIMit:DELeTe`

This command clears the selected limit.

Suffix:
`<t>` 1..n

Example: `CALC:ADEM:LIM:DEL`
Clears off the selected limit line.

Usage: Event

CALCulate<t>:ADEModulation:LIMit:FAIL?

This command queries the result of a limit check.

To get a valid result, you have to perform a complete sweep with synchronization to the sweep end before reading out the result. This is only possible in single sweep mode.

Suffix:

<t> 1..n

Example:

CALC:ADEM:LIM:FAIL?

Queries the result of the check for limit line

Usage:

Query only

CALCulate<t>:ADEModulation:LIMit:SElect <Filename>

This command loads a limit line for the selected measurement mode.

Suffix:

<t> 1..n

Parameters:

<Filename> String containing the filename of the limit line.

Example:

CALC:ADEM:LIM:SEL 'GSM.aamlim'

Selects the filename for limit line.

14.6.3.7 Setting the measurement mode

The following chapter describes command necessary to switch to the correct measurement mode.

The suffix <t> is irrelevant.

List of commands

- [INSTrument\[:SElect\]](#) on page 448
- [INSTrument:NSElect](#) on page 448

For a detailed description of the commands not described below, see [Chapter 14.6.11.1, "Mode selection"](#), on page 447.

[CALCulate<t>:FEED](#)..... 410

CALCulate<t>:FEED <Measurement>

This command switches the measurement mode.

Suffix:

<t> 1..n

Parameters:

<Measurement> String containing the measurement mode (analog modulation or digital modulation):

Example:	<code>CALC:FEED 'XTIM.AM'</code>	Switches the analog measurement mode to AM Time.
	<code>CALC:FEED 'XTIM.FM'</code>	Switches the analog measurement mode to FM Time.
	<code>CALC:FEED 'XTIM.FMSummary'</code>	Switches the analog measurement mode to FM Summary.
	<code>CALC:FEED 'XTIM:DDEM:ERR:MPH'</code>	Switches the digital measurement mode to error result display.
	<code>CALC:FEED 'XTIM:DDEM:EYE'</code>	Switches the digital measurement mode to eye diagram.
	<code>CALC:FEED 'XTIM:DDEM:MEAS'</code>	Selects the modulation depth (ASK) or modulation deviation (FSK) result display.
	<code>CALC:FEED 'XTIM:DDEM:SYMB'</code>	Switches the digital measurement mode to symbol stream result display.

14.6.3.8 Reading measurement results

The following chapter describes command necessary to display the measurement results.

The suffix <t> is irrelevant.

List of commands

<code>[SENSe:]ADEMod:FM:OFFSet?</code>	411
<code>CALCulate<t>:MARKer:FUNCTION:ADEMod:AFRequency[:RESult]?</code>	411
<code>CALCulate<t>:MARKer:FUNCTION:ADEMod:AM[:RESult]?</code>	412
<code>CALCulate<t>:MARKer:FUNCTION:ADEMod:CARRier[:RESult]?</code>	412
<code>CALCulate<t>:MARKer:FUNCTION:ADEMod:FERRor[:RESult]?</code>	412
<code>CALCulate<t>:MARKer:FUNCTION:ADEMod:FM[:RESult]?</code>	413
<code>CALCulate<t>:MARKer:FUNCTION:ADEMod:MINdex[:RESult]?</code>	413
<code>CALCulate<t>:MARKer:FUNCTION:ADEMod:MRAT[:RESult]?</code>	413
<code>CALCulate<t>:MARKer:FUNCTION:ADEMod:SINad[:RESult]?</code>	413
<code>CALCulate<t>:MARKer:FUNCTION:ADEMod:SNR[:RESult]?</code>	414
<code>CALCulate<t>:MARKer:FUNCTION:ADEMod:THD[:RESult]?</code>	414

`[SENSe:]ADEMod:FM:OFFSet?`

This command displays the Frequency Deviation value for FM.

Example: `ADEM:FM:OFFS?`
Reads out the Frequency Deviation value for FM.

Usage: Query only

`CALCulate<t>:MARKer:FUNCTION:ADEMod:AFRequency[:RESult]?`

This command queries the modulation frequency.

Suffix:
 <t> 1..n

Example: CALC:MARK:FUNC:ADEM:AFR?
 Reads out the modulation frequency

Usage: Query only

CALCulate<t>:MARKer:FUNCTION:ADEMod:AM[:RESult]? <MeasType>

This command displays the results of frequency deviation for AM.

Suffix:
 <t> 1..n

Parameters:
 <MeasType> PPEak | MPEak | MIDDLE | RMS

PPEak

+Peak value

MPEak

-Peak value

MIDDLE

-±Peak value/2

RMS

RMS value

Example: CALC:MARK:FUNC:ADEM:AM RMS
 Reads out the RMS value for AM.

Usage: Query only

CALCulate<t>:MARKer:FUNCTION:ADEMod:CARRier[:RESult]?

This command displays the Carrier Power value for both AM/FM.

Suffix:
 <t> 1..n

Example: CALC:MARK:FUNC:ADEM:CARR?
 Reads out the Carrier Power value for both AM/FM.

Usage: Query only

CALCulate<t>:MARKer:FUNCTION:ADEMod:FERRor[:RESult]?

This command displays the Carrier Offset value for both AM/FM.

Suffix:
 <t> 1..n

Example: CALC:MARK:FUNC:ADEM:FERR?
 Reads out the Carrier Offset value for both AM/FM.

Usage: Query only

CALCulate<t>:MARKer:FUNCTION:ADEMod:FM[:RESult]? <MeasType>

This command displays the results of frequency deviation for FM.

Suffix:

<t> 1..n

Parameters:

<MeasType> PPEak | MPEak | MIDDLE | RMS

PPEak

+Peak value

MPEak

-Peak value

MIDDLE

-±Peak value/2

RMS

RMS value

Example: CALC:MARK:FUNC:ADEM:FM RMS
Reads out the RMS value for FM.

Usage: Query only

CALCulate<t>:MARKer:FUNCTION:ADEMod:MINDEX[:RESult]?

This command displays the Modulation Index value for AM.

Suffix:

<t> 1..n

Example: CALC:MARK:FUNC:ADEM:MIND?
Reads out the Modulation Index value for AM.

Usage: Query only

CALCulate<t>:MARKer:FUNCTION:ADEMod:MRAT[:RESult]?

This command queries the modulation rate for the FM signal.

Suffix:

<t> 1..n

Example: CALC:MARK:FUNC:ADEM:MRAT?
Reads out the modulation rate value for FM.

Usage: Query only

CALCulate<t>:MARKer:FUNCTION:ADEMod:SINad[:RESult]?

This command displays the SINAD value for both AM/FM.

Suffix:	
<t>	1..n
Example:	CALC:MARK:FUNC:ADEM:SIN? Reads out the SINAD value for both AM/FM.
Usage:	Query only

CALCulate<t>:MARKer:FUNCtion:ADEMod:SNR[:RESult]?

This command displays the SNR value for both AM/FM.

Suffix:	
<t>	1..n
Example:	CALC:MARK:FUNC:ADEM:SNR? Reads out the SNR value for both AM/FM.
Usage:	Query only

CALCulate<t>:MARKer:FUNCtion:ADEMod:THD[:RESult]?

This command displays the THD value for both AM/FM.

Suffix:	
<t>	1..n
Example:	CALC:MARK:FUNC:ADEM:THD? Reads out the THD value for both AM/FM.
Usage:	Query only

14.6.4 Remote commands of the digital modulation

The chapter provides information on remote commands that configure and perform digital modulation measurements.



Availability of remote commands for the digital modulation

Note that the listed remote commands take effect only if R&S FPH-K7 is installed on the R&S Spectrum Rider

- [Setting the frequency](#)..... 415
- [Setting the amplitude](#)..... 415
- [Defining the sweep control](#).....415
- [Configuring the trigger](#).....416
- [Setting the marker](#).....416
- [Setting the measurement mode](#).....417
- [Setting measurement configuration](#)..... 417
- [Reading measurement results](#)..... 419

14.6.4.1 Setting the frequency

The following chapter describes command to define and query on the frequency settings.

List of commands

- [\[SENSe:\] FREQuency:CENTer](#) on page 333
- [\[SENSe:\] FREQuency:CENTer:STEP](#) on page 333
- [\[SENSe:\] FREQuency:OFFSet](#) on page 335

For a detailed description of the commands, see [Configuring the horizontal axis](#) in spectrum mode.

14.6.4.2 Setting the amplitude

The following chapter describes command necessary to define the vertical scale such as the x-axis deviation per division and settings affecting the amplitude of the measurements.

The suffix <t> is irrelevant.

List of commands

- [DISPlay\[:WINDow\]:TRACe<t>:Y\[:SCALE\]:PDIVision](#) on page 406
- [DISPlay\[:WINDow\]:TRACe<t>:Y\[:SCALE\]:RPOSITION](#) on page 338
- [DISPlay\[:WINDow\]:TRACe<t>:Y\[:SCALE\]:RLEVEL](#) on page 337
- [INPut:ATTenuation<p>](#) on page 339
- [INPut:ATTenuation:AUTO](#) on page 339
- [INPut:ATTenuation:MODE](#) on page 339
- [INPut:GAIN:STATE](#) on page 339
- [INPut:IMPedance](#) on page 340
- [INPut:IMPedance:PAD](#) on page 456

For a detailed description of the commands, see [Defining the vertical axis](#) in analog modulation mode, [Configuring the vertical axis](#) in spectrum mode and [Chapter 14.6.11.6, "System settings"](#), on page 455.

14.6.4.3 Defining the sweep control

The following chapter describes command that define the sweep mode and query measurement time.

List of commands

- [INITiate\[:IMMediate\]](#) on page 345
- [INITiate:CONTInuous](#) on page 346

- `CALCulate<t>:DELTaMarker<m>:Y?` on page 358

For a detailed description of the command, see [Markers and delta markers](#) and [Working with traces](#) in spectrum mode.

14.6.4.6 Setting the measurement mode

The following chapter describes command necessary to switch to the correct measurement mode.

The suffix <t> is irrelevant.

List of commands

- `CALCulate<t>:FEED` on page 410
- `INSTRument[:SElect]` on page 448
- `INSTRument:NSElect` on page 448

For a detailed description of the commands, see [Setting the measurement mode](#) in analog modulation mode and [Chapter 14.6.11.1, "Mode selection"](#), on page 447.

14.6.4.7 Setting measurement configuration

The following chapter describes command necessary to set the measurement configuration.

The suffix <t> is irrelevant.

List of commands

<code>CALCulate<t>:FSK:DEVIation:REFerence[:VALue]</code>	417
<code>[SENSe:]DDEMod:BURSt[:STATe]</code>	418
<code>[SENSe:]DDEMod:FILTer:ALPHa</code>	418
<code>[SENSe:]DDEMod:FILTer:NAME</code>	418
<code>[SENSe:]DDEMod:FILTer[:STATe]</code>	418
<code>[SENSe:]DDEMod:SRATe</code>	419
<code>[SENSe:]DDEMod:TIME</code>	419

`CALCulate<t>:FSK:DEVIation:REFerence[:VALue]` <FrequencyDeviation>

This command sets and queries the frequency deviation in the FSK signal.

Suffix:

<t> 1..n

Parameters:

<FrequencyDev> Range: 1 kHz to 200 kHz
 Default unit: Hz

Example:

`CALC:FSK:DEV:REF 1 KHZ`
 Set frequency deviation as 1 kHz.

[SENSe:]DDEMod:BURSt[:STATe] <State>

This command turns burst processing on and off.

Parameters:

<State> ON | OFF | 1 | 0
 ON | 1
 Turn on burst processing..
 OFF | 0
 Turn off burst processing..

Example:

DDEM: BURS ON
 Turn on burst processing.

[SENSe:]DDEMod:FILTer:ALPHa <Alpha>

This command defines the roll-off factor of the measurement filter (alpha or BT value).

Parameters:

<Alpha> Range: 0 to 1
 *RST: 1

Example:

DDEM: FILT: ALPH 0.35
 Define roll-off factor.

[SENSe:]DDEMod:FILTer:NAME <FilterName>

This command selects the measurement filter.

If you want to use no filter (unfiltered measurements), see [\[SENSe:\]DDEMod:FILTer\[:STATe\]](#) on page 418.

Parameters:

<FilterName> RRC | RC | GAUS
 RRC
 Selects a root raised cosine filter.
 RC
 Select a raised cosine filter.
 GAUS
 Select a Gaussian filter.

Example:

DDEM: FILT: NAME RRC
 Select RRC filter.

[SENSe:]DDEMod:FILTer[:STATe] <State>

This command turns the measurement filter on and off.

Parameters:

<State> **OFF | 0**
 Turns off the measurement filter for unfiltered measurements.

ON | 1

Turns on the measurement filter selected with [\[SENSe:\]DDEMod:FILTEr:NAME](#) on page 418.

[SENSe:]DDEMod:SRATe <SymbolRate>

This command defines the symbol rate.

Parameters:

<SymbolRate> Default unit: Hz

Example:

DDEM:SRAT 10KHZ
Define symbol rate.

[SENSe:]DDEMod:TIME <ResultLength>

This command defines the number of symbols to be evaluated.

Parameters:

<ResultLength> Range: 20 to frpnfd on measurement filter
 *RST: 100

Example:

DDEM:TIME 150
Define the number of symbols.

14.6.4.8 Reading measurement results

The following chapter describes command necessary to display the measurement results.

The suffix <t> is irrelevant.

List of commands

- [TRACe<t>\[:DATA\]?](#) on page 353

For a detailed description of the command not described below, see [Working with traces](#) in spectrum mode.

CALCulate<t>:MARKer:FUNCTion:DDEMod:CARRier[:RESult]?.....	420
CALCulate<t>:MARKer:FUNCTion:DDEMod:CFDRiff[:RESult]?.....	420
CALCulate<t>:MARKer:FUNCTion:DDEMod:CFERror[:RESult]?.....	420
CALCulate<t>:MARKer:FUNCTion:DDEMod:MDEPth[:RESult]?.....	420
CALCulate<t>:MARKer:FUNCTion:DDEMod:MDEViation[:RESult]?.....	421
CALCulate<t>:MARKer:FUNCTion:DDEMod:MERRor[:RESult]?.....	421
CALCulate<t>:MARKer:FUNCTion:DDEMod:MINDEx[:RESult]?.....	421
CALCulate<t>:MARKer:FUNCTion:DDEMod:MOERror[:RESult]?.....	421
CALCulate<t>:MARKer:FUNCTion:DDEMod:MPOWer[:RESult]?.....	422
[SENSe:]DDEMod.....	422
[SENSe:]DDEMod:FSK:OFFSet?.....	422

CALCulate<t>:MARKer:FUNction:DDEMod:CARRier[:RESult]?

This command queries the carrier power of the measured signal.

Suffix:

<t> 1..n

Example:

CALC:MARK:FUNC:DDEM:CARR?
Query carrier power

Usage:

Query only

CALCulate<t>:MARKer:FUNction:DDEMod:CFDRift[:RESult]?

This command queries the carrier frequency drift of the measured signal.

Prerequisites for this command: Select FSK demodulation [[SENSe: \] DDEMod](#) on page 422.

Suffix:

<t> 1..n

Example:

CALC:MARK:FUNC:DDEM:CFDR?
Query carrier frequency drift.

Usage:

Query only

CALCulate<t>:MARKer:FUNction:DDEMod:CFERror[:RESult]?

This command queries the carrier frequency error of the measured signal.

Suffix:

<t> 1..n

Example:

CALC:MARK:FUNC:DDEM:CFER?
Query carrier frequency error.

Usage:

Query only

CALCulate<t>:MARKer:FUNction:DDEMod:MDEPth[:RESult]?

This command queries the modulation depth of the measured signal.

Prerequisites for this command: Select ASK demodulation [[SENSe: \] DDEMod](#) on page 422.

Suffix:

<t> 1..n

Example:

CALC:MARK:FUNC:DDEM:MDEP?
Query modulation depth.

Usage:

Query only

CALCulate<t>:MARKer:FUNCTION:DDEMod:MDEViation[:RESult]?

This command queries the frequency deviation of the measured signal.

Prerequisites for this command: Select FSK demodulation [[SENSe](#):] [DDEMod](#) on page 422.

Suffix:

<t> 1..n

Example:

CALC:MARK:FUNC:DDEM:MDEV?
Query frequency deviation.

Usage:

Query only

CALCulate<t>:MARKer:FUNCTION:DDEMod:MERRor[:RESult]?

This command queries the magnitude error of the measured signal.

Prerequisites for this command: Select FSK demodulation [[SENSe](#):] [DDEMod](#) on page 422.

Suffix:

<t> 1..n

Example:

CALC:MARK:FUNC:DDEM:MERR?
Query magnitude error.

Usage:

Query only

CALCulate<t>:MARKer:FUNCTION:DDEMod:MINdex[:RESult]?

This command queries the modulation index of the measured signal.

Prerequisites for this command: Select ASK demodulation [[SENSe](#):] [DDEMod](#) on page 422.

Suffix:

<t> 1..n

Example:

CALC:MARK:FUNC:DDEM:MIND?
Query modulation index.

Usage:

Query only

CALCulate<t>:MARKer:FUNCTION:DDEMod:MOERror[:RESult]?

This command queries the modulation error.

Suffix:

<t> 1..n

Example:

CALC:MARK:FUNC:DDEM:MOER?
Query modulation error.

Usage:

Query only

CALCulate<t>:MARKer:FUNCTION:DDEMod:MPOWER[:RESult]?

This command queries the power of the carrier signal.

Suffix:

<t> 1..n

Example: CALC:MARK:FUNC:DDEM:MPOW??
Query carrier power.

Usage: Query only

[SENSe:]DDEMod <DemodType>

This command selects the demodulation scheme of the signal you are measuring.

Parameters:

<DemodType> ASK | FSK
ASK
Selects ASK modulation.
FSK
Selects FSK modulation.

Example: DDEM ASK
Sets ASK modulation to measure signal.

[SENSe:]DDEMod:FSK:OFFSet?

This command queries the measured frequency deviation of an FSK signal.

Prerequisites for this command: Select FSK demodulation [\[SENSe:\]DDEMod](#) on page 422.

Parameters:

<Frequency>> <numeric value>
Default unit: Hz

Example: DDEM:FSK:OFFS?
Query frequency deviation.

Usage: Query only

14.6.5 Remote commands of the power meter

The chapter provides information on remote commands that configure and perform power measurements with the power sensor. These commands are available in power meter mode only.



Availability of remote commands for Power Sensor measurements

Note that the listed remote commands take effect only if a power sensor is connected.

• Setting the frequency.....	423
• Setting the wavelength.....	423
• Configuring power level readout.....	424
• Defining the measurement time.....	425
• Zeroing of the power sensor.....	425
• Forward power display.....	426
• Defining the video bandwidth.....	426
• Reading measurement results.....	427
• Selecting a telecommunication standard.....	428

14.6.5.1 Setting the frequency

The following chapter describes commands necessary to define frequency settings.

The suffix <t> is irrelevant.

List of commands

[SENSe:]PMETer:FREQuency.....	423
CALCulate<t>:PMETer:CPOWer:BANDwidth.....	423

[SENSe:]PMETer:FREQuency <Frequency>

This command sets the frequency of the power sensor.

Parameters:

<Frequency> Specified in the data sheet.
 Default unit: GHz

Example:

PMET:FREQ 500 MHZ
 Sets the power sensor's frequency to 500 MHz.

CALCulate<t>:PMETer:CPOWer:BANDwidth <ChannelBW>

This command defines the channel bandwidth.

Available for the channel power meter.

Suffix:

<t> 1..n

Parameters:

<ChannelBW> Default unit: GHz

Example:

CALC:PMET:CPOW:BAND 5 MHZ
 Sets the channel bandwidth to 5 MHz.

14.6.5.2 Setting the wavelength

The following chapter describes commands necessary to define the wavelength settings for the operation of optic power sensor.

List of commands

[SENSe:]PMETer:WAVelength..... 424

[SENSe:]PMETer:WAVelength <Wavelength>

This command sets the wavelength when the optical power sensor is connected.

See the respective optic power sensor specification for the supported wavelength.

Parameters:

<Wavelength> Default unit: NM

Example:

PMET:WAV 1550 NM

Set wavelength as 1550 nm.

14.6.5.3 Configuring power level readout

The following chapter describes commands that configure the power level readout.

The suffix <t> is irrelevant.

List of commands

CALCulate<t>:PMETer:RELative[MAGNitude]..... 424

CALCulate<t>:PMETer:RELative[MAGNitude]:AUTO..... 424

CALCulate<t>:PMETer:RELative[MAGNitude]:OFFSet..... 425

CALCulate<t>:PMETer:RELative[MAGNitude] <RefLevel>

This command sets the reference value for relative measurements.

Suffix:

<t> 1..n

Parameters:

<RefLevel> Default unit: dBm

Example:

CALC:PMET:REL 30

The reference value to 30 dBm.

CALCulate<t>:PMETer:RELative[MAGNitude]:AUTO <ONCE>

This command sets the current measurement result as the reference level for relative measurements.

This command is an event and therefore has no *RST value and no query.

Suffix:

<t> 1..n

Parameters:

<ONCE> ONCE

Example:

CALC:PMET:REL ONCE

CALCulate<t>:PMETer:RELative[:MAGNitude]:OFFSet <RefLvOffset>

This command sets an offset for the reference value.

Suffix:

<t> 1..n

Parameters:

<RefLvOffset> Default unit: dB

Example: CALC:PMET:REL -10

14.6.5.4 Defining the measurement time

The following chapter describes commands to define the measurement time of the power sensor.

List of commands

[SENSe:]PMETer:MTIME..... 425

[SENSe:]PMETer:MTIME <MeasTime>

This command sets the duration of measurements.

Available for measurements with a power sensor.

Parameters:

<MeasTime> SHORt | NORMAl | LONG

Example: PMET:MTIME SHOR
Sets a short measurement time for power measurements.

14.6.5.5 Zeroing of the power sensor

The following chapter describes commands to perform zeroing of the power sensor.

List of commands

CALibration:PMETer:ZERO:AUTO..... 425

CALibration:PMETer:ZERO:AUTO <ONCE>

This command starts to zero the power sensor.

This command is an event and therefore has no *RST value and no query.

Parameters:

<ONCE> ONCE

Example: CAL:PMET:ZERO:AUTO ONCE
Starts to zero the power meter.

14.6.5.6 Forward power display

Note that the forward power is only available in conjunction with the R&S FSH-Z14 or R&S FSH-Z44.

List of commands

[SENSe:]PMETer:DETEctor[:FUNction]..... 426

[SENSe:]PMETer:DETEctor[:FUNction] <Detector>

This command selects the forward power display of the power sensor.

Parameters:

<Detector>	AVERage PENvelope
	AVERage
	Displays the average power.
	PENvelope
	Displays the peak envelope power.
*RST:	-

Example:

```
PMET:DET AVER
Selects the Average weighting mode.
```

14.6.5.7 Defining the video bandwidth

Selecting a video bandwidth is only possible when you are measuring the peak envelope power with the R&S FSH-Z44 power sensor based on a customized (= user) standard.

The suffix <t> is irrelevant.

List of commands

- [SENSe:]PMETer:DETEctor[:FUNction] on page 426
- CALCulate<t>:PMETer:PRESet[:STATe] on page 428
- CALCulate<t>:PMETer:PRESet:SElect on page 428

For a detailed description of the commands, see [Forward power display](#) and [Selecting a telecommunication standard](#) in power meter mode.

CALCulate<t>:PMETer:PRESet:BANDwidth:VIDeo.....426

CALCulate<t>:PMETer:PRESet:BANDwidth:VIDeo <VideoBW>

This command defines the video bandwidth of the R&S FSH-Z44 power sensor.

Suffix:

<t>	1..n
-----	------

Parameters:

<VideoBW>	Default unit: GHz
-----------	-------------------

Example: `CALC:PMET:PRES:BAND:VID 10MHZ`
 Defines a video bandwidth of 10 MHz.

14.6.5.8 Reading measurement results

The following chapter describes commands to configure and read measurement result from the power sensor.

List of commands

<code>FETCh<z>:PMETer</code>	427
<code>UNIT<t>:PMETer:POWer</code>	427

`FETCh<z>:PMETer`

This command queries the results of measurements with the power sensor.

The numeric suffix <z> at FETCh has the following effects:

Table 14-4: Power measurement with R&S FSH-Z1, R&S FSH-Z18 and USB power sensors:

1	Power in defined unit.
2	Not available.

Table 14-5: Power measurement with R&S FSH-Z14 and R&S FSH-Z44:

1	Forward power in defined unit.
2	Reflected power in defined unit.

Suffix:

<z> 1..n

Example:

`FETC2:PMET?`

Returns nothing for R&S FSH-Z1 / R&S FSH-Z18 and the reflected power for R&S FSH-Z14 / R&S FSH-Z44.

`UNIT<t>:PMETer:POWer <Unit>`

This command selects the unit of the power sensor.

The numeric suffix <t> at UNIT has the following effects:

Table 14-6: Power measurement with R&S FSH-Z1, R&S FSH-Z18 and USB power sensors:

1	Power unit.
2	Not available.

Table 14-7: Power measurement with R&S FSH-Z14 and R&S FSH-Z44:

1	Forward power.
2	Reflected power.

Suffix:

<t> 1..n

Parameters:

<Unit> DBM | DB | WATT | VSWR | W | DUVM | DBUV | DBMV | DUVE | DMVE | W_M2 | V_M

Note on the parameter DB: when applied to UNIT1, the power is relative to the reference level, when applied to UNIT2, the return loss is displayed.

Note on the parameter VSWR: the parameter is only available if applied to UNIT2.

Example:

UNIT1:PMET:POW DBM

When measuring with the R&S FSH-Z1, R&S FSH-Z18 or USB power sensors: sets unit to dBm.

When measuring with the R&S FSH-Z14 or R&S FSH-Z44: sets unit of forward power to dBm.

14.6.5.9 Selecting a telecommunication standard

These commands apply radio communication standards to measurements with the power sensor.

The suffix <t> is irrelevant.

Note that the selection of a standard is available only for the power sensors R&S FSH-Z1, -Z14, -Z18 and Z-44.

List of commands

CALCulate<t>:PMETer:PRESet[:STATe].....	428
CALCulate<t>:PMETer:PRESet:SElect.....	428

CALCulate<t>:PMETer:PRESet[:STATe] <State>

This command turns on or off the use of a standard.

Suffix:

<t> 1..n

Parameters:

<State> ON | OFF

Example:

CALC:PMET:PRES ON

Activates usage of a standard.

CALCulate<t>:PMETer:PRESet:SElect <Standard>

This command selects the standard for power sensor measurements.

Suffix:

<t> 1..n

Parameters:

<Standard>

E.g. GSM | EDGE | WCDMA | CDMAOne | CDMA2000 | DVBT | DAB | TETRA | USER

Example:

CALC:PMET:PRES:SEL GSM

Selects the GSM standard for power sensor measurements.

14.6.6 Remote commands of the receiver mode

The chapter provides information on remote commands that configure and perform measurements receiver.

**Availability of remote commands for EMI measurements**

Note that the listed remote commands take effect only if option R&S FPH-K43 Receiver Mode and Channel Scanner are installed.

- [Configuring the horizontal axis](#).....429
- [Configuring the vertical axis](#).....430
- [Setting the bandwidth](#).....431
- [Performing and triggering the measurement](#).....432
- [Working with traces](#).....433
- [Using markers](#).....434
- [Using limit lines](#).....435

14.6.6.1 Configuring the horizontal axis

The following commands configure the horizontal (frequency) axis of the active display.

List of commands

- [\[SENSe:\]CHANnel<1...3>](#) on page 375
- [\[SENSe:\]FREQuency:CENTer](#) on page 333
- [\[SENSe:\]FREQuency:CENTer:STEP](#) on page 333
- [\[SENSe:\]FREQuency:INPut:MODE](#) on page 334

For a detailed description of the commands not described below, see [Configuring the horizontal axis](#) and [Configuring and using measurement functions](#) in spectrum mode.

[SENSe:]SCAN:START	429
[SENSe:]SCAN:STEP	430
[SENSe:]SCAN:STOP	430

[SENSe:]SCAN:START <StartScan>

This command defines the start frequency of the receiver scan range.

Parameters:

<StartScan> Numeric value in Hz.
 The range is specified in the datasheet.
 *RST: fmin
 Default unit: GHZ

Example:

SCAN:STAR 30kHz
 Defines a start frequency of 30 kHz.

[SENSe:]SCAN:STEP <StepFrequency>

This command defines the step size in the receiver scan range.

Parameters:

<StepFrequency> Numeric value in Hz.
 The range is from 1 Hz to fmax.
 *RST: 0
 Default unit: GHz

Example:

SCAN:STEP 1kHz
 Defines a step frequency of 1 kHz.

[SENSe:]SCAN:STOP <StopFrequency>

This command defines the step size in the receiver scan range.

Parameters:

<StopFrequency> Numeric value in Hz.
 The range is specified in the datasheet.
 *RST: fmax
 Default unit: GHZ

Example:

SCAN:STOP 1GHz
 Defines a stop frequency of 30 kHz.

14.6.6.2 Configuring the vertical axis

The following commands configure the vertical (level) axis and level parameters of the active display.

The suffix <t> and <p> are irrelevant.

List of commands

- [DISPlay\[:WINDow\]:TRACe<t>:Y:SPACing](#) on page 336
- [DISPlay\[:WINDow\]:TRACe<t>:Y\[:SCALE\]](#) on page 337
- [DISPlay\[:WINDow\]:TRACe<t>:Y\[:SCALE\]:RLEVEL](#) on page 337
- [DISPlay\[:WINDow\]:TRACe<t>:Y\[:SCALE\]:RLEVEL:OFFSet](#) on page 338
- [DISPlay\[:WINDow\]:TRACe<t>:Y\[:SCALE\]:RPOSITION](#) on page 338
- [INPut:ATTenuation<p>](#) on page 339

- `INPut:ATTenuation:MODE` on page 339
- `INPut:ATTenuation:AUTO` on page 339
- `INPut:GAIN:STATE` on page 339
- `INPut:IMPedance` on page 340
- `[SENSe:]CORREction:TRANsducer<1...2>[:STATE]` on page 340
- `[SENSe:]CORREction:TRANsducer<1...2>:SElect` on page 340
- `[SENSe:]CORREction:TRANsducer<1...2>:UNIT?` on page 341
- `UNIT<t>:POWER` on page 341

For a detailed description of the commands, see [Configuring the vertical axis](#) in spectrum mode.

14.6.6.3 Setting the bandwidth

The following commands configure the filter bandwidths of the R&S Spectrum Rider.

- `[SENSe:]BWIDth[:RESolution]` on page 344
- `[SENSe:]BANDwidth[:RESolution]` on page 344

For a detailed description of the commands not described below, see [Setting the bandwidth](#) in spectrum mode.

List of commands

<code>[SENSe:]BANDwidth[:RESolution]:CISPr</code>	431
<code>[SENSe:]BANDwidth[:RESolution]:CISPr:AUTO</code>	431

`[SENSe:]BANDwidth[:RESolution]:CISPr <CisprResolutionBW>`

This command defines the CISPR (6 dB) bandwidth for CISPR conform measurements.

Parameters:

`<CisprResolutionBW>` 200 Hz | 9 kHz | 120 kHz | 1 MHz

*RST: (AUTO is on)

Example:

`BAND:CISP 120KHZ`

Defines a bandwidth of 120 kHz.

`[SENSe:]BANDwidth[:RESolution]:CISPr:AUTO <State>`

This command turns automatic selection of the CISPR measurement bandwidth on and off.

Parameters:

`<State>` ON | OFF

*RST: ON

Example:

`BAND:CISP:AUTO ON`

Turns automatic selection of the CISPR bandwidth on.

14.6.6.4 Performing and triggering the measurement

The following commands configure the sweep.

Performing the measurement

The following chapter describes commands necessary to perform receiver mode measurement.

The suffix <t> is irrelevant.

List of commands

- [ABORt](#) on page 345
- [INITiate\[:IMMediate\]](#) on page 345
- [INITiate:CONTinuous](#) on page 346
- [\[SENSe:\]SWEep:COUNT](#) on page 346
- [\[SENSe:\]SWEep:TIME](#) on page 347

For a detailed description of the commands not described below, see [Performing the measurement](#) in spectrum mode.

DISPlay<t>:BARGraph:PHOLd:RESet

This command resets the maximum hold power level of the receiver frequency.

This command is an event and therefore has no query and no *RST value.

Suffix:

<t> 1..n

Example: DISP:BRAG:PHOL:RES

Usage: Event

Triggering measurements

The following commands set up trigger conditions if you are using a trigger for the measurement.

List of commands

- [TRIGger\[:SEQuence\]:SLOPe](#) on page 349
- [TRIGger\[:SEQuence\]:SOURce](#) on page 349

For a detailed description of the commands, see [Triggering measurements](#) in spectrum mode.

Using an isotropic antenna

The following commands set up measurements with an isotropic antenna.

You can use an isotropic antenna with all measurement modes that are described above.

List of commands

- `INPut:ANTenna:MEASure` on page 404
- `INPut:ANTenna:STATe` on page 405
- `[SENSe:]CORREction:TRANsducer<1...2>:ISOTropic[:STATe]` on page 405

For a detailed description of the commands, see [Using an isotropic antenna](#) in spectrum mode.

14.6.6.5 Working with traces

The following commands set up the trace and the various functions associated with it, e.g. trace mathematics or the selection of the detector.

The suffix <t> is irrelevant.

List of commands

- `[SENSe:]DETEctor<t>[:FUNCTion]` on page 350
- `CALCulate<t>:MATH:COpy:MEMory` on page 350
- `DISPlay[:WINDow]:TRACe<t>[:STATe]` on page 351
- `DISPlay[:WINDow]:TRACe<t>:MEMory[:STATe]` on page 351
- `DISPlay[:WINDow]:TRACe<t>:MODE` on page 352
- `FORMat:BORDER` on page 352
- `FORMat[:DATA]` on page 353
- `FORMat:BORDER` on page 352
- `TRACe<t>[:DATA]?` on page 353
- `TRACe<t>[:DATA]:MEMory?` on page 354

For a detailed description of the commands not described below, see [Working with traces](#) in spectrum mode.

`DISPlay[:WINDow]:TRACe:STYLE`.....433

DISPlay[:WINDow]:TRACe:STYLE <TraceStyle>

This command selects the style of the trace display.

Parameters:

<TraceStyle> LINES | POLYgon

LINES

Adjacent Channel Leakage Ratio measurement (ACLR or ACP).

POLYgon

Shows the results in form of vertical lines at each receiver frequency.

*RST: POLYgon

Example: `DISP:TRAC:STYL LIN`
Selects the display of a line trace.

14.6.6.6 Using markers

Markers and delta markers

The following commands are for setting and controlling markers and deltamarkers.

The suffix <m> selects the marker. It is in the range of <1..6>.

The suffix <t> is irrelevant.

List of commands

- `CALCulate<t>:DELTamarker<m>[:STATe]` on page 355
- `CALCulate<t>:DELTamarker<m>:AOFF` on page 355
- `CALCulate<t>:DELTamarker<m>:MAXimum[:PEAK]` on page 356
- `CALCulate<t>:DELTamarker<m>:MAXimum:NEXT` on page 356
- `CALCulate<t>:DELTamarker<m>:MINimum[:PEAK]` on page 356
- `CALCulate<t>:DELTamarker<m>:X` on page 357
- `CALCulate<t>:DELTamarker<m>:X:RELative` on page 357
- `CALCulate<t>:DELTamarker<m>:Y?` on page 358
- `CALCulate<t>:MARKer<m>[:STATe]` on page 358
- `CALCulate<t>:MARKer<m>:AOFF` on page 359
- `CALCulate<t>:MARKer<m>:MAXimum[:PEAK]` on page 360
- `CALCulate<t>:MARKer<m>:MAXimum:NEXT` on page 360
- `CALCulate<t>:MARKer<m>:MINimum[:PEAK]` on page 360
- `CALCulate<t>:MARKer<m>:X` on page 361
- `CALCulate<t>:MARKer<m>:X:SLIMits<l>[:STATe]` on page 361
- `CALCulate<t>:MARKer<m>:X:SLIMits<l>:LEFT` on page 362
- `CALCulate<t>:MARKer<m>:X:SLIMits<l>:RIGHT` on page 362
- `CALCulate<t>:MARKer<m>:Y?` on page 363

For a detailed description of the commands, see [Using markers](#) in spectrum mode.

Marker functions

The following commands perform various kinds of analysis at the marker position.

The suffix <m> selects the marker. It is in the range of <1..6>.

The suffix <t> is irrelevant.

List of commands

- `CALCulate<t>:MARKer:FREQuency:MODE` on page 359

- [CALCulate<t>:MARKer<m>:FUNction:DEModulation\[:STATe\]](#) on page 365
- [CALCulate<t>:MARKer<m>:FUNction:DEModulation:HOLD](#) on page 366
- [CALCulate<t>:MARKer<m>:FUNction:DEModulation:SElect](#) on page 366

For a detailed description of the commands not described below, see [Using markers](#) in spectrum mode.

[CALCulate<t>:MARKer<m>:FUNction:FIXed](#).....435

CALCulate<t>:MARKer<m>:FUNction:FIXed

This command synchronizes the bargraph frequency to one of the marker frequencies in the frequency scan.

At the same, the command switches to the fixed frequency measurement.

Suffix:

<t> 1..n

<m> 1..n

Usage: Event

14.6.6.7 Using limit lines

The following commands define limit lines and perform the corresponding limit checks.

The suffix <l> selects the limit lines. It is in the range of <1..2>.

The suffix <t> is irrelevant.

List of commands

- [CALCulate<t>:LIMit:BEEP\[:STATe\]](#) on page 370
- [CALCulate<t>:LIMit<l>:COMMeNt?](#) on page 370
- [CALCulate<t>:LIMit<l>:DELeTe](#) on page 372
- [CALCulate<t>:LIMit<l>:FAIL?](#) on page 372
- [CALCulate<t>:LIMit<l>:LOWer:SElect](#) on page 373
- [CALCulate<t>:LIMit:STATe](#) on page 372
- [CALCulate<t>:LIMit<l>:UNIT:X?](#) on page 373
- [CALCulate<t>:LIMit<l>:UNIT\[:Y\]?](#) on page 373
- [CALCulate<t>:LIMit<l>:UPPer:SElect](#) on page 374

For a detailed description of the commands, see [Limit lines](#) in spectrum mode.

14.6.7 File management

The following commands perform various tasks in the context of file management.

These commands are independent from the operating mode.

List of commands

MMEMory:CATalog?	436
MMEMory:CATalog:DIRectories?	436
MMEMory:CDIRectory	436
MMEMory:COpy	437
MMEMory:DATA	437
MMEMory:DELeTe	438
MMEMory:FILE	438
MMEMory:FILE:DATE	438
MMEMory:FILE:TIME	439
MMEMory:INIT	439
MMEMory:LOAD:STATe	439
MMEMory:MDIRectory	440
MMEMory:MOVE	440
MMEMory:RDIRectory	440
MMEMory:STORe:STATe	440
MMEMory:STORe:CSV:STATe	441
SYSTem:SET:LOCK	441
SYSTem:SET:UNLock	441
SYSTem:CAPTure:CSV[:STATe]	441

MMEMory:CATalog?

This command queries the files of the current directory.

You can select directories with [MMEMory:CDIRectory](#) on page 436.

This command is a query and therefore has no *RST value.

Example: MMEM:CDIR '\Public\Limit Lines'
 Opens directory 'Limit Lines'.
 MMEM:CAT?
 Returns all files in \Public\Limit Lines.

Usage: Query only

MMEMory:CATalog:DIRectories?

This command queries the directories of the current directory.

This command is a query and therefore has no *RST value.

Example: MMEM:CDIR '\Public'
 Opens directory \Public.
 MMEM:CAT:DIR?
 Returns all directories in the \Public directory.

Usage: Query only

MMEMory:CDIRectory <PathName>

This command changes the current directory.

Parameters:

<PathName> String containing the path to another directory.

Example:

```
MMEM:CDIR '\Public'
```

Opens directory \Public.

MMEMory:COPY <SourceFile>, <Destination>

This command copies one or more files to another directory.

This command is an event and therefore has no *RST value and no query.

Parameters:

<SourceFile> String containing the path and filename of the source file.

<Destination> String containing the path and name of the destination file.

Example:

```
MMEM:COPY '\Public\Standards\cdmaOne.obwstd',
'\USB\cdmaOne.std'
```

Copies the cdmaOne standard file to a memory stick.

Usage:

Setting only

MMEMory:DATA <TargetFile>[, <Block>]

This command writes block data into a file. The delimiter must be set to EOI to obtain error-free data transfer.

When you query the contents of a file, you can save them in a file on the remote control computer.

The command is useful for reading stored settings files or trace data from the instrument or for transferring them to the instrument.

Parameters:

<TargetFile> String containing the path and filename.

<Block>

<block_data>

Data block with the structure:

represents hash sign

<number> represents length of the length information

<number> represents length information of the binary data (number of bytes)

<data> binary data with the indicated number of bytes

Example:

```
MMEM:NAME '\Public\User\Testfile.txt'
Creates a new file called 'Testfile.txt'.
MMEM:DATA
'\Public\User\Testfile.txt',#220Contents of the
file
The parameters mean:
- '\Public\...' selects the target file
- #2: hash sign and length of the length information (20 bytes = 2
digits)
- 20: indicates the number of subsequent binary data bytes
- Contents of the file: store 20 binary bytes (characters) to the
file
MMEM:DATA? '\Public\User\Testfile.txt'
Transfers the contents of the file 'Testfile.txt' to the control com-
puter.
```

MMEMory:DELeTe <File>

This command deletes a file.

Parameters:

<File> String containing the path and filename of the file to delete.

Example: MMEM:DEL '\Public\Screen Shots\Screen0001.png'
Deletes the file Screen0001.png.

Usage: Setting only

MMEMory:FILE <FileName>[, <Block>]

This command creates a file.

Parameters:

<FileName> String containing the filename.

<Block> <block_data>

Example: MMEM:FILE 'TEST.TXT'
Creates the file TEST.TXT.

MMEMory:FILE:DATE <FileName>[, <Year>, <Month>, <Day>]

This command sets the date of a file.

Parameters:

<FileName> String containing the path and filename.

<Year> Range: 1980 to 2099

<Month> Range: 1 to 12

<Day> Range: 1 to 31

Example: `MMEM:FILE:DATE '\Public\Screen
Shots\Screen0001.png',2006,04,01`
Sets the date to April, 1st, 2006.
`MMEM:FILE:DATE? '\Public\Screen
Shots\Screen0001.png'`
Returns the modification date of the file Screen0001.png.

MMEMory:FILE:TIME <FileName>[, <Hour>, <Minutes>, <Seconds>]

This command sets the time of a file. The sequence of entry is hour, minute, second.

Parameters:

<FileName> String containing the path and filename.
<Hour> Range: 0 to 23
<Minutes> Range: 0 to 59
<Seconds> Range: 0 to 59

Example: `MMEM:FILE:TIME '\Public\Screen
Shots\Screen0006.png',11,04,00`
Sets the time to 11:04:00.

MMEMory:INIT [<DriveName>]

This command formats the indicated drive.

Note: Formatting deletes all data stored on the memory drive.

This command is an event and therefore has no *RST value and no query.

Parameters:

<DriveName>

Example: `MMEM:INIT`
Formats and deletes all data from the drive.

Usage: Setting only

MMEMory:LOAD:STATE <1>, <SettingsFile>

This command loads the settings from a *.set file.

Parameters:

<1>

<SettingsFile> String containing the path and filename.

Example: `MMEM:LOAD:STAT 1,
'\Public\Datasets\Dataset001.set'`
Loads the settings from the file Dataset001.

Usage: Setting only

MMEMory:MDIRectory <DirectoryName>

This command creates a new directory.

This command is an event and therefore has no *RST value and no query.

Parameters:

<DirectoryName> String containing the path and new directory name.

Example:

```
MMEM:MDIR '\Public\USER'  
Creates a directory called 'User'.
```

Usage:

Setting only

MMEMory:MOVE <SourceFile>, <Destination>

This command renames files, if <file_destination> contains no path. Otherwise the file is moved to the indicated path and stored under the filename specified there.

This command is an event and therefore has no *RST value and no query.

Parameters:

<SourceFile> String containing the path and filename of the source file.

<Destination> String containing the path and name of the destination file.

Example:

```
MMEM:MOVE '\Public\Screen  
Shots\Screen0002.png', '\Public\Screen  
Shots\Screen0001.png'  
Renames Screen0002.png to Screen0001.png  
MMEM:MOVE '\Public\Screen  
Shots\Screen0001.png', '\Public\Test\Pic1.png'  
Moves file Screen0006.png to the 'Test' folder and renames the  
file Pic1.png.
```

Usage:

Setting only

MMEMory:RDIRectory <DirectoryName>

This command deletes the indicated directory. The directory name includes the path and may also include the drive name. The path name complies with DOS conventions.

This command is an event and therefore has no *RST value and no query.

Parameters:

<DirectoryName> String containing the path of the directory to delete.

Example:

```
MMEM:RDIR '\Public\Screen Shots\  
Deletes the directory 'Screen Shots'.
```

Usage:

Setting only

MMEMory:STORe:STATe <1>, <TargetFile>

This command stores the current device settings in a *set file.

This command is an event and therefore has no *RST value and no query.

Parameters:

<1>

<TargetFile> String containing the designated path and filename of the dataset to store.

Example: `M MEM:STOR:STAT 1, 'DATASET001.SET'`
Saves the current device settings in the file DATASET001.SET.

Usage: Setting only

M MEMory:STORe:CSV:STATe <1>, <TargetFile>

This command exports dataset to CSV format. The CSV file is saved in the same folder as the dataset file.

This works for all datasets except spectrogram and spectrogram playback.

Parameters:

<1>

<TargetFile> String containing the designated path and filename of the file to export.

Example: `M MEM:STOR:CSV:STAT 1, '\Public\Datasets\Dataset0001.set'`
Export the file Dataset0001.set to Dataset0001.csv

Usage: Setting only

SYSTem:SET:LOCK <arg0>

This command adds write-protection to a dataset.

Parameters:

<arg0> String containing the path and name of the dataset.

Example: `SYST:SET:LOCK 'Dataset001.set'`
Protects the file Dataset001.set from overwriting.

SYSTem:SET:UNLock <arg0>

This command removes write-protection from a dataset.

Parameters:

<arg0> String containing the path and name of the dataset.

Example: `SYST:SET:UNL 'Dataset001.set'`
Removes write-protection from the file Dataset001.set.

SYSTem:CAPTure:CSV[:STATe] <State>

This command enables or disables the CSV export function.

Parameters:

<State>

Example:

SYST:CAPT:CSV 1

Enables the CSV export function.

14.6.8 Making and storing screenshots

The following commands manage screenshots.

These commands are independent from the operating mode.

List of commands

DISPlay[:WINDow]:STORe.....	442
HCOPy:DEVice:LANGuage.....	442
HCOPy[:IMMediate].....	443
MMEMory:NAME.....	443

DISPlay[:WINDow]:STORe <TargetFile>

This command makes a screenshot of the current display content in png or jpg format and stores it on the R&S Spectrum Rider internal memory.

You can select a filename for the screenshot in png format with [MMEMory:NAME](#) on page 443 and select the file format of the screenshot with [HCOPy:DEVice:LANGuage](#) on page 442.

This command is an event and therefore has no *RST value and no query.

Parameters:

<TargetFile>

Example:

HCOP:DEV:LANG PNG

MMEM:NAME '\Public\Screen Shots\Test.png'

DISP:WIND:STOR

Makes and stores a screenshot of the current screen in a file 'Test.png'.

Usage:

Setting only

HCOPy:DEVice:LANGuage <Format>

This command selects the file format for screenshots.

Parameters:

<Format>

PNG | JPG

Example:

HCOP:DEV:LANG PNG

Selects the png format for screenshots.

HCOPy[:IMMediate]

This command makes a screenshot of the current display content in png format and stores it on the R&S Spectrum Rider internal memory.

You can select a filename for the screenshot in png format with [MMEMoRY:NAME](#) on page 443 and select the file format of the screenshot with [HCOPy:DEVIce:LANGUage](#) on page 442.

To make a screenshot in jpg format, use [DISPlay\[:WINDow\]:STORe](#) on page 442.

This command is an event and therefore has no *RST value and no query.

Example:

```
HCOP:DEV:LANG PNG
MMEM:NAME '\Public\Screen Shots\Test.png'
HCOP
Makes and stores a screenshot of the current screen in a file
'Test.png'.
```

Usage: Event

MMEMoRY:NAME <FileName>

This command defines the path and filename that the R&S Spectrum Rider uses for storing screenshots (see [HCOPy\[:IMMediate\]](#) on page 443). The path and filename comply with DOS conventions.

This command is an event and therefore has no *RST value and no query.

Parameters:
<FileName> String containing the filename.

Example:

```
MMEM:NAME 'Public\Screenshots\Test.png'
Stores the screenshot in the corresponding directory on the R&S
Spectrum Rider.
```

14.6.9 Configuring data capture

The following commands configure the data capture.

These commands are independent from the operating mode.

List of commands

- [SYSTem:CAPTURE:CSV\[:STATe\]](#) on page 441

For a detailed description of the commands not described below, see [File management](#).

SYSTem:CAPTURE:COUNTER	444
SYSTem:CAPTURE:DATaset[:STATe]	444
SYSTem:CAPTURE:GPX[:STATe]	444
SYSTem:CAPTURE:MODE	444
SYSTem:CAPTURE:SCReen[:STATe]	445

SYSTem:CAPTure:COUNter <CaptureCounter>

This command defines the start of the filename counter.

The counter numbers the files stored when you capture data (screenshots, datasets etc.).

Parameters:

<CaptureCounter> String containing the number with which to start numbering files.
*RST: '0000'

Example:

SYST:CAPT:COUN '0100'
Starts numbering files with 0100, e.g. Measurement0100.png.

SYSTem:CAPTure:DATaset[:STATe] <State>

This command includes or excludes datasets from the data capture.

Parameters:

<State> ON | OFF
*RST: OFF

Example:

SYST:CAPT:DAT ON
Includes datasets into the data capture.

SYSTem:CAPTure:GPX[:STATe] <State>

This command includes or excludes GPX information from the data capture.

Parameters:

<State> ON | OFF
*RST: OFF

Example:

SYST:CAPT:GPX ON
Includes GPX information into the data capture.

SYSTem:CAPTure:MODE <CaptureMode>

This command selects the data types that the R&S Spectrum Rider saves when you capture the current measurement data.

Parameters:

<CaptureMode> SCReen | DATaset | BOTH
SCReen
Saves a screenshot.
DATaset
Saves a dataset.
BOTH
Saves a screenshot and a dataset.
*RST: SCReen

Example: `SYST:CAPT:MODE BOTH`
Captures both a screenshot and a dataset of the current measurement.

SYSTem:CAPTure:SCReen[:STATe] <State>

This command includes or excludes screenshots from the data capture.

Parameters:

<State> ON | OFF
*RST: ON

Example: `SYST:CAPT:SCR ON`
Includes screenshots into the data capture.

14.6.10 Saving events

The following commands configure the circumstances under which the R&S Spectrum Rider saves events.

These commands are independent from the operating mode.

Using the commands requires a GPS receiver and a storage device (SD card or memory stick).

List of commands

SYSTem:SOEVent:DISTance:INTerval	445
SYSTem:SOEVent:LIMits:MODE	446
SYSTem:SOEVent:RECORDing:STORage	446
SYSTem:SOEVent:SOURce	446
SYSTem:SOEVent:TIME:INTerval	447
SYSTem:SOEVent[:STATe]	447

SYSTem:SOEVent:DISTance:INTerval <Seconds>

This command defines a distance that you must cover before the R&S Spectrum Rider saves another coordinate.

Parameters:

<Seconds> Distance between one coordinate and the next.
*RST: 1 m

Example: `SYST:SOEV ON`
Turns on saving coordinates on an event.
`SYST:SOEV:REC:STOR USB`
Selects a USB device as the storage device.
`SYST:SOEV:SOUR DIST`
`SYST:SOEV:DIST:INT 5`
Saves the coordinates every 5 m.

SYSTem:SOEVent:LIMits:MODE <arg0>

This command selects the limit check condition that must occur in order to save a coordinate.

Parameters:

<arg0> STARtonfail | STOPonfail | FAILonly

STARtonfail

Starts to save all sweeps from the moment a limit check fails.

STOPonfail

Saves all sweeps until a limit check fails.

FAILonly

Saves only sweeps that contain a limit check violation.

*RST: STAR

Example:

```
SYST:SOEV:SOUR LIM
```

```
SYST:SOEV:LIM:MODE FAIL
```

Saves all sweeps that contain a violation of a limit check.

SYSTem:SOEVent:RECording:STORage <arg0>

This command selects the storage device to save the coordinates to.

Parameters:

<arg0> SDCard | USB

SDCard

Saves coordinates to an SD card.

USB

Saves coordinates to a USB device.

*RST: SDCard

Example:

See [SYSTem:SOEVent:DISTance:INTerval](#) on page 445

SYSTem:SOEVent:SOURce <arg0>

This command selects the type of event that triggers saving the coordinates of your current location.

Parameters:

<arg0> TIMEinterval | LIMitsfail | DISTanceint | ALLSweeps

TIMEinterval

Saves coordinates after a certain length of time has passed.

LIMitsfail

Saves coordinates when a limit check has failed.

DISTanceint

Saves coordinates after a certain distance has been covered.

ALLSweeps

Saves coordinates after each sweep.

*RST: TIMEinterval

Example: See [SYSTem:SOEVent:DISTance:INTerval](#) on page 445.

SYSTem:SOEVent:TIME:INTerval <Seconds>

This command defines a time interval that must pass before the R&S Spectrum Rider saves another coordinate.

Parameters:

<Seconds> Time that must pass between one coordinate and the next.

*RST: 1 s

Example:

SYST:SOEV ON

Turns on saving coordinates on an event.

SYST:SOEV:REC:STOR USB

Selects a USB device as the storage device.

SYST:SOEV:SOUR TIM

SYST:SOEV:TIME:INT 5

Saves the coordinates every 5 seconds.

SYSTem:SOEVent[:STATe] <State>

This command turns saving of your current coordinates in case of certain events on and off.

Parameters:

<State> ON | OFF

*RST: OFF

Example: See [SYSTem:SOEVent:DISTance:INTerval](#) on page 445

14.6.11 Configuring the instrument

The following commands configure general instrument settings. These commands are independent from the operating mode.

- [Mode selection](#).....447
- [Controlling the GPS receiver](#).....448
- [Display configuration](#).....451
- [Audio settings](#).....453
- [Setting up a network connection](#).....454
- [System settings](#).....455

14.6.11.1 Mode selection

This chapter describes all commands that select the operating mode of the R&S Spectrum Rider.

List of commands

INSTrument[:SElect]	448
INSTrument:NSElect	448

INSTrument[:SElect] <OperatingMode>

This command selects the operating mode.

Parameters:

<OperatingMode> SANalyzer | PM | ADEModulation | DDEMod | RECeiver | MAPS

SANalyzer

Spectrum analyzer

PM

Power meter

ADEModulation

Analog modulation

DDEMod

Digital modulation

RECeiver

Receiver

MAPS

Map

*RST: PM

Example:

```
INST PM
Selects power meter mode.
```

INSTrument:NSElect <OperatingMode>

This command selects the operating mode.

Parameters:

<OperatingMode> **1**
Spectrum analyzer

5

Power meter

*RST: 1

Example:

```
INST:NSEL 5
Selects power meter mode.
```

14.6.11.2 Controlling the GPS receiver

This chapter describes all commands that control the GPS receiver.

List of commands

SYSTem:POSition:ALTitude?	449
SYSTem:POSition:COMPass:ANGLE?	449
SYSTem:POSition:COMPass:VALid?	449
SYSTem:POSition:COMPass[:STATe]	449
SYSTem:POSition:GPS:CONNected?	450
SYSTem:POSition:GPS:CORRection:FREQUency?	450
SYSTem:POSition:GPS:QUALity?	450
SYSTem:POSition:GPS:SATellites?	450
SYSTem:POSition:GPS[:STATe]	450
SYSTem:POSition:LATitude?	451
SYSTem:POSition:LONGitude?	451
SYSTem:POSition:VALid?	451
SYSTem:POSition:GPS:TIME?	451

SYSTem:POSition:ALTitude?

This command queries the altitude of the current position of the R&S Spectrum Rider.

Example: SYST:POS:ALT?
Return value would be, for example, 554.1.

Usage: Query only

SYSTem:POSition:COMPass:ANGLE?

This command queries the compass position angle of R&S Spectrum Rider.

Usage: Query only

SYSTem:POSition:COMPass:VALid?

This command queries if the compass position of R&S Spectrum Rider is valid.

Usage: Query only

SYSTem:POSition:COMPass[:STATe] <State>

This command sets or queries the compass position state of R&S Spectrum Rider.

Parameters:

<State> **0**
Compass state is off.

1
Compass state is on.

Example: SYST:POS:COMP?-> 1
Compass position state is on.

Example: SYST:POS:COMP 0
Compass position state is sets off.

SYSTem:POSition:GPS:CONNected?

This command queries if the R&S Spectrum Rider is currently connected to the GPS receiver.

Example: `SYST:POS:GPS:CONN?`

Usage: Query only

SYSTem:POSition:GPS:CORRection:FREQuency?

This command queries the frequency correction factor.

The R&S Spectrum Rider calculates this factor from a reference signal provided by the GPS receiver. The reference signal is used to determine the deviation of the internal clock of the instrument. The deviation can be turned into a correction factor for the measured frequency.

Example: `SYST:POS:GPS:CORR:FREQ?`
Queries the frequency correction factor.

Usage: Query only

SYSTem:POSition:GPS:QUALity?

This command queries the quality of the GPS signal.

Example: `SYST:POS:GPS:QUAL?`

Usage: Query only

SYSTem:POSition:GPS:SATellites?

This command queries the number of tracked satellites.

Example: `SYST:POS:GPS:SAT?`

Usage: Query only

SYSTem:POSition:GPS[:STATe] <State>

This command turns the GPS receiver on and off.

Note that the GPS receiver only works if a connection between the R&S Spectrum Rider and a GPS signal transmitter is established.

Parameters:
<State> ON | OFF
*RST: OFF

Example: `SYST:POS:GPS ON`
Activates the GPS receiver.

SYSTem:POSition:LATitude?

This command queries the latitude of the current position of the R&S Spectrum Rider.

Example: `SYST:POS:LAT?`
Return value would be, for example, 48,7,40.0 for 48°, 7', 40.0" in the northern hemisphere.

Usage: Query only

SYSTem:POSition:LONGitude?

This command queries the longitude of the current position of the R&S Spectrum Rider.

Example: `SYST:POS:LONG?`
Return value would be, for example, 11,36,46.2 for 11°, 36', 46.2" East.

Usage: Query only

SYSTem:POSition:VALid?

This command queries if the current position is valid.

Example: `SYST:POS:VAL?`

Usage: Query only

SYSTem:POSition:GPS:TIME?

This command queries the time in format HH, MM, SS.XXX (where XXX = millisec).

Usage: Query only

14.6.11.3 Display configuration

This chapter describes commands to set up the display of the R&S Spectrum Rider via remote control.

The suffix <t> is irrelevant.

List of commands

<code>DISPlay<t>:BRIGhtness</code>	451
<code>DISPlay<t>:CMAp</code>	452
<code>DISPlay<t>:CMAp:DEFault</code>	452
<code>DISPlay<t>:DATE:FORMat</code>	452

DISPlay<t>:BRIGhtness <Brightness>

This command sets the brightness of the display backlight.

Suffix:

<t> 1..n

Parameters:

<Brightness> Range: 0.01 to 1
 *RST: 0.5

Example:

DISP:BRIG 0.80
 Sets the brightness of the display to 80%.

DISPlay<t>:CMAP <ColorScheme>

This command sets the color scheme of the display.

Suffix:

<t> 1..n

Parameters:

<ColorScheme> COLor | BW | PF
COLor
 Color
BW
 Black & white
PF
 Printer-friendly
 *RST: COLor

Example:

DISP:CMAP BW
 Sets the screen colors to black and white.

DISPlay<t>:CMAP:DEFault

This command sets the display to the default state.

This command is an event and therefore has no query and no *RST value.

Suffix:

<t> 1..n

Example:

DISP:CMAP:DEF
 Restores the original color scheme.

Usage:

Event

DISPlay<t>:DATE:FORMat <DateFormat>

This command sets the display date format.

Suffix:

<t> 1..n

Parameters:

<DateFormat> DDMMyyyy | MMDDyyyy
 *RST: DDMMyyyy

Example:

DISP:DATE:FORM DDMMyyyy

14.6.11.4 Audio settings

This chapter describes all commands to control the audio functions of the R&S Spectrum Rider.

List of commands

SYSTem:AUDio:VOLume.....	453
SYSTem:BEEPer:POVerload[:STATe].....	453
SYSTem:BEEPer:VOLume.....	453
SYSTem:BEEPer:KEY:VOLume.....	454

SYSTem:AUDio:VOLume <Volume>

This command sets the volume of the internal speaker.

Parameters:

<Volume> Range: 0 to 1
 *RST: 0.3

Example:

SYST:AUD:VOL 0.40
 Sets the volume to 40%.

SYSTem:BEEPer:POVerload[:STATe] <State>

This command turns the beeper on and off when battery has reached its low-level state.

Parameters:

<State> ON | OFF
 *RST: OFF

Example:

SYST:BEEP:POV ON
 Activates the beeper state.

SYSTem:BEEPer:VOLume <Volume>

This command sets the volume of the system beeper.

Parameters:

<Volume> Range: 0 to 1
 *RST: 0.3

Example:

SYST:BEEP:VOL 0.50
 Sets the volume of the beeper to 50%.

SYSTem:BEEPer:KEY:VOLume <Volume>

This command sets the volume of the keyboard click noise.

Parameters:

<Volume> Range: 0 to 1
 *RST: 0.3

Example:

SYST:BEEP:KEY:VOL 0.10
 Sets of keyboard clicking volume to 10%.

14.6.11.5 Setting up a network connection

This chapter describes all commands that are used if the R&S Spectrum Rider is part of a network.

List of commands

SYSTem:COMMunicate:LAN:ETHernet.....	454
SYSTem:COMMunicate:LAN:GATeway.....	454
SYSTem:COMMunicate:LAN:SUBMask.....	454
SYSTem:COMMunicate:SOCKet:ADDRess.....	455
SYSTem:COMMunicate:SOCKet:DHCP[:STATe].....	455
SYSTem:COMMunicate:SOCKet:PORT.....	455

SYSTem:COMMunicate:LAN:ETHernet

This command queries the MAC address of the R&S Spectrum Rider.

This command is a query and therefore has no *RST value.

Example:

SYST:COMM:LAN:ETH?
 Returns the MAC address.

SYSTem:COMMunicate:LAN:GATeway <Gateway>

This command sets the gateway in the LAN.

Parameters:

<Gateway> String containing the identifier of the gateway.

SYSTem:COMMunicate:LAN:SUBMask <Submask>

This command sets the subnet mask of the R&S Spectrum Rider

Parameters:

<Submask> String containing the subnet mask ('x.x.x.x').
 *RST: 255.255.255.0

Example:

SYST:COMM:LAN:SUBM '255.255.255.0'
 Sets the subnet mask address to 255.255.255.0.

SYSTem:COMMunicate:SOCKet:ADDRess <IPAddress>

This command sets the IP address of the R&S Spectrum Rider.

Parameters:

<IPAddress> String containing the IP address ('x.x.x.x').
*RST: 172.76.68.24

Example:

SYST:COMM:SOCK:ADDR '172.76.68.30'
Sets the IP address of the R&S Spectrum Rider to 172.76.68.30.

SYSTem:COMMunicate:SOCKet:DHCP[:STATe] <State>

This command turns the Dynamic Host Configuration Protocol (DHCP) on and off.

Parameters:

<State> ON | OFF
*RST: ON

Example:

SYST:COMM:SOCK:DHCP ON
Activates DHCP.

SYSTem:COMMunicate:SOCKet:PORT <Port>

This command sets the port number for the connection.

Parameters:

<Port> Port number.
*RST: 5555

Example:

SYST:COMM:SOCK:PORT 1000
Sets the port number to 1000.

14.6.11.6 System settings

This chapter describes all commands that define or query general system settings.

List of commands

INPut:IMPedance:PAD.....	456
[SENSe:]ROSCillator:SOURce.....	456
SYSTem:ACCessory.....	456
SYSTem:ACCessory:AUTO.....	457
SYSTem:BNC:MODE.....	457
SYSTem:DATE.....	457
SYSTem:ERRor[:NEXT]?	458
SYSTem:ERRor:ALL?	458
SYSTem:ERRor:CODE[:NEXT]?	458
SYSTem:ERRor:CODE:ALL?	458
SYSTem:ERRor:COUNT?	458
SYSTem:FORMat:IDENT.....	459

<code>SYSTem:HELP:HEADers?</code>	459
<code>SYSTem:HELP:SYNTax?</code>	459
<code>SYSTem:LANGuage</code>	459
<code>SYSTem:LANGuage:CATalog?</code>	460
<code>SYSTem:POWer:SOURce?</code>	460
<code>SYSTem:POWer:STATus?</code>	460
<code>SYSTem:PRESet</code>	460
<code>SYSTem:PRESet:CALibration:DISCard</code>	460
<code>SYSTem:PRESet:FACTory</code>	461
<code>SYSTem:PRESet:MODE</code>	461
<code>SYSTem:PRESet:USER</code>	461
<code>SYSTem:REBoot</code>	461
<code>SYSTem:SET</code>	462
<code>SYSTem:SHUTdown</code>	462
<code>SYSTem:TIME</code>	462
<code>SYSTem:TZONee</code>	462
<code>SYSTem:VERSion?</code>	463

INPut:IMPedance:PAD <PadType>

This command selects the matching pad connected to the R&S Spectrum Rider.

Parameters:

<PadType> RAM | RAZ | HZTE

Example:

`INPut:IMP 75;PAD RAZ`

Selects 75 Ω input impedance and the R&S RAZ as the matching pad.

[SENSe:]ROSCillator:SOURce <Format>

This command selects the source of the frequency reference oscillator.

If you use an external reference signal, make sure to connect the signal to the Ext Ref BNC connector of the R&S Spectrum Rider.

Parameters:

<Format> INTernal | EXTernal

INTernal

Internal reference.

EXTernal

External reference.

Example:

`ROSC:SOUR EXT`

Activates external source as reference signal.

SYSTem:ACCessory <Accessory>

This command queries the type of measurement accessory, if one is connected to the R&S Spectrum Rider (for example a power sensor).

Parameters:

<Accessory> Z1 | Z2 | Z3 | Z14 | Z18 | Z44 | TS_emf | ZN_Z103 | NONE | UNKNown
Name of the accessory.

Example:

SYST:ACC?
Queries connected measurement accessories.

SYSTem:ACCessory:AUTO <State>

This command turns automatic detection of connected measurement accessories on and off.

Parameters:

<State> ON | OFF

Example:

SYST:ACC:AUTO ON
Turns on automatic accessory detection.

SYSTem:BNC:MODE <BNCUsage>

This command configures the BNC sockets.

Parameters:

<BNCUsage> REFerence | TRIGger | BIAS

REFerence

Input for external reference signal.

TRIGger

Input for external trigger.

BIAS

BIAS port.

*RST: TRIGger

Example:

SYST:BNC:MODE BIAS
Sets the BNC socket to bias.

SYSTem:DATE <Year>, <Month>, <Day>

This command sets the date for the internal calendar.

Parameters:

<Year> Range: 1980 to 2099

<Month> Range: 1 to 12

<Day> Range: 1 to 31

Example:

SYST:DATE 2000,6,1
Sets the date to 1/6/2000.

SYSTem:ERRor[:NEXT]?

This command queries the oldest entry in the error queue and deletes it.

This command is a query and therefore has no *RST value.

Example: STAT:ERR?

Usage: Query only

SYSTem:ERRor:ALL?

This command queries the complete error queue.

This command is a query and therefore no *RST value.

Example: SYST:ERR:ALL?

Usage: Query only

SYSTem:ERRor:CODE[:NEXT]?

This command queries the code of the next error in the error queue.

This command is a query and therefore has no *RST value.

Example: STAT:ERR:CODE?

Usage: Query only

SYSTem:ERRor:CODE:ALL?

This command queries the complete error queue.

This command is a query and therefore no *RST value.

Example: SYST:ERR:CODE:ALL?

Usage: Query only

SYSTem:ERRor:COUNt?

This command queries the number of errors currently in the error queue.

This command is a query and therefore no *RST value.

Example: SYST:ERR:COUN?

Usage: Query only

SYSTem:FORMat:IDENt <Format>

This command sets the response format to the *IDN? query. This function is intended for re-use of existing control programs together with the R&S Spectrum Rider.

Parameters:

<Format> LEGacy | NEW

LEGacy

Format that is compatible to the older R&S Spectrum Rider version.

NEW

Format that is compatible to the newer R&S Spectrum Rider version.

Example:

```
SYST:FORM:IDEN LEG
```

```
*IDN?
```

IDN would return the older R&S Spectrum Rider version.

```
SYST:FORM:IDEN NEW
```

```
*IDN?
```

IDN would return the newer R&S Spectrum Rider version.

SYSTem:HELP:HEADers?

This command returns a list of all available remote control commands.

This command is a query and therefore no *RST value.

Example:

```
SYST:HELP:HEAD?
```

Returns the syntax of all available commands.

Usage:

Query only

SYSTem:HELP:SYNTax? <arg0>

This command returns the full syntax of the specified command.

This command is a query and therefore no *RST value.

Parameters:

<arg0> String containing the command you want to query.

Example:

```
SYST:HELP:SYNT? 'SYST:ERR?'
```

Returns the full syntax. In this case: 'SYSTem:ERRor[:NEXT]'.

Usage:

Query only

SYSTem:LANGUage <Language>

This command sets the language of the user interface. You can query a list of available languages with [SYSTem:LANGUage:CATalog?](#) on page 460.

Parameters:

<Language> String containing the language.

Example: `SYST:LANG 'english'`
Sets the system language to English.

SYSTem:LANGuage:CATalog?

This command lists all languages available for the user interface.

This command is a query and therefore no *RST value.

Example: `SYST:LANG:CAT?`

Usage: Query only

SYSTem:POWer:SOURce?

This command queries the current R&S Spectrum Rider power source.

This command is a query and therefore has no *RST value.

Example: `SYST:POW:SOUR?`

Usage: Query only

SYSTem:POWer:STATus?

This command queries the remaining power of the battery.

This command is a query and therefore has no *RST value.

Example: `SYST:POW:STAT?`

Usage: Query only

SYSTem:PRESet

Resets the R&S Spectrum Rider to its default state or a state defined by the user, depending on SYSTem:PRESet:MODE.

This command is an event and therefore has no *RST value and no query.

Example: `SYST:PRES`

Usage: Event

SYSTem:PRESet:CALibration:DISCard <Disc>

This command turns the mechanism that discards or keeps user calibration after a pre-set on and off.

Parameters:

<Disc> ON | OFF

ON

Discards user calibration after a preset.

OFF

Keep user calibration after a preset.

*RST: OFF

Example:

SYST:PRES:CAL:DISC ON

Discards user calibration after a preset.

SYSTem:PRESet:FACTory

This command initiates an instrument reset back to factory settings.

This command is an event and therefore has no query and no *RST value.

Example:

SYST:PRES:FACT

Resets the R&S Spectrum Rider to its factory settings.

Usage:

Event

SYSTem:PRESet:MODE <Mode>

This command selects the preset mode.

Parameters:

<Mode> DEFault | USER

DEFault

Default preset state.

USER

User defined preset state.

Example:

SYST:PRES:MODE USER

Selects a user defined preset.

SYSTem:PRESet:USER <PathName>

This command selects a file containing a user defined preset state.

Parameters:

<PathName> Filename of the user defined preset state.

SYSTem:REBoot

This command initiates a reboot of the R&S Spectrum Rider.

This command is an event and therefore has no *RST value and no query.

Example:

SYST:REB

Restarts the R&S Spectrum Rider.

Usage:

Event

SYSTem:SET [<arg0>]

This query `SYSTem:SET?` causes the data of the current instrument setting to be transmitted to the control computer in binary format (SAVE function). The data can be read back into the instrument (RECALL function) by means of command `SYSTem:SET <block>`.

Whilst the data records are stored on the instrument hard disk with SAVE/RECALL (`MMEMoRY:STORe`, `MMEMoRY:LOAD`), it is possible to store the data in an external computer by means of `SYSTem:SET`.

The receive terminator has to be set to EOI to ensure reliable transfer of data (setting `SYST:COMM:GPIB:RTER EOI`).

Parameters:

<arg0> <block_data>

Example: `SYST:SET`

SYSTem:SHUTdown

This command turns the R&S Spectrum Rider off.

This command is an event and therefore has no *RST value and no query.

Example: `SYST:SHUT`
Turns the R&S Spectrum Rider off.

Usage: Event

SYSTem:TIME <Hour>, <Minutes>, <Seconds>

This command sets the internal clock.

Parameters:

<Hour> Range: 0 to 23

<Minutes> Range: 0 to 59

<Seconds> Range: 0 to 59

Example: `SYST:TIME 12,30,30`

SYSTem:TZONee <Hour>, <Minutes>

This command defines a shift of the system time to select another time zone.

Parameters:

<Hour> Range: 0 to 23

<Minutes> Range: 0 to 59
*RST: 0,0

Example: `SYST:TZON 01,00`
Shifts the time an hour ahead.

SYSTem:VERSion?

This command queries the SCPI version the remote control is based on.

This command is a query and therefore has no *RST value.

Example: SYST:VERS?

Usage: Query only

14.6.12 Status reporting system

The status reporting system stores all information on the present operating state of the instrument, and on errors which have occurred. This information is stored in the status registers and in the error queue. The status registers and the error queue can be queried via Ethernet.

The information is of a hierarchical structure. The register status byte (STB) defined in IEEE 488.2 and its associated mask register service request enable (SRE) form the uppermost level. The STB receives its information from the standard event status register (ESR) which is also defined in IEEE 488.2 with the associated mask register standard event status enable (ESE) and registers `STATus:OPERation` and `STATus:QUESTionable` which are defined by SCPI and contain detailed information on the instrument.

The output buffer contains the messages the instrument returns to the controller. It is not part of the status reporting system but determines the value of the MAV bit in the STB.

- [Structure of a SCPI status register](#).....463
- [Overview of the status register](#).....465
- [Status byte \(STB\) & service request enable register \(SRE\)](#)..... 466
- [Event status register \(ESR\) and event status enable register \(ESE\)](#).....467
- [Application of the status reporting systems](#).....470
- [Reset values of the status reporting system](#)..... 472
- [Remote commands of the status reporting system](#).....472

14.6.12.1 Structure of a SCPI status register

Each standard SCPI register consists of 5 parts which each have a width of 16 bits and have different functions. The individual bits are independent of each other, i.e. each hardware status is assigned a bit number that applies to all five parts. For example, bit 0 of the `STATus:OPERation` register is assigned to the calibration status of the R&S Spectrum Rider. Bit 15 (the most significant bit) is set to zero for all parts. Thus the contents of the register parts can be processed by the controller as positive integer.

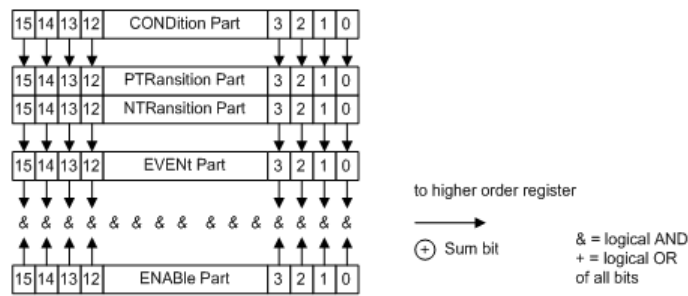

Figure 14-6: The status-register model

CONDition part

The CONDition part is directly written into by the hardware or the sum bit of the next lower register. Its contents reflects the current instrument status. This register part can only be read, but not written into or cleared. Its contents is not affected by reading.

PTRansition part

The Positive-TRansition part acts as an edge detector. When a bit of the CONDition part is changed from 0 to 1, the associated PTR bit decides whether the EVENt bit is set to 1.

PTR bit =1: the EVENt bit is set.

PTR bit =0: the EVENt bit is not set.

This part can be written into and read at will. Its contents is not affected by reading.

NTRansition part

The Negative-TRansition part also acts as an edge detector. When a bit of the CONDition part is changed from 1 to 0, the associated NTR bit decides whether the EVENt bit is set to 1.

NTR-Bit = 1: the EVENt bit is set.

NTR-Bit = 0: the EVENt bit is not set.

This part can be written into and read at will. Its contents is not affected by reading.

With these two edge register parts, you can define which state transition of the condition part (none, 0 to 1, 1 to 0 or both) is stored in the EVENt part.

EVENt part

The EVENt part indicates whether an event has occurred since the last reading, it is the "memory" of the condition part. It only indicates events passed on by the edge filters. It is permanently updated by the instrument. This part can only be read by you. Reading the register clears it. This part is often equated with the entire register.

ENABle part

The ENABle part determines whether the associated EVENt bit contributes to the sum bit (see below). Each bit of the EVENt part is ANDed with the associated ENABle bit

(symbol '&'). The results of all logical operations of this part are passed on to the sum bit via an OR function (symbol '+').

ENABLE-Bit = 0: the associated EVENT bit does not contribute to the sum bit

ENABLE-Bit = 1: if the associated EVENT bit is "1", the sum bit is set to "1" as well.

This part can be written into and read by you at will. Its contents is not affected by reading.

Sum bit

As indicated above, the sum bit is obtained from the EVENT and ENABLE part for each register. The result is then entered into a bit of the CONDition part of the higher-order register.

The instrument automatically generates the sum bit for each register. Thus an event, e.g. a PLL that has not locked, can lead to a service request throughout all levels of the hierarchy.



The service request enable register SRE defined in IEEE 488.2 can be taken as ENABLE part of the STB if the STB is structured according to SCPI. By analogy, the ESE can be taken as the ENABLE part of the ESR.

14.6.12.2 Overview of the status register

The following figure shows the status registers used by the R&S Spectrum Rider.

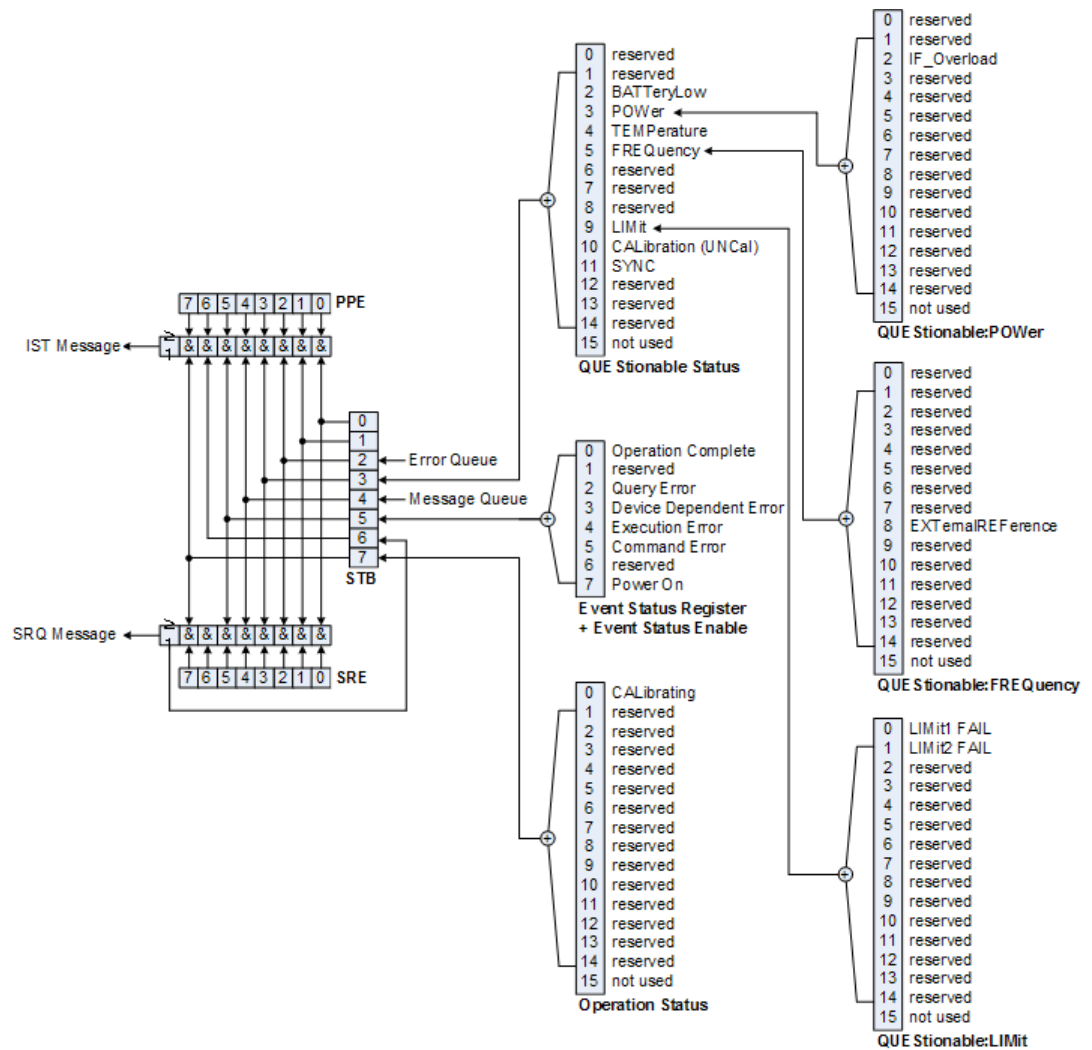

Figure 14-7: Overview of the status registers

14.6.12.3 Status byte (STB) & service request enable register (SRE)

The STB is already defined in IEEE 488.2. It provides a rough overview of the instrument status by collecting the pieces of information of the lower registers. It can thus be compared with the CONDition part of an SCPI register and assumes the highest level within the SCPI hierarchy. A special feature is that bit six acts as the sum bit of the remaining bits of the status byte.

The STATUS BYTE is read using the command `*STB?` or a serial poll.

The STB is linked to the SRE. The latter corresponds to the ENABLE part of the SCPI registers in its function. Each bit of the STB is assigned a bit in the SRE. Bit 6 of the SRE is ignored. If a bit is set in the SRE and the associated bit in the STB changes from 0 to 1, a service request (SRQ) is generated, which triggers an interrupt in the controller if this is appropriately configured and can be further processed there. The SRE can be set using the command `"*SRE"` and read using the command `*SRE?`

Table 14-8: Meaning of the bits used in the status byte

Bit no.	Meaning
0 to 1	Not used
2	<p>Error Queue not empty</p> <p>The bit is set when an entry is made in the error queue.</p> <p>If this bit is enabled by the SRE, each entry of the error queue generates a service request. Thus an error can be recognized and specified in greater detail by polling the error queue. The poll provides an informative error message. This procedure is to be recommended since it considerably reduces the problems involved with remote control.</p>
3	<p>QUESTionable status sum bit</p> <p>The bit is set if an EVENT bit is set in the QUESTionable: status register and the associated ENABle bit are set to 1.</p> <p>A set bit indicates a questionable instrument status, which can be specified in greater detail by polling the QUESTionable status register.</p>
4	<p>MAV bit (message available)</p> <p>The bit is set if a message is available in the output buffer which can be read.</p> <p>This bit can be used to enable data to be automatically read from the instrument to the controller.</p>
5	<p>ESB bit</p> <p>Sum bit of the event status register. It is set if one of the bits in the event status register is set and enabled in the event status enable register.</p> <p>Setting of this bit indicates a serious error which can be specified in greater detail by polling the event status register.</p>
6	<p>MSS bit (master status summary bit)</p> <p>The bit is set if the instrument triggers a service request. This is the case if one of the other bits of this register is set together with its mask bit in the service request enable register SRE.</p>
7	<p>OPERation status register sum bit</p> <p>The bit is set if an EVENT bit is set in the OPERation status register and the associated ENABle bit is set to 1.</p> <p>A set bit indicates that the instrument is just performing an action. The type of action can be determined by polling the OPERation status register.</p>

14.6.12.4 Event status register (ESR) and event status enable register (ESE)

The ESR is defined in IEEE 488.2. It can be compared with the EVENT part of an SCPI register. The event status register can be read out using command `*ESR?`.

The ESE is the associated ENABle part. It can be set using the command `*ESE` and read using the command `*ESE?`.

Table 14-9: Meaning of the bits in the event status register

Bit No.	Meaning
0	<p>Operation Complete</p> <p>This bit is set on receipt of the command <code>*OPC</code> exactly when all previous commands have been executed.</p>
1	Not used

Bit No.	Meaning
2	Query Error This bit is set if either the controller wants to read data from the instrument without having sent a query, or if it does not fetch requested data and sends new instructions to the instrument instead. The cause is often a query which is faulty and hence cannot be executed.
3	Device-dependent Error This bit is set if a device-dependent error occurs. An error message with a number between -300 and -399 or a positive error number, which denotes the error in greater detail, is entered into the error queue.
4	Execution Error This bit is set if a received command is syntactically correct but cannot be performed for other reasons. An error message with a number between -200 and -300, which denotes the error in greater detail, is entered into the error queue.
5	Command Error This bit is set if a command is received, which is undefined or syntactically incorrect. An error message with a number between -100 and -200, which denotes the error in greater detail, is entered into the error queue.
6	Not used
7	Power On (supply voltage on) This bit is set on switching on the instrument.

STATus:OPERation register

In the CONDition part, this register contains information on which actions the instrument is being executing or, in the EVENT part, information on which actions the instrument has executed since the last reading. It can be read using the commands `STATus:OPERation:CONDition?` or `STATus:OPERation[:EVENT]?`.

Table 14-10: Meaning of the bits in the STATus:OPERation register

Bit no.	Meaning
0	CALibrating This bit is set as long as the instrument is performing a calibration.
1 to 14	Not used
15	This bit is always 0

STATus:QUESTionable register

This register contains information about indefinite states which may occur if the unit is operated without meeting the specifications. It can be read using the commands `STATus:QUESTionable:CONDition?` and `STATus:QUESTionable[:EVENT]?`.

Table 14-11: Meaning of bits in STATUS:QUESTIONable register

Bit no.	Meaning
0 to 1	These bits are not used
2	BATTERY LOW If the instrument is running without any external power supply and the charging level of the internal battery is approximately lower than 5%, this bit is set to indicate that the system is shut down automatically in approximately 5 minutes.
3	Not used
4	TEMPerature This bit is set if a questionable temperature occurs.
5 to 8	Not used
9	LIMit (device-specific) This bit is set if a limit value is violated
10	CALibration The bit is set if a measurement is performed unaligned (label UNCAL)
11 to 14	Not used
15	This bit is always 0.

STATUS:QUESTIONable:FREQUENCY register

This register contains information about the reference frequency. It can be read using the commands `STATUS:QUESTIONable:LIMit:FREQUENCY?` and `STATUS:QUESTIONable:FREQUENCY[:EVENT]?`.

Table 14-12: Meaning of bits in STATUS:QUESTIONable:FREQUENCY register

Bit no.	Meaning
0 to 7	Not used
8	EXTernal REFerence This bit is set if an external reference is used.
9 to 14	Not used
15	This bit is always 0.

STATUS:QUESTIONable:LIMit register

This register contains information about the observance of limit lines. It can be read using the commands `STATUS:QUESTIONable:LIMit:CONDition?` and `STATUS:QUESTIONable:LIMit[:EVENT]?`.

Table 14-13: Meaning of bits in STATUS:QUESTIONable:LIMit register

Bit no.	Meaning
0	LIMit 1 FAIL This bit is set if limit line 1 is violated.
1	LIMit 2 FAIL This bit is set if limit line 2 is violated.
2 to 14	Not used
15	This bit is always 0.

STATUS:QUESTIONable:POWER register

This register contains information about possible overload states. It can be read using the commands `STATUS:QUESTIONable:POWER:CONDition?` and `STATUS:QUESTIONable:POWER[:EVENT]?`.

Table 14-14: Meaning of bits in STATUS:QUESTIONable:POWER register

Bit no.	Meaning
0 to 1	Not used
2	IF_Overload This bit is set if the IF path is overloaded. 'IFOVL' is displayed.
3 to 14	Not used
15	This bit is always 0.

STATUS:QUESTIONable:SYNC register

This register contains information about sync and bursts not found, and about premeasurement results exceeding or falling short of expected values.

It can be read using the commands `STATUS:QUESTIONable:SYNC:CONDition?` and `STATUS:QUESTIONable:SYNC[:EVENT]?`.

14.6.12.5 Application of the status reporting systems

In order to be able to effectively use the status reporting system, the information contained there must be transmitted to the controller and further processed there. There are several methods which are represented in the following.

Service request

Under certain circumstances, the instrument can send a service request (SRQ) to the controller. Usually this service request initiates an interrupt at the controller, to which the control program can react appropriately.

As evident from [Figure 14-7](#), an SRQ is always initiated if one or several of bits 2, 3, 4, 5 or 7 of the status byte are set and enabled in the SRE. Each of these bits combines the information of a further register, the error queue or the output buffer. The ENABLE parts of the status registers can be set so that arbitrary bits in an arbitrary status regis-

ter initiate an SRQ. In order to make use of the possibilities of the service request effectively, all bits should be set to "1" in enable registers SRE and ESE.

Example:

Use of the command *OPC to generate an SRQ at the end of a sweep.

- `CALL InstrWrite(analyzer, "*ESE 1")`
'Set bit 0 in the ESE (Operation Complete)
- `CALL InstrWrite(analyzer, "*SRE 32")`
'Set bit 5 in the SRE (ESB)?

After its settings have been completed, the instrument generates an SRQ.

The SRQ is the only possibility for the instrument to become active on its own. Each controller program should set the instrument in a way that a service request is initiated in the case of malfunction. The program should react appropriately to the service request.

Serial poll

In a serial poll, just as with command *STB, the status byte of an instrument is queried. However, the query is realized via interface messages and is thus clearly faster. The serial-poll method has already been defined in IEEE 488.1 and used to be the only standard possibility for different instruments to poll the status byte. The method also works with instruments which do not adhere to SCPI or IEEE 488.2.

The VISUAL BASIC command for executing a serial poll is IBRSP(). Serial poll is mainly used to obtain a fast overview of the state of several instruments connected to the controller.

Query by means of commands

Each part of any status register can be read by means of queries. The individual commands are listed in the description of the STATUS Subsystem. The returned value is always a number that represents the bit pattern of the queried register. This number is evaluated by the controller program.

Queries are usually used after an SRQ in order to obtain more detailed information on the cause of the SRQ.

Error queue query

Each error state in the instrument leads to an entry in the error queue. The entries of the error queue are detailed plain-text error messages that can be displayed via manual operation using the setup menu or queried via remote control using the command `SYSTEM:ERROR?`. Each call of `SYSTEM:ERROR?` provides one entry from the error queue. If no error messages are stored there any more, the instrument responds with 0, "No error".

The error queue should be queried after every SRQ in the controller program as the entries describe the cause of an error more precisely than the status registers. Especially in the test phase of a controller program the error queue should be queried regu-

larly since faulty commands from the controller to the instrument are recorded there as well.

14.6.12.6 Reset values of the status reporting system

Table 14-15 contains the different commands and events causing the status reporting system to be reset. None of the commands, except *RST and SYSTem:PRESet, influences the functional instrument settings. In particular, DCL does not change the instrument settings.

Table 14-15: Resetting the status reporting system

Event	Switching on supply voltage	DCL, SDC				
	Power-On-Status-Clear		(Device Clear, Selected Device Clear)	*RST or SYSTem:PRESet	STAtus:PRESet	*CLS
Effect	0	1				
Clear STB, ESR	-	yes	-	-	-	yes
Clear SRE, ESE	-	yes	-	-	-	-
Clear PPE	-	yes	-	-	-	-
Clear EVENT parts of the registers	-	yes	-	-	-	yes
Clear ENABLE parts of all OPERATION and QUESTIONABLE registers; Fill ENABLE parts of all other registers with "1".	-	yes	-	-	yes	-
Fill PTRansition parts with "1"; Clear NTRansition parts	-	yes	-	-	yes	-
Clear error queue	yes	yes	-	-	-	yes
Clear output buffer	yes	yes	yes	1)	1)	1)
Clear command processing and input buffer	yes	yes	yes	-	-	-

1) Every command being the first in a program message, i.e., immediately following a <PROGRAM MESSAGE TERMINATOR> clears the output buffer.

14.6.12.7 Remote commands of the status reporting system

The following commands control the status-reporting system *RST does not influence the status registers.

The OPERation status register contains information about the calibration status of the instrument.

The QUESTionable status register contains information about the status of the reference and local oscillator, possible overloads of the instrument and the status of limit checks and limit margins.

The commands are independent from the operating mode.

List of commands

STATus:PRESet.....	473
STATus:QUEue[:NEXT]?.....	474
STATus:OPERation[:EVENT]?.....	474
STATus:OPERation:CONDition?.....	474
STATus:OPERation:ENABle.....	474
STATus:OPERation:NTRansition.....	474
STATus:OPERation:PTRansition.....	475
STATus:QUESTionable[:EVENT]?.....	475
STATus:QUESTionable:FREQuency[:EVENT]?.....	475
STATus:QUESTionable:LIMit[:EVENT]?.....	475
STATus:QUESTionable:POWer[:EVENT]?.....	475
STATus:QUESTionable:CONDition?.....	475
STATus:QUESTionable:FREQuency:CONDition?.....	476
STATus:QUESTionable:LIMit:CONDition?.....	476
STATus:QUESTionable:POWer:CONDition?.....	476
STATus:QUESTionable:ENABle.....	476
STATus:QUESTionable:FREQuency:ENABle.....	476
STATus:QUESTionable:LIMit:ENABle.....	476
STATus:QUESTionable:POWer:ENABle.....	477
STATus:QUESTionable:NTRansition.....	477
STATus:QUESTionable:FREQuency:NTRansition.....	477
STATus:QUESTionable:LIMit:NTRansition.....	477
STATus:QUESTionable:POWer:NTRansition.....	478
STATus:QUESTionable:PTRansition.....	478
STATus:QUESTionable:FREQuency:PTRansition.....	478
STATus:QUESTionable:LIMit:PTRansition.....	478
STATus:QUESTionable:POWer:PTRansition.....	479

STATus:PRESet

This command resets the edge detectors and ENABle parts of all registers to a defined value. All PTRansition parts are set to FFFFh, i.e. all transitions from 0 to 1 are detected. All NTRansition parts are set to 0, i.e. a transition from 1 to 0 in a CONDition bit is not detected. The ENABle part of the STATus:OPERation and STATus:QUESTionable registers are set to 0, i.e. all events in these registers are not passed on.

Example: STAT:PRESet

Usage: Event

STATus:QUEue[:NEXT]?

This command returns the earliest entry to the error queue and deletes it.

Positive error numbers indicate device-specific errors, negative error numbers are error messages defined by SCPI. If the error queue is empty, the error number 0, "no error", is returned. This command is identical with the command SYSTem:ERRor.

Example: STAT:QUE?

Usage: Query only

STATus:OPERation[:EVENT]?

This command reads out the EVENT section of the OPERation register.

The command at the same time deletes the contents of the EVENT section.

Usage: Query only

STATus:OPERation:CONDition?

This command reads out the CONDition section of the OPERation register.

The command does not delete the contents of the EVENT section.

Usage: Query only

STATus:OPERation:ENABLE <DecimalValue>

This command controls the ENABLE part of the OPERation register.

The ENABLE part allows true conditions in the EVENT part of the status register to be reported in the summary bit. If a bit is 1 in the enable register and its associated event bit transitions to true, a positive transition occurs in the summary bit reported to the next higher level.

Parameters:

<DecimalValue> Range: 0 to 65535

STATus:OPERation:NTRansition <DecimalValue>

This command controls the Negative TRansition part of the OPERation register.

Setting a bit causes a 1 to 0 transition in the corresponding bit of the associated register. The transition also writes a 1 into the associated bit of the corresponding EVENT register.

Parameters:

<DecimalValue> Range: 0 to 65535

STATus:OPERation:PTRansition <DecimalValue>

This command controls the Positive TRansition part of the OPERation register.

Setting a bit causes a 0 to 1 transition in the corresponding bit of the associated register. The transition also writes a 1 into the associated bit of the corresponding EVENT register.

Parameters:

<DecimalValue> Range: 0 to 65535

STATus:QUEStionable[:EVENT]?

This command reads out the EVENT section of the QUEStionable register.

The command at the same time deletes the contents of the EVENT section.

Usage: Query only

STATus:QUEStionable:FREQuency[:EVENT]?

This command reads out the EVENT section of the QUEStionable register.

The command at the same time deletes the contents of the EVENT section.

Usage: Query only

STATus:QUEStionable:LIMit[:EVENT]?

This command reads out the EVENT section of the QUEStionable register.

The command at the same time deletes the contents of the EVENT section.

Usage: Query only

STATus:QUEStionable:POWer[:EVENT]?

This command reads out the EVENT section of the QUEStionable register.

The command at the same time deletes the contents of the EVENT section.

Usage: Query only

STATus:QUEStionable:CONDition?

This command reads out the CONDition section of the QUEStionable register.

The command does not delete the contents of the EVENT section.

Usage: Query only

STATus:QUESTIONable:FREQuency:CONDition?

This command reads out the CONDition section of the QUEStionable register.

The command does not delete the contents of the EVENT section.

Usage: Query only

STATus:QUESTIONable:LIMit:CONDition?

This command reads out the CONDition section of the QUEStionable register.

The command does not delete the contents of the EVENT section.

Usage: Query only

STATus:QUESTIONable:POWer:CONDition?

This command reads out the CONDition section of the QUEStionable register.

The command does not delete the contents of the EVENT section.

Usage: Query only

STATus:QUESTIONable:ENABle <DecimalValue>

This command controls the ENABle part of the QUEStionable register.

The ENABle part allows true conditions in the EVENT part of the status register to be reported in the summary bit. If a bit is 1 in the enable register and its associated event bit transitions to true, a positive transition will occur in the summary bit reported to the next higher level.

Parameters:

<DecimalValue> Range: 0 to 65535

STATus:QUESTIONable:FREQuency:ENABle <DecimalValue>

This command controls the ENABle part of the QUEStionable register.

The ENABle part allows true conditions in the EVENT part of the status register to be reported in the summary bit. If a bit is 1 in the enable register and its associated event bit transitions to true, a positive transition will occur in the summary bit reported to the next higher level.

Parameters:

<DecimalValue> Range: 0 to 65535

STATus:QUESTIONable:LIMit:ENABle <DecimalValue>

This command controls the ENABle part of the QUEStionable register.

The ENABLE part allows true conditions in the EVENT part of the status register to be reported in the summary bit. If a bit is 1 in the enable register and its associated event bit transitions to true, a positive transition will occur in the summary bit reported to the next higher level.

Parameters:

<DecimalValue> Range: 0 to 65535

STATus:QUESTIONable:POWER:ENABLE <DecimalValue>

This command controls the ENABLE part of the QUESTIONable register.

The ENABLE part allows true conditions in the EVENT part of the status register to be reported in the summary bit. If a bit is 1 in the enable register and its associated event bit transitions to true, a positive transition occurs in the summary bit reported to the next higher level.

Parameters:

<DecimalValue> Range: 0 to 65535

STATus:QUESTIONable:NTRansition <DecimalValue>

This command controls the Negative TRansition part of the QUESTIONable register.

Setting a bit causes a 1 to 0 transition in the corresponding bit of the associated register. The transition also writes a 1 into the associated bit of the corresponding EVENT register.

Parameters:

<DecimalValue> Range: 0 to 65535

Example: STAT:QUES:NTR 65535

STATus:QUESTIONable:FREQuency:NTRansition <DecimalValue>

This command controls the Negative TRansition part of the QUESTIONable register.

Setting a bit causes a 1 to 0 transition in the corresponding bit of the associated register. The transition also writes a 1 into the associated bit of the corresponding EVENT register.

Parameters:

<DecimalValue> Range: 0 to 65535

Example: STAT:QUES:NTR 65535

STATus:QUESTIONable:LIMit:NTRansition <DecimalValue>

This command controls the Negative TRansition part of the QUESTIONable register.

Setting a bit causes a 1 to 0 transition in the corresponding bit of the associated register. The transition also writes a 1 into the associated bit of the corresponding EVENT register.

Parameters:

<DecimalValue> Range: 0 to 65535

Example:

STAT:QUES:NTR 65535

STATus:QUESTIONable:POWER:NTRansition <DecimalValue>

This command controls the Negative TRansition part of the QUESTionable register.

Setting a bit causes a 1 to 0 transition in the corresponding bit of the associated register. The transition also writes a 1 into the associated bit of the corresponding EVENT register.

Parameters:

<DecimalValue> Range: 0 to 65535

Example:

STAT:QUES:NTR 65535

STATus:QUESTIONable:PTRansition <DecimalValue>

This command control the Positive TRansition part of the QUESTionable register.

Setting a bit causes a 0 to 1 transition in the corresponding bit of the associated register. The transition also writes a 1 into the associated bit of the corresponding EVENT register.

Parameters:

<DecimalValue> Range: 0 to 65535

STATus:QUESTIONable:FREQuency:PTRansition <DecimalValue>

This command control the Positive TRansition part of the QUESTionable register.

Setting a bit causes a 0 to 1 transition in the corresponding bit of the associated register. The transition also writes a 1 into the associated bit of the corresponding EVENT register.

Parameters:

<DecimalValue> Range: 0 to 65535

STATus:QUESTIONable:LIMit:PTRansition <DecimalValue>

This command control the Positive TRansition part of the QUESTionable register.

Setting a bit causes a 0 to 1 transition in the corresponding bit of the associated register. The transition also writes a 1 into the associated bit of the corresponding EVENT register.

Parameters:

<DecimalValue> Range: 0 to 65535

STATus:QUESTionable:POWer:PTRansition <DecimalValue>

This command control the Positive TRansition part of the QUESTionable register.

Setting a bit causes a 0 to 1 transition in the corresponding bit of the associated register. The transition also writes a 1 into the associated bit of the corresponding EVENT register.

Parameters:

<DecimalValue> Range: 0 to 65535

15 Menu and softkey overview

This chapter shows an overview of all instrument functions in the form of softkey and menu overview.

- [General functions](#).....480
- [Functions of the spectrum analyzer](#).....486
- [Functions of the power meter](#).....502
- [Functions of the wizard](#).....510
- [Functions of the modulation analysis](#).....513
- [Functions of the receiver](#).....517
- [Functions of the maps](#).....522

15.1 General functions

- [General R&S Spectrum Rider setup](#).....480
- [File management](#).....484
- [Operating mode selection](#).....486

15.1.1 General R&S Spectrum Rider setup



R&S Spectrum Rider options

¹ only available with R&S FPH-K35

The [SETUP] key opens the setup menu that contains functionality to set up the R&S Spectrum Rider in general and functionality to set up the measurement.

Softkey	Menu or Dialog items	Parameters	Parameters selection
Config Overview	Input	RF Impedance	50 Ω, 75 Ω RAM, 75 Ω RAZ, 75 Ω FSH-Z38
		Power Sensor	Channel
	Amplitude	Ref Level	
		Ref Offset	
		Att Mode	Manual, Auto Low Distortion, Auto Low Noise
		RF Attenuation	
		RF Preamplifier	On, Off
	Frequency	Center Freq	
		Freq Offset	

Softkey	Menu or Dialog items	Parameters	Parameters selection	
		Span	Manual Span, Full Span, Zero Span, Last Span	
		Bandwidth	RBW	Man-ual 1 Hz, 3 Hz, 10 Hz, 30 Hz, 100Hz, 300 Hz, 1 kHz, 3 kHz, 10 kHz, 30 kHz, 100 kHz, 300 kHz, 1 MHz, 3 MHz,
				Auto
			VBW	Man-ual 1 Hz, 3 Hz, 10 Hz, 30 Hz, 100Hz, 300 Hz, 1 kHz, 3 kHz, 10 kHz, 30 kHz, 100 kHz, 300 kHz, 1 MHz, 3 MHz,
		Auto		
	SWT	Manual, Auto		
	Analy-sis	Analysis for T1	Trace Mode	Clear/Write, Max Hold Min Hold, Average
			Average Count	
			Trace Math	Off, Trace - Memory, Memory - Trace
		Analysis for T2	Detector	Auto Man-ual Auto Peak, Max Peak, Min Peak, Sample, RMS
	Trigger		Trigger Mode	Free Run, Video, External Rise, External Fall, Gated
			Trigger Level	0 - 100 %
			Trigger Delay	1 - 10 s
			Gate Delay	
			Gate Length	
Instrument Setup	Hardware	Auto Accessory Detec-tion		
		Detected Accessory		
		BNC		
	Antenna	Antenna	On	
			Off	
		Compass		
		Show Compass Informa-tion		

Softkey	Menu or Dialog items	Parameters	Parameters selection
		Magnetic Declination	
	GPS	GPS	On
			Off
		Show GPS Information	On
			Off
		Coordinate Format	dd° mm' ss.sss"
			dd° mm.mmm'
	LAN	MAC Address	On, Off
		DHCP	
		IP Address	
		Subnet Mask	
		Gateway	
	Date and Time	Set Date	
		Set Time	
		Time Zone	
	Regional	Language	English, French, German, Spanish, Italian, Portuguese, Japanese, Chinese, Korean, Russian, Hungarian, Traditional Chinese
		Date Format	dd/mm/yyyy, mm/dd/yyyy
	Display	Display Backlight	0 - 50 %
		Display Color Scheme	Color
			Black & White
			Printer Friendly
		Keyboard Backlight	0 - 50 %
		Keyboard Backlight Delay	1 - 10 s
	Touch Interface	On	
		Off	
	Audio	Key Click Volume	0 - 100 %
		System Beeper Volume	0 - 100 %
		Beep on Power Over-board	On

Softkey	Menu or Dialog items	Parameters	Parameters selection
			Off
	Power	Current Power Source	
		Battery Level	
		Battery Low Level	
		Battery Low Level Beep	Repetitive
			Once
			Off
		Auto Power Up on AC	On
	Off		
	Internal Alignment ¹	Frequency Clock	Align
		Reference Level	Align
	Reset	Reset Factory Settings	Factory Reset
User Preference	Site Name	Site Name	
		User	
		Name	
		Comments	
	Preset Key	Preset Mode	User Defined
			Default
		Preset Dataset	
	Working Directory	User working directory	On
			Off
		Working directory	
	Save On Event	Save On Event	On
			Off
		Event Source	Time Interval
			Limit Failure
			Distance Interval
			Every Sweep
Time Interval			
Distance Interval			
Limit Save Mode	Start On Failure		
	Stop On Failure		
	Save Only failures		

Softkey	Menu or Dialog items	Parameters	Parameters selection
	Capture	Recording Storage	SD
			USB
		Capture Screen	On
			Off
		Capture Dataset	On
			Off
		Capture GPX	
		Default Filename	
		Filename Counter Starts at	
		Capture Screen Format	PNG
			JPG
		Dataset	Default Dataset Name
Documentation	Export Documentation	Export	
HW/SW info	Hardware	Instrument Model	
		Instrument Serial Number	
		Mainboard Part Number	
		Mainboard Revision	
		Mainboard Serial Number	
		Frontboard Part Number	
		Frontboard Revision	
		Frontboard Serial Number	
	Controller Version		
Software	Software Version		
Installed Options	Option Administration		
	Install Option		
	Installation Status		
Exit			

15.1.2 File management

The [SAVE/RECALL] key opens the file manager that contains functionality to manage datasets and other files.

Softkey	Menu or dialog items	Parameters	Parameters selection
Save	On-screen KB (see Chapter 3.2.7, "On-screen keyboard" , on page 44)		
	Exit		
Recall	Preview	Prev	
		Next	
		Recall	
		Exit	
	Load		
	Refresh		
	Exit		
Recall Screenshot	Preview	Prev	
		Next	
		Exit	
	Refresh		
	Exit		
Export CSV			
File Manager	Mark		
	Edit	Rename	
		Cut	
		Copy	
		Paste	
		Delete	
	Preview	Prev	
		Next	
		Exit	
	Load		
	Refresh		
Exit			

15.1.3 Operating mode selection



¹Available only if R&S FPH-K15 (but no R&S FPH-K16) is installed.

²Available only if R&S FPH-K16 (with or without R&S FPH-K15) is installed.

³Available only if R&S FPH-K7 is installed.

⁴Available only if R&S FPH-K43 is installed.

⁵Available only if R&S FPH-K9 is installed.

The [MODE] key opens the mode menu that contains functionality to select the operating mode of the R&S Spectrum Rider.

Softkey	Menu or dialog items	Parameters	Parameters selection
Spectrum	See Chapter 6, "Spectrum analyzer mode" , on page 123		
³ Analog Demod ³ Digital Demod	See Chapter 10, "Modulation analysis" , on page 237		
⁴ Spectrum -> Receiver	See Chapter 12, "Receiver mode" , on page 283		
⁵ Power Meter	See Chapter 7, "Power meter" , on page 216)		
¹ Triangulation	See "Triangulation" on page 523		
² Spectrum -> Maps	See Chapter 15.7, "Functions of the maps" , on page 522		

15.2 Functions of the spectrum analyzer

This section contains all softkeys and menus that are available in spectrum analyzer mode.

• Measurement selection	487
• Frequency parameters	497
• SPAN selection	497
• AMPT parameters	497
• SWEEP parameters	498
• BW parameters	499
• Trace functionality	499
• Limit lines	500
• Markers	501

15.2.1 Measurement selection



The spectrogram and spectrogram playback is available only if you have installed option R&S Spectrum Rider-K15.

The [MEAS] key opens the measurement menu that contains functionality to select and configure the measurement.

Spectrum

Softkey	Menu or dialog items	Parameters	Parameters selection
Meas Mode	Spectrum		
	Channel Power		
	EIRP		
	Occupied Bandwidth		
	TDMA		
	Spectrum Emission Mask		
	ACLR		
	Harmonic Distortion		
	AM Modulation Depth		
	Spectrogram		
	Spectrogram Playback		
Isotropic Antenna [Auto]			
Tone	Squelch Level		
	Threshold Tone Frequency		
	Tone Gain		
	Tone Volume		
	Tone		

Channel Power

Softkey	Menu or dialog items	Parameters	Parameters selection
Meas Mode	Spectrum		
	Channel Power		
	EIRP		
	Occupied Bandwidth		

Softkey	Menu or dialog items	Parameters	Parameters selection
	TDMA		
	Spectrum Emission Mask		
	ACLR		
	Harmonic Distortion		
	AM Modulation Depth		
	Spectrogram		
	Spectrogram Playback		
	Iso Direction [Auto]		
Standard	Load		
	Refresh		
	Exit		
Level Adjust			
Channel BW			
Power Unit	dBm		
	dBmV		
	dB μ V		
	V		
	W		
Power Display	Clear/Write		
	Max Hold		
	Channel Pwr/Hz		

EIRP

Softkey	Menu or dialog items	Parameters	Parameters selection
Meas Mode	Spectrum		
	Channel Power		
	EIRP		
	Occupied Bandwidth		
	TDMA		
	Spectrum Emission Mask		
	ACLR		
	Harmonic Distortion		

Softkey	Menu or dialog items	Parameters	Parameters selection
	AM Modulation Depth		
	Spectrogram		
	Spectrogram Playback		
	Isotropic Antenna {Auto}		
Standard	Refresh		
	Exit		
Level Adjust			
EIRP Settings	Channel BW		
	Antenna Gain		
	Cable Loss		
	Distance		
Reset Max Hold			
Advanced Setting	Capture Horizontal		
	Capture Vertical		
	Clear Meas		

Occupied Bandwidth

Softkey	Menu or dialog items	Parameters	Parameters selection
Meas Mode	Spectrum		
	Channel Power		
	EIRP		
	Occupied Bandwidth		
	TDMA		
	Spectrum Emission Mask		
	ACLR		
	Harmonic Distortion		
	AM Modulation Depth		
	Spectrogram		
	Spectrogram Playback		
	Iso Direction [Auto]		
Standard	Load		
	Refresh		
	Exit		

Softkey	Menu or dialog items	Parameters	Parameters selection
Level Adjust			
Channel BW			
% Power BW			

TDMA

Softkey	Menu or dialog items	Parameters	Parameters selection
Meas Mode	Spectrum		
	Channel Power		
	EIRP		
	Occupied Bandwidth		
	TDMA		
	Spectrum Emission Mask		
	ACLR		
	Harmonic Distortion		
	AM Modulation Depth		
	Spectrogram		
	Spectrogram Playback		
	Iso Direction [Auto]		
Standard	Load		
	Refresh		
	Exit		
Level Adjust			
Manual SWT			
Burst Length			

Spectrum Emission Mask

Softkey	Menu or dialog items	Parameters	Parameters selection
Meas Mode	Spectrum		
	Channel Power		
	EIRP		
	Occupied Bandwidth		
	TDMA		

Softkey	Menu or dialog items	Parameters	Parameters selection
	Spectrum Emission Mask		
	ACLR		
	Harmonic Distortion		
	AM Modulation Depth		
	Spectrogram		
	Spectrogram Playback		
	Iso Direction [Auto]		
Standard	Load		
	Refresh		
	Exit		
Level Adjust			
View List			

ACLR

Softkey	Menu or dialog items	Parameters	Parameters selection
Meas Mode	Spectrum		
	Channel Power		
	EIRP		
	Occupied Bandwidth		
	TDMA		
	Spectrum Emission Mask		
	ACLR		
	Harmonic Distortion		
	AM Modulation Depth		
	Spectrogram		
	Spectrogram Playback		
	Iso Direction [Auto]		
Standard	Load		
	Refresh		
	Exit		
Level Adjust			
Channel Settings	Tx Channel		

Softkey	Menu or dialog items	Parameters	Parameters selection	
	Adj Channel			
	Channel BW			
	Channel Tx Spacing			
	Channel Adj Spacing			
	ACLR Ref Setting	Tx Channel		
		Min Pwr TX Chan.		
		Max Pwr TX Chan.		
		Low High Chan.		
	Channel Limit Relative			
Channel Limit Absolute				
Check Channel Limit				
Power Unit	dBm			
	dBmV			
	dBuV			
	V			
	W			
Power Display	Clear/Write			
	Max Hold			
	Absolute			
	Relative			
	Channel Pwr/Hz			

Harmonic Distortion

Softkey	Menu or dialog items	Parameters	Parameters selection
Meas Mode	Spectrum		
	Channel Power		
	EIRP		
	Occupied Bandwidth		
	TDMA		
	Spectrum Emission Mask		
	ACLR		
	Harmonic Distortion		
	AM Modulation Depth		

Softkey	Menu or dialog items	Parameters	Parameters selection
	Spectrogram		
	Spectrogram Playback		
	Iso Direction [Auto]		
Adjust Setting			
Harmonics			

AM Modulation Depth

Softkey	Menu or dialog items	Parameters	Parameters selection
Meas Mode	Spectrum		
	Channel Power		
	EIRP		
	Occupied Bandwidth		
	TDMA		
	Spectrum Emission Mask		
	ACLR		
	Harmonic Distortion		
	AM Modulation Depth		
	Spectrogram		
	Spectrogram Playback		
	Iso Direction [Auto]		
Adjust Setting			
Select Marker			
Threshold			

Spectrogram

Softkey	Menu or dialog items	Parameters	Parameters selection
Meas Mode	Spectrum		
	Channel Power		
	EIRP		
	Occupied Bandwidth		
	TDMA		
	Spectrum Emission Mask		

Softkey	Menu or dialog items	Parameters	Parameters selection	
	ACLR			
	Harmonic Distortion			
	AM Modulation Depth			
	Spectrogram			
	Spectrogram Playback			
	Iso Direction [Auto]			
Settings	Display	Reference Level		
		Level Range		
		Auto Range		
		Color Table	Green-Yellow	
			Green-Blue	
			Black-White	
			Red-Purple	
	Blue-Black			
	Full Screen			
	Couple to Spectrum			
	Tone	Squelch Level		
		Threshold Tone Frequency		
		Tone Gain		
		Tone Volume		
		Tone		
Long Time Rec				
Rec Settings				
Exit				
Playback	See "Spectrogram Playback" on page 495			
Save	On-screen KB			
	Exit			
Clear				
Hold				

Spectrogram Playback

Softkey	Menu or dialog items	Parameters	Parameters selection	
Meas Mode	Spectrum			
	Channel Power			
	EIRP			
	Occupied Bandwidth			
	TDMA			
	Spectrum Emission Mask			
	ACLR			
	Harmonic Distortion			
	AM Modulation Depth			
	Spectrogram			
	Spectrogram Playback			
	Iso Direction [Auto]			
Settings	Display	Reference Level		
		Level Range		
		Auto Range		
		Color Table	Green-Yellow	
			Green-Blue	
			Black-White	
			Red-Purple	
			Blue-Black	
		Full Screen		
		Couple to Spectrum		
	Tone	Squelch Level		
		Threshold Tone Frequency		
		Tone Gain		
		Tone Volume		
		Tone		
	Long Time Rec			
	Rec Settings			
	Exit			

Softkey	Menu or dialog items	Parameters	Parameters selection
Live Update	See " Spectrogram Playback " on page 495		
Save	On-screen KB		
	Exit		
Recall	Load		
	Refresh		
	Exit		
Select Time Line	T1 Line		
	T2 Line		

Isotropic Antenna [Auto]

Softkey	Menu or dialog items	Parameters	Parameters selection
Meas Mode	Spectrum		
	Channel Power		
	EIRP		
	Occupied Bandwidth		
	TDMA		
	Spectrum Emission Mask		
	ACLR		
	Harmonic Distortion		
	AM Modulation Depth		
	Spectrogram		
	Spectrogram Playback		
	Isotropic Antenna {Auto}		
Auto	Refresh		
	Exit		
X-Axis			
Y-Axis			
Z-Axis			
Exit			

15.2.2 Frequency parameters

The [FREQ] key opens the frequency menu that contains functionality to set up the horizontal axis of the measurement diagram.

Softkey	Menu or dialog items	Parameters	Parameters selection
Center Freq			
CF Stepsize	0.1 x Span, Manual, Step=Center		
Start Freq			
Stop Freq			
Freq Offset			
Freq Mode	Frequency		
	Select Downlink	Refresh	
		Load	
		Exit	
	Select Uplink	Refresh	
		Load	
		Exit	
	Set to Downlink		
Set to Uplink			

15.2.3 SPAN selection

The [SPAN] key opens the span menu that contains functionality to set the span.

Softkey	Menu or dialog items	Parameters	Parameters selection
Manual Span			
Full Span			
Zero Span			
Last Span			

15.2.4 AMPT parameters

The [AMPT] key opens the amplitude menu that contains functionality to set up the vertical axis of the measurement diagram.

Softkey	Menu or dialog items	Parameters	Parameters selection	
Ref Level				
Range / RefPos	Auto Range			
	Range			
	Linear			
	Ref Position			
Unit	dBm			
	dBmV			
	dBuV			
	V			
	W			
Ref Offset				
Att / Amp / Imp	Preamp			
	Manual Att			
	Auto Low Distortion			
	Auto Low Noise			
	Imp 50Ω			
	75 Ω RAM			
	75 Ω RAZ			
	75 Ω FSH-Z38			
Transducer	Primary			
	Secondary			
	Select Primary	Refresh		
		Load		
		Exit		
	Select Secondary	Refresh		
		Load		
		Exit		

15.2.5 SWEEP parameters

The [SWEEP] key opens a menu that contains all functionality to configure the sweep.

Softkey	Menu or dialog items	Parameters	Parameters selection	
Manual SWT				
Auto SWT				
Cont Sweep				
Single Sweep				
Trigger	Free Run			
	Video	0 - 100 %		
	Eternal Rise			
	External Fall			
	Delay	1 - 10 s		
	Gate Settings	Gate Delay		
		Gate Length		
		Manual SWT		
AutoGate High				
	AutoGate Low			

15.2.6 BW parameters

The [BW] key opens a menu that contains all functionality to set the bandwidths.

Softkey	Menu or dialog items	Parameters	Parameters selection
Manual RBW			
Auto RBW			
Manual VBW			
Auto VBW			

15.2.7 Trace functionality

The [TRACE] key opens the trace menu that contains functionality to set up the traces.

Softkey	Menu or dialog items	Parameters	Parameters selection
Trace Mode	View		
	Clear/Write		
	Max Hold		
	Min Hold		
	Average	1 to 10	

Softkey	Menu or dialog items	Parameters	Parameters selection
Detector	Auto Detector		
	Auto Peak		
	Max Peak		
	Min Peak		
	Sample		
	RMS		
Show	Enable Trace 2		
	Enable Memory 1		
	Enable Memory 2		
Trace>Memory			
Select Trace			
Trace Math	Math Position		
	Off		
	Trace - Memory		
	Memory - Trace		

15.2.8 Limit lines

The [LINES] key opens a menu that contains the functionality to control display and limit lines.

The [LINES] key opens a menu that contains the functionality to control limit lines.

Softkey	Menu or dialog items	Parameters	Parameters selection
Show Limit Lines			
Upper Limit	Set Threshold		
	Load From File	Refresh	
		Load	
		Exit	
Remove			
Lower Limit	Set Threshold		
	Load From File	Refresh	
		Load	
		Exit	

Softkey	Menu or dialog items	Parameters	Parameters selection
	Remove		
Auto Beep			

15.2.9 Markers

The [MARKER] key opens a menu to control markers and use marker functions.

Softkey	Menu or dialog items	Parameters	Parameters selection
New Marker			
Marker Type			
Delete Marker	Delete Selected		
	Delete All Delta		
	Delete All		
Select Marker			
Marker Function	Noise		
	Frequency Count	High Resolution	
		Low Resolution	
	N dB Down		
	N dB	-100 to 100 dB	
	Frequency Display		
	Channel Display		
	Demodulation Off		
	AM		
	FM		
	Time		
Volume	0 - 100%		
Set Marker	Search Range		
	Set To Peak		
	Set To Next Peak		
	Set To Minimum		
	All Marker To Peak		
	Center=Marker Freq		
	Ref Level=Marker Level		

15.3 Functions of the power meter

This section contains all softkeys and menus that are available in power meter mode.

- [Power meter measurements](#)..... 502
- [Frequency parameters](#)..... 505
- [BW parameters](#)..... 506
- [Amplitude parameters](#)..... 507
- [Sweep configuration](#)..... 508
- [Limits line parameters](#)..... 508
- [Trace parameters](#)..... 509
- [Marker parameters](#)..... 509

15.3.1 Power meter measurements



The power meter is available only if you have installed option R&S Spectrum Rider-K9.

The [MEAS] key opens a menu that contains the functionality to configure measurements with the power meter.

Power Meter

Softkey	Menu or dialog items	Parameters	Parameters selection
¹ Freq			
Unit	dBm		
	dB μ V		
	W		
	dB Rel		
Zero			
To Ref			
Meas Time	Short		
	Normal		
	Long		

¹ If "Freq Mode" (see [Frequency parameters](#)) is set to "Channel", the softkey displays "Channel".

Directional Power Meter with R&S FSH-Z14 & R&S FZH-Z44



The directional power meter is available only if you have installed option R&S Spectrum Rider-K9.

Softkey	Menu or dialog items	Parameters	Parameters selection	
Fwd Pwr Display	Average			
	Peak Envelope			
Freq ¹				
Unit	Forward Power	dBm		
		W		
		dB		
	Reflected Power	dBm		
		W		
		VSWR		
		dB (Return Loss)		
	Zero			
To Ref				
Standard	Correction Off			
	GSM			
	EDGE			
	3GPPWCDMA ²			
	cdmaOne ²			
	cdma200 1x ²			
	DVB-T ²			
	DVB ²			
	TETRA			
	USER	4 kHz		
		200 kHz		
600 kHz				

¹ If "Freq Mode" (see [Frequency parameters](#)) is set to "Channel", the softkey displays "Channel".

² Only for R&S FSH-Z44

Channel Power Meter

The internal power meter is available only if you have installed option R&S FPH-K19.

Softkey	Menu or dialog items	Parameters	Parameters selection
Freq ¹			
Unit	dBm		

Softkey	Menu or dialog items	Parameters	Parameters selection
	W		
	dB Rel		
Zero			
To Ref			
Channel BW			

¹ If "Freq Mode" (see [Frequency parameters](#)) is set to "Channel", the softkey displays "Channel".

Optic Power Measurement with ODM UPM 100

Softkey	Menu or dialog items	Parameters	Parameters selection
Wavelength			
Unit	dBm		
	dB μ V		
	W		
	dB Rel		
To Ref			

Pulse Power Measurement



The pulse power measurement is available only if you have installed option R&S Spectrum Rider-K29.

Table 15-1: Pulse power measurement with numeric mode

Softkey	Menu or dialog items	Parameters	Parameters selection
Meas Mode	Average		
	Power vs Time		
Freq			
Unit	dBm		
	W		
Zero			
To Ref			
Meas Time	Short		
	Normal		
	Long		

Table 15-2: Pulse power measurement with trace mode

Softkey	Menu or dialog items	Parameters	Parameters selection
Meas Mode	Average		
	Pwr vs Time		
Freq			
Unit	dBm		
	W		
Zero			
Algorithm	Histogram		
	Integration		
	Peak		
Ref Power Config	Low Ref Power	0 - 100 %	
	High Ref Power	0 - 100 %	
	Ref Power	0 - 100 %	
	Set to Default		
	Related to Power		
	Related to Voltage		

15.3.2 Frequency parameters

The [FREQ] key opens a menu that contains the functionality to set the frequency or wavelength.

Table 15-3: Optic Power Measurement

Softkey	Menu or dialog items	Parameters	Parameters selection
Wavelength			

Table 15-4: Power Meter, Directional Power Meter, Channel Power Meter, Pulse Power Measurement

Softkey	Menu or dialog items	Parameters	Parameters selection
¹ Frequency			
Freq Mode	² Channel		
	Select Downlink	Refresh	
		Load	
		Exit	
	Select Uplink	Refresh	
		Load	
Exit			

Softkey	Menu or dialog items	Parameters	Parameters selection
	Set to Downlink		
	Set to Uplink		

¹ If "Freq Mode" is set to "Channel", the softkey displays "Channel".

² If "Freq Mode" is previously configured to "Channel", the menu item displays "Frequency".

15.3.3 BW parameters

The [BW] key contains functionality to configure bandwidth parameters.

Table 15-5: Directional Power Meter

Softkey	Menu or dialog items	Parameters	Parameters selection	
Standard	Correction Off			
	GSM			
	EDGE			
	3GPPWCDMA ²			
	cdmaOne ²			
	cdma200 1x ²			
	DVB-T ²			
	DVB ²			
	TETRA			
	USER		4 kHz	
			200 kHz	
		600 kHz		

Table 15-6: Channel Power Meter

Softkey	Menu or dialog items	Parameters	Parameters selection
Channel BW			

Table 15-7: Pulse Measurement

Softkey	Menu or dialog items	Parameters	Parameters selection
VBW	Full		
	5 MHz		
	1.5 MHz		
	300 kHz		

15.3.4 Amplitude parameters

The [AMPT] key contains functionality to configure level parameters.

Table 15-8: Power Meter, Directional Power Meter, Optic Power Meter

Softkey	Menu or Dialog items	Parameters	Parameters selection
Unit	dBm		
	W		
	dB Rel		
Offset			

Table 15-9: Channel Power Meter

Softkey	Menu or dialog items	Parameters	Parameters selection
Unit	dBm		
	W		
	dB		
Offset			
RF At / Amp	Preamp		
	Manual Att		
	Auto		
Transducer	Primary		
	Secondary		
	Select Primary	Load	
		Refresh	
		Exit	
	Select Secondary	Load	
		Refresh	
		Exit	

Table 15-10: Pulse Power Measurement

Softkey	Menu or dialog items	Parameters	Parameters selection
Ref Level	-70 to 30 dBm		
Range	Scale Adjust		
	100 dB (10.0dB/Div)		
	50 dB (5.0dB/Div)		
	50 dB (5.0dB/Div)		
	30 dB (3.0dB/Div)		

Softkey	Menu or dialog items	Parameters	Parameters selection
	20 dB (2.0dB/Div)		
	10 dB (1.0dB/Div)		
	50 dB (0.5dB/Div)		
Unit	dBm		
	W		
Offset			

15.3.5 Sweep configuration

The [SWEEP] key opens a menu that contains functionality to configure the sweep.

Table 15-11: Power Meter, Directional Power Meter

Softkey	Menu or dialog items	Parameters	Parameters selection
Meas Time	Short		
	Normal		
	Long		

Table 15-12: Pulse Power Measurement

Softkey	Menu or dialog items	Parameters	Parameters selection
Trace Time		52 us to 1 s	
Conf Meas			
Single Meas			
Trigger	Free Run		
	Positive		
	Negative		
	Trigger Level	-30 to 20 dBm	
	Trigger Delay	-51.1875us to 53 s	
	Trigger Hysteresis	0.1 to 10 dB	
	Dropout Time	0 to 10s	

15.3.6 Limits line parameters

The [LINES] key opens a menu that contains functionality to configure the limits line.

Table 15-13: Power Meter, Channel Power Meter, Optic Power Meter

Softkey	Menu or dialog items	Parameters	Parameters selection
Show Limit Lines			
Upper Limit	Set Threshold		
	Remove		
Lower Limit	Set Threshold		
	Remove		
Auto Beep			

15.3.7 Trace parameters

The [TRACE] key opens a menu that contains functionality to configure the trace.

Table 15-14: Pulse Power Measurement

Softkey	Menu or dialog items	Parameters	Parameters selection
Trace Mode	Clear/Write		
	Average		
Detector	Average		
	Max Peak		
Show	Enable Trace 2		
	Enable Memory 1		
	Enable Memory 2		
Trace>Memory			

15.3.8 Marker parameters

The [MARKER] key opens a menu that contains functionality to configure the marker on the trace

Table 15-15: Pulse Power Measurement

Softkey	Menu or dialog items	Parameters	Parameters selection
New Marker			
Marker Type			
Delete Marker	Delete Selected		
	Delete All Delta		
	Delete All		
Select Marker			
Set Marker	Search Range		

Softkey	Menu or dialog items	Parameters	Parameters selection
	Set To Peak		
	Set To Next Peak		
	Set To Minimum		
	All Marker To Peak		
	Center=Marker Freq		
	Ref Level=Marker Level		

15.4 Functions of the wizard

This section contains all softkeys and menus that are available in the measurement WIZARD.

- [Measurement wizard](#).....510

15.4.1 Measurement wizard

The [WIZARD] key opens a menu that contains the functionality to perform wizard measurement.

Softkey	Menu or dialog items	Parameters	Parameter selection		
Wizard	Load Meas Set	Edit	Rename		
			Cut		
			Copy		
			Paste		
			Delete		
		Refresh			
		Load			
	Exit				
	Start Meas	Continue	Next Meas	Continue	
				Interrupt	
				Skip	
				Finish Wizard	
Cancel					
Repeat Meas					
Interrupt		Leave Menu ¹			

Softkey	Menu or dialog items	Parameters	Parameter selection		
				Resume Sequence	
				Cancel	
			Finish Wizard		
			Cancel		
		Interrupt	Leave Menu ¹		
			Resume Sequence		
			Cancel	Yes	
				No	
		Skip	Continue	Next Meas	
				Repeat Meas	
				Interrupt	
				Finish Wizard	
				Cancel	
				Interrupt	Leave Menu ¹
					Resume Sequence
					Cancel
				Skip	Continue
					Interrupt
			Skip		
			Finish Wizard		
			Cancel		
			Finish Wizard		
			Cancel	Yes	
				No	
		Finish Wizard			
		Cancel	Yes	Save Result	
					Discard Result
			No		
	Meas Setting	General	Measurement Definition		
			User		
			Number of Steps		
			Description		
		Site	Site Number		

Softkey	Menu or dialog items	Parameters	Parameter selection	
			Comments	
			GPS Position	
	Meas Spec			
	Meas Results	Mark	Edit	Rename
				Cut
				Copy
				Paste
				Delete
				Preview
		Next		
		Exit		
	Refresh			
	Exit			
	Exit			
	EMF	Load Meas Set		
Start Meas		Next		
		Result Mode	Average	
			Max Peak	
			Min Peak	
			RMS	
		Unit	dB μ V/m	
			V/m	
			dB μ A/m	
		Meas Results / Meas Sub Results	Result Mode	
			Unit	dB μ V/m
V/m				
dB μ A/m				
Meas Sub Results				
Back				
Cancel				
Meas Setting				

Softkey	Menu or dialog items	Parameters	Parameter selection
	Meas Spec		
	Exit		

¹Press [WIZARD] key to resume back the wizard measurement.

15.5 Functions of the modulation analysis

This section contains all softkeys and menus that are available in analog and digital demodulation mode.



The modulation analysis is available only if you have installed option R&S FPH-K7.

- [Analog demodulation measurements](#).....513
- [Digital demodulation measurements](#).....514
- [Frequency parameters](#).....514
- [BW parameters](#).....515
- [Amplitude parameters](#).....515
- [Sweep configuration](#).....516
- [Limits line parameters](#).....516
- [TRACE parameters](#).....517
- [MARKER parameters](#).....517

15.5.1 Analog demodulation measurements

The [MEAS] key opens a menu that contains the functionality to configure measurements with the analog demodulation.

Softkey	Menu or dialog items	Parameters	Parameters selection
AM Domain ¹			
FM Domain ¹			
Audio Lowpass	DBW/1		
	DBW/10		
	DBW/30		
	DBW/100		
Mod. Trace ¹			
Mod. Summary ¹			

¹To perform the analog modulation measurement, select the required modulation domain (AM Domain or FM Domain) and the required measurement setting (Mod. Trace or Mod. Summary).

15.5.2 Digital demodulation measurements

The [MEAS] key opens a menu that contains the functionality to configure measurements with the digital demodulation.

Softkey	Menu or dialog items	Parameters	Parameters selection
ASK ¹			
FSK ¹			
Filter Type ¹	Root Raised Cosine		
	Raised Cosine		
	Guassian		
	Unfiltered		
Demod Parameters ¹	Symbol Rate		
	Frequency Deviation ²		
	Alpha/BT		
	Number of symbols		
	Burst Processing	On Off	
Standard ²	Off		
	Bluetooth LE		
	Tire PResure		
Display Mode ¹	Eye Diagram		
	Symbols		
	Modulation Depth		
	Modulation Error		

¹To perform the digital modulation measurement, select the required modulation scheme (ASK or FSK) and the required measurement setting (filter type, demodulation parameters, display mode).

²Only available for FSK modulation scheme.

15.5.3 Frequency parameters

The [FREQ] key opens a menu that contains the functionality to set the frequency.

Softkey	Menu or dialog items	Parameters	Parameters selection
Center Freq			
CF Stepsize			
Freq Offset ¹			

¹Only available for ASK and FSK modulation scheme.

15.5.4 BW parameters



Only available for AM and FM domain measurements.

The [BW] key contains functionality to configure bandwidth parameters.

Softkey	Menu or dialog items	Parameters	Parameters selection
Manual DBW	3kHz - 2MHz		
Reference Deviation	<= DBW/2		
FM Broadcast ¹	Off		
	50us		
	75us		

¹FM Broadcast is only enabled when the DBW is set to 200kHz and 300kHz.

15.5.5 Amplitude parameters

The [AMPT] key contains functionality to configure the level parameters.

Softkey	Menu or dialog items	Parameters	Parameters selection
Ref Level			
Dev per Division ¹	1-100%		
Deviation per Div ²			
Ref Position ³			
Scale Adjust ⁴			
Att / Amp / Imp	Preamp		
	Manual Att		
	Auto Low Distortion		
	Auto Low Noise		

Softkey	Menu or dialog items	Parameters	Parameters selection
	Imp 50Ω		
	75 Ω RAM		
	75 Ω RAZ		
	75 Ω FSH-Z38		

¹Available for AM and FM Domain. For AM Domain, the Dev per Division is configurable up to 20%.

²Available for ASK and FSK measurement. For ASK, the Deviation per Div is configurable in %, for FSK, it is configurable in kHz.

³Only available for ASK measurement.

⁴Scale Adjust is only enabled in the FM Domain for Mod. Trace measurement.

15.5.6 Sweep configuration

The [SWEEP] key opens a menu that contains functionality to configure the sweep.

Softkey	Menu or dialog items	Parameters	Parameters selection
Cont Meas			
Single Meas			
Trigger ¹	Free Run		
	IQ Power -20.0 dBm		
	External Rise		
	External Fail		
	Trigger Delay		

¹Only available for ASK and FSK measurement.

15.5.7 Limits line parameters



Only available for AM and FM domain measurements.

The [LINES] key opens a menu that contains functionality to configure the limits line.

Softkey	Menu or dialog items	Parameters	Parameters selection
Select Limits	Refresh		
	Load		

Softkey	Menu or dialog items	Parameters	Parameters selection
	Exit		
Clear Limits			
Auto Beep			

15.5.8 TRACE parameters



Only available for ASK and FSK domain measurements.

The [TRACE] key opens a menu that contains functionality to configure the trace diagram.

Softkey	Menu or dialog items	Parameters	Parameters selection
Enable Memory 1			
Trace -> Memory			

15.5.9 MARKER parameters



Only available for ASK and FSK domain measurements.

The [MARKER] key opens a menu that contains functionality to configure the markers.

Softkey	Menu or dialog items	Parameters	Parameters selection
New Marker			
Marker Type			
Delete Marker			
Select Marker			
View List			

15.6 Functions of the receiver

This section contains all softkeys and menus that are available in receiver mode.



The receiver mode is available only if you have installed option R&S FPH-K43.

- Receiver mode measurement..... 518
- Frequency parameters..... 518
- Amplitude parameters..... 519
- BW parameters..... 520
- Sweep configuration..... 520
- Trace functionality..... 520
- Markers..... 521
- Limits line parameters..... 522

15.6.1 Receiver mode measurement

The [MEAS] key opens a menu that contains the functionality to configure measurements with the receiver mode modulation.

Softkey	Menu or Dialog items	Parameters	Parameters selection
Fixed Channel			
Channel Scan			

15.6.2 Frequency parameters

The [FREQ] key opens a menu that contains the functionality to set the frequency or channel.

Softkey	Menu or dialog items	Parameters	Parameters selection
Channel ¹			
Scan Step ²			
Start Freq			
Stop Freq			
Full Scan ²			
Freq Mode	Frequency		
	Channel Downlink		
	Channel Uplink		
	Set to Downlink		
	Set to Uplink		

¹Available when "Channel Downlink" or "Channel Uplink" is selected in the "Freq Mode".

²Available when "Frequency" is selected in the "Freq Mode".

15.6.3 Amplitude parameters

The [AMPT] key opens the amplitude menu that contains functionality to set up the vertical axis in the receiver mode.

Softkey	Menu or dialog items	Parameters	Parameters selection	
Ref Level				
Range / RefPos	Range			
	Ref Position			
Unit	dBm			
	dBmV			
	dBuV			
	V			
	W			
Ref Offset				
Att / Amp / Imp	Preamp			
	Manual Att			
	Auto Low Distortion			
	Auto Low Noise			
	Imp 50Ω			
	75 Ω RAM			
	75 Ω RAZ			
	75 Ω FSH-Z38			
Transducer	Primary			
	Secondary			
	Select Primary	Refresh		
		Load		
		Exit		
	Select Secondary	Refresh		
		Load		
		Exit		

15.6.4 BW parameters

The [BW] key contains functionality to configure bandwidth parameters.

Table 15-16: AM Domain, FM Domain

Softkey	Menu or dialog items	Parameters	Parameters selection
Manual DBW	3kHz - 2MHz		
Manual CISPR BW			
Auto CISPR BW			

15.6.5 Sweep configuration

The [SWEEP] key opens a menu that contains functionality to configure the sweep.

Table 15-17: AM Domain, FM Domain

Softkey	Menu or dialog items	Parameters	Parameters selection
Meas Time			
Cont Scan			
Single Scan			
Trigger	Free Run		
	Video		
	External Rise		
	External fall		
	Gated Trigger		
	Trigger Delay		
	Gate Settings	Gate Delay	
	Gate Length		
	Manual SWT		

15.6.6 Trace functionality

The [TRACE] key opens the trace menu that contains functionality to set up the traces.

Softkey	Menu or dialog items	Parameters	Parameters selection
Trace Mode	View		
	Clear/Write		
	Max Hold		
	Min Hold		
	Average	1 to 10	

Softkey	Menu or dialog items	Parameters	Parameters selection
Detector	Max Peak		
	Quasi Peak		
	Average		
	RMS		
Show	Enable Memory		
Trace>Memory			
Trace Style	Lines		
	Polygon		
Trace Math	Math Position		
	Off		
	Trace - Memory		
	Memory - Trace		

15.6.7 Markers

The [MARKER] key opens a menu to control markers and use marker functions.

Softkey	Menu or dialog items	Parameters	Parameters selection
New Marker			
Marker Type			
Delete Marker	Delete Selected		
	Delete All Delta		
	Delete All		
Select Marker			
Marker Function	Frequency Display		
	Channel Display		
	Demodulation Off		
	AM		
	FM		
	Time		
	Volume	0 - 100%	
Set Marker	Search Range		
	Set To Peak		
	Set To Next Peak		

Softkey	Menu or dialog items	Parameters	Parameters selection
	Set To Minimum		
	All Marker To Peak		
	Ref Level=Marker Level		

15.6.8 Limits line parameters

The [LINES] key opens a menu that contains functionality to configure the limits line.

Table 15-18: AM Domain, FM Domain

Softkey	Menu or dialog items	Parameters	Parameters selection
Show Limit Lines			
Upper Limit	Set Threshold		
	Load From File		
	Remove		
Lower Limit	Set Threshold		
	Load From File		
	Remove		
Auto Beep			

15.7 Functions of the maps

This section contains all softkeys and menus that are available in map mode.



The map is available only if you have installed option R&S FPH-K16.

- [Maps measurement](#)..... 522
- [Frequency parameters](#)..... 528
- [Amplitude parameters](#)..... 528
- [BW parameters](#)..... 529
- [Sweep configuration](#)..... 529
- [Trace functionality](#)..... 529
- [Limits line parameters](#)..... 530

15.7.1 Maps measurement

The [MEAS] key opens a menu that contains the functionality to configure map measurements.

Triangulation

The triangulation is available only if you have installed option R&S FPH-K15.

Softkey	Menu or dialog items	Parameters	Parameters selection	
Meas Mode ¹	Triangulation			
	Outdoor Mapping			
	Indoor Mapping			
GPS Position	Display	Trace Current Position		
		Show Saved Position		
		Show Current Position		
	Save	Current Position		
		Manual Position and Azimuth		
		Azimuth Only		
		Triangulation		
	Go To Triangulation			
	GPS Position List	Include	View	Previous
				Next
				Edit
				Exit
		Delete	Delete All	Yes
				No
Triangulate				
Exit				
Zoom in				
Zoom out				
Settings	Show	GPS Information		
		Compass Information		
		Power Bar		
		Power Result		
		Hardware Settings		
	Colors	Current Position Color	Black	
			Blue	

Softkey	Menu or dialog items	Parameters	Parameters selection
			Yellow
			Red
		Saved Positions Color	Black
			Blue
			Yellow
			Red
		Triangulation Color	Black
			Blue
	Yellow		
	Red		
	GPS Settings	HE800-PA	
		HE400	
		HE300	
		HL300	
GPS			
Compass			
Maps	Auto Select		
	"Map folder name" ²		
	World		

¹Available only if option R&S FPH-K16 is installed.

²Available only if a connected USB stick is scanned to locate the available map folders. See "Map folder" on page 258.

Outdoor Mapping

Softkey	Menu or dialog items	Parameters	Parameters selection
Meas Mode	Triangulation ¹		
	Outdoor Mapping		
	Indoor Mapping		
GPS Position	Display	Trace Current Position	
		Show Saved Position	
		Show Current Position	
		Live Map Update	
	Save	Current Position	

Softkey	Menu or dialog items	Parameters	Parameters selection
		Manual Position and Azimuth	
	Go To		
	GPS Position List	include	
		View	
		Delete	
		Delete All	
		Exit	
	Select GPX File	Mark	
		Edit	
		Preview	
		Load	
		Refresh	
		Exit	
	Exit		
Zoom in			
Zoom out			
Settings	Show	GPS Information	
		Compass Information	
		Power Bar	
		Power Result	
		Hardware Settings	
	Colors	Current Position Color	
		Saved Positions Color	
		Triangulation Color	
	Tone	Squelch Level	
		Threshold Tone Frequency	
		Tone Gain	
		Tone Volume	
		Tone	
	Save on Event Event Source	Time Interval	
		Limit Failure	
Distance Interval			

Softkey	Menu or dialog items	Parameters	Parameters selection
		Every Sweep	
Maps	Auto Select		
	"Map folder name" ²		
	World		

¹Available only if option R&S FPH-K15 is installed.

²Available only if a connected USB stick is scanned to locate the available map folders. See "[Map folder](#)" on page 258.

Indoor Mapping

Softkey	Menu or dialog items	Parameters	Parameters selection
Meas Mode	Triangulation ¹		
	Outdoor Mapping		
	Indoor Mapping		
Indoor Position	Capture Position		
	Save Results	On-screen KB	
		Exit	
	Clear Indoor Position List	Yes	
		No	
	Indoor Position List	Include	
		View	
		Delete	
		Delete All	
		Exit	
	Select GPX File	Mark	
		Edit	
		Preview	
		Load	
		Refresh	
Exit			
Zoom in			
Zoom out			
Settings	Show	Power Bar	
		Power Result	

Softkey	Menu or dialog items	Parameters	Parameters selection
		Hardware Settings	
	Current Position Color	Black	
		Blue	
		Yellow	
		Res	
	Good Coverage Color	Magenta	
		Light Blue	
		Cyan	
		Green	
		Yellow	
		Red	
	Good Coverage Level		
	Average Coverage Color	Magenta	
		Light Blue	
		Cyan	
		Green	
		Yellow	
		Red	
	Average Coverage Level		
	Bad Coverage Color	Magenta	
		Light Blue	
		Cyan	
		Green	
		Yellow	
		Red	
	Bad Coverage Level		
	Default Indicator	Best	
		Average	
		Worst	
	Tone	Squelch Level	
		Threshold Tone Frequency	
		Tone Gain	
		Tone Volume	

Softkey	Menu or dialog items	Parameters	Parameters selection
		Tone	
	Cursor Sensitivity		
	Exit	Every Sweep	
Maps	Auto Select		
	"Map folder name" ²		
	World		

¹Available only if option R&S FPH-K15 is installed.

²Available only if a connected USB stick is scanned to locate the available map folders. See "[Map folder](#)" on page 258.

15.7.2 Frequency parameters

The [FREQ] key opens a menu that contains the functionality to set the frequency.

Softkey	Menu or dialog items	Parameters	Parameters selection
Freq			

15.7.3 Amplitude parameters

The [AMPT] key opens the amplitude menu that contains functionality to set up the vertical axis in the map mode.

Softkey	Menu or dialog items	Parameters	Parameters selection
Ref Level			
Range	Auto Range		
	Range		
Unit	dBm		
	dBmV		
	dBuV		
	V		
	W		
	dB μ V/m		
	dB μ A/m		
	V/m		
	W/m ²		

Softkey	Menu or dialog items	Parameters	Parameters selection	
Att / Amp / Imp	Preamp			
	Manual Att			
	Auto Low Distortion			
	Auto Low Noise			
	Imp 50Ω			
	75 Ω RAM			
	75 Ω RAZ			
	75 Ω FSH-Z38			
Transducer	Primary			
	Secondary			
	Select Primary	Refresh		
		Load		
		Exit		
	Select Secondary	Refresh		
		Load		
		Exit		

15.7.4 BW parameters

The [BW] key contains functionality to configure bandwidth parameters.

Softkey	Menu or dialog items	Parameters	Parameters selection
RBW	3kHz - 2MHz		

15.7.5 Sweep configuration

The [SWEEP] key opens a menu that contains functionality to configure the sweep.

Softkey	Menu or dialog items	Parameters	Parameters selection
Sweep Time			

15.7.6 Trace functionality

The [TRACE] key opens the trace menu that contains functionality to set up the traces.

Softkey	Menu or dialog items	Parameters	Parameters selection
Detector	Max Peak		
	Min Peak		
	Sample		
	RMS		

15.7.7 Limits line parameters

The [LINES] key opens a menu that contains functionality to configure the limits line.

Softkey	Menu or dialog items	Parameters	Parameters selection
Show Limit Lines			
Upper Limit	Set Threshold		
	Load From File		
	Remove		
Lower Limit	Set Threshold		
	Load From File		
	Remove		
Auto Beep			

16 Contacting customer support

Technical support – where and when you need it

For quick, expert help with any Rohde & Schwarz product, contact our customer support center. A team of highly qualified engineers provides support and works with you to find a solution to your query on any aspect of the operation, programming or applications of Rohde & Schwarz products.

Contact information

Contact our customer support center at www.rohde-schwarz.com/support, or follow this QR code:



Figure 16-1: QR code to the Rohde & Schwarz support page

17 Appendix

In this appendix, additional information on how a spectrum analyzer work is given.

17.1 How a spectrum analyzer works

Basically, it is possible to measure and analyze RF signals either in the time domain or the frequency domain.

Measurements in the time domain show signal variations over time. You can perform these with an oscilloscope, for example. Measurements in the frequency domain show the frequency components of a signal. To perform measurements in the frequency domain, you can use a spectrum analyzer.

Both modes are essentially equivalent because applying the Fourier transform to any signal converts it into its spectral components. Depending on the signal characteristic to be measured, one method is usually more appropriate than the other. With an oscilloscope, it is possible to tell whether a signal is a sine wave, a square wave with a certain on/off ratio or a sawtooth wave. However, detecting superimposed low-level signals or monitoring the harmonic content of the signal is easier with a spectrum or signal analyzer.

Figure 17-1 shows the theoretical basis of the two measurement methods. In the time domain, an oscilloscope would, for example, show a section of the signal that is a square wave. The same signal, when viewed with a spectrum analyzer, would show a line spectrum (the fundamental and its harmonics).

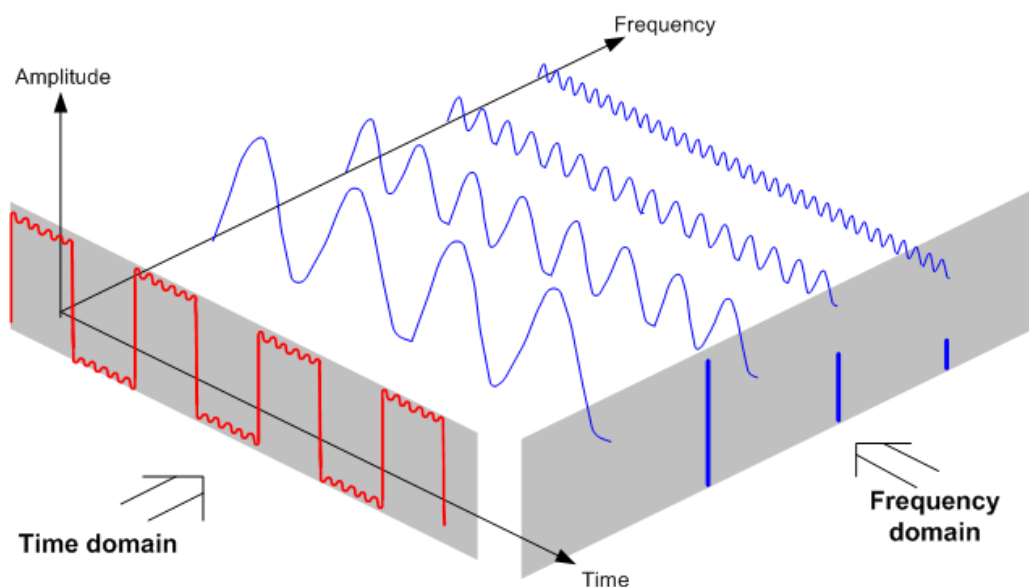

Figure 17-1: Visualization of time domain and frequency domain

Applying the Fourier transform to the periodic square wave transforms it into the frequency domain. The spectrum analyzer would show the fundamental (or frequency of the square wave) and its harmonics.

The spectrum analyzer uses a narrow bandpass filter for measurements in the frequency domain. Only at frequencies containing a signal there is a reading that gives the amplitude of the frequency component.

Figure 17-2 shows the basic principle of how a spectrum analyzer works.

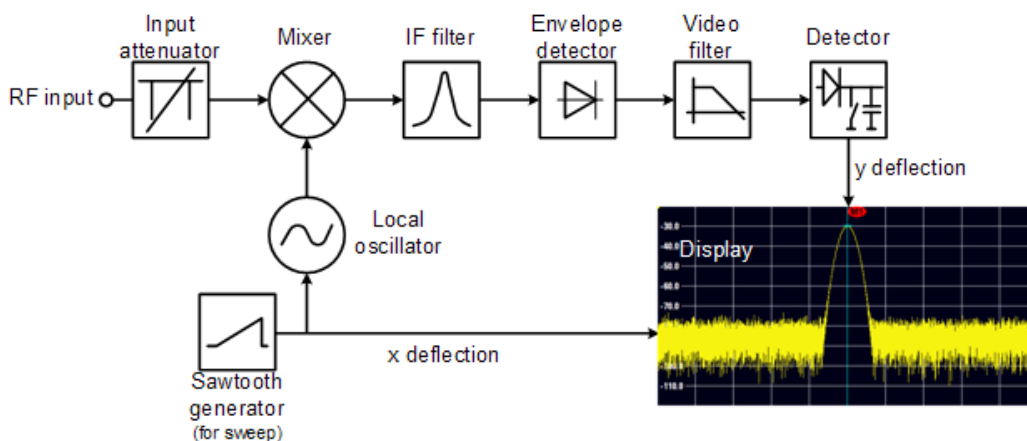

Figure 17-2: Block diagram showing the basic functionality of a spectrum analyzer

The precision attenuator at the R&S Spectrum Rider input attenuates the signal to a level that the mixer can handle without overdriving the mixer. The attenuator is directly coupled to the reference level. You can attenuate the signal in the range from 0 dB to 40 dB in steps of 5 dB.

The mixer converts the RF signal to a fixed intermediate frequency (IF). This process usually involves several stages. It lasts until you get an IF for which good narrowband filters are available. The R&S Spectrum Rider needs three mixing stages to get an IF that the filter can handle. Figure 11-3 graphically shows the mixing process.

For models with a frequency limit of 3.6 GHz, the IFs are 4892.8 MHz, 860.8 MHz and 54.4 MHz. The conversion from a specific input frequency to the first IF is done by a local oscillator (LO). This LO can be tuned from 4.8 GHz to 8.4 GHz. All other conversions are handled by single-frequency oscillators.

In case of models with a frequency limit of 8 GHz, the IFs are 8924.8 MHz, 860.8 MHz and 54.4 MHz. The conversion from the first to the second IF for these models is done by a second local oscillator.

The frequency of the local oscillator determines the input frequency at which the spectrum analyzer performs measurements: $f_{in} = f_{LO} - f_{IF}$.

The first mixer produces the sum frequency $f_{LO} + f_{in}$ (= image frequency f_{image}) as well as the difference frequency $f_{LO} - f_{in}$.

The image frequency is rejected by the bandpass at the IF so that it does not interfere with the subsequent frequency conversions.

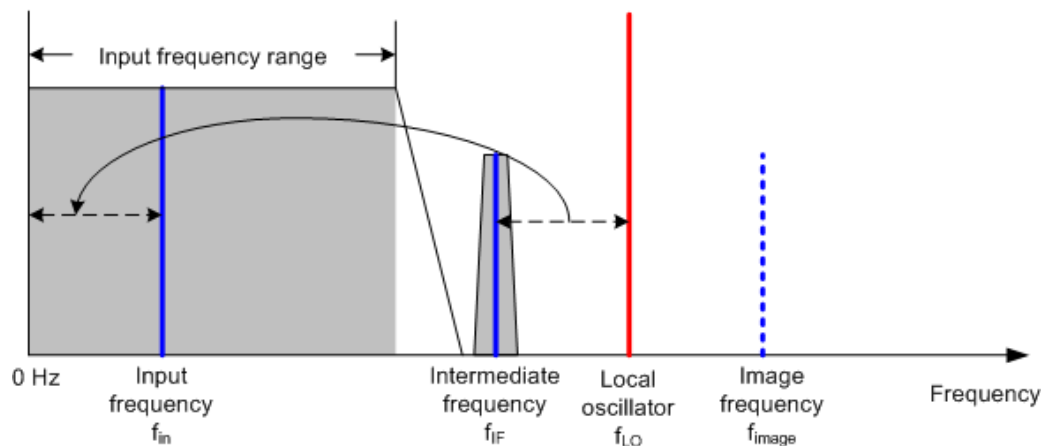

The first local oscillator is tuned with a sawtooth which simultaneously acts as the x deflection voltage for the display. In practice, synthesizer technology is used to generate the frequency of the first local oscillator and for a digital display.

The instantaneous sawtooth voltage therefore determines the input frequency of the spectrum analyzer.

The bandwidth of the IF filter at the IF determines the bandwidth that is used for measurements. Pure sine signals are passed by the IF filter characteristics. This means that signals closer together than the bandwidth of the IF filter cannot be resolved. This is why the bandwidth of the IF filter in a spectrum analyzer is referred to as the resolution bandwidth. The R&S Spectrum Rider has resolution bandwidths from 1 Hz to 3 MHz.

The bandlimited IF is passed to the envelope detector. The envelope detector removes the IF from the signal and outputs its envelope. The output signal from the envelope detector is referred to as the video signal. As it has been demodulated, it only contains amplitude information. The phase information is lost.

With RF sine signals, the video signal is a DC voltage. With AM signals the video signal contains a DC component whose amplitude corresponds to the carrier power and an AC component whose frequency is equal to the modulation frequency, provided the modulation frequency is inside the resolution bandwidth.

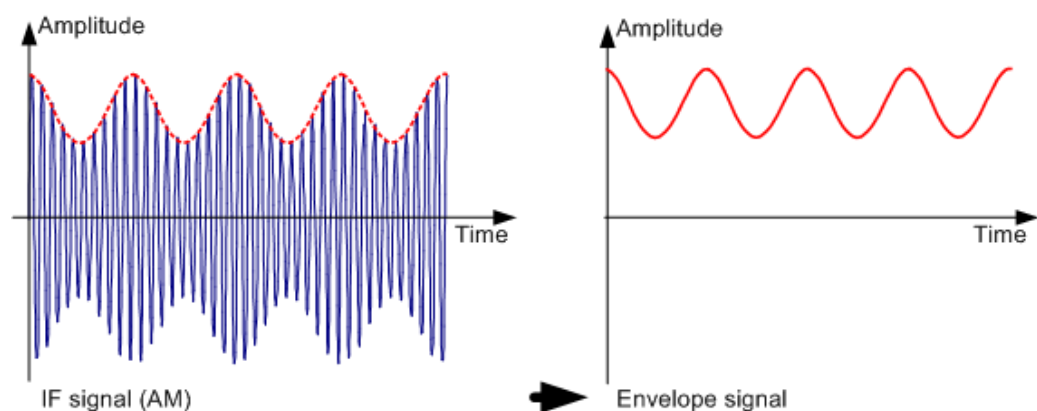

The video filter comes after the envelope detector. The filter is a lowpass with an adjustable cutoff frequency which limits the bandwidth of the video signal. It is particu-

larly useful when sine signals are to be measured in the vicinity of the spectrum analyzer’s intrinsic noise. The sine signal produces a video signal that is a DC voltage.

At the IF, however, the noise is distributed over the whole bandwidth or, in the case of the video signal, over half the bandwidth of the resolution filter. By selecting a narrow video bandwidth relative to the resolution bandwidth, the noise can be suppressed, while the sine signal to be measured (= DC) is not affected.

The figures below show a weak sine signal. In the first picture, it is measured with a large video bandwidth and in the second with a narrow video bandwidth.

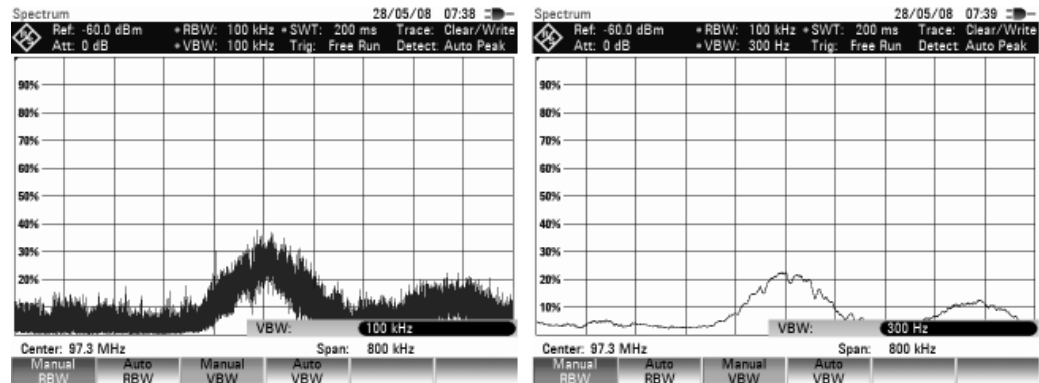

Limiting the video bandwidth smoothes the trace considerably. This makes it much easier to determine the level of the measured signal.

The detector comes after the video filter. The detector combines the measured spectrum so that it can be represented as one pixel in the trace. The R&S Spectrum Rider uses 711 pixels to form the trace, i.e. the whole measured spectrum has to be represented using just 711 pixels. Common types of spectrum analyzer detectors are the peak detector (PEAK), the sample detector (SAMPLE) and the RMS detector (RMS). An Auto Peak detector which simultaneously displays the maximum peak and the minimum peak is usually also provided. The Fig. below explains how these detectors work.

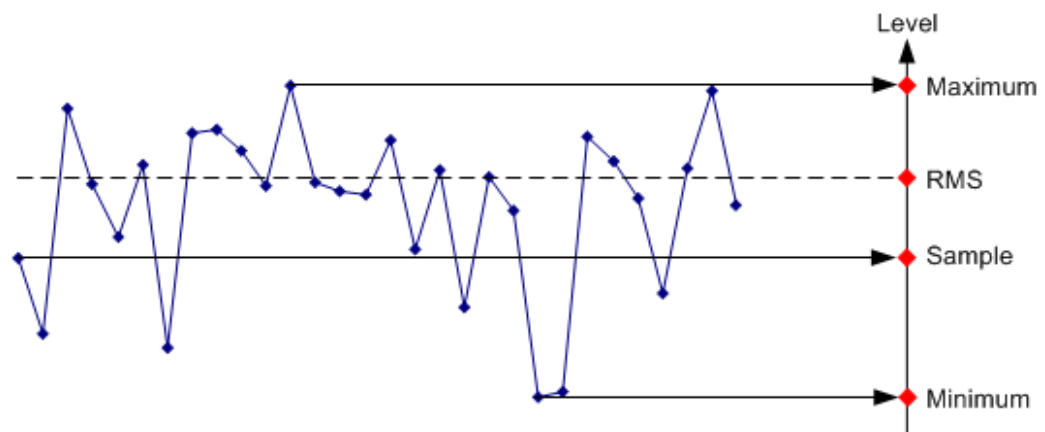

The figure above shows 30 measured values which are represented by a single pixel. The peak detector determines and displays the maximum measured value. The Auto Peak detector takes the maximum and minimum and displays them together. The two values are joined by a vertical line segment. This gives a good indication of the level variation over the measured values represented by a single pixel. The RMS detector is

used by the spectrum analyzer to determine the RMS value of the measured values. It is therefore a measure of the spectral power represented by a pixel. The sample detector takes an arbitrary measurement value and displays it (in the Fig. above, the first). The other measured values are ignored.

On the basis of the operating principles of detectors, a few recommendations can be made as to their use.

- It is best to use the Auto Peak detector or the peak detector for spectrum analysis over large frequency ranges. This ensures that all signals are displayed.
- The RMS detector is recommended for power measurements on modulated signals. However, the display range should be chosen so as not to exceed 100 times the bandwidth of the signal or the resolution bandwidth, whichever is larger.
- The sample detector or the RMS detector (preferred) should be used for noise measurements. Only these two detectors are capable of measuring noise power correctly
- When measurements are made on sine signals, the level display does not depend on the detector. However, if you use the RMS detector or the sample detector, ensure that the span is not too great. Otherwise, the displayed levels of sine signals may be lower than their true value.

List of commands

[SENSe:]ADEMod:Bandwidth:DEModulation.....	407
[SENSe:]ADEMod:Bandwidth:RDEVIation.....	407
[SENSe:]ADEMod:BWIDth:DEModulation.....	407
[SENSe:]ADEMod:BWIDth:RDEVIation.....	407
[SENSe:]ADEMod:FM:OFFSet?.....	411
[SENSe:]ADEMod:MTIME?.....	409
[SENSe:]BANDwidth:VIDeo.....	344
[SENSe:]BANDwidth:VIDeo:AUTO.....	344
[SENSe:]BANDwidth[:RESolution].....	344
[SENSe:]BANDwidth[:RESolution]:AUTO.....	344
[SENSe:]BANDwidth[:RESolution]:CISPr.....	431
[SENSe:]BANDwidth[:RESolution]:CISPr:AUTO.....	431
[SENSe:]BWIDth:VIDeo.....	344
[SENSe:]BWIDth:VIDeo:AUTO.....	344
[SENSe:]BWIDth[:RESolution].....	344
[SENSe:]BWIDth[:RESolution]:AUTO.....	344
[SENSe:]CHANnel:TABLE:SElect:DOWNlink.....	376
[SENSe:]CHANnel:TABLE:SElect:UPLink.....	376
[SENSe:]CHANnel:TABLE:SElect<1...4>.....	375
[SENSe:]CHANnel:TABLE:SET.....	377
[SENSe:]CHANnel<1...3>.....	375
[SENSe:]CORRection:TRANsducer<1...2>:ISOTropic[:STATE].....	405
[SENSe:]CORRection:TRANsducer<1...2>:SElect.....	340
[SENSe:]CORRection:TRANsducer<1...2>:UNIT?.....	341
[SENSe:]CORRection:TRANsducer<1...2>[:STATE].....	340
[SENSe:]DDEMod.....	422
[SENSe:]DDEMod:BURSt[:STATE].....	418
[SENSe:]DDEMod:FILTer:ALPHA.....	418
[SENSe:]DDEMod:FILTer:NAME.....	418
[SENSe:]DDEMod:FILTer[:STATE].....	418
[SENSe:]DDEMod:FSK:OFFSet?.....	422
[SENSe:]DDEMod:SRATE.....	419
[SENSe:]DDEMod:TIME.....	419
[SENSe:]DETEctor<t>[:FUNction].....	350
[SENSe:]DETEctor<t>[:FUNction]:AUTO.....	350
[SENSe:]EIRPpower:CLOSSs.....	383
[SENSe:]EIRPpower:DISTance.....	383
[SENSe:]EIRPpower:MAXHold?.....	384
[SENSe:]EIRPpower:PLOSSs?.....	384
[SENSe:]EIRPpower:POWEr?.....	384
[SENSe:]EIRPpower:RAGain.....	384
[SENSe:]EIRPpower:SUM?.....	384
[SENSe:]ESpectrum:PRESet:SETTings.....	403
[SENSe:]ESpectrum:PRESet[:STANdard].....	403
[SENSe:]FILTer:DEMPHasis:TCONstant.....	408
[SENSe:]FILTer:DEMPHasis[:STATE].....	408
[SENSe:]FILTer:LPASSs.....	408

[SENSe:]FREQUency:CENTer.....	333
[SENSe:]FREQUency:CENTer:STEP.....	333
[SENSe:]FREQUency:CENTer:STEP:LINK.....	333
[SENSe:]FREQUency:INPut:MODE.....	334
[SENSe:]FREQUency:MODE.....	334
[SENSe:]FREQUency:OFFSet.....	335
[SENSe:]FREQUency:SPAN.....	335
[SENSe:]FREQUency:SPAN:AUTO.....	335
[SENSe:]FREQUency:SPAN:FULL.....	335
[SENSe:]FREQUency:START.....	335
[SENSe:]FREQUency:STOP.....	336
[SENSe:]PMETer:DETEctor[:FUNction].....	426
[SENSe:]PMETer:FREQUency.....	423
[SENSe:]PMETer:MTIME.....	425
[SENSe:]PMETer:WAVElength.....	424
[SENSe:]POWer:ACHannel:ACPairs.....	388
[SENSe:]POWer:ACHannel:BANDwidth[:ACHannel].....	389
[SENSe:]POWer:ACHannel:BANDwidth[:ALTErnate<1...11>].....	389
[SENSe:]POWer:ACHannel:BANDwidth[:CHANnel].....	389
[SENSe:]POWer:ACHannel:BWIDth:ACHannel.....	390
[SENSe:]POWer:ACHannel:BWIDth:ALTErnate<1...11>.....	390
[SENSe:]POWer:ACHannel:BWIDth[:CHANnel].....	389
[SENSe:]POWer:ACHannel:MODE.....	390
[SENSe:]POWer:ACHannel:PRESet:RLEVel.....	391
[SENSe:]POWer:ACHannel:REFerence:TXCHannel:AUTO.....	391
[SENSe:]POWer:ACHannel:REFerence:TXCHannel:MANual.....	392
[SENSe:]POWer:ACHannel:SPACing:ALTErnate<1...11>.....	392
[SENSe:]POWer:ACHannel:SPACing:CHANnel<1...11>.....	393
[SENSe:]POWer:ACHannel:SPACing[:ACHannel].....	392
[SENSe:]POWer:ACHannel:TXCHannel:COUNT.....	393
[SENSe:]ROSCillator:SOURce.....	456
[SENSe:]SCAN:START.....	429
[SENSe:]SCAN:STEP.....	430
[SENSe:]SCAN:STOP.....	430
[SENSe:]SWEep:COUNT.....	346
[SENSe:]SWEep:EGATE.....	347
[SENSe:]SWEep:EGATE:HOLDoff.....	348
[SENSe:]SWEep:EGATE:LENGth.....	348
[SENSe:]SWEep:EGATE:TIME.....	348
[SENSe:]SWEep:MODE.....	403
[SENSe:]SWEep:POINts.....	346
[SENSe:]SWEep:TIME.....	347
[SENSe:]SWEep:TIME:AUTO.....	347
*CLS.....	329
*ESE.....	329
*ESR?.....	329
*IDN?.....	330
*IST?.....	330
*OPC.....	330
*OPT?.....	330

*RST.....	331
*SRE.....	331
*STB?.....	331
*TRG.....	331
*TST?.....	331
*WAI.....	332
ABORt.....	345
CALCulate<t>:ADEModulation:LIMit:DELeTe.....	409
CALCulate<t>:ADEModulation:LIMit:FAIL?.....	410
CALCulate<t>:ADEModulation:LIMit:SELeCt.....	410
CALCulate<t>:DELtAmarker<m>:AOFF.....	355
CALCulate<t>:DELtAmarker<m>:MAXimum:NEXt.....	356
CALCulate<t>:DELtAmarker<m>:MAXimum[:PEAK].....	356
CALCulate<t>:DELtAmarker<m>:MINimum[:PEAK].....	356
CALCulate<t>:DELtAmarker<m>:X.....	357
CALCulate<t>:DELtAmarker<m>:X:RELative.....	357
CALCulate<t>:DELtAmarker<m>:Y?.....	358
CALCulate<t>:DELtAmarker<m>[:STATe].....	355
CALCulate<t>:DLINe.....	369
CALCulate<t>:DLINe:STATe.....	369
CALCulate<t>:FEED.....	410
CALCulate<t>:FSK:DEViation:REFerence[:VALue].....	417
CALCulate<t>:LIMit:BEEP[:STATe].....	370
CALCulate<t>:LIMit:STATe.....	372
CALCulate<t>:LIMit<l>:ACPoweR:ACHannel:ABSolute.....	396
CALCulate<t>:LIMit<l>:ACPoweR:ACHannel:ABSolute[:STATe].....	396
CALCulate<t>:LIMit<l>:ACPoweR:ACHannel:RESult?.....	396
CALCulate<t>:LIMit<l>:ACPoweR:ACHannel[:RELative].....	395
CALCulate<t>:LIMit<l>:ACPoweR:ACHannel[:RELative]:STATe.....	395
CALCulate<t>:LIMit<l>:ACPoweR:ALternate<1...11>:ABSolute.....	398
CALCulate<t>:LIMit<l>:ACPoweR:ALternate<1...11>:ABSolute[:STATe].....	398
CALCulate<t>:LIMit<l>:ACPoweR:ALternate<1...11>:RESult?.....	398
CALCulate<t>:LIMit<l>:ACPoweR:ALternate<1...11>[:RELative].....	397
CALCulate<t>:LIMit<l>:ACPoweR:ALternate<1...11>[:RELative]:STATe.....	397
CALCulate<t>:LIMit<l>:ACPoweR:STATe.....	394
CALCulate<t>:LIMit<l>:COMMeNt?.....	370
CALCulate<t>:LIMit<l>:DEFine.....	371
CALCulate<t>:LIMit<l>:DELeTe.....	372
CALCulate<t>:LIMit<l>:FAIL?.....	372
CALCulate<t>:LIMit<l>:LOWer:SELeCt.....	373
CALCulate<t>:LIMit<l>:LOWer:THReShold.....	374
CALCulate<t>:LIMit<l>:UNIT:X?.....	373
CALCulate<t>:LIMit<l>:UNIT[:Y]?.....	373
CALCulate<t>:LIMit<l>:UPPeR:SELeCt.....	374
CALCulate<t>:LIMit<l>:UPPeR:THReShold.....	374
CALCulate<t>:MARKeR:COUNt:RESolution:MODE.....	364
CALCulate<t>:MARKeR:FREQuency:MODE.....	359
CALCulate<t>:MARKeR:FUNcTION:ADEMod:AFREquency[:RESult]?.....	411
CALCulate<t>:MARKeR:FUNcTION:ADEMod:AM[:RESult]?.....	412
CALCulate<t>:MARKeR:FUNcTION:ADEMod:CARRier[:RESult]?.....	412

CALCulate<t>:MARKer:FUNCTION:ADEMod:FERRor[:RESult]?	412
CALCulate<t>:MARKer:FUNCTION:ADEMod:FM[:RESult]?	413
CALCulate<t>:MARKer:FUNCTION:ADEMod:MINdex[:RESult]?	413
CALCulate<t>:MARKer:FUNCTION:ADEMod:MRAT[:RESult]?	413
CALCulate<t>:MARKer:FUNCTION:ADEMod:SINad[:RESult]?	413
CALCulate<t>:MARKer:FUNCTION:ADEMod:SNR[:RESult]?	414
CALCulate<t>:MARKer:FUNCTION:ADEMod:THD[:RESult]?	414
CALCulate<t>:MARKer:FUNCTION:DDEMod:CARRier[:RESult]?	420
CALCulate<t>:MARKer:FUNCTION:DDEMod:CFDRift[:RESult]?	420
CALCulate<t>:MARKer:FUNCTION:DDEMod:CFERror[:RESult]?	420
CALCulate<t>:MARKer:FUNCTION:DDEMod:MDEPth[:RESult]?	420
CALCulate<t>:MARKer:FUNCTION:DDEMod:MDEviation[:RESult]?	421
CALCulate<t>:MARKer:FUNCTION:DDEMod:MERRor[:RESult]?	421
CALCulate<t>:MARKer:FUNCTION:DDEMod:MINdex[:RESult]?	421
CALCulate<t>:MARKer:FUNCTION:DDEMod:MOERror[:RESult]?	421
CALCulate<t>:MARKer:FUNCTION:DDEMod:MPOWer[:RESult]?	422
CALCulate<t>:MARKer<m>:AOFF	359
CALCulate<t>:MARKer<m>:COUNT:FREQUency?	364
CALCulate<t>:MARKer<m>:COUNT[:STATe]	365
CALCulate<t>:MARKer<m>:FUNCTION:ACPower:UNIT	388
CALCulate<t>:MARKer<m>:FUNCTION:CENTer	359
CALCulate<t>:MARKer<m>:FUNCTION:CPOWer:BANDwidth	381
CALCulate<t>:MARKer<m>:FUNCTION:CPOWer:MODE	382
CALCulate<t>:MARKer<m>:FUNCTION:CPOWer:UNIT	382
CALCulate<t>:MARKer<m>:FUNCTION:DEModulation:HOLD	366
CALCulate<t>:MARKer<m>:FUNCTION:DEModulation:SElect	366
CALCulate<t>:MARKer<m>:FUNCTION:DEModulation[:STATe]	365
CALCulate<t>:MARKer<m>:FUNCTION:FIXed	435
CALCulate<t>:MARKer<m>:FUNCTION:HARMonics:DISTortion?	400
CALCulate<t>:MARKer<m>:FUNCTION:HARMonics:LIST?	400
CALCulate<t>:MARKer<m>:FUNCTION:HARMonics:NHARmonics	401
CALCulate<t>:MARKer<m>:FUNCTION:HARMonics:PRESet	401
CALCulate<t>:MARKer<m>:FUNCTION:HARMonics[:STATe]	400
CALCulate<t>:MARKer<m>:FUNCTION:LEVel:ONCE	377
CALCulate<t>:MARKer<m>:FUNCTION:MDEPth:RESult?	402
CALCulate<t>:MARKer<m>:FUNCTION:MDEPth[:STATe]	402
CALCulate<t>:MARKer<m>:FUNCTION:NDBDown	366
CALCulate<t>:MARKer<m>:FUNCTION:NDBDown:FREQUency?	367
CALCulate<t>:MARKer<m>:FUNCTION:NDBDown:RESult?	367
CALCulate<t>:MARKer<m>:FUNCTION:NDBDown:STATe	367
CALCulate<t>:MARKer<m>:FUNCTION:NOISe:RESult?	368
CALCulate<t>:MARKer<m>:FUNCTION:NOISe[:STATe]	368
CALCulate<t>:MARKer<m>:FUNCTION:OBAN:BANDwidth	385
CALCulate<t>:MARKer<m>:FUNCTION:OBAN:BANDwidth:PCT	386
CALCulate<t>:MARKer<m>:FUNCTION:OBW:BANDwidth	386
CALCulate<t>:MARKer<m>:FUNCTION:OBW:BANDwidth:PCT	386
CALCulate<t>:MARKer<m>:FUNCTION:POWer:PRESet	378
CALCulate<t>:MARKer<m>:FUNCTION:POWer:PRESet:CHECK?	378
CALCulate<t>:MARKer<m>:FUNCTION:POWer:RESult:PHZ	382
CALCulate<t>:MARKer<m>:FUNCTION:POWer:RESult?	379

CALCulate<t>:MARKer<m>:FUNction:POWer:SElect.....	380
CALCulate<t>:MARKer<m>:FUNction:POWer[:STATe].....	381
CALCulate<t>:MARKer<m>:FUNction:REFEreNce.....	360
CALCulate<t>:MARKer<m>:FUNction:TDMA:BURSt.....	387
CALCulate<t>:MARKer<m>:FUNction:TXPower:RESult?.....	399
CALCulate<t>:MARKer<m>:MAXimum:NEXT.....	360
CALCulate<t>:MARKer<m>:MAXimum[:PEAK].....	360
CALCulate<t>:MARKer<m>:MINimum[:PEAK].....	360
CALCulate<t>:MARKer<m>:X.....	361
CALCulate<t>:MARKer<m>:X:SLIMits<l>:LEFT.....	362
CALCulate<t>:MARKer<m>:X:SLIMits<l>:RIGHt.....	362
CALCulate<t>:MARKer<m>:X:SLIMits<l>[:STATe].....	361
CALCulate<t>:MARKer<m>:Y?.....	363
CALCulate<t>:MARKer<m>[:STATe].....	358
CALCulate<t>:MATH:COpy:MEMory.....	350
CALCulate<t>:MATH:STATe.....	350
CALCulate<t>:MATH[:EXPRession][:DEFine].....	351
CALCulate<t>:PMETer:CPOWer:BANDwidth.....	423
CALCulate<t>:PMETer:PRESet:BANDwidth:VIDeo.....	426
CALCulate<t>:PMETer:PRESet:SElect.....	428
CALCulate<t>:PMETer:PRESet[:STATe].....	428
CALCulate<t>:PMETer:RELative[:MAGNitude].....	424
CALCulate<t>:PMETer:RELative[:MAGNitude]:AUTO.....	424
CALCulate<t>:PMETer:RELative[:MAGNitude]:OFFSet.....	425
CALCulate<t>:SPECtrogram[:STATe].....	404
CALibration:PMETer:ZERO:AUTO.....	425
DISPlay[:WINDow]:STORe.....	442
DISPlay[:WINDow]:TRACe:STYLe.....	433
DISPlay[:WINDow]:TRACe<t>:MEMory[:STATe].....	351
DISPlay[:WINDow]:TRACe<t>:MODE.....	352
DISPlay[:WINDow]:TRACe<t>:Y:SPACing.....	336
DISPlay[:WINDow]:TRACe<t>:Y[:SCALE].....	337
DISPlay[:WINDow]:TRACe<t>:Y[:SCALE]:ADJust.....	337
DISPlay[:WINDow]:TRACe<t>:Y[:SCALE]:PDIVision.....	406
DISPlay[:WINDow]:TRACe<t>:Y[:SCALE]:RLEVel.....	337
DISPlay[:WINDow]:TRACe<t>:Y[:SCALE]:RLEVel:OFFSet.....	338
DISPlay[:WINDow]:TRACe<t>:Y[:SCALE]:RPOStion.....	338
DISPlay[:WINDow]:TRACe<t>[:STATe].....	351
DISPlay<t>:BARGraph:PHOLd:RESet.....	432
DISPlay<t>:BRIGHtness.....	451
DISPlay<t>:CMAP.....	452
DISPlay<t>:CMAP:DEFault.....	452
DISPlay<t>:DATE:FORMat.....	452
DISPlay<t>:EIRP:HORIZontal.....	385
DISPlay<t>:EIRP:MAXHold:RESet.....	385
DISPlay<t>:EIRP:VERTical.....	385
FETCH<z>:PMETer.....	427
FORMat:BORDER.....	352
FORMat[:DATA].....	353
HCOPY:DEVice:LANGUage.....	442

HCOPY[:IMMEDIATE].....	443
INITiate:CONTinuous.....	346
INITiate[:IMMEDIATE].....	345
INPut:ANTenna:MEASure.....	404
INPut:ANTenna:STATe.....	405
INPut:ATTenuation:AUTO.....	339
INPut:ATTenuation:MODE.....	339
INPut:ATTenuation<p>.....	339
INPut:GAIN:STATe.....	339
INPut:IMPedance.....	340
INPut:IMPedance:PAD.....	456
INSTRument:NSElect.....	448
INSTRument[:SElect].....	448
MMEMory:CATalog:DIRectories?.....	436
MMEMory:CATalog?.....	436
MMEMory:CDIRectory.....	436
MMEMory:COPY.....	437
MMEMory:DATA.....	437
MMEMory:DElete.....	438
MMEMory:FILE.....	438
MMEMory:FILE:DATE.....	438
MMEMory:FILE:TIME.....	439
MMEMory:INIT.....	439
MMEMory:LOAD:STATe.....	439
MMEMory:MDIRectory.....	440
MMEMory:MOVE.....	440
MMEMory:NAME.....	443
MMEMory:RDIRectory.....	440
MMEMory:STORe:CSV:STATe.....	441
MMEMory:STORe:STATe.....	440
SOURce:TG:ATTenuation.....	341
SOURce:TG:AUTO.....	342
SOURce:TG:FREQuency.....	342
SOURce:TG:FREQuency:AUTO.....	342
SOURce:TG:FREQuency:OFFSet.....	343
SOURce:TG:POWer.....	343
SOURce:TG[:STATe].....	343
STATus:OPERation:CONDition?.....	474
STATus:OPERation:ENABLE.....	474
STATus:OPERation:NTRansition.....	474
STATus:OPERation:PTRansition.....	475
STATus:OPERation[:EVENT]?.....	474
STATus:PRESet.....	473
STATus:QUESTionable:CONDition?.....	475
STATus:QUESTionable:ENABLE.....	476
STATus:QUESTionable:FREQuency:CONDition?.....	476
STATus:QUESTionable:FREQuency:ENABLE.....	476
STATus:QUESTionable:FREQuency:NTRansition.....	477
STATus:QUESTionable:FREQuency:PTRansition.....	478
STATus:QUESTionable:FREQuency[:EVENT]?.....	475

STATus:QUEStionable:LIMit:CONDition?	476
STATus:QUEStionable:LIMit:ENABle	476
STATus:QUEStionable:LIMit:NTRansition	477
STATus:QUEStionable:LIMit:PTRansition	478
STATus:QUEStionable:LIMit[:EVENT]?	475
STATus:QUEStionable:NTRansition	477
STATus:QUEStionable:POWer:CONDition?	476
STATus:QUEStionable:POWer:ENABle	477
STATus:QUEStionable:POWer:NTRansition	478
STATus:QUEStionable:POWer:PTRansition	479
STATus:QUEStionable:POWer[:EVENT]?	475
STATus:QUEStionable:PTRansition	478
STATus:QUEStionable[:EVENT]?	475
STATus:QUEue[:NEXT]?	474
SYSTem:ACCessory	456
SYSTem:ACCessory:AUTO	457
SYSTem:AUDio:VOLume	453
SYSTem:BEEPer:KEY:VOLume	454
SYSTem:BEEPer:POVerload[:STATe]	453
SYSTem:BEEPer:VOLume	453
SYSTem:BNC:MODE	457
SYSTem:CAPTure:COUNter	444
SYSTem:CAPTure:CSV[:STATe]	441
SYSTem:CAPTure:DATaset[:STATe]	444
SYSTem:CAPTure:GPX[:STATe]	444
SYSTem:CAPTure:MODE	444
SYSTem:CAPTure:SCReen[:STATe]	445
SYSTem:COMMunicate:LAN:ETHernet	454
SYSTem:COMMunicate:LAN:GATeway	454
SYSTem:COMMunicate:LAN:SUBMask	454
SYSTem:COMMunicate:SOCKet:ADDRess	455
SYSTem:COMMunicate:SOCKet:DHCP[:STATe]	455
SYSTem:COMMunicate:SOCKet:PORT	455
SYSTem:DATE	457
SYSTem:ERRor:ALL?	458
SYSTem:ERRor:CODE:ALL?	458
SYSTem:ERRor:CODE[:NEXT]?	458
SYSTem:ERRor:COUNt?	458
SYSTem:ERRor[:NEXT]?	458
SYSTem:FORMat:IDENT	459
SYSTem:HELP:HEADers?	459
SYSTem:HELP:SYNTax?	459
SYSTem:LANGuage	459
SYSTem:LANGuage:CATalog?	460
SYSTem:POSition:ALTitude?	449
SYSTem:POSition:COMPass:ANGLE?	449
SYSTem:POSition:COMPass:VALid?	449
SYSTem:POSition:COMPass[:STATe]	449
SYSTem:POSition:GPS:CONNected?	450
SYSTem:POSition:GPS:CORRection:FREQuency?	450

SYSTem:POStion:GPS:QUALity?	450
SYSTem:POStion:GPS:SATellites?	450
SYSTem:POStion:GPS:TIME?	451
SYSTem:POStion:GPS[:STATe]	450
SYSTem:POStion:LATitude?	451
SYSTem:POStion:LONGitude?	451
SYSTem:POStion:VALid?	451
SYSTem:POWer:SOURce?	460
SYSTem:POWer:STATus?	460
SYSTem:PRESet	460
SYSTem:PRESet:CALibration:DISCard	460
SYSTem:PRESet:FACTory	461
SYSTem:PRESet:MODE	461
SYSTem:PRESet:USER	461
SYSTem:REBoot	461
SYSTem:SET	462
SYSTem:SET:LOCK	441
SYSTem:SET:UNLock	441
SYSTem:SHUTdown	462
SYSTem:SOEVent:DISTance:INTerval	445
SYSTem:SOEVent:LIMits:MODE	446
SYSTem:SOEVent:RECORDing:STORage	446
SYSTem:SOEVent:SOURce	446
SYSTem:SOEVent:TIME:INTerval	447
SYSTem:SOEVent[:STATe]	447
SYSTem:TIME	462
SYSTem:TZONee	462
SYSTem:VERSion?	463
TRACe<t>[:DATA]:MEMory?	354
TRACe<t>[:DATA]?	353
TRIGger[:SEQuence]:LEVel:IQPower	416
TRIGger[:SEQuence]:LEVel:VIDeo	348
TRIGger[:SEQuence]:SLOPe	349
TRIGger[:SEQuence]:SOURce	349
UNIT<t>:PMETer:POWer	427
UNIT<t>:POWer	341

Index

A

AC adapter	25
Accessory detection	52
AM demodulator	206
AM modulation depth	150
Amplitude	177
Analog modulation	237
AM domain	237
AMPT	515
BW	515
FM domain	237
FREQ	514
LINE	516
MEAS	513
SWEEP	516
Antenna	
Configuring	52
Application cards	19
Application notes	19
Attenuation	76, 179, 224
Audio demodulation	
Mute function	207
Time	207
Volume	207
Audio demodulator	206
Audio settings	63
Auto low distortion	76
Auto low noise	76
Auto low noise/distortion	179
Auto peak	193
Auto power up	65
Average time	220
Average trace	192

B

Backlight	61
Bandwidth	
Resolution	183
Video	184
Basic signal characteristics	123
Basic signal using an audio signal to locate signal	123
Battery insertion	24
Battery low level	65
Battery maintenance	28
Battery operation	
Battery (car adapter)	26
Battery (charging)	26
Battery (external charger)	26
Battery (replacement)	26
Beeper	210
BNC connector	34
Configuring	52
Brochure	18

C

Calibration certificate	18
Center frequency	174, 218, 223
CF step size	174
Channel Power	125
Channel table	211

Clear / write	187
Clear status	
Remote	329
Command sequence	
Remote	332
Command sequence and command synchronization	327
Configuring the instrument	
Audio settings	453
Controlling the GPS receiver	448
Display configuration	451
Mode selection	447
Setting up a network connection	454
System settings	455
Continue sweep	187
Controls	32
Customer support	531

D

Data management	105
Data sheet	18
Date & time	59
Date format	60
Default values	
Remote	331
Delay time	188
Delete dataset	111
Delta marker	198
Detector	193
Device documentation	112
Digital modulation	237
AMPT	515
ASK	237
FREQ	514
FSK	237
MARKER	517
MEAS	514
SWEEP	516
TRACE	517
Directional power sensor	221
Zeroing	87
Display element	90
Display line	208
Display range	178
Display settings	61
Displaying maps	
Adding and removing elements	260
Aligning the indoor mapping mode	260
Aligning the triangulation and outdoor mapping mode	260
Screen layout	260
Zoom in and out of the map	260
Documentation overview	17

E

EIRP	168
Electrostatic discharge	22
EMF measurement	295
Configuring measurements	296
Contents of the result displays	306
Loading a measurement set	302
Measurement specification	303

Performing a sequence of measurements	304
Preparing an EMF measurement	296
Running the EMF measurement	301
ESD	22
Event status enable register (ESE)	
Remote	329
Event status register (ESR)	
Remote	329
Export dataset	112
External reference	34
External trigger	34
Reference level	187

F

File management	105
Firmware	112
FM demodulator	206
Forward power display	221
Free run	187
Frequency	79
Counter	204
Mode	211
Offset	175
settings	218, 223
Settings	174
Start / Stop	175
Front panel keys	45
Function keys	46

G

Gated trigger	187
Getting started	18
GPS receiver	57

H

Hardkey	
WIZARD	510
Hardware settings	52
Harmonic distortion	148
Harmonics	82
Headphone jack	35
Horizontal axis	173
How a spectrum analyzer works	532

I

Identification	
Remote	330
Impedance	181
Indoor mapping	270
Instrument model and command processing	315
Intended use	17
Interfaces and protocols	311
LAN	311
SCPI	311
USB	311
VISA	311
VXI-11	311
Interference analyzer	
Measuring the spectrum	256
Working with maps	256
Internal power meter	226
IST flag	
Remote	330

K

Key

AMPT	497
Ampt (SA)	177
BW	183, 499
FREQ	497
Freq (SA)	173
LINE	500
Marker	196
MARKER	501
MEAS	487
Meas (PM)	221
MEAS (PM)	216, 226, 229
MODE	486
SAVE/RECALL	484
SETUP	480
SPAN	497
Sweep	186
SWEEP	498
Trace	191
TRACE	499
Keypad	47

L

LAN connection with R&S Spectrum Rider	69
Languages	60
Last span	177
Left view	
DC port	35
Kensington lock	35
Length unit	60
Limit check	210
Limit line	209

M

Maps

AMPT	528
BW	529
FREQ	528
Indoor mapping	522
LINE	530
MEAS	522
Outdoor mapping	522
SWEEP	529
TRACE	529
Triangulation	522
Marker	196
Active marker	197
Automatic positioning	199
Delta marker	198
Distance	205
Frequency counter	79
Functions	202
List	197
Position	197, 204
Removal	200
Search limit	202
Search limits	201
Selection	199
Type	199
Mathematics	196
Max hold	193
Max peak	193

- Measurement 186
 - Audio demodulation 206
 - Channel power 226
 - Directional power sensor 221
 - Frequency counter 204
 - n dB down 205
 - Noise power density 203, 211
 - Measurement setup 99
 - Configure overview 99
 - Measurement wizard 114
 - Evaluating results 121
 - Performing and configuring measurements 114
 - Measuring the effective isotropic radiated power 168
 - Memory trace 195
 - Menu 480
 - General 480
 - Menu and softkey overview 480
 - Min hold 193
 - Min peak 193
 - Multiple traces 194
 - Mute function 207
- N**
- n dB down 205
 - Navigation controls
 - Rotary knob 48
 - Noise power 203
- O**
- Occupied bandwidth 129
 - Offset
 - Frequency 175
 - Reference level 179
 - On-screen keyboard 44
 - Open source acknowledgment (OSA) 19
 - Operation complete
 - Remote 330
 - Options 49, 112
 - Checking options 50
 - Enabling options 49
 - Identification (remote) 330
 - Managing options with R&S license manager 50
 - Outdoor mapping 270
- P**
- Package contents 24
 - Positioning
 - Support 24
 - Power key 45
 - Power meter 216, 229
 - AMPT 507
 - BW 506
 - FREQ 505
 - LINE 508
 - MARKER 509
 - MEAS 502
 - SWEEP 508
 - TRACE 509
 - Power overload beep 65
 - Power sensor 216, 217, 218, 229
 - Attenuation 224
 - Average time 220
 - Directional 221
 - errors 218
 - Reference level 220
 - Standard 224
 - Unit 220, 223
 - Weighting mode 223
 - Zeroing 84, 219
 - Power sensor port 35
 - Power settings 65
 - Preamplifier 78, 181
 - Preset 68, 98
 - Preview dataset 110
 - Primary transducer 212
 - Pulse characteristic 231
 - Pulse power measurement 229
 - Power vs time 229
 - Putting into operation 22
- R**
- R&S InstrumentView
 - Channel table 211
 - Limit lines 208
 - Range 175
 - RBW 183
 - Rear view
 - SD card slot 36
 - Receiver
 - Channel scan 283
 - Fixed scan 283
 - Receiver mode
 - AMPT 519
 - BW 520
 - FREQ 518
 - LINE 522
 - MARKER 521
 - MEAS 518
 - SWEEP 520
 - TRACE 520
 - Reference level 79, 177
 - Directional power meter 223
 - External trigger 187
 - Offset 179
 - Power sensor 220
 - transducer 214
 - Reference position 177
 - Regional settings 60
 - Release notes 19
 - Remote commands
 - Analog modulation 405
 - Common commands 329
 - Configuring data capture 443
 - Configuring the instrument 447
 - Digital modulation 414
 - File management 435
 - Making and storing screenshots 442
 - Power meter 422
 - Receiver mode 429
 - Saving events 445
 - Spectrum analyzer 332
 - Status reporting system 472
 - Remote control commands 327
 - Remote control connection 314
 - Changing the IP address 314
 - Reset 68
 - Reset values
 - Remote 331
 - Resolution bandwidth 183
 - Restore dataset 109

- RF attenuation 179
- Right view
 - LAN port 36
 - Mini USB 36
- RMS 193
- S**
- Safety information 17
- Safety instructions 18
- Sample 193
- Save on event 106
- Saving events 102
- Scaling
 - Horizontal axis 173
- SCPI command structure and syntax 318
- Screen layout
 - Configure overview 90
 - Power meter 216
 - Power meter (Directional) 221
 - Power meter (Pulse) 229
 - Spectrum 90
- Screenshot 100
 - Dataset 100
 - Preview 100
- Screenshot key 45
- Search limits 201
- Secondary transducer 212
- Self-test
 - Remote 331
- Service request enable register (SRE)
 - Remote 331
- Signal attenuation 76
- Single sweep 187
- Softkey 45
 - Analog modulation 513
 - Configuration overview 172
 - General 480
 - Maps 522
 - New marker 197
 - Power meter 502
 - Receiver 517
 - Spectrum analysis 486
- Span 176
- Spectrogram result display 152
 - Spectrogram playback 163
 - Spectrogram recording 159
- Spectrum analysis
 - Spectrogram 486
 - Spectrogram playback 486
- Spectrum analyzer 76
- Spectrum emission mask 136
- Standard
 - Directional power sensor 224
 - Power sensor 224
- Start / Stop 175
- Start / Stop frequency 175
- Status byte
 - Remote 329, 331
- Status reporting system 463
 - Application of the status reporting systems 470
 - Event status register (ESR) and event status enable register (ESE) 467
 - Overview of the status register 465
 - Reset values of the status reporting system 472
- Status byte (STB) & service request enable register (SRE) 466
- Structure of a SCPI status register 463
- Step size 174
- Supplied options 30
- Sweep 186, 193
- Sweep mode 187
- Sweep number 186, 191
- Sweep time 186
- Switching on and off the instrument 29
- Synchronization
 - Data 105
- System keys 45
- T**
- TDMA 133
- Time domain 177, 187
- Top view
 - BNC connector 33
 - Headphone jack 33
 - RF input 33
 - RF output 33
 - USB type A connector 33
- Touchscreen 37
 - Configuration overview 42
 - Measurement result view 39, 40
 - Parameter view 40
 - Title bar 38
- Touchscreen gesture 37
 - Add marker 92
 - Change center frequency 92
 - Change reference level 92
 - Change span 92
 - Delete all markers 92
- Trace 191
- Trace (second) 194
- Trace average 192
- Trace mathematics 196
- Trace memory 195
- Trace mode 192
- Trace selection 194
- Tracking generator 182
- Transducer 181, 212
 - Unit 214
- Triangulation 270
- Trigger 186
 - Event (remote) 331
- Trigger delay 188
- Trigger level 189
- U**
- Unit 179
 - Power sensor 220, 223
 - Transducer 214
- Unpacking and checking the instrument 23
- USB connection with R&S Spectrum Rider 75
- USB port 35
- User interface 32, 90
- User manual 18
- Using isotropic antennas 165
- V**
- VBW 184
- Vertical axis 177

Video bandwidth	184
View trace	192
Volume	207
Key clock volume	63
System beeper	63

W

Wait	
Remote	332
Wavelength	218
settings	218
White papers	19
WIZARD	510
Working directory	99
Working with maps	
Displaying maps	257
Transferring indoor maps	257
Transferring maps	257

X

X axis	173
--------------	-----

Y

Y axis	177
--------------	-----

Z

Zero span	177
Zeroing	219