

- Notes:
- *1. Minimum voltage is guaranteed to maximum 0.2% of the rated output voltage.
 - *2. Minimum current is guaranteed to maximum 0.4% of the rated output current.
 - *3. At 85-132Vac or 170-265Vac, constant load.
 - *4. From No-load to Full-load, constant input voltage. Measured at the sensing point in Remote Sense.
 - *5. Measure with JEITA RC-9131B (1:1) probe
 - *6. Measurement frequency bandwidth is 10Hz to 20MHz.
 - *7. Measurement frequency bandwidth is 5Hz to 1MHz.
 - *8. From 10% to 90% of rated output voltage, with rated resistive load.
 - *9. From 90% to 10% of rated output voltage, with rated resistive load.

- *10. Time for output voltage to recover within 0.5% of its rated output for a load change from 10 to 90% of its rated output current. Voltage set point from 10% to 100% of rated output.
- *11. For load voltage change, equal to the unit voltage rating, constant input voltage.
- *12. For 6V-20V model the ripple is measured at 2V ~ rated output voltage and full output current. For other models, the ripple is measured at 10-100% output voltage and full output current.
- *13. At rated output power.
- *14. If install the front panel filter kit, the temperature is guaranteed to 40°C.

ORDERING INFORMATION

PSU 6-200	1200W	Programmable Switching DC Power Supply
PSU 8-180	1440W	Programmable Switching DC Power Supply
PSU 12.5-120	1500W	Programmable Switching DC Power Supply
PSU 15-100	1500W	Programmable Switching DC Power Supply
PSU 20-76	1520W	Programmable Switching DC Power Supply
PSU 30-50	1500W	Programmable Switching DC Power Supply
PSU 40-38	1520W	Programmable Switching DC Power Supply
PSU 50-30	1500W	Programmable Switching DC Power Supply
PSU 60-25	1500W	Programmable Switching DC Power Supply
PSU 80-19	1520W	Programmable Switching DC Power Supply
PSU 100-15	1500W	Programmable Switching DC Power Supply
PSU 150-10	1500W	Programmable Switching DC Power Supply
PSU 300-5	1500W	Programmable Switching DC Power Supply
PSU 400-3.8	1520W	Programmable Switching DC Power Supply
PSU 600-2.6	1560W	Programmable Switching DC Power Supply

ACCESSORIES

CD-ROM x 1 (User Manual, Programming Manual), Output terminal cover x 1, Analog connector plug kit x1, Output terminal M8 bolt set(6V-60V model), Input terminal cover x 1, 1U Handle(RoHS), 1U Bracket(LEFT, RoHS), 1U Bracket (RIGHT, RoHS), Power Cord(10A) provided for certain regions only

OPTIONAL ACCESSORIES

PSU-01B	Bus bar for 2 units in parallel connection	GTL-246	USB Cable, USB 2.0A-B Type Cable, 4P
PSU-01C	Cable for 2 units in parallel connection	GTL-258	GPIB Cable, 2000mm
PSU-02B	Bus bar for 3 units in parallel connection	GTL-259	RS-232 Cable with DB9 connector to RJ45
PSU-02C	Cable for 3 units in parallel connection	GTL-260	RS-485 Cable with DB9 connector to RJ45
PSU-03B	Bus bar for 4 units in parallel connection	GTL-262	RS-485 Slave cable
PSU-03C	Cable for 4 units in parallel connection		
PSU-232	RS232 Cable with DB9 connector kit		
PSU-485	RS485 Cable with DB9 connector kit		
PSU-001	Front panel filter kit(factory Installed)		
PSU-01A	Joins a vertical stack of 2 PSU units together. 2U-sized handles x2, joining plates x2		
PSU-02A	Joins a vertical stack of 3 PSU units together. 3U-sized handles x2, joining plates x2		
PSU-03A	Joins a vertical stack of 4 PSU units together. 4U-sized handles x2, joining plates x2		
PSU-ISO-I	Isolate current remote control card(factory option)		
PSU-ISO-V	Isolate voltage remote control card(factory option)		
PSU-GPIB	GPIB Interface card (factory option)		
GRM-001	Slide bracket 2pcs/set ,PSU option		
GPW-001	UL/CSA power cord 3m ,PSU option		
GPW-002	VDE power cord 3m, PSU option		
GPW-003	PSE power cord 3m, PSU option		

FREE DOWNLOAD

Driver LabView Driver

Specifications subject to change without notice. PSU-SeriesGD1BH



PSU-Series

Programmable Switching D.C. Power Supply

FEATURES

- Voltage Output : 6V/8V/12.5V/15V/20V/30V/40V/50V/60V/80V/100V/150V/300V/400V/600V
- Power Output : 1200W ~ 1560W
- C.V/C.C Priority Mode
- Adjustable Voltage/Current Rise and Fall Time
- Series/Parallel Connection : Max. 2 units(Models Under 300V)/4 units of The Same Model
- High Efficiency and High Power Density
- 1U Height and 19"Rack Mount Size
- Three sets of Preset Function
- Bleeder Control Function
- Internal Resistance Function
- Panel Lock Function
- Protection : OVP, OCP, OHP,UVL, AC Fail, FAN Fail
- Standard : USB, LAN, RS-232, RS-485, Analog Control
- Option : GPIB, Isolated Analog Interface(Voltage Control/Current Control)

GW INSTEK
Simply Reliable

CALPLUS
Die Kompetenz in der Messtechnik

CalPlus GmbH
Normannenweg 30
20537 Hamburg
Tel.: 040 3039595-0
Fax: 040 3039595-50
scopeshop@calplus.de
www.calplus.de

CalPlus GmbH - Zentrale
Heerstraße 32
14052 Berlin
Tel.: 030 214982-0
Fax: 030 214982-50
office@calplus.de
www.calplus.de

Global Headquarters

GOOD WILL INSTRUMENT CO., LTD.
No.7-1, Jhongsing Road, Tucheng Dist., New Taipei City 236, Taiwan
T +886-2-2268-0389 F +886-2-2268-0639
E-mail: marketing@goodwill.com.tw

China Subsidiary

GOOD WILL INSTRUMENT (SUZHOU) CO., LTD.
No. 521, Zhujiang Road, Snd, Suzhou Jiangsu 215011 China
T +86-512-6661-7177 F +86-512-6661-7277

Malaysia Subsidiary

GOOD WILL INSTRUMENT (SEA) SDN. BHD.
No. 1-3-18, Elit Avenue, Jalan Mayang Pasir 3,
11950 Bayan Baru, Penang, Malaysia
T +604-6111122 F +604-6115225

Europe Subsidiary

GOOD WILL INSTRUMENT EURO B.V.
De Run 5427A, 5504DG Veldhoven, THE NETHERLANDS
T +31 (0)40-2557790 F +31 (0)40-2541194

GW INSTEK
Simply Reliable



GW Instek PSU-Series, a DC power supply with high power density design, is 1U in height and compatible with 19" Rack Mount Size. The series is suitable for test system installation or system integration by flexibly selecting models for the integration into the existing test system. The PSU-Series, featuring superior voltage and current control functions, comprises fifteen models with output voltage/current ranging from 6V/200A to 600V/2.6A. The Series is suitable for different test conditions and DUTs, including electronic components testing, micro resistors, relays, shunt resistors, 12V/24V/48V battery simulation, and automotive electronic device testing.

The PSU-HV series is ideal for the primary input of DC/DC converter and servomotor production application. PSU is often integrated into component test systems such as aging test equipment for capacitors; 600V DC bias applications; aging test equipment for diode; semiconductor production equipment; automotive electronics; and ECU for V8 engine or V12 engine, etc.

Utilizing same model units of the PSU-Series to conduct series and parallel connections can increase total output power, total current or total voltage. The wide voltage and current output ranges of the PSU-Series can fully satisfy various voltage and current measurement requirements. The PSU-Series is a single power output DC programmable power supply, which outputs 1200W to 1560W. The PSU-Series provides maximum 2 units in series connection (models under 300V) to achieve maximum 600V or 4 units in parallel connection to obtain maximum 800A and the maximum output power of 6.24 kilowatts.

The PSU-Series allows settings for CC priority or CV priority. Under CC or CV mode, users can adjust slew rate for output voltage or current based upon test requirements. There are two kinds of slew rate settings: high speed priority and slew rate priority. High speed priority sets slew rate at the maximum speed to reach CC or CV mode. Slew rate priority allows users to set slew rate for CC or CV mode in order to control rise or fall slew rate. Slew rate priority mode is ideal for motor tests by adjusting the rise time of output voltage to protect DUT from being damaged by inrush current occurred at turn-on.

Comparing with other 1U power supplies available in the market, PSU supports a most complete array of interfaces, including USB, LAN, RS-232, RS-485, analog control interface, GPIB (option), isolated analog interface (voltage control), and isolated analog interface (current control). Via the multi-drop mode, PSU will not need any switch/hub and GPIB cable for remote control and slave unit augmentation when using LAN, USB or GPIB. This feature can help users save costs on augmentation equipment for connecting slave while using LAN or USB.

The PSU-Series provides users with flexible settings of High/Low Level or Trigger input/Trigger output signals with pulse width of 1 ~ 60ms. Trigger input controls PSU to output or upload preset voltage, current and memory parameters. While outputting or uploading preset voltage, current and memory parameters PSU can produce corresponding Trigger output signals.

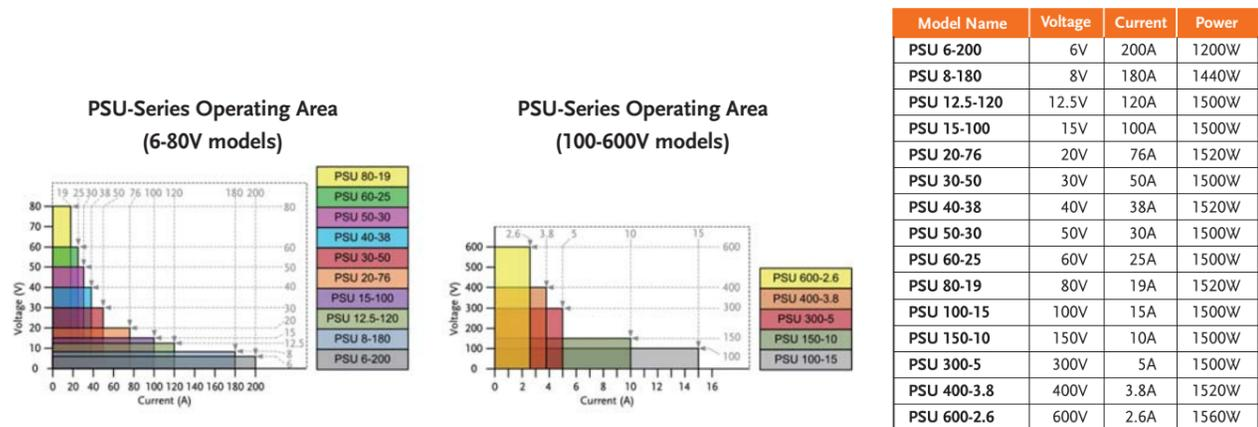

A. SERIES/PARALLEL OPERATION AND HIGH POWER DENSITY

Series Connection	1 unit	2 units	3 units	4 units
Height of sets	1U	2U	3U	4U
PSU 6-200	6V 200A	12V 200A	6V 400A	6V 800A
PSU 8-180	8V 180A	16V 180A	8V 360A	8V 720A
PSU 12.5-120	12.5V 120A	25V 120A	12.5V 240A	12.5V 480A
PSU 15-100	15V 100A	30V 100A	15V 200A	15V 400A
PSU 20-76	20V 76A	40V 76A	20V 152A	20V 304A
PSU 30-50	30V 50A	60V 50A	30V 100A	30V 200A
PSU 40-38	40V 38A	80V 38A	40V 76A	40V 152A
PSU 50-30	50V 30A	100V 30A	50V 60A	50V 120A
PSU 60-25	60V 25A	120V 25A	60V 50A	60V 75A
PSU 80-19	80V 19A	160V 19A	80V 38A	80V 57A
PSU 100-15	100V 15A	200V 15A	100V 30A	100V 45A
PSU 150-10	150V 10A	300V 10A	150V 20A	150V 30A
PSU 300-5	300V 5A	600V 5A	300V 10A	300V 15A
PSU 400-3.8	400V 3.8A	NA	400V 7.6A	400V 11.4A
PSU 600-2.6	600V 2.6A	NA	600V 5.2A	600V 7.8A

To augment output power, the PSU-series can realize two-fold rated power (models under 300V) via 2 same model units in series connection; and four-fold rated power via 4 same model units in parallel connection so as to satisfy customers with large voltage and large current requirements. 2U height units in series connection can achieve maximum 600V output. 4U height units in parallel connection can output maximum 800A and 6240W.

B. REMOTE PROGRAM CONTROL (UP TO 31 UNITS CONNECTION)

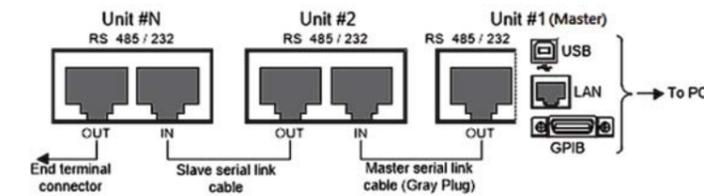

Provide RS-232, RS-485, USB, GPIB and LAN for PC to remote control Master PSU-Series. RJ-45 connector on the rear panel can connect up to 31 units.

LAN or USB remote control and augmenting slave units by using PSU-Series multi-drop mode will no longer need any switch/hub that can help customers save equipment costs.

* For the detailed information please refer to User Manual

C. C.V/C.C PRIORITY MODE

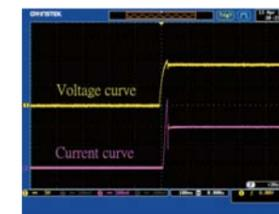

Under the conventional C.V mode, inrush current and surge voltage appeared at forward voltage (V_f) of LED.

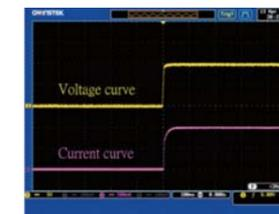

Under C.C priority mode, inrush current and surge voltage are effectively restrained.

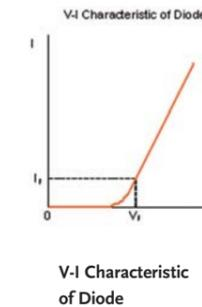

V-I Characteristic of Diode

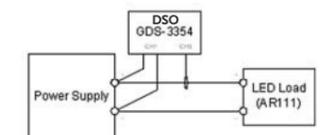

Using GDS-3354 DSO to Test LED Operation Under C.V Priority and C.C Priority Respectively

Conventional power supplies under the CV priority mode will produce inrush current and surge voltage at turn-on. The PSU-series has CV and CC priority modes.

The CC priority mode can prevent inrush current and surge voltage from occurring at turn-on to protect DUT.

D. ADJUSTABLE SLEW RATE

VOLTAGE SLEW RATE	CURRENT SLEW RATE
0.001V~0.060V/msec (PSU 6-200)	0.001A~2.000A / msec (PSU 6-200)
0.001V~0.080V/msec(PSU 8-180)	0.001A~1.800A / msec (PSU 8-180)
0.001V~0.125V/msec (PSU 12.5-120)	0.001A~1.200A / msec (PSU 12.5-120)
0.001V~0.150V/msec(PSU 15-100)	0.001A~1.000A / msec(PSU 15-100)
0.001V~0.200V/msec (PSU 20-76)	0.001A~0.760A / msec (PSU 20-76)
0.001V~0.300V/msec(PSU 30-50)	0.001A~0.500A / msec(PSU 30-50)
0.001V~0.400V/msec (PSU 40-38)	0.001A~0.380A / msec (PSU 40-38)
0.001V~0.500V/msec(PSU 50-30)	0.001A~0.300A / msec(PSU 50-30)
0.001V~0.600V/msec (PSU 60-25)	0.001A~0.250A / msec (PSU 60-25)
0.001V~0.800V/msec(PSU 80-19)	0.001A~0.190A / msec(PSU 80-19)
0.001V~1.000V/msec (PSU 100-15)	0.001A~0.150A / msec (PSU 100-15)
0.001V~1.500V/msec (PSU 150-10)	0.001A~0.100A / msec (PSU 150-10)
0.001V~1.500V/msec (PSU 300-5)	0.001A~0.025A / msec (PSU 300-5)
0.001V~2.000V/msec (PSU 400-3.8)	0.001A~0.008A / msec (PSU 400-3.8)
0.001V~2.400V/msec (PSU 600-2.6)	0.001A~0.006A / msec (PSU 600-2.6)

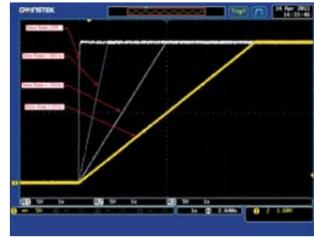

Adjustable Voltage Slew Rate

The PSU series can adjust slew rate for current and voltage. Via setting the rise and fall time of voltage and current, users can verify DUT's characteristics during voltage and current variation.

Additionally, slew rate adjustment can mitigate voltage shift to effectively prevent DUT from being damaged by inrush current. This function is ideal for tests such as capacitive load and motor.

E. OVP, OCP AND UVL

SETTING RANGE

MODEL	OCP	OVP	UVL
PSU 6-200	5 ~ 220A	0.6 ~ 6.6V	0 ~ 6.3V
PSU 8-180	5 ~ 198A	0.8 ~ 8.8V	0 ~ 8.4V
PSU 12.5-120	5 ~ 132A	1.25 ~ 13.75V	0 ~ 13.12V
PSU 15-100	5 ~ 110A	1.5 ~ 16.5V	0 ~ 15.75V
PSU 20-76	5 ~ 83.6A	2 ~ 22V	0 ~ 21V
PSU 30-50	5 ~ 55A	3 ~ 33V	0 ~ 31.5V
PSU 40-38	3.8 ~ 41.8A	4 ~ 44V	0 ~ 42V
PSU 50-30	3 ~ 33A	5 ~ 55V	0 ~ 52.5V
PSU 60-25	2.5 ~ 27.5A	5 ~ 66V	0 ~ 63V
PSU 80-19	1.9 ~ 20.9A	5 ~ 88V	0 ~ 84V
PSU 100-15	1.5 ~ 16.5A	5 ~ 110V	0 ~ 105V
PSU 150-10	1 ~ 11A	5 ~ 165V	0 ~ 157.5V
PSU 300-5	0.5 ~ 5.5A	5 ~ 330V	0 ~ 315V
PSU 400-3.8	0.38 ~ 4.18A	5 ~ 440V	0 ~ 420V
PSU 600-2.6	0.26 ~ 2.86A	5 ~ 660V	0 ~ 630V

Once the voltage or current output exceeds the preset level of OVP or OCP, PSU will shut down output to protect DUT. UVL is for users to set the minimum output voltage from the output terminal.

F. TRIGGER CONTROL (TRIGGER INPUT/TRIGGER OUTPUT)

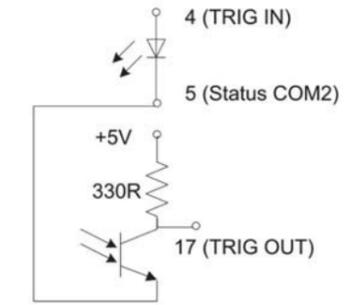

PSU-series provides users with complete trigger input and trigger output functions so as to flexibly control PSU-series. Each function is elaborated as follows.

Trigger Input function :

1. Allow users to set the effective pulse width from 0~60ms for trigger input (0: the LOW or HIGH signal of DC level for trigger input)
2. Receive trigger input to control PSU-series output or to output preset voltage and current.
3. Receive trigger input to upload preset memory parameters.

Trigger Output function :

1. Allow users to set the effective pulse width from 0~60ms for trigger output (0: the LOW or HIGH signal of DC level for trigger output)
2. Set LOW or HIGH for output DC level
3. PSU produces trigger output signal when setting output or changing preset value or uploading preset memory parameters.

G. EXTERNAL ANALOG CONTROL FUNCTION

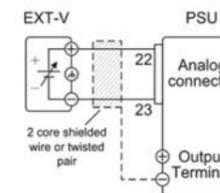

- Pin23 → EXT-V (-)
- Pin22 → EXT-V (+)
- Wire shield → negative (-) output terminal

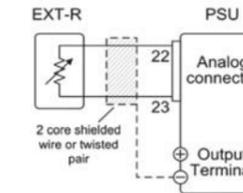

- Pin22 → EXT-R
- Pin23 → EXT-R
- Wire shield → negative (-) output terminal

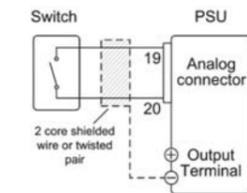

- Pin19 → Switch
- Pin20 → Switch
- Wire shield → negative (-) output terminal

External Voltage Controls Voltage Range External Resistance Controls Voltage Range External On-off to Control Output, on or off

The rear panel of the PSU-series has an analog control terminal. The external analog control interface allows external voltage or resistance to control voltage and current output; and allows power supply to output or to be turned on and off. The diagram on the upper shows typical connection methods for external control applications. For more detailed connection information please refers to user manual.

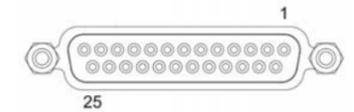

H. BLEEDER CONTROL

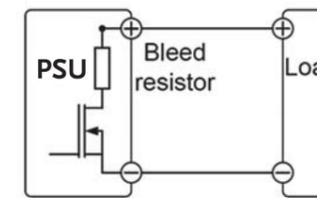

PSU-Series Built-in Bleed Resistor

The PSU-Series employs a bleed resistor in parallel with the output terminal. Bleed resistor is designed to dispatch the power from the power supply filter capacitors when power is turned off or the load is disconnected. Without a bleed resistor, power terminal may remain charged on the filter capacitors for some time and be potentially hazardous. In addition, bleed resistor also allows for smoother voltage regulation of the power supply as the bleed resistor acts as a minimum voltage load. The bleed resistance can be turned on or off using the configuration setting.

I. VARIOUS INTERFACES SUPPORT

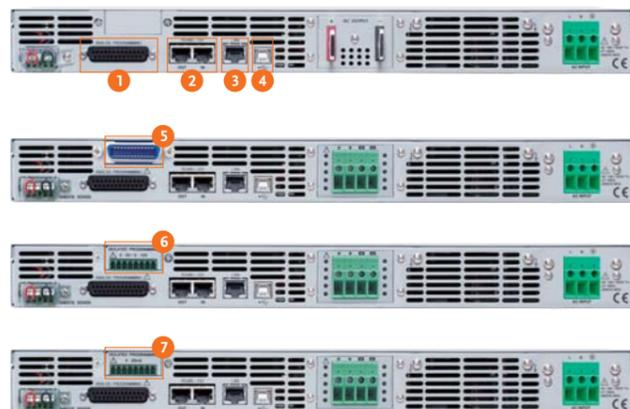

1. Analog Control Interface
2. RS485/RS232 Interface for Remote Control
3. LAN Port for System Communication
4. USB Interface for Remote Control
5. GPIB Interface for Remote Control
6. Isolate Voltage Remote Control Card
7. Isolate Current Remote Control Card

J. USING THE RACK MOUNT KIT



Rack Mount Kit for PSU-Series EIA & JIS

The rack mount kit of the PSU-Series supports both EIA and JIS standards. A standard rack can accommodate one unit of the PSU-Series.

K. OUTPUT ON / OFF DELAY

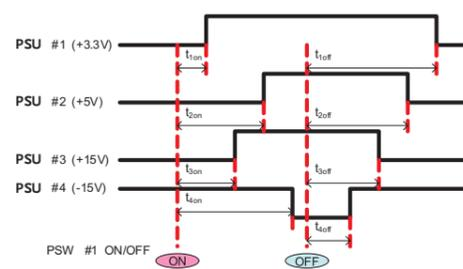

The Example of Output On/Off Delay Control Among Multiple Outputs of the PSU Units

The Output On/Off delay feature enables the setting of a specific time delay for output on after the power supply output is turned on, and a specific time delay for output off after the power supply output is turned off. When multiple PSU units are used, the On/Off

delay time of each unit can be set respectively referring to fix time points. This multiple-output control can be done through the analog control terminal at rear panel or through the PC programming with standard commands.

PANEL INTRODUCTION



- | | | |
|---------------------------------------|------------------------------|---|
| 1. AC Power Switch (AC Power On/Off) | 7. DC Output Terminal | 12. Option Slot for (Selection One of Three)
GPIB Interface Card/Isolate Voltage Remote
Control Card/Isolate Current Remote
Control Card |
| 2. USB A Port | 8. USB | |
| 3. Voltage Knob | 9. LAN | |
| 4. Display Area | 10. RS 485/RS 232 | |
| 5. Current Knob | 11. Analog Control Interface | 13. Remote Sense |
| 6. AC Input (HV:Wire Clamp Connector) | | |

OPTIONAL ASSESSORIES

PSU-001 Front panel filter kit (factory Installed) 	PSU-01C Cable for 2 units in parallel connection 	PSU-02C Cable for 3 units in parallel connection 	GPW-001 UL/CSA power cord 3m, PSU option 	PSU-01A Joins a vertical stack of 2 PSU units together. 2U-sized handles x2, joining plates x2
PSU-01B Bus bar for 2 units in parallel connection 	PSU-232 RS232 Cable with DB9 connector kit 	PSU-03B Bus bar for 4 units in parallel connection 	GPW-002 VDE power cord 3m, PSU option 	PSU-02A Joins a vertical stack of 3 PSU units together. 3U-sized handles x2, joining plates x2
PSU-02B Bus bar for 3 units in parallel connection 	PSU-485 RS485 Cable with DB9 connector kit 	PSU-03C Cable for 4 units in parallel connection 	GPW-003 PSE power cord 3m, PSU option 	PSU-03A Joins a vertical stack of 4 PSU units together. 4U-sized handles x2, joining plates x2
GRM-001 Slide bracket 2pcs/set, PSU option 				

SPECIFICATIONS									
MODEL	PSU 6-200	PSU 8-180	PSU 12.5-120	PSU 15-100	PSU 20-76	PSU 30-50	PSU 40-38	PSU 50-30	
OUTPUT RATINGS									
Rated Output Voltage (*1)	6V	8V	12.5V	15V	20V	30V	40V	50V	
Rated Output Current (*2)	200A	180A	120A	100A	76A	50A	38A	30A	
Rated Output Power	1200W	1440W	1500W	1500W	1520W	1500W	1520W	1500W	
RIPPLE AND NOISE(*5)									
CVp-p(10 ~ 20MHz) p-p (*6)	60mV	60mV	60mV	60mV	60mV	60mV	60mV	60mV	
CVrms(5Hz ~ 1MHz) r.m.s. (*7)	8mV	8mV	8mV	8mV	8mV	8mV	8mV	8mV	
CCrms(5Hz ~ 1MHz) r.m.s. (*12)	400mA	360mA	240mA	200mA	152mA	125mA	95mA	85mA	
LOAD REGULATION									
Voltage(*4)	2.6mV	2.8mV	3.25mV	3.5mV	4mV	5mV	6mV	7mV	
Current(*11)	45mA	41mA	29mA	25mA	20.2mA	15mA	12.6mA	11mA	
LINE REGULATION									
Voltage(*3)	2.6mV	2.8mV	3.25mV	3.5mV	4mV	5mV	6mV	7mV	
Current(*3)	22mA	20mA	14mA	12mA	9.6mA	7mA	5.8mA	5mA	
ANALOG PROGRAMMING AND MONITORING									
External Voltage Control Output Voltage	Accuracy and linearity: ±0.5% of rated output voltage								
External Voltage Control Output Current	Accuracy and linearity: ±1% of rated output current								
External Resistor Control Output Voltage	Accuracy and linearity: ±1% of rated output voltage								
External Resistor Control Output Current	Accuracy and linearity: ±1.5% of rated output current								
Output Voltage Monitor	Accuracy: ±1%								
Output Current Monitor	Accuracy: ±1%								
Shutdown Control	Turns the output off with a LOW (0V to 0.5V) or short-circuit								
Output On/Off Control	Possible logic selections: Turn the output on using a LOW (0V to 0.5V) or short-circuit, turn the output off using a HIGH (4.5V to 5V) or open-circuit; Turn the output on using a HIGH (4.5V to 5V) or open-circuit, turn the output off using a LOW (0V to 0.5V) or short-circuit								
Alarm Clear Control	Clear alarms with a LOW (0V to 0.5V) or short-circuit								
CV/CC/ALM/PWR ON/OUT ON Indicator	Photocoupler open collector output; Maximum voltage 30V, maximum sink current 8mA								
Trigger Out	Maximum low level output = 0.8V; minimum high level output = 2V; Maximum source current = 8mA								
Trigger In	Maximum low level input voltage = 0.8V; minimum high level input voltage = 2V, Maximum sink current = 8mA								
FRONT PANEL									
Display, 4 digits, Voltage Accuracy 0.1%+ Current Accuracy 0.2%+	12mV 600mA	16mV 540mA	25mV 360mA	30mV 300mA	40mV 228mA	60mV 150mA	80mV 114mA	100mV 90mA	
Indications	GREEN LED's: CV, CC, V, A, VSR, ISR, DLY, RMT, LAN, M1, M2, M3, RUN, Output ON; RED LED's: ALM, ERR								
Buttons	Lock/Local(Unlock), PROT(ALM_CLR), Function(M1), Test(M2), Set(M3), Shift, Output								
Knobs	Voltage, Current								
USB Port	Type A USB connector								
TRANSIENT RESPONSE TIME (*10)									
Transient Response Time	1.5ms	1.5ms	1ms	1ms	1ms	1ms	1ms	1ms	
OUTPUT RESPONSE TIME									
Rise Time(*8)	80ms	80ms	80ms	80ms	80ms	80ms	80ms	80ms	
Fall Time(*9)	10ms	50ms	50ms	50ms	50ms	80ms	80ms	80ms	
	500ms	600ms	700ms	700ms	800ms	900ms	1000ms	1100ms	
PROGRAMMING AND MEASUREMENTS (RS-232/485, USB, LAN, GPIB)									
Output Voltage Programming Accuracy 0.05%+	3mV	4mV	6.25mV	7.5mV	10mV	15mV	20mV	25mV	
Output Current Programming Accuracy 0.2%+	200mA	180mA	120mA	100mA	76mA	50mA	38mA	30mA	
Output Voltage Programming Resolution	0.2mV	0.27mV	0.4mV	0.5mV	0.7mV	1mV	1.3mV	1.7mV	
Output Current Programming Resolution	6mA	6mA	4mA	3.3mA	2.5mA	1.7mA	1.2mA	1mA	
Output Voltage Measurement Accuracy 0.1%+	6mV	8mV	12.5mV	15mV	20mV	30mV	40mV	50mV	
Output Current Measurement Accuracy 0.2%+	400mA	360mA	240mA	200mA	152mA	100mA	76mA	60mA	
Output Voltage Measurement Resolution	0.2mV	0.27mV	0.4mV	0.5mV	0.7mV	1mV	1.3mV	1.7mV	
Output Current Measurement Resolution	6mA	6mA	4mA	3.3mA	2.5mA	1.7mA	1.2mA	1mA	
TEMPERATURE COEFFICIENCY									
Voltage & Current	100ppm/°C after a 30 minute warm-up								
REMOTE SENSE COMPENSATION VOLTAGE(TWO WIRE)									
Voltage	1V	1V	1V	1V	1.5V	2V	2V	2V	
PROTECTION FUNCTION									
Over Voltage Protection(OVP) Setting Range	0.6~6.6V	0.8~8.8V	1.25~13.75V	1.5~16.5V	2~22V	3~33V	4~44V	5~55V	
Over Voltage Protection(OVP) Setting Accuracy	60mV	80mV	125mV	150mV	200mV	300mV	400mV	500mV	
Over Current Protection(OCP) Setting Range	5~220A	5~198A	5~132A	5~110A	5~83.6A	5~55A	3.8~41.8A	3~33A	
Over Current Protection(OCP) Setting Accuracy	4000mA	3600mA	2400mA	2000mA	1520mA	1000mA	760mA	600mA	
Under Voltage Limit(UVL) Setting Range	0~6.3V	0~8.4V	0~13.12V	0~15.75V	0~21V	0~31.5V	0~42V	0~52.5V	
Over Temperature Protection(OHP) Operation	Turn the output off.								
Incorrect Sensing Connection Protection(SENSE) Operation	Turn the output off.								
Low AC Input Protection (AC-FAIL) Operation	Turn the output off.								
Shutdown (SD) Operation	Turn the output off.								
Power Limit (POWER LIMIT) Operation	Over power limit								
Value (Fixed)	Approx. 105% of rated output power								
INTERFACE CAPABILITIES									
USB	TypeA: Host, TypeB: Slave, Speed: 1.1/2.0, USB Class: CDC(Communications Device Class)								
LAN	MAC Address, DNS IP Address, User Password, Gateway IP Address, Instrument IP Address, Subnet Mask								
RS-232 / RS-485	Complies with the EIA232D / EIA485 Specifications								
GPIB (Factory Option)	SCPI - 1993, IEEE 488.2 compliant interface								
ISOLATED ANALOG CONTROL INTERFACE (FACTORY OPTION)									
Voltage Control	Using 0-5V or 0-10V signals for programming and measurement								
Current Control	Using 4-20mA current signals for programming and measurement								
ENVIRONMENTAL CONDITIONS									
Operating Temperature	0°C ~ 50°C (*14)								
Storage Temperature	-25°C ~ 70°C								
Operating Humidity	20% ~ 85% RH; No condensation								
Storage Humidity	90% RH or less; No condensation								
Altitude	Maximum 2000m								
INPUT CHARACTERISTICS									
Nominal Input Rating	100Vac to 240Vac, 50Hz to 60Hz, single phase								
Input Voltage Range	85Vac ~ 265Vac								
Input Frequency Range	47Hz ~ 63Hz								
Maximum Input Current	100Vac/200Vac(A) 21/11								
Inrush Current	Less than 50A								
Maximum Input Power	2000VA								
Power Factor	100Vac/200Vac 0.99/0.98								
Hold-up Time	20ms or greater								
Efficiency (*13)	100Vac/200Vac(%)	76.5/79	78/81	82/85	82/85	83/86	83/86	84/87	84/87
DIMENSIONS & WEIGHT									
	423(W) × 43.6(H) × 447.2(D)mm, Approx. 8.7kg								

SPECIFICATIONS									
MODEL	PSU 60-25	PSU 80-19	PSU 100-15	PSU 150-10	PSU 300-5	PSU 400-3.8	PSU 600-2.6		
OUTPUT RATINGS									
Rated Output Voltage (*1)	60V	80V	100V	150V	300V	400V	600V		
Rated Output Current (*2)	25A	19A	15A	10A	5A	3.8A	2.6A		
Rated Output Power	1500W	1520W	1500W	1500W	1500W	1520W	1560W		
RIPPLE AND NOISE(*5)									
CVp-p(10 ~ 20MHz) p-p (*6)	60mV	80mV	80mV	100mV	150mV	200mV	300mV		
CVrms(5Hz ~ 1MHz) r.m.s. (*7)	8mV	8mV	8mV	10mV	25mV	40mV	60mV		
CCrms(5Hz ~ 1MHz) r.m.s. (*12)	75mA	57mA	45mA	35mA	25mA	17mA	12mA		
LOAD REGULATION									
Voltage(*4)	8mV	10mV	12mV	17mV	32mV	42mV	62mV		
Current(*11)	10mA	8.8mA	8mA	7mA	6mA	5.76mA	5.52mA		
LINE REGULATION									
Voltage(*3)	8mV	10mV	12mV	17mV	32mV	42mV	62mV		
Current(*3)	4.5mA	3.9mA	3.5mA	3mA	2.5mA	2.38mA	2.26mA		
ANALOG PROGRAMMING AND MONITORING									
External Voltage Control Output Voltage	Accuracy and linearity: ±0.5% of rated output voltage								
External Voltage Control Output Current	Accuracy and linearity: ±1% of rated output current								
External Resistor Control Output Voltage	Accuracy and linearity: ±1% of rated output voltage								
External Resistor Control Output Current	Accuracy and linearity: ±1.5% of rated output current								
Output Voltage Monitor	Accuracy: ±1%								
Output Current Monitor	Accuracy: ±1%								
Shutdown Control	Turns the output off with a LOW (0V to 0.5V) or short-circuit								
Output On/Off Control	Possible logic selections: Turn the output on using a LOW (0V to 0.5V) or short-circuit, turn the output off using a HIGH (4.5V to 5V) or open-circuit; Turn the output on using a HIGH (4.5V to 5V) or open-circuit, turn the output off using a LOW (0V to 0.5V) or short-circuit								
Alarm Clear Control	Clear alarms with a LOW (0V to 0.5V) or short-circuit								
CV/CC/ALM/PWR ON/OUT ON Indicator	Photocoupler open collector output; Maximum voltage 30V, maximum sink current 8mA								
Trigger Out	Maximum low level output = 0.8V; minimum high level output = 2V; Maximum source current = 8mA								
Trigger In	Maximum low level input voltage = 0.8V; minimum high level input voltage = 2V, Maximum sink current = 8mA								
FRONT PANEL									
Display, 4 digits, Voltage Accuracy 0.1%+ Current Accuracy 0.2%+	120mV 75mA	160mV 57mA	200mV 45mA	300mV 30mA	600mV 15mA	800mV 11.4mA	1200mV 7.8mA		
Indications	GREEN LED's: CV, CC, V, A, VSR, ISR, DLY, RMT, LAN, M1, M2, M3, RUN, Output ON; RED LED's: ALM, ERR								
Buttons	Lock/Local(Unlock), PROT(ALM_CLR), Function(M1), Test(M2), Set(M3), Shift, Output								
Knobs	Voltage, Current								
USB Port	Type A USB connector								
TRANSIENT RESPONSE TIME (*10)									
Transient Response Time	1ms	1ms	1ms	2ms	2ms	2ms	2ms		
OUTPUT RESPONSE TIME									
Rise Time(*8)	80ms	150ms	150ms	150ms	150ms	200ms	250ms		
Fall Time(*9)	80ms	150ms	150ms	150ms	150ms	200ms	250ms		
	1100ms	1200ms	1500ms	2000ms	2500ms	3000ms	4000ms		
PROGRAMMING AND MEASUREMENTS (RS-232/485, USB, LAN, GPIB)									
Output Voltage Programming Accuracy 0.05%+	30mV	40mV	50mV	75mV	150mV	200mV	300mV		
Output Current Programming Accuracy 0.2%+	25mA	19mA	15mA	10mA	5mA	3.8mA	2.6mA		
Output Voltage Programming Resolution	2mV	2.7mV	3.4mV	5.2mV	10.2mV	13.6mV	20.4mV		
Output Current Programming Resolution	0.8mA	0.65mA	0.5mA	0.34mA	0.19mA	0.13mA	0.09mA		
Output Voltage Measurement Accuracy 0.1%+	60mV	80mV	100mV	150mV	300mV	400mV	600mV		
Output Current Measurement Accuracy 0.2%+	50mA	38mA	30mA	20mA	10mA	7.6mA	5.2mA		
Output Voltage Measurement Resolution	2mV	2.7mV	3.4mV	5.2mV	10.2mV	13.6mV	20.4mV		
Output Current Measurement Resolution	0.8mA	0.65mA	0.5mA	0.34mA	0.19mA	0.13mA	0.09mA		
TEMPERATURE COEFFICIENCY									
Voltage & Current	100ppm/°C after a 30 minute warm-up								
REMOTE SENSE COMPENSATION VOLTAGE(TWO WIRE)									
Voltage	3V	4V	5V	5V	5V	5V	5V		
PROTECTION FUNCTION									
Over Voltage Protection(OVP) Setting Range	5~66V	5~88V	5~110V	5~165V	5~330V	5~440V	5~660V		
Over Voltage Protection(OVP) Setting Accuracy	600mV	800mV	1000mV	1500mV	3000mV	4000mV	6000mV		
Over Current Protection(OCP) Setting Range	2.5~27.5A	1.9~20.9A	1.5~16.5A	1~11A	0.5~5.5A	0.38~4.18A	0.26~2.86A		
Over Current Protection(OCP) Setting Accuracy	500mA	380mA	300mA	200mA	100mA	76mA	52mA		
Under Voltage Limit(UVL) Setting Range	0~6.3V	0~8.4V	0~10.5V	0~15.75V	0~31.5V	0~42.0V	0~63.0V		
Over Temperature Protection(OHP) Operation	Turn the output off.								
Incorrect Sensing Connection Protection(SENSE) Operation	Turn the output off.								
Low AC Input Protection (AC-FAIL) Operation	Turn the output off.								
Shutdown (SD) Operation	Turn the output off.								
Power Limit (POWER LIMIT) Operation	Over power limit								
Value (Fixed)	Approx. 105% of rated output power								
INTERFACE CAPABILITIES									
USB	TypeA: Host, TypeB: Slave, Speed: 1.1/2.0, USB Class: CDC(Communications Device Class)								
LAN	MAC Address, DNS IP Address, User Password, Gateway IP Address, Instrument IP Address, Subnet Mask								
RS-232 / RS-485	Complies with the EIA232D / EIA485 Specifications								
GPIB (Factory Option)	SCPI - 1993, IEEE 488.2 compliant interface								
ISOLATED ANALOG CONTROL INTERFACE (FACTORY OPTION)									
Voltage Control	Using 0-5V or 0-10V signals for programming and measurement								
Current Control	Using 4-20mA current signals for programming and measurement								
ENVIRONMENTAL CONDITIONS									
Operating Temperature	0°C ~ 50°C (*14)								
Storage Temperature	-25°C ~ 70°C								
Operating Humidity	20% ~ 85% RH; No condensation								
Storage Humidity	90% RH or less; No condensation								
Altitude	Maximum 2000m								
INPUT CHARACTERISTICS									
Nominal Input Rating	100Vac to 240Vac, 50Hz to 60Hz, single phase								
Input Voltage Range	85Vac ~ 265Vac								
Input Frequency Range	47Hz ~ 63Hz								
Maximum Input Current	100Vac/200Vac(A) 21/11								
Inrush Current	Less than 50A								
Maximum Input Power	2000VA								
Power Factor	100Vac/200Vac 0.99/0.98								
Hold-up Time	20ms or greater								
Efficiency (*13)	100Vac/200Vac(%)	84/87	84/87	84/87	84/87	84/87	84/87		
DIMENSIONS & WEIGHT									
	423(W) × 43.6(H) × 447.2(D)mm, Approx. 8.7kg								