

3153

Instruction Manual

AUTOMATIC INSULATION/ WITHSTANDING HiTESTER



EN

Contents

Introduction	i
Inspection	i
Safety Notes	ii
Notes on Use	v
Chapter Summary	vi
Chapter 1 Overview	1
1.1 Product Introduction	1
1.2 Names and Functions of Parts	3
1.2.1 Front panel	3
1.2.2 Rubber keys	4
1.2.3 Rear panel	5
1.2.4 9615 H.V. TEST LEAD	6
1.2.5 REMOTE CONTROL BOX	7
1.3 External Dimensions	8
Chapter 2 Testing Arrangements	9
2.1 Connecting the Protective Ground Terminal	9
2.2 Wearing rubber gloves	10
2.3 Connecting the External I/O Connector	10
2.4 Power Cord Connection	11
2.5 Powering On and Off the Unit	12
2.6 Connecting the 9615 H.V. TEST LEAD	14
2.7 Connecting the REMOTE CONTROL BOX	15
2.8 Installation of the Unit	16
2.9 Connection to the Measured Equipment	17
2.10 Startup Inspection	18
Chapter 3 Withstand Voltage Mode Testing Method	19
3.1 Withstand Voltage Mode Display	20
3.2 Displaying the "READY" State	22
3.2.1 Key-lock Function	23
3.3 "SETTING" State	24
3.3.1 Setting the Test Voltage Value	25
3.3.2 Setting the Upper (Lower) Limit Value	26
3.3.3 Setting the Test Time	27
3.3.4 Setting of the Ramp Timer	28

3.3.5	Setting the Type of Test Voltage	29
3.3.6	Examples of Settings	30
3.4	Starting a Test	34
3.4.1	Executing a Test	34
3.4.2	Screening in "TEST" State	36
3.5	"PASS" or "FAIL" Determination	37
3.5.1	"PASS" State	37
3.5.2	Screening in "PASS" State	38
3.5.3	"FAIL" State	39
3.5.4	Screening in "FAIL" State	41
3.6	Automatic Discharge Function	42

Chapter 4 Insulation Resistance Mode Testing Method 43

4.1	Insulation Resistance Mode Display	44
4.2	Displaying the "READY" State	46
4.2.1	Key-lock Function	47
4.3	"SETTING" State	48
4.3.1	Setting the Test Voltage Value	49
4.3.2	Setting the Lower (Upper) Limit Value	50
4.3.3	Setting the Test Time	52
4.3.4	Setting the Delay Time	53
4.3.5	Examples of Settings	54
4.4	Starting a Test	57
4.4.1	Executing a Test	58
4.4.2	Screening in "TEST" State	59
4.5	"PASS" or "FAIL" Determination	60
4.5.1	"PASS" State	60
4.5.2	Screening in "PASS" State	62
4.5.3	"FAIL" State	63
4.5.4	Screening in "FAIL" State	65
4.6	Automatic Discharge Function	66

Chapter 5 Auto Test Mode Testing Method 67

5.1	Auto Test Mode Display	68
5.2	Displaying the "READY" State	70
5.2.1	Key-lock Function	71
5.3	"SETTING" State	72
5.4	Starting a Test	73
5.4.1	Executing a Test	74
5.4.2	Screening in "TEST" State	75
5.5	PASS or FAIL Determination	76

5.5.1	"PASS" State	76
5.5.2	Screening in "PASS" State	78
5.5.3	"FAIL" State	79
5.5.4	Screening in "FAIL" State	81
5.6	Automatic Discharge Function	82
Chapter 6	Program Mode Testing Method	83
6.1	Program Mode Display	84
6.2	Displaying the "READY" State	86
6.2.1	Key-lock Function	87
6.3	Program Setting State	88
6.3.1	Examples of Settings	91
6.4	Program-File Loading	96
6.5	Starting a Test	97
6.5.1	Executing a Test	98
6.5.2	Screening in "TEST" State	99
6.6	PASS or FAIL Determination	100
6.6.1	"PASS" State	100
6.6.2	Screening in "PASS" State	101
6.6.3	"FAIL" State	102
6.6.4	Screening in "FAIL" State	104
6.7	Automatic Discharge Function	105
Chapter 7	Optional Functions	107
7.1	PASS Hold Function	110
7.2	FAIL Hold Function	111
7.3	Hold Function	112
7.4	Momentary Out	114
7.5	Double Action	115
7.6	FAIL Mode	116
7.7	Interface Command "START"	117
7.8	Inter-lock Function	118
7.9	Setting of an Output-Voltage Restricting Value	119
7.10	Insulation Resistance Test Measurement Range	120
7.11	Insulation Resistance Test Termination Mode Settings	121
7.12	Setting for Screening during the Ramp-Up Time	123
7.13	PC Interface	124
7.14	START Protection Function	125
7.15	TEST-Signal Output	126
7.16	Example of Optional Functions Use	127

Chapter 8	Saving/loading Preset Values	129
8.1	Saving Preset Values	129
8.1.1	Procedure for Saving Data	129
8.1.2	Example of Saving	132
8.2	Loading Preset Values	134
8.2.1	Procedure for Loading Data	134
8.2.2	Example of Loading	137
Chapter 9	External Interface	139
9.1	External I/O Terminal	139
9.1.1	Signal Line	140
9.1.2	Example of Input Signal Connection	142
9.1.3	Example of Output Signal Connection	144
9.1.4	Inter-lock Function	146
9.1.5	Selecting a Program Test File	147
9.1.6	Timing Chart of External I/O Terminal	149
9.2	Buzzer	154
Chapter 10	PC Interface	155
10.1	RS-232C Interface	156
10.1.1	Specifications	156
10.1.2	Preparing for Data Transfer	157
10.1.3	RS-232C Command Transfer Methods	159
10.2	Command Table	164
10.3	RS-232C Command Reference	167
10.3.1	Common Command Messages	168
10.3.2	Specific Command Messages	171
10.4	Response Formats	201
10.5	GP-IB Interface	203
10.5.1	Specifications	203
10.5.2	Preparing for Data Transfer	203
10.6	GP-IB Command Transfer Methods	205
10.7	GP-IB Commands	211
10.8	GP-IB Command Reference	212
10.8.1	Command Reference	212
10.8.2	Specific Command Messages	216
Chapter 11	Specifications	219
11.1	Basic Specifications	219
11.1.1	Withstand Voltage test portion	219
11.1.2	Insulation resistance test portion	221

11.1.3	Timer Section	222
11.1.4	Interface	223
11.1.5	Program Function	224
11.1.6	Other Functions	225
11.2	General Specifications	226
Chapter 12	Maintenance and Inspection	227
12.1	Maintenance and Service	227
12.2	Fuse Replacement	229
12.3	Troubleshooting	230
12.4	Displaying Errors	231
12.5	Removing the Lithium Battery	232
12.6	Resetting the System	233
Appendix APPENDIX 1	
Appendix 1	9613 REMOTE CONTROL BOX (SINGLE) APPENDIX 1	
Appendix 2	9614 REMOTE CONTROL BOX (DUAL) APPENDIX 2	
Appendix 3	9615 H.V. TEST LEAD (Standard Accessory) APPENDIX 3	
Appendix 4	Insulation Resistance Mode measurement range APPENDIX 4	
INDEX INDEX 1	

Introduction

Thank you for purchasing the HIOKI 3153 AUTOMATIC INSULATION/WITHSTANDING HiTESTER. To obtain maximum performance from the product, please read this manual first, and keep it handy for future reference.

Inspection

When you receive the product, inspect it carefully to ensure that no damage occurred during shipping. In particular, check the connectors. If damage is evident, or if it fails to operate according to the specifications, contact your dealer or Hioki representative.

Accessories

Verify that the following standard accessories are complete.

Instruction Manual	1
Spare fuse (built into the power inlet)	1
Grounded three-core power cord	1
9615 H.V. TEST LEAD (High voltage and return side)	1

Shipment of the unit

Use the original packing materials when reshipping the product, if possible.

Warranty

HIOKI cannot be responsible for losses caused either directly or indirectly by the use of the 3153 with other equipment, or if ownership is transferred to a third party.

NOTE

Before using the product, make sure that the insulation on the leads is undamaged and that no bare conductors are improperly exposed. Using the product in such conditions could cause an electric shock, so contact your dealer or Hioki representative for repair.

Safety Notes



This product is designed to conform to IEC 61010 Safety Standards, and has been thoroughly tested for safety prior to shipment. However, mishandling during use could result in injury or death, as well as damage to the product. Be certain that you understand the instructions and precautions in the manual before use. We disclaim any responsibility for accidents or injuries not resulting directly from product defects.

This manual contains information and warnings essential for safe operation of the product and for maintaining it in safe operating condition. Before using the product, be sure to carefully read the following safety notes.

Safety Symbols

	<ul style="list-style-type: none"> The symbol printed on the product indicates that the user should refer to a corresponding topic in the manual (marked with the symbol) before using the relevant function. In the manual, the symbol indicates particularly important information that the user should read before using the product.
	Indicates that dangerous voltage may be present at this terminal.
	Indicates a fuse.
	Indicates AC (Alternating Current).
	Indicates both DC (Direct Current) and AC (Alternating Current).
	Indicates a protective conductor terminal.
	Indicates a grounding terminal.
	Indicates the ON side of the power switch.
	Indicates the OFF side of the power switch.

The following symbols in this manual indicate the relative importance of cautions and warnings.

	Indicates that incorrect operation presents an extreme hazard that could result in serious injury or death to the user.
	Indicates that incorrect operation presents a significant hazard that could result in serious injury or death to the user.
	Indicates that incorrect operation presents a possibility of injury to the user or damage to the product.
	Advisory items related to performance or correct operation of the product.

Measurement categories

To ensure safe operation of measurement products, IEC 61010 establishes safety standards for various electrical environments, categorized as CAT II to CAT IV, and called measurement categories.

CAT II	Primary electrical circuits in equipment connected to an AC electrical outlet by a power cord (portable tools, household appliances, etc.) CAT II covers directly measuring electrical outlet receptacles.
CAT III	Primary electrical circuits of heavy equipment (fixed installations) connected directly to the distribution panel, and feeders from the distribution panel to outlets.
CAT IV	The circuit from the service drop to the service entrance, and to the power meter and primary overcurrent protection device (distribution panel).

Using a measurement product in an environment designated with a higher-numbered category than that for which the product is rated could result in a severe accident, and must be carefully avoided.

Use of a measurement instrument that is not CAT-rated in CAT II to CAT IV measurement applications could result in a severe accident, and must be carefully avoided.

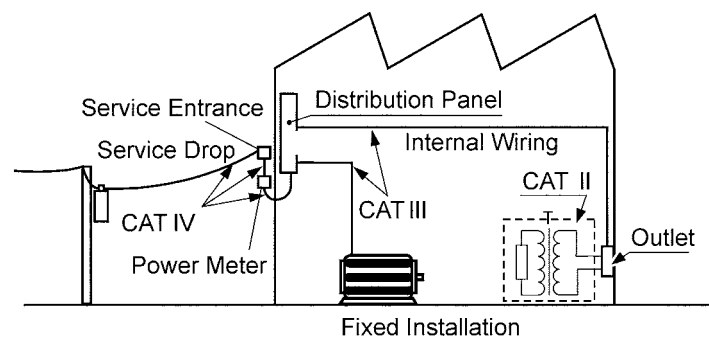

Accuracy

The specifications in this manual include figures for "measurement accuracy" when referring to digital measuring instruments, and for "measurement tolerance" when referring to analog instruments.

-
- f.s. (maximum display or scale value, or length of scale)
Signifies the maximum display (scale) value or the length of the scale (in cases where the scale consists of unequal increments or where the maximum value cannot be defined).
In general, this is the range value (the value written on the range selector or equivalent) currently in use.
 - rdg. (displayed or indicated value)
This signifies the value actually being measured, i.e., the value that is currently indicated or displayed by the measuring instrument.
 - dgt. (resolution)
Signifies the smallest display unit on a digital measuring instrument, i.e., the value displayed when the last digit on the digital display is "1".
-

Notes on Use



Follow these precautions to ensure safe operation and to obtain the full benefits of the various functions.



- **To avoid electric shock, do not remove the product's case. The internal components of the product carry high voltages and may become very hot during operation.**
- **The vinyl shield on the 9615 H.V. TEST LEAD alligator clip is not high voltage insulated. Do not touch when high voltage is applied.**



- **To avoid electric shock, do not allow the product to get wet, and do not use it when your hands are wet.**
- **To avoid electric shock, be sure to connect the protective ground terminal to a grounded conductor.**
- **To avoid electrical accidents and to maintain the safety specifications of this instrument, connect the power cord provided only to a 3-contact (two-conductor + ground) outlet.**
- **Before turning the product on, make sure the source voltage matches that indicated on the product's power connector. Connection to an improper supply voltage may damage the product and present an electrical hazard.**
- **Replace the fuse only with one of the specified characteristics and voltage and current ratings. Using a non-specified fuse or shorting the fuse holder may cause a life-threatening hazard.**
Fuse type: 250VT10AL (100-120 V), 250VT5AL (200-240 V)
- **To avoid electric shock when measuring live lines, wear appropriate protective gear, such as insulated rubber gloves, boots and a safety helmet.**



- To avoid electrocution, turn off the power to all devices before plugging or unplugging any of the interface connectors.
- To avoid damaging the power cord, grasp the plug, not the cord, when unplugging the cord from the power outlet.
- To avoid damaging H.V. TEST LEAD, do not kink or pull on the leads.
- For safety reasons, when taking measurements, only use the 9615 H.V. TEST LEAD provided with the product.
- To avoid damage to the product, protect it from vibration or shock during transport and handling, and be especially careful to avoid dropping.
- Failure to observe the following precaution may result in bodily injury.
 - This instrument weighs approximately 18kg. When lifting or moving the unit, it is strongly recommended that two capable persons hold the instrument at both ends of the bottom to prevent drop or damage.
 - The instrument is heavy. When transporting it, follow your company's workplace safety standards to assure safety (for example, by wearing non-slip gloves and protective footwear).
- To avoid electric shock, do not exceed the lower of the ratings shown on the instrument and test leads.



- Do not use the product near a device that generates a strong electromagnetic field or electrostatic charge, as these may cause erroneous measurements.
- This product may cause interference if used in residential areas. Such use must be avoided unless the user takes special measures to reduce electromagnetic emissions to prevent interference to the reception of radio and television broadcasts.

Chapter Summary

Chapter 1 Overview

Describes an overview, features, and the names and functions of the parts of the product.

Chapter 2 Testing Arrangements

Describes particulars of testing arrangements.

Chapter 3 Withstand Voltage Mode Testing Method

Describes the procedures for setting the withstand-voltage mode testing, testing method, and test decisions.

Chapter 4 Insulation Resistance Mode Testing Method

Describes the procedures for setting the insulation-resistance mode testing, testing method, and test decisions.

Chapter 5 Auto Test Mode Testing Method

Describes the procedures for setting the auto test mode testing, testing method, and test decisions.

Chapter 6 Program Mode Testing Method

Describes the procedures for setting the program mode testing, testing method, and test decisions.

Chapter 7 Optional Functions

Describes procedures for setting optional functions.

Chapter 8 Saving/Loading Preset Values

Describes procedure for saving and loading test values.

Chapter 9 External Interface

Describes use of the external I/O, and buzzer.

Chapter 10 PC Interface

Describes communication procedures and commands for an RS-232C/GP-IB interface.

Chapter 11 Specifications

Contains the unit specifications such as the general specifications, measurement accuracy, etc. of the unit.

Chapter 12 Maintenance and Inspection

Covers the maintenance and inspection, fuse replacement, ultimate disposal, and system reset.

Appendix

Covers the options of the unit.

Chapter 1

Overview

1.1 Product Introduction

(1) Easy testing conforming to standards

With the unit insulation-resistance and withstand-voltage tests based on a wide variety of standards can be performed. Accurate test results can be obtained by comparative screening functions that use upper- and lower-limit values, timer functions, and ramp up/down timer functions that control test-voltage increases/decreases.

(2) Automatic insulation-resistance testing and withstand-voltage testing

The Continuous Test mode allows consecutive insulation-resistance and withstand-voltage tests to be performed.

(3) Fluorescent indicator

The large, easy-to-read fluorescent display permits quick checking of the testing state and result.

(4) Analog Voltage Measurement

The voltage is digitally displayed on the fluorescent indicator. This value can also be checked on the analog voltmeter.

(5) Saving testing set values (Memory function)

This unit is provided with a function for saving the set values used in a test, allowing quick switching between different testing set values to meet a variety of standards and regulations. Up to 10 values may be saved for each test mode (withstand-voltage mode or insulation-resistance mode). The values immediately prior to a power shutdown are saved in the unit, and the unit restarts with these settings the next time.

(6) REMOTE CONTROL BOX

The 9613 REMOTE CONTROL BOX (single-hand) or the 9614 REMOTE CONTROL BOX (dual-hand) can be connected to the external switch terminal to perform 3153 start/stop control.

(7) External I/O

The external I/O terminal generates signals according to the state of the 3153. It can be used to feed signals for the **START** and **STOP** key.

(8) RS-232C/GP-IB interface as a standard feature

Automatic testing and saving of the test results are possible with the use of a computer.

(9) Program test

Withstand-voltage and insulation-resistance tests under various conditions can be conducted successively at your option. Through the use of a 3930 HIGH VOLTAGE SCANNER, many test points can be tested at one time. Up to 32 files can be created, with each file containing up to 50 steps.

(10) Switching-power-supply method

The adoption of the PWM switching power supply allows the unit to output any preset voltage. The test voltage is not affected by fluctuations in the power-supply voltage of this unit.

1.2 Names and Functions of Parts

1.2.1 Front panel



To prevent electric shock, when the **DANGER** lamp is lit, never touch the **HIGH** or **LOW** terminals, **H.V. TEST LEAD**, or the tested object.

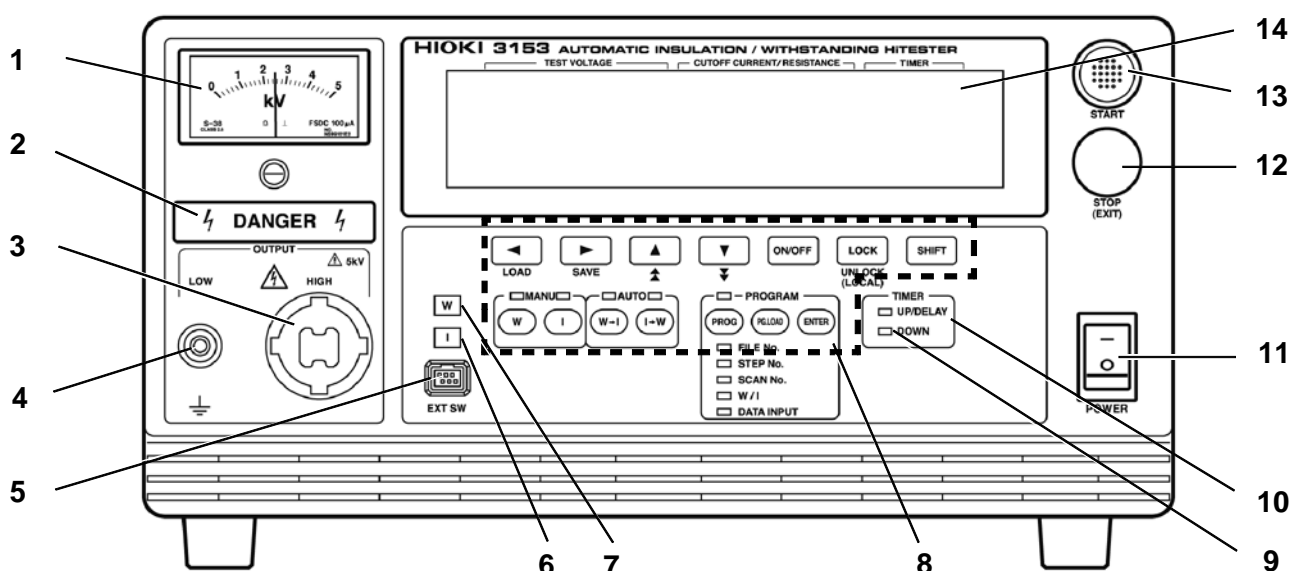

1	Analog voltmeter	Indicates output-voltage value.
2	DANGER lamp	This lamp lights to warn that voltage is present between the terminals during testing.
3	HIGH terminal	The HIGH terminal is a high-voltage terminal for voltage outputs.
4	LOW terminal	The LOW terminal is a low-voltage terminal for voltage outputs. It has the same electric potential as the unit body.
5	External switch terminal	Used for the switch signal line plug for the REMOTE CONTROL BOX.
6	I lamp	This lamp lights when insulation-resistance mode is selected and during insulation-resistance testing.
7	W lamp	This lamp lights when withstand-voltage mode is selected and during withstand-voltage testing.
8	Rubber keys	The 14 rubber keys include 13 function keys and a SHIFT key. The six function keys offer a variety of settings, used in combination with the SHIFT key.
9	DOWN lamp	This lamp lights during ramp-down from withstand-voltage testing.
10	UP/DELAY lamp	This lamp lights during ramp-up to withstand-voltage testing and during insulation-resistance testing delays. (However, it does not light during time testing when insulation-resistance test termination mode is set to 0 [initial setting].)
11	Main power switch	Powers the 3153 product on or off.
12	STOP key	Normally used to terminate a test.
13	START key	Used to start a test. This key functions only when the READY lamp is lit.
14	VFD (vacuum fluorescent display)	Displays various information, such as the test state and test results.

1.2.2 Rubber keys

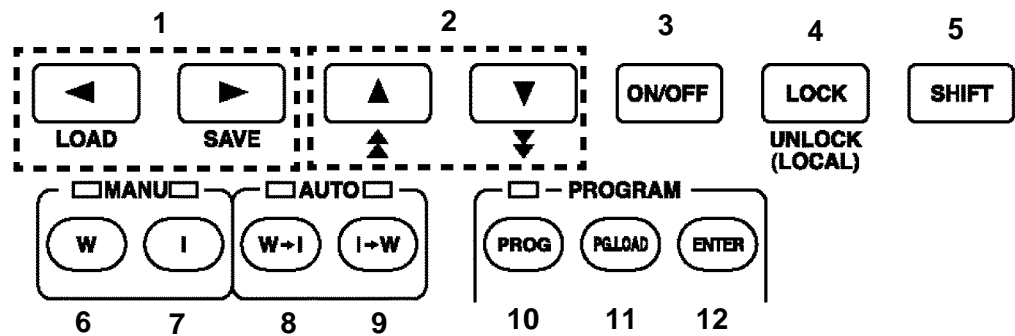

1	◀/▶ key	Moves the flashing cursor. The switching range is preset before shipment: Withstand-voltage test: Test-voltage value Upper-limit value Lower-limit value Test time Ramp-up time Ramp-down time Test-voltage type Insulation-resistance test: Test-voltage value Lower-limit value Upper-limit value Test time Delay time To display the flashing cursor, press the ◀/▶ keys. The cursor appears, displaying the preset comparative voltage value or test-voltage value. (withstand-voltage test and insulation-resistance test)
2	▼/▲ key	Changes the position at which the flashing cursor appears.
3	ON/OFF key	Switches on/off the set value for the position of the flashing cursor. If turned off, the set value is not used in testing. However, the following key can't perform the switching on/off: Withstand-voltage test: Test-voltage type, Test voltage, Upper-limit value Insulation-resistance test: Test voltage, Lower-limit value
4	LOCK key (LOCAL key)	Used to lock the keys. When pressed, the LOCK key disables all keys except the START key, STOP key, and Key Lock Cancel key (LOCK + SHIFT key). See the "Key-lock Function" section. (Chapter 3 to 6) In the remote state, this key functions as a LOCAL key. It cancels the remote state.
5	SHIFT key	Used in combination with other keys. SHIFT + ◀ key Displaying the Preset-data loading screen. (See Chapter 8) SHIFT + ▶ key Displaying the Preset-data saving screen. (See Chapter 8) SHIFT + UNLOCK key Disabling the key lock function. Cancels the key lock. When GP-IB is used for communication, go to LOCAL state. SHIFT + ▼/▲ key Changing the increment size of setting values.
6	W key (withstand-voltage test)	Performs withstand-voltage tests and settings. (See Chapter 3)
7	I key (insulation-resistance test)	Performs insulation-resistance tests and settings. (See Chapter 4)
8	W I key	Tests for withstand-voltage, then insulation-resistance. (See Chapter 5)
9	I W key	Tests for insulation-resistance, then withstand-voltage. (See Chapter 5)
10	PROG key	Creates or edits program tests or their files. (See Chapter 6)
11	PG.LOAD key	Used to load program data. (See Chapter 6)
12	ENTER key	Used to create or edit program test files. (See Chapter 6)

1.2.3 Rear panel



To prevent electric shock, when the DANGER lamp is lit, never touch the HIGH or LOW terminals, H.V. TEST LEAD, or the tested object.

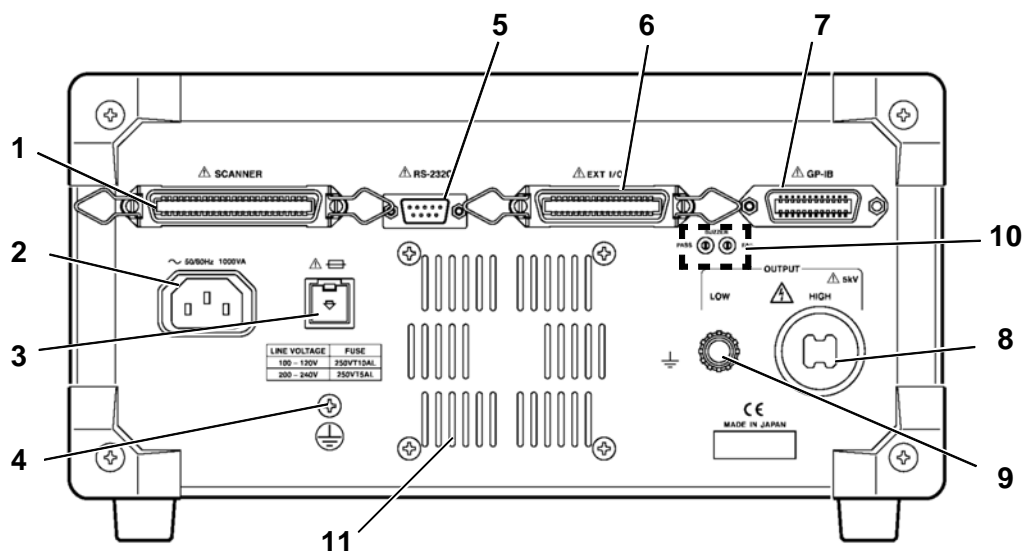

1	Scanner connection terminal	Terminal for connecting the optional 3930 HIGH VOLTAGE SCANNER. Do not connect any scanner other than the 3930.
2	Power inlet	Connect the grounded three-core power cord supplied here.
3	Fuse holder	Contains a power fuse.
4	Protective ground terminal	Used to earth a protective ground wire. Be sure to make grounding connections before starting a test.
5	RS-232C terminal	Used for remote control with RS-232C.
6	External I/O terminal	For output of 3153 state and input of start and stop signals.
7	GP-IB terminal	Used for remote control with GP-IB.
8	HIGH terminal	A high-voltage terminal for voltage output. Connected to the HIGH terminal on the front panel.
9	LOW terminal	A low-voltage terminal for voltage output. Contains the same electrical potential as this units casing.
10	Buzzer adjustment knob	Used for buzzer sound adjustment. Two knobs are provided: one for PASS screening and one for FAIL screening.
11	Vent holes	Holes for cooling the inside of the unit. Both sides of the unit also have vent holes.

1.2.4 9615 H.V. TEST LEAD



The vinyl shield on the 9615 H.V. TEST LEAD alligator clip is not high voltage insulated. Do not touch when high voltage is applied.

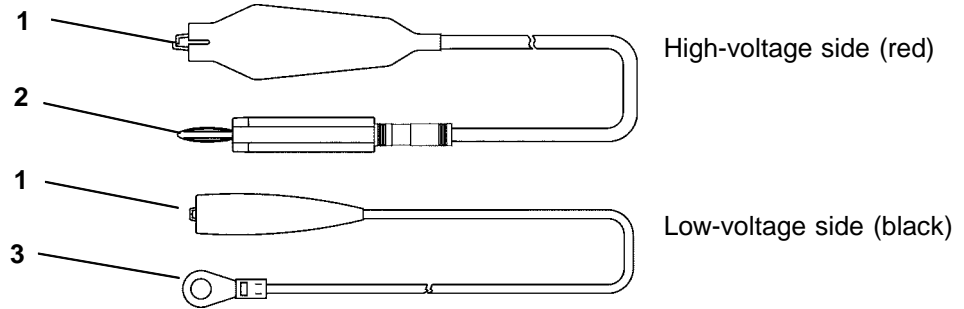

1	Alligator clip	Connect to a test point on the tested object.
2	High-voltage output plug	Connect to the HIGH terminal on the unit.
3	Low-voltage output plug	Connect to the LOW terminal on the unit.

1.2.5 REMOTE CONTROL BOX

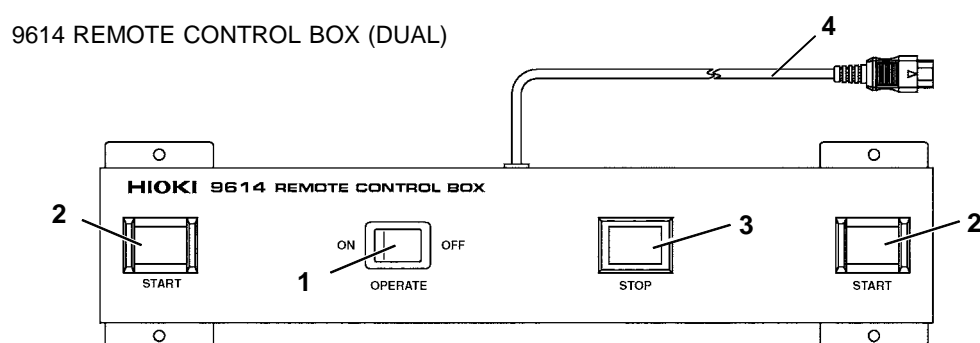
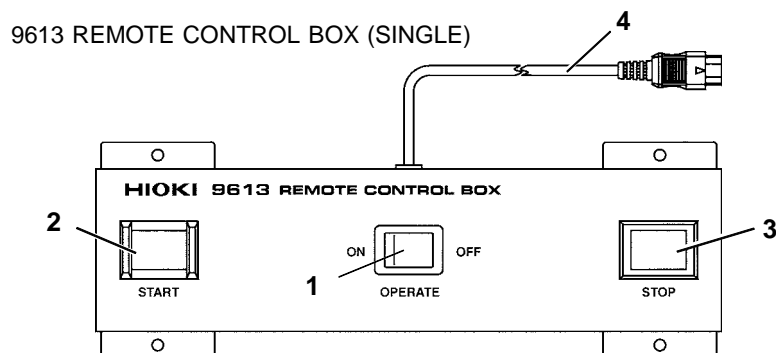

1 OPERATE switch	Used to enable remote-control operation. When this switch is ON, the START and STOP keys for remote control are active.
2 START key	Works in the same manner as the START key on the unit. With the 9614 REMOTE CONTROL BOX (dual-hand), the two START switches must be pressed.
3 STOP key	Works in the same manner as the STOP key on the unit. The STOP key is ON during a test or when a voltage is being output.
4 Switch signal-line plug	Connect to the external switch terminal on the unit.

1.3 External Dimensions

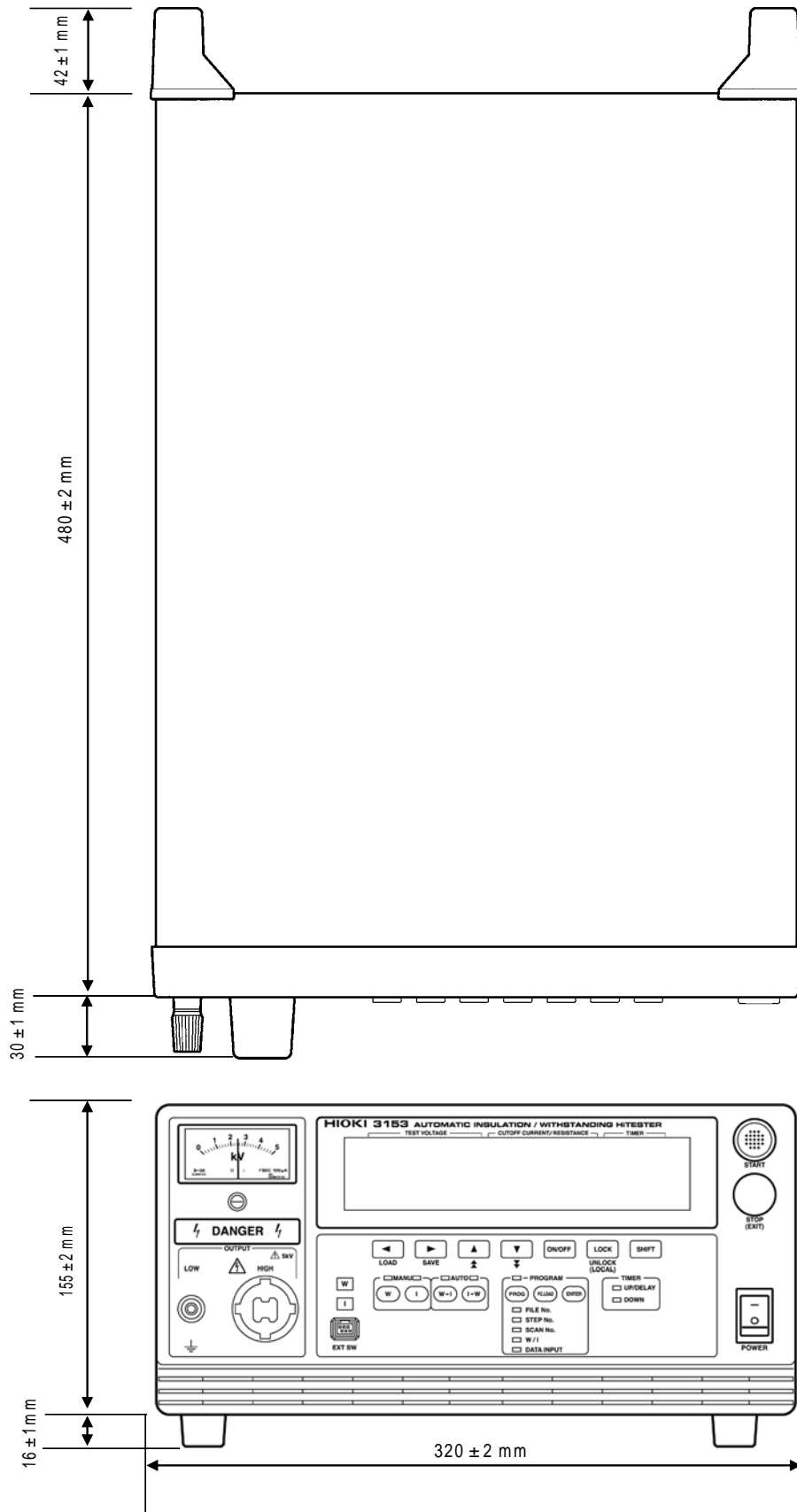

Chapter 2

Testing Arrangements

2

2.1 Connecting the Protective Ground Terminal



- To avoid electric shock, be sure to connect the protective ground terminal to a grounded conductor.
- To avoid electric shock, connect the protective ground terminal to a grounded conductor before making any other connections.

1. Using a Phillips-head screwdriver, remove the protective ground terminal from the rear of the unit.
2. Connect an electric wire with a sufficient current capacity to the protective ground terminal, and secure the wire using a Phillips-head screwdriver.
3. Ground the other end of the wire.

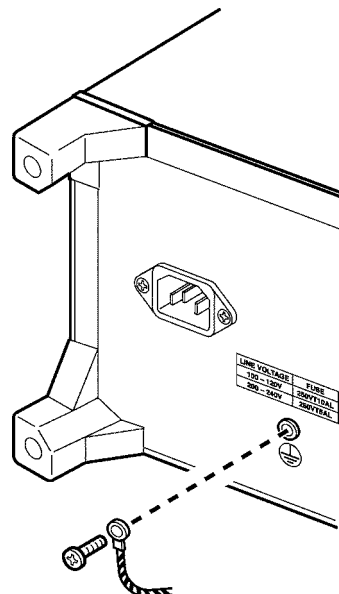
**NOTE**

If the ground-type double-pole power cord that is supplied with the unit is used, the unit is automatically grounded.

2.2 Wearing rubber gloves



To avoid any life-threatening electric shock accidents, ensure that the following rules are observed.

- The AC Withstanding HiTester is a dangerous product which discharges high voltages. To prevent getting electrocuted, always wear high-voltage protective rubber gloves when carrying out any operation.
- Be careful when using the product and ensure that you do not touch this product, any tested object that is connected or any H.V. Test Lead, etc.

1. To avoid electrocution, always wear high-voltage protective rubber gloves when using this product.
2. Contact your dealer or Hioki representative to help you look for high-voltage protective rubber gloves.

2.3 Connecting the External I/O Connector

Connect the external I/O connector before turning on the power. If the external I/O connector is installed or removed following startup, malfunction may result.

1. Insert the external I/O connector into the external I/O terminal.
2. Secure the external I/O connector using the hooks of the external I/O terminal.

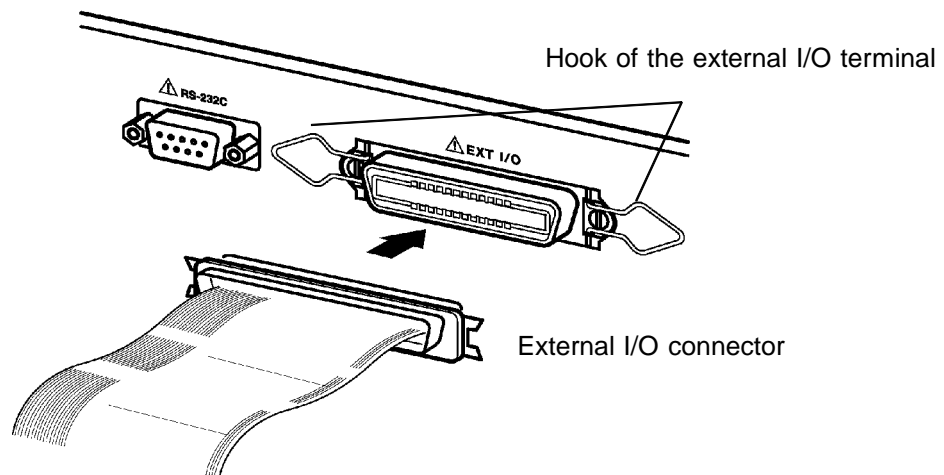

- For the specifications of the external I/O connector, see Section 9.1.
- If the optional "Interlock" function is set to "1: Set," set Pin 10 of the external I/O terminal to "LOW level" before starting a test. "Err 000" will be indicated until "LOW level" is set. (See Section 9.1.4)

2.4 Power Cord Connection



- Before turning the product on, make sure the source voltage matches that indicated on the product's power connector. Connection to an improper supply voltage may damage the product and present an electrical hazard.
- To avoid electrical accidents and to maintain the safety specifications of this instrument, connect the power cord provided only to a 3-contact (two-conductor + ground) outlet.

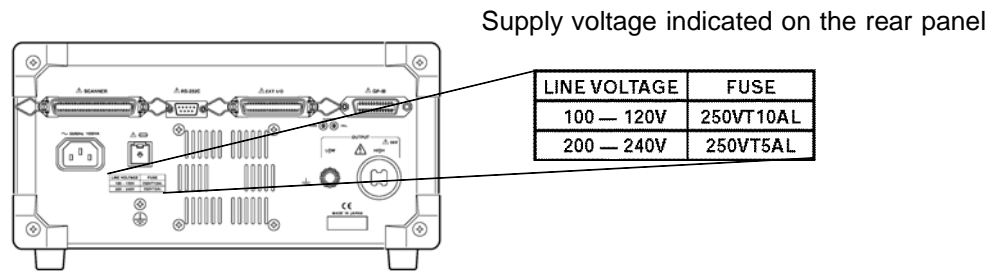

1. Be sure that the main power switch is turned to OFF.
2. Connect the grounded three-core power cord provided to the power inlet on the back of the unit.
3. Insert the plug into the grounded outlet.

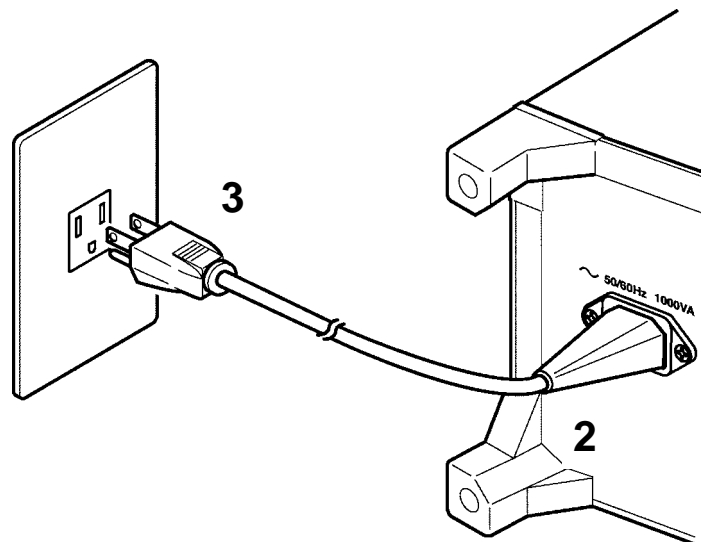

2.5 Powering On and Off the Unit



Before turning on the power, make sure that the voltage of the power supply being used matches the supply voltage indicated on the rear panel of the unit. If an attempt is made to use an improper supply voltage, there is danger of damage to this unit and of life-threatening risk to the operator. Apply a voltage within the acceptable power-voltage range. Otherwise, damage to the unit or electrical accidents may result.



- The settings immediately prior to power shutdown are saved. The unit restarts with these settings, even following a power interruption. When settings are modified, however they are only saved after running a test.
- Allow 10 minutes warming up after powering on.
- The REMOTE CONTROL BOX, external I/O device, RS-232C interface, and GP-IB interface are active only when they are connected prior to startup. If these devices are connected after the power is turned on, the protective function may be activated, thus causing a malfunction.
- A filter circuit is provided in the first stage of the power supply. Therefore, power (apparent power) is consumed even when the main power switch is turned OFF, provided that the unit is connected to an outlet.

50 Hz	$(\text{Effective voltage})^2 \times 1.4 \times 10^{-3} \text{ (VA)}$
60 Hz	$(\text{Effective voltage})^2 \times 1.7 \times 10^{-3} \text{ (VA)}$

(1) Powering on the unit

1. Turn the main power switch to ON (**1**).

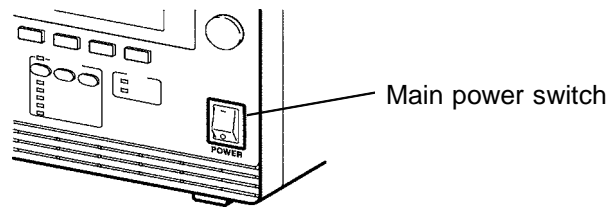

2. The model name and version number are displayed as below:

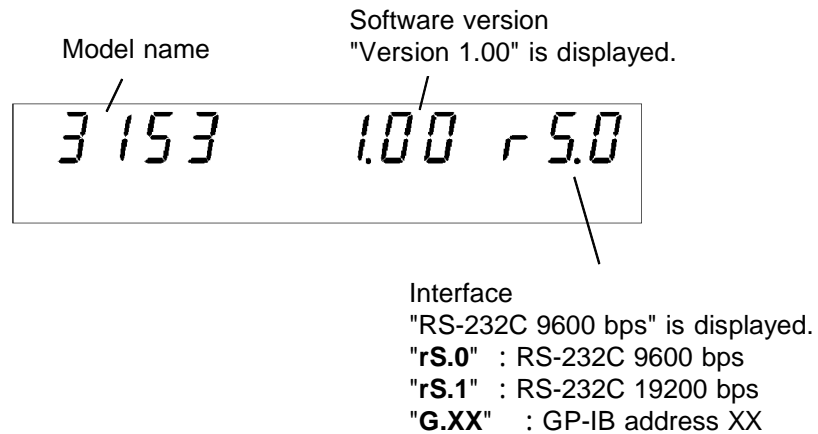

3. When the **READY** lamp is lit (it does not light up in the Double Action mode), the keys are ready for operation. (See Section 7.5)

(2) Powering off the unit

1. Following a test, make sure the analog voltmeter is at 0 kV, the **DANGER** lamp is OFF, and the **READY** lamp is lit.
2. Turn OFF the Main Power switch.

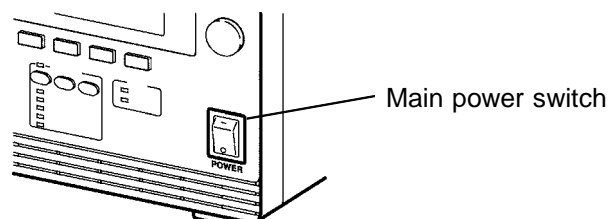

2.6 Connecting the 9615 H.V. TEST LEAD



- To prevent electrical shock, turn off the power unit, make sure that there is no high voltage being applied to the output, confirm the following 3 items, and connect the 9615 H.V. TEST LEAD.
 - (1) The analog voltmeter reads 0 kV.
 - (2) The DANGER lamp is OFF.
 - (3) The **READY** lamp is lit (it is off in the Double Action mode).
- Before connecting the 9615 H.V. TEST LEAD, be sure to check its insulation for tearing and metal exposure. Using the product in such conditions could cause an electric shock, so contact your dealer or Hioki representative for repair.
- To avoid electric shock, make sure the 9615 H.V. TEST LEAD is securely connected before starting a test, as a loose test lead can cause a hazard when a voltage is output.

1. Remove the LOW terminal by turning it counterclockwise.

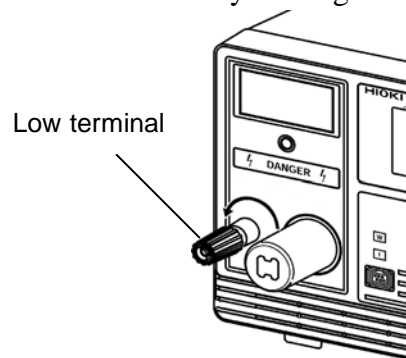

2. As shown in the figure, insert the plug on the H.V. TEST LEAD (low voltage side).

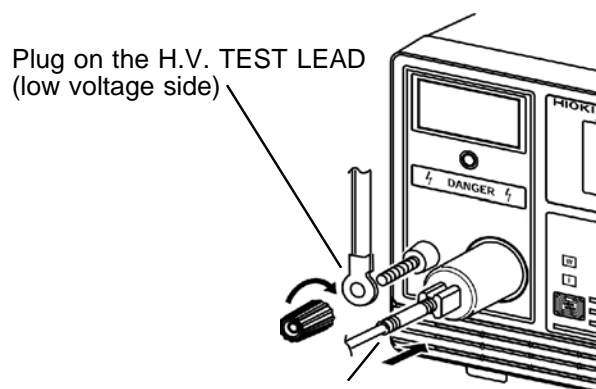

Plug on the H.V. TEST LEAD (high voltage side)

3. Secure the LOW terminal by turning it clockwise.
4. Connect the plug on the H.V. TEST LEAD (high voltage side) to the HIGH terminal.

2.7 Connecting the REMOTE CONTROL BOX



- To prevent electrical shock, turn off the power unit, make sure that there is no high voltage being applied to the output, confirm the following 3 items, and connect the 9615 H.V. TEST LEAD.
 - (1) The analog voltmeter reads 0 kV.
 - (2) The DANGER lamp is OFF.
 - (3) The **READY** lamp is lit (it is off in the Double Action mode).
- To prevent malfunctions, do not remove the REMOTE CONTROL BOX following startup. Before removing it, be sure to turn OFF the power.
- To avoid electric shock, when using the REMOTE CONTROL BOX, provide safety measures to keep the output-voltage terminal, tested object, and H.V. TEST LEAD out of contact with one another when they are in the TEST state.

Connection of the REMOTE CONTROL BOX (9613/9614) enables start/stop operations to be performed easily.

1. Make sure the Main Power switch and OPERATE switch on the REMOTE CONTROL BOX are OFF.

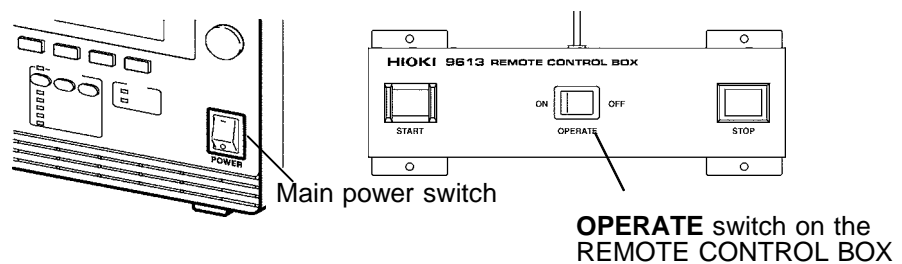

2. Insert the switch signal-line plug into the external switch terminal. Check the direction of the switch signal line.
3. Turn ON the **OPERATE** switch of the REMOTE CONTROL BOX. The **OPERATE** switch can be turned ON/OFF even following startup.

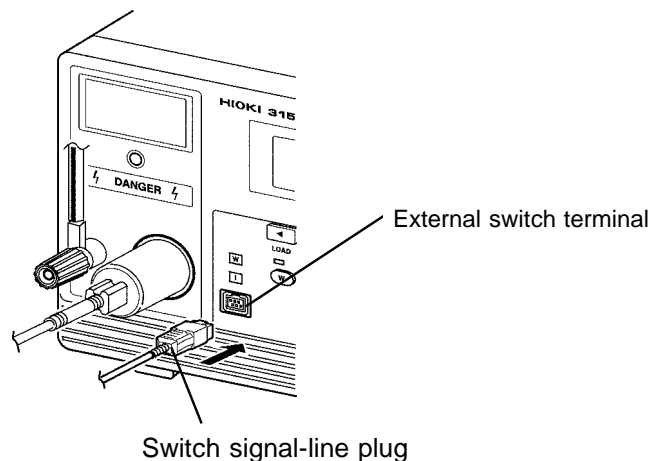

2.8 Installation of the Unit

Temperature: 0 to 40

Humidity: 80% RH or less (no condensation)

Avoid the following locations:

- Subject to direct sunlight.
- Subject to high levels of dust, steam, or corrosive gases (Avoid using the equipment in an environment containing corrosive gases (e.g., H₂S, SO₂, NI₂, and Cl₂) or substances that generate harmful gasses (e.g., organic silicones, cyanides, and formalins)).
- Subject to vibrations.
- In the vicinity of equipment generating strong electromagnetic fields.

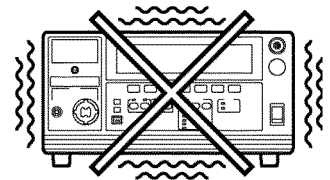
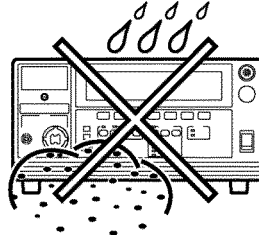
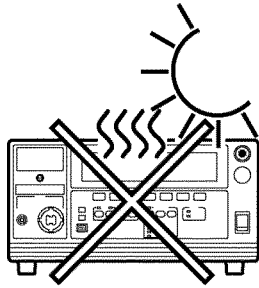

NOTE

- The noise generated by this unit may affect equipment located around the unit.
- Install the unit in such a way that the vent holes on both sides and at the rear of the unit are not blocked, so that the unit can function normally.

2.9 Connection to the Measured Equipment



Observe the following precautions to avoid electric shock.

- Make sure that no high voltage is being applied to the output, confirm the following items, and connect the H.V. TEST LEAD.
 - (1) The analog voltmeter reads 0 kV.
 - (2) The DANGER lamp is OFF.
 - (3) The READY lamp is lit (it is off in the Double Action mode).
- In the TEST state, never touch the output-voltage terminal, H.V. TEST LEAD, or tested object.
- Even following a test, there may be a residual voltage at the output terminal. Therefore, before touching the output-voltage terminal, H.V. TEST LEAD, or tested object, make sure that no high voltage is being applied between the output terminals.

1. Make sure the analog voltmeter is at 0 kV and the DANGER lamp is OFF.
2. Make sure the unit is in the READY state with the READY lamp ON (it is OFF in the Double Action mode).
3. Connect the LOW terminal probe to the tested object. Fasten the probe securely to prevent it from loosening during a test.
4. Following the procedure described above, connect the HIGH terminal probe to the tested object.



- Note that taking measurements or routing cables in a humid location may cause errors in insulation-resistance tests.
If the HIGH and LOW voltage output terminals short-circuit or a dielectric breakdown occurs in the tested object during the test, noise will be generated and such noise may lead to a malfunction of this unit or of a nearby electronic device. If this problem occurs, connect a ferrite core or a resistor to the H. V. TEST LEAD (high voltage side).
When using a resistor, choose one appropriate for the power rating and withstand voltage. Also, be alert to any drop in test voltage.
Beware of electric shock when connecting the resistor.
- Do not the test lead and the EXT/IO cable arranged closely to each other. Doing so may lead to a malfunction of the external control due to a noise. Additionally, if the test lead touches to other metallic parts, it may cause an increase in leakage current.
Prevent the test lead from coming into contact with other parts as much as possible.

2.10 Startup Inspection

To ensure safe testing, check the following before starting operation:

(1) Breaking current (withstand-voltage mode)

1. Prepare a resistor with a resistance smaller than that of the calculation result from the output voltage and test upper-limit value (breaking current) that are preset in the withstand-voltage test.

(Output voltage ÷ Upper-limit value (Breaking current) = Resistance)

A high-voltage resistor with a power rating larger than the power calculated from the output voltage and resistance is recommended.

$((\text{Output voltage})^2 \div \text{Resistance} < \text{Power rating})$

Example high-voltage resistor:

KOA Corp.'s GS Series High Voltage High Resistance Thick Film Resistor

2. Set an upper-limit value.
3. Connect the resistor to the H.V. TEST LEAD.
4. Start the test. Confirm that the current is cut off when the preset voltage is output. (i.e., make sure the unit is in the FAIL state).

(2) Measured resistance (insulation-resistance mode)

1. Calculate the resistance based on the test voltage set for insulation-resistance testing and the measured current (1 mA), and prepare a resistor whose resistance is larger than that of the calculation result.
(output-voltage ÷ measured current (1 mA) = resistance value)
2. Specify the test voltage.
3. Connect the resistor that you prepared to the H.V. TEST LEAD.
4. Make sure that the resistance measured matches the resistor that you prepared.

(3) Analog voltmeter

1. Before turning on the power, make sure the analog voltmeter is at 0 kV.
2. If the voltage reading is not at zero, adjust the value to zero using a slotted screwdriver.

(4) Interlock

If the Interlock function is set, make sure the Interlock function works properly before starting operation. (See Section 9.1.4)

(5) Key inspection

1. Turn off the power, and unplug the power cord from the power outlet.
2. For both the START and STOP keys on the front panel of the unit, press the center of the key, and make sure you feel it click. The click is less noticeable when the edges of the keys are pressed.

* Clicking

When a key is pressed slowly, there is a moment of slight resistance and a feeling that the key cannot be pressed any further. When the key is pressed further after this point, a clicking sensation can be felt.

3. If you do not feel a click, the key may be broken.

Chapter 3

Withstand Voltage Mode Testing Method

3

This chapter describes how to set withstand-voltage mode test conditions and the proper testing procedure.

Read chapter 2, and make the necessary preparations for testing.

Press the **W** key to enter withstand-voltage mode.
(The W lamp above the key to the left lights.)

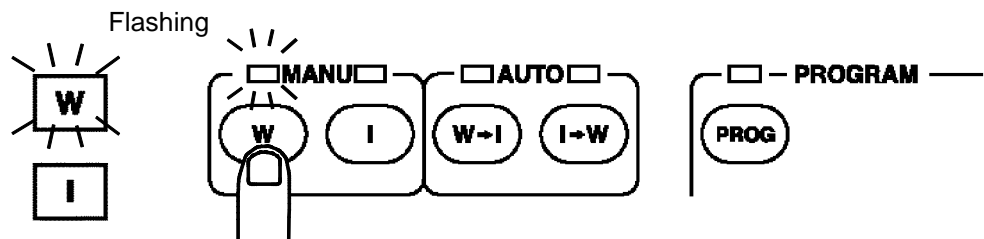

NOTE

Note that the output waveform may be distorted when conducting an AC withstand voltage test for a voltage-dependent device or object (e.g., ceramic capacitor). Excessively large distortion may damage the device or tested object.

3.1 Withstand Voltage Mode Display

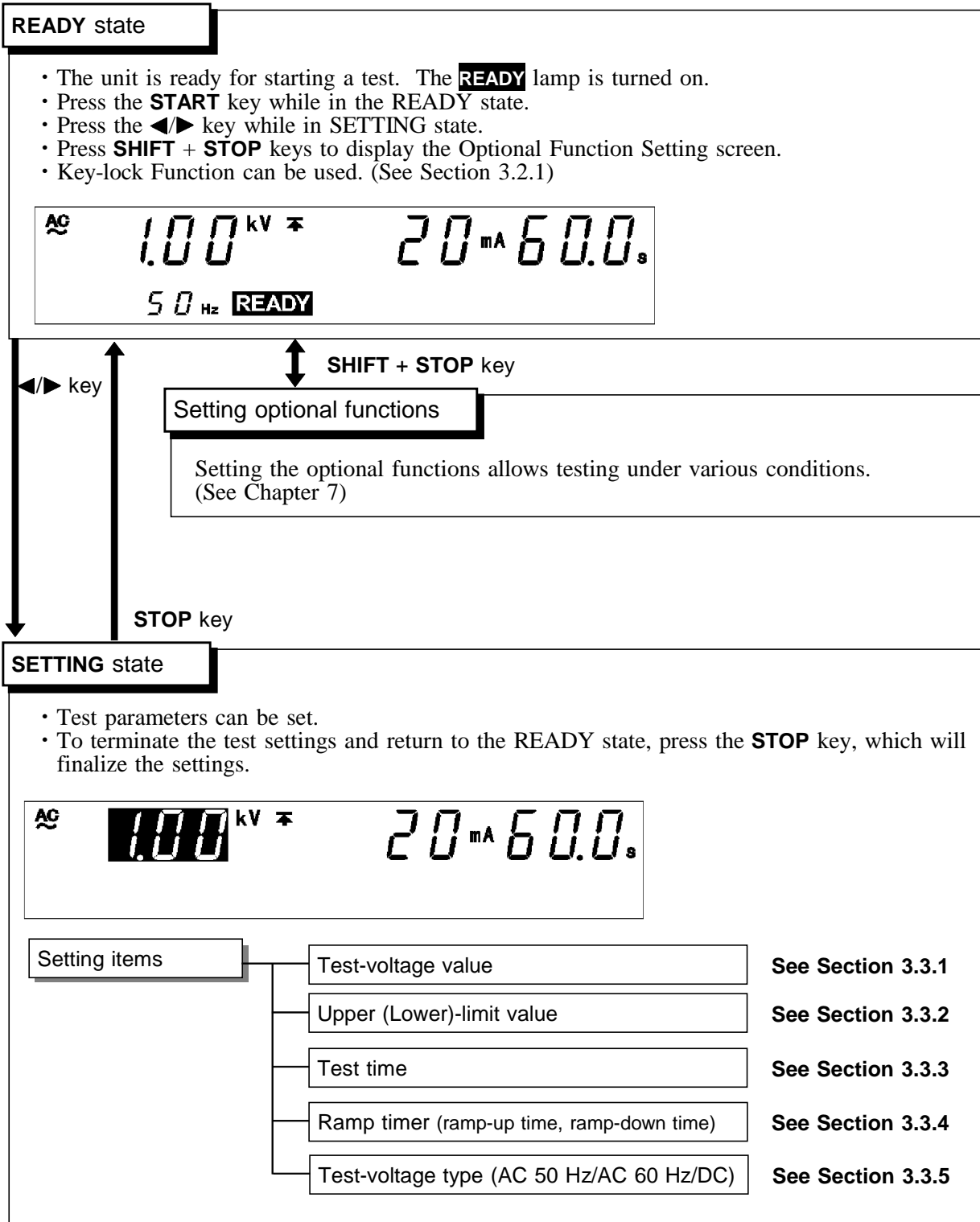

START key

TEST state

See Section 3.4.2

- When the unit is in the TEST state, the **TEST** lamp is lit. This indicates that a test is in progress.
- The measured-current value is compared with the upper- and lower-limit values. If the measured-current value deviates from these values, the unit shifts to the FAIL state and the test is terminated. When the preset test time has elapsed, if there have been no deviations, the unit shifts to the PASS state.
- Press the **STOP** key to forcibly terminate the test.



Key operation in the TEST status

Forced ending

Press the **STOP** key.**PASS state**

See Section 3.5.1

- **PASS** indicates that the measured object passed the test set in the READY state.
- The **PASS** lamp is turned on. The PASS state screen is displayed for about 0.3 second before switching to the READY state.
- The PASS state can be maintained if the PASS Hold function is disabled in the optional settings. (See Section 7.1)

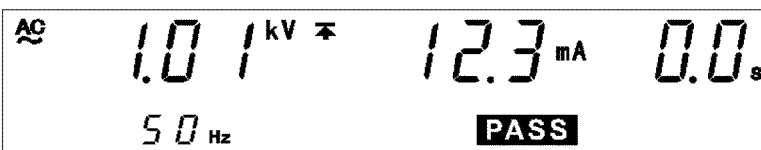
**FAIL state**

See Section 3.5.3

- **FAIL** indicates that the tested object failed to pass the test set in the READY state.
- The **FAIL** lamp will light up, accompanied by **UPPER** if the measured value exceeds the upper-limit value, or by **LOWER** if the measured value is below the lower-limit value.
- The FAIL state can be maintained. To return to the READY state, press the **STOP** key, which will cancel the FAIL Hold function.
- FAIL Hold function can be disabled in the optional settings. The FAIL-state screen is displayed for 0.3 seconds, and the unit then switches to the READY state. (See Section 7.2)

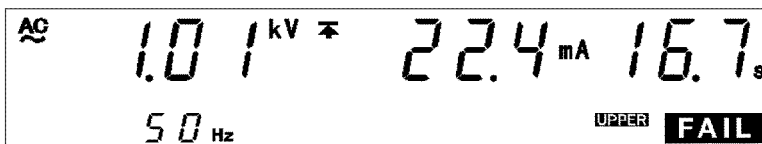

3.2 Displaying the "READY" State

In the READY state, the unit is always ready to start a test. The **READY** lamp remains lit to indicate the READY state.

Saving and loading for setting data and the setting of optional functions are made following the READY state.

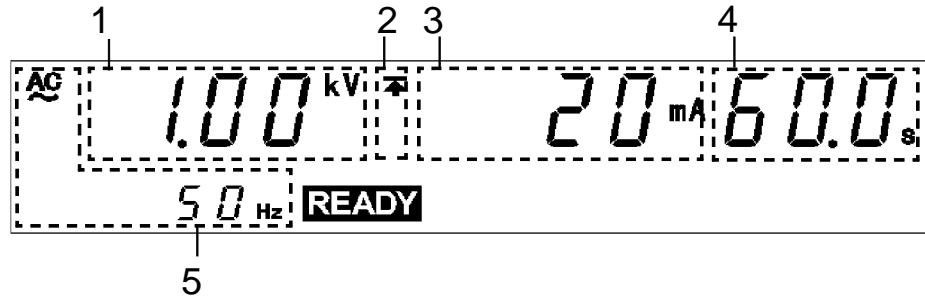

1	Test-voltage value	Indicates the voltage value being output.
2	Upper-limit value icon and Lower-limit value icon	The symbol \blacktriangle appears when the upper-limit value is set, and the symbol \blacktriangledown appears when the lower-limit value is set.
3	Upper-limit value	Indicates Upper-limit value.
4	Test time	Indicates the preset test time. "OFF" is indicated when no test-time setting has been made.
5	Test-voltage type	Indicates the test type (AC 50 Hz, AC 60 Hz or DC.)

Danger lamp

Indicates that a voltage is being output. This lamp remains lit as long as a voltage is being applied to the output terminal. It does not light up in the READY state.

External I/O

The READY signal is ON when **READY** is lit on the fluorescent indicator. The READY signal is turned OFF when **READY** is not lit.

Analog voltmeter

Indicates the voltage value being output. In the READY state, the value remains at 0 kV.

Key Operations

$\blacktriangleleft/\blacktriangleright$	Displays the SETTING state. (See Section 3.3)
SHIFT + \blacktriangleright	Displays the set data Save screen. (See Section 8.1)
SHIFT + \blacktriangleleft	Displays the set data Load screen. (See Section 8.2)
SHIFT + STOP	Displays the Optional functions setting screen. (See Chapter 7)
START	Test Start (See Section 3.4)
LOCK	Key-lock function (See Section 3.2.1)

3.2.1 Key-lock Function

It inactivates all keys except the **START** key, **STOP** key, and the range switch. The **KEYLOCK** lamp is lit while the key-lock function is active. Use this function when you do not want to change the test mode or test settings.

To switch to the KEY-LOCK state, press the **LOCK** key. The **KEYLOCK** lamp is lit.

To cancel the key-lock function, press the **LOCK** key in the Key-LOCK state while holding down the **SHIFT** key. The **KEYLOCK** lamp is not lit.

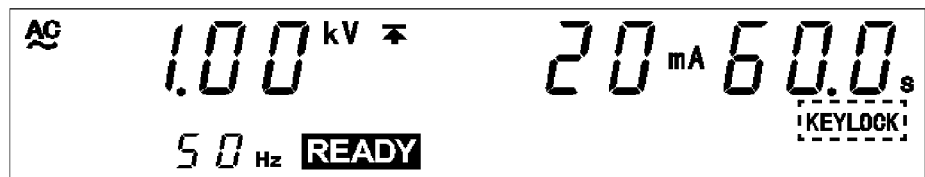

NOTE

Even when the key-lock function is activated, the **START** and **STOP** keys on the REMOTE CONTROL BOX and the start and stop signals on the external I/O terminal remain active.

3.3 "SETTING" State

To set or change test settings, switch to the SETTING state.



- In the SETTING state, the **READY** light goes out and tests cannot start.
- In the withstand-voltage mode READY state and "test setting state," although the test-voltage value is displayed, that voltage is not being output.

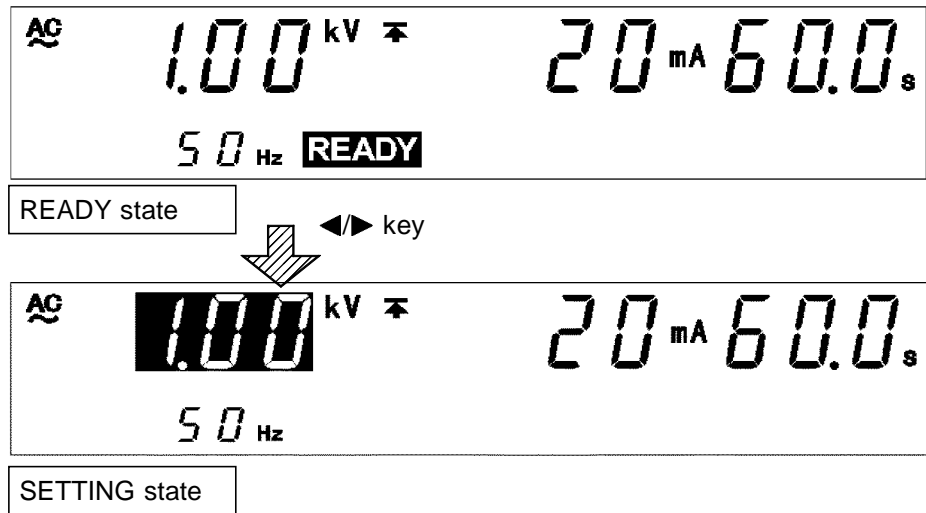

1. In the withstand-voltage mode READY state, when you press the keys, the flashing cursor appears where the test voltage is indicated to show that the unit is in the SETTING state. (The **READY** light goes out and tests cannot start even if the **START** key is pressed.)
2. Use the following operation keys to make settings:
 - key: Move the flashing cursor.
 - key: Change settings.
 - ON/OFF** keys: Activate and deactivate values.
 - The flashing cursor moves between the test-voltage value, upper-limit value, lower-limit value, test time, ramp-up time, ramp-down time and the test-voltage type.
 - If the value indicated by the flashing cursor is not needed in the test, turn it OFF using the **ON/OFF** keys. The upper-limit value, the test-voltage value and the test-voltage type however, cannot be turned OFF.
3. To finalize the test settings, press the **STOP** key. The settings are confirmed and the unit returns to the READY state.



- Note that the unit does not start test if the lower-limit value is greater than the upper-limit value. In this case, correct the settings and press the **STOP** key to confirm them.
- Note that the unit does not start test if the test-voltage value is greater than the output-voltage restricting value. See Section 7.9.

3.3.1 Setting the Test Voltage Value

Set a test-voltage value. The test will not start if the load current value is large and the output voltage does not reach $\pm 5\%$ of the set test voltage. (**TEST** flashes.) If the output voltage fails to reach the test voltage within approximately 5 seconds after completion of the ramp-up time, the unit will change to the FAIL state and the test will be terminated. Also, if the output voltage deviates from test voltage and does not return to ± 1 dgt. of the set value within 5 seconds, the test is terminated.

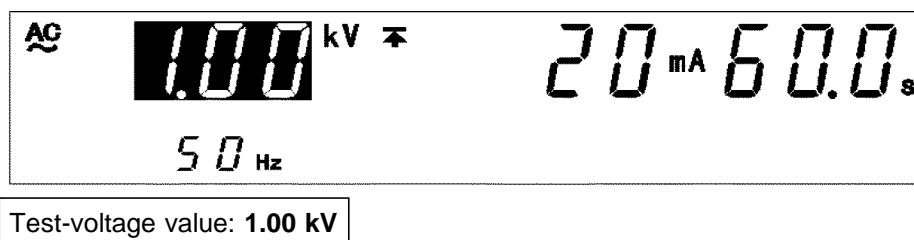

1. If no flashing cursor is displayed in the withstand-voltage mode READY state, press either the ◀/▶ key to display the cursor in the test-voltage value position.
2. Change the test-voltage value using the ▼/▲ keys. The value changes in 0.01 kV increments. To change the value by 0.10 kV, press **SHIFT + ▼/▲** keys. Settings may be made along a scale ranging from 0.20 to 5.00 kV.
3. To finalize the test settings, press the **STOP** key. The settings are confirmed and the unit returns to the READY state.

Optional Function

The output voltage can be restricted to prevent accidents caused by improper settings. (When the default is set to 5.00 kV.) (See Section 7.9)



Note that the unit does not start test if the test-voltage value is greater than the output-voltage restricting value. See Section 7.9.

3.3.2 Setting the Upper (Lower) Limit Value

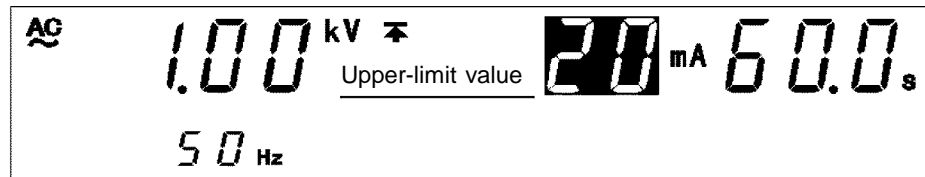

Upper (Lower) Limit Value: 20 mA

1. If no flashing cursor is displayed in the withstand-voltage mode READY state, press either the ◀/▶ key to display the cursor in the upper (lower)-limit value position.
2. Set the upper (lower)-limit value using the ▼/▲ keys.
The upper (lower)-limit value will change by 0.1 mA (by 1 mA at 10 mA to 100 mA). While holding down the **SHIFT** key, press the ▼/▲ keys. (by 10 mA at 10 mA to 100 mA).
The following is the setting range:
The upper-limit value can be set between 0.1 and 100 mA. The lower-limit value can be set between 0.1 and 10 mA. (DC withstand-voltage)
The lower-limit value can be set between 0.1 and 99 mA. The lower-limit value can be set between 0.1 and 9.9 mA. (DC withstand-voltage)
If no lower-limit value is required, turn off the **ON/OFF** key. Upper-limit value can not be turn off.
3. To finalize the test settings, press the **STOP** key. The settings are confirmed and the unit returns to the READY state.

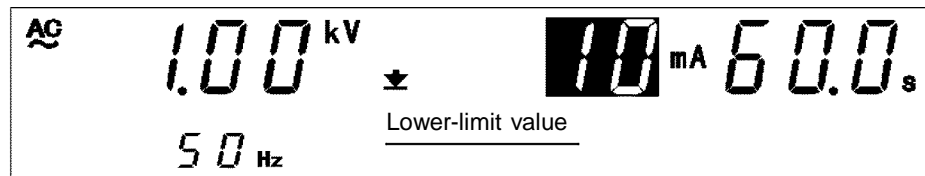

Lower-limit value: 1.0 mA

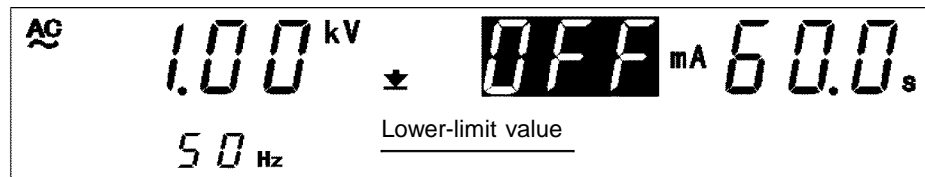

Lower-limit value: OFF

NOTE

- The setting resolution of the upper (lower)-limit value is 0.1 mA at 0.1 mA to 9.9 mA, and 1 mA at 10 mA to 100 mA.
- The current measurement resolution during a test depends on the set upper-limit value: 0.01 mA at 0.10 mA to 10.00 mA and 0.1 mA at 10.1 mA to 100.0 mA.
- If the set lower-limit value is greater than the upper-limit value, the test cannot be started, even if the **START** key is pressed. In such a case, correct the upper- or lower-limit value.
- When the AC withstand-voltage mode is changed to the DC withstand-voltage mode, if the set upper-limit value is 10 mA or greater and the set lower-limit value is 9.9 mA or greater, the values for DC withstand-voltage testing will automatically be changed to 10 mA for the upper-limit, and 9.9 mA for the lower-limit.

3.3.3 Setting the Test Time

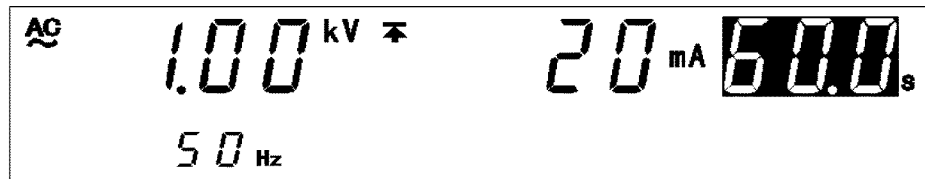

Test Time: 60.0 s

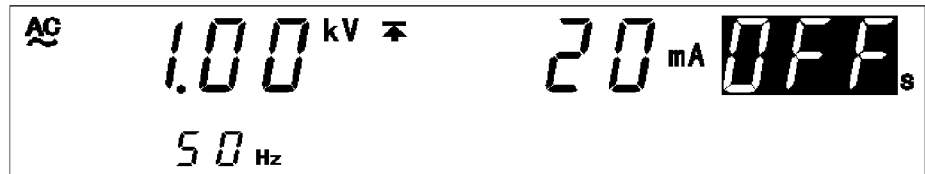

Test Time: OFF

1. If no flashing cursor is displayed in the withstand-voltage mode READY state, press either the ◀/▶ key to display the cursor in the test time position.
2. Set the test time using the ▼/▲ keys.
 - With time set the time changes in 0.1 s increments (1 s increments when the set time scale is 100 s to 999 s).
 - With time set at 0.3 s to 99.9 s, press **SHIFT** + ▼/▲ keys. The time changes in 1 s increments (10 s increments when the set time scale is 100 s to 999 s).
 - Settings may be made along a scale ranging from 0.3 s to 999 s.
 - If no testing time is required, turn off the **ON/OFF** key.
3. To finalize the test settings, press the **STOP** key. The settings are confirmed and the unit returns to the READY state.

NOTE

- The setting resolution of the test time is 0.1 s between 0.3 and 99.9 s, and becomes 1 s between 100 and 999 s.
- If a test time has been set, the reduction timer will operate during the test.
- If the test time is set to OFF, the time elapsed during the test is displayed. When this time exceeds 999 s, "---" will appear, but the test will continue.
- In the withstand-voltage test, because of the circuit response time, the output voltage may take some time to reach the test voltage depending on the load. As a result, the actual test time is "time taken to reach the accurate test voltage + pre-set test time".

3.3.4 Setting of the Ramp Timer

In this unit, the time to increase the voltage until it reaches the set test voltage (ramp-up time) and the time to decrease the voltage upon completion of the test time (ramp-down time) can be set. **TEST** flashes during the ramp-up time and the ramp-down time.

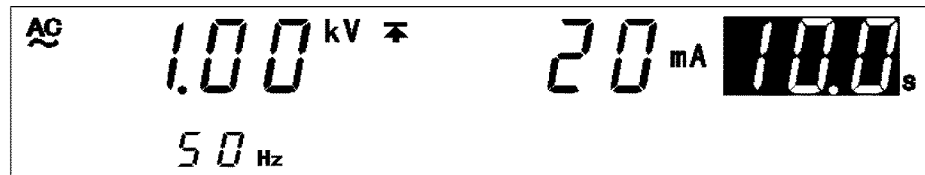

Ramp-up time: 10.0 s

1. If no flashing cursor is displayed in the withstand-voltage mode READY state, press either the ◀/▶ key to display the cursor in the test time position.
2. When the ▶ key is pressed, the **UP/DELAY** lamp will light up, enabling the ramp-up time to be set.
3. Set the test time using the ▼/▲ keys.
With time set the time changes in 0.1 s increments.
With time set at 0.1 s to 99.9 s, press **SHIFT + ▼/▲** keys.
If no testing time is required, turn off the **ON/OFF** key.
4. When the ▶ key is pressed, the **DOWN** lamp will light up, enabling the ramp-down time to be set.
5. Set the ramp-down time in the same way as the ramp-up time.
6. To finalize the test settings, press the **STOP** key. The settings are confirmed and the unit returns to the READY state.

NOTE

- During the ramp-up time, screening using the lower-limit value is invalid.
- During the ramp-up time, screening using the upper- or lower-limit value is invalid.

Optional Function

For the DC withstand-voltage test, you can select whether you want to perform screening during the ramp-up time. (See Section 7.12)

3.3.5 Setting the Type of Test Voltage

In the withstand-voltage mode, the following types of test voltages can be selected:

AC 50 Hz	For AC withstand-voltage tests. The frequency of the test voltage is 50 Hz.
AC 60 Hz	For AC withstand-voltage tests. The frequency of the test voltage is 60 Hz.
DC	For DC withstand-voltage tests.

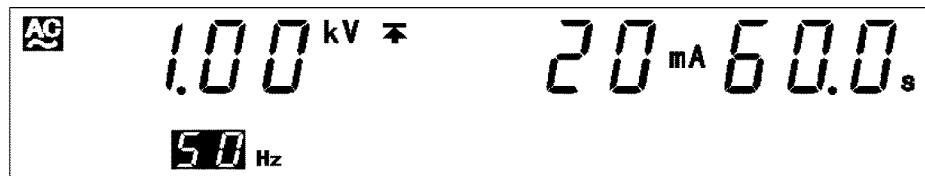

Test-voltage type: **AC 50 Hz**

1. If no flashing cursor is displayed in the withstand-voltage mode READY state, press either the $\blacktriangleleft/\blacktriangleright$ key to display the cursor in the AC or DC position.
2. Change the test-voltage type using the $\blacktriangledown/\blacktriangle$ keys. Select from AC 50 Hz, AC 60 Hz or DC.
3. To finalize the test settings, press the **STOP** key.

NOTE

The ripple voltage caused by the output of the DC withstand-voltage is not more than 6% of the set test-voltage value.

3.3.6 Examples of Settings

This section describes the procedure for making withstand-voltage test settings under the following conditions.

Test-voltage value: 2.00 kV
 Upper-limit value: 20 mA
 Lower-limit value: OFF
 Test time: 60.0 s
 Ramp-up time: 10 s
 Ramp-down time: OFF
 Test-voltage type: AC 60 Hz

The 3153 is in the READY state in withstand-voltage mode.

Values currently set		➔	Values to be set	
Test-voltage value	1.50 kV		Test-voltage value	2.00 kV
Upper-limit value	100 mA		Upper-limit value	20 mA
Lower-limit value	40 mA		Lower-limit value	OFF
Test time	120 s		Test time	60.0 s
Ramp-up time	30 s		Ramp-up time	10 s
Ramp-down time	20 s		Ramp-down time	OFF
Test voltage type	AC 50 Hz		Test-voltage type	AC 60 Hz

AC 1.50 kV 100 mA 120 s
50 Hz **READY**

(1) Changing to the SETTING state

Press the ◀/▶ keys to switch to the SETTING state. The **READY** light will go out, and the flashing cursor will be displayed at the position where the test-voltage value is indicated.

AC 1.50 kV 100 mA 120 s
50 Hz

(2) Setting the test-voltage value

In this example, the value is **1.50 kV**.

Using the $\blacktriangledown/\blacktriangle$ keys, set the comparative voltage value to **2.00 kV**.

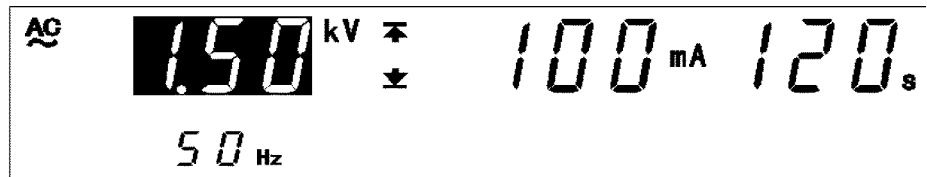

To change the value by **0.01 kV**, press $\blacktriangledown/\blacktriangle$ keys.

To change the value by **0.10 kV**, press **SHIFT + $\blacktriangledown/\blacktriangle$** keys.

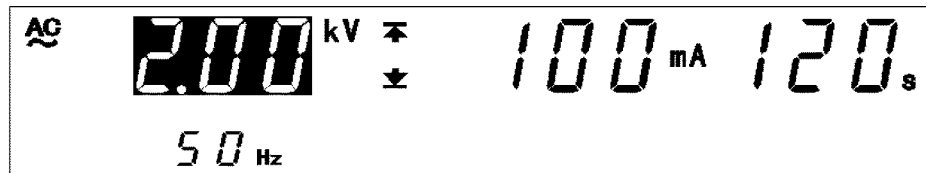

(3) Setting an upper-limit value

Press the \blacktriangleright key to move the flashing cursor to the upper-limit value.

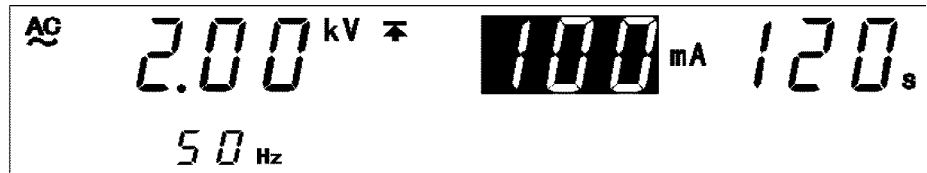

In this example, switch from **100 mA** to **20 mA** using the $\blacktriangledown/\blacktriangle$ keys.

To change the upper-limit value by **1 mA**, press $\blacktriangledown/\blacktriangle$ keys.

To change the upper-limit value by **10 mA**, press **SHIFT + $\blacktriangledown/\blacktriangle$** keys.

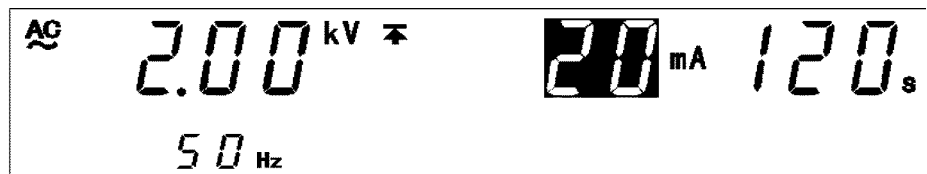

(4) Setting a lower-limit value

Using the \blacktriangleright key, move the flashing cursor to the lower-limit value.

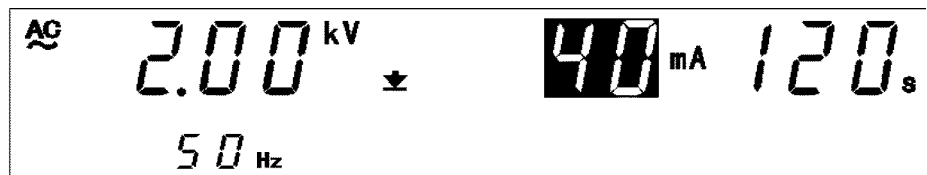

The lower-limit value is set at **40 mA**. Turn it OFF, as it is not needed. To change to OFF, press the **ON/OFF** key.

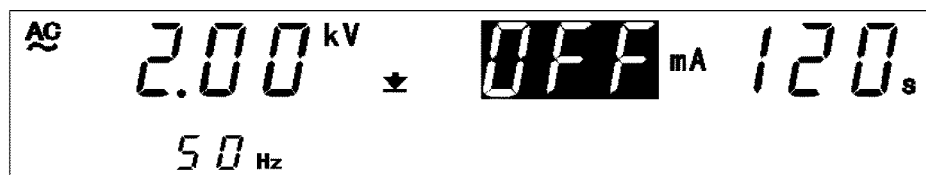

(5) Setting the test time

Using the ► key, move the flashing cursor to the test time.

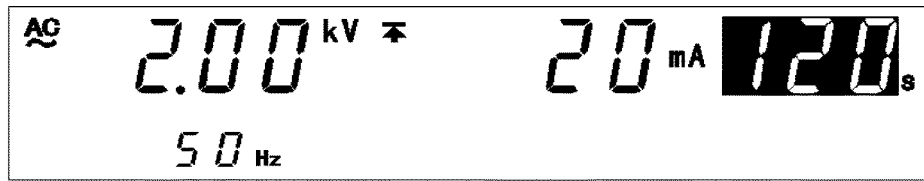

In this example, change the test time from 120 s to 60.0 s.

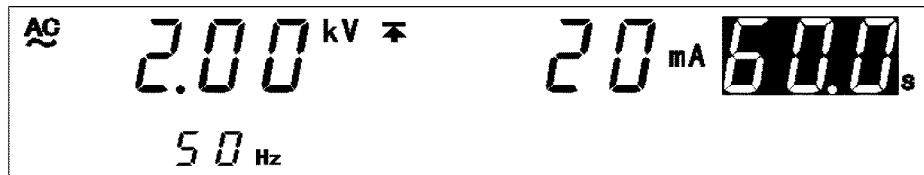

(6) Setting the ramp-up time

Using the ► key, move the flashing cursor to the ramp-up time.

(UP/DELAY lamp is lit.)

In this example, change the test time from 30 s to 10 s.

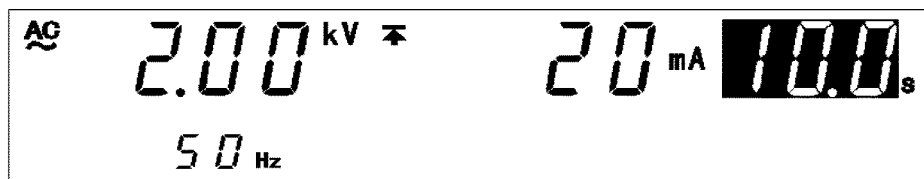

(7) Setting the ramp-down time

Using the ► key, move the flashing cursor to the ramp-down time.

(DOWN lamp is lit.)

The ramp-down time is set at 20 s. Turn it OFF, as it is not needed. To change to OFF, press the ON/OFF key.

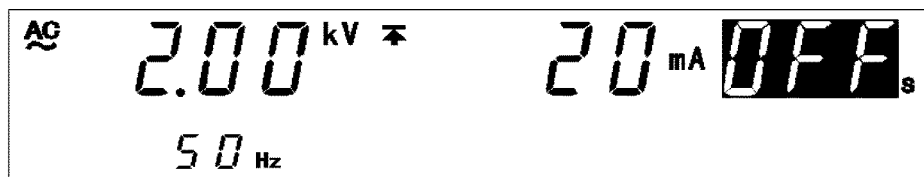

(8) Setting a test-voltage type

Press the ► key to move the flashing cursor to the AC or DC.

In this example, change the output voltage range from **AC 50 Hz** to **AC 60 Hz** using ▼/▲ keys.

Pressing the ▼/▲ keys changes the display as follows:

AC 50 Hz **AC 60 Hz** **DC.**

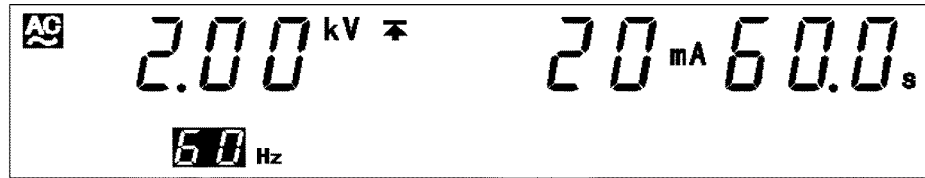

(9) Changing to the READY state

To return to the READY state, press the **STOP** key, which will finalize the test settings. In the READY state, **READY** lights up.

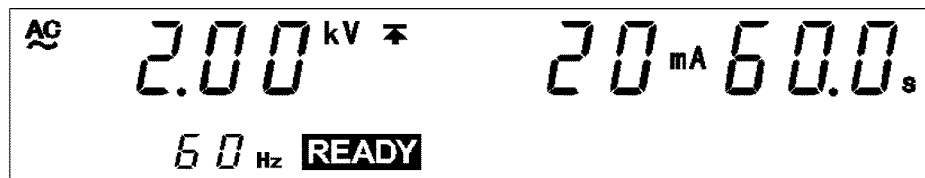

The new parameters following setting are shown below:

Test-voltage value: 2.00 kV
 Upper-limit value: 20 mA
 Lower-limit value: OFF
 Test time: 60.0 s
 Ramp-up time: 10 s
 Ramp-down time: OFF
 Test-voltage type: AC 60 Hz

3.4 Starting a Test

The flowchart below explains how a test is carried out.

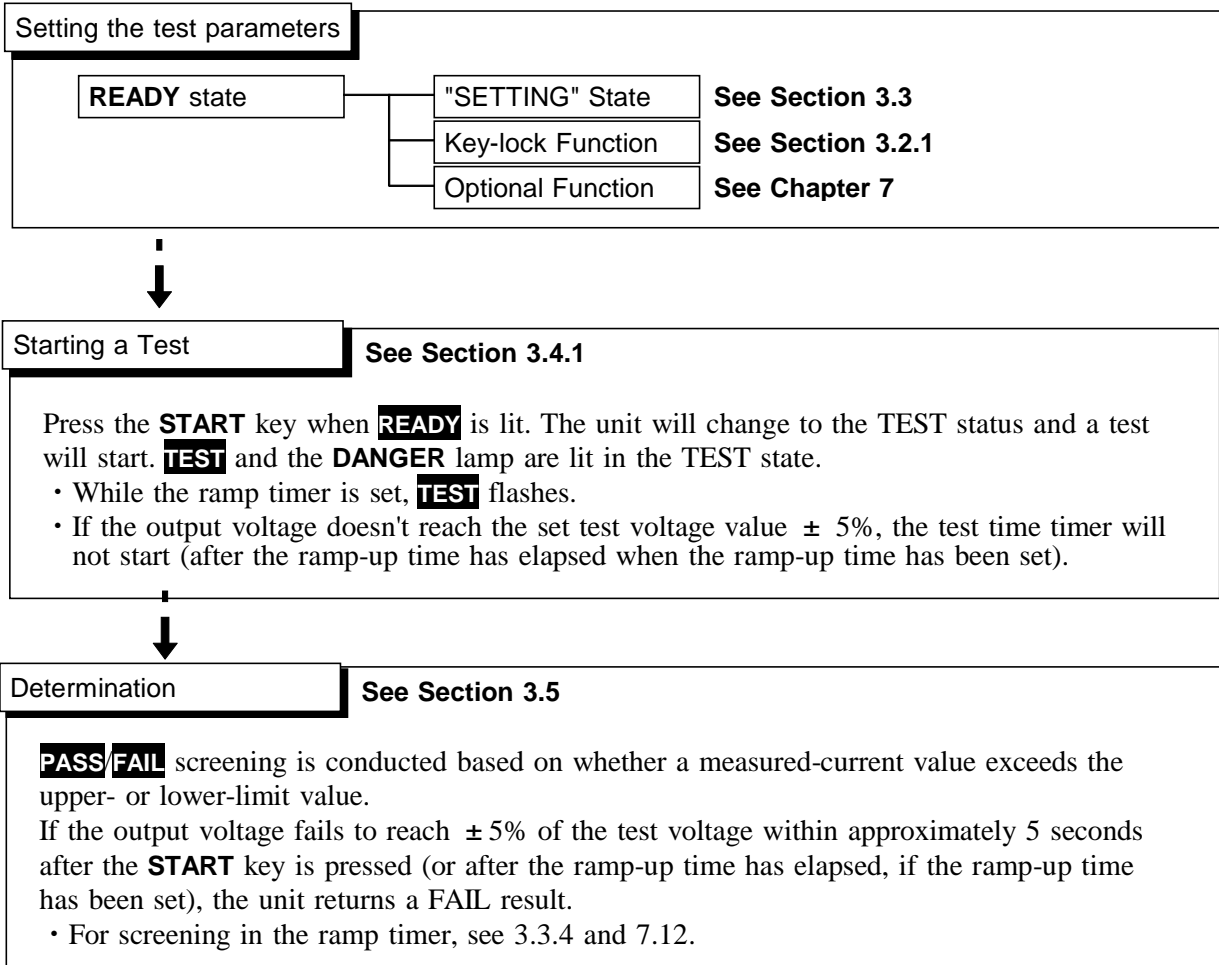

3.4.1 Executing a Test



To avoid electric shock, observe the following precautions to avoid electric shock.

Make sure that no high voltage is being applied to the output, confirm the following items, and output voltage.

- (1) The analog voltmeter reads 0 kV.
- (2) The **DANGER** lamp is OFF.
- (3) The **READY** lamp is lit (it is off in the Double Action mode).



- If a capacity load is applied to the tested object, the output voltage may exceed the preset voltage, thereby damaging the equipment.
- Continuous output of a high voltage may heat the bottom of the unit. Take special care when handling the unit (e.g. transporting the unit).



Priority for control of the **START** key is in the following order: the **START** key on the REMOTE CONTROL BOX, the external I/O, and the front panel of the unit. Connecting the switch signal line plug on the REMOTE CONTROL BOX disables the **START** key on the front panel of the unit and the start signal for the external I/O.

1. Press the **START** key when **READY** is lit.
The unit will change to the TEST status and a test will start. **TEST** and the **DANGER** lamp are lit in the TEST state.
2. In the following cases, tests are terminated, and **UPPER**, **LOWER**, and **FAIL** light up:
 - The output voltage fails to reach $\pm 5\%$ of the set test voltage.
 - During the test, the output voltage deviates from the test voltage, and does not return to ± 1 dgt of the set value within 5 seconds.
3. To terminate the test, press the **STOP** key. The unit will immediately stop outputting a voltage and switch to the READY state. In such a case, no screening is conducted.

NOTE

- Until the output voltage reaches the set test voltage, the **TEST** lamp continues to flash. When the output voltage reaches the set test voltage, the **TEST** lamp remains lit. If the ramp-up time is set, the **TEST** lamp continues flashing until the output voltage reaches the set test voltage. During the ramp-up time, the lower-limit value cannot be set.
- The **UP/DELAY** lamp lights during ramp-up.
- The **DOWN** lamp lights during ramp-down. (However, it does not light during time testing when insulation-resistance test termination mode is set to 0 [initial setting].)
- In addition to using the **STOP** key on the unit, a stop can be forced using the **STOP** key on the remote-control box or by using a STOP signal via external input/output.
- Conditions under which testing cannot start:
When using settings similar to the following, testing cannot start even when the **START** key is pressed. (Flashing items vary by setting.)

Flashing	Setting
Testing upper-/lower-limit values	Testing lower-limit value testing upper-limit value
Measured voltage value	Output voltage restricting value (optional function) < testing voltage value (See Section 7.9)

Optional Functions

- To ensure safety, an upper-limit for the test voltage can be set. (When the default is set to 5.00 kV.) (See Section 7.9)
- The FAIL Hold function can be used to hold the effective value at the time of termination of the test using FAIL screening. (See Section 7.2)
- The Hold function can be used to hold the value that was effective at the time of forced termination of the test. (See Section 7.3)
- For the DC withstand-voltage test, you can select whether you want to perform screening during the ramp-up time. (See Section 7.12)

3.4.2 Screening in "TEST" State

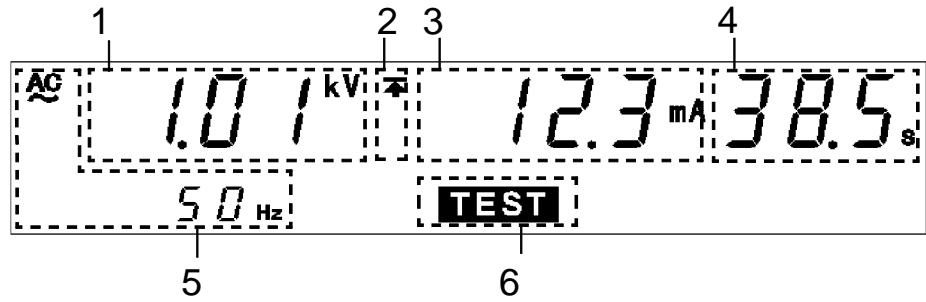

1	Measured voltage value	Indicates the voltage value being output.
2	Upper-limit value icon and Lower-limit value icon	The symbol appears when the upper-limit value is set, and the symbol appears when the lower-limit value is set.
3	Measured current value	Represent the value of a current flowing between the HIGH and LOW terminals.
4	Test time elapsed	<ul style="list-style-type: none"> • When the testing time is set, countdown starts from the time set, and is displayed. When the testing time is set to OFF, the time elapsed after the start of the test is displayed. • If the elapsed test time exceeds 999 s, "---" is displayed, but the voltage continues to be output.
5	Test-voltage type	Indicates the test type (AC 50 Hz, AC 60 Hz or DC.)
6	TEST	TEST flickers for up to five seconds at the start of a test and when the output voltage exceeds the comparative-voltage range.

Danger lamp

Indicates that a voltage is being output. The lamp stays on during the test (including ramp-up time and ramp-down time). In the withstand-voltage mode, this lamp remains lit even after completion of the test, if a voltage higher than the safety voltage (approximately AC 0.03 kV or approximately DC 0.06 kV) has flowed between output terminals.

Analog voltmeter

Indicates the voltage value being output.

External I/O

The timing when the TEST signal is turned ON is the same as the timing when **TEST** on the fluorescent indicator lights up (or flashes). The timing when the H.V.ON signal is turned on is the same as when the **DANGER** lamp lights up. The two signals are turned OFF at the same time.

Upon startup of the test, although **TEST** flashes until the output voltage reaches the set test voltage or during the ramp-up time, the TEST signal is ON.

Optional Functions

Setting can be performed so that the TEST signal will be OFF while **TEST** flashes. See Section 7.15.

3.5 "PASS" or "FAIL" Determination

3.5.1 "PASS" State



Even when a test has been terminated, there may still be voltage in the output-voltage terminal. Before touching the output-voltage terminal, H.V. TEST LEAD, or tested object, make sure that no high voltage is being applied to the output, confirm the following items.

- (1) The analog voltmeter reads 0 kV.
- (2) The DANGER lamp is OFF.
- (3) The **READY** lamp is lit (it is off in the Double Action mode).

If the test time has not been set, PASS screening is not performed. To the test, press the **STOP** key, which will forcibly terminate the test.

Optional Functions

The PASS state is held using the PASS Hold function. (See Section 7.1)

Flow of PASS determination

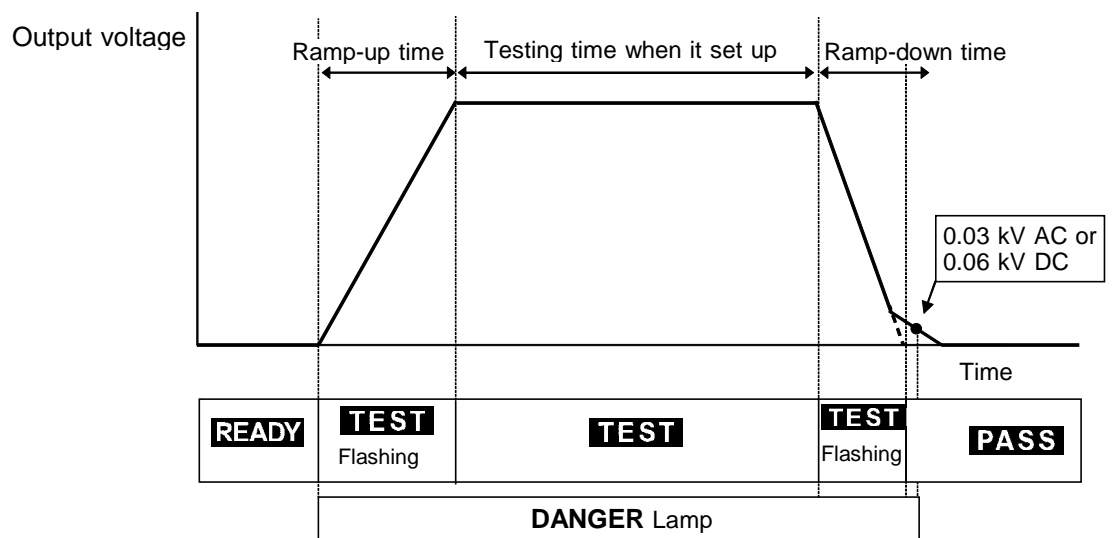

1. Press the **START** key to start a test.
2. **TEST** flashes until the output voltage reaches the set test voltage. **TEST** also flashes during the ramp-up time. When the output voltage reaches the test voltage, **TEST** remains lit, and the reduction timer starts counting down the test time.
3. A voltage is output until the test time elapses. (If the measured-current value deviates from the upper- and lower-limit values, the unit switches to the FAIL state.
4. If the ramp-down time is not set, upon completion of the test time, the unit will change to the PASS state. If the ramp-down time is set, the reduction timer starts counting down the ramp-down time. Upon expiration of the time, the measurement result upon completion of the test is displayed, and the unit changes to the PASS state. In the PASS state, **PASS** is lit.



- For screening in the ramp timer, see 3.3.4 and 7.12.

3.5.2 Screening in "PASS" State

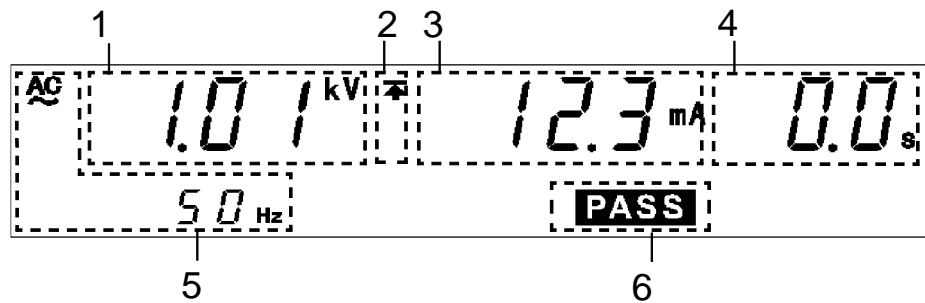

1	Measured voltage value	Indicates the voltage in the PASS state.
2	Upper-limit value icon and Lower-limit value icon	The symbol \uparrow appears when the upper-limit value is set, and the symbol \downarrow appears when the lower-limit value is set.
3	Measured current value	Indicates the value of the current flowing between the HIGH and LOW terminals in the PASS state
4	Test time elapsed	Displays the time in which the test has been completed. In PASS state, "0.0s" is displayed.
5	Test-voltage type	Indicates the test type (AC 50 Hz, AC 60 Hz or DC.)
6	PASS	Indicates that the unit is in the PASS state.

Danger lamp

Indicates that a voltage is being output. The lamp stays on during the test (including ramp-up time and ramp-down time). In the withstand-voltage mode, this lamp remains lit even after completion of the test, if a voltage higher than the safety voltage (approximately AC 0.03 kV or approximately DC 0.06 kV) has flowed between output terminals.

Analog voltmeter

Indicates the voltage being output in withstand-voltage test. The analog voltmeter is not held even if the PASS Hold function is disabled.
Indicates the voltage value being output.

External I/O

The **PASS** signal is turned ON when **PASS** on the fluorescent indicator is lit. As long as the PASS state is held, the PASS signal remains ON. The PASS signal is turned OFF when the **PASS** light on the fluorescent indicator goes out.

If voltage remains in the output-voltage terminal following termination of a test, the H.V.ON signal remains ON. When the **DANGER** lamp goes out, H.V.ON signal is immediately turned OFF.

3.5.3 "FAIL" State



Even when a test has been terminated, there may still be voltage in the output-voltage terminal. Before touching the output-voltage terminal, H.V. TEST LEAD, or tested object, make sure that no high voltage is being applied to the output, confirm the following items.

- (1) The analog voltmeter reads 0 kV.
- (2) The DANGER lamp is OFF.
- (3) The **READY** lamp is lit (it is off in the Double Action mode).

If the measured voltage deviates from the upper or lower value during the test, the unit switches to the FAIL state and immediately stops outputting a voltage.

The FAIL state can be divided into UPPER FAIL and LOWER FAIL states.

UPPER FAIL	The measured current has exceeded the upper-limit value.
LOWER FAIL	The measured current has dropped below the lower-limit value.

(When the lower-limit value is set to OFF, LOWER FAIL is ineffective.)

If the output voltage fails to reach $\pm 5\%$ of the set test voltage, or if it deviates from the set voltage, the unit changes to the FAIL state. **UPPER**, **LOWER**, and **FAIL** light up.

Optional Functions

The FAIL state is held using the FAIL Hold function. (See Section 7.2)

Flow of FAIL determination

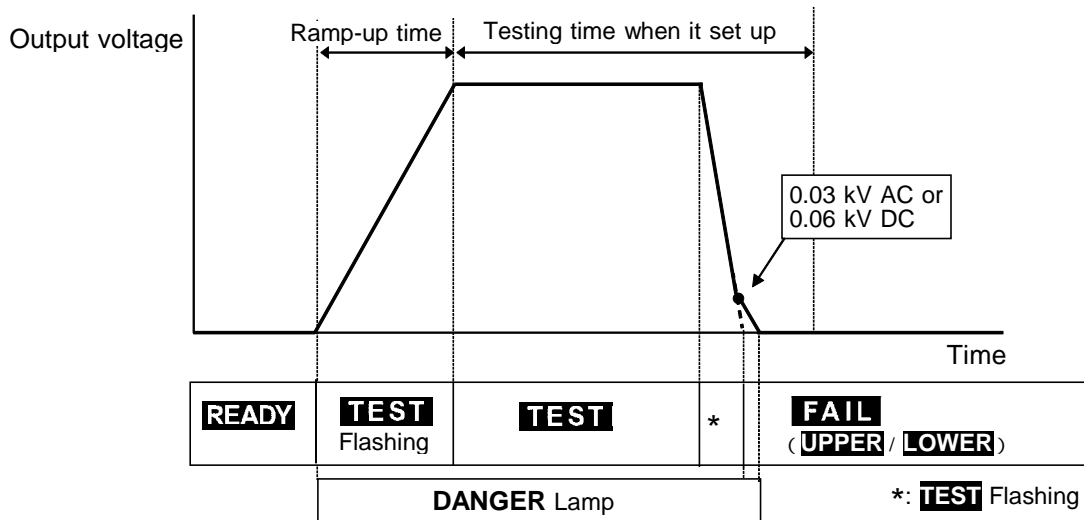

1. Press the **START** key to start a test.
2. **TEST** flashes until the output voltage reaches the set test voltage. **TEST** also flashes during the ramp-up time. When the output voltage reaches the test voltage, **TEST** remains lit, and the reduction timer starts counting down the test time.
3. A voltage continues to be output until the test time elapses. If the measured current deviates from the upper- or lower-level value during this period, the unit switches to the FAIL state.
4. Once a switch is made to the FAIL state, **FAIL** lights up, together with **UPPER** or **LOWER**. The unit stops outputting a voltage and the reduction timer stops.

NOTE

If the current generated is several times as large as the upper-limit value, a circuit promptly cuts off the high voltage, thereby switching the unit to **UPPER FAIL**. At this point, an incorrect value for the measured current is displayed.

* For screening in the ramp timer, see 3.3.4 and 7.12.

3.5.4 Screening in "FAIL" State

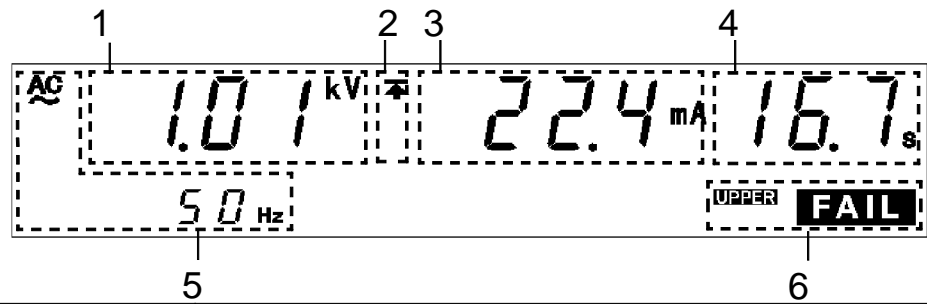

1	Measured voltage value	Indicates the voltage in the FAIL state.
2	Upper-limit value icon and Lower-limit value icon	The symbol \uparrow appears when the upper-limit value is set, and the symbol \downarrow appears when the lower-limit value is set.
3	Measured current value	Indicates the current flowing between the HIGH and LOW terminals in the FAIL state.
4	Test time elapsed	Indicates the time when the unit switched to the FAIL state. If the test time has been set, the remaining test time is displayed. If the test time is set at OFF, the period of time during which a voltage is output is displayed.
5	Test-voltage type	Indicates the test type (AC 50 Hz, AC 60 Hz or DC.)
6	FAIL	Indicates that the unit is in the FAIL state. FAIL lights up with UPPER to indicate UPPER FAIL , and with LOWER to indicate LOWER FAIL . If the output voltage deviates from the comparative-voltage range and switches the unit to the FAIL state, UPPER , LOWER , and FAIL light up.

Danger lamp

Indicates that a voltage is being output. The lamp stays on during the test (including ramp-up time and ramp-down time). In the withstand-voltage mode, this lamp remains lit even after completion of the test, if a voltage higher than the safety voltage (approximately AC 0.03 kV or approximately DC 0.06 kV) has flowed between output terminals.

Analog voltmeter

Indicates the voltage being output in withstand-voltage test. The analog voltmeter is not held even if the FAIL Hold function is disabled.

Indicates the voltage value being output.

External I/O

The W-FAIL signal and either the U-FAIL or L-FAIL signal come on when **FAIL** lights on the fluorescent indicator. (If the output voltage fails to reach $\pm 5\%$ of the set test voltage, or if it deviates from the set test voltage, **UPPER**, **LOWER**, and **FAIL** light up, and the W-FAIL, U-FAIL, and L-FAIL signals turn ON.) Both the W-FAIL and U-FAIL signals, as well as the L-FAIL signal remain ON as long as the FAIL state is held. The W-FAIL, U-FAIL and L-FAIL signals are turned OFF when the **FAIL** light on the fluorescent indicator goes out. If voltage remains in the output-voltage terminal following the termination of a test, the H.V.ON signal remains ON. When the **DANGER** lamp goes out, the H.V.ON signal is immediately turned OFF.

3.6 Automatic Discharge Function

When a test object that contains a capacity component is subjected to a withstand-voltage test, the object might remain electrically charged, thereby causing an electric shock. This unit is equipped with a function to discharge residual electricity upon termination of the withstand-voltage test (discharge resistance: 726 k Ω).

The unit automatically switches to the internal discharge circuit to discharge the test object (the **DANGER** lamp is lit).

When the voltage between the output terminals falls below the safety voltage (approximately AC 0.03 kV or DC 0.06 kV), the **DANGER** lamp goes out.

The larger the capacity component of the test object, the more time is required to discharge the test object.

NOTE

- The unit does not return to the READY state until the **DANGER** lamp goes out upon completion of the test. Until the unit returns to the READY state, no key operation is accepted.
- With an optional setting, the unit can change to the READY state, regardless of the **DANGER** lamp indication, upon completion of the test (see Section 7.14 START Protection Function).

In such a case, the voltage output terminals may contain residual electricity even when the unit is in the READY state.

Chapter 4

Insulation Resistance Mode Testing Method

4

This chapter describes how to set insulation-resistance mode test conditions and the proper testing procedure.

Read chapter 2, and make the necessary preparations for testing.

Press the **I** key to enter insulation-resistance mode.
(The **I** lamp above the key to the left lights.)

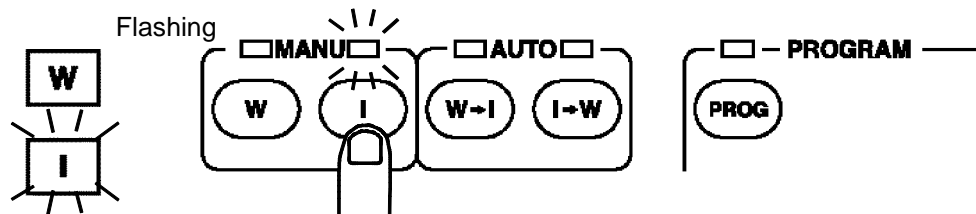

NOTE

- Choose the insulation resistance test termination mode (see "7.11 Insulation Resistance Test Termination Settings") and set an adequate test time and delay time.
- With some tested objects, it may take some time until the actual output voltage reaches the set test voltage.
Using both defective and non-defective samples of the tested object, check to see if measurement and screening are conducted correctly.
Turn OFF the timer and find an adequate timer setting with which measurement is performed correctly.
Turn ON the timer. Set that timer setting as the test time and check to ensure that measurement and screening are conducted correctly. Also, set the delay time.
- Approximately 2.0 seconds is required to calculate moving averages when it has been determined that capacity is available. (Determination of capacity requires 0.6 seconds.)
- When capacitance is present, the time constant based on the capacitance and resistance values may delay the measurement results.
- Approximately 1.6 seconds is required for the range to stabilize when Auto Range is selected (when the resistance values of the device tested do not vary).
- When resistance values vary, more time is required for testing.

4.1 Insulation Resistance Mode Display

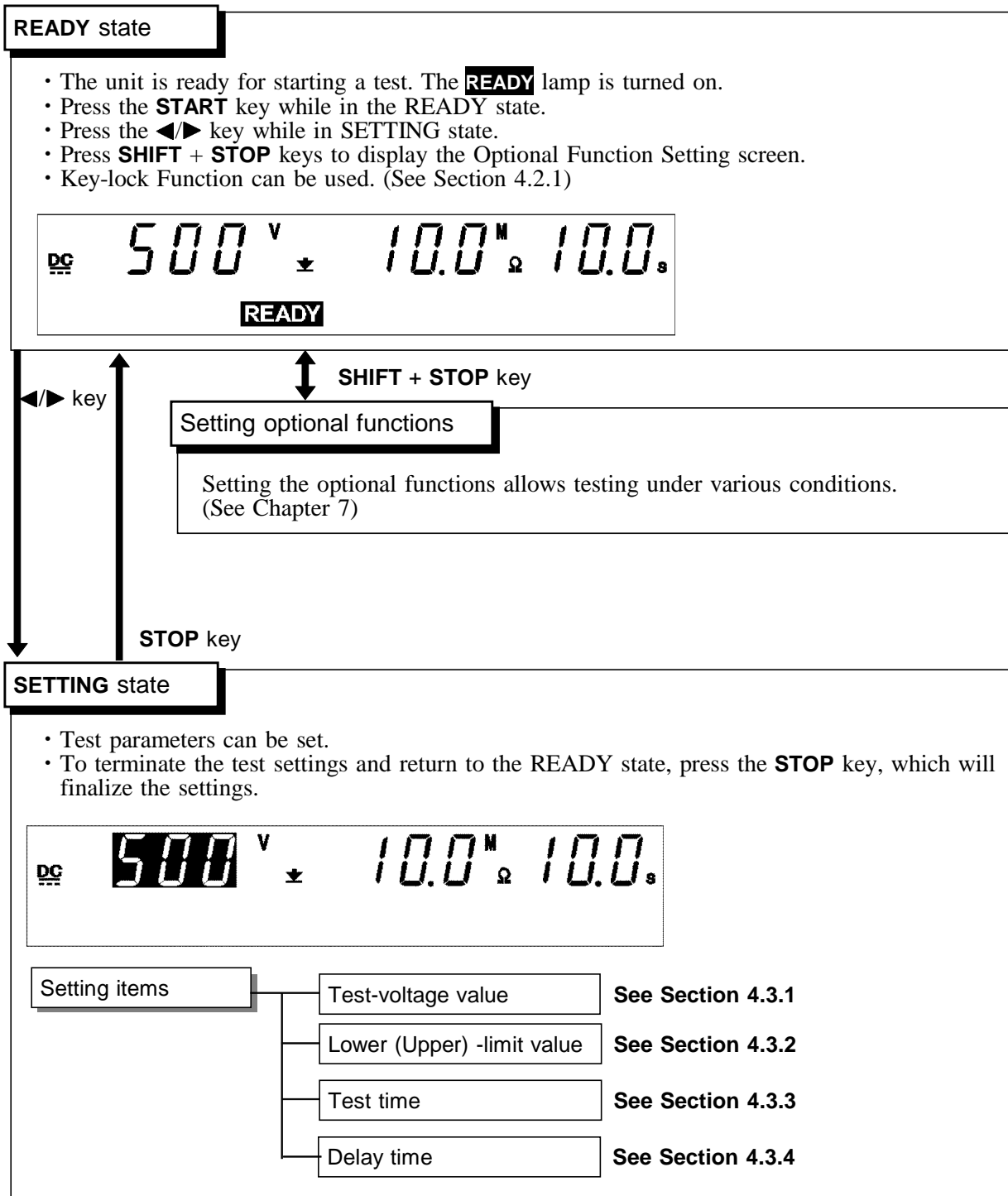

START key

TEST state

See Section 4.4.2

- When the unit is in the TEST state, the **TEST** lamp is lit. This indicates that a test is in progress.
- Compares the upper- and lower-limit measured resistance values. If the measured resistance value deviates from either of these values once the test time has elapsed, the unit shifts to the FAIL state. If the value does not deviate, the unit shifts to the PASS state.
- Press the **STOP** key to forcibly terminate the test.

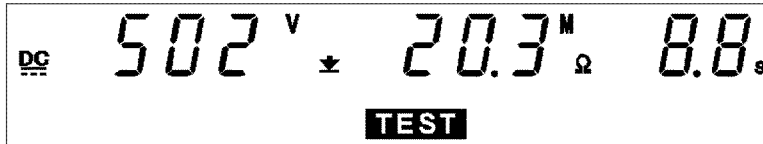

Key operation in the TEST status

Forced ending

Press the **STOP** key.**PASS state**

See Section 4.5.1

- **PASS** indicates that the measured object passed the test set in the READY state.
- The **PASS** lamp is turned on. The PASS state screen is displayed for about 0.3 second before switching to the READY state.
- The PASS state can be maintained if the PASS Hold function is disabled in the optional settings. (See Section 7.1)

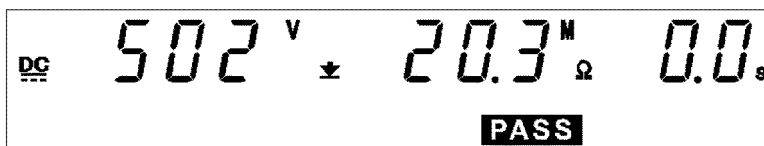
**FAIL state**

See Section 4.5.3

- **READY** indicates that the tested object failed to pass the test set in the READY state.
- The **FAIL** lamp will light up, accompanied by **UPPER** if the measured value exceeds the upper-limit value, or by **LOWER** if the measured value is below the lower-limit value.
- The FAIL state can be maintained. To return to the READY state, press the **STOP** key, which will cancel the FAIL Hold function.
- FAIL Hold function can be disabled in the optional settings. The FAIL-state screen is displayed for 0.3 seconds, and the unit then switches to the READY state. (See Section 7.2)

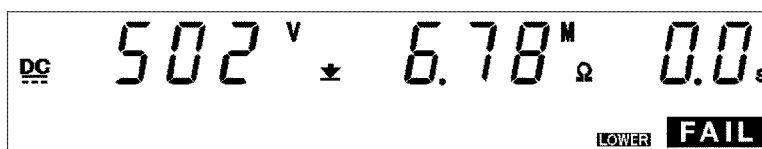

4.2 Displaying the "READY" State

In the READY state, the unit is always ready to start a test. The **READY** lamp remains lit to indicate the READY state.

Saving and loading for setting data and the setting of optional functions are made following the READY state.

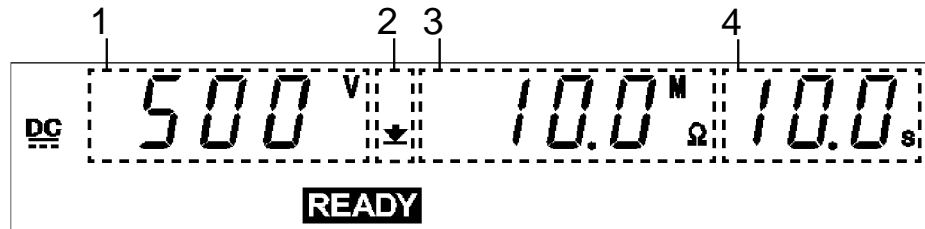

1	Test-voltage value	Indicates the voltage value being output.
2	Upper-limit value icon and Lower-limit value icon	The symbol \uparrow appears when the upper-limit value is set, and the symbol \downarrow appears when the lower-limit value is set.
3	Lower-limit value	Indicates Lower-limit value.
4	Test time	Indicates the preset test time. "OFF" is indicated when no test-time setting has been made.

Danger lamp

Indicates that a voltage is being output. This lamp remains lit as long as a voltage is being applied to the output terminal. It does not light up in the READY state.

Analog voltmeter

Indicates the voltage value being output. In the READY state, the value remains at 0 kV.

External I/O

The READY signal is ON when **READY** is lit on the fluorescent indicator. The READY signal is turned OFF when **READY** is not lit.

Key Operations

$\blacktriangleleft/\blacktriangleright$	Displays the SETTING state. (See Section 4.3)
SHIFT + \blacktriangleright	Displays the set data Save screen. (See Section 8.1)
SHIFT + \blacktriangleleft	Displays the set data Load screen. (See Section 8.2)
SHIFT + STOP	Displays the Optional functions setting screen. (See Chapter 7)
START	Test Start (See Section 4.4)
LOCK	Key-lock function (See Section 4.2.1)

4.2.1 Key-lock Function

It inactivates all keys except the **START** key, **STOP** key, and the range switch. The **KEYLOCK** lamp is lit while the key-lock function is active. Use this function when you do not want to change the test mode or test settings.

To switch to the KEY-LOCK state, press the **LOCK** key. The **KEYLOCK** lamp is lit.

To cancel the key-lock function, press the **LOCK** key in the KEY-LOCK state while holding down the **SHIFT** key. The **KEYLOCK** lamp is not lit.

4

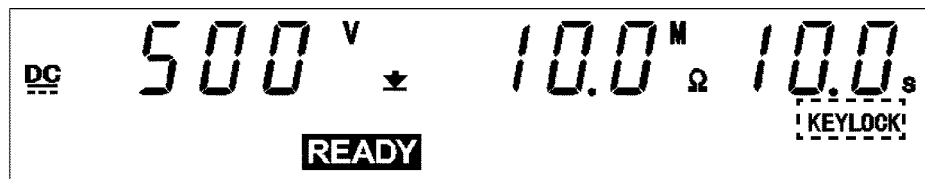

NOTE

Even when the key-lock function is activated, the **START** and **STOP** keys on the REMOTE CONTROL BOX and the start and stop signals on the external I/O terminal remain active.

4.3 "SETTING" State

To set or change test settings, switch to the SETTING state.

NOTE

- In the SETTING state, the **READY** light goes out and tests cannot start.
- In the insulation-resistance mode READY state and "test setting state," although the test-voltage value is displayed, that voltage is not being output.

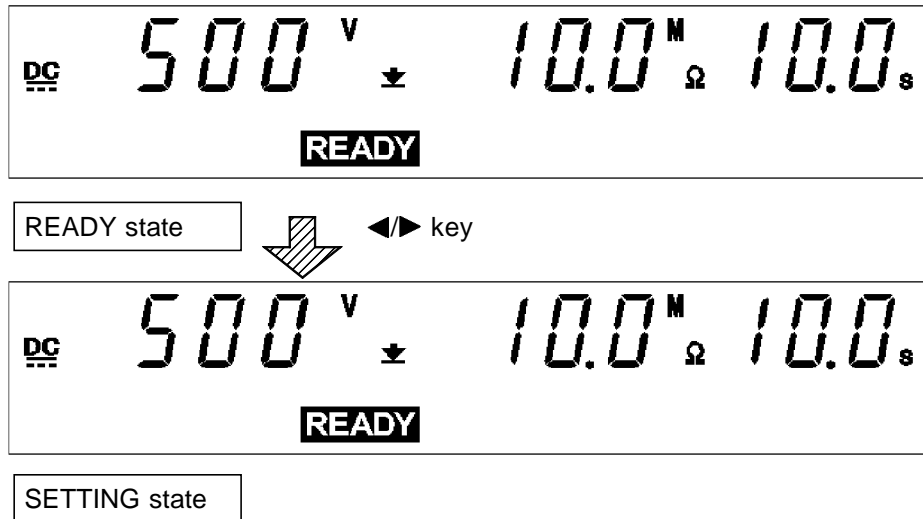

1. In the insulation-resistance mode READY state, when you press the **◀▶** keys, the flashing cursor appears where the test-voltage is indicated to show that the unit is in the SETTING state. (The **READY** light goes out and tests cannot start even if the **START** key is pressed.)
2. Use the following operation keys to make settings:
 - ◀▶ key: Move the flashing cursor.
 - ▼/▲ key: Change settings.
 - ON/OFF keys: Activate and deactivate values.
 - The flashing cursor moves between the test-voltage value, lower-limit value, upper-limit value, test time and the delay time.
 - If the value indicated by the flashing cursor is not needed in the test, turn it OFF using the **ON/OFF** keys. The lower-limit value and the test-voltage value, however, cannot be turned OFF.
3. To finalize the test settings, press the **STOP** key. The settings are confirmed and the unit returns to the READY state.

NOTE

Note that the unit does not return to the READY state if the lower-limit value is greater than the upper-limit value. In this case, correct the settings and press the **STOP** key to confirm them.

4.3.1 Setting the Test Voltage Value

The test-voltage value can be set in the range of 50 V to 1,200 V in 1-V steps.

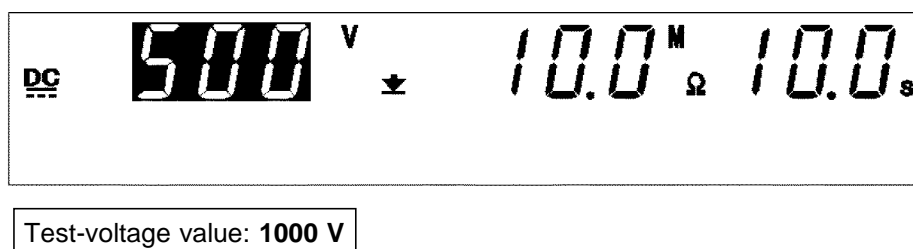

1. If no flashing cursor is displayed in the insulation-resistance mode READY state, press either the ◀/▶ key to display the cursor in the test-voltage value position.
2. Change the test-voltage value using the ▼/▲ keys.
To change the value by 10 V, press **SHIFT** + ▼/▲ keys.
Settings may be made along a scale ranging from 50 to 1200 V.
3. To finalize the test settings, press the **STOP** key. The settings are confirmed and the unit returns to the READY state.

NOTE

- The test-voltage value is connected to the lower-limit value. The test voltage cannot be set at a value greater than the lower-limit value x 1,000. (For example, if the lower-limit value is set at 0.5 M Ω , the test voltage cannot be set at a value greater than 0.5 x 1,000 = 500 (V).)
- If the lower-limit for the test voltage is set in accordance with various safety standards, set the voltage with errors generated by this unit taken into consideration.
- If the test object contains a capacity load, the output voltage may be higher than the set voltage. (In the case of a capacity load of 5 μ F or less, the output voltage should not be greater than 1.2 times the set voltage.)
- Note that the unit does not start test if the test-voltage value is greater than the output-voltage restricting value. See Section 7.9.

4.3.2 Setting the Lower (Upper) Limit Value

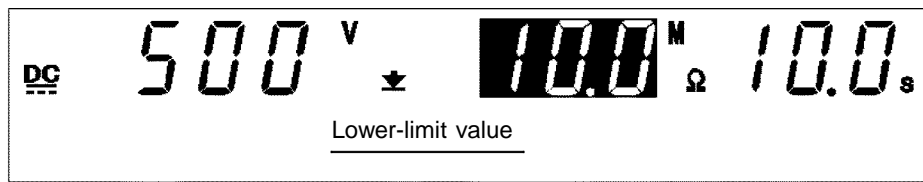

Lower Limit Value: 10 MΩ

1. If no flashing cursor is displayed in the insulation-resistance mode READY state, press either the ◀/▶ key to display the cursor in the lower (upper)-limit value position.
2. Set the lower (upper)-limit value using the ▼/▲ keys.
The lower (upper)-limit value increases for each setting resolution function shown in the list below.
Press the keys, **SHIFT** + ▼/▲ key. The value increases or decreases 10 times more rapidly than when the **SHIFT** key is not held down.
If the **SHIFT** + ▼/▲ keys continue to be held down, the value increases or decreases by multiples of 100.
The lower (upper)-limit value can be set between 0.1 and 9999 MΩ.
If no Upper-limit value is required, turn off the **ON/OFF** key. Lower-limit value can not be turn off.
3. To finalize the test settings, press the **STOP** key. The settings are confirmed and the unit returns to the READY state.

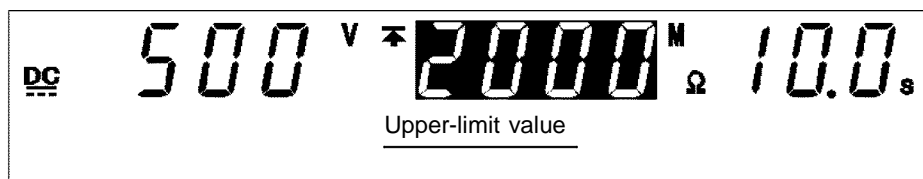

Upper-limit value: 2000 MΩ

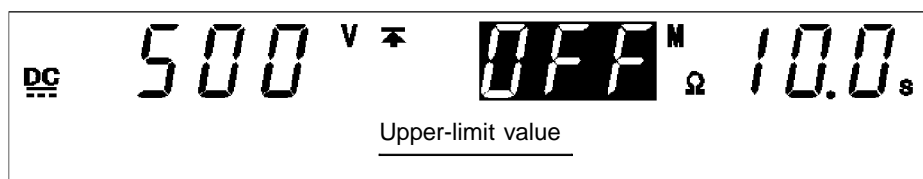

Upper-limit value: OFF

NOTE

- If the set lower-limit value is greater than the upper-limit value, the test cannot be started, even if the **START** key is pressed. In such a case, correct the upper- or lower-limit value.
- The measured resistance and measurement ranges depend on the set lower-limit and test-voltage values.
- Resistance values larger than 9999 MΩ are displayed as "O.F." (overflow). Therefore, when the resistance measurement range is fixed, UPPER FAIL may result even if the actual resistance value is lower than the test upper-limit value. If "O.F." (overflow) appears on the screen, check out the actual measurement range.
- Resistance values smaller than 0.1 MΩ are displayed as "U.F." (underflow).
- The lower-limit value cannot be set to a value smaller than the test-voltage value/1,000 (MΩ). For example, if the test voltage is set at 1,000 V, the lower-limit value cannot be set at a value smaller than 1,000/1,000=1(MΩ).

Upper- or lower-value

Setting range (MΩ)	Setting resolution (MΩ)
0.10 to 9.99	0.01
10.0 to 99.9	0.1
100 to 9999	1

Measurement resistance value

Measurement range (MΩ)	Measurement resolution (MΩ)
0.100 to 1.049	0.001
1.05 to 10.49	0.01
10.5 to 104.9	0.1
105 to 9999	1

Test voltages (reference values), lower-limit values, and measurement ranges

Test voltage (V)	Lower-value (MΩ)	Measurement resistance (MΩ)
50	0.10 to 0.49	0.100 to 1.000
	0.50 to 4.76	0.430 to 10.00
	4.77 to 49.9	4.30 to 100.0
	50.0 to 9999	43.0 to 1000
100	0.10 to 0.99	0.100 to 2.00
	1.00 to 9.52	0.870 to 20.0
	9.53 to 99.9	8.70 to 200
	100 to 9999	87.0 to 2000
250	0.25 to 2.48	0.217 to 5.00
	2.49 to 23.8	2.17 to 50.0
	23.9 to 249	21.7 to 500
	250 to 9999	217 to 5000
500	0.50 to 4.97	0.435 to 10.00
	4.98 to 49.9	4.35 to 100.0
	50.0 to 499	43.5 to 1000
	500 to 9999	435 to 9999
1000	1.00 to 9.95	0.870 to 20.0
	9.96 to 99.9	8.70 to 200
	100 to 999	87.0 to 2000
	1000 to 9999	870 to 9999

The measurement range varies depending on the test voltage. See " Appendix 4 Insulation Resistance Mode measurement range. "

When the resistance value exceeds the measurement range, it is displayed as "O.F." (overflow).

When the set resistance value does not reach the measurement range, values are displayed on the "U.F." (underflow).

In this case, if the resistance measurement range is not appropriate, the voltage between the voltage output terminals may become lower than the measurement. Choose the Auto Range.

*: Refer to the notes.

Optional Functions

You can make the low measurement range a fixed range or an automatic range, depending on the optional function settings. (See Section 7.10)

4.3.3 Setting the Test Time



1. If no flashing cursor is displayed in the insulation-resistance mode READY state, press either the ◀/▶ key to display the cursor in the test time position.
2. Set the test time using the ▼/▲ keys.
 With time set the time changes in 0.1 s increments (1 s increments when the set time scale is 100 s to 999 s).
 With time set at 0.3 s to 99.9 s, press **SHIFT + ▼/▲** keys. The time changes in 1.0 s increments (10 s increments when the set time scale is 100 s to 999 s).
 Settings may be made along a scale ranging from 0.3 s to 999 s.
 If no testing time is required, turn off the **ON/OFF** key.
3. To finalize the test settings, press the **STOP** key. The settings are confirmed and the unit returns to the READY state.

NOTE

- Screening is not conducted for insulation-resistance tests when the test time is set to OFF.
- If the test time is set to OFF, the time elapsed during the test is displayed. When this time exceeds 999 s, "---" will appear, but the test will continue.
- The setting resolution of the test time is 0.1 s between 0.3 and 99.9 s, and becomes 1 s between 100 and 999 s.
- If a test time has been set, the reduction timer will operate during the test.
- When Auto Range is set (see Section 7.10), it takes approximately 1.5 s for the range to stabilize after the test starts. When the set test time is shorter than this, the test results in a UPPER LOWER FAIL (see Chapter 4).
- If the test time is short, the output voltage may not reach the preset test voltage, depending on the test object.
- Set a sufficient test time and delay time, in accordance with the insulation-resistance termination mode (see Section 7.11).

Optional Functions

When the test time is set, the test can be terminated before the set test time for PASS or FAIL determination has elapsed depending on optional function settings. (See Section 7.11)

4.3.4 Setting the Delay Time

Time during which screening is not performed from the start of a test (delay time) can be set. This is effective when a test object contains a capacity load.

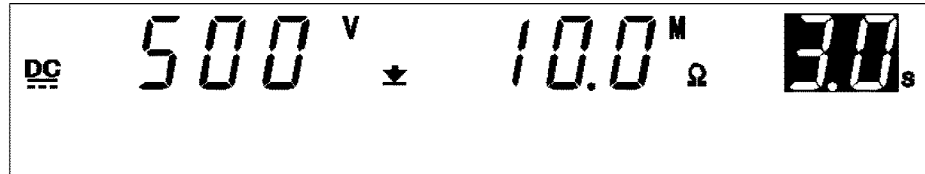

Delay time: 3.0 s

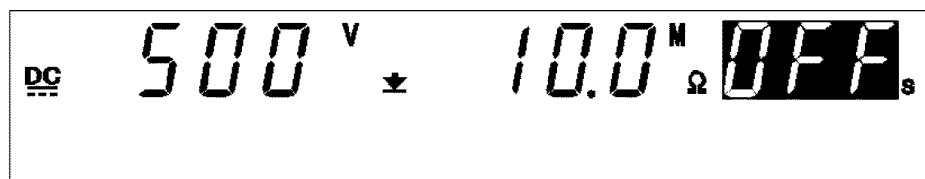

Delay time: OFF

1. If no flashing cursor is displayed in the insulation-resistance mode READY state, press either the ◀/▶ key to display the cursor in the test time position.
2. When the ▶ key is pressed, the **UP/DELAY** lamp lights up to enable the delay time to be set.
3. Set the test time using the ▼/▲ keys.
 With time set the time changes in 0.1 s increments.
 With time set the time changes in 1 s increments, press **SHIFT + ▼/▲** keys.
 Settings may be made along a scale ranging from 0.1 s to 99.9 s.
 If no testing time is required, turn off the **ON/OFF** key.
4. To finalize the test settings, press the **STOP** key. The settings are confirmed and the unit returns to the READY state.

NOTE

- After the delay time is set, if it is turned OFF and turned ON again using the **ON/OFF** key, the delay time is reset to the initial value (0.1 s).
- When the delay time test time, the unit will not start the test.

4.3.5 Examples of Settings

This section describes the procedure for making insulation-resistance test settings under the following conditions.

Test-voltage value: 500 V
 Lower-limit value: 100 MΩ
 Upper-limit value: OFF
 Test time: 5.0 s
 Delay time: 0.5 s

The 3153 is in the READY state in insulation-resistance mode.

Values currently set	
Test-voltage value	1000 V
Lower-limit value	10.0 MΩ
Upper-limit value	2000 MΩ
Test time	20.0 s
Delay time	1.0 s



Values to be set	
Test-voltage value	500 V
Lower-limit value	100 MΩ
Upper-limit value	OFF
Test time	5.0 s
Delay time	0.5 s

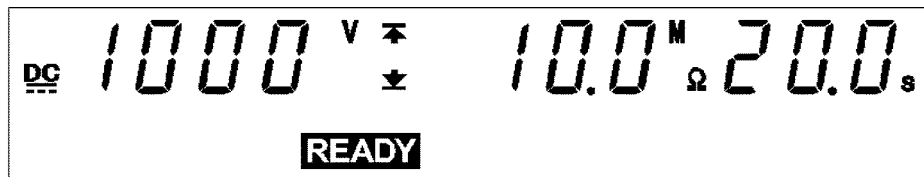

(1) Changing to the SETTING state

Press the ◀/▶ keys to switch to the SETTING state. The **READY** light will go out, and the flashing cursor will be displayed at the position where the test-voltage value is indicated.

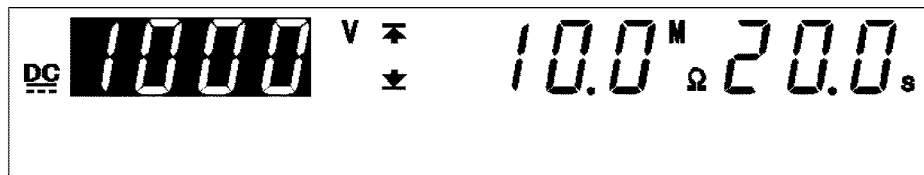

(2) Setting the test-voltage value

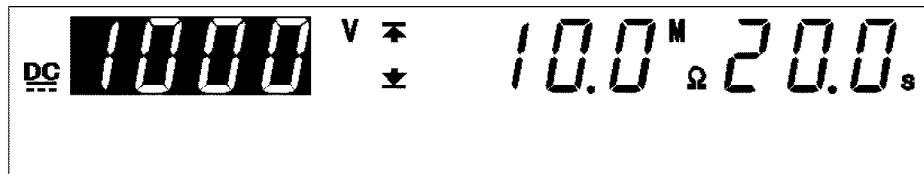

In this example, the value is 1000 V.

Using the ▼/▲ keys, set the comparative voltage value to 500 V.

To change the value by 10 V, press **SHIFT + ▼/▲** keys.

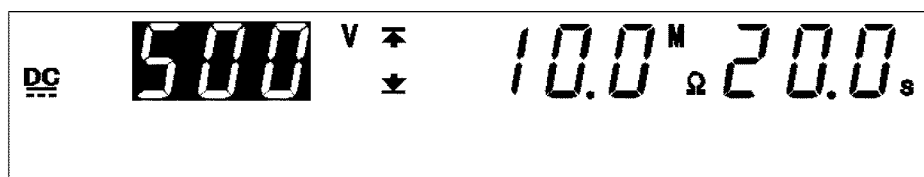

(3) Setting an lower-limit value

Press the ► key to move the flashing cursor to the lower-limit value.

In this example, switch from 10.0 MΩ to 100 MΩ using the ▼/▲ keys.

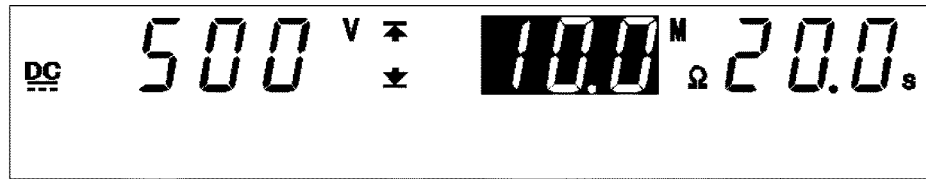

To change the lower-limit value, press ▼/▲ keys.

Press the keys, **SHIFT + ▼/▲** key. The value increases or decreases 10 times more rapidly than when the **SHIFT** key is not held down.

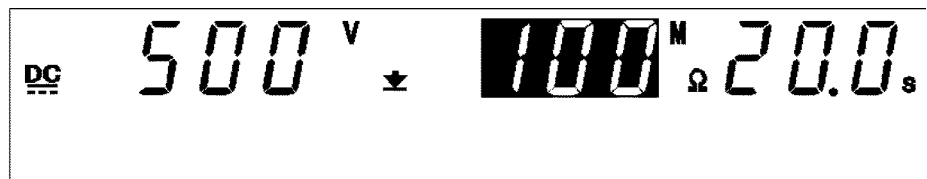

(4) Setting an upper-limit value

Using the ► key, move the flashing cursor to the upper-limit value.



The upper-limit value is set at 2000 MΩ. Turn it **OFF**, as it is not needed. To change to **OFF**, press the **ON/OFF** key.

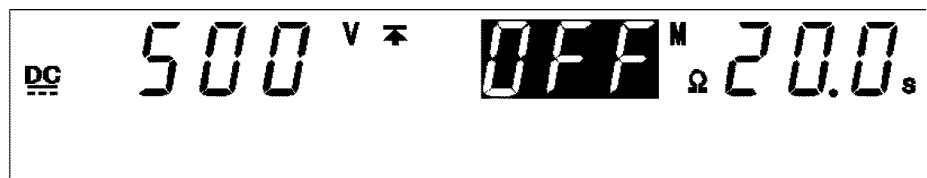

(5) Setting the test time

Using the ► key, move the flashing cursor to the test time.

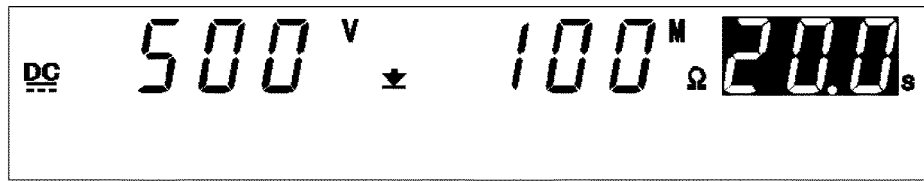

In this example, change the test time from 20.0 s to 5.0 s.

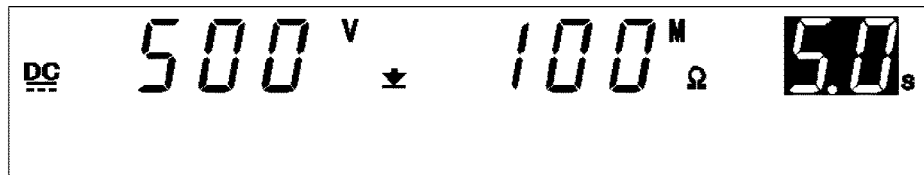

(6) Setting the delay time

Using the ► key, move the flashing cursor to the delay time. (DELAY lamp is lit.)

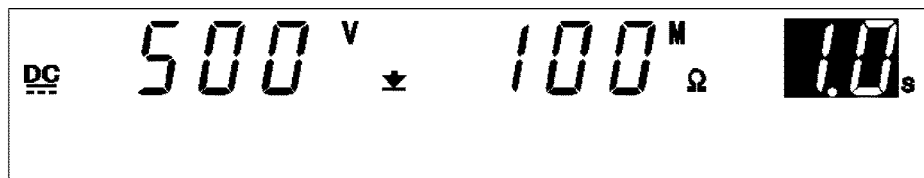

In this example, change the test time from 1.0 s to 0.5 s.

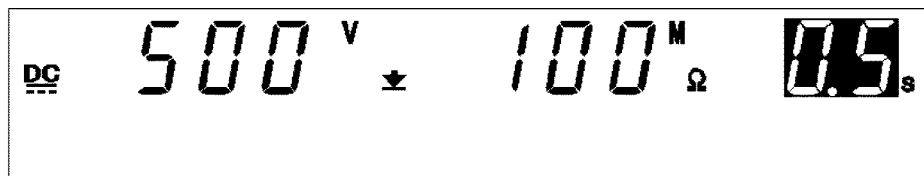

(7) Changing to the READY state

To return to the READY state, press the **STOP** key, which will finalize the test settings.

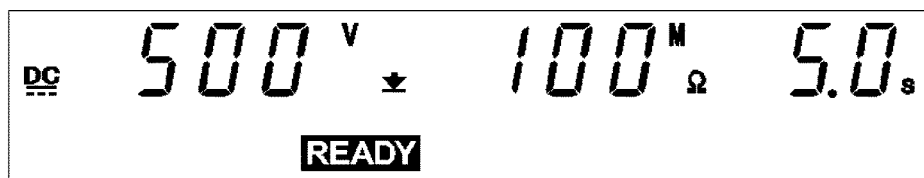

The new parameters following setting are shown below:

Test-voltage value: 500 V
 Lower-limit value: 100 MΩ
 Upper-limit value: OFF
 Test time: 5.0 s
 Delay time: 0.5 s

4.4 Starting a Test

The flowchart below explains how a test is carried out.

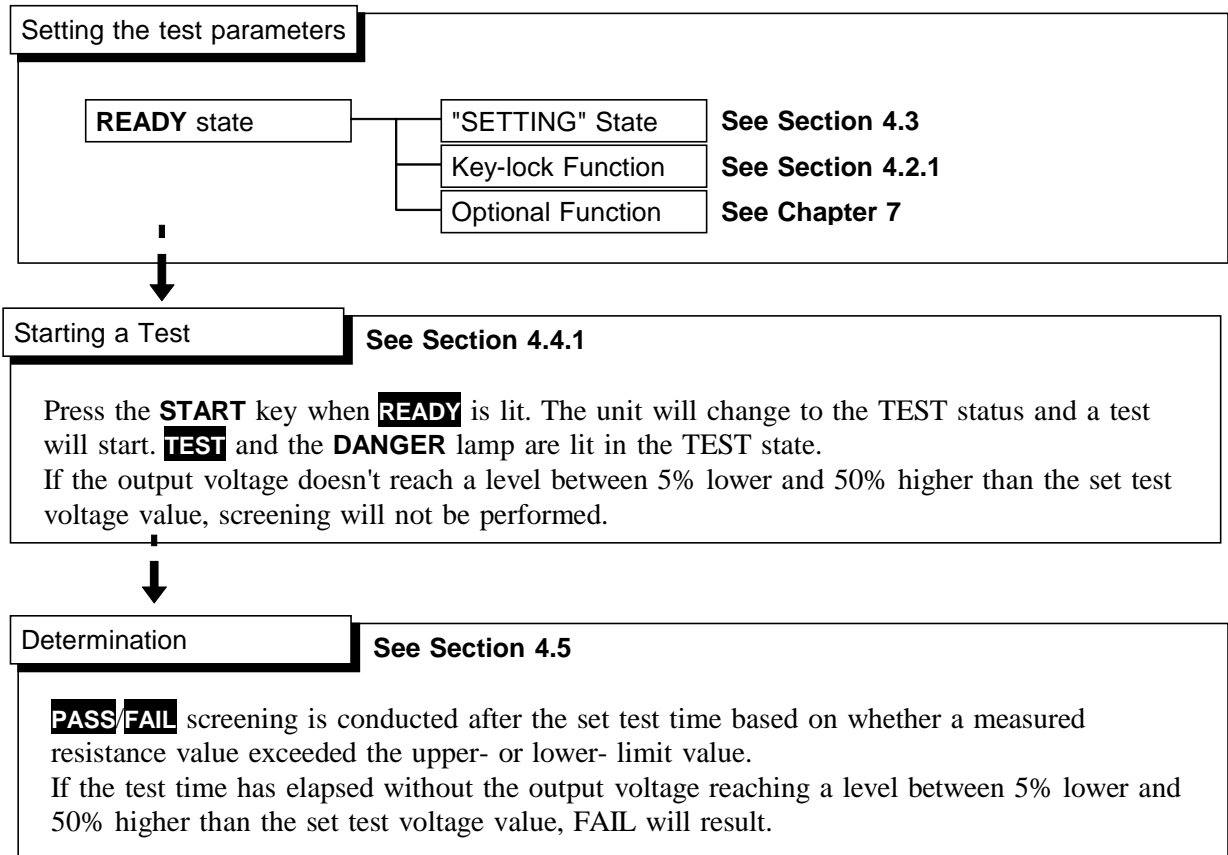

4.4.1 Executing a Test



To avoid electric shock, make sure that no high voltage is being applied to the output, confirm the following items, and output voltage.

- (1) The analog voltmeter reads 0 kV.
- (2) The **DANGER** lamp is OFF.
- (3) The **READY** lamp is lit (it is off in the Double Action mode).



Priority for control of the **START** key is in the following order: the **START** key on the REMOTE CONTROL BOX, the external I/O, and the front panel of the unit. Connecting the switch signal line plug on the REMOTE CONTROL BOX disables the **START** key on the front panel of the unit and the start signal for the external I/O.

1. Press the **START** key when **READY** is lit.

The unit will change to the TEST status and a test will start. **TESAT** and the **DANGER** lamp are lit in the TEST state.

2. In either of the cases below, the test will be terminated and **UPPER**, **LOWER**, or **FAIL** will light.

- About 1 second after the test has started, the output voltage is still lower than 1/2 of the set test voltage.
- The test time has elapsed without the output voltage reaching a level between 5% lower and 50% higher than the set test voltage value.
- Output voltage during testing differs from the test voltage value and does not fall within the range 80% to 150% of the voltage setting.

3. To terminate the test, press the **STOP** key. The unit will immediately stop outputting a voltage and switch to the READY state. In such a case, no screening is conducted.



- During the delay, the **UP/DELAY** lamp lights. (However, it does not light during time testing when insulation-resistance test termination mode is set to 0 [initial setting].)
- In addition to using the **STOP** key on the unit, a stop can be forced using the **STOP** key on the remote-control box or by using a STOP signal via external input/output.
- Conditions under which testing cannot start:
When using settings similar to the following, testing cannot start even when the **START** key is pressed. (Flashing items vary by setting.)

Flashing	Setting
Resistance value and test time	Auto range is selected, Test time is set to On (See Section 7.10)
Testing upper-/lower-limit values	Testing lower-limit value testing upper-limit value
Test time	Delay time test time
Measured voltage value	Output voltage restricting value (optional function) < testing voltage value (See Section 7.9)

Optional Functions

The Hold function can be used to hold the value that was effective at the time of forced termination of the test. (See Section 7.3)

4.4.2 Screening in "TEST" State

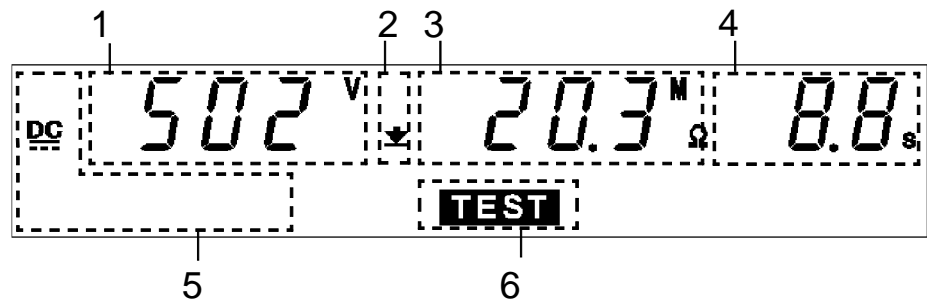

1	Measured voltage value	Indicates the voltage value being output.
2	Upper-limit value icon and Lower-limit value icon	The symbol \uparrow appears when the upper-limit value is set, and the symbol \downarrow appears when the lower-limit value is set.
3	Measured resistance value	Represent the value of a resistance flowing between the HIGH and LOW terminals.
4	Test time elapsed	<ul style="list-style-type: none"> When the testing time is set, countdown starts from the time set, and is displayed. When the testing time is set to OFF, the time elapsed after the start of the test is displayed. If the elapsed test time exceeds 999 s, "---" is displayed, but the voltage continues to be output.
5	Test-voltage type	Indicates the test type (DC).
6	TEST	Remains lit during the test.

Danger lamp

Indicates that a voltage is being output. The lamp stays on during the test. In the insulation-resistance mode, this lamp remains lit even after completion of the test, if a voltage higher than the safety voltage (approximately DC 60 V) has flowed between output terminals.

Analog voltmeter

Indicates the voltage value being output.

External I/O

The timing when the TEST signal is turned ON is the same as the timing when **TEST** on the fluorescent indicator lights up (or flashes). The timing when the H.V.ON signal is turned on is the same as when the **DANGER** lamp lights up. The two signals are turned OFF at the same time.

Upon startup of the test, although **TEST** flashes until the output voltage reaches the set test voltage, the TEST signal is ON.

Optional Functions

Setting can be performed so that the TEST signal will be OFF while **TEST** flashes. See Section 7.15.

4.5 "PASS" or "FAIL" Determination

4.5.1 "PASS" State



Even when a test has been terminated, there may still be voltage in the output-voltage terminal. Before touching the output-voltage terminal, H.V. TEST LEAD, or tested object, make sure that no high voltage is being applied to the output, confirm the following items.

- (1) The analog voltmeter reads 0 kV.
 - (2) The **DANGER** lamp is OFF.
 - (3) The **READY** lamp is lit (it is off in the Double Action mode).
-

- When the set time has elapsed, if the measured resistance value lower - limit value or upper-limit value, the unit will change to the PASS state. As soon as the unit switches to the PASS state, it stops outputting voltage.
- If the test time has not been set, PASS screening is not performed. To the test, press the **STOP** key, which will forcibly terminate the test.
- If the output voltage doesn't reach a level between 5% lower and 50% higher than the set test voltage value, screening will not be performed.

Optional Functions

- The PASS state is held using the PASS Hold function. (See Section 7.1)
- If the test time is set, the test can be forcibly terminated when the measured resistance value enters the PASS range before the preset time has elapsed. This is convenient when testing objects that contains capacity loads. (See Section 7.11)

Flow of PASS determination

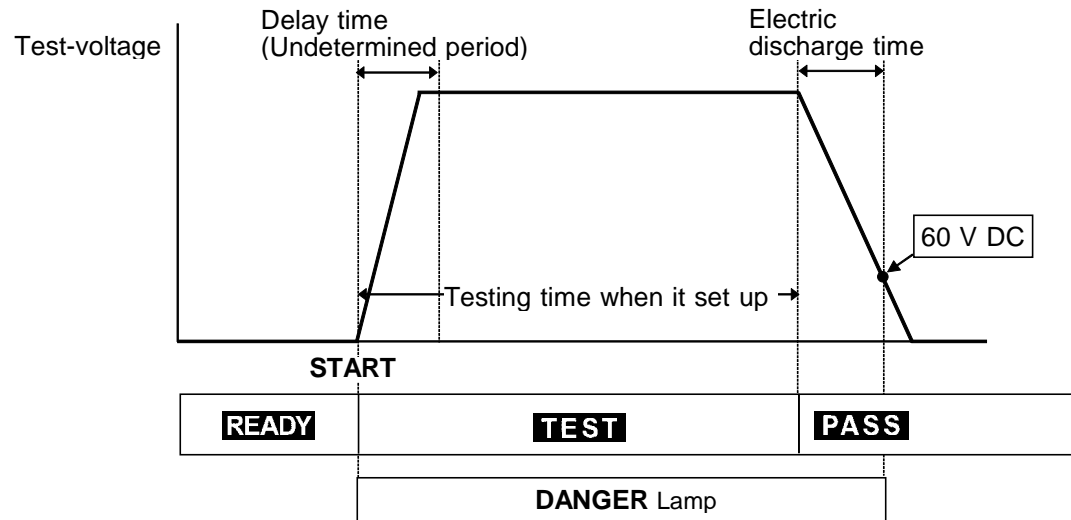

1. Press the **START** key to start a test.
2. A voltage is output until the test time elapses and the resistance is measured.
3. When the preset test time has elapsed and the measured resistance value is within the upper- and lower-limit values, the unit stops outputting a voltage and switches to the PASS state. **PASS** lights up in the PASS state.

4.5.2 Screening in "PASS" State

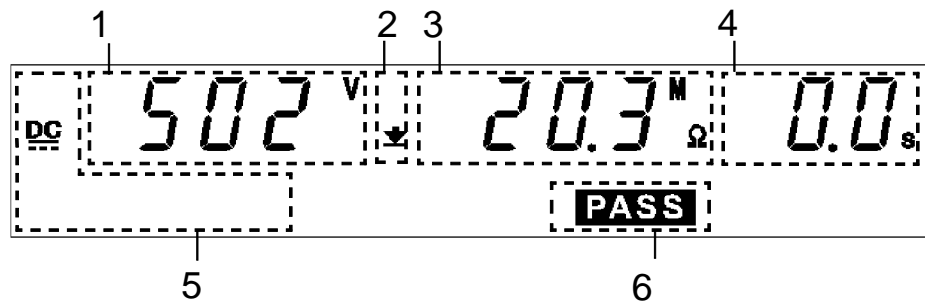

1	Measured voltage value	Indicates the voltage in the PASS state.
2	Upper-limit value icon and Lower-limit value icon	The symbol \blacktriangle appears when the upper-limit value is set, and the symbol \blacktriangledown appears when the lower-limit value is set.
3	Measured resistance value	Indicates the measured resistance value in the PASS state.
4	Test time elapsed	"0.0s" is displayed.
5	Test-voltage type	Indicates the test type (DC).
6	PASS	Indicates that the unit is in the PASS state.

Danger lamp

Indicates that a voltage is being output. The lamp stays on during the test. In the insulation-resistance mode, the lamp will also light if a voltage exceeding the safety voltage (approximately DC 60 V) remains between the output terminals after the test has been completed.

Analog voltmeter

Indicates the voltage value being output. Even when values are held using the "PASS hold function," the value of the analog voltmeter is not held.

External I/O

The **PASS** signal is turned ON when **PASS** on the fluorescent indicator is lit. As long as the PASS state is held, the PASS signal remains ON. The PASS signal is turned OFF when the **PASS** light on the fluorescent indicator goes out.

If voltage remains in the output-voltage terminal following termination of a test, the H.V.ON signal remains ON. When the **DANGER** lamp goes out, H.V.ON signal is immediately turned OFF.

4.5.3 "FAIL" State



Even when a test has been terminated, there may still be voltage in the output-voltage terminal. Before touching the output-voltage terminal, H.V. TEST LEAD, or tested object, make sure that no high voltage is being applied to the output, confirm the following items.

- (1) The analog voltmeter reads 0 kV.
- (2) The DANGER lamp is OFF.
- (3) The **READY** lamp is lit (it is off in the Double Action mode).

When the preset test time has elapsed, the unit switches to the FAIL state and immediately stops outputting a voltage if the measured resistance value deviates from the upper or lower-limit value during the test.

The FAIL state can be divided into UPPER FAIL and LOWER FAIL states. If the output voltage doesn't reach a level between 5% lower and 50% higher than the set test voltage value, screening will not be performed.

UPPER FAIL	The measured resistance has exceeded the upper-limit value.
LOWER FAIL	The measured resistance has dropped below the lower-limit value.

If the test time has elapsed without the output voltage reaching a level between 5% lower and 50% higher than the set test voltage value or if the voltage deviates largely from the set voltage value, FAIL will result. **UPPER**, **LOWER** or **FAIL** will light.

(When the upper-limit value is set to OFF, UPPER FAIL is ineffective.)

If the test time has not been set, PASS screening is not performed. To the test, press the **STOP** key, which will forcibly terminate the test.

Optional Functions

- The FAIL state is held using the FAIL Hold function. (See Section 7.2)
- If the test time is set, the test can be forcibly terminated when the measured resistance value enters the PASS range before the preset time has elapsed. This is convenient when testing objects that contains capacity loads. (See Section 7.11)

Flow of FAIL determination

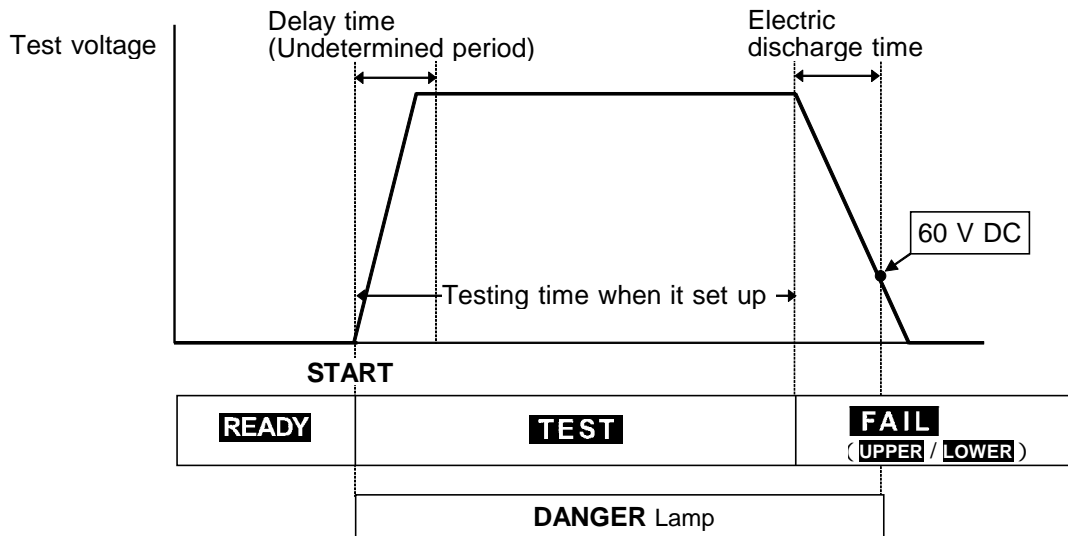

1. Press the **START** key to start a test.
2. A voltage continues to be output until the test time elapses and measure resistance.
3. When the preset test time has elapsed, and the measured resistance value deviates from the upper- or lower-limit value, the unit stops outputting a voltage and switches to the FAIL state. **FAIL** lights up in the FAIL state together with **LOWER** or **UPPER**.

NOTE

- When the optional "Insulation Resistance Measurement Range" function is set to "1: Auto Range", it takes up to 1.5 s to display the resistance value. When the test finishes before the preset test time, the test results in a **UPPER LOWER FAIL**.
- When capacitance is present, the time constant based on the capacitance and resistance values may delay the measurement results.
- Setting an upper-limit value while using a fixed range restricts the range of resistance that can be measured. Therefore, even if a resistance value lower than the preset upper-limit value is measured, "O.F." is displayed resulting in an **UPPER FAIL**. In addition, even when the measured resistance value is higher than the preset lower-limit, "U.F." may be displayed, resulting in a LOWER FAIL. (See Section 4.3.2)

4.5.4 Screening in "FAIL" State

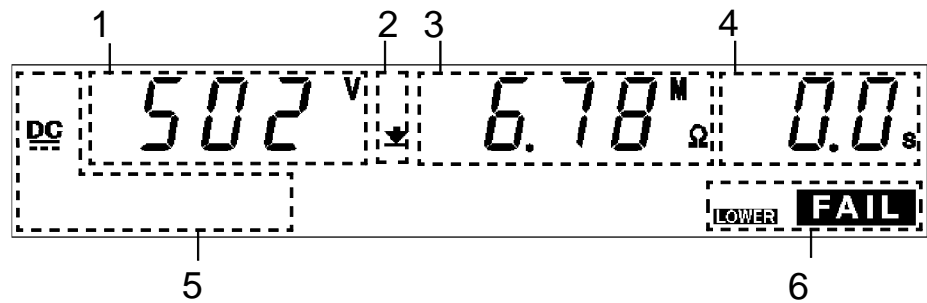

1	Measured voltage value	Indicates the voltage in the FAIL state.
2	Upper-limit value icon and Lower-limit value icon	The symbol \uparrow appears when the upper-limit value is set, and the symbol \downarrow appears when the lower-limit value is set.
3	Measured resistance value	Indicates the measured resistance value in the FAIL state.
4	Test completion time	"0.0s" is displayed.
5	Test-voltage type	Indicates the test type (DC).
6	FAIL	Indicates that the unit is in the FAIL state. FAIL lights up with UPPER to indicate UPPER FAIL, and with LOWER to indicate LOWER FAIL.

Danger lamp

Indicates that a voltage is being output. The lamp stays on during the test. In the insulation-resistance mode, the lamp will also light if a voltage exceeding the safety voltage (approximately DC 60 V) remains between the output terminals after the test has been completed.

Analog voltmeter

Indicates the voltage value being output. Even when values are held using the "FAIL hold function," the value of the analog voltmeter is not held.

External I/O

The I-FAIL signal and either the U-FAIL or L-FAIL signal come on when **FAIL** lights on the fluorescent indicator.

Both the I-FAIL and U-FAIL signals, as well as the L-FAIL signal remain ON as long as the FAIL state is held. The I-FAIL, U-FAIL and L-FAIL signals are turned OFF when the FAIL light on the fluorescent indicator goes out.

If voltage remains in the output-voltage terminal following the termination of a test, the H.V.ON signal remains ON. When the **DANGER** lamp goes out, the H.V.ON signal is immediately turned OFF.

4.6 Automatic Discharge Function

When a test object that contains a capacity component is subjected to a insulation-resistance test, the object might remain electrically charged, thereby causing an electric shock. This unit is equipped with a function to discharge residual electricity upon termination of the insulation-resistance test (discharge resistance: 726 k Ω).

The unit automatically switches to the internal discharge circuit to discharge the test object (the **DANGER** lamp is lit).

When the voltage between the output terminals falls below the safety voltage (approximately DC 60 V), the **DANGER** lamp goes out. The larger the capacity component of the test object, the more time is required to discharge the test object.

NOTE

- The unit does not return to the READY state until the **DANGER** lamp goes out upon completion of the test. Until the unit returns to the READY state, no key operation is accepted.
- With an optional setting, the unit can change to the READY state, regardless of the **DANGER** lamp indication, upon completion of the test (see Section 7.14 START Protection Function).

In such a case, the voltage output terminals may contain residual electricity even when the unit is in the READY state.

Chapter 5

Auto Test Mode Testing Method

This chapter describes how to set auto test mode test conditions and the proper testing procedure.

Read chapter 2, and make the necessary preparations for testing.

This mode has two types:

(1) W→I mode

Tests for withstand voltage, then insulation resistance.

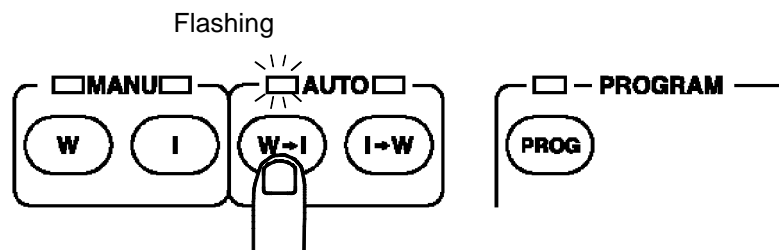

(2) I→W mode

Tests for insulation resistance, then withstand voltage.

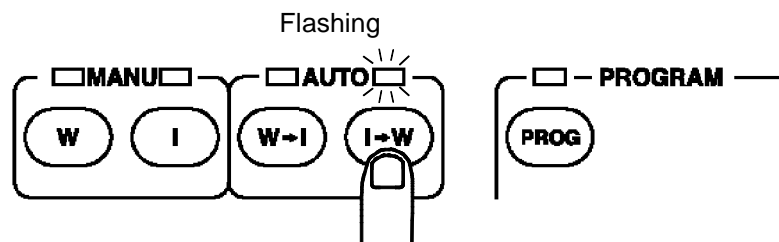

NOTE

- The lamps above the key light. When switching between withstand-voltage and insulation-resistance testing, the W or I lamp lights, respectively.
- Note that the output waveform may be distorted when conducting an AC withstand voltage test for a voltage-dependent device or object (e.g., ceramic capacitor). Excessively large distortion may damage the device or tested object.

5.1 Auto Test Mode Display

READY state

- The unit is ready for starting a test. The **READY** lamp is turned on.
- W→I (Withstand-voltage test → Insulation-resistance test) mode: the unit is in the READY state for withstand-voltage testing.

AC 1.00 kV ∇ 20 mA 60.0 s
50 Hz **READY**

- I→W (Insulation-resistance test → Withstand-voltage test) mode: the unit is in the READY state for insulation-resistance testing.

DC 500 V ∇ 10.0 M Ω 10.0 s
READY

- Press the **START** key while in the READY state.
- Press **SHIFT + STOP** keys to display the Optional Function Setting screen.
- Key-lock Function can be used. (See Section 5.2.1)

W I/I W key

SHIFT + STOP key

Setting optional functions

Setting the optional functions allows testing under various conditions.
(See Chapter 7)

Withstand-voltage mode READY state

- To make test settings, withstand-voltage mode must be in the SETTING state.
- For details on settings, see chapter 3, "Withstand Voltage Mode Testing Method."
- Make sure you set a test time.

Insulation-resistance mode READY state

- To make test settings, insulation-resistance mode must be in the SETTING state.
- For details on settings, see chapter 4, "Insulation Resistance Mode Testing Method."
- Make sure you set a test time.

START key

TEST state

See Section 5.4.2

- When the unit is in the TEST state, the **TEST** lamp is lit. This indicates that a test is in progress.
- When performing a withstand-voltage test, compares the measured voltage value and the measured current value set in withstand-voltage mode SETTING state. If the measured value deviates from either of these values, the unit terminates the test and switches to the FAIL state.
- When performing an insulation-resistance test, compares the measured resistance value and the value set in the insulation-resistance mode SETTING state. If the value deviates from either of these values once the test time has elapsed, the unit shifts to the FAIL state.
- If both the voltage and insulation-resistance tests are passed, the unit switches to the PASS state.
- Press the **STOP** key to forcibly terminate the test.

Key operation in the TEST status

Forced ending

Press the **STOP** key.**5****PASS state**

See Section 5.5.1

- Indicates that both the voltage and insulation-resistance tests were passed. **PASS** lights up.
- The **PASS** lamp is turned on. The PASS state screen is displayed for about 0.3 second before switching to the READY state.
- The PASS state can be maintained if the PASS Hold function is disabled in the optional settings. (See Section 7.1)

FAIL state

See Section 5.5.3

- Indicates that either the withstand-voltage or insulation-resistance test was failed.
- When performing a withstand-voltage test, if the measured current value deviates from the upper-limit value, **UPPER** and **FAIL** light up. If the measured current value deviates from the lower-limit value, **LOWER** and **FAIL** light up.
- When performing an insulation-resistance test, if the measured resistance value deviates from the lower-limit value, **LOWER** and **FAIL** light up. If the resistance value deviates from the upper-limit value, **UPPER** and **FAIL** light up.
- The FAIL state can be maintained. To return to the READY state, press the **STOP** key, which will cancel the FAIL Hold function.
- FAIL Hold function can be disabled in the optional settings. The FAIL-state screen is displayed for 0.3 seconds, and the unit then switches to the READY state. (See Section 7.2)

5.2 Displaying the "READY" State

In the READY state, the unit is always ready to start a test. The **READY** lamp remains lit to indicate the READY state.

You can make settings for each test type in a variety of modes. (See chapter 3 and chapter 4)

The settings for W→I mode are the same as those for withstand-voltage mode. (See Section 3.2)



The settings for I→W mode are the same as those for insulation-resistance mode. (See Section 4.2)

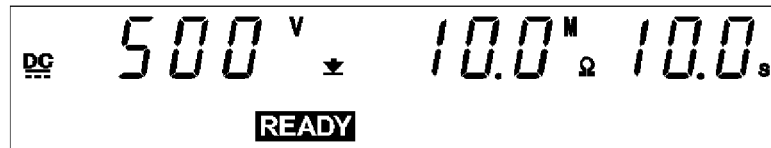

Danger lamp

Indicates that a voltage is being output. This lamp remains lit as long as a voltage is being applied to the output terminal. It does not light up in the READY state.

Analog voltmeter

Indicates the voltage value being output in withstand-voltage test. In the READY state, the value remains at 0 kV.

External I/O

The READY signal is ON when **READY** is lit on the fluorescent indicator. The READY signal is turned OFF when **READY** is not lit.

Key Operations

SHIFT + STOP	Displays the Optional functions setting screen. (See Chapter 7)
START	Test Start (See Section 5.4)
LOCK	Key-lock function (See Section 5.2.1)

5.2.1 Key-lock Function

It inactivates all keys except the **START** key, **STOP** key, and the range switch. The **KEYLOCK** lamp is lit while the key-lock function is active. Use this function when you do not want to change the test mode or test settings.

To switch to the KEY-LOCK state, press the **LOCK** key. The **KEYLOCK** lamp is lit.

To cancel the key-lock function, press the **LOCK** key in the KEY-LOCK state while holding down the **SHIFT** key. The **KEYLOCK** lamp is not lit.

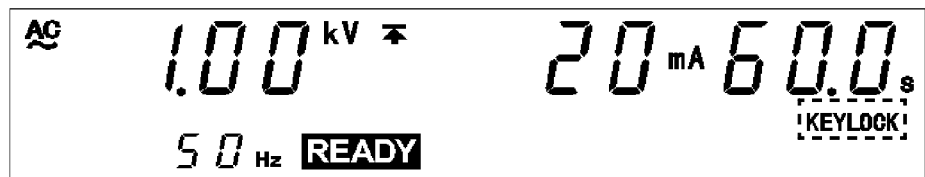

NOTE

Even when the key-lock function is activated, the **START** and **STOP** keys on the REMOTE CONTROL BOX and the start and stop signals on the external I/O terminal remain active.

5.3 "SETTING" State



In Auto test mode, test settings cannot be changed. To change test settings, the withstand-voltage and insulation-resistance modes must be in the SETTING state. (See Section 3.3 and 4.3)

After you have made the various test settings, select Auto test mode.

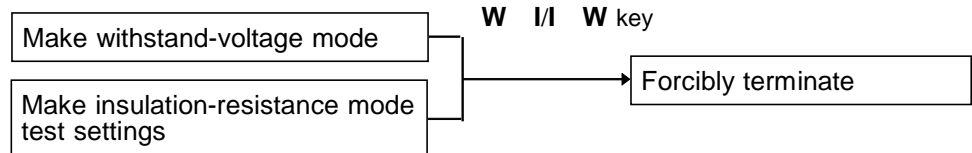

If you try to start a test in the Auto test mode, the test mode when the test time is switched **OFF** is displayed (**OFF** flashes), and the test cannot be started.

NOTE

- If the test time is set to OFF in the withstand-voltage mode or insulation-resistance mode, the test mode with its time set to **OFF** is displayed (**OFF** flashes) upon startup of the test in the Auto test mode, and the test cannot be started. Return to withstand-voltage or insulation-resistance mode, and set the test time to **ON**.
- If the set lower-limit value upper-limit value, an item of comparative value flashes upon startup of the test, and the test cannot be started.
- In the insulation-resistance mode, if the set delay time test time, time-setting items flash upon startup of the test, and the test cannot be started.
- Note that the unit does not start test if the test-voltage value is greater than the output-voltage restricting value. See Section 7.9.

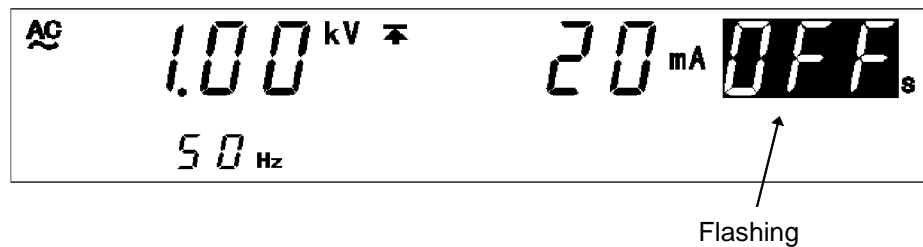

5.4 Starting a Test

The flowchart below explains how a test is carried out.

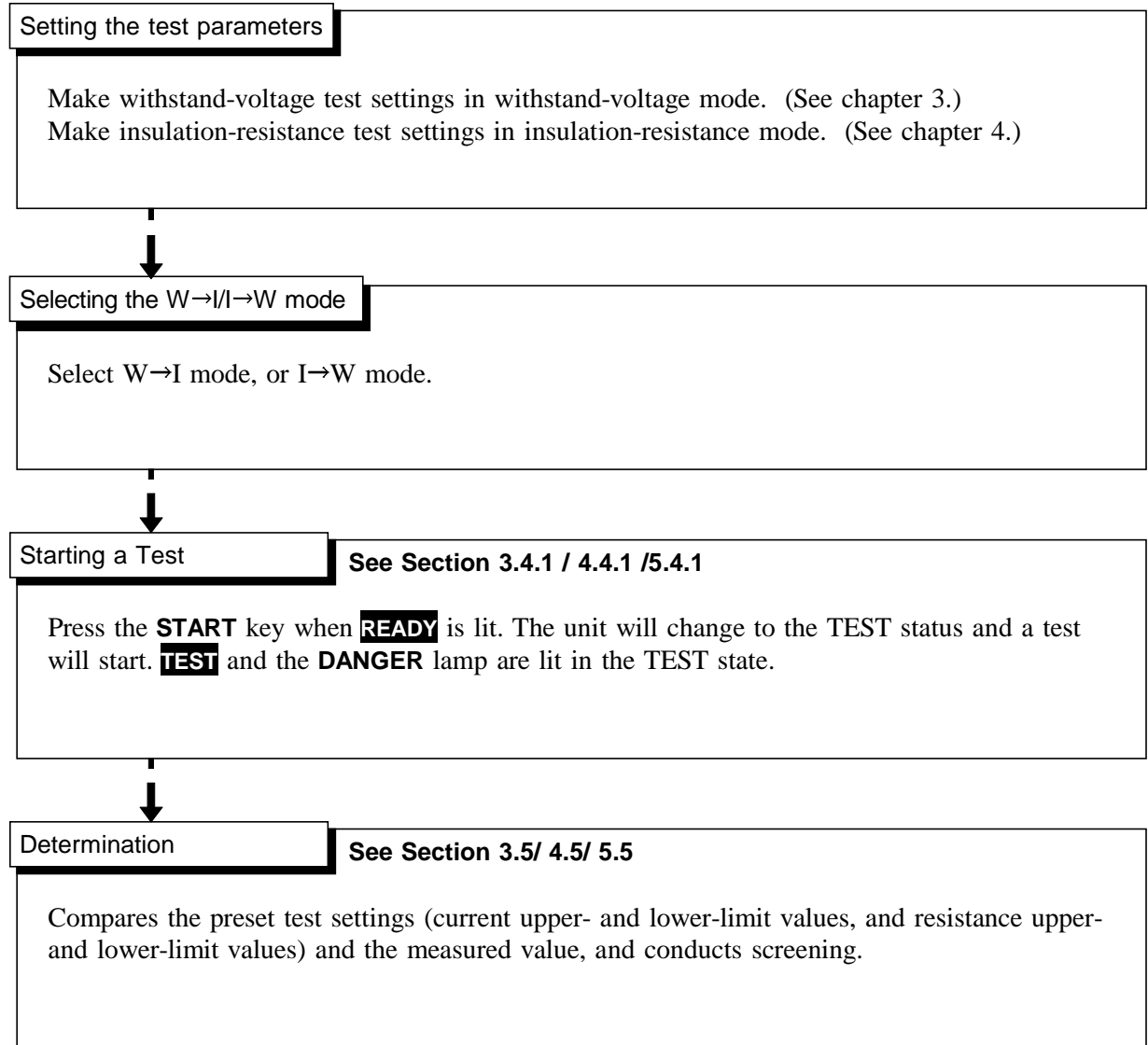

5.4.1 Executing a Test



To avoid electric shock, make sure that no high voltage is being applied to the output, confirm the following items, and output voltage.

- (1) The analog voltmeter reads 0 kV.
- (2) The **DANGER** lamp is OFF.
- (3) The **READY** lamp is lit (it is off in the Double Action mode).



Priority for control of the **START** key is in the following order: the **START** key on the REMOTE CONTROL BOX, the external I/O, and the front panel of the unit. Connecting the switch signal line plug on the REMOTE CONTROL BOX disables the **START** key on the front panel of the unit and the start signal for the external I/O.

1. Press the **START** key when **READY** is lit.
The unit will change to the TEST status and a test will start. **TEST** and the **DANGER** lamp are lit in the TEST state.
2. In either of the cases below, the test will be terminated and **UPPER**, **LOWER**, or **FAIL** will light.

When performing a withstand-voltage test:

- The output voltage doesn't reach the set test voltage value $\pm 5\%$.
- The output voltage deviates from the test voltage value during the test and doesn't return to the set value ± 1 dgt. within 5 seconds.

When performing an insulation-resistance test:

- About 1 second after the test has started, the output voltage is still lower than 1/2 of the set test voltage.
- The test time has elapsed without the output voltage reaching a level between 5% lower and 50% higher than the set test voltage value.
- Output voltage during testing differs from the test voltage value and does not fall within the range 80% to 150% of the voltage setting.

*See Section 3.4.1 / 4.4.1

3. To terminate the test, press the **STOP** key. The unit will immediately stop outputting a voltage and switch to the READY state. In such a case, no screening is conducted.



- The **UP/DELAY** lamp lights during withstand-voltage testing ramp-up and during insulation-resistance testing delays. (However, it does not light during time testing when insulation-resistance test termination mode is set to 0 [initial setting].)
- The **DOWN** lamp lights during withstand-voltage testing ramp-down.

Optional Functions

- The Hold function can be used to hold the value that was effective at the time of forced termination of the test. (See Section 7.3)
- If the **W** or **I** key is pressed when the Hold function is enabled, you can view the next test result.

5.4.2 Screening in "TEST" State



(1) When performing a withstand-voltage test:

Similar to the withstand-voltage mode TEST state. (See Section 3.4.2)



(2) When performing an insulation-resistance test:

Similar to the insulation-resistance mode TEST state. (See Section 4.4.2)

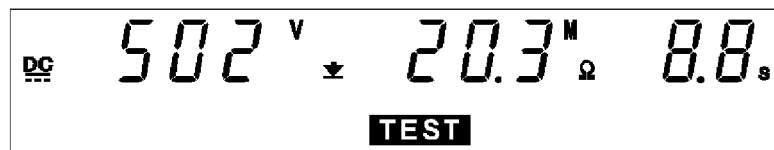

Danger lamp

Indicates that a voltage is being output. The lamp stays on during the test. This lamp remains lit even after completion of the test, if a voltage higher than the safety voltage (approximately AC 0.03 kV (AC withstand-voltage test) or approximately DC 60 V (DC withstand-voltage test or insulation-resistance test) has flowed between output terminals.

Analog voltmeter

Indicates the voltage value being output.

External I/O

The timing when the TEST signal is turned ON is the same as the timing when **TEST** on the fluorescent indicator lights up (or flashes). The timing when the H.V.ON signal is turned on is the same as when the **DANGER** lamp lights up. The two signals are turned OFF at the same time.

Upon startup of the test, although **TEST** flashes until the output voltage reaches the set test voltage or during the ramp-up time, the TEST signal is ON.

Optional Functions

Setting can be performed so that the TEST signal will be OFF while **TEST** flashes. See Section 7.15.

5.5 PASS or FAIL Determination

5.5.1 "PASS" State



Even when a test has been terminated, there may still be voltage in the output-voltage terminal. Before touching the output-voltage terminal, H.V. TEST LEAD, or tested object, make sure that no high voltage is being applied to the output, confirm the following items.

- (1) The analog voltmeter reads 0 kV.
 - (2) The DANGER lamp is OFF.
 - (3) The **READY** lamp is lit (it is off in the Double Action mode).
-

When the preset test time has elapsed, the unit switches to the PASS state and immediately stops outputting a voltage.

During the insulation-resistance test, if the output voltage doesn't reach a level between 5% lower and 50% higher than the set test voltage value, screening will not be performed.

Optional Functions

- The PASS state is held using the PASS Hold function. (See Section 7.1)
- If the **W** or **I** key is pressed when the Hold function is enabled, you can view the next test result.

Flow of PASS determination W→I mode

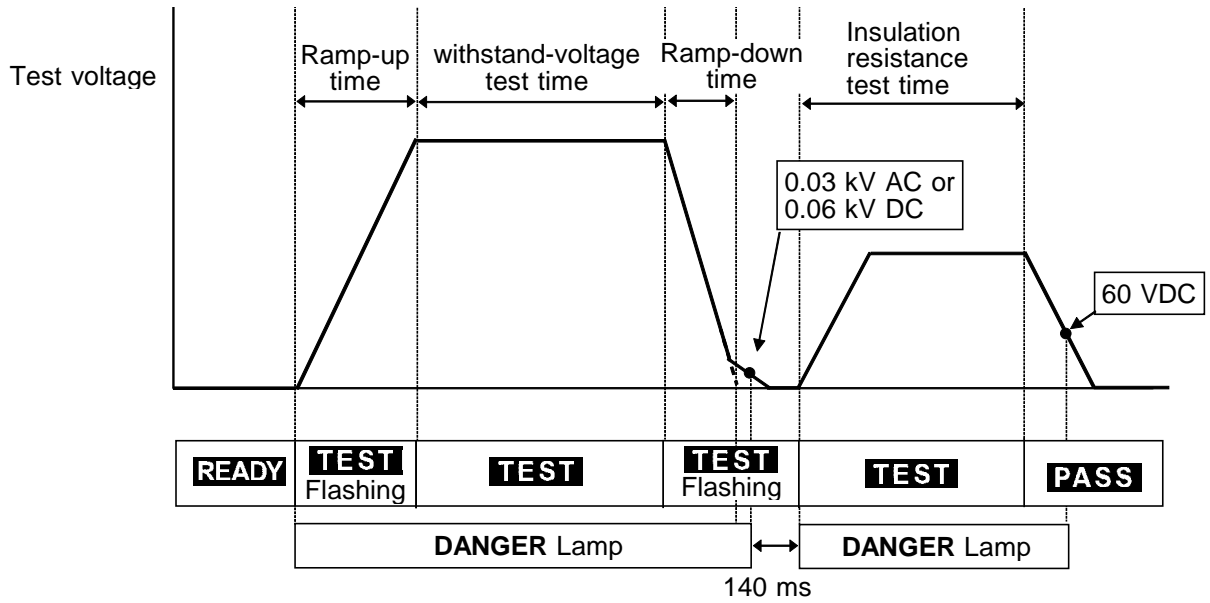

I→W mode

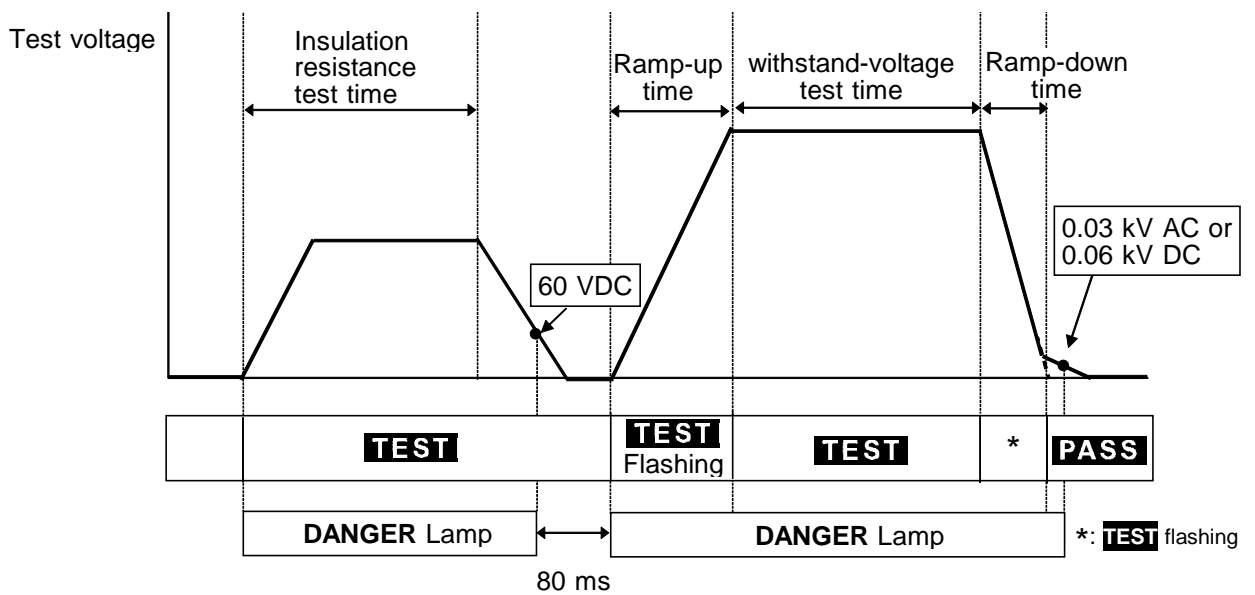

1. Press the **START** key to start a test.
2. In W→I mode, the test order is Withstand-voltage test → Insulation-resistance; in I→W mode, the test order is Insulation-resistance test → Withstand-voltage test.
3. If both tests clear the test settings, the unit stops outputting a voltage and switches to the PASS state. **PASS** lights up in the PASS state.

5.5.2 Screening in "PASS" State

(1) W→I mode

Similar to the insulation-resistance mode TEST state. (See Section 4.5.2)

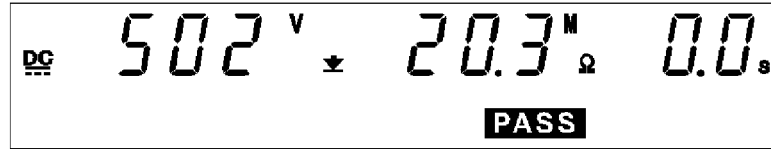

(2) I→W mode

Similar to the withstand-voltage mode TEST state. (See Section 3.5.2)

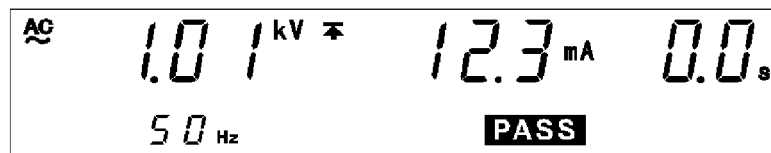

Danger lamp

Indicates that a voltage is being output. The lamp stays on during the test. The lamp will also light if a voltage exceeding the safety voltage (approximately AC 0.03 kV (AC withstand-voltage test)) or approximately DC 60 V (DC withstand-voltage test or insulation-resistance test) remains between the output terminals after the test has been completed.

Analog voltmeter

Indicates the voltage value being output. Even when values are held using the "PASS hold function," the value of the analog voltmeter is not held.

External I/O

The PASS signal is turned ON when **PASS** on the fluorescent indicator is lit. As long as the PASS state is held, the PASS signal remains ON. The PASS signal is turned OFF when the **PASS** light on the fluorescent indicator goes out. If voltage remains in the output-voltage terminal following termination of a test, the H.V.ON signal remains ON. When the **DANGER** lamp goes out, the H.V.ON signal is immediately turned OFF. If the voltage drops below 0.03 kVAC or below 60 VDC, the **DANGER** lamp goes out.

5.5.3 "FAIL" State



Even when a test has been terminated, there may still be voltage in the output-voltage terminal. Before touching the output-voltage terminal, H.V. TEST LEAD, or tested object, make sure that no high voltage is being applied to the output, confirm the following items.

- (1) The analog voltmeter reads 0 kV.
- (2) The DANGER lamp is OFF.
- (3) The **READY** lamp is lit (it is off in the Double Action mode).

If the measured voltage deviates from the upper or lower value during the test, the unit switches to the FAIL state and immediately stops outputting a voltage. The FAIL state can be divided into UPPER FAIL and LOWER FAIL states. During the insulation-resistance test, if the output voltage doesn't reach a level between 5% lower and 50% higher than the set test voltage value, screening will not be performed.

Withstand voltage test

UPPER FAIL	The measured current has exceeded the upper-limit value.
LOWER FAIL	The measured current has dropped below the lower-limit value. (When the lower-limit value is set to OFF, LOWER FAIL is ineffective.)

If the output voltage doesn't reach the set test voltage value $\pm 5\%$ or if the voltage deviates from the set voltage value, FAIL will result. **UPPER**, **LOWER** or **FAIL** will light.

Insulation resistance test

UPPER FAIL	The measured resistance has exceeded the upper-limit value. (When the upper-limit value is set to OFF, UPPER FAIL is ineffective.)
LOWER FAIL	The measured resistance has dropped below the lower-limit value.

If the test time has elapsed without the output voltage reaching a level between 5% lower and 50% higher than the set test voltage value or if the voltage deviates largely from the set voltage value, FAIL will result. **UPPER**, **LOWER** or **FAIL** will light.

Optional Functions

- The FAIL state is held using the FAIL Hold function. (See Section 7.2)
- If the **W** or **I** key is pressed when the Hold function is enabled, you can view the next test result.

Flow of FAIL determination

1. Press the **START** key to start a test.
2. Perform a withstand-voltage and insulation-resistance test.
3. When the measured current or measured resistance values deviate from the preset test settings, the unit stops outputting a voltage and switches to the FAIL state. **FAIL** lights up in the FAIL state together with **LOWER** or **UPPER**.

NOTE

- If a current double to the preset upper-limit value is detected while performing a withstand-voltage test, the voltage is immediately blocked by the insulation circuit, resulting in an UPPER FAIL. In such cases, the measured current value is not displayed correctly.
- When the optional "Insulation Resistance Measurement Range" function is set to "1: Auto Range", it takes up to 1.5 s to display the resistance value. When the test finishes before the preset test time, the test results in a UPPER LOWER FAIL.
- Setting an upper-limit value while using a fixed range restricts the range of resistance that can be measured. Therefore, even if a resistance value lower than the preset upper-limit value is measured, "O.F." is displayed resulting in an UPPER FAIL. In addition, even if the measured resistance value is higher than the preset lower-limit value, "U.F." may be displayed, resulting in a LOWER FAIL. (See Section 4.3.2)
- Insulation resistance test termination mode is enabled only in I mode. In Auto test mode or Program test mode, in which Insulation resistance test termination mode is disabled, the unit shifts to the FAIL state and the test is terminated. To make the unit operate in the same way as that with a timer test termination function enabled, set a delay time.

Example of setting

For the test time of 1.0 s, set the delay time to 0.9 s.

Because screening is performed for 0.1 s, the unit operates in the same way as a timer termination.

5.5.4 Screening in "FAIL" State

(1) When performing a withstand-voltage test:

Similar to the withstand-voltage mode TEST state. (See Section 3.5.4)

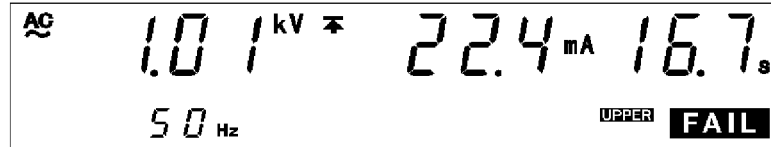

(2) When performing an insulation-resistance test:

Similar to the insulation-resistance mode TEST state. (See Section 4.5.4)

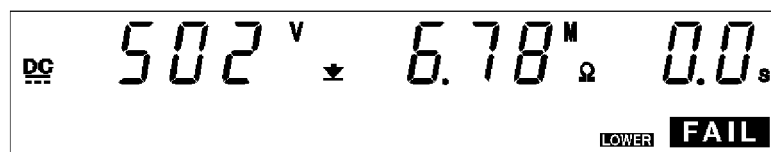

Danger lamp

Indicates that a voltage is being output. The lamp stays on during the test. The lamp will also light if a voltage exceeding the safety voltage (approximately AC 0.03 kV (AC withstand-voltage test)) or approximately DC 60 V (DC withstand-voltage test or insulation-resistance test) remains between the output terminals after the test has been completed.

Analog voltmeter

Indicates the voltage value being output. Even when values are held using the "FAIL hold function," the value of the analog voltmeter is not held.

External I/O

The W-FAIL or I-FAIL signals are turned on when FAIL appears on the fluorescent indicator, and the U-FAIL or L-FAIL signals also. The W-FAIL signal or the I-FAIL, U-FAIL, and L-FAIL signals are turned OFF when FAIL goes out on the fluorescent indicator. If voltage remains in the output-voltage terminal following the termination of a test, the H.V.ON signal remains ON. When the DANGER lamp goes out, the H.V.ON signal is immediately turned OFF.

5.6 Automatic Discharge Function

When a test object that contains a capacity component is subjected to a withstand-voltage test and insulation-resistance test, the object might remain electrically charged, thereby causing an electric shock. This unit is equipped with a function to discharge residual electricity upon termination of the withstand-voltage test (discharge resistance: 726 k Ω).

The unit automatically switches to the internal discharge circuit to discharge the test object (the **DANGER** lamp is lit).

When the voltage between the output terminals falls below the safety voltage (approximately AC 0.03 kV or DC 60 V), the **DANGER** lamp goes out. The larger the capacity component of the test object, the more time is required to discharge the test object.

NOTE

- In W → I mode, the insulation-resistance test does not start up if the voltage between the output terminals has not fallen below the safety voltage (approximately AC 0.03 kV [AC insulation-resistance test] or approximately DC 60 V [DC insulation-resistance test]) upon completion of the withstand-voltage test.
- In I → W mode, the withstand-voltage test does not start until the voltage between the output terminals has fallen below the safety voltage (approximately DC 60 V) upon completion of the insulation-resistance test.
- The test is terminated and the unit does not shift to the READY state until the **DANGER** lamp goes out. Furthermore, all key operations are invalid until the unit returns to the READY state.
- With an optional setting, the unit can change to the READY state, regardless of the **DANGER** lamp indication, upon completion of the test (See Section 7.14). In such a case, the voltage output terminals may contain residual electricity even when the unit is in the READY state.

Chapter 6

Program Mode Testing Method

This chapter describes program setting and testing methods in the program mode.

Read chapter 2, and make the necessary preparations for testing.

Press the **PROG** key to enter program mode. (The lamp above the key lights.)

6

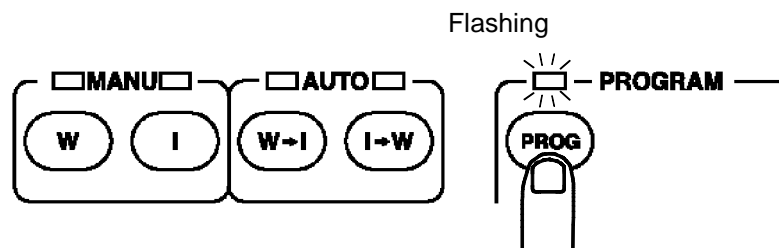
**NOTE**

Note that the output waveform may be distorted when conducting an AC withstand voltage test for a voltage-dependent device or object (e.g., ceramic capacitor). Excessively large distortion may damage the device or tested object.

6.1 Program Mode Display

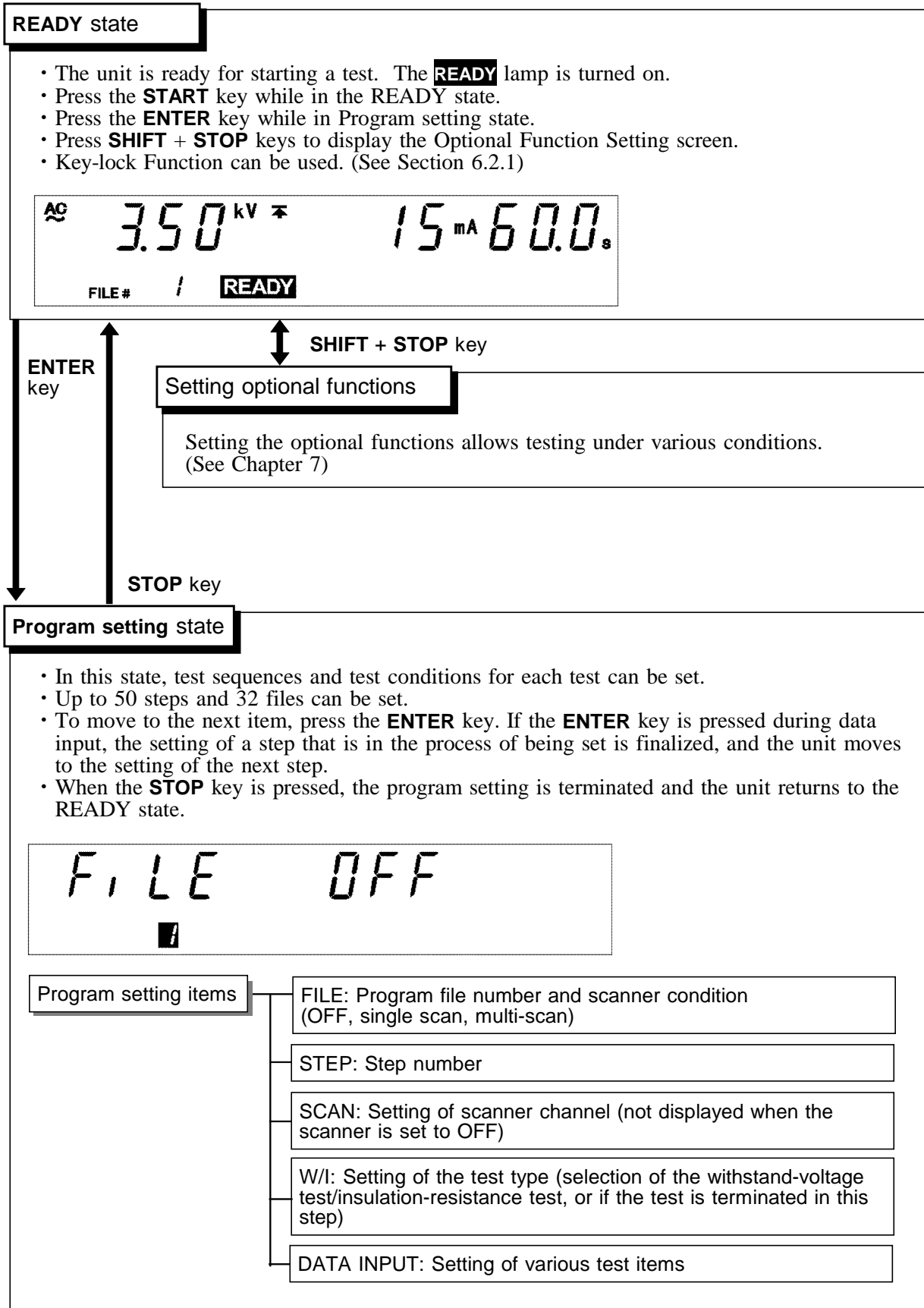

START key

TEST state

See Section 6.5.2

- When the unit is in the TEST state, the **TEST** lamp is lit. This indicates that a test is in progress.
- The measured current and resistance values are compared with the lower-and upper-limit values. If the measured resistance value has deviated from those limit values when the test time has elapsed, the unit switches to the FAIL state. If the measured resistance value has not deviated in any test, the unit switches to the PASS state.
- Press the **STOP** key to forcibly terminate the test.



Key operation in the TEST status

Forced ending

Press the **STOP** key.**PASS state**

See Section 6.6.1

- This state demonstrates that the measured value has passed all programmed tests. **PASS** lights up.
- The **PASS** lamp is turned on. The PASS state screen is displayed for about 0.3 second before switching to the READY state.
- The PASS state can be maintained if the PASS Hold function is disabled in the optional settings. (See Section 7.1)

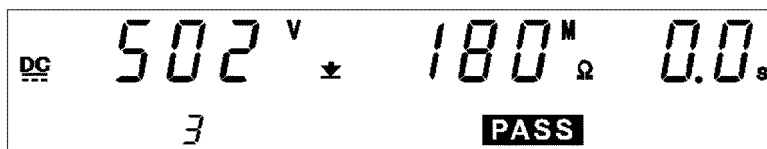
**FAIL state**

See Section 6.6.3

- This state demonstrates that the measured value has not passed the set test conditions.
- When the measured value has deviated from the lower-limit value, **FAIL** lights up along with **LOWER**, and when the measured value has deviated from the upper-limit value, **FAIL** lights up along with **UPPER**.
- The FAIL state can be maintained. To return to the READY state, press the **STOP** key, which will cancel the FAIL Hold function.
- FAIL Hold function can be disabled in the optional settings. The FAIL-state screen is displayed for 0.3 seconds, and the unit then switches to the READY state. (See Section 7.2)

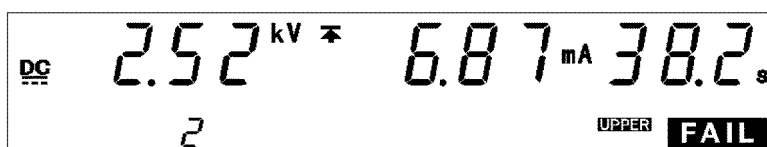

6.2 Displaying the "READY" State

In the READY state, the unit is always ready to start a test. The **READY** lamp remains lit to indicate the READY state.

- When you enter the program mode by pressing the **PROG** key, the step-1 settings of the file that was loaded previously are displayed.
- From this state, you can enter the "program setting state," perform program-file loading, and set optional functions.

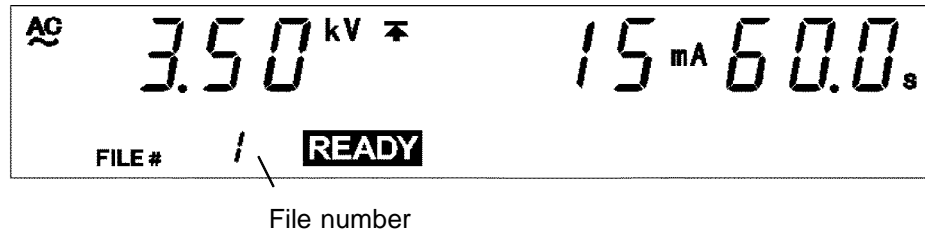

Danger lamp

Indicates that a voltage is being output. This lamp remains lit as long as a voltage is being applied to the output terminal. It does not light up in the READY state.

Analog voltmeter

Indicates the voltage value being output. In the READY state, the value remains at 0 kV.

External I/O

The READY signal is ON when **READY** is lit on the fluorescent indicator. The READY signal is turned OFF when **READY** is not lit.

Key Operations

PG.LOAD	Moves to the program-file loading window. (See Section 6.4)
SHIFT + STOP	Displays the Optional functions setting screen. (See Chapter 7)
START	Test Start (See Section 6.5)
LOCK	Key-lock function (See Section 6.2.1)

6.2.1 Key-lock Function

It inactivates all keys except the **START** key, **STOP** key, and the range switch. The **KEYLOCK** lamp is lit while the key-lock function is active. Use this function when you do not want to change the test mode or test settings.

To switch to the KEY-LOCK state, press the **LOCK** key. The **KEYLOCK** lamp is lit.

To cancel the key-lock function, press the **LOCK** key in the KEY-LOCK state while holding down the **SHIFT** key. The **KEYLOCK** lamp is not lit.

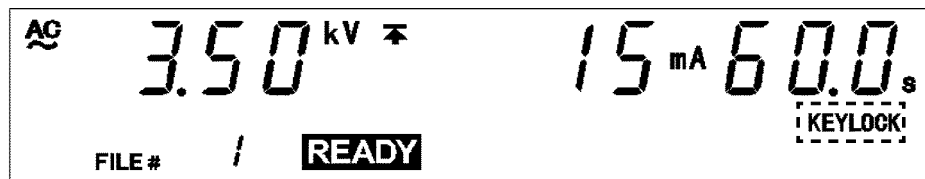

NOTE

Even when the key-lock function is activated, the **START** and **STOP** keys on the REMOTE CONTROL BOX and the start and stop signals on the external I/O terminal remain active.

6.3 Program Setting State

To edit, change, or confirm the program file, enter the Program setting state.

NOTE

- In the program setting state, **READY** is not lit, and the test cannot be started.
- When the program mode is used, although the test-voltage value is displayed in the READY state or "program setting state," that voltage is not being output.

1. When the **ENTER** key is pressed in the READY state in the program mode, the **FILE No.** lamp lights up and the unit enters the "program setting state." **READY** goes off and the test does not start, even when the **START** key is pressed.
2. The file number flashes. Select the number of the file to be edited or changed using the **▼/▲** keys.

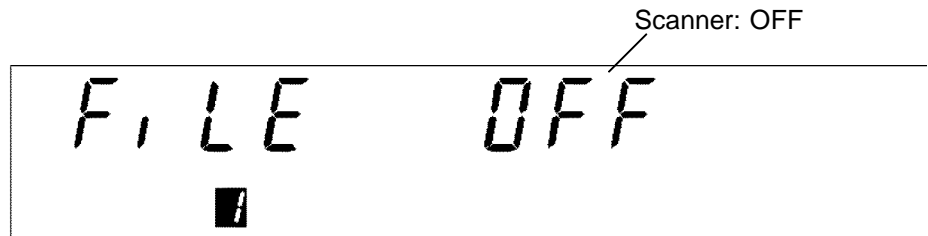

3. To use the scanner, select the mode.* When the scanner is not used, set it to OFF. (* **↔**: single scan; **↕**: multi-scan)
4. Move the flashing cursor using the **◀/▶** keys, and select the mode using the **▼/▲** keys. (For details on the scanner setting method, see the instruction manual for the 3930 HIGH VOLTAGE SCANNER.)

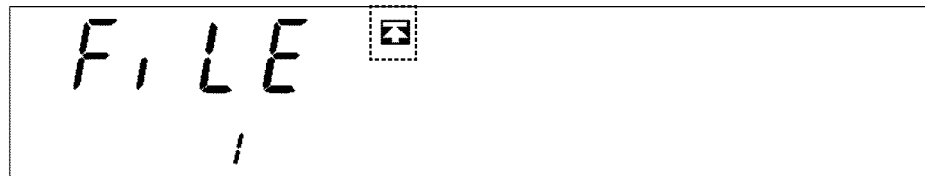

Single scan mode

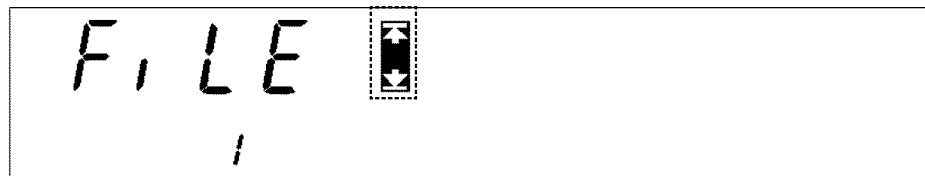

Multiple scan mode

4. To finalize the setting, press the **ENTER** key.
If the **STOP** key is pressed, the setting state can be exited without finalizing the setting (the unit changes to the program-mode **READY** state).

5. When the **ENTER** key is pressed, the **STEP No.** lamp lights up.
6. The step number flashes. Select the number of the step to be edited or changed using the **▼/▲** keys.
Press the **ENTER** key to proceed to the next setting. If the **STOP** key is pressed, the setting state can be exited. (The step setting is cancelled, and the unit changes to the program-mode **READY** state.)

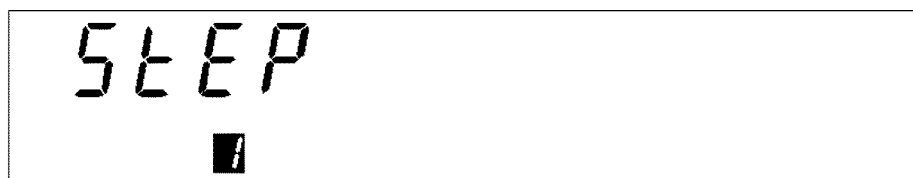

7. When the **ENTER** key is pressed, the **SCAN** lamp lights up. (If the scanner is set to **OFF** in **3.**, this item is not displayed.)
8. Move the flashing cursor using the **◀/▶** keys, and set the scanner box numbers and channel numbers using the **▼/▲** keys. Set between which channels of the scanner the test is to be conducted in the step that is being set. (For the scanner channel-setting method, see the instruction manual for the 3930 **HIGH VOLTAGE SCANNER**.)
Press the **ENTER** key to proceed to the next setting. If the **STOP** key is pressed, the setting state can be exited. (The step setting is cancelled, and the unit changes to the program-mode **READY** state.)

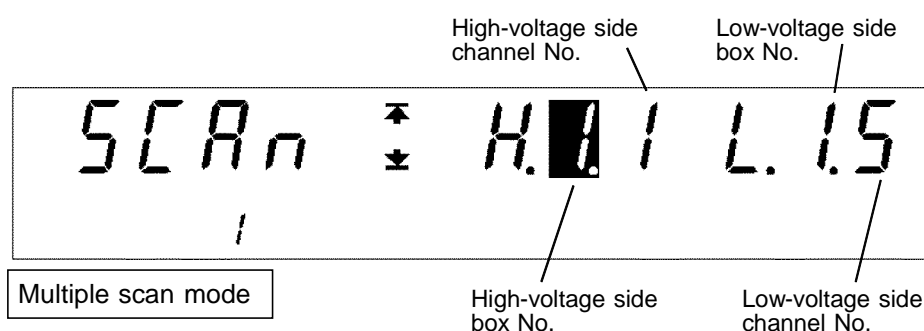
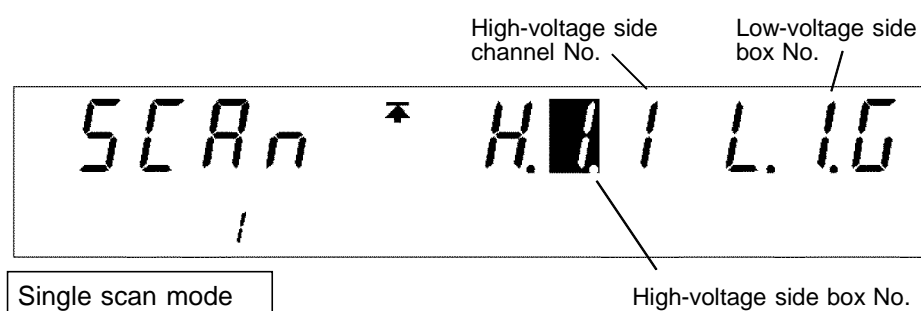

9. When the **ENTER** key is pressed, the **W/I** lamp lights up. Using the **W** key or **I** key, select a withstand-voltage test or insulation-resistance test to be conducted. To terminate the program test in this step, select **OFF** using the **ON/OFF** key. To continue the test, select **ON**. (If the step number is 50, **ON** cannot be selected.)

Press the **ENTER** key to proceed to the next setting. If the **STOP** key is pressed, the setting state can be exited. (The step setting is cancelled, and the unit changes to the program-mode **READY** state.)

To terminate the program test in this step

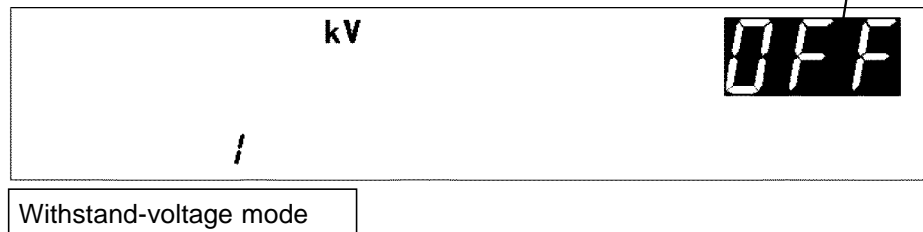

To continue the test to next step,

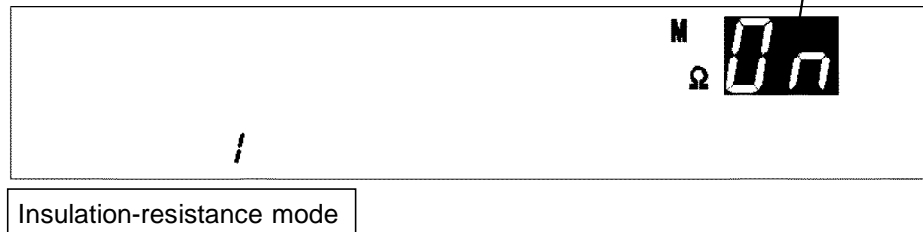

10. When the **ENTER** key is pressed, the **DATA INPUT** lamp lights up. Set the withstand-voltage or insulation-resistance test conditions in the step being set. For the setting items, see Test setting conditions in Chapters 3 and 4.

To make settings, use the following operation keys:

◀/▶ key: Move to the setting item

▼/▲ key: Change the preset value

ON/OFF key: Set the setting item to **ON** or **OFF**

When the **ENTER** key is pressed, the step being set is finalized. The step No. is as shown in 5. If the **STOP** key is pressed, the setting state can be exited. (The step setting is cancelled, and the unit changes to the program-mode **READY** state.)

11. When the **ENTER** key is pressed, the **STEP** lamp lights up, and the step number can be set. To conduct more than one test at the same time, repeat steps 5. to 10..
12. Upon completion of setting, press the **STOP** key. The unit returns to the program-mode **READY** state.

NOTE

- If each test condition is set as specified below, the test is conducted up to the step immediately prior to reaching that condition, and the test is terminated.
Lower-limit value upper-limit value
Delay time test time
Test-voltage value > output-voltage restricting value
- In the setting of each test condition, the test time cannot be set to **OFF**.

6.3.1 Examples of Settings

This is a description of the procedure for making settings for a program test under the conditions specified below. Create a program for conducting a test in the following order and under the following conditions:

Step 1. Insulation-resistance test

Test-voltage value: 500 V
 Upper-limit value: 100 MΩ
 Lower-limit value: OFF
 Test time: 5.0 s
 Delay time: 0.5 s

Step 2. AC-withstand-voltage test (50 Hz)

Test-voltage value: 1.5 kV
 Upper-limit value: 20 mA
 Lower-limit value: OFF
 Test time: 60.0 s
 Ramp-up time: 5.0 s
 Ramp-down time: OFF

Step 3. DC-withstand-voltage test

Test-voltage value: 2.0 kV
 Upper-limit value: 10 mA
 Lower-limit value: OFF
 Test time: 3.0 s
 Ramp-up time: OFF
 Ramp-down time: OFF

- Create a program in file No. 2.
- The scanner is not used.

The unit should be in the program-mode READY state.

(1) Move to the program setting state.

When the **ENTER** key is pressed, the unit changes to the "program setting state." **READY** goes off and the file-number setting window is displayed (the **FILE No.** lamp lights up).

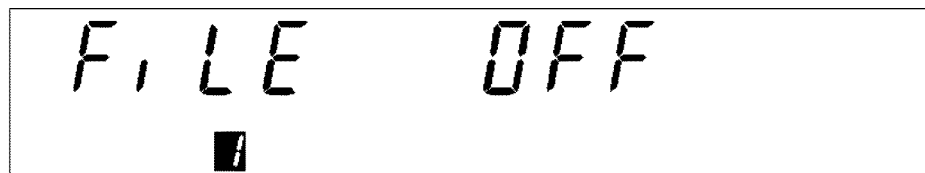

(2) Setting the file number

Select the number of the file to be edited, and set the scanner mode. In this example, the file number shown is 1. Change the file number to **2** using the **▼/▲** keys. As the scanner is not used, move the flashing cursor using the **◀/▶** keys, and set the scanner to **OFF** using the **▼/▲** keys. Press the **ENTER** key to finalize the setting.

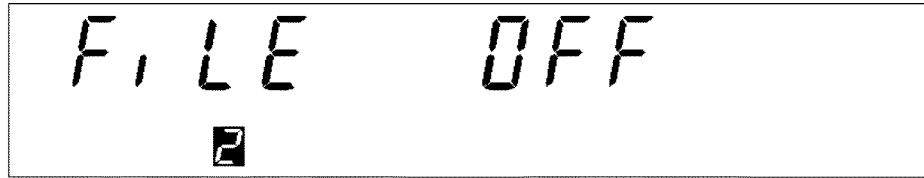

(3) Setting the step number

Select the number of the step to be edited. The **STEP** lamp lights up. Change the step number using the **▼/▲** keys. In this example, the step number is already **1**, so simply press the **ENTER** key and proceed to the next setting.

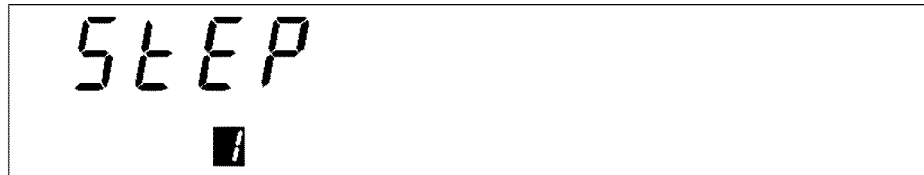

(4) Setting the scanner channels

When performing a test using the scanner, set the scanner channels to be used for testing in the step that is being set. (For details on this setting, see the instruction manual for the 3930 HIGH VOLTAGE SCANNER. This item is not displayed, as the scanner is set to OFF in the setting described in (2).)

(5) Setting the type of test in step 1 and selecting the continuation of the test

Select a test to be performed in step 1. The **W/I** lamp will light up. Use the **W** or **I** key. As an insulation-resistance test is to be performed in step 1, press the **I** key to select the insulation-resistance test. In addition, as the test is to be continued in steps 2 and 3, select **ON** using the **ON/OFF** key. Press the **ENTER** key, and proceed to the next setting.

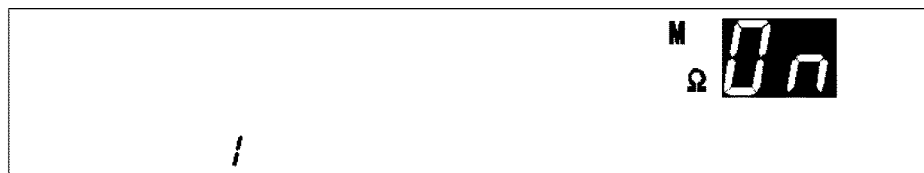

(6) Setting test conditions in step 1

Set the conditions of the test to be conducted in step 1. The **DATA INPUT** lamp will light up. Move the flashing cursor using the ◀/▶ keys, and set the conditions using the ▼/▲ keys. The setting method is the same as that for each mode. The test conditions in step 1 are as follows:

Test-voltage value: 500 V
 Upper-limit value: 100 MΩ
 Lower-limit value: OFF
 Test time: 5.0 s
 Delay time: 0.5 s

Therefore, set them as follows:

Test-voltage value: 500 V
 Upper-limit value: 100 MΩ
 Lower-limit value: OFF
 Test time: 5.0 s
 Delay time: 0.5 s

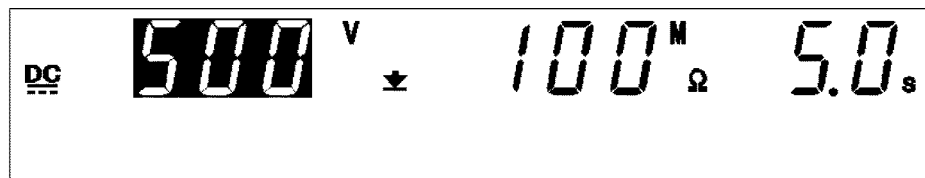

When the test conditions have been set, press the **ENTER** key. Pressing the **ENTER** key at this point finalizes settings (3) to (6). When the settings have been finalized, the step number selected in (3) is fixed as that for the settings.

(7) Setting of step 2

Select **2** as the step number. Press the **ENTER** key, and proceed to the next setting.



(8) Type of test performed in step 2

The test to be performed in step 2 is a withstand-voltage test. Therefore, the **W** key should be pressed. In addition, as the test is continued in step 3, select **ON** using the **ON/OFF** key.



(9) Setting test conditions in step 2

Set the conditions of the test to be conducted in step 2.

Test type: AC50 Hz
 Test-voltage value: 1.5 kV
 Upper-limit value: 20 mA
 Lower-limit value: OFF
 Test time: 10.0 s
 Ramp-up time: 5.0 s
 Ramp-down time: OFF

When the test conditions have been set, press the **ENTER** key to finalize the settings. Then, proceed to the setting of step 3.

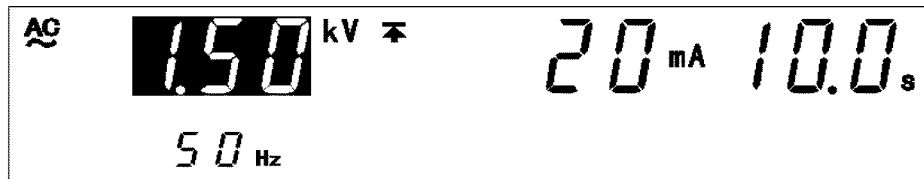

(10) Setting of step 3

Select **3** as the step number. Press the **ENTER** key, and proceed to the next setting.

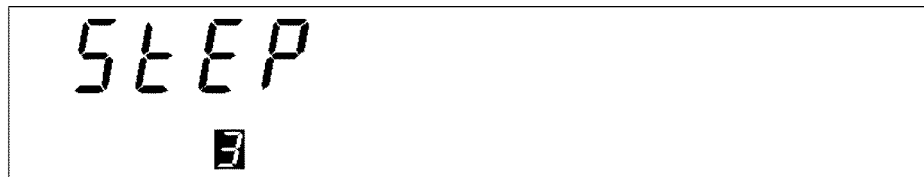

(11) Type of test performed in step 3

The test to be performed in step 3 is a withstand-voltage test. Therefore, the **W** key should be pressed. In addition, as the test is terminated in step 3, select **OFF** using the **ON/OFF** key.



(12) Setting the test conditions in step 3

Set the conditions of the test to be conducted in step 3.

Test type: DC
 Test-voltage value: 2.0 kV
 Upper-limit value: 10 mA
 Lower-limit value: OFF
 Test time: 3.0 s
 Ramp-up time: OFF
 Ramp-down time: OFF

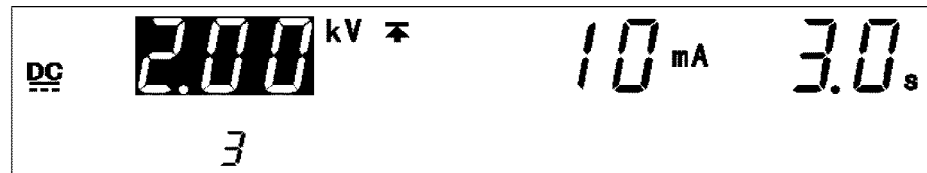

When the test conditions have been set, press the **ENTER** key to finalize the settings. Press the **STOP** key to exit the program setting state. The unit will change to the program mode and enter the **READY** state. File 2 is set as follows:

File: 2

Scanner: OFF

Step 1. Insulation-resistance test

Test-voltage value: 500 V
 Upper-limit value: 100 MΩ
 Lower-limit value: OFF
 Test time: 5.0 s
 Delay time: 0.5 s

Step 2. AC-withstand-voltage test (50 Hz)

Test-voltage value: 1.5 kV
 Upper-limit value: 20 mA
 Lower-limit value: OFF
 Test time: 60.0 s
 Ramp-up time: 5.0 s
 Ramp-down time: OFF

Step 3. DC-withstand-voltage test

Test-voltage value: 2.0 kV
 Upper-limit value: 10 mA
 Lower-limit value: OFF
 Test time: 3.0 s
 Ramp-up time: OFF
 Ramp-down time: OFF

6.4 Program-File Loading

Loads a file that has been created or edited, so that it can be executed.

1. Press the **PG.LOAD** key in the READY state.
2. Set the number of the file to be loaded using the ▼/▲ keys.
Step 1 of the selected file will be displayed.

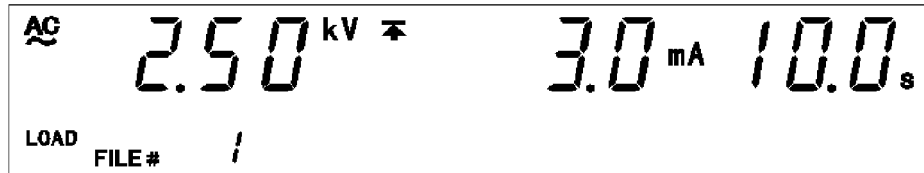

3. Execute file loading by pressing the **ENTER** key. The selected file will be loaded, and the program-mode window will be displayed. To cancel loading, press the **STOP** key. The unit will change to the program mode with the file number used or loaded previously.

6.5 Starting a Test

The flowchart below explains how a test is carried out.

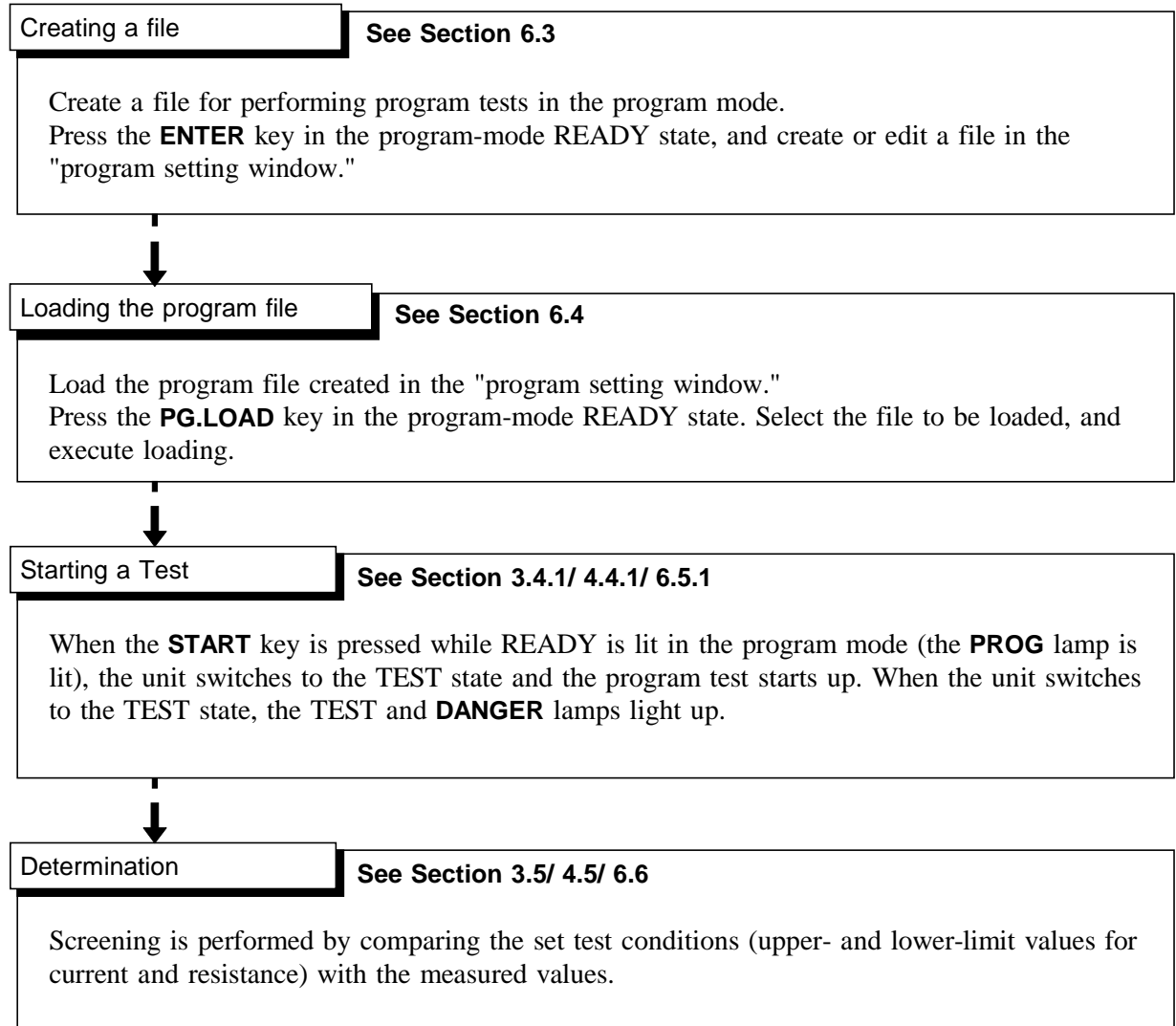

6.5.1 Executing a Test



To avoid electric shock, observe the following precautions to avoid electric shock.

Make sure that no high voltage is being applied to the output, confirm the following items, and output voltage.

- (1) The analog voltmeter reads 0 kV.
- (2) The **DANGER** lamp is OFF.
- (3) The **READY** lamp is lit (it is off in the Double Action mode).



Priority for control of the **START** key is in the following order: the **START** key on the REMOTE CONTROL BOX, the external I/O, and the front panel of the unit.

Connecting the switch signal line plug on the REMOTE CONTROL BOX disables the **START** key on the front panel of the unit and the start signal for the external I/O.

1. Press the **START** key when **READY** is lit in the program mode.
The unit will change to the TEST status and a test will start. **TEST** and the **DANGER** lamp are lit in the TEST state.
2. In either of the cases below, the test will be terminated and **UPPER**, **LOWER**, or **FAIL** will light.

When performing a withstand-voltage test:

- The output voltage doesn't reach the set test voltage value $\pm 5\%$.
- The output voltage deviates from the test voltage value during the test and doesn't return to the set value ± 1 dgt. within 5 seconds.

When performing an insulation-resistance test:

- About 1 second after the test has started, the output voltage is still lower than 1/2 of the set test voltage.
- The test time has elapsed without the output voltage reaching a level between 5% lower and 50% higher than the set test voltage value.
- Output voltage during testing differs from the test voltage value and does not fall within the range 80% to 150% of the voltage setting.

*See Section 3.4.1 , 4.4.1

3. To terminate the test, press the **STOP** key. The unit will immediately stop outputting a voltage and switch to the READY state. In such a case, no screening is conducted.



- In addition to using the **STOP** key on the unit, a stop can be forced using the **STOP** key on the remote-control box or by using a STOP signal via external input/output.
- If each test condition is set as specified below, the test is conducted up to the step immediately prior to reaching that condition, and the test is terminated.
Lower-limit value upper-limit value, Delay time test time,
Test-voltage value > output-voltage restricting value
The step number displayed at this time is that in which the test is terminated. The step in which any of the above settings is recognized is that following the step number displayed. When any of the above settings is recognized in step 1, the file number is displayed instead of the step number, and the program test does not start.

Optional Functions

- The Hold function can be used to hold the value that was effective at the time of forced termination of the test. (See Section 7.3)
- During the hold state, the result of the terminated test can be displayed using the ◀/▶ keys.

6.5.2 Screening in "TEST" State

(1) When performing a withstand-voltage test:

Similar to the withstand-voltage mode TEST state. (See Section 3.4.2)

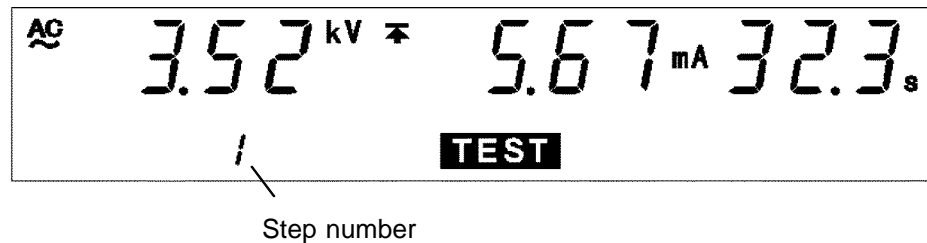

(2) When performing an insulation-resistance test:

Similar to the insulation-resistance mode TEST state. (See Section 4.4.2)

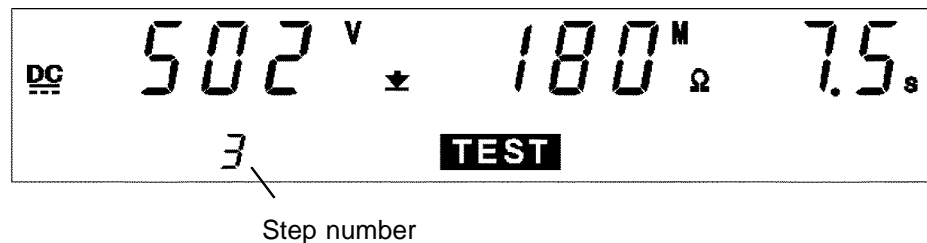

Danger lamp

Indicates that a voltage is being output. The lamp stays on during the test. This lamp remains lit even after completion of the test, if a voltage higher than the safety voltage (approximately AC 0.03 kV (AC withstand-voltage test) or approximately DC 60 V (DC withstand-voltage test or insulation-resistance test) has flowed between output terminals.

External I/O

The timing when the TEST signal is turned ON is the same as the timing when **TEST** on the fluorescent indicator lights up (or flashes). The timing when the H.V.ON signal is turned on is the same as when the **DANGER** lamp lights up.

Each time one step is completed, the STEP-END signal turns ON (ON time: 0.1 s).

Analog voltmeter

Indicates the voltage value being output.

Optional Functions

Setting can be performed so that the TEST signal will be OFF while TEST flashes. See Section 7.15.

6.6 PASS or FAIL Determination

6.6.1 "PASS" State



Even when a test has been terminated, there may still be voltage in the output-voltage terminal. Before touching the output-voltage terminal, H.V. TEST LEAD, or tested object, make sure that no high voltage is being applied to the output, confirm the following items.

- (1) The analog voltmeter reads 0 kV.
 - (2) The **DANGER** lamp is OFF.
 - (3) The **READY** lamp is lit (it is off in the Double Action mode).
-

- When all set test conditions have been met, the unit switches to the PASS state. As soon as the unit switches to this state, it stops outputting voltage.
- When the test is forcibly terminated by pressing the **STOP** key, no screening is performed.
- During the insulation-resistance test, if the output voltage doesn't reach a level between 5% lower and 50% higher than the set test voltage value, screening will not be performed.

Optional Functions

- The PASS state is held using the PASS Hold function. (See Section 7.1)
- During the hold state, the result of the terminated test can be displayed using the ◀▶ keys.

Flow of PASS determination

1. Press the **START** key to start a test.
2. The test set by the program file is conducted in each step.
3. When all test conditions have been met, the unit switches to the PASS state. In this state, PASS lights up.

6.6.2 Screening in "PASS" State

(1) When the most recent test was a withstand-voltage test

Similar to the withstand-voltage mode PASS state. (See Section 3.5.2)

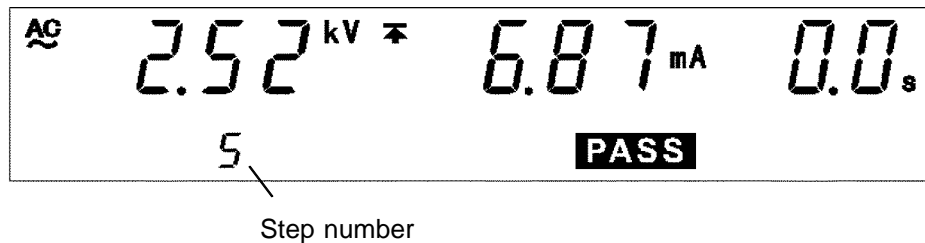

(2) When the most recent test was an insulation-resistance test

Similar to the insulation-resistance mode PASS state. (See Section 4.5.2)

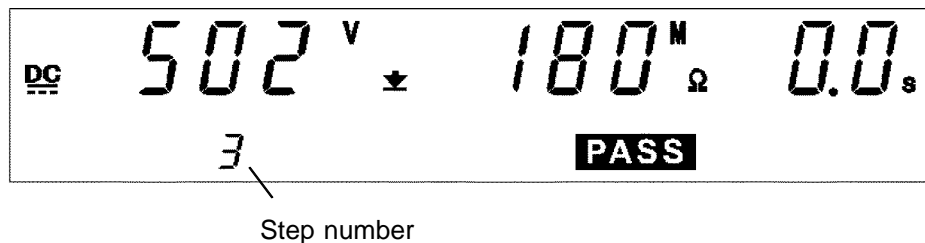

Danger lamp

Indicates that a voltage is being output. The lamp stays on during the test. The lamp will also light if a voltage exceeding the safety voltage (approximately AC 0.03 kV (AC withstand-voltage test)) or approximately DC 60 V (DC withstand-voltage test or insulation-resistance test) remains between the output terminals after the test has been completed.

External I/O

The PASS and FILE-END signal is turned ON when **PASS** on the fluorescent indicator is lit. (FILE-END signal: 0.1 s) As long as the PASS state is held, the PASS signal remains ON. The PASS signal is turned OFF when the **PASS** light on the fluorescent indicator goes out.

If voltage remains in the output-voltage terminal following termination of a test, the H.V.ON signal remains ON. When the **DANGER** lamp goes out, H.V.ON signal is immediately turned OFF.

Analog voltmeter

Indicates the voltage value being output. Even when values are held using the "FAIL hold function," the value of the analog voltmeter is not held.

6.6.3 "FAIL" State



Even when a test has been terminated, there may still be voltage in the output-voltage terminal. Before touching the output-voltage terminal, H.V. TEST LEAD, or tested object, make sure that no high voltage is being applied to the output, confirm the following items.

- (1) The analog voltmeter reads 0 kV.
- (2) The DANGER lamp is OFF.
- (3) The READY lamp is lit (it is off in the Double Action mode).

If the measured voltage deviates from the upper or lower value during the test, the unit switches to the FAIL state and immediately stops outputting a voltage. The FAIL state can be divided into UPPER FAIL and LOWER FAIL states.

During the insulation-resistance test, if the output voltage doesn't reach a level between 5% lower and 50% higher than the set test voltage value, screening will not be performed.

UPPER FAIL	The measured current or measured resistance has exceeded the upper-limit value.
LOWER FAIL	The measured current or measured resistance has dropped below the lower-limit value.

When performing a withstand-voltage test:

- If the output voltage doesn't reach the set test voltage value $\pm 5\%$ or if the voltage deviates from the set voltage value during the test and doesn't return to the set value ± 1 dgt. within 5 seconds, FAIL will result. UPPER, LOWER or FAIL will light.

When performing an insulation-resistance test:

- If the test time has elapsed without the output voltage reaching a level between 5% lower and 50% higher than the set test voltage value or if the voltage deviates largely from the set voltage value, FAIL will result. UPPER, LOWER or FAIL will light.

Optional Functions

- The FAIL state is held using the FAIL Hold function. (See Section 7.2)
- During the hold state, the result of the terminated test can be displayed using the ◀▶ keys.

Flow of FAIL determination

1. Press the START key to start a test.
2. The test set by the program file is conducted in each step.
3. When the measured current or measured resistance values deviate from the preset test settings, the unit stops outputting a voltage and switches to the FAIL state. FAIL lights up in the FAIL state together with LOWER or UPPER.

NOTE

- If a current double to the preset upper-limit value is detected while performing a withstand-voltage test, the voltage is immediately blocked by the insulation circuit, resulting in an UPPER FAIL. In such cases, the measured current value is not displayed correctly.
- When the optional "Insulation Resistance Measurement Range" function is set to "1: Auto Range", it takes up to 1.5 s to display the resistance value. When the test finishes before the preset test time, the test results in a LOWER FAIL.
- Setting an upper-limit value while using a fixed range restricts the range of resistance that can be measured. Therefore, even if a resistance value lower than the preset upper-limit value is measured, "O.F." is displayed resulting in an UPPER FAIL. If the measured values have deviated from the test conditions, the unit switches to the FAIL state. As soon as the unit switches to this state, it stops outputting voltage. (See Section 4.3.2) • Insulation resistance test termination mode is enabled only in I mode. In Auto test mode or Program test mode, in which Insulation resistance test termination mode is disabled, the unit shifts to the FAIL state and the test is terminated. To make the unit operate in the same way as that with a timer test termination function enabled, set a delay time.

Example of setting

For the test time of 1.0 s, set the delay time to 0.9 s.

Because screening is performed for 0.1 s, the unit operates in the same way as a timer termination.

6.6.4 Screening in "FAIL" State

(1) When performing a withstand-voltage test:

Similar to the withstand-voltage mode FAIL state. (See Section 3.5.3)

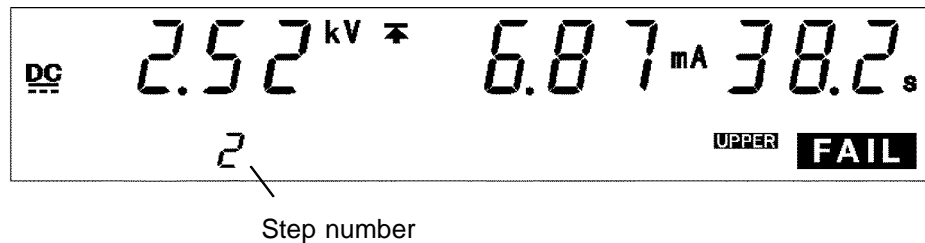

(2) When performing an insulation-resistance test:

Similar to the insulation-resistance mode FAIL state. (See Section 4.5.3)

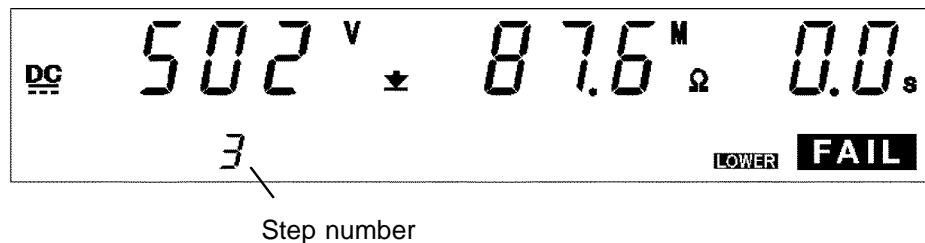

Danger lamp

Indicates that a voltage is being output. The lamp stays on during the test. The lamp will also light if a voltage exceeding the safety voltage (approximately AC 0.03 kV (AC withstand-voltage test)) or approximately DC 60 V (DC withstand-voltage test or insulation-resistance test) remains between the output terminals after the test has been completed.

Analog voltmeter

Indicates the voltage value being output. Even when values are held using the "FAIL hold function," the value of the analog voltmeter is not held.

External I/O

As soon as **FAIL** on the fluorescent indicator lights up, the L-FAIL or U-FAIL signal lights up. At the same time, the FILE-END signal also lights up for 0.1 seconds. While the FAIL state is held, both L-FAIL and U-FAIL signals remain ON. As soon as FAIL on the fluorescent indicator goes off, the L-FAIL or U-FAIL signal goes off.

As soon as FAIL on the fluorescent indicator lights up, the W-FAIL signal (in the case of a withstand-voltage test) or I-FAIL signal (in the case of an insulation-resistance test) lights up.

If voltage remains in the output-voltage terminal following termination of a test, the H.V.ON signal remains ON. When the **DANGER** lamp goes out, H.V.ON signal is immediately turned OFF.

6.7 Automatic Discharge Function

When a test object that contains a capacity component is subjected to the DC withstand-voltage test and insulation-resistance test, the object might remain electrically charged, thereby causing an electric shock. This unit is equipped with a function to discharge residual electricity upon termination of the withstand-voltage test (discharge resistance: 726 k Ω).

The unit automatically switches to the internal discharge circuit to discharge the test object (the **DANGER** lamp is lit).

When the voltage has dropped below approximately AC 0.03 kV or approximately DC 60 V, the DANGER lamp goes out.

The larger the capacity component of the test object, the more time is required to discharge the test object.

NOTE

- When the unit completes one step and switches to the next step, the test in the next step does not start until the voltage between the output terminals drops below the safety voltage (approximately AC 0.03 kV or approximately DC 60 V). If the test object contains a capacity component, switching may take some time.
- Until the test is complete and the **DANGER** lamp goes out, no key operation is accepted.

Chapter 7

Optional Functions

Setting the optional functions allows testing under various conditions. To set an optional function, select the number assigned to the function (except for output-voltage setting).

(1) Optional Function Settings Screen

Press **SHIFT** + **STOP** keys while in READY state to display the Optional function setting screen.

Page 1

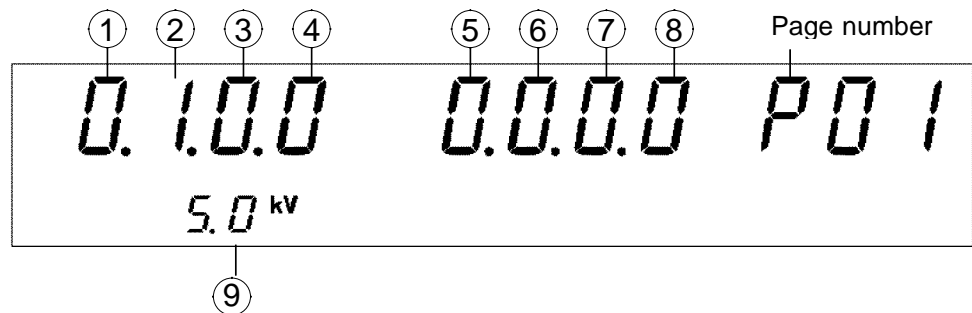

Page2

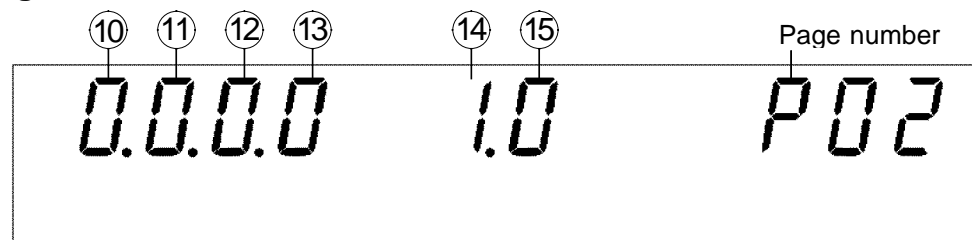

Press **SHIFT** + **STOP** keys once more to complete the Optional function setting screen.

(2) Setting optional functions

1. Use the ◀▶ keys to move the flashing cursor to the target function.
2. Use the ▼▲ keys to set a value at the flashing cursor location.
To change the page, move the flashing cursor to the page number and select a page using the ▼▲ keys.
3. To complete the optional settings, press **SHIFT** + **STOP** keys. The unit reverts to the READY state.

Page 1

1 PASS hold function	
This function retains PASS state to help verify the value screened in the test.	
Selection	0: Not held (initial setting) 1: Held
2 FAIL hold function	
This function retains FAIL state to help verify the value screened in the test.	
Selection	0: Not held 1: Held (initial setting)
3 Hold function	
Enable this function to hold the current state when testing is interrupted by the STOP key.	
Selection	0: Not held (initial setting) 1: Held
4 Momentary-out	
The momentary out function allows current output only while the START key is held down. The START key on the remote control or the START signal via external I/O has the same effect.	
Selection	0: Not set (initial setting) 1: Set
5 Double action	
Enable this function to allow testing to start only when the START key is pressed within about 0.5 seconds after the STOP key.	
Selection	0: Not set (initial setting) 1: Set
6 FAIL mode	
Enable this function to restrict hold release to the STOP key on the main unit.	
Selection	0: Not set (initial setting) 1: Set
7 Interface command "START"	
Turn this function on to enable the interface START command.	
Selection	0: Not set (initial setting) 1: Set
8 Inter-lock function	
Enable this function to activate the external I/O interlock terminals.	
Selection	0: Not set (initial setting) 1: Set
9 Output-voltage restricting value	
Enable this function to set the upper-limit value for the output voltage (common for the withstand-voltage and insulation-resistance tests).	
Selection	0.5 to 5.0 kV (Can be set in 0.1-kV steps) (initial setting: 5.0 kV)

Page 2

10 Insulation-resistance test measurement range	
Select whether you want to use a fixed or an automatic range as the insulation-resistance test measurement range. The fixed ranges are automatically selected depending on the preset lower-limit value. Auto range switches between ranges depending on the measured value, but it takes time to display this value, since it is displayed after the range is switched. (This takes approximately 1.5 seconds.)	
Selection	0: Fixed range (initial setting) 1: Auto range
11 Insulation-resistance test termination mode	
When performing an insulation-resistance test, set whether you want to conduct the test for the set test time regardless of the decision, terminate the test when PASS screening is performed, or terminate the test when FAIL screening is performed. This mode is effective when the test time is set.	
Selection	0: Test for set time 1: Terminate test at PASS screening 2: Terminate test at FAIL screening
12 Setting for screening during ramp-up time	
Select whether screening is to be performed during ramp-up time in a DC withstand-voltage test.	
Selection	0: No screening during ramp-up time (Initial setting) 1: Screening during ramp-up time
13 PC interface	
Enable this function to select a PC interface to be used.	
Selection	0: RS-232C (9600 bps) (initial setting) 1: RS-232C (19200 bps) 2: GP-IB When GP-IB is selected, set the GP-IB address in the lower column.
Contents	GP-IB address: 0 to 30 (initial setting: 3) ("2: GP-IB" is selected)
14 START protection function	
Select whether START is to be invalid during the discharge time upon completion of each test.	
Selection	0: Not set (initial setting) 1: Set
15 TEST-signal output	
Select whether the external I/O TEST signal output and TEST flashing time are to be included in the TEST-signal output.	
Selection	0: TEST signal ON, including while TEST is flashing (Initial setting) 1: TEST signal OFF, while TEST is flashing 2: TEST signal ON, only while TEST is flashing (excluding ramp-down time)

7.1 PASS Hold Function

This function retains the value for the PASS state on test completion. To inactivate the hold function, press the **STOP** key. The unit reverts to the READY state.

If the PASS hold function is not selected, the test result is displayed for about 0.3 second before the unit reverts to the READY state.

1. Press **SHIFT** + **STOP** keys while in READY state to display the Optional function setting screen.
2. Use the ◀▶ keys to move the flashing cursor to the position shown in the figure.

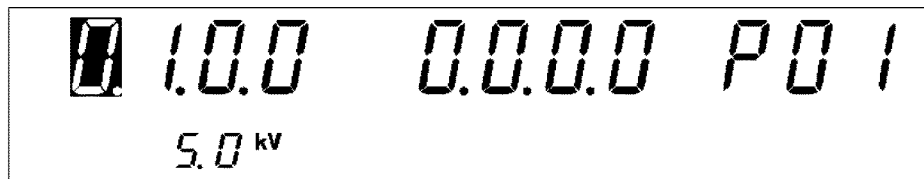

3. Use the ▼/▲ keys to set a value at the flashing cursor location.

0:	Not held (Initial setting)
1:	Held
4. To complete the optional settings, press **SHIFT** + **STOP** keys. The unit reverts to the READY state.

7.2 FAIL Hold Function

This function retains the value for the FAIL state on test completion. To inactivate the hold function, press the **STOP** key. The unit reverts to the READY state.

If the FAIL hold function is not selected, the test result is displayed for about 0.3 second before the unit reverts to the READY state.

1. Press **SHIFT** + **STOP** keys while in READY state to display the Optional function setting screen.
2. Use the ◀▶ keys to move the flashing cursor to the position shown in the figure.

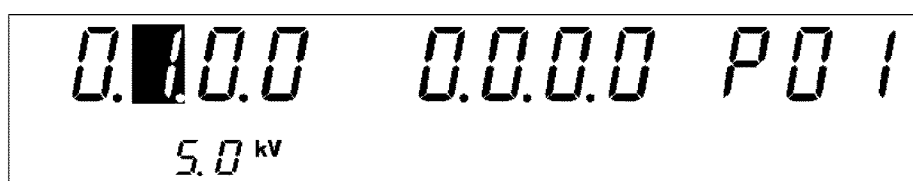

3. Use the ▼/▲ keys to set a value at the flashing cursor location.

0: Not held

1: Held (Initial setting)

4. To complete the optional settings, press **SHIFT** + **STOP** keys. The unit reverts to the READY state.

7.3 Hold Function

Enable this function to hold the current state when testing is interrupted by the **STOP** key.

To inactivate the hold function, press the **STOP** key. The unit reverts to the **READY** state.

If the Hold function is not selected, the unit switches to the **READY** state upon forced termination of the test.

1. Press **SHIFT + STOP** keys while in **READY** state to display the Optional function setting screen.
2. Use the ◀▶ keys to move the flashing cursor to the position shown in the figure.

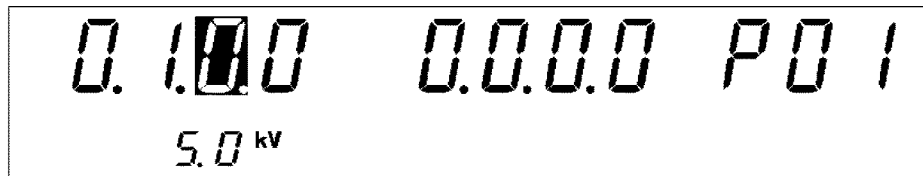

3. Use the ▼/▲ keys to set a value at the flashing cursor location.

0:	Not held (Initial setting)
1:	Held
4. To complete the optional settings, press **SHIFT + STOP** keys. The unit reverts to the **READY** state.

Distinction between the PASS Hold Function, FAIL Hold Function, and Hold Function

- If the test time is set to OFF in withstand-voltage mode, PASS screening is not performed. In such a case, FAIL screening is performed or the test is terminated using the **STOP** key.
- In insulation-resistance mode, if the test time is set to OFF, PASS screening is not performed. In such a case, the test is terminated using the **STOP** key.

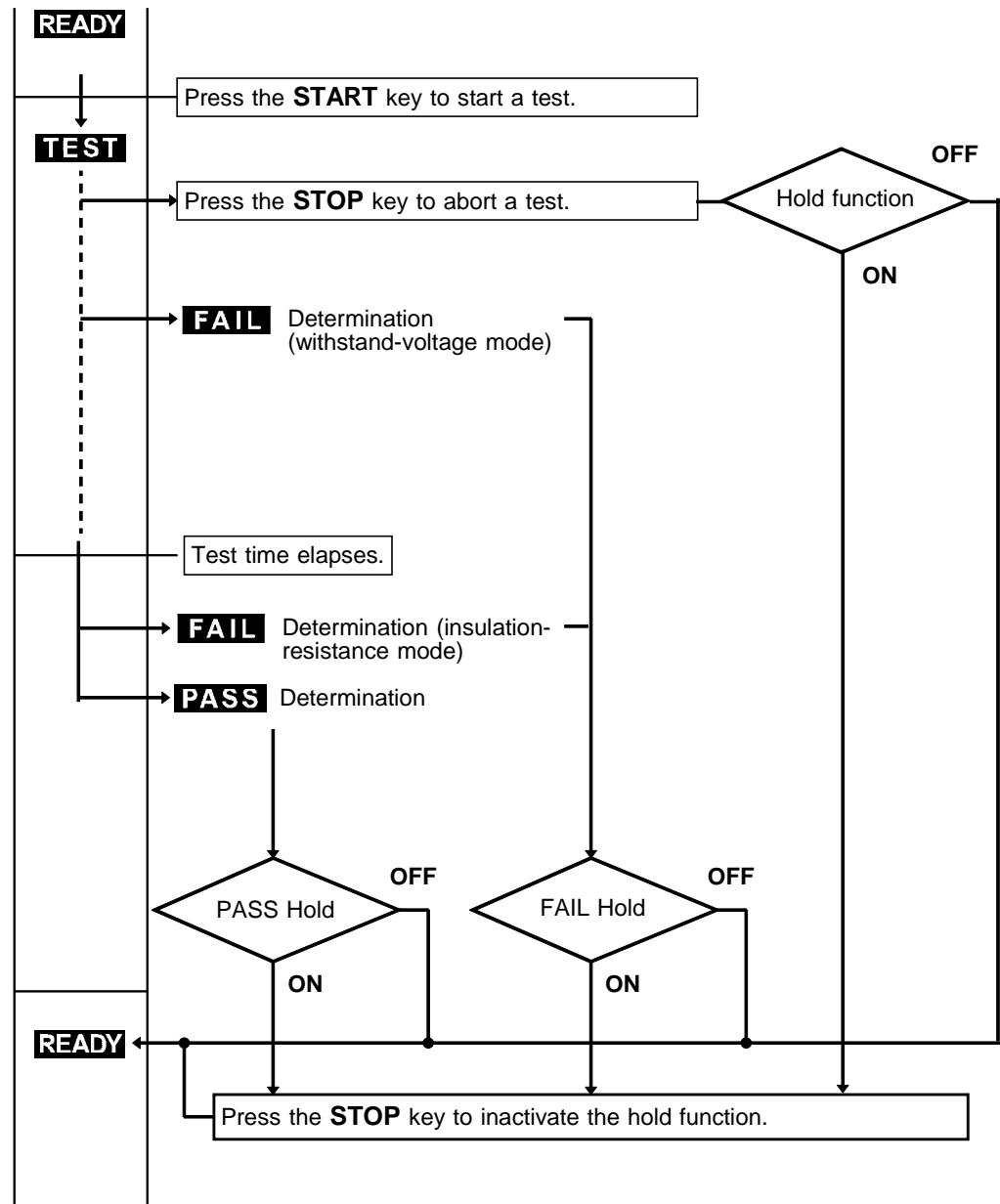

7.4 Momentary Out

The momentary out function allows current output only while the **START** key is held down. Releasing the **START** key is equivalent to pressing the **STOP** key and ends the test.

To perform PASS/FAIL screening, hold down the **START** key until the preset test time elapses.

The **START** key on the remote control or the **START** signal via external I/O has the same effect.

1. Press **SHIFT** + **STOP** keys while in **READY** state to display the Optional function setting screen.
2. Use the ◀▶ keys to move the flashing cursor to the position shown in the figure.

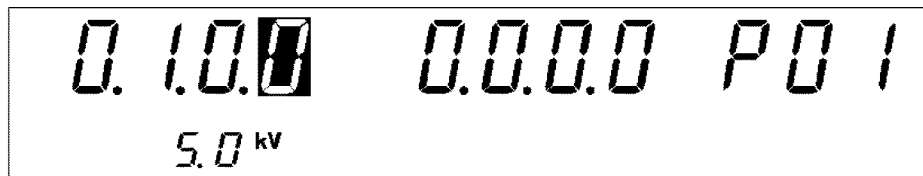

3. Use the ▼/▲ keys to set a value at the flashing cursor location.

0:	Not set (Initial setting)
1:	Set
4. To complete the optional settings, press **SHIFT** + **STOP** keys. The unit reverts to the **READY** state.



Priority for control of the **START** key is in the following order: the switch on the **REMOTE CONTROL BOX**, the external I/O, and the front panel of the unit.

7.5 Double Action

When using the Double Action function, the test starts if the **START** key is pressed within approximately 0.5 s of the **STOP** key being pressed. Normally, pressing the **START** key only starts the test. However, when using the Double Action function, the **STOP** key must be pressed before pressing the **START** key. This function increases testing safety by preventing operational errors.

Double Action function is set, **READY** only lights up for approximately 0.5 seconds after the **STOP** key is pressed.

1. Press **SHIFT** + **STOP** keys while in READY state to display the Optional function setting screen.
2. Use the ◀▶ keys to move the flashing cursor to the position shown in the figure.

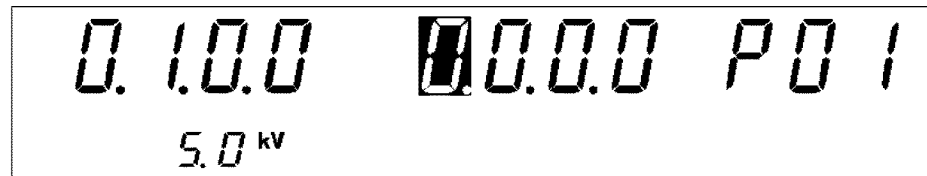

3. Use the ▼/▲ keys to set a value at the flashing cursor location.

0: Not set (Initial setting)

1: Set

4. To complete the optional settings, press **SHIFT** + **STOP** keys. The unit reverts to the READY state.

NOTE

The Double Action function can be set in combination with the Momentary-Out function. If settings are made in this way, press the **START** key within 0.5 seconds after the **STOP** key is pressed to start a test. Hold down the **START** key during the test.

7.6 FAIL Mode

The FAIL mode is a function that is limited to manually cancelling the FAIL hold state (using the **STOP** key on the machine or the **STOP** switch on the remote control box).

1. Press **SHIFT** + **STOP** keys while in READY state to display the Optional function setting screen.
2. Use the ◀▶ keys to move the flashing cursor to the position shown in the figure.

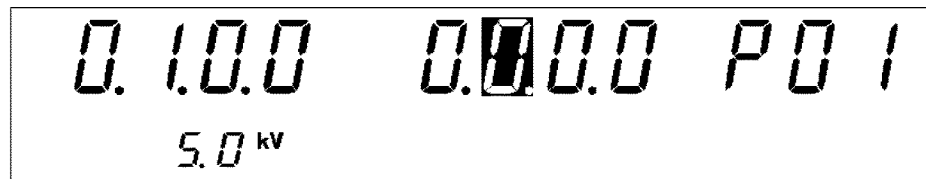

3. Use the ▼/▲ keys to set a value at the flashing cursor location.

0:	Not set (Initial setting)
1:	Set
4. To complete the optional settings, press **SHIFT** + **STOP** keys. The unit reverts to the READY state.

7.7 Interface Command "START"

When RS-232C is used for control, settings can be made to specify whether to accept the test start command ":STAR."

If "0: Not set" is selected, this command is disregarded.

If "1: Set" is selected, a test is started when the ":START" command is received.

1. Press **SHIFT** + **STOP** keys while in READY state to display the Optional function setting screen.
2. Use the ◀▶ keys to move the flashing cursor to the position shown in the figure.

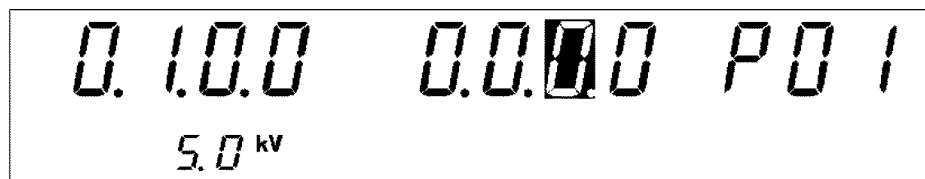

3. Use the ▼/▲ keys to set a value at the flashing cursor location.

0: Not set (Initial setting)

1: Set

4. To complete the optional settings, press **SHIFT** + **STOP** keys. The unit reverts to the READY state.

NOTE

Unless the control program on your PC is complete, select "0: Not set."

7.8 Inter-lock Function

Settings can be made to specify whether to use the Inter-lock function with the external I/O terminal.

If "0: Not set" is selected, the Inter-lock function is cancelled regardless of the state of Pin 10 (INT.LOCK) on the external I/O terminal.

If "1: Set" is selected, the Inter-lock function may be disabled, depending on the state of Pin 10 (INT.LOCK) of the external I/O terminal. For the Inter-lock function, see Section 9.1.4, "Inter-lock function."

1. Press **SHIFT + STOP** keys while in READY state to display the Optional function setting screen.
2. Use the ◀▶ keys to move the flashing cursor to the position shown in the figure.

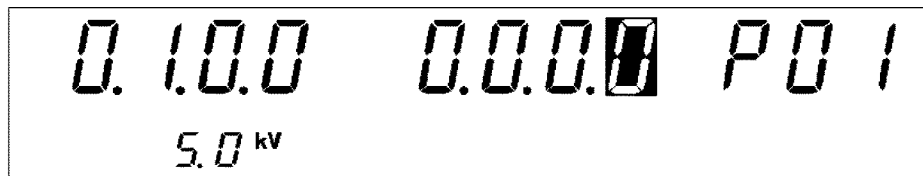

3. Use the ▼/▲ keys to set a value at the flashing cursor location.

0: Not set (Initial setting)

1: Set

4. To complete the optional settings, press **SHIFT + STOP** keys. The unit reverts to the READY state.



The Inter-lock function can be set only when INT.LOCK (Pin 10) of the external I/O terminal is set at LOW level. If the terminal is set at HIGH level, "0: Not set" remains effective even if the ▼/▲ keys are pressed.

7.9 Setting of an Output-Voltage Restricting Value

Enable this function to set the upper-limit for the voltage to be output by this unit. Set the value in the range of 0.5 kV to 5.0 kV (in 0.1-kV steps, effective value). This is common for all modes.

1. Press **SHIFT** + **STOP** keys while in READY state to display the Optional function setting screen.
2. Use the ◀/▶ keys to move the flashing cursor to the position shown in the figure.

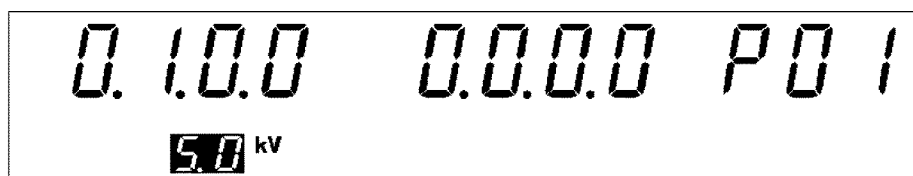

3. Use the ▼/▲ keys to set a value at the flashing cursor location.
Initial setting: **0.5 to 5.0 kV**
4. To complete the optional settings, press **SHIFT** + **STOP** keys. The unit reverts to the READY state.

NOTE

- If the set test voltage is greater than the voltage value set here, an error will occur upon startup of the test (the test-voltage value flashes), and it will not be possible to conduct the test.
- If the test-voltage value that is loaded by loading a set value is greater than the set upper-limit, an error will occur upon startup of the test (the test-voltage value flashes), and it will not be possible to conduct the test.
- If the test-voltage value that is loaded by loading a program in program mode is greater than the set upper-limit, an error will occur upon starting the step, and it will not be possible to conduct the test.

7.10 Insulation Resistance Test Measurement Range

Select whether you want to use a fixed or an automatic range as the insulation-resistance test measurement range.

If "0: Fixed range" is selected, the range is automatically selected depending on the preset lower-limit value.

If "1: Auto range" is selected, the range is automatically switched according to the measured value.

1. Press **SHIFT** + **STOP** keys while in **READY** state to display the Optional function setting screen.
2. Move the flashing cursor to the position of **P01** using the **◀/▶** keys, and display **P02** (p. 2) using the **▼/▲** keys.
3. Use the **◀/▶** keys to move the flashing cursor to the position shown in the figure.

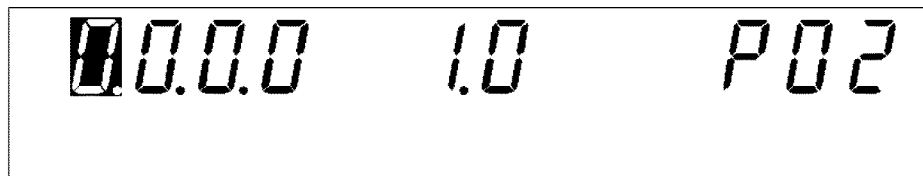

4. Use the **▼/▲** keys to set a value at the flashing cursor location.

0:	Fixed range (Initial setting)
1:	Auto range
5. To complete the optional settings, press **SHIFT** + **STOP** keys. The unit reverts to the **READY** state.

NOTE

- For details on the relationships among the test-voltage values, lower-limit values, and resistance measurement range, see Section 4.3.2 Setting of Lower-Limit Values (Upper-Limit Values).
- When the auto range is used, it is switched according to measured values. Due to the range-switching time, a certain amount of time is required for a measured value to be displayed (approximately 1.5 seconds).
- When both the "Auto range" and the Test Time are set to ON, testing will not begin even if the **START** key is pressed. (If set to ON, the displays for the resistance value and the test time will blink.)

7.11 Insulation Resistance Test Termination Mode Settings

When performing an insulation-resistance test, set whether you want to conduct the test for the set test time regardless of the decision, terminate the test when PASS screening is performed, or terminate the test when FAIL screening is performed. (Insulation resistance mode only. In auto test mode and program mode, operation will be the same as when " 2: terminate test at FAIL screening " is selected as the insulation resistance test termination mode.)

If "0: Test for set time" is selected, the test is only conducted for the set time, and the value is decided when the test is terminated.

If "1: Terminate test at PASS screening" is selected, the test is terminated when PASS screening is conducted within the set time. If PASS screening is not conducted within the set time, the test is terminated when FAIL screening is conducted after the set time.

If "2: The test is terminated when FAIL screening is conducted within the set time. If FAIL screening is not conducted within the set time, the test is terminated when PASS screening is conducted after the set time.

1. Press **SHIFT** + **STOP** keys while in READY state to display the Optional function setting screen.
2. Move the flashing cursor to the position of **P01** using the **◀/▶** keys, and display **P02** (p. 2) using the **▼/▲** keys.
3. Use the **◀/▶** keys to move the flashing cursor to the position shown in the figure.

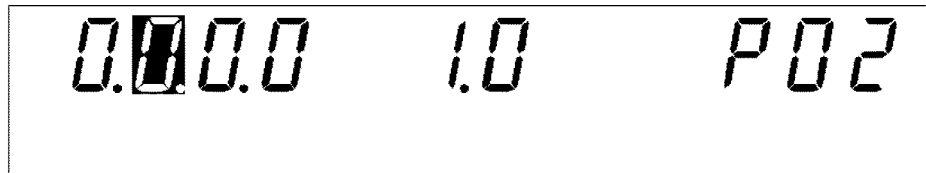

4. Use the **▼/▲** keys to set a value at the flashing cursor location.

0 : Test for set time (Initial setting)

1 : Terminate test at PASS screening

2 : Terminate test at FAIL screening

5. To complete the optional settings, press **SHIFT** + **STOP** keys. The unit reverts to the READY state.

NOTE

- To test an object that contains a capacity component, set it to either one of the following:
 1. Select "0: Test for the set time".
 2. Select "1: End with a PASS result", and set the test time necessary for charging.
 3. Select "2: End with a FAIL result", and set the delay time necessary for charging.
- When the test time is set to OFF, the setting of this mode is invalid. Press the **STOP** key to terminate the test.

"0: Test for set time"

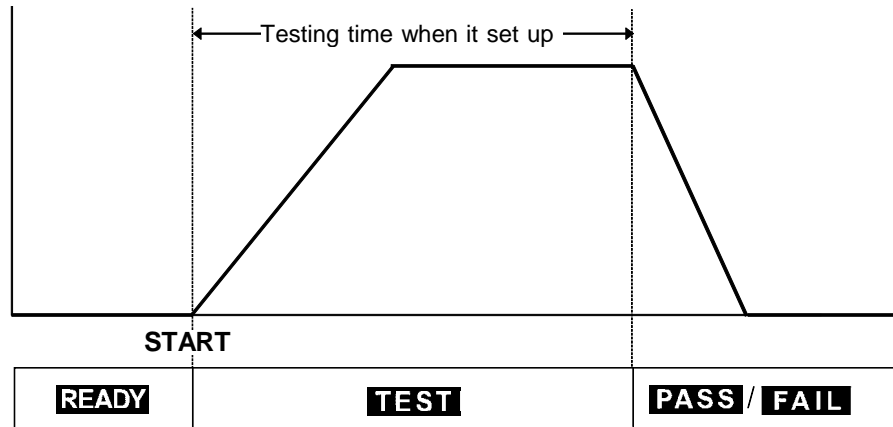

"1: Terminate test at PASS screening"

Set a sufficient delay time.

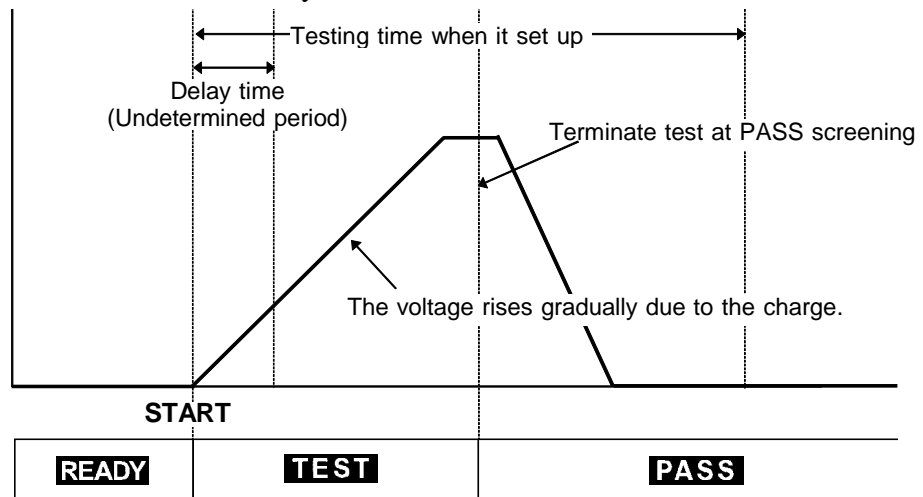

"2: Terminate test at FAIL screening"

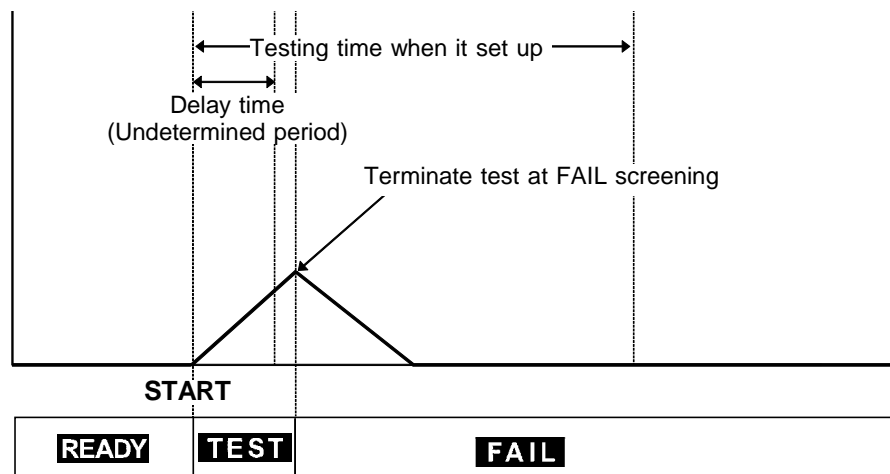

7.12 Setting for Screening during the Ramp-Up Time

Select whether screening is to be performed using the upper-limit value during the ramp-up time in a DC withstand-voltage test.

1. Press **SHIFT** + **STOP** keys while in READY state to display the Optional function setting screen.
2. Move the flashing cursor to the position of **P01** using the ◀/▶ keys, and display **P02** (p. 2) using the ▼/▲ keys.
3. Use the ◀/▶ keys to move the flashing cursor to the position shown in the figure.

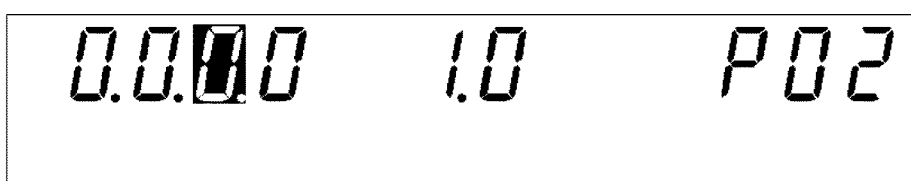

4. Use the ▼/▲ keys to set a value at the flashing cursor location.

0:	No screening during ramp-up time (Initial setting)
1:	Screening during ramp-up time
5. To complete the optional settings, press **SHIFT** + **STOP** keys. The unit reverts to the READY state.

NOTE

- Even when "0: No screening during ramp-up" is selected, screening is performed with 10 mA as the upper-limit value.
- During the ramp-up time in an AC withstand-voltage test, screening using the upper-limit value is performed.
- During the ramp-up time, screening using the lower-limit value is not performed.
- During the ramp-down time, no screening is performed.

7.13 PC Interface

This function enables selection of the PC interface to be used (at the rear of the unit). Make a selection from among RS-232C with a transmission speed of 9,600 bps, RS-232C with a transmission speed of 19,200 bps, and GP-IB.

1. Press **SHIFT + STOP** keys while in READY state to display the Optional function setting screen.
2. Move the flashing cursor to the position of **P01** using the ◀/▶ keys, and display **P02** (p. 2) using the ▼/▲ keys.
3. Use the ◀/▶ keys to move the flashing cursor to the position shown in the figure.

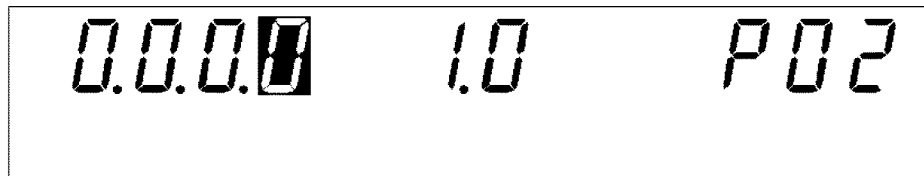

4. Use the ▼/▲ keys to set a value at the flashing cursor location.

0 : RS-232C (PC, 9600 bps)

1 : RS-232C (PC, 19200 bps)

2 : GP-IB (PC)

5. When [2: GP-IB (PC)] is selected, move the flashing cursor to the position illustrated in the figure, and set the GP-IB address using the ▼/▲ keys.

0 ~ 30 (Initial value: 3)

Setting range: 0 to 30 (Initial setting: 3)

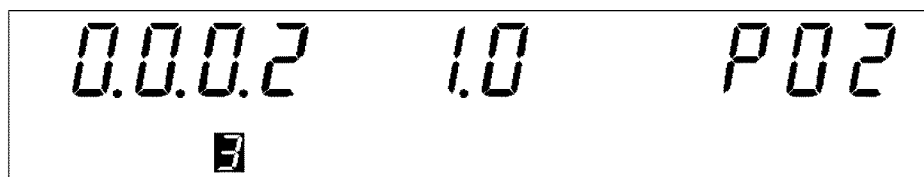

6. To complete the optional settings, press **SHIFT + STOP** keys. The unit reverts to the READY state.

NOTE

When both RS-232C and GP-IB are connected, signals without settings are ignored.

7.14 START Protection Function

This is a function for preventing the unit from starting the next test during discharge time upon completion of each withstand-voltage or insulation-resistance test.

Discharge function

This is a function for discharging electricity from the test object upon completion of each withstand-voltage or insulation-resistance test (discharge resistance: 726 k Ω). During the discharge time, the **DANGER** lamp is lit, even when the test has been terminated. The **DANGER** lamp goes off when the measured voltage drops below approximately 0.03 kV in the case of AC withstand-voltage tests, and below approximately 60 V in the case of DC withstand-voltage and insulation-resistance tests. The larger the capacity component of the test object, the more time is required to discharge the test object.

1. Press **SHIFT** + **STOP** keys while in READY state to display the Optional function setting screen.
2. Move the flashing cursor to the position of **P01** using the **◀/▶** keys, and display **P02** (p. 2) using the **▼/▲** keys.
3. Use the **◀/▶** keys to move the flashing cursor to the position shown in the figure.

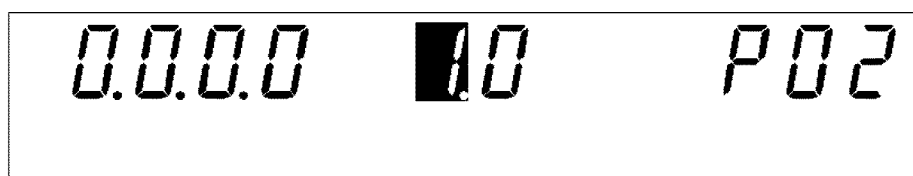

4. Use the **▼/▲** keys to set a value at the flashing cursor location.

0: Not set

1: Set (Initial setting)

5. To complete the optional settings, press **SHIFT** + **STOP** keys. The unit reverts to the READY state.

NOTE

- If the START protection function is used for tests that are to be performed successively, such as tests in auto-test mode or program tests, the unit does not proceed to the next test until completion of discharge, as the discharging function is enabled upon termination of each test (in the meantime, no key operation is accepted).
- Note that if "0: No set" is selected, even when the unit is in READY state upon completion of the test, residual electricity may remain between the output terminals.

7.15 TEST-Signal Output

This function enables selection of whether the external I/O TEST signal output is to include the **TEST** flashing time (ramp-up/down time).

1. Press **SHIFT** + **STOP** keys while in READY state to display the Optional function setting screen.
2. Move the flashing cursor to the position of **P01** using the ◀/▶ keys, and display **P02** (p. 2) using the ▼/▲ keys.
3. Use the ◀/▶ keys to move the flashing cursor to the position shown in the figure.

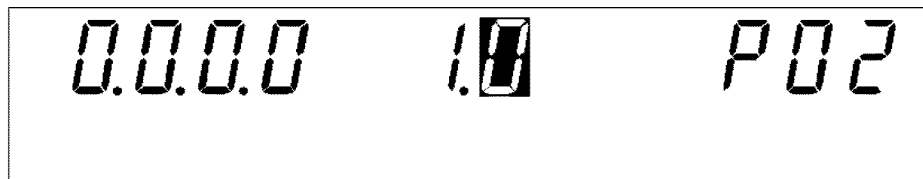

4. Use the ▼/▲ keys to set a value at the flashing cursor location.

0	: TEST signal ON, including while TEST is flashing.
1	: TEST signal OFF, while TEST is flashing
2	: TEST signal ON, only while TEST is flashing (excluding ramp-down time)
5. To complete the optional settings, press **SHIFT** + **STOP** keys. The unit reverts to the READY state.

7.16 Example of Optional Functions Use

The following describes how 3153 optional functions are used for testing. Various combinations of optional functions are possible for testing.

(1) Testing to check test results

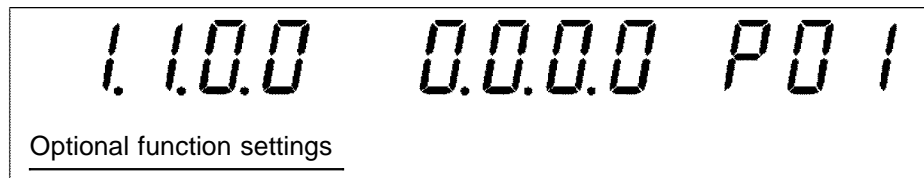

Optional Functions	Selection
PASS Hold Function	1: Held
FAIL Hold Function	1: Held

Advantages of these settings

PASS or FAIL state is held, allowing inspection of test results.

(2) Safe testing by remote control

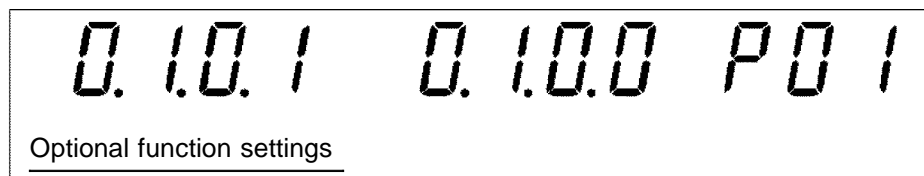

Optional Functions	Selection
FAIL Hold Function	1: Held
Momentary Out	1: Set
FAIL mode	1: Set

Advantages of these settings

- Hold down the **START** key during the test, as the Momentary-Out function is set. The 9614 REMOTE CONTROL BOX (dual hand) must be operated with both hands during the test. This prevents high-voltage devices such as the probe and tested device from coming into contact with the hands.
- The FAIL Hold function must be cancelled using the **STOP** key on the unit, as the FAIL mode is set. The use of the FAIL mode enables the FAIL state to be set.

Chapter 8

Saving/loading Preset Values

8.1 Saving Preset Values

The following describes a function used to save values set in the READY state (withstand-voltage mode or insulation-resistance mode). Up to twenty parameters may be saved.

Up to 10 parameters may be saved in the each mode, such as the withstand-voltage and insulation-resistance modes. To retrieve saved data, follow the procedures described in Section 8.2.

The following parameters can be saved:

Withstand-voltage mode	Test type (AC50 Hz, AC60 Hz, DC), Test-voltage value, Upper-limit value, Lower-limit value, Test time, Ramp-up time, Ramp-down time
Insulation-resistance mode	Test-voltage value, Upper-limit value, Lower-limit value, Test time, Delay time

NOTE

Optional function settings cannot be saved.

8.1.1 Procedure for Saving Data

You must make the settings first before they can be saved. Parameters cannot be changed on the Save screen.

(1) Selecting a test mode

Select the test mode where you want to save settings for the **W** or **I** key.

(2) Displaying the save screen

With the target preset value displayed in the READY state, press **SHIFT** + **▶** keys to shift to the save screen.

In the "save screen", the saved data for the file number replaces the target value displayed in the READY state. The first saved data displayed is the last data from the previous "save screen".

Withstand-voltage mode

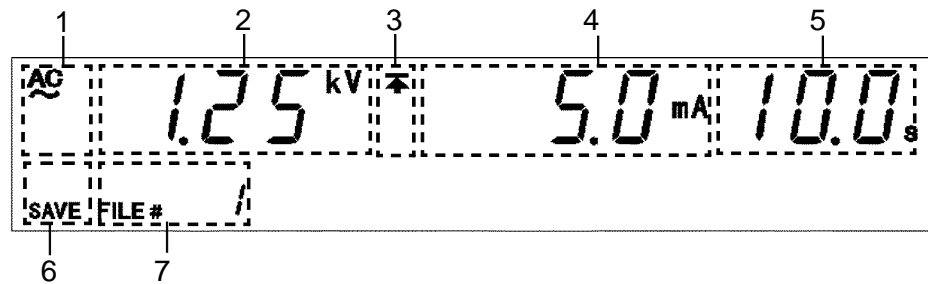

1	Test type	For an AC withstand-voltage test, "AC" is displayed; for a DC withstand-voltage test, "DC" is displayed.
2	Test-voltage value	The test-voltage value for saved data. Press the ◀ key, test frequency is displayed at 「7 File number」. (AC-withstand-voltage mode)
3	Upper-limit value icon and Lower-limit value icon	⬆ is displayed when the upper-limit value is shown, and ⬇ is displayed when the lower-limit value is shown.
4	Upper and Lower-limit values	The upper- or lower-limit value of saved data. Switch the display using the ▶ key.
5	Test time Ramp-up time Ramp-down time	Test time for "saved data," ramp-up time, and ramp-down time. The display is switched using the ON/OFF keys.
6	SAVE	Indicates a save screen.
7	File number	Indicates the file number for the saved data.

Insulation-resistance mode

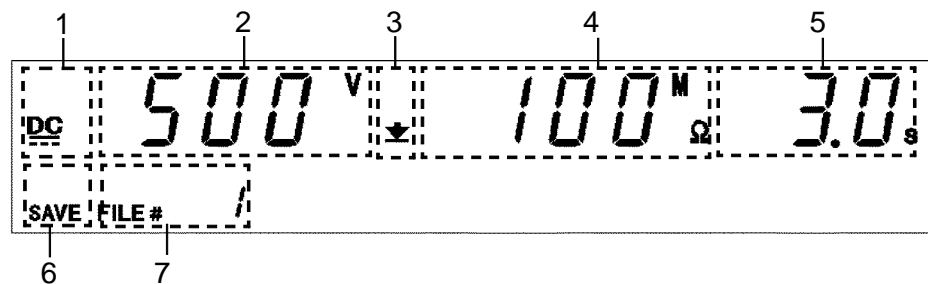

1	Test-voltage value	The test-voltage value for saved data.
2	Upper-limit value icon and Lower-limit value icon	⬆ is displayed when the upper-limit value is shown, and ⬇ is displayed when the lower-limit value is shown.
3	Upper and Lower-limit values	The upper- or lower-limit value of saved data. Switch the display using the ▶ key.
4	Test time Delay time	The test time or delay time for the saved data. Switch the display using the ON/OFF key.
5	SAVE	Indicates a save screen.
6	File number	Indicates the file number for the saved data.

(3) Selecting a file to save

The new data overwrites the previous data. Look for the saved data to be deleted, using the ▼/▲ keys.

Save screen on the withstand-voltage mode

◀ key	Switches between the test-voltage value and test frequency value. (AC-withstand-voltage test)
▶ key	Switches between the upper-limit value and lower-limit value.
ON/OFF key	Switches between the test time and ramp timer time.

Save screen on the insulation-resistance mode

▶ key	Switches between the upper-limit value and lower-limit value.
ON/OFF key	Switches between the test time and delay time.

(4) Saving and canceling data

When the saved data to be deleted is displayed, press **SHIFT** + ▶ keys. This deletes the saved data and saves the value set in the READY state.

After the saving the data, the unit reverts to the READY state.

Press the **STOP** key to revert to the READY state without saving the target data.

NOTE

If the preset values are OFF, the information that they are OFF is saved. The value that is effective when they are switched ON using the **ON/OFF** key in the READY state is also saved.

(When the preset values are switched ON, the delay time in the insulation-resistance mode is set to 0.1 s.)

8.1.2 Example of Saving

The following example shows how to save in File No.3. We assume that the 3153 is in the READY state.

1. Make the settings that you want to save in the SETTING state and the unit returns to the READY state.

For more information on making these settings, see Chapter 3.

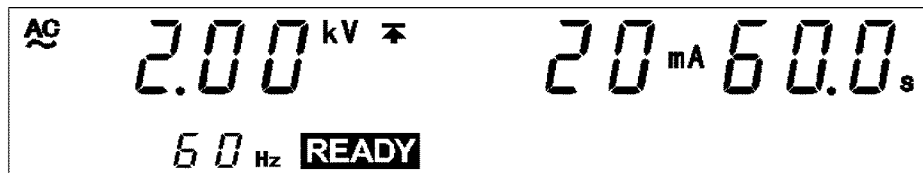

In this example, settings are made as follows:

Test type: AC 60 Hz
 Test-voltage value: 2.00 kV
 Upper-limit value: 20 mA
 Lower-limit value: OFF
 Test time: 60.0 s
 Ramp-up time: 10.0 s
 Ramp-down time: OFF

2. Press **SHIFT** + **▶** keys to bring up the save screen.

In the save screen, the value set in the READY state is replaced by the saved data being displayed. The first saved data displayed is the last data item from the previous save screen. This example shows "File No.1."

The new data overwrites the previous data. Use the **▼/▲** keys to select the data to be overwritten. The new data in this example is to be saved in File No.3.

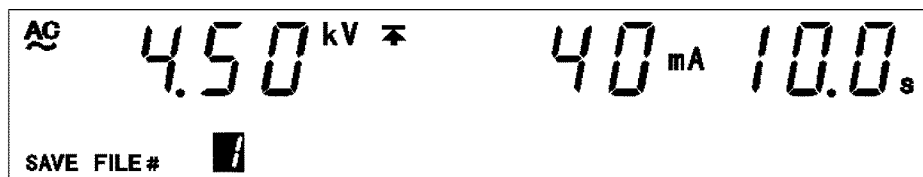

At this time, the "test frequency" can be confirmed using the **◀** key, the "lower-limit value" can be confirmed using the **▶** key, and the "ramp-up/down time" can be confirmed using the **ON/OFF** key.

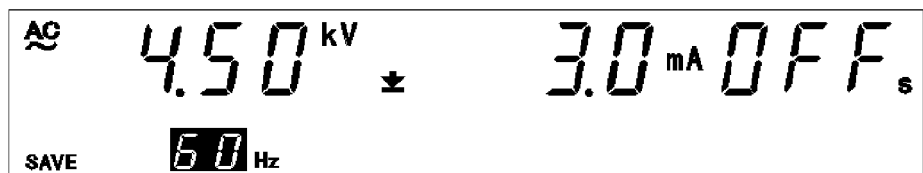

In this example, File No. 1 contains the following settings.

Test type: AC 60 Hz
 Test-voltage value: 4.50 kV
 Upper-limit value: 40 mA
 Lower-limit value: 3 mA
 Test time: 10.0 s
 Ramp-up time: OFF
 Ramp-down time: OFF

3. Use the $\blacktriangledown/\blacktriangle$ keys to select File No.3.

If a test frequency is displayed in "File number," press the \blacktriangleleft key to display the file number.

This example shows File No. 1. Press the \blacktriangle key twice to display File No.3.

The digital display shows the following information: AC symbol, 2.00 kV with a tilde symbol, 20 mA, 0.5 s, and SAVE FILE # 1.

4. The "test voltage" and "test frequency" can be confirmed using the \blacktriangleleft key, the "upper-limit value" and "lower-limit value" can be confirmed using the \blacktriangleright key, and the "test time" and "ramp-up/down time" can be confirmed using the ON/OFF key.

The digital display shows the following information: AC symbol, 2.00 kV with a tilde symbol, OFF mA, OFF s, and SAVE 50 Hz.

8

In this example, File No. 3 contains the following settings.

Test type: AC 50 Hz
 Test-voltage value: 2.00 kV
 Upper-limit value: 20 mA
 Lower-limit value: OFF
 Test time: 0.5 s
 Ramp-up time: OFF
 Ramp-down time: OFF

5. If a test frequency is displayed in "File number," press the \blacktriangleleft key to display the file number.

To save the data, press **SHIFT** + \blacktriangleright keys. The unit reverts to the READY state. Once saved, the value set in the READY state is retained in File No.3. Note that File No.3, shown in Step (4) above, is deleted.

The digital display shows the following information: AC symbol, 2.00 kV with a tilde symbol, 20 mA, 600.0 s, 50 Hz, and a black box containing the word READY.

To abort the save procedure, press the **STOP** key at Step (4). The unit halts the save procedure and reverts to the READY state.

8.2 Loading Preset Values

The following describes how to load saved data.

Up to 10 data items may be saved in the each mode, such as the voltage and insulation-resistance modes. Use this function to instantly change a preset value.

The following parameters can be saved:

Withstand-voltage mode	Test type (AC50 Hz, AC60 Hz, DC), Test-voltage value, Upper-limit value, Lower-limit value, Test time, Ramp-up time, Ramp-down time
Insulation-resistance mode	Test-voltage value, Upper-limit value, Lower-limit value, Test time, Delay time

8.2.1 Procedure for Loading Data

(1) Selecting a test mode

Select the test mode where you want to save settings for the **W** or **I** key.

(2) Displaying the load screen

Press **SHIFT** + ◀ keys in the **READY** state to shift to the load screen.

In the load screen, a number for saved data equal to the file preset replaces the target value displayed in the **READY** state.

The first saved data displayed is the last data from the previous load screen.

Withstand-voltage mode

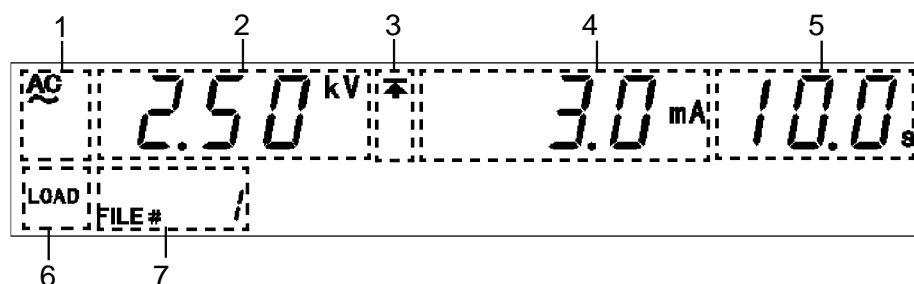

1	Test type	For an AC withstand-voltage test, "AC" is displayed; for a DC withstand-voltage test, "DC" is displayed.
2	Test-voltage value	The test-voltage value for saved data. Press the ◀ key, test frequency is displayed at 「7 File number」. (AC-withstand-voltage mode)
3	Upper-limit value icon and Lower-limit value icon	⬆ is displayed when the upper-limit value is shown, and ⬇ is displayed when the lower-limit value is shown.
4	Upper and Lower-limit values	The upper- or lower-limit value of saved data. Switch the display using the ▶ key.
5	Test time Ramp-up time Ramp-down time	Test time for "saved data," ramp-up time, and ramp-down time. The display is switched using the ON/OFF keys.
6	LOAD	Indicates a load screen.
7	File number	Indicates the file number for the saved data.

Insulation-resistance mode

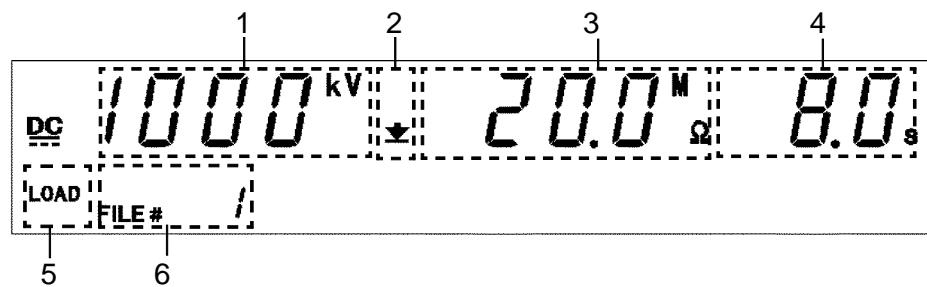

1	Test-voltage value	The test-voltage value for saved data.
2	Upper-limit value icon and Lower-limit value icon	▲ is displayed when the upper-limit value is shown, and ▼ is displayed when the lower-limit value is shown.
3	Upper and Lower-limit values	The upper- or lower-limit value of saved data. Switch the display using the ► key.
4	Test time and delay time	The test time or delay time for the saved data. Switch the display using the ON/OFF key.
5	LOAD	Indicates a load screen.
6	File number	Indicates the file number for the saved data.

NOTE

When a test-voltage value greater than the value set in the optional function "Section 7.9 Setting of the Output-Voltage Restricting Value" is loaded, an error will occur upon startup of the test (the test-voltage value flashes), and the test cannot be performed.

(3) Selecting a file to load

Use the ▼/▲ keys to change the file number and confirm the saved data that you want to load.

In the "load screen" in the withstand-voltage mode, the display of the "test voltage" and "test frequency" (in the case of AC-withstand-voltage test) can be changed using the ◀ key, the "upper-limit value" and "lower-limit value" can be changed using the ► key, and the "test time" and "ramp timer time" can be changed using the **ON/OFF** key.

In the "load screen" in the insulation-resistance mode, the display of the "upper-limit value" and "lower-limit value" can be changed using the ► key, and the "test time" and "delay time" can be changed using the **ON/OFF** key.

(4) Loading and canceling data

When the saved data to be loaded is displayed, press **SHIFT** + ◀ keys. This loads the saved data and the unit reverts to the READY state.

Press the **STOP** key to revert to the READY state without loading the target data.

8.2.2 Example of Loading

The following example shows how to load File No.3. The 3153 is in the withstand-voltage mode READY state.

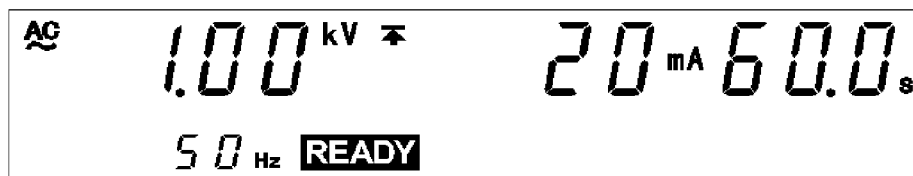

1. Press **SHIFT** + **◀** keys to bring up the load screen.

In the load screen, the value set in the READY state is replaced by the saved data being displayed. The first saved data displayed is the last data item from the previous load screen. This example shows "File No.1."

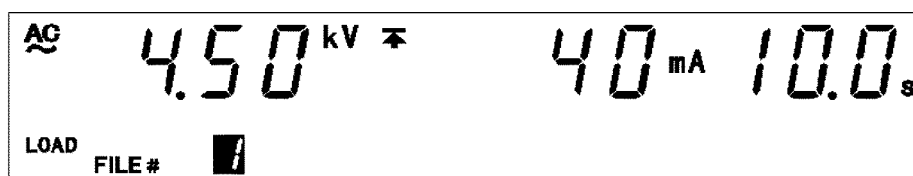

At this time, the "test frequency" (in the case of AC-withstand-voltage) can be confirmed using the **◀** key, the "lower-limit value" can be confirmed using the **▶** key, and the "ramp-up/down time" can be confirmed using the **ON/OFF** key.

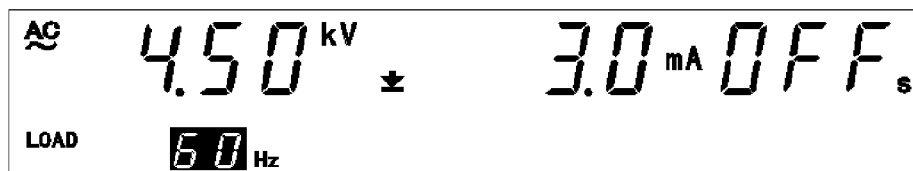

In this example, File No. 1 contains the following settings.

Test type: AC 60 Hz
 Test-voltage value: 4.5 kV
 Upper-limit value: 40 mA
 Lower-limit value: 3 mA
 Test time: 10.0 s
 Ramp-up time: OFF
 Ramp-down time: OFF

2. Use the ∇/\blacktriangle keys to select File No.3.

If a test frequency is displayed in "File number," press the \blacktriangleleft key to display the file number.

This example shows File No. 1. Press the \blacktriangle key twice to display File No.3.

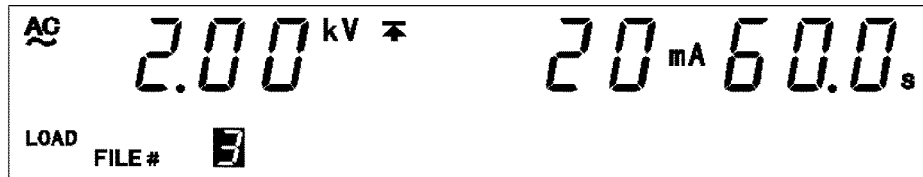

3. The "test voltage" and "test frequency" (in the case of AC-withstand-voltage) can be confirmed using the \blacktriangleleft key, the "upper-limit value" and "lower-limit value" can be confirmed using the \blacktriangleright key, and the "test time" and "ramp-up/down time" can be confirmed using the **ON/OFF** key.

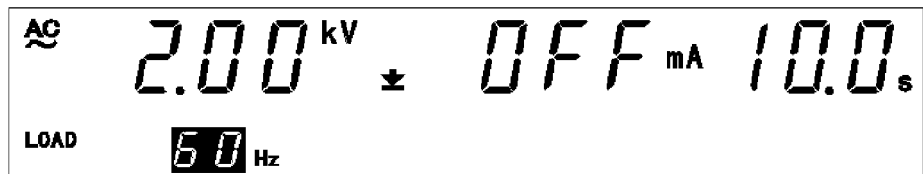

In this example, File No. 3 contains the following settings.

Test type: AC 60 Hz
 Test-voltage value: 2.00 kV
 Upper-limit value: 20 mA
 Lower-limit value: OFF
 Test time: 60.0 s
 Ramp-up time: 10.0 s
 Ramp-down time: OFF

4. If a test frequency is displayed in "File number," press the \blacktriangleleft key to display the file number.

To load the data, press **SHIFT** + \blacktriangleright keys. The unit reverts to the **READY** state. To abort the load procedure, press the **STOP** key.

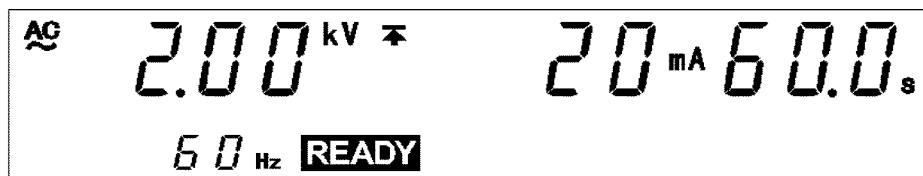

Chapter 9

External Interface



9.1 External I/O Terminal

The output of signals regarding the status of the unit (such as the TEST state) and decisions (such as FAIL), along with control signals such as START and STOP signals and file selection signals for program tests, are controlled through the external I/O terminal, which is located at the rear of the unit. In addition, an interlock terminal is provided to ensure safety. All signal lines are insulated internally with a photocoupler. A power voltage of 5 V (60 mA), insulated from the internal supply, is output from the external I/O terminal. This voltage can be used as external power. If the unit power capacity is insufficient, add an external power supply.

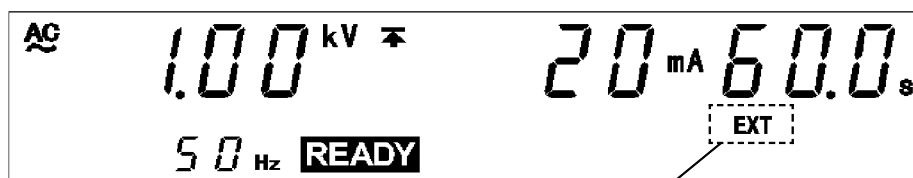

When EXT-E of the external I/O terminal is at LOW level, EXT lights up when the REMOTE CONTROL BOX is active.

NOTE

- There is a priority hierarchy for the **START** keys. When a **START** key with a higher priority is in use, lower-priority keys are disabled. (When EXT-E of the external I/O terminal is at LOW level (EXT lights up), the unit **START** key is disabled.) If you use the REMOTE CONTROL BOX, the START signal for the external I/O terminal is disabled.)
Priority: REMOTE CONTROL BOX > External I/O > Front panel of the unit.
- Do not short circuit the external I/O signal line and power source with the voltage output (HIGH, LOW). Put the high voltage lead of the voltage output (HIGH, LOW) as far away as possible from the test objects as inaccurate operations may occur due to noise.

9.1.1 Signal Line

Use the following external I/O connectors or their equivalents:

(1) Compatible connector

DDK Ltd.'s 57-30360, 57E-30360, 57F-30360 and 57FE-30360
Hirose Electric's RC30-36P(50)

(2) External I/O connector pin numbering

DDK Ltd.'s 57RE-40360-730B (D29) (Connector of the 3153 main unit)

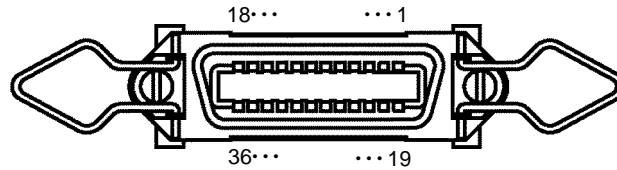

Pin number	I/O	Signal line name	Pin number	I/O	Signal line name
1	OUT	READY	19	OUT	STEP-END
2	OUT	L-FAIL	20	OUT	FILE-END
3	OUT	U-FAIL	21	IN	FILE-E
4	OUT	PASS	22	IN	FILE-0
5	OUT	TEST	23	IN	FILE-1
6	OUT	H.V.ON	24	IN	FILE-2
7	IN	EXT-E	25	IN	FILE-3
8	IN	START	26	IN	FILE-4
9	IN	STOP	27	OUT	Not used
10	IN	INT.LOCK	28	OUT	Not used
11	OUT	W-MODE	29	OUT	Not used
12	OUT	I-MODE	30	OUT	Not used
13	OUT	W-FAIL	31	OUT	Not used
14	OUT	I-FAIL	32	OUT	Not used
15	OUT	ISO.GND	33	OUT	ISO.DCV
16	OUT	ISO.GND	34	OUT	ISO.DCV
17	IN	EXT.COM	35	IN	EXT.DCV
18	IN	EXT.COM	36	IN	EXT.DCV

(3) Function of the signal line

Signal line name	I/O	Function
READY	OUT	LOW level in the READY state
L-FAIL	OUT	LOW level in the FAIL state at LOWER (minimum value)
U-FAIL	OUT	LOW level in the FAIL state at UPPER (maximum value)
PASS	OUT	LOW level in the PASS state
TEST	OUT	LOW level in the TEST state
H.V.ON	OUT	LOW level when a voltage is generated in the output terminal
EXT-E	IN	At LOW level, the external I/O input signal is active. INT.LOCK or STOP remains active regardless of this signal.
START	IN	LOW level is equivalent to pressing the unit START key and provides the same functions.
STOP	IN	LOW level is equivalent to pressing the unit STOP key and provides the same functions. This signal is valid regardless of EXT-E status.
INT.LOCK	IN	Inter-lock function terminal. This signal is always active regardless of the status of the EXT-E terminal. When connected to ISO.GND, this terminal cancels the Inter-lock function, enabling the unit to function properly. When disconnected, the terminal disables all keys. To activate the Inter-lock function, set the optional Inter-lock function to "1: Set." Use this terminal for a protective device against electric shock that uses an area sensor or the like. See Section 9.1.4.
W-MODE	OUT	LOW level when performing a withstand-voltage test in the withstand-voltage test screen.
I-MODE	OUT	LOW level when performing an insulation-resistance test in the insulation-resistance test screen.
W-FAIL	OUT	LOW level in FAIL state during a withstand-voltage test.
I-FAIL	OUT	LOW level in FAIL state during an insulation-resistance test.
STEP-END	OUT	LOW level upon completion of one step in a program test.
FILE-END	OUT	LOW level upon completion of one file in a program test.
FILE-E	IN	At LOW level, the file selection terminal (FILE-0 to 4) is active.
FILE-0 ~ 4	IN	Program test-file selection terminal.
ISO.GND	OUT	Outputs a GND, insulated from the internal GND for the unit. Used to temporarily activate the external I/O function.
EXT.COM	IN	Terminal common to each output terminal.
ISO.DCV	OUT	Outputs a power voltage of 5 V (60 mA), isolated from the internal power supply. Used to temporarily activate the external I/O function.
EXT.DCV	IN	Terminal for supplying power from the outside. Input power-voltage range: DC 5 to 30 V

9.1.2 Example of Input Signal Connection

The unit can be controlled externally using the external I/O input signal. Program test files can also be selected. Provide a connector that conforms to the external I/O specifications.

To enable the external I/O signal, set the EXT-E signal (Pin 7) to LOW level. Connect the EXT-E signal to ISO.GND for the GND signal (Pins 15, 16), which is insulated from the unit's internal power supply.

To enable the file selection terminal, set the FILE-E signal (pin 21) to LOW level. To load a file, Connect the FILE-E signal to ISO.GND for the GND signal (Pins 15, 16), which is insulated from the unit's internal power supply. See Section 9.15.

EXT I/O Input signals Specifications

External power supply	V_{EXT} : EXT.DCV-EXT.COM
Maximum external input voltage	30 V DC
Minimum external input voltage	5 V DC
Input signal	Active low input (photocoupler isolated)
HIGH level voltage (HI)	Maximum : $V_{EXT} + 1 \text{ V}$ (30 V DC or less) Minimum : $V_{EXT} - 1.5 \text{ V}$
LOW level voltage (LO)	Maximum : $V_{EXT} - 4 \text{ V}$ Minimum : 0 V
Input signals	EXT-E, START, STOP, INT.LOCK, FILE-E, FILE-0 to 4

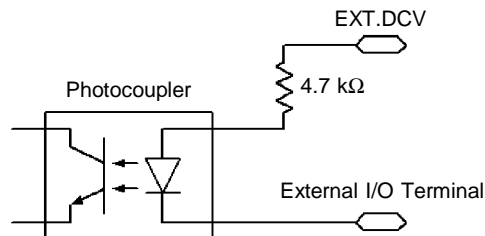

(1) Control using the external switch (When the internal power supply is used)

To control the START and STOP signals using a relay or switch, make connections as shown below:

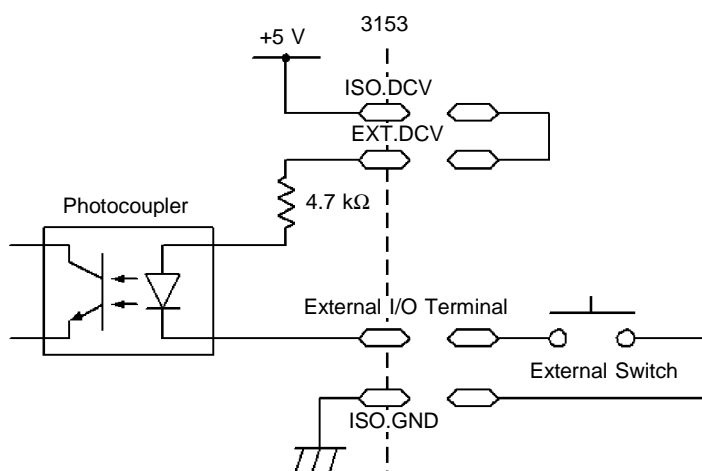

NOTE

For connection to the input signal, provide a circuit that protects the relay and switch from chattering to prevent malfunctioning.

(2) Control using the transistor (When the external power supply is used)

For control using a transistor or FET, make connections as shown below. Design the signals so that 6 mA is absorbed into each of the signals.

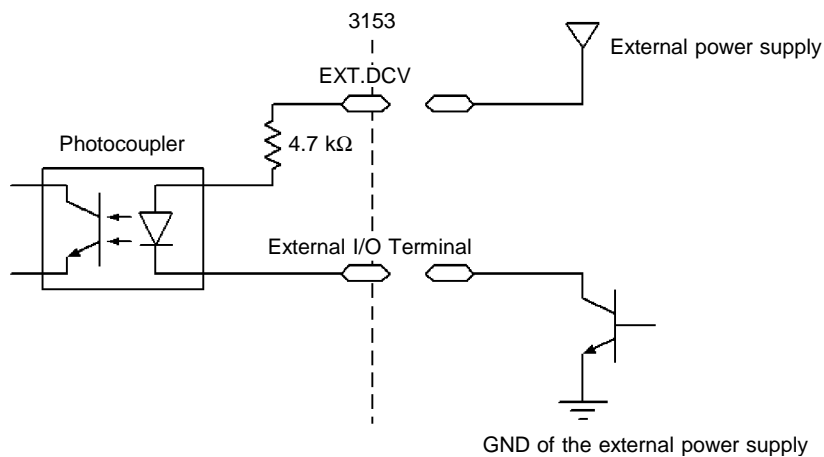

9.1.3 Example of Output Signal Connection

The output signal becomes LOW level depending on the condition of the unit. Prepare a connector that conforms to the External I/O Specifications. See Section 9.1.6.

EXT I/O Output signals Specifications

Output signal	Open collector output (Pull-up resistance: 4.7 k Ω)
Maximum output current	DC60 mA/1
HIGH level voltage (HI)	Minimum : $V_{EXT} - 0.5 \text{ V}$ (No load)
LOW level voltage (LO)	Maximum : 0.5 V (TYP.)
Output signals	READY, U-FAIL, L-FAIL, PASS, TEST, H.V.ON, W-MODE, I-MODE, W-FAIL, I-FAIL

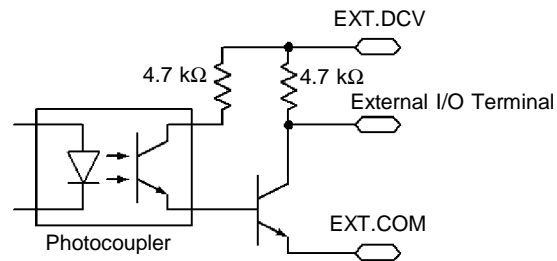

(1) Controlling the relay (When the external power supply is used)

To link the relay to an external device, make connections as shown below.

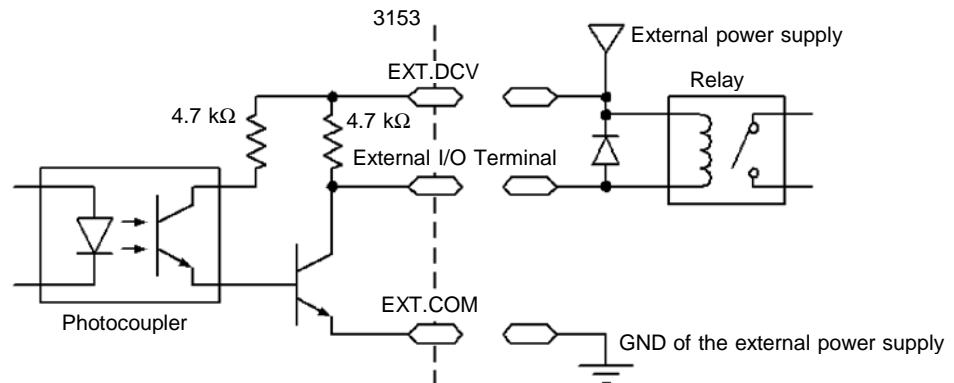

NOTE

- A signal can absorb up to 60 mA.
- If the current capacity is not sufficient, connect a transistor or the like to the outside in order to amplify the current.
- When connecting an inductive load such as a relay, connect the diode in parallel with the coil.

(2) Obtaining a signal limit (When the internal power supply is used)

To obtain a signal limit, make connections as shown below. In addition, check the output current.

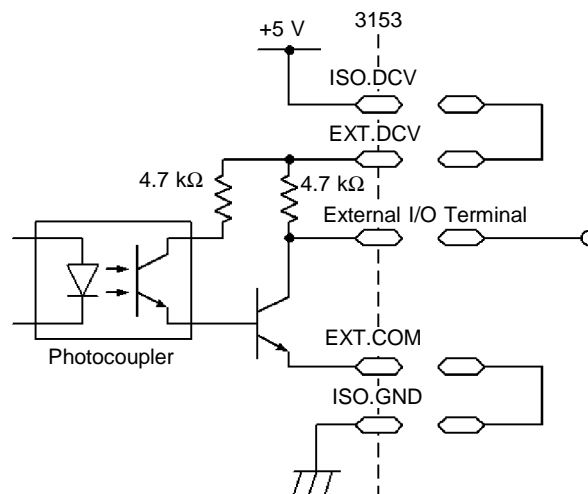

NOTE

The output signal status upon power-on may be undetermined. Care should be taken in the operation of equipment connected to the external I/O.

9.1.4 Inter-lock Function

The inter-lock function is used to cut off output from the 3153 in combination with other devices, including external equipment. This function cuts off output from the 3153, and disables all key operations.

(1) Setting the inter-lock function

1. Connect Pin 10 INT.LOCK on the external I/O terminal to ISO.GND (Pins 15, 16), and set the pin to Lo. Connect EXT.DCV and ISO.DCV.
2. In Optional Functions, set "Inter-lock" to "1: Set."

For the optional function settings, see Section "7.8 Inter-lock Function".

NOTE

- The INT.LOCK terminal is always active, regardless of the status of the EXT-E terminal.
- If "0: Not set" is selected for "Inter-lock" in Optional Functions, the inter-lock function is inactive, regardless of the status of the INT.LOCK terminal. The function is set at "0: Not set" by default. If the inter-lock function is to be used, be sure to select "1: Set."
- When the INT.LOCK terminal is not LOW level, the optional Inter-lock function cannot be set to "1: Set."

(2) Using the inter-lock function

The inter-lock function is active when the INT.LOCK terminal is open, with the following displayed:

To disable the function, connect the INT.LOCK terminal to ISO.GND and set it to LOW level. The unit changes to READY status once the inter-lock function is disabled.

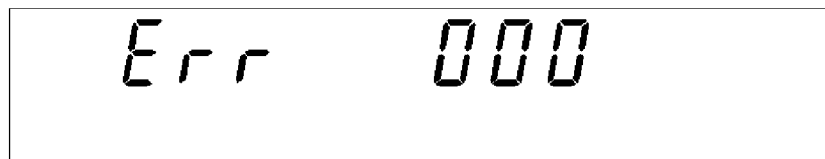

(3) Connections for the inter-lock function

For example, to ensure the safety of workers, the unit and the tested object are placed in a box so that they are not in contact with each other. The door of the box cover is also equipped with a switch that works in combination with the inter-lock function. If a connection is made to the switch, the inter-lock function is enabled when the box cover is opened. When the cover is closed, the function is disabled, making the unit ready for testing.

All keys are inactive provided that the inter-lock function is active. As a result, once the unit is mounted in the box, the settings cannot be changed. In such a case, connect the setting adjustment switch the door switch such that these switches are arranged in parallel, as shown below:

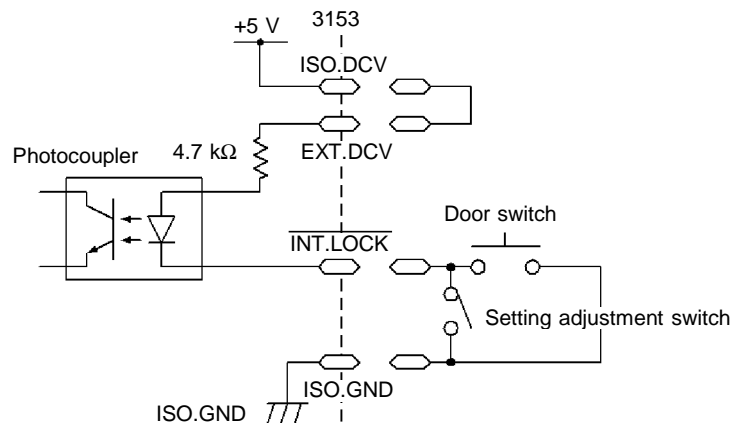

9.1.5 Selecting a Program Test File

By setting the test mode of this unit to program mode in advance, through the FILE-E and FILE-0 to 4 terminals of the external I/O terminal, program test files can be selected.

1. Connect the EXT.E (pin 7) of the external I/O terminal to the ISO GND (pins 15 and 16). In addition, connect EXT.DCV and ISO.DCV.
2. Select a file by combining the FILE-0 to 4 signals (see the "File selection terminal and file numbers" table).
3. When the FILE-E terminal is set to LOW level in the program-mode READY state, the file of the number selected in 2. is loaded.



Do not load files via the external I/O during a file operation such as by operating the keys or communicating via RS-232C.

File selection terminal and file numbers

File No.	File selection termina				
	FILE-4	FILE-3	FILE-2	FILE-1	FILE-0
1	HI	HI	HI	HI	HI
2	HI	HI	HI	HI	LO
3	HI	HI	HI	LO	HI
4	HI	HI	HI	LO	LO
5	HI	HI	LO	HI	HI
6	HI	HI	LO	HI	LO
7	HI	HI	LO	LO	HI
8	HI	HI	LO	LO	LO
9	HI	LO	HI	HI	HI
10	HI	LO	HI	HI	LO
11	HI	LO	HI	LO	HI
12	HI	LO	HI	LO	LO
13	HI	LO	LO	HI	HI
14	HI	LO	LO	HI	LO
15	HI	LO	LO	LO	HI
16	HI	LO	LO	LO	LO
17	LO	HI	HI	HI	HI
18	LO	HI	HI	HI	LO
19	LO	HI	HI	LO	HI
20	LO	HI	HI	LO	LO
21	LO	HI	LO	HI	HI
22	LO	HI	LO	HI	LO
23	LO	HI	LO	LO	HI
24	LO	HI	LO	LO	LO
25	LO	LO	HI	HI	HI
26	LO	LO	HI	HI	LO
27	LO	LO	HI	LO	HI
28	LO	LO	HI	LO	LO
29	LO	LO	LO	HI	HI
30	LO	LO	LO	HI	LO
31	LO	LO	LO	LO	HI
32	LO	LO	LO	LO	LO

9.1.6 Timing Chart of External I/O Terminal

(1) Timing chart at time of start of testing

When a test begins, the READY signal becomes HIGH level, and the TEST signal and H.V.ON signal become LOW level.

The H.V.ON signal becomes LOW level with the voltage output.

The TEST signal changes at the same time **TEST** on the fluorescent indicator changes.

Withstand-voltage mode

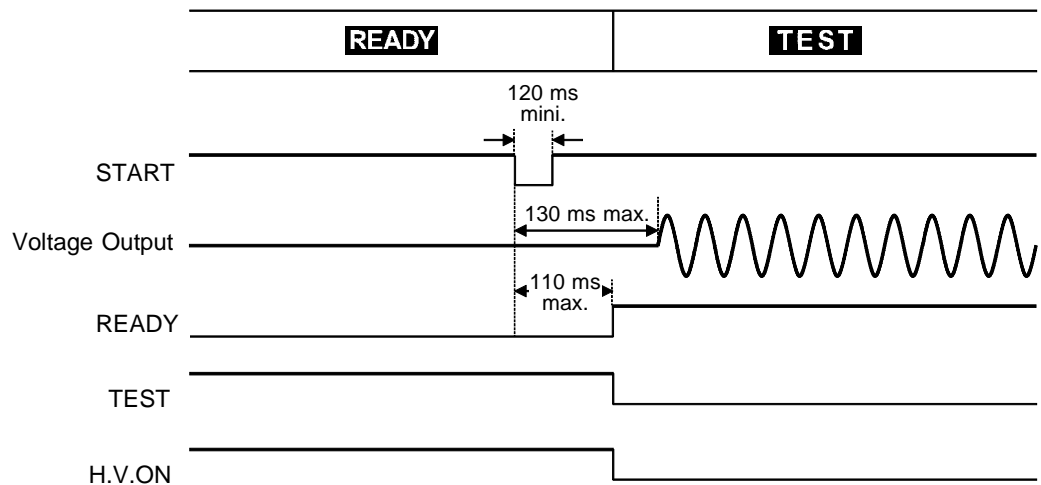

Insulation-resistance mode

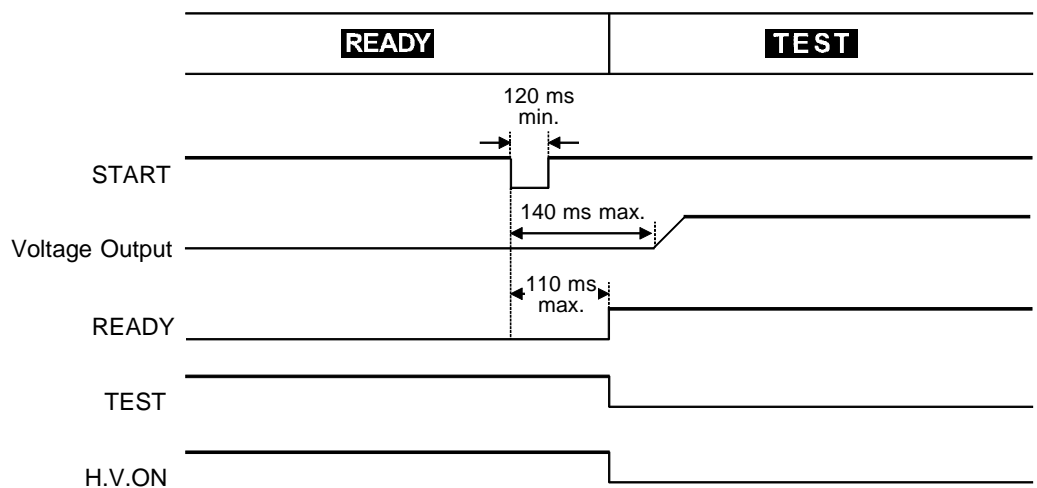

(2) Timing chart during a test decision

The figure shows the timing chart of the unit in PASS state after a test. In PASS state, the TEST signal indicates HIGH level.

The H.V.ON signal remains at LOW level provided that the voltage between the output terminals remains unchanged, as the signal is synchronized with the **DANGER** lamp. (Below 30 VAC when performing an AC-withstand-voltage test, or below 60 VDC when performing a DC-withstand-voltage test or an insulation-resistance test)

Once the voltage reaches 0, the signal changes to HIGH level.

The PASS signal changes according to the **PASS** indicator on the fluorescent display. If the PASS hold function is enabled, the PASS signal continues to indicate LOW level until the function is disabled.

When the Hold function is disabled or the unit automatically returns to the READY state, the PASS signal becomes HIGH level and the READY signal becomes LOW level.

In the program mode, as soon as the PASS signal enters LOW level, the FILE-END signal enters LOW level (100 ms) as well.

Withstand-voltage mode (When the PASS hold function is not used)

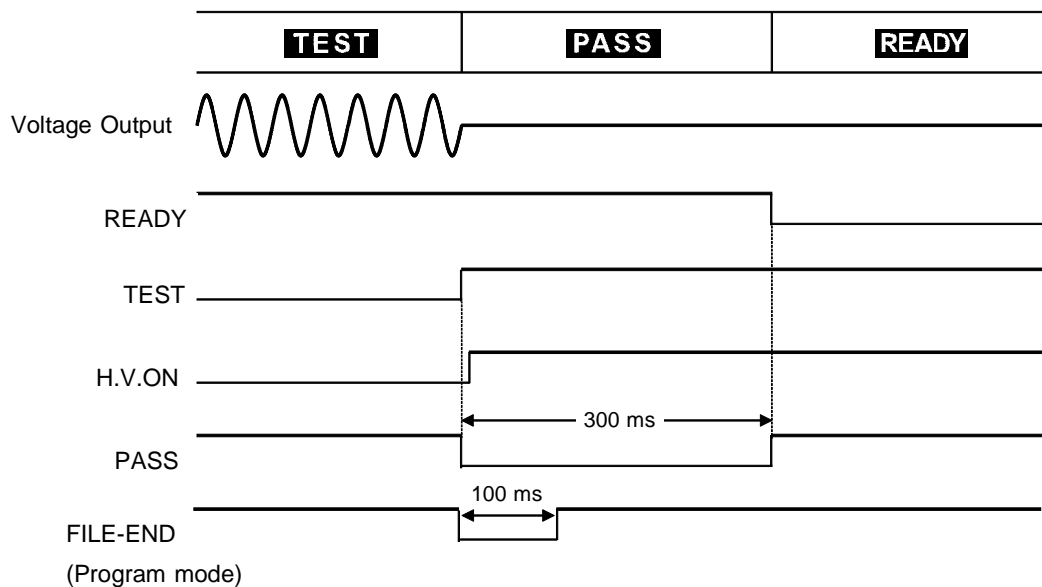

Insulation-resistance mode (When the PASS hold function is not used)

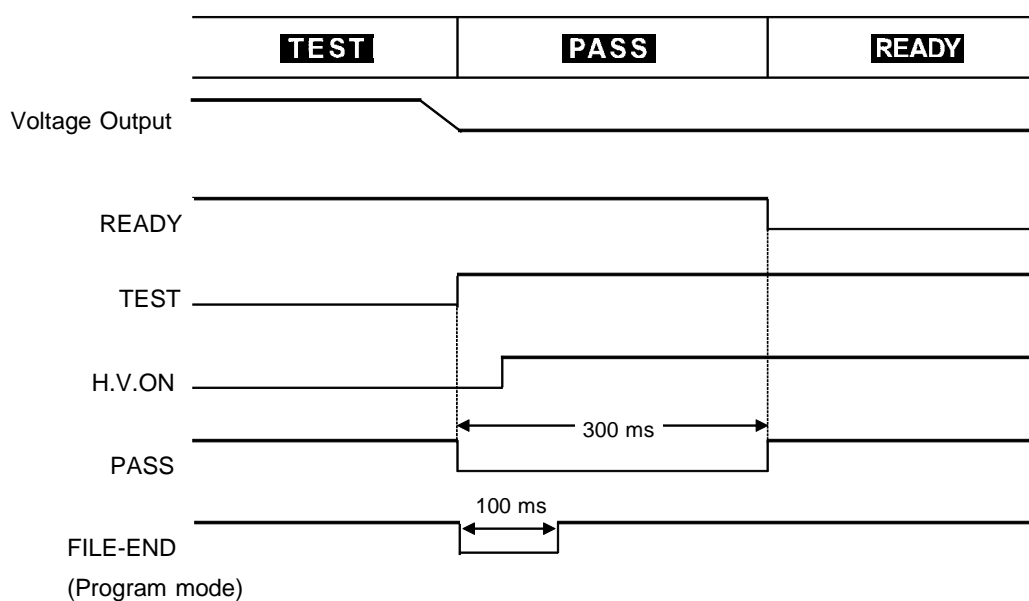

Even in the FAIL state, when UPPER FAIL is activated, the U-FAIL signal becomes LOW level. Similarly, with LOWER-FAIL, the L-FAIL signal becomes LOW level. When the FAIL Hold function is set, the signal remains at LOW level until the Hold function is disabled.

If a withstand-voltage test fails, the W-FAIL signal becomes LOW level. Similarly, if an insulation-resistance test fails, the I-FAIL signal becomes LOW level.

When the Hold function is disabled or the unit automatically returns to the READY state, the PASS signal becomes HIGH level and the READY signal becomes LOW level.

In the program mode, as soon as the FAIL signal enters LOW level, the FILE-END signal enters LOW level (100 ms) as well, as in the case of a PASS result.

(3) Timing chart at forced termination

When the **STOP** key is pressed to forcibly terminate testing, the unit does not change to either PASS or FAIL status, as test screening is not performed. In this case, the signal becomes HIGH level. In the absence of status indicators (READY/TEST/FAIL/PASS) -- in the SETTING state, when set values are being saved or loaded, or when settings are being made for the optional functions -- all signals become HIGH level.

Withstand-voltage mode (when the hold function is not used)

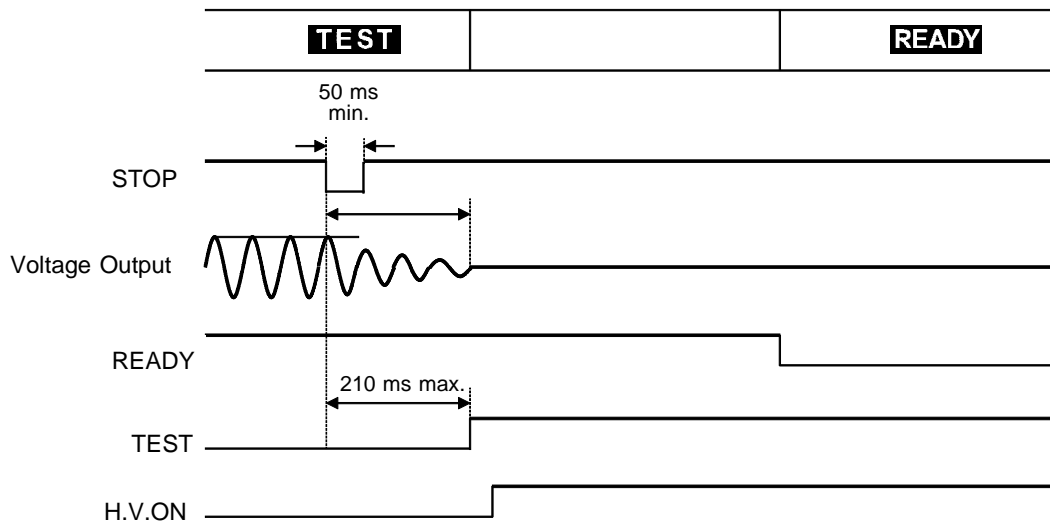

Insulation-resistance mode (when the hold function is not used)

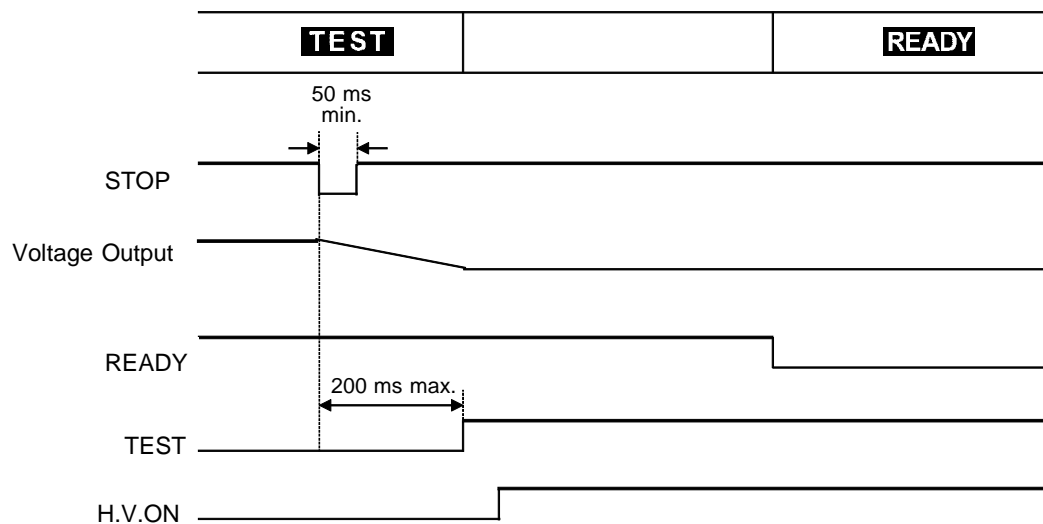

(4) Auto-test-mode and program-mode switching timing chart

This figure shows the switching timing chart of the unit when it is in the auto-test mode. In this mode, withstand-voltage and insulation-resistance tests are conducted successively. The unit switches to the next test when the output-voltage value has dropped sufficiently. The TEST signal remains at LOW level until a series of tests is completed. In the program mode, each time a test is completed, the STEP-END signal enters LOW level.

Withstand-voltage test → Insulation-resistance test

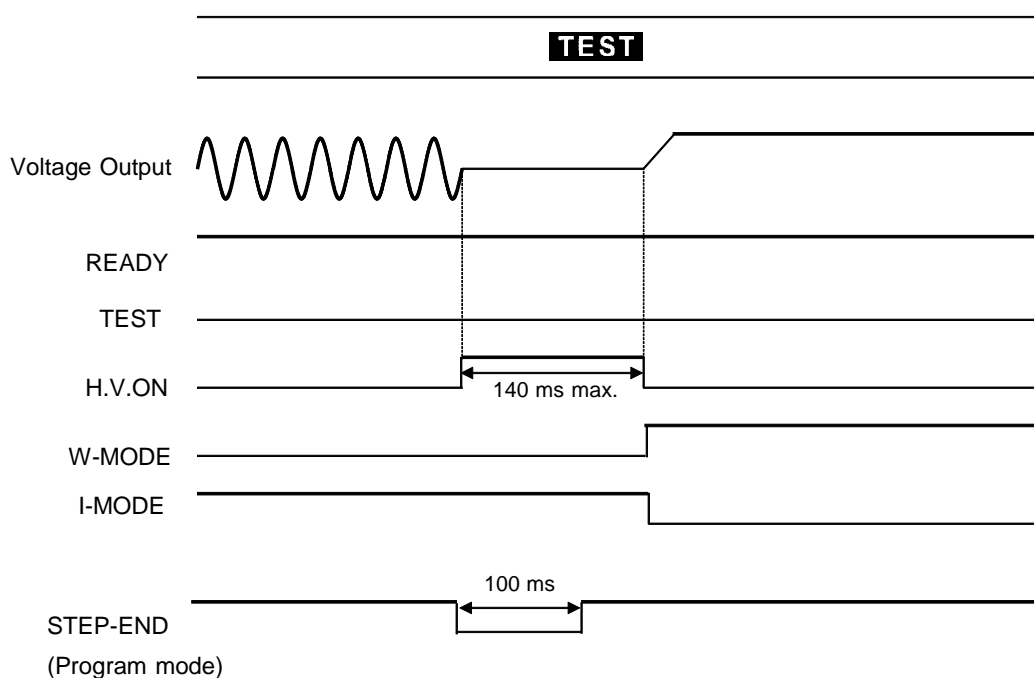

Insulation-resistance test → Withstand-voltage test

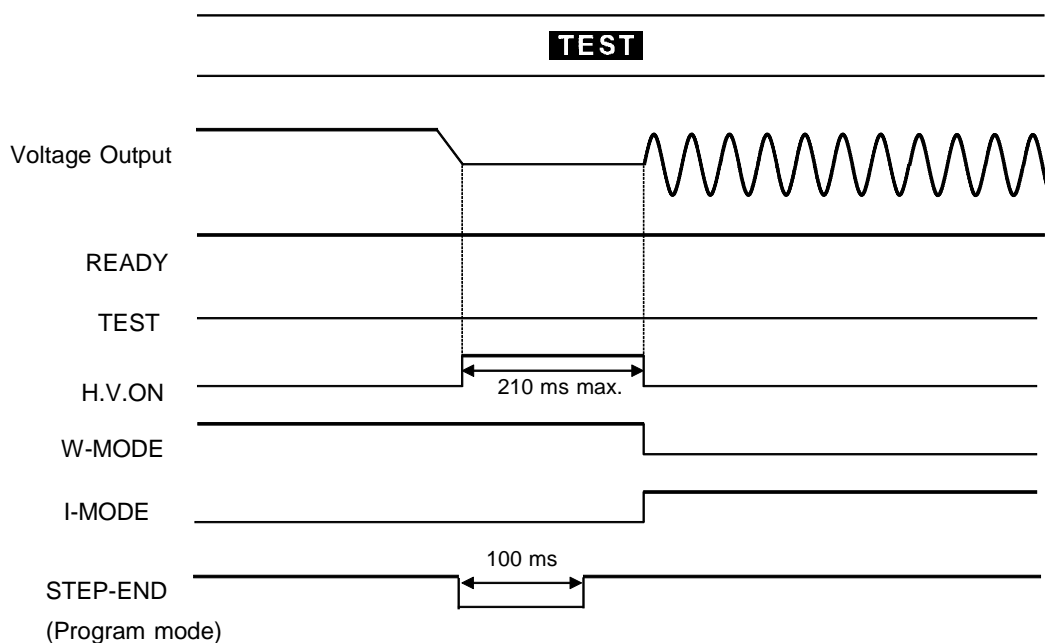

9.2 Buzzer

A buzzer sounds during PASS or FAIL screening and in the event of an error due to improper key operations. Two buzzer volume adjustment knobs are provided on the rear panel: one for PASS screening and one for FAIL screening. Volume adjustments can be made using the knobs.

1. Check the analog voltmeter and the **DANGER** lamp to make sure a voltage is not being output.
2. Using a screwdriver, adjust the volume adjustment knob. To increase the volume, turn the knob clockwise. To decrease it, turn it counterclockwise.

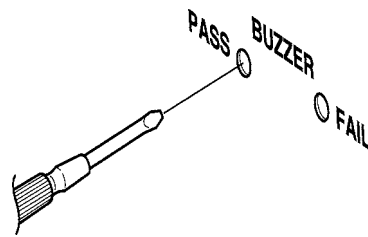

NOTE

- If an excessive force is placed on the volume adjustment knob, it may be fractured.
- The buzzer that sounds in the event of an error caused by improper key operations is at the same volume as the buzzer that sounds for FAIL screening.



Chapter 10

PC Interface



10.1 RS-232C Interface



10.1.1 Specifications

The RS-232C settings of 3153 are as follows. As the settings are fixed and cannot be changed except for the transmission speed, these settings must be the same on the computer side. The transmission speed can be selected by enabling an optional function. See Chapter 7 "Optional functions."

(1) RS-232C Settings

Transmission mode	Start-stop synchronization, full duplex
Transfer rate	9600 bps/ 19200 bps
Data length	8 bit
Parity	None
Stop bit	1 bit
Hand shake	No X flow, hardware flow control
Delimiter	CR, CR + LF for reception CR + LF for transmission

(2) Electrical Characteristi

Input voltage limit	+5 V to +15 V : ON -15 V to -5 V : OFF
Out put voltage (load resistance 3 to 7 kΩ)	+5 V to +9 V : ON -9 V to -5 V : OFF

(3) Pin arrangement of interface connector (D-sub 9Pin male)

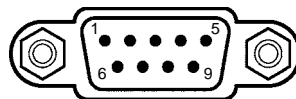

RS-232C

(4) Pin arrangement of connector

The signal lines of the 3153's RS-232C connector are as follows.

Pin number	Signal	IN/OUT	Contents
2	RxD	IN	Incoming data
3	TxD	OUT	Outgoing data
4	DTR	OUT	Data terminal ready
5	GND	GND	Signal ground
7	RTS	OUT	Transmission request

10.1.2 Preparing for Data Transfer

(1) Connecting cable

Use a cross cable for connection to the PC. If the hardware flow control signal (RTS and CTS) is not used, the 3153 will not perform hardware flow control.

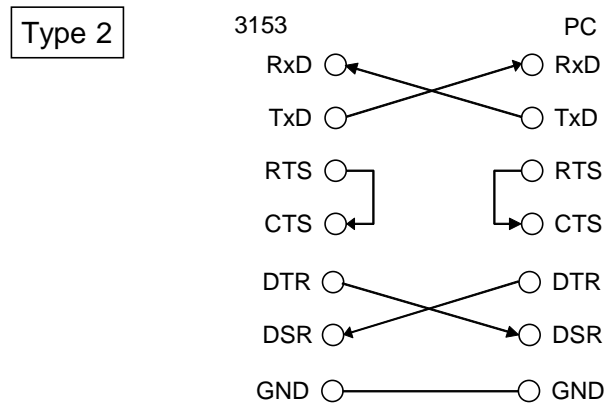
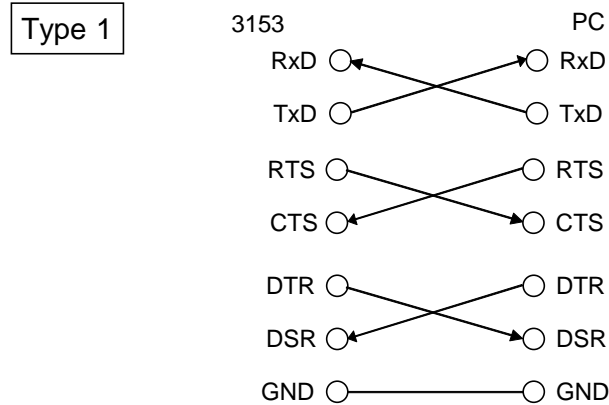

Connector on cable side: D-Sub 9 Pin female
Connection: Reverse connection

NOTE

The optional 9637 and 9638 RS-232C cables must be connected in accordance with the procedure for type 2.

(2) Connection to Computer

1. Connect the 3153 to the computer using a cross cable.
2. Perform the RS-232C settings on the computer side.
For the flow control on the computer side, be sure to turn OFF the hardware flow. For details on how to make settings, see the instruction manual for each software.

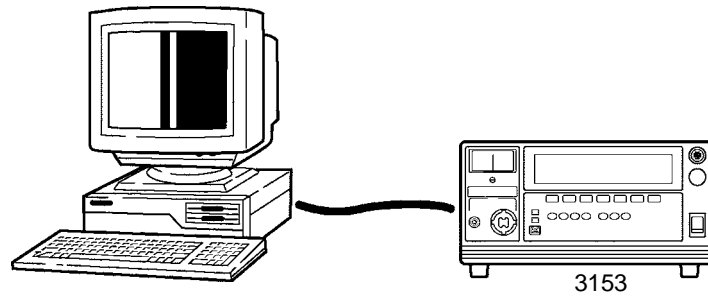

(3) Setting of optional functions

To perform communication and control with the computer through the use of RS-232C of this unit, optional functions must be set (for details, see Chapter 7 Optional Functions).

1. Press the **SHIFT + STOP** keys in the READY state to display the "optional function setting window."
2. Set "START" for the interface command to "1: Set". This will activate the interface command :START.
3. Change the page, and make settings for the PC interface. When using RS-232C, select the transmission speed.

0 : RS-232C 9600bps

1 : RS-232C 19200bps

2 : GP-IB

4. Press the **SHIFT + STOP** keys to close the "optional function setting window."

10.1.3 RS-232C Command Transfer Methods

The command is issued from the computer. When the 3153 receives the incoming command from the computer, it executes the processing specified by the command.

"RMT" lights up on the screen during interface communication.

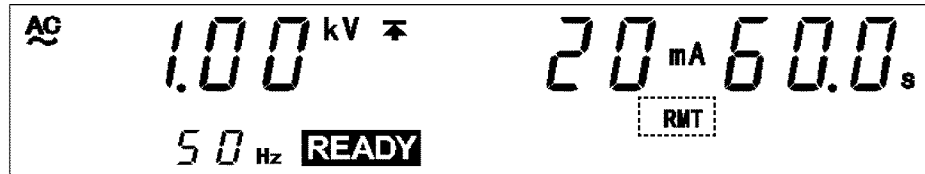

Command Format

(1) Command Format

The 3153 commands have the following structure.

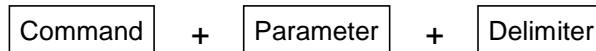

The command and the parameter are separated by " " (one character space)
If there is no parameter, send the delimiter after the command.

The command may consist of both upper and lower case letters.

Make sure to use one character space as the separator between the command and the parameter.

(1) When the command contains a parameter

:CONFigure:WITHStand:CUPPer 5.0 (+ delimiter)

the command format consists of the command

:CONFigure:WITHStand:CUPPer followed by the separator " " (one character space). Then follows the parameter 5.0. Following the parameter comes the delimiter.

(2) When the command contains no parameter

:START (+ delimiter)

the command format consists of the command :START immediately followed by the delimiter.

A command can abbreviated. The whole command form is referred to as the "long form" and the abbreviated form as the "short form."

Although the short form is printed in upper case letters and the rest in lower case letters in this instruction manual, sending command (including parameter and delimiter) from personal computer in either upper or lower case letters is valid.

All responses returned from the 3153 are in upper case letters.

:HEADER OK (the long form)

:HEAD OK (the short form)

:HEADE,;HEA error

NOTE

The delimiter is a symbol indicating separation of a command or data. Upon reception of the delimiter, this unit starts to analyze a command.

(2) Response format

When a command is sent to 3153 processes the command. When processing is completed, 3153 always returns a response.

When there is no information from 3153
No response

When there is information from 3153 (measurement values, etc.)
Response character string related to the command (+delimiter)

(3) Parameters

The 3153 uses parameters composed of decimal numbers. There are three different formats for decimal data: NR1, NR2, and NR3. Each has two values: one with a code and one without it. A value without a code is regarded as a positive number. If a number exceeds the accuracy resolution of the 3153, the value is rounded up or down.

NR1 format: Integer data
+12, -23, 34

NR2 format: Fixed point numbers
+1.23, -23.45, 3.456

NR3: Floating point number
+1.2E3, -2.3E-4, 3.4E5

The term "NRf format" includes all these three formats.
Each 3153 command designates a format.

(4) Delimiter

Depending on transmission direction, the delimiter is as follows.
From computer to 3153: CR or CR + LF
From 3153 to computer: CR + LF



This unit starts analysis after confirming the delimiter.

(5) Separators

Message unit separator

A semicolon (;) is used as a message unit separator when it is desired to set out several messages on a single line.

Example: :WITHstand:CLOWer ON;;CONFigure:WITHstand:CLOWer 10

Header separator

In a message which has a header and data, a space (represented by " " in the examples) is used as the header separator to separate the header from the data.

Example: :MODE MWITH

Data separator

If a message has several data items, commas (,) are required as data separators for separating these data items from one another.

Example: :PROGram:EDIT:FILE 5,1

(6) Abbreviation of Compound Commands

When several compound commands have a common head portion (for example, :CONFigure), then, when and only when writing them directly following on from one another, this common portion (for example, :CONFigure) can be omitted from each command except for the first one. This common portion is called "the current path", by analogy with the general concept of the current directory in the directory structure of UNIX or MSDOS, and until it is cleared the analysis of following commands is performed by deeming them to be preceded by the current path which has been curtailed in the interests of brevity. This manner of using the current path is shown in the following example:

Normal expression

CONFigure:WITHstand:CUPPer 10;;CONFigure:WITHstand:CLOWer 1.0

Abbreviated expression

CONFigure:WITHstand:CUPPer 10;CLOWer 1.0

The current path is cleared when the power is turned on, when a colon (:) appears at the start of a command, and when a delimiter is detected.

Messages with particular headers can be executed without relation to the current path. Further, they have no effect upon the current path.

Output Queue

Response messages accumulate in the output queue and are transmitted as data and cleared.

The output queue is also cleared when the power is turned off and turned on again.

The 3153 has an output queue of 300 bytes capacity. If the response messages overflow this limit of 300 bytes, a query error is generated, and the output queue is cleared.

Input Buffer

The 3153 has an input buffer of 300 bytes capacity. When more than 300 bytes of data are transmitted, when the buffer is full any subsequent bytes received will be ignored.

Event Registers

The 3153 includes two 8-bit event registers. It is possible to determine the status of the unit by reading these registers.

The event register is cleared in the following situations:

- When a *CLS command is executed.
- When an event register query is executed. (*ESR?, :ESR0?)
- When the unit is powered on.

(1) Standard event status register (SESR) bit assignments

Bit 7 PON	Power on flag. When the power is turned on, or on recovery from a power cut, this bit is set to 1.
Bit 6	Unused.
Bit 5 CME	Command error. When a command which has been received contains a syntactic or semantic error, this bit is set to 1. <ul style="list-style-type: none"> • The command is not supported by the 3153. • There is a mistake in a program header. • The number of data parameters is wrong. • The format of the parameters is wrong.
Bit 4 EXE	Execution error. When for some reason a command which has been received cannot be executed, this bit is set to 1. <ul style="list-style-type: none"> • The designated data value is outside the set range. • The designated data value is not acceptable.
Bit 3 DDE	Device dependent error. When a command cannot be executed due to some cause other than a command error, a query error, or an execution error, this bit is set to 1. <ul style="list-style-type: none"> • Execution is impossible due to an abnormality inside the 3153.
Bit 2 QYE	Query error. This bit is set to 1 when a query error is detected by the output queue control. <ul style="list-style-type: none"> • When the data overflows the output queue. • When data in the output queue has been lost.
Bit 1	Unused.
Bit 0	Unused.

(2) Event status register 0 (ESR0) bit assignments

Bit 7	Unused
Bit 6	Unused
Bit 5	Unused
Bit 4	Unused
Bit 3 EOM	Test completed
Bit 2 LFAIL	Below lower-limit of comparator
Bit 1 UFAIL	Above upper-limit of comparator
Bit 0 PASS	Within limits of comparator

10.2 Command Table

Common Commands (RS-232C/ GP-IB)

Command	Explanation	Page
*CLS	Clears the status byte register and the event registers.	168
*ESR?	Queries the contents of the standard event status register.	168
*IDN?	Queries manufacturer's name, model name, and software version.	169
*RST	Performs device initial setting.	169
*TST?	Requests execution of, and queries the result of, the self test.	170

Specific Commands (RS-232C/ GP-IB)

Command	Explanation	Page
:ESR0?	Queries event status register 0.	171
:HEADer	Enables and disables headers for the response messages.	171
:HEADer?	Queries whether or not headers on response messages are enabled.	172
:SYSTem:ERRor?	Queries RS-232C communication errors.	172
:MODE	Sets the test mode.	173
:MODE?	Queries the test mode.	173
:STATe?	Queries the state.	174
:START	Starting a test.	174
:STOP	Forcibly ends a test and releases the hold state.	175
:CONFigure:WITHstand:KIND	Sets the type of test voltage.	175
:CONFigure:WITHstand:KIND?	Queries the type of voltage for withstand-voltage tests.	175
:CONFigure:WITHstand:VOLTage	Sets the test-voltage value for withstand-voltage tests.	176
:CONFigure:WITHstand:VOLTage?	Queries the test-voltage value for withstand-voltage tests.	176
:CONFigure:WITHstand:CUPPer	Sets the upper-limit value for withstand-voltage tests.	176
:CONFigure:WITHstand:CUPPer?	Queries the upper-limit value for withstand-voltage tests.	177
:CONFigure:WITHstand:CLOWer	Sets the lower-limit value for withstand-voltage tests.	177
:CONFigure:WITHstand:CLOWer?	Queries the lower-limit value for withstand-voltage tests.	177
:CONFigure:WITHstand:TIMer	Sets the test time for withstand-voltage tests.	178
:CONFigure:WITHstand:TIMer?	Queries the test time for withstand-voltage tests.	178
:CONFigure:WITHstand:UTIMer	Sets the ramp-up time for withstand-voltage tests.	178
:CONFigure:WITHstand:UTIMer?	Queries the ramp-up time for withstand-voltage tests.	179
:CONFigure:WITHstand:DTIMer	Sets the ramp-down time for withstand-voltage tests.	179
:CONFigure:WITHstand:DTIMer?	Queries the ramp-down time for withstand-voltage tests.	179
:WITHstand:CLOWer	Enables and disables the lower-limit value for withstand-voltage tests.	180
:WITHstand:CLOWer?	Queries the lower-limit value enablement for withstand-voltage tests.	180
:WITHstand:TIMer	Enables and disables the test time for withstand-voltage tests.	180
:WITHstand:TIMer?	Queries the test time enablement for withstand-voltage tests.	181
:WITHstand:UTIMer	Sets the ramp-up time ON/OFF for withstand-voltage tests.	181
:WITHstand:UTIMer?	Queries the ramp-up time ON/OFF for withstand-voltage tests.	181
:WITHstand:DTIMer	Sets the ramp-down time ON/OFF for withstand-voltage tests.	182

:WITHstand:DTimer?	Queries the ramp-down time ON/OFF for withstand-voltage tests.	182
:MEASure:RESult:WITHstand?	Queries the withstand-voltage test result.	183
:MEASure:WITHstand:VOLTage?	Queries the measured voltage value for withstand-voltage tests.	183
:MEASure:WITHstand:CURRent?	Queries the measured current value for withstand-voltage tests.	184
:MEASure:WITHstand:TIMer?	Queries the test time elapsed for withstand-voltage tests.	184
:MEMory:WITHstand:FILE?	Queries the contents of the set-value memory for withstand-voltage tests.	185
:MEMory:WITHstand:LOAD	Loads the set-value memory for withstand-voltage tests.	185
:MEMory:WITHstand:SAVE	Saves set values for withstand-voltage tests in memory.	186
:MEMory:WITHstand:CLEar	Clears the set-value memory for withstand-voltage tests.	186
:CONFigure:INSulation:VOLTage	Sets the test-voltage value for insulation-resistance tests.	186
:CONFigure:INSulation:VOLTage?	Queries the test-voltage value for insulation-resistance tests.	187
:CONFigure:INSulation:RUPPer	Sets the upper-limit value for insulation-resistance tests.	187
:CONFigure:INSulation:RUPPer?	Queries the upper-limit value for insulation-resistance tests.	187
:CONFigure:INSulation:RLOWer	Sets the lower-limit value for insulation-resistance tests.	188
:CONFigure:INSulation:RLOWer?	Queries the lower-limit value for insulation-resistance tests.	188
:CONFigure:INSulation:TIMer	Sets the test time for insulation-resistance tests.	188
:CONFigure:INSulation:TIMer?	Queries the test time for insulation-resistance tests.	189
:CONFigure:INSulation:DELay	Sets the delay time for insulation-resistance tests.	189
:CONFigure:INSulation:DELay?	Queries the delay time for insulation-resistance tests.	189
:INSulation:RUPPer	Enables and disables the upper-limit value for insulation-resistance tests.	190
:INSulation:RUPPer?	Queries the upper-limit value enablement for insulation-resistance tests.	190
:INSulation:TIMer	Enables and disables the test time for insulation-resistance tests.	190
:INSulation:TIMer?	Queries the test time enablement for insulation-resistance tests.	191
:INSulation:DELay	Sets the delay time ON/OFF for insulation-resistance tests.	191
:INSulation:DELay?	Queries the delay time ON/OFF for insulation-resistance tests.	191
:MEASure:RESult:INSulation?	Queries the insulation-resistance test result.	192
:MEASure:INSulation:VOLTage?	Queries the measured voltage value for insulation-resistance tests.	192
:MEASure:INSulation:RESistance?	Queries the measured resistance value for insulation-resistance tests.	193
:MEASure:INSulation:TIMer?	Queries the test time elapsed for insulation-resistance tests.	193
:MEMory:INSulation:FILE?	Queries the content of data saved for insulation-resistance tests.	194
:MEMory:INSulation:LOAD	Loads data saved for insulation-resistance tests.	194
:MEMory:INSulation:SAVE	Saves data for insulation-resistance tests to memory files.	195
:MEMory:INSulation:CLEar	Clears the insulation-resistance test data saved to memory files.	195
:PROGram:EDIT:FILE	Sets the file scanner mode for program tests.	196
:PROGram:EDIT:FILE?	Queries the file scanner mode for program tests.	196
:PROGram:EDIT:STEP	Makes settings for the scanner, test mode, and test conditions for program test step.	197
:PROGram:EDIT:STEP?	Queries settings for the scanner, test mode, and test conditions for program test step.	198
:PROGram:LOAD:FILE	Loads the program test file.	199
:MEASure:RESult:FILE?	Queries the test result of the program test file.	199
:MEASure:RESult:STEP?	Queries the measured result in the program test step.	200

Common Commands (GP-IB)

Command	Explanation	Page
*ESE	Sets the standard event status enable register.	212
*ESE?	Queries the standard event status enable register.	213
*OPC	After all action has been completed during execution, performs an SRQ request.	213
*OPC?	Queries whether or not all action has been completed during execution.	213
*SRE	Sets the service request enable register.	214
*SRE?	Queries the service request enable register (SRER).	214
*STB?	Queries the status byte register.	215
*WAI	Waits until all execution is fully completed.	215

Specific Commands (GP-IB)

Command	Explanation	Page
:ESE0	Sets event status enable register 0.	216
:ESE0?	Queries event status enable register 0.	216
:TRANsmit:TERMinator	Sets the data terminator for response messages.	217
:TRANsmit:TERMinator?	Queries the data terminator for response messages.	217

10.3 RS-232C Command Reference

Command Reference

Explanation of Command Reference

Syntax	Describes the syntax of the command.
Response syntax	Explains the parameter data.
<data>	Explains the received data.
Function	Explains the actions specified by the command.
Note	Describes points that require special attention when using the command.
Example	Command execution examples.
	Transmission Denotes command from the computer.
	Response Denotes command from 3153. (Header: OFF)
Error	Describes errors that may occur when the command is executed.

10.3.1 Common Command Messages

*CLS

Clears the status byte register and the event registers.

Syntax *CLS

Function Clears all the event registers (SESR, ESR0) associated with the bits of the status byte register. Accordingly, also clears the status byte register. This has no effect upon the output queue.

Example Clears the status byte register and the event registers.
Transmission *CLS

Error If the data parameters are set after this command, a command error occurs.

*ESR?

Queries the contents of the standard event status register (SESR).

Syntax *ESR?

Response syntax <data>

<data> 0 to 255 (NR1)

Function Returns the contents of the standard event status register (SESR) as a numerical value in NR1 format between 0 and 255, and then clears standard event status register. No header is affixed to the response message.

Example Queries the contents of the standard event status register (SESR).
Transmission *ESR?
Response 32
Bit 5 of SESR has been set to 1.

Error If the response message is longer than 300 bytes, a query error is generated.

128 bit7	64 bit6	32 bit5	16 bit4	8 bit3	4 bit2	2 bit1	1 bit0
PON	URQ	CME	EXE	DDE	QYE	RQC	OPC

Standard event status register (SESR)

*IDN?

Queries manufacturer's name, model name, and software version.

Syntax	*IDN?
Response syntax	<data1>,<data2>,<data3>,<data4>
<data1>	Manufacturer's name (HIOKI)
<data2>	Model name (3153)
<data3>	Serial No. (Not used - always zero)
<data4>	Software version (V*.** : version No.)
Function	The response consists of the name of the manufacturer of the unit, the model name, and the software version.
Example	Queries manufacturer's name, model name, Serial No. (Not used - always zero), and software version.
Transmission	*IDN?
Response	HIOKI,3153,0,V1.00 Manufacturer's name: HIOKI; Model name: 3153; Software version: 1.00

*RST

Performs device initial setting.

Syntax	*RST																										
Function	<table> <tr> <td>Performs device initial setting.</td> <td>Insulation-resistance mode (initial setting)</td> </tr> <tr> <td>Withstand-voltage mode (initial setting)</td> <td>Test type: 50 V</td> </tr> <tr> <td>Test type: AC50 Hz</td> <td>Upper-limit value setting: OFF</td> </tr> <tr> <td>Test-voltage value: 0.20 kV</td> <td>Upper-limit value: 9999 M</td> </tr> <tr> <td>Lower-limit value setting: OFF</td> <td>Lower-limit value setting: 4000 M</td> </tr> <tr> <td>Upper-limit value: 0.20 mA</td> <td>Test time setting: ON</td> </tr> <tr> <td>Lower-limit value: 0.1 mA</td> <td>Delay time setting: OFF</td> </tr> <tr> <td>Test time setting: ON</td> <td>Test time: 0.3 s</td> </tr> <tr> <td>Ramp-up time setting: OFF</td> <td>Delay time: 0.1 s</td> </tr> <tr> <td>Ramp-down time setting: OFF</td> <td></td> </tr> <tr> <td>Test time: 0.3 s</td> <td></td> </tr> <tr> <td>Ramp-up time setting: 0.1 s</td> <td></td> </tr> <tr> <td>Ramp-down time setting: 0.1 s</td> <td></td> </tr> </table> <p>Optional functions (Initial settings) Set all functions to zero, except for the FAIL hold function, START protection function, interface command "START," and PC interface. FAIL hold function and START protection function: 1 Output-voltage restricting value: 5.0 kV</p>	Performs device initial setting.	Insulation-resistance mode (initial setting)	Withstand-voltage mode (initial setting)	Test type: 50 V	Test type: AC50 Hz	Upper-limit value setting: OFF	Test-voltage value: 0.20 kV	Upper-limit value: 9999 M	Lower-limit value setting: OFF	Lower-limit value setting: 4000 M	Upper-limit value: 0.20 mA	Test time setting: ON	Lower-limit value: 0.1 mA	Delay time setting: OFF	Test time setting: ON	Test time: 0.3 s	Ramp-up time setting: OFF	Delay time: 0.1 s	Ramp-down time setting: OFF		Test time: 0.3 s		Ramp-up time setting: 0.1 s		Ramp-down time setting: 0.1 s	
Performs device initial setting.	Insulation-resistance mode (initial setting)																										
Withstand-voltage mode (initial setting)	Test type: 50 V																										
Test type: AC50 Hz	Upper-limit value setting: OFF																										
Test-voltage value: 0.20 kV	Upper-limit value: 9999 M																										
Lower-limit value setting: OFF	Lower-limit value setting: 4000 M																										
Upper-limit value: 0.20 mA	Test time setting: ON																										
Lower-limit value: 0.1 mA	Delay time setting: OFF																										
Test time setting: ON	Test time: 0.3 s																										
Ramp-up time setting: OFF	Delay time: 0.1 s																										
Ramp-down time setting: OFF																											
Test time: 0.3 s																											
Ramp-up time setting: 0.1 s																											
Ramp-down time setting: 0.1 s																											
Note	<ul style="list-style-type: none"> • The settings of the interface command "START" and the PC interface cannot be reset. • The memory of the set values and program files cannot be reset. 																										
Example	Performs device initial setting.																										
Transmission	*RST																										

*TST?

Requests execution of, and queries the result of, the self test.

Syntax *TST?

**Response
syntax** <data>

<data> 0 to 3 (NR1)

Function Performs the self test of the 3153, and returns the result thereof as a numerical value in NR1 format between 0 and 3.
0: No error
1: A ROM error occurred.
2: A RAM error occurred.
3: ROM and RAM error occurred.

Example Requests execution of, and queries the result of, the self test.

Transmission *TST?

Response 3

A ROM error (bit 0) and a RAM error (bit 1) have occurred.

Error If the response message is longer than 300 bytes, a query error occurs.
The execution of this command in a state other than the READY state causes an execution error.

10.3.2 Specific Command Messages

:ESR0?

Queries event status register 0.

Syntax :ESR0?

Response syntax <data>

<data> 0 to 255 (NR1)

Function Returns the value of event status register 0 (ESR0) as a numerical value in NR1 format between 0 and 255, and then clears event status register 0.

Example Queries event status register 0.

Transmission :ESR0?

Response 4

Bit 2 of ESR0 has been set to 1.

Error If the response message is longer than 300 bytes, a query error is generated.

128 bit7	64 bit6	32 bit5	16 bit4	8 bit3	4 bit2	2 bit1	1 bit0
Unused	Unused	Unused	Unused	EOM	LFAIL	UFAIL	PASS

Event status register 0 (ESR0)

:HEADer

Enables and disables headers for the response messages.

Syntax :HEADer <data>

<data> ON/OFF (Character data)

Function Sets whether or not the 3153 will prefix headers to its response messages.

Note If the PC interface settings are changed by setting optional functions when the power is turned ON, the header will be reset to OFF.

Example Enables headers for the response messages.

Transmission :HEADer ON

Error If <data> is other than character data described above, an execution error occurs.

:HEADer?

Queries whether or not headers on response messages are enabled.

Syntax :HEADer?

Response syntax <data>

<data> ON/OFF (Character data)

Function Returns whether or not headers on response messages are enabled as character data.

Example Queries whether or not headers on response messages are enabled.

Transmission :HEADer?
 Response :HEADER ON (header: ON)
 OFF (header: OFF)

Error If the response message is longer than 300 bytes, a query error is generated.

:SYSTem:ERRor?

Queries RS-232C communication errors.

Syntax :SYSTem:ERRor?

Response syntax <data>

<data> 0 to 7 (NR1)

Function Returns the contents of the RS-232C communication-error register in NR1 format (<data>) 0 to 7, and clears the contents.

RS-232C communication-error register

- Overrun error: Data missing
- Framing error: Data reading error
- Parity error: Data garbling

Note

- No header is attached to response messages.
- This command cannot be used in GP-IB.

Example Queries RS-232C communication errors.

Transmission :SYSTem:ERRor?
 Response 4
 An overrun error has occurred.

Error If the response message is longer than 300 bytes, a query error is generated.

128 bit7	64 bit6	32 bit5	16 bit4	8 bit3	4 bit2	2 bit1	1 bit0
Unused	Unused	Unused	Unused	Unused	Overrun error	Framing error	Parity error

:MODE

Sets the test mode.

Syntax :MODE <data>

<data> MWITH : Withstand-voltage mode
 MINS : Insulation-resistance mode
 AWI : Withstand-voltage mode → insulation-resistance mode
 AIW : Insulation-resistance mode → withstand-voltage mode
 PROG : Program mode
 (Character data)

Function In the READY state, sets the test mode.

Example Sets the test mode to the auto test mode (withstand-voltage mode → insulation-resistance mode.)
 Transmission :MODE AWI

Error The execution of this command in a state other than the READY state or "test setting state" causes an execution error.

:MODE?

Queries the test mode.

Syntax :MODE?

Response syntax <data>

<data> MWITH : Withstand-voltage mode
 MINS : Insulation-resistance mode
 AWI : Withstand-voltage mode → insulation-resistance mode
 AIW : Insulation-resistance mode → withstand-voltage mode
 PROG : Program mode
 (Character data)

Function Queries the test mode.

Example Queries the test mode.
 Transmission :MODE?
 Response AWI
 Test mode: withstand-voltage mode → insulation-resistance mode

:STATE?

Queries the state.

Syntax	:STATE?
Response syntax	<data>
<data>	WPASS : Withstand-voltage mode PASS IPASS : Insulation-resistance mode PASS WUFAIL : Withstand-voltage mode UPPER FAIL IUFAIL : Insulation-resistance mode UPPER FAIL WLFAIL : Withstand-voltage mode LOWER FAIL ILFAIL : Insulation-resistance mode LOWER FAIL WREADY: Withstand-voltage mode READY IREADY : Insulation-resistance mode READY WTEST : Withstand-voltage mode TEST ITEST : Insulation-resistance mode TEST NULL : Others(Aborts a test) (Character data)
Function	Queries the state.
Example	Queries the state. Transmission :STATE? Response WREADY In the withstand-voltage mode READY state.

:START

Starting a test.

Syntax	:START
Function	Starts a test in the READY state.
Note	To start a test using this command, set "START" for the interface command to "1: Set", which is an optional function setting (for details, see Section 7.7 Interface command "START").
Example	Starting a test Transmission :START
Error	The execution of this command in a state other than the READY state or "test setting state" causes an execution error. In the optional functions, if the RS command START is set to "0: Not set," an execution error will occur. Note that an execution error occurs when double action is set to "1: ON" on the optional function setting screen.

:STOP

Forcibly ends a test and releases the hold state.

Syntax :STOP

Function In the TEST state, forcibly ends a test. Furthermore, releases the Hold function and returns to the READY state. However, in the optional functions, when "FAIL Mode Function" is set to ON, the Hold function cannot be disabled by this command. (See Section 7.6.)

Example Forcibly ends a test.
Transmission :STOP

Error In the optional functions, when "FAIL Mode Function" is set to ON, an execution error will occur if the unit is in the FAIL Hold Mode.

:CONFigure:WITHstand:KIND

Sets the type of test voltage.

Syntax :CONFigure:WITHstand:KIND <data>

<data> AC50,AC60,DC (Character data)

Function Sets the type of voltage for withstand-voltage tests in the READY state.

Example Sets the type of voltage for withstand-voltage tests at AC 50 Hz.
Transmission :CONFigure:WITHstand:KIND AC50

Error The execution of this command in a state other than the READY state or "test setting state" causes an execution error.

:CONFigure:WITHstand:KIND?

Queries the type of voltage for withstand-voltage tests.

Syntax :CONFigure:WITHstand:KIND?

Response syntax <data>

<data> AC50,AC60,DC (Character data)

Function Queries the type of voltage for withstand-voltage tests in the READY state.

Example Queries the type of voltage for withstand-voltage tests.
Transmission :CONFigure:WITHstand:KIND?
Response AC50
The type of voltage is AC50 Hz.

:CONFigure:WITHstand:VOLTage

Sets the test-voltage value for withstand-voltage tests.

- Syntax** :CONFigure:WITHstand:VOLTage <data>
- <data>** 0.20 to 5.00 (NRf)
- Function** Sets the test-voltage value (unit: kV) for withstand-voltage tests in the READY state.
- Example** Sets the test-voltage value for withstand-voltage tests at 1.00 kV.
Transmission :CONFigure:WITHstand:VOLTage 1.00
- Error** The execution of this command in a state other than the READY state or "test setting state" causes an execution error.

:CONFigure:WITHstand:VOLTage?

Queries the test-voltage value for withstand-voltage tests.

- Syntax** :CONFigure:WITHstand:VOLTage?
- Response syntax** <data>
- <data>** 0.20 to 5.00 (NRf)
- Function** Queries the test-voltage value (unit: kV) for withstand-voltage tests.
- Example** Queries the test-voltage value for withstand-voltage tests.
Transmission :CONFigure:WITHstand:VOLTage?
Response 1.00
The test-voltage value is 1.00 KV.

:CONFigure:WITHstand:CUPPer

Sets the upper-limit value for withstand-voltage tests.

- Syntax** :CONFigure:WITHstand:CUPPer <data>
- <data>** 0.1 to 100 (AC-withstand-voltage test)
0.1 to 10 (DC-withstand-voltage test)
(NRf)
- Function** Sets the upper-limit value (unit: mA) for withstand-voltage tests, in the READY state.
- Example** Sets the upper-limit value for withstand-voltage tests to 5.0 mA.
Transmission :CONFigure:WITHstand:CUPPer 5.0
- Error** The execution of this command in a state other than the READY state or "test setting state" causes an execution error.

:CONFigure:WITHstand:CUPPer?

Queries the upper-limit value for withstand-voltage tests.

Syntax	:CONFigure:WITHstand:CUPPer?
Response syntax	<data>
<data>	0.1 to 100 (AC-withstand-voltage test) 0.1 to 10 (DC-withstand-voltage test) (NR1 or NR2)
Function	Queries the upper-limit value (unit: mA) for withstand-voltage tests.
Example	Queries the upper-limit value for withstand-voltage tests. Transmission :CONFigure:WITHstand:CUPPer? Response 5.0 The upper-limit value is 5.0 mA.

:CONFigure:WITHstand:CLOWer

Sets the lower-limit value for withstand-voltage tests.

Syntax	:CONFigure:WITHstand:CLOWer <data>
<data>	0.1 to 99 (AC-withstand-voltage test) 0.1 to 9.9 (DC-withstand-voltage test) (NRF)
Function	Sets the lower-limit value (unit: mA) for withstand-voltage tests, in the READY state.
Example	Sets the lower-limit value for withstand-voltage tests to 0.1 mA. Transmission :CONFigure:WITHstand:CLOWer 0.1
Error	The execution of this command in a state other than the READY state or "test setting state" causes an execution error.

:CONFigure:WITHstand:CLOWer?

Queries the lower-limit value for withstand-voltage tests.

Syntax	:CONFigure:WITHstand:CLOWer?
Response syntax	<data>
<data>	0.1 to 99 (AC-withstand-voltage test) 0.1 to 9.9 (DC-withstand-voltage test) (NR1 or NR2)
Function	Queries the lower-limit value (unit: mA) for withstand-voltage tests.
Example	Queries the lower-limit value for withstand-voltage tests. Transmission :CONFigure:WITHstand:CLOWer? Response 0.1 The lower-limit value is 0.1 mA.

:CONFigure:WITHstand:TIMer

Sets the test time for withstand-voltage tests.

Syntax :CONFigure:WITHstand:TIMer <data>

<data> 0.3 to 999 (NRf)

Function Sets the test time (unit: s) for withstand-voltage tests, in the READY state.

Example Sets the test time for withstand-voltage tests to 30.0 s.
Transmission :CONFigure:WITHstand:TIMer 30.0

Error The execution of this command in a state other than the READY state or "test setting state" causes an execution error.

:CONFigure:WITHstand:TIMer?

Queries the test time for withstand-voltage tests.

Syntax :CONFigure:WITHstand:TIMer?

Response syntax <data>

<data> 0.3 to 999 (NR1 or NR2)

Function Queries the test time (unit: s) for withstand-voltage tests.

Example Queries the test time for withstand-voltage tests.
Transmission :CONFigure:WITHstand:TIMer?
Response 30.0
The test time is set to 30.0 s.

:CONFigure:WITHstand:UTIMer

Sets the ramp-up time for withstand-voltage tests.

Syntax :CONFigure:WITHstand:UTIMer <data>

<data> 0.1 to 99.9 (NRf)

Function Sets the ramp-up time (unit: s) for withstand-voltage tests in the READY state.

Example Sets the ramp-up time for withstand-voltage tests at 10.0 s.
Transmission :CONFigure:WITHstand:UTIMer 10.0

Error The execution of this command in a state other than the READY state or "test setting state" causes an execution error.

:CONFigure:WITHstand:UTIMer?

Queries the ramp-up time for withstand-voltage tests.

Syntax	:CONFigure:WITHstand:UTIMer?
Response syntax	<data>
<data>	0.1 to 99.9 (NR2)
Function	Queries the ramp-up time (unit: s) for withstand-voltage tests.
Example	Queries the ramp-up time for withstand-voltage tests. Transmission :CONFigure:WITHstand:UTIMer? Response 10.0 The set ramp-up time is 10.0 s.

:CONFigure:WITHstand:DTIMER

Sets the ramp-down time for withstand-voltage tests.

Syntax	:CONFigure:WITHstand:DTIMER <data>
<data>	0.1 to 99.9 (NRf)
Function	Sets the ramp-down time (unit: s) for withstand-voltage tests in the READY state.
Example	Sets the ramp-down time for withstand-voltage tests at 5.0 s. Transmission :CONFigure:WITHstand:DTIMER 5.0
Error	The execution of this command in a state other than the READY state or "test setting state" causes an execution error.

:CONFigure:WITHstand:DTIMER?

Queries the ramp-down time for withstand-voltage tests.

Syntax	:CONFigure:WITHstand:DTIMER?
Response syntax	<data>
<data>	0.1 to 99.9 (NR2)
Function	Queries the ramp-down time (unit: s) for withstand-voltage tests.
Example	Queries the ramp-down time for withstand-voltage tests. Transmission :CONFigure:WITHstand:DTIMER? Response 5.0 The set ramp-down time is 5.0 s.

:WITHstand:CLOWer

Enables and disables the lower-limit value for withstand-voltage tests.

Syntax :WITHstand:CLOWer <data>

<data> ON/OFF (Character data)

Function Enables and disables the lower-limit value for withstand-voltage tests, in the READY state.

Example Enables the lower-limit value for a withstand-voltage test.
Transmission :WITHstand:CLOWer ON

Error The execution of this command in a state other than the READY state or "test setting state" causes an execution error.

:WITHstand:CLOWer?

Queries the lower-limit value enablement for withstand-voltage tests.

Syntax :WITHstand:CLOWer?

Response syntax <data>

Function Queries the lower-limit value enablement for withstand-voltage tests.

Note ON/OFF (Character data)

Example Queries the lower-limit value enablement for withstand-voltage tests.
Transmission :WITHstand:CLOWer?
Response ON

:WITHstand:TIMer

Enables and disables the test time for withstand-voltage tests.

Syntax :WITHstand:TIMer <data>

<data> ON/OFF (Character data)

Function Enables and disables the test time for withstand-voltage tests, in the READY state.

Example Enables the test time for a withstand-voltage test.
Transmission :WITHstand:TIMer ON

Error The execution of this command in a state other than the READY state or "test setting state" causes an execution error.

:WITHstand:TIMer?

Queries the test time enablement for withstand-voltage tests.

Syntax	:WITHstand:TIMer?
Response syntax	<data>
<data>	ON/OFF (Character data)
Function	Queries the test time enablement for withstand-voltage tests.
Example	Queries the test time enablement for withstand-voltage tests. Transmission :WITHstand:TIMer? Response ON

:WITHstand:UTIMer

Sets the ramp-up time ON/OFF for withstand-voltage tests.

Syntax	:WITHstand:UTIMer <data>
<data>	ON/OFF (Character data)
Function	Sets the ramp-up time ON/OFF for withstand-voltage tests in the READY state.
Example	Sets the ramp-up time for the withstand-voltage tests to ON. Transmission :WITHstand:UTIMer ON
Error	The execution of this command in a state other than the READY state or "test setting state" causes an execution error.

:WITHstand:UTIMer?

Queries the ramp-up time ON/OFF for withstand-voltage tests.

Syntax	:WITHstand:UTIMer?
Response syntax	<data>
<data>	ON/OFF (Character data)
Function	Queries the ramp-up time ON/OFF for withstand-voltage tests.
Example	Queries the ramp-up time ON/OFF for withstand-voltage tests. Transmission :WITHstand:UTIMer? Response ON

:WITHstand:DTIMer

Sets the ramp-down time ON/OFF for withstand-voltage tests.

Syntax :WITHstand:DTIMer <data>

<data> ON/OFF (Character data)

Function Sets the ramp-down time ON/OFF for withstand-voltage tests in the READY state.

Example Sets the ramp-down time for the withstand-voltage tests to ON.
Transmission :WITHstand:DTIMer ON

Error The execution of this command in a state other than the READY state or "test setting state" causes an execution error.

:WITHstand:DTIMer?

Queries the ramp-down time ON/OFF for withstand-voltage tests.

Syntax :WITHstand:DTIMer?

Response syntax <data>

<data> ON/OFF (Character data)

Function Queries the ramp-down time ON/OFF for withstand-voltage tests.

Example Queries the ramp-down time ON/OFF for withstand-voltage tests.
Transmission :WITHstand:DTIMer?
Response ON

:MEASure:RESult:WITHstand?

Queries the withstand-voltage test result.

Syntax	:MEASure:RESult:WITHstand?
Response syntax	<data1>,<data2>,<data3>,<data4>,<data5>
<data1>	Measured voltage value (unit: kV)
<data2>	Measured current value (unit: mA)
<data3>	Test time elapsed (unit: s)
<data4>	Determination
<data5>	Types of timers Determination other than types of timers: NR1/NR2 format Determination: PASS UFAIL (UPPER FAIL) LFAIL (LOWER FAIL) ULFAIL (UPPER LOWER FAIL) OFF (Others) (Character data) Type of timer: 0 (test time), 1 (ramp-up time), 2 (ramp-down time) (NR1)
Function	Queries the results of the preceding test. Returns the determination and valid values at termination of the preceding test. The test results are updated upon termination of a new test.
Example	Queries the measured value for withstand-voltage tests Transmission :MEASure:RESult:WITHstand? Response 1.00,2.00,30.0,PASS,0 Measured voltage value: 1.00 kV; Measured current value: 2.00 mA; Test time elapsed: 30.0 s; Determination: PASS; Test time: 0

:MEASure:WITHstand:VOLTage?

Queries the measured voltage value for withstand-voltage tests.

Syntax	:MEASure:WITHstand:VOLTage?
Response syntax	<data>
<data>	Withstand-voltage test measured voltage value (NR2)
Function	Queries the measured voltage value (unit: kV) for withstand-voltage tests.
Example	Queries the measured voltage value for withstand-voltage tests. Transmission :MEASure:WITHstand:VOLTage? Response 1.00 The measured voltage value is 1.00 kV.
Error	The execution of this command in a state other than the TEST state causes an execution error.

:MEASure:WITHstand:CURRent?

Queries the measured current value for withstand-voltage tests.

Syntax :MEASure:WITHstand:CURRent?

Response syntax <data>

<data> Withstand-voltage test measured current value (NR1 or NR2)

Function Queries the measured current value (unit: mA) for withstand-voltage tests.

Example Queries the measured current value for withstand-voltage tests.
Transmission :MEASure:WITHstand:CURRent?
Response 2.00
The measured current value is 2.00 mA.

Error The execution of this command in a state other than the TEST state causes an execution error.

:MEASure:WITHstand:TIMer?

Queries the test time elapsed for withstand-voltage tests.

Syntax :MEASure:WITHstand:TIMer?

Response syntax <data1>, <data2>

<data1> Withstand-voltage test time elapsed (NR1 or NR2)

<data2> Timer types: 0 (test time), 1 (ramp-up time), 2 (ramp-down time) (NR1)

Function Queries the test time elapsed (unit: s) for withstand-voltage tests.

Example Queries the test time elapsed for withstand-voltage tests.
Transmission :MEASure:WITHstand:TIMer?
Response 30.0,0
The elapsed test time is 30.0 s, and the type of timer is test time.

Error The execution of this command in a state other than the TEST state causes an execution error.

:MEMory:WITHstand:FILE?

Queries the contents of the set-value memory for withstand-voltage tests.

Syntax	:MEMory:WITHstand:FILE? <data>
Response syntax	<data1>,<data2>,<data3>,<data4>,<data5>,<data6>,<data7>
<data1>	Test type: 0 (AC50 Hz-withstand-voltage test), 1 (AC60 Hz-withstand-voltage test), 2 (DC-withstand-voltage test) (NR1)
<data2>	Test-voltage value: 0.20 to 5.00 (unit: kV, NR2)
<data3>	Upper-limit value: 0.1 to 100 (unit: mA, NR1 or NR2)
<data4>	Lower-limit value: 0 (OFF), 0.1 to 99.9 (unit: mA, NR2 or character data)
<data5>	Test time setting value: 0 (OFF), 0.3 to 999 (unit: s, NR1, NR2 or character data)
<data6>	Ramp-up time setting value: 0 (OFF), 0.1 to 99.9 (unit: s, NR2 or character data)
<data7>	Ramp-down time setting value: 0 (OFF), 0.1 to 99.9 (unit: s, NR2 or character data)
Function	Queries the contents of the set-value memory for the withstand-voltage test number specified in <data>.
Example	Queries the contents of memory file 1 for withstand-voltage tests. Transmission :MEMory:WITHstand:FILE? 1 Response 0,1.20,5.0,0,20.0,5.0,0 Test type: AC50 Hz-withstand-voltage test; Test voltage: 1.2 kV; Upper-limit value: 5 mA; Lower-limit value: OFF; Test time: 20.0 s; Ramp-up time: 5.0 s; Ramp-down time: OFF
Error	An execution error occurs when file numbers other than 1 to 10 are specified.

:MEMory:WITHstand:LOAD

Loads the set-value memory for withstand-voltage tests.

Syntax	:MEMory:WITHstand:LOAD <data>
<data>	1 to 10 (NR1)
Function	Loads the data saved for the withstand-voltage test file numbers specified in <data>.
Example	Loads memory file 1 for withstand-voltage tests. Transmission :MEMory:WITHstand:LOAD 1
Error	The execution of this command in a state other than the withstand-voltage mode READY state causes an execution error. The execution of this command in the insulation-resistance mode and program mode also causes an execution error. An execution error occurs when file numbers other than 1 to 10 are specified.

:MEMory:WITHstand:SAVE

Saves set values for withstand-voltage tests in memory.

Syntax :MEMory:WITHstand:SAVE <data>

<data> 1 to 10 (NR1)

Function Saves the current withstand-voltage test settings in the memory file specified in <data>.

Example Saves the settings for withstand-voltage tests in memory file 2.
Transmission :MEMory:WITHstand:SAVE 2

Error The execution of this command in a state other than the withstand-voltage mode READY state causes an execution error.
The execution of this command in the insulation-resistance mode and program mode also causes an execution error.
An execution error occurs when file numbers other than 1 to 10 are specified.

:MEMory:WITHstand:CLEar

Clears the set-value memory for withstand-voltage tests.

Syntax :MEMory:WITHstand:CLEar <data>

<data> 1 to 10 (NR1)

Function Clears and resets the data saved for the withstand-voltage test specified in <data>.

Example Clears and resets the contents of memory file 3 for withstand-voltage tests.
Transmission :MEMory:WITHstand:CLEar 3

Error The execution of this command in a state other than the READY state causes an execution error.
An execution error occurs when file numbers other than 1 to 10 are specified.

:CONFigure:INSulation:VOLTage

Sets the test-voltage value for insulation-resistance tests.

Syntax :CONFigure:INSulation:VOLTage <data>

<data> 50 to 1200 (NR1)

Function Sets the test-voltage value (unit: V) for insulation-resistance tests, in the READY state.

Example Sets the test-voltage value for the insulation-resistance tests to 500 V.
Transmission :CONFigure:INSulation:VOLTage 500

Error The execution of this command in a state other than the READY state or "test setting state" causes an execution error.
The lower-limit value restricts the test-voltage-value setting range (see Section 4.3.1 Setting of Test-Voltage Values). The transmission of a value outside the range causes an execution error.

:CONFigure:INSulation:VOLTage?

Queries the test-voltage value for insulation-resistance tests.

Syntax	:CONFigure:INSulation:VOLTage?
Response syntax	<data>
<data>	50 to 1200 (NR1)
Function	Queries the test-voltage value (unit: V) for insulation-resistance tests.
Example	Queries the test-voltage value for insulation-resistance tests. Transmission :CONFigure:INSulation:VOLTage? Response 500 The test-voltage value is 500 V.

:CONFigure:INSulation:RUPPer

Sets the upper-limit value for insulation-resistance tests.

Syntax	:CONFigure:INSulation:RUPPer <data>
<data>	0.10 to 9999 (NR1)
Function	Sets the upper-limit value (unit: M Ω) for insulation-resistance tests, in the READY state.
Example	Sets the upper-limit value value for the insulation-resistance tests to 2000 M Ω . Transmission :CONFigure:INSulation:RUPPer 2000
Error	The execution of this command in a state other than the READY state or "test setting state" causes an execution error.

:CONFigure:INSulation:RUPPer?

Queries the upper-limit value for insulation-resistance tests.

Syntax	:CONFigure:INSulation:RUPPer?
Response syntax	<data>
<data>	0.10 to 9999 (NR1 or NR2)
Function	Queries the upper-limit value (unit: M Ω) for insulation-resistance tests.
Example	Queries the upper-limit value for insulation-resistance tests. Transmission :CONFigure:INSulation:RUPPer? Response 2000 The upper-limit value is 2000 M Ω .

:CONFigure:INSulation:RLOWer

Sets the lower-limit value for insulation-resistance tests.

- Syntax** :CONFigure:INSulation:RLOWer <data>
- <data>** 0.10 to 9999 (NRf)
- Function** Sets the lower-limit value (unit: M Ω) for insulation-resistance tests, in the READY state.
- Example** Sets the lower-limit value value for the insulation-resistance tests to 10.0 M Ω .
Transmission :CONFigure:INSulation:RLOWer 10.0
- Error** The execution of this command in a state other than the READY state or "test setting state" causes an execution error.
The test-voltage value restricts the lower-limit-value setting range (see Section 4.3.2 Setting of Lower-Limit Values (Upper-Limit Values)). The transmission of a value outside the range causes an execution error.

:CONFigure:INSulation:RLOWer?

Queries the lower-limit value for insulation-resistance tests.

- Syntax** :CONFigure:INSulation:RLOWer?
- Response syntax** <data>
- <data>** 0.10 to 9999 (NR1 or NR2)
- Function** Queries the lower-limit value (unit: M Ω) for insulation-resistance tests.
- Example** Queries the lower-limit value for insulation-resistance tests.
Transmission :CONFigure:INSulation:RLOWer?
Response 10.0
The lower-limit value is 10.0 M Ω .

:CONFigure:INSulation:TIMer

Sets the test time for insulation-resistance tests.

- Syntax** :CONFigure:INSulation:TIMer <data>
- <data>** 0.3 to 999 (NRf)
- Function** Sets the test time (unit: s) for insulation-resistance tests, in the READY state.
- Example** Sets the test time for the insulation-resistance tests to 10.0 s.
Transmission :CONFigure:INSulation:TIMer 10.0
- Error** The execution of this command in a state other than the READY state or "test setting state" causes an execution error.

:CONFigure:INSulation:TIMer?

Queries the test time for insulation-resistance tests.

Syntax	:CONFigure:INSulation:TIMer?
Response syntax	<data>
<data>	0.3 to 999 (NR1 or NR2)
Function	Queries the test time (unit: s) for insulation-resistance tests.
Example	Queries the test time for insulation-resistance tests. Transmission :CONFigure:INSulation:TIMer? Response 10.0 The test time is set to 10.0 s.

:CONFigure:INSulation:DELay

Sets the delay time for insulation-resistance tests.

Syntax	:CONFigure:INSulation:DELay <data>
<data>	0.1 to 99.9 (NR1 or NR2)
Function	Sets the delay time (unit: s) for insulation-resistance tests in the READY state.
Example	Sets the delay time for insulation-resistance tests at 3.0 s. Transmission :CONFigure:INSulation:DELay 3.0
Error	The execution of this command in a state other than the READY state or "test setting state" causes an execution error.

:CONFigure:INSulation:DELay?

Queries the delay time for insulation-resistance tests.

Syntax	:CONFigure:INSulation:DELay?
Response syntax	<data>
<data>	0.1 to 99.9 (NR2)
Function	Queries the delay time (unit: s) for insulation-resistance tests.
Example	Queries the delay time for insulation-resistance tests. Transmission :CONFigure:INSulation:DELay? Response 3.0 The set test time is 3.0 s.

:INSulation:RUPPer

Enables and disables the upper-limit value for insulation-resistance tests.

Syntax :INSulation:RUPPer <data>

<data> ON/OFF (Character data)

Function Enables and disables the upper-limit value for insulation-resistance tests, in the READY state.

Example Enables the upper-limit value for an insulation-resistance test.
Transmission :INSulation:RUPPer ON

Error The execution of this command in a state other than the READY state or "test setting state" causes an execution error.

:INSulation:RUPPer?

Queries the upper-limit value enablement for insulation-resistance tests.

Syntax :INSulation:RUPPer?

Response syntax <data>

<data> ON/OFF (Character data)

Function Queries the upper-limit value enablement for insulation-resistance tests.

Example Queries the upper-limit value enablement for insulation-resistance tests.
Transmission :INSulation:RUPPer?
Response OFF

:INSulation:TIMer

Enables and disables the test time for insulation-resistance tests.

Syntax :INSulation:TIMer <data>

<data> ON/OFF (Character data)

Function Enables and disables the test time for insulation-resistance tests, in the READY state.

Example Enables the test time for an insulation-resistance test.
Transmission :INSulation:TIMer ON

Error The execution of this command in a state other than the READY state or "test setting state" causes an execution error.

:INSulation:TIMer?

Queries the test time enablement for insulation-resistance tests.

Syntax	:INSulation:TIMer?
Response syntax	<data>
<data>	ON/OFF (Character data)
Function	Queries the test time enablement for insulation-resistance tests.
Example	Queries the test time enablement for insulation-resistance tests. Transmission :INSulation:TIMer? Response ON

:INSulation:DELAy

Sets the delay time ON/OFF for insulation-resistance tests.

Syntax	:INSulation:DELAy <data>
<data>	ON/OFF (Character data)
Function	Sets the delay time ON/OFF for insulation-resistance tests in the READY state.
Example	Sets the delay time for insulation-resistance tests to ON. Transmission :INSulation:DELAy ON
Error	The execution of this command in a state other than the READY state or "test setting state" causes an execution error.

:INSulation:DELAy?

Queries the delay time ON/OFF for insulation-resistance tests.

Syntax	:INSulation:DELAy?
Response syntax	<data>
<data>	ON/OFF (Character data)
Function	Queries the delay time ON/OFF for insulation-resistance tests.
Example	Queries the delay time ON/OFF for insulation-resistance tests. Transmission :INSulation:DELAy? Response ON

:MEASure:RESult:INSulation?

Queries the insulation-resistance test result.

Syntax	:MEASure:RESult:INSulation?
Response syntax	<data1>,<data2>,<data3>,<data4>
<data1>	Measured voltage value (unit: V)
<data2>	Measured resistance value (unit: MΩ) O.F.: 10000 U.F.: 0
<data3>	Test time elapsed (unit: s)
<data4>	Determination Excluding determination: NR1 or NR2 Determination: PASS UFAIL (UPPER FAIL) LFAIL (LOWER FAIL) ULFAIL (UPPER LOWER FAIL) OFF (Others) (Character data)
Function	Queries the results of the preceding test. Returns the determination and valid values at termination of the preceding test. The test results are updated upon termination of a new test.
Example	Queries the measured value for insulation-resistance test. Transmission :MEASure:RESult:INSulation? Response 500,100,10.0,PASS Measured voltage value: 500 V; Measured current value: 100 MΩ; Test time elapsed: 10.0 s; Determination: PASS

:MEASure:INSulation:VOLTage?

Queries the measured voltage value for insulation-resistance tests.

Syntax	:MEASure:INSulation:VOLTage?
Response syntax	<data>
<data>	Insulation-resistance test measured voltage value (NR1)
Function	Queries the measured voltage value (unit: V) for insulation-resistance tests.
Example	Queries the measured voltage value for insulation-resistance tests. Transmission :MEASure:INSulation:VOLTage? Response 500 The measured voltage value is 500 V.
Error	The execution of this command in a state other than the TEST state causes an execution error.

:MEASure:INSulation:RESistance?

Queries the measured resistance value for insulation-resistance tests.

Syntax :MEASure:INSulation:RESistance?

Response syntax <data>

<data> Insulation-resistance test measured resistance value (NR1 or NR2)
O.F.: 10000
U.F.: 0

Function Queries the measured resistance value (unit: $M\Omega$) for insulation-resistance tests.

Example Queries the measured resistance value for insulation-resistance tests.

Transmission :MEASure:INSulation:RESistance?

Response 100.0

The measured resistance value is 100 $M\Omega$.

Error The execution of this command in a state other than the TEST state causes an execution error.

:MEASure:INSulation:TIMer?

Queries the test time elapsed for insulation-resistance tests.

Syntax :MEASure:INSulation:TIMer?

Response syntax <data>

<data> Insulation-resistance test time elapsed (NR1 or NR2)

Function Queries the test time elapsed (unit: s) for insulation-resistance tests.

Example Queries the test time elapsed for insulation-resistance tests.

Transmission :MEASure:INSulation:TIMer?

Response 10.0

The test time elapsed is 10.0 s.

Error The execution of this command in a state other than the TEST state causes an execution error.

:MEMory:INSulation:FILE?

Queries the content of data saved for insulation-resistance tests.

Syntax :MEMory:INSulation:FILE? <data>

<data> 1 to 10 (NR1)

Response syntax <data1>,<data2>,<data3>,<data4>,<data5>,<data6>

<data1> Test type: 3 (insulation-resistance test)

<data2> Test-voltage value: 50 to 1200 (unit: V, NR1)

<data3> Upper-limit value: 0 (OFF), 0.10 to 9999
(unit: M , NR1 or NR2)

<data4> Lower-limit value: 0.10 to 9999
(unit: M , NR1 or NR2)

<data5> Test time setting value: 0 (OFF), 0.3 to 999
(unit: s, NR1 or NR2)

<data6> Delay time setting value: 0 (OFF), 0.1 to 99.9
(unit: s, NR1 or NR2)

Function Queries the content of setting value memory for the insulation-resistance file specified in <data>.

Example Queries insulation-resistance test data to memory file 1.

Transmission :MEMory:INSulation:FILE? 1

Response 3,1000,0,100,5.0,1.0

Test type: insulation-resistance test; Test voltage: 1000 V;

Upper-limit value: OFF; Lower-limit value: 100 M ;

Test time: 5.0 s; Delay time: 1.0 s

Error An execution error occurs when file numbers other than 1 to 10 are specified.

:MEMory:INSulation:LOAD

Loads data saved for insulation-resistance tests.

Syntax :MEMory:INSulation:LOAD <data>

<data> 1 to 10 (NR1)

Function Loads the data saved for the insulation-resistance file specified in <data>.

Example Loads insulation-resistance test data to memory file 1.

Transmission :MEMory:INSulation:LOAD 1

Error The execution of this command in a state other than the insulation-resistance mode READY state causes an execution error.

The execution of this command in the withstand-voltage mode and program mode also causes an execution error.

An execution error occurs when file numbers other than 1 to 10 are specified.

:MEMory:INSulation:SAVE

Saves data for insulation-resistance tests to memory files.

Syntax :MEMory:INSulation:SAVE <data>

<data> 1 to 10 (NR1)

Function Saves the current insulation-resistance test settings in the memory file specified in <data>.

Example Saves insulation-resistance test data to memory file 2.
Transmission :MEMory:INSulation:SAVE 2

Error The execution of this command in a state other than the insulation-resistance mode READY state causes an execution error.

The execution of this command in the withstand-voltage mode and program mode also causes an execution error.

An execution error occurs when file numbers other than 1 to 10 are specified.

:MEMory:INSulation:CLEar

Clears the insulation-resistance test data saved to memory files.

Syntax :MEMory:INSulation:CLEar <data>

<data> 1 to 10 (NR1)

Function Clears and resets the data saved for the insulation-resistance test specified in <data>.

Example Clears the insulation-resistance test data saved to memory file 3.
Transmission :MEMory:INSulation:CLEar 3

Error The execution of this command in a state other than the READY state causes an execution error.
An execution error occurs when file numbers other than 1 to 10 are specified.

:PROGram:EDIT:FILE

Sets the file scanner mode for program tests.

Syntax :PROGram:EDIT:FILE <data1>,<data2>

<data1> 1 to 32 (NR1): File number

<data2> 0 to 2 (NR1)
0: OFF (unused)
1: Multiple mode
2: Single mode

Function Sets the file scanner mode for program tests.

Example Sets program test file No. 1 to multi-mode.
Transmission :PROGram:EDIT:FILE 1,1

Error The execution of this command in a state other than the READY state or "test setting state" causes an execution error.

:PROGram:EDIT:FILE?

Queries the file scanner mode for program tests.

Syntax :PROGram:EDIT:FILE? <data>

<data> 0 to 32 (NR1): File number

Response syntax <data1>

<data1> 0 (OFF (unused)), 1 (Multiple mode), 2 (Single mode)

Function Queries the file scanner mode for program tests.

Example Queries the scanner mode for program test file No. 1.
Transmission :PROGram:EDIT:FILE? 1
Response 1
The scanner mode is multi-mode.

:PROGram:EDIT:STEP

Makes settings for the scanner, test mode, and test conditions for program test step.

- Syntax** :PROGram:EDIT:STEP <data1>,<data2>,<data3>,<data4>,<data5>,<data6>,<data7>,<data8>,<data9>,<data10>,<data11>,<data12>,<data13>,<data14>
- <data1>** 1 to 32: File number
- <data2>** 1 to 50: Step number
- <data3>** 0 (OFF), 1 to 4: Scanner box number (high voltage side)
- <data4>** 1 to 4 (Multiple mode), 1 to 8 (Single mode): Scanner channel number (high voltage side)
- <data5>** 0 (OFF), 1 to 4: Scanner box number (low voltage side)
- <data6>** 5 to 8 (Multiple mode), 0 (Single mode): Scanner channel number (low voltage side)
- <data7>** 0: Stop upon completion of this step., 1: Proceed to the next step.
- Withstand-voltage test**
- <data8>** Test type: 0 (AC50 Hz-withstand-voltage test), 1 (AC60 Hz-withstand-voltage test), 2 (DC-withstand-voltage test)
- <data9>** Test-voltage value: 0.20 to 5.00
- <data10>** Upper-limit value: 0.1 to 100 (AC-withstand-voltage test), 0.1 to 10 (DC-withstand-voltage test)
- <data11>** Lower-limit value: 0 (OFF), 0.1 to 99 (AC-withstand-voltage test), 0.1 to 9.9 (DC-withstand-voltage test)
- <data12>** Test time: 0.3 to 999
- <data13>** Ramp-up timer: 0 (OFF), 0.1 to 99.9
- <data14>** Ramp-down timer: 0 (OFF), 0.1 to 99.9
- Insulation-resistance test**
- <data8>** Test type: 3 (insulation-resistance test)
- <data9>** Test-voltage value: 50 to 1200
- <data10>** Upper-limit value: 0 (OFF), 0.10 to 9999
- <data11>** Lower-limit value: 0.10 to 9999
- <data12>** Test time: 0.3 to 999
- <data13>** Delay time: 0 (OFF), 0.1 to 99.9
0 (OFF)
- <data14>** Input "0" at all times (<data 1> is always in NRf format).
- Function** Sets the scanner, test mode, and test conditions for the desired file and step for the program tests.
- Example** In step 2 of program test file No. 1, a withstand-voltage test is conducted with CH 1 of scanner box 1 on the high-pressure side and CH 7 of scanner box 2 on the low-pressure side, before proceeding to the next step. (The scanner is set in multi-mode.)
Makes settings as follows: File No. 1, step No. 2, CH 1 of scanner box 1 (high pressure), CH 7 of scanner box 2 (low pressure), proceeds to the next step, AC 50 Hz withstand-voltage test, test voltage 1.50 kV, upper-limit value 10 mA, lower -limit value OFF, test time 5.0 s, ramp-up time 2.0 s, ramp-down time OFF
Transmission :PROGram:EDIT:STEP 1,2,1,1,2,7,1,0,1.50,10,0,5.0,2.0,0
- Error** The execution of this command in a state other than the READY state or "test setting state" causes an execution error.
The transmission of the following settings causes an execution error:
Insulation-resistance mode
(1) Delay time test time
(2) Due to the relationship between the test voltage and the lower-limit value, the transmission of a test voltage or lower-limit value outside the range causes an execution error.

:PROGram:EDIT:STEP?

Queries settings for the scanner, test mode, and test conditions for program test step.

Syntax	:PROGram:EDIT:STEP? <data1>,<data2>
<data1>	1 to 3 (NR1): File number
<data2>	1 to 50 (NR1): Step number
Response syntax	<data1>,<data2>,<data3>,<data4>,<data5>,<data6>,<data7>,<data8>,<data9>,<data10>,<data11>,<data12>,<data13>,<data14>
<data1>	1 to 32 (NR1): File number
<data2>	1 to 50 (NR1): Step number
<data3>	0 (OFF), 1 to 4: Scanner box number (high voltage side) (NR1)
<data4>	1 to 4 (Multiple mode), 1 to 8 (Single mode): Scanner channel number (high voltage side) (NR1)
<data5>	0 (OFF), 1 to 4: Scanner box number
<data6>	5 to 8 (Multiple mode), 0 (Single mode): Scanner channel number (low voltage side) (NR1)
<data7>	0: Stop upon completion of this step., 1: Proceed to the next step. (NR1)
	Withstand-voltage test
<data8>	Test type: 0 (AC50 Hz-withstand-voltage test), 1 (AC60 Hz-withstand-voltage test), 2 (DC-withstand-voltage test)
<data9>	Test-voltage value: 0.20 to 5.00 (NR2)
<data10>	Upper-limit value: 0.1 to 100 (AC-withstand-voltage test), 0.1 to 10 (DC-withstand-voltage test) (NR1 or NR2)
<data11>	Lower-limit value: 0 (OFF), 0.1 to 99 (AC-withstand-voltage test),0.1 to 9.9 (DC-withstand-voltage test) (NR1 or NR2)
<data12>	Test time: 0.3 to 999 (NR1 or NR2)
<data13>	Ramp-up time: 0 (OFF), 0.1 to 99.9 (NR1 or NR2)
<data14>	Ramp-down time: 0 (OFF), 0.1 to 99.9 (NR1 or NR2)
	Insulation-resistance test
<data8>	Test type: 3 (insulation-resistance test) (NR1)
<data9>	Test-voltage value: 50 to 1200 (NR1)
<data10>	Upper-limit value: 0 (OFF), 0.10 to 9999 (NR1 or NR2)
<data11>	Lower-limit value: 0.10 to 9999 (NR1 or NR2)
<data12>	Test time: 0.3 to 999 (NR1 or NR2)
<data13>	Delay time: 0 (OFF), 0.1 to 99.9 (NR1 or NR2)
<data14>	0 (OFF) (NR1)
Function	Queries the scanner, test mode, and test conditions of the file and step to be confirmed for program tests.
Example	Queries the scanner mode of program test file No. 1. Transmission :PROGram:EDIT:STEP? 1,2 Response 1,2,1,1,2,7,1,0,1.50,10,0,5.0,2.0,0 File No. 1, step No. 2, CH 1 of scanner box 1 (high pressure), CH 7 of scanner box 2 (low pressure), proceeds to the next step, AC 50 Hz withstand-voltage test, test voltage 1.50 kV, upper-limit value 10 mA, lower-limit value OFF, test time 5.0 s, ramp-up time 2.0 s, ramp-down time OFF

:PROGram:LOAD:FILE

Loads the program test file.

Syntax :PROGram:LOAD:FILE <data>

<data> 1 to 32 (NR1)

Function Loads the program test file.

Example Loads program test file No. 5.
Transmission :PROGram:LOAD:FILE 5

Error The execution of this command in a state other than the READY state or "test setting state" causes an execution error.
An execution error occurs when file numbers other than 1 to 32 are specified.

:MEASure:RESult:FILE?

Queries the test result of the program test file.

Syntax :MEASure:RESult:FILE?

Response syntax <data>

<data> 0 (PASS) or 1 to 50 (Step No. s that resulted in a FAIL) (NR1)

Function Queries the test result of the program test file that executed the test.

Example Queries the test result of the program test file that executed the test.
Transmission :MEASure:RESult:FILE?
Response 5
The result was FAIL in step 5.

Note An execution error will occur if testing is terminated before all steps that have been programmed have ended.

:MEASure:RESult:STEP?

Queries the measured result in the program test step.

Syntax :MEASure:RESult:STEP? <data>

<data> 1 to 50 (NR1)

Response <data1>,<data2>,<data3>,<data4>,<data5>,<data6>

syntax (<data6>: withstand-voltage test only)

When the designated step is a withstand-voltage test

<data1> Test type: 0 (AC50 Hz-withstand-voltage test), 1 (AC60 Hz-withstand-voltage test), 2 (DC-withstand-voltage test) (NR1)

<data2> Measured voltage value (unit: kV)

<data3> Measured current value (unit: mA)

<data4> Test time elapsed (unit: s)

<data5> Determination: PASS
 UFAIL (UPPER FAIL)
 LFAIL (LOWER FAIL)
 ULFAIL (UPPER LOWER FAIL)
 OFF (Others) (Character data)

<data6> Timer type: 0 (test time), 1 (ramp-up time), 2 (ramp-down time) (NR1)
 Test type, determination, Other than the type of timer: NR1 or NR2

When the designated step is an insulation-resistance test

<data1> Test type: 3 (insulation-resistance test) (NR1)

<data2> Measured voltage value (unit: V)

<data3> Measured resistance value (unit: M Ω)
 O.F.: 10000
 U.F.: 0

<data4> Test time elapsed (unit: s)

<data5> Determination: PASS
 UFAIL (UPPER FAIL)
 LFAIL (LOWER FAIL)
 ULFAIL (UPPER LOWER FAIL)
 OFF (Others) (Character data)
 Test type, excluding determination: (NR1 or NR2)

Function Queries the measured result in the step.

Example Queries the measured result in step No. 3.

Transmission :MEASure:RESult:STEP? 3

Response 3,500,120,10.0,PASS

Output voltage 500 V, measured resistance value 120 M Ω , test time 10.0 s,
 test result PASS.

10.4 Response Formats

The response format is identical to the VFD display format, except that the former lacks spaces.

**Test-voltage value, Measured voltage value
(withstand-voltage mode, unit: kV)**

.
Three digits (in NR2 format)

**Test-voltage value, Measured voltage value
(insulation-resistance mode, unit: V)**

One, two, three or four digits (in NR1 format)

**Upper-limit value, Lower-limit value
(withstand-voltage mode, unit: mA)**

.
Two or three digits (in NR1 or NR2 format)

**Upper-limit value, Lower-limit, Resistance value (insulation-
resistance mode, unit: MΩ)**

.
Three or four digits (in NR1 or NR2 format)

Measured current value (withstand-voltage mode, unit: mA)

.
Three or four digits (in NR1 or NR2 format)

Measured resistance value (insulation-resistance mode, unit: MΩ)

.
Three or four digits (in NR1 or NR2 format)

Test time, Ramp timer, Delay time setting value (withstand-voltage mode and insulation-resistance mode, unit: s)

.
.
Two or three digits (in NR1 or NR2 format)

Test time elapsed (withstand-voltage mode and insulation-resistance mode, unit: s)

.
.
Two to three digits (in NR1 or NR2 format)

10.5 GP-IB Interface



10.5.1 Specifications

(1) Command system

The GP-IB command system of this unit conforms to IEEE-488.2 (1987).

(2) Connector

This is a 24-pin connector for the IEEE488 bus. Standard bus cables can be used together.

10.5.2 Preparing for Data Transfer

(1) Connecting cable

Connect the GP-IB connector of this unit to the GP-IB connector of the controller using a GP-IB CONNECTOR CABLE. Use either of the following HIOKI genuine products:
9151-02 GP-IB CABLE (2 m)

(2) Connection to Computer

1. Connect the 3153 to the computer using the GP-IB cable.
2. After connecting, turn on both 3153 and personal computer power.

(3) Setting of optional functions

To perform communication and control with the computer through the use of GP-IB of this unit, optional functions must be set.



In this unit, GP-IB and RS-232C cannot be used at the same time.

1. Press the **SHIFT** + **STOP** keys in the READY state to display the "optional function setting window." See Chapter 7.
2. Set "START" for the interface command to "1: Set". This will activate the interface command :START.
3. Change the page, and make settings for the PC interface. When using GP-IB, select "2: GP-IB."

0	RS-232C	9600bps
1	RS-232C	19200bps
2	GP-IB	
4. When GP-IB is selected, the GP-IB address setting items are displayed in the lower column. Move the flashing cursor and set the GP-IB address using the / keys.
5. Press the **SHIFT** + **STOP** keys to close the "optional function setting window."

10.6 GP-IB Command Transfer Methods

The command transfer method is the same as that for RS-232C. See Section 10.1.3 Command Transfer Method for RS-232C. The following is the command transfer method for GP-IB.

Terminator

This unit accepts LF, EOI, and LF+EOI as terminators. As terminators for response messages, those specified below can be selected using the command :TRANsmit:TERMinator.

- (1) LF + EOI (initial state)
- (2) CR, LF + EOI

Status Model

In its implementation of the serial polling function using service requests, the 3153 employs the status model specified by IEEE 488.2.

The term "event" refers to any phenomenon which generates a service request.

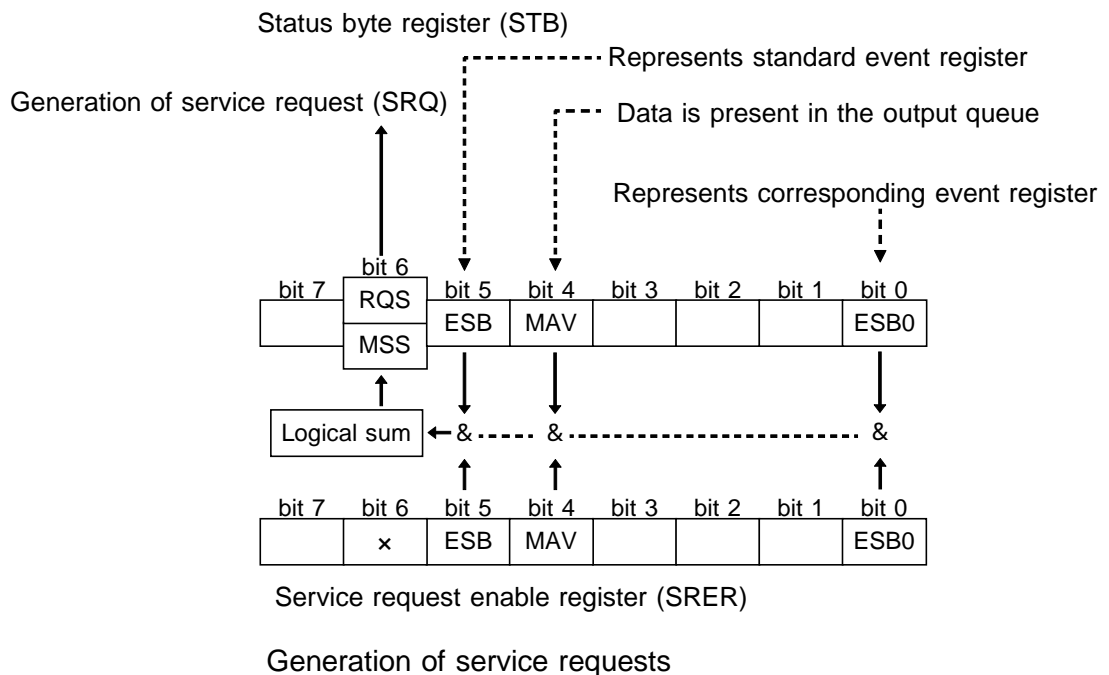

The status byte register holds information relating to the event registers and the output queue.

It is further possible to use the service request enable register as a mask to select the items required. If any of the bits selected by the mask becomes 1, bit 6 (the master summary status or MSS bit) is also set to 1, an RQS message is generated, and this generates a service request.

Status Byte Register

(1) Status byte register (STB)

The status byte register is an 8-bit register whose contents are output from the 3153 to the controller, when serial polling is being performed. If any bit in the status byte register has changed from 0 to 1 (provided that it is a bit which has been set in the service request enable register as a bit which can be used), then the MSS bit is set to 1. Simultaneously with this the RQS bit is also set to 1, and a service request is generated.

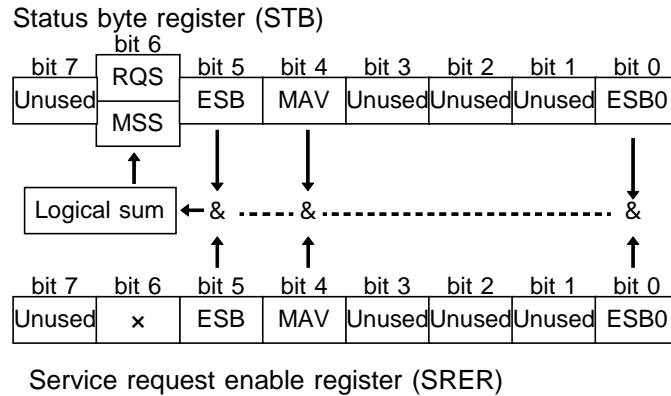

The RQS bit is synchronized with service requests, and is read out and simultaneously cleared when serial polling is being performed. Although the MSS bit is only read out on an *STB? query, on a *CLS command for example it is not cleared until the event is cleared.

Status byte register bit assignments

Bit 7	Unused.
Bit 6 RQS	Set to 1 when a service request is issued.
MSS	Logical sum of the other bits of the status byte register
Bit 5 ESB	Standard event summary (logical sum) bit Shows a logical sum of the standard event status register.
Bit 4 MAV	Message available. Shows that there is at least one message in the output queue.
Bit 3	Unused.
Bit 2	Unused.
Bit 1	Unused.
Bit 0	Event summary bit 0 Shows a logical sum of event status register 0.

(2) Service request enable register (SRER)

This register masks the status byte register. Setting a bit of this register to 1 enables the corresponding bit of the status byte register to be used.

Event Registers

(1) Standard event status register (SESR)

The standard event status register is an 8-bit register. If any bit in the standard event status register is set to 1 (after masking by the standard event status enable register), bit 5 (ESB) of the status byte register is set to 1.

Status byte register (STB)

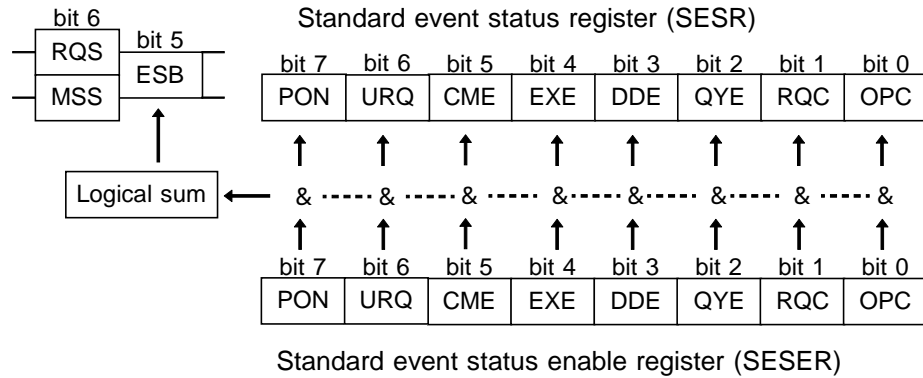

The standard event status register is cleared in the following four situations:

- When a *CLS command is received.
- When an *ESR? query is received.
- When the unit is powered on.
- When the I/F is Switched.

(2) Standard event status enable register (SESER0)

Setting any bit of the standard event status enable register to 1 enables the corresponding bit of the standard event status register to be accessed.

Standard event status register (SESR0) bit assignments

Bit 7 PON	Power on flag. When the power is turned on, or on recovery from a power cut, this bit is set to 1.
Bit 6 URQ	User request. Not used by the 3153.
Bit 5 CME	Command error. When a command which has been received contains a syntactic or semantic error, this bit is set to 1. <ul style="list-style-type: none"> • The command is not supported by the 3153. • There is a mistake in a program header. • The number of data parameters is wrong. • The format of the parameters is wrong.
Bit 4 EXE	Execution error. When for some reason a command which has been received cannot be executed, this bit is set to 1. <ul style="list-style-type: none"> • The designated data value is outside the set range. • The designated data value is not acceptable. • Execution is impossible because some other function is being performed.
Bit 3 DDE	Device dependent error. When a command cannot be executed due to some cause other than a command error, a query error, or an execution error, this bit is set to 1. Execution is impossible due to an abnormality inside the 3153.
Bit 2 QYE	Query error. This bit is set to 1 when a query error is detected by the output queue control. <ul style="list-style-type: none"> • When an attempt has been made to read the output queue when it is empty. • When the data overflows the output queue. • When data in the output queue has been lost.
Bit 1 RQC	Request for controller authority. Not used by the 3153.
Bit 0 OPC	Operation terminated. This bit is set to 1 when an *OPC command is executed, when the operation of all the messages up to the *OPC command has been completed.

(3) Event status register 0 (ESR0)

An 8-bit event status register is provided for managing events on the 3153. If any bit in this event status register is set to 1 (after masking by the corresponding event status enable register), the following happens:

For event status register 0, bit 0 of the status byte register (ESB0) is set to 1.

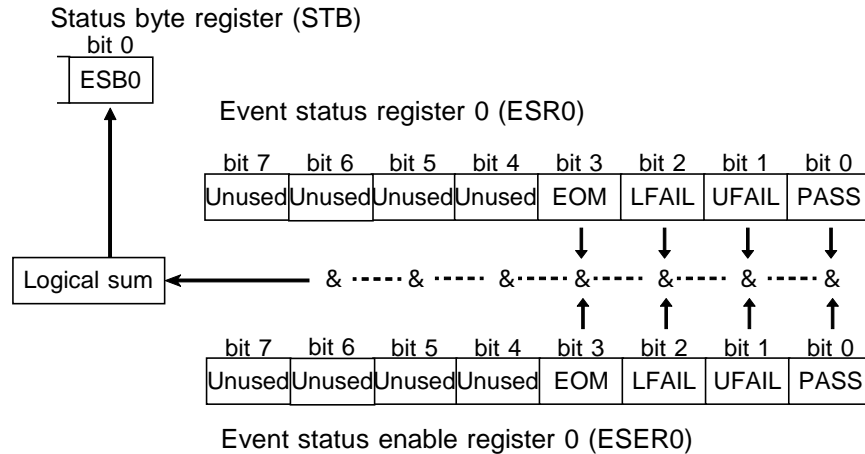

Event status register 0 is cleared in the following three situations:

- When a *CLS command is received.
- When an :ESR0? query is received.
- When the unit is powered on.

Event status register 0 (ESR0) bit assignments

Bit 7	Unused
Bit 6	Unused
Bit 5	Unused
Bit 4	Unused
Bit 3 EOM	Test completed
Bit 2 LFAIL	Below lower-limit of comparator
Bit 1 UFAIL	Above upper-limit of comparator
Bit 0 PASS	Within limits of comparator

(4) Event status enable register 0 (ESER0)

This event status enable register masks the corresponding event status register.

(5) Summary of commands for writing and reading each of the registers

Register	Read	Write
Status byte register	*STB?	
Service request enable register	*SRE?	*SRE
Standard event status register	*ESR?	
Standard event status enable register	*ESE?	*ESE
Event status register 0	:ESR0?	
Event status enable register 0	:ESE0?	:ESE0

(6) Transmission and response formats

The transmission and response formats are the same as those used for RS-232C. See Section 10.1.3.

10.7 GP-IB Commands

The following commands are used for performing interface functions:

Command	Function
GTL	Go To local The remote state is canceled,, and the system goes into the local state.
LLO	Local Lock Out All keys, including the LOCAL key, become inoperable.
DCL	Device Clear Clears the input buffer and the output queue.
SDC	Selected Device Clear Clears the input buffer and the output queue.

10.8 GP-IB Command Reference

The commands specified below can be used through interface function.

10.8.1 Command Reference

The commands are the same as those used for RS-232C. See Section 10.3.1 Common Command. Those specified below are the commands that can be used for GP-IB only.

*ESE

Sets the standard event status enable register.

Syntax *ESE <data>

<data> 0 to 255 (NR1)

- Function**
- Sets the standard event status enable register (SESER) to a bit pattern which is used to mask the standard event status register (SESR).
 - The numerical value can be in NRf format, but any digits after the decimal point will be rounded.
 - When the power is turned on, the data is reinitialized to zero.

Example Bits 2 and 4 of SESER are set to 1.
Transmission *ESE 20

Error If <data> is other than numerical value described above, an execution error occurs.

128 bit7	64 bit6	32 bit5	16 bit4	8 bit3	4 bit2	2 bit1	1 bit0
PON	URQ	CME	EXE	DDE	QYE	RQC	OPC

Standard event status enable register (SESER)

*ESE?

Queries the standard event status enable register.

Syntax *ESE?

Response syntax <data>

<data> 0 to 255 (NR1)

Function Returns the setting contents of SESER as a numerical value in NR1 format between 0 and 255.

Example Queries the standard event status enable register.

Transmission *ESE?

Response 20

Bits 2 and 4 of SESER have been set to 1.

Error If the response message is longer than 300 bytes, a query error is generated.

128 bit7	64 bit6	32 bit5	16 bit4	8 bit3	4 bit2	2 bit1	1 bit0
PON	URQ	CME	EXE	DDE	QYE	RQC	OPC

Standard event status enable register (SESER)

*OPC

After all action has been completed during execution, performs an SRQ request.

Syntax *OPC

Function Sets bit 0 (the OPC bit) of the standard event status register (SESR) to 1 at the instant the previous commands which is on the same line with *OPC have been completed.

Example After all action has been completed during execution, performs an SRQ request.

Transmission *OPC

Error If the data parameters are set after this command, a command error occurs.

*OPC?

Queries whether or not all action has been completed during execution.

Syntax *OPC?

Function The same as the *OPC command, except in that, at the instant that the previous commands have been completed. Returns the response message "1", instead of bit 0 (the OPC bit) of the standard event status register (SESR) being set to 1. No header is affixed to the response message.

Example Queries whether or not all action has been completed during execution.

Transmission *OPC?

Response 1

Error If the response message is longer than 300 bytes, a query error is generated.

*SRE

Sets the service request enable register.

Syntax *SRE <data>

<data> 0 to 255 (NR1)

- Function**
- Sets a pattern which is used to mask the status byte register (STB) to the service request enable register (SRSR).
 - The numerical value can be in NRf format, but any digits after the decimal point will be rounded.
 - The settings of unused bits (bits 1, 2, 3, and 7) and bit 6 are disregarded.
 - When the power is turned on, the data is reinitialized to zero.

Example Bits 0 and 5 of SRER are set to 1.
Transmission *SRE 33

Error If <data> is other than numerical value described above, an execution error occurs.

128 bit7	64 bit6	32 bit5	16 bit4	8 bit3	4 bit2	2 bit1	1 bit0
Unused	Unused	ESB	MAV	Unused	Unused	Unused	ESE0

Service request enable register (SRER)

*SRE?

Queries the service request enable register (SRER).

Syntax *SRE?

Function Returns the set contents of the service request enable register (SRER) as a numerical value in NR1 format between 0 and 255.

Example Queries the service request enable register (SRER).

Transmission *SRE?

Response 33

Bits 0 and 5 of SRER have been set to 1.

Error If the response message is longer than 300 bytes, a query error is generated.

128 bit7	64 bit6	32 bit5	16 bit4	8 bit3	4 bit2	2 bit1	1 bit0
Unused	x	ESB	MAV	Unused	Unused	Unused	ESE0

Service request enable register (SRER)

*STB?

Queries the status byte register.

Syntax *STB?

<data> 0 to 255 (NR1)

Function Returns the set contents of the status byte register (STB) as a numerical value in NR1 format between 0 and 1, 16 and 17, 32 and 33, 48 and 49, 64 and 65, 80 and 81, 96 and 97, 112 and 113.
No header is affixed to the response message.

Example Queries the status byte register.

Transmission *STB?

Response 16

Error If the response message is longer than 300 bytes, a query error is generated.

128 bit7	64 bit6	32 bit5	16 bit4	8 bit3	4 bit2	2 bit1	1 bit0
Unused	MSS	ESB	MAV	Unused	Unused	Unused	ESE0

Status byte register (STB)

*WAI

Waits until all execution is fully completed.

Syntax *WAI

Function The unit goes into waiting state until the operation of the previous command has been completed.

Note The *WAI command is accepted by the 9518-02 interface because it is a standard command as specified by IEEE-488.2 1987. However, since all of the commands specific to the 3157 are in any case sequential commands, using this *WAI command never has any effect.

Example Waits until all execution is fully completed.

Transmission *WAI

Error If the data parameters are set after this command, a command error occurs.

10.8.2 Specific Command Messages

The commands are the same as those used for RS-232C. See Section 10.3.1 Common Command. Those specified below are the commands that can be used for GP-IB only.

:ESE0

Sets event status enable register 0.

Syntax :ESE0 <data>

<data> 0 to 255 (NR1)

- Function**
- Sets event status enable register 0 (ESER0) to the bitmask for controlling access to events in event status register 0 (ESR0).
 - The numerical value can be in NRF format, but any digits after the decimal point will be rounded.
 - When the power is turned on, the data is reinitialized to zero.

Example Bit 2 of ESER0 is set to 1.
Transmission :ESE0 4

Error If <data> is other than numerical value described above, an execution error occurs.

128 bit7	64 bit6	32 bit5	16 bit4	8 bit3	4 bit2	2 bit1	1 bit0
Unused	Unused	Unused	Unused	EOM	LFAIL	UFAIL	PASS

Event status enable register 0 (ESER0)

:ESE0?

Queries event status enable register 0.

Syntax :ESE0?

Response syntax <data>

<data> 0 to 255 (NR1)

- Function** Returns the value of event status register 0 (ESR0) as a numerical value in NR1 format between 0 and 255, and then clears event status register 0. No header is prefixed to the response message.

Example Queries event status enable register 0.
Transmission :ESE0?
Response 4
Bit 2 of ESR0 has been set to 1.

Error If the response message is longer than 300 bytes, a query error is generated.

128 bit7	64 bit6	32 bit5	16 bit4	8 bit3	4 bit2	2 bit1	1 bit0
Unused	Unused	Unused	Unused	EOM	LFAIL	UFAIL	PASS

Event status enable register 0 (ESER0)

:TRANsmit:TERMinator

Sets the data terminator for response messages.

Syntax :TRANsmit:TERMinator <data>

<data> 0 to 255 (NR1)
 0: LF+EOI
 1: CR, LF+EOI

Function Sets the data terminator for response messages.
 The numerical value can be in NRf format, but any digits after the decimal point will be rounded.
 When powering on, <data> is initially set to 0 (LF+EOI).

Example Sets the terminator for the response message to LF + EOI.
 Transmission :TRANsmit:TERMinator 0

Error If <data> is other than numerical value described above, an execution error occurs.

:TRANsmit:TERMinator?

Queries the data terminator for response messages.

Syntax :TRANsmit:TERMinator?

Response syntax <data>

<data> 0 to 255 (NR1)
 0: LF+EOI
 1: CR, LF+EOI

Function Returns the data terminator for response messages as a numerical value (0 or 1) in NR1 format.

Example Queries the data terminator for response messages.
 Transmission :TRANsmit:TERMinator?
 Response 0
 Data terminator has been set to LF+EOI.

Error If the response message is longer than 300 bytes, a query error is generated.

Chapter 11

Specifications

11.1 Basic Specifications

11.1.1 Withstand Voltage test portion

AC Test Voltage

Voltage	0.20 - 5.00 kV AC
Voltage testing method	PWM switching (Zero-toggle switch)
Transformer capacity	500 VA (30 min max.)
Setting method	Digital setting (Setting resolution: 0.01 kV)
Accuracy	$\pm(1.5\%$ of the setting value+2 dgt.)
Fluctuation rate	$\pm 7\%$ or less (Maximum rating: 5 kV/100 mA No load: Resistance load) ^{*2*3}
Current	100 mA ^{*1}
Waveform	Sine wave (Distortion rate: 5% or less, No load) ^{*2}
Frequency	50/60 Hz $\pm 0.2\%$
Voltage measurement	Average value rectified effective value display Digital: 0.00 - 5.00 kV AC (full-scale) Accuracy $\pm 1.5\%$ f.s. Analog: 0 - 5.0 kV AC (full-scale) Accuracy $\pm 5\%$ f.s.

- *1: Rated time for output voltages (at an ambient temperature of 23°C)
The transformer capacity of the unit is approximately half the rated output. Use the unit within the rated time. If the rated time is exceeded, the unit may overheat and thereby cause the thermal fuse for the internal circuit to blow out.

Current measurement range	Maximum test time	Pause
I \leq 60 mA	Continuous	None
60 mA < I \leq 100 mA	15 minutes	15 minutes

- *2: No load
When loaded with 40 M Ω (input impedance during measurement)
- *3: This is a case of transitional fluctuation. The voltage normally stabilizes within the set value in less than 1 s.

DC Test Voltage

Voltage	0.20 - 5.00 kVDC
Voltage testing method	PWM switching
Output capacity	50 VA (continuous)
Setting method	Digital setting (Setting resolution: 0.01 kV)
Accuracy	±(1.5% of the setting value+2 dgt.)
Fluctuation rate	±16% or less (Maximum rating: 5 kV/10 mA No load: Resistance load)*
Ripple voltage	6% of output voltage max. (5 kV DC output, 10 mA Resistance load)
Current	10 mA (continuous)
Voltage measurement	Average value display Digital: 0.00 - 5.00 kV DC (full-scale) Accuracy ±1.5%f.s. Analog: 0 - 5.0 kV DC (full-scale) Accuracy ±5%f.s.

*: No load

When loaded with 40 MΩ (input impedance during measurement)

Current Detection (AC/DC common)

Current measurement range	0.01 to 100.0 mA (AC), 0.01 to 10.0 mA (DC)
Designated value	AC: Average value rectified effective value display (digital) DC: Average value display (digital)
Measurement range	10 mA range (AC/DC), 100 mA range (AC)
Measured area and resolution	0.00 to 10.00 mA/ 0.01 mA (10 mA range) 10.1 to 100.0 mA/ 0.1 mA (100 mA range)
Accuracy	±(2% rdg.+5dgt.) for all ranges *

* The error limit is added when the scanner is used.

* For DC measurements, if the capacitance that is connected in parallel with the load is over 0.01 μF, the table above will not apply.

Decision Function

Decision method	Window comparator method (digital setting)
Decision contents	UPPER-FAIL : when measured current exceeds the upper-limit setting PASS : when measured current remains between the upper- / lower-limit settings for set time LOWER-FAIL : when the measured current is below the lower-limit setting
Decision process	Output to the display, beeper sound, signals to EXT I/O for each decision result
Setting range	AC: 0.1 to 100 mA (Upper-limit value), 0.1 to 99 mA (Lower-limit value) DC: 0.1 to 10 mA (Upper-limit value), 0.1 to 9.9 mA (Lower-limit value)
Setting resolution	0.1 mA (0.1 to 9.9 mA)/ 1 mA (10 to 100 mA)

11.1.2 Insulation resistance test portion

Test Voltage

Voltage	50 to 1200 V DC (positive electrode)
Voltage testing method	Digital setting (Setting resolution: 1 V)
Accuracy	$\pm(1.5\%$ of the setting value+2 dgt.)
Rated measurement current	1 mA
Short-circuit current	200 mA or less
Voltage measurement	Average value display Digital: 0 to 1200 V DC (full-scale) Accuracy $\pm (1.5\%$ rdg.+2 dgt.) Analog: 0 to 1200 V DC Accuracy $\pm 5\%$ f.s. (full-scale: 5 kV)

Resistance Measurement

Measured area and resolution	0.100 to 1.049 M Ω / 0.001 M Ω 1.05 to 10.49 M Ω / 0.01 M Ω 10.5 to 104.9 M Ω / 0.1 M Ω 105 to 9999 M Ω / 1 M Ω For the measurement range, see the table on appendix 4. The range varies depending on the output voltage.
Accuracy	See the following table. (The error limit is added when the scanner is used.)

Resistance Rm (M Ω)	Test voltage Vt (V)					
	50 Vt < 100	100 Vt < 250	250 Vt < 500	500 Vt < 750	750 Vt < 1000	1000 Vt < 1200
5000 < Rm < 9999	Out-of-spec error limit			25%rdg.	20%rdg.	
3000 < Rm < 5000				15%rdg.	10%rdg.	
1100 < Rm < 3000				15%rdg.	10%rdg.	5%rdg.
900 < Rm < 1100	20%rdg.	10%rdg.	4%rdg.			
100 < Rm < 900	15%rdg.					
10.0 < Rm < 100	10%rdg.					
1.00 Rm < 10.0	5%rdg.					
0.500 Rm < 1.00						
0.250 Rm < 0.500						
0.100 Rm < 0.250	Out of measurement range					

* For resistances Rm listed above that are connected in parallel to capacitances, accuracy is derived by referring to the JIS C1302 standard.

Decision Function

Decision method	Window comparator method (digital setting)
Decision contents	UPPER-FAIL : when measured current exceeds the upper-limit setting PASS : when measured current remains between the upper- / lower-limit settings for set time LOWER-FAIL : when the measured current is below the lower-limit setting
Decision process	Output to the display, beeper sound, signals to EXT I/O for each decision result
Setting range	0.10 to 9999 MΩ (Upper and lower-limit value)
Setting resolution	0.01 MΩ (0.10 to 9.99 MΩ) 0.1 MΩ (10.0 to 99.9 MΩ) 1 MΩ (100 to 9999 MΩ)

11.1.3 Timer Section

Test Time Timer

Setting range	0.3 to 999 s
Operation	ON : Displays the time that is counted down from the start OFF: Displays the time that has elapsed from the start
Setting resolution	0.1 s (0.3 to 99.9 s) / 1 s (100 to 999 s)
Accuracy	±0.5% of the setting value

Ramp timer (Withstand-voltage test)

Setting range	The ramp-up time and ramp-down time can be set individually in the range of 0.1 s to 99.9 s.
Operation	Ramp-up: Increase the voltage up to the set voltage value during the ramp-up time, prior to the test time. Ramp-down: Lower the set voltage value during the ramp-down time, following the test time. Both are displayed as time counted down from the set time.
Setting resolution	0.1 s (0.1 to 99.9 s)
Accuracy	±0.5% of the setting value

Delay Timer (Insulation resistance test)

Setting range	0.1 to 99.9 s
Operation	Sets the delay time as soon as the test timer starts; no screening is performed in the meantime.
Setting resolution	0.1 s (0.1 to 99.9 s)
Accuracy	±0.5% of the setting value

11.1.4 Interface

EXT I/O

(Rear panel: Input/Output signal lines are insulated internally with a photocoupler.)

Power supply	External power supply	V_{EXT} : EXT.DCV - EXT.COM
	Maximum external input voltage	$V_{EXTmax} = 30\text{ V}$
	Minimum external input voltage	$V_{EXTmin} = 5\text{ V}$
	Internal power supply	V_{INT} : $5\text{ V} \pm 0.5\text{ V}$, 60 mA (total)
Signal level	All signal active low input	
Output signals	Open collector output, pull-up resistance 4.7 k Ω (insulated with a photocoupler)	
Signal level	HIGH	: Minimum $V_{EXT} - 0.5\text{ V}$ (No load)
	LOW	: Maximum 0.5 V (TYP.) (No load)
Signal names	HV-ON	: Generating voltage for output
	TEST	: Test in progress
	PASS	: When measured current remains between the upper- / lower- limit settings for set time
	UFAIL	: When measured current exceeds the upper-limit setting
	LFAIL	: When the measured current is below the lower-limit setting
	READY	: Standby
	W-MODE	: Withstand-voltage test display
	I-MODE	: Insulation-resistance test display
	W-FAIL	: Withstand-voltage test FAIL determination
	I-FAIL	: Insulation-resistance test failed
	STEP-END	: When the step ends in a program test
	FILE-END	: When the file ends in a program test
	INT.DCV	: Internal support resistance current
Input signals	Active low input (insulated with a photocoupler)	
Signal level	HIGH	: Max. $V_{EXT} + 1\text{ V}$ (V_{EXTmax} or less), Min. $V_{EXT} - 1.5\text{ V}$
	LOW	: Max. $V_{EXT} - 4\text{ V}$, Min. 0 V
Signal names	START	: Measurement start
	STOP	: Measurement stop
	EXT-E	: External I/O effective
	FILE-E	: The file selection in a program test
	FILE-0 to 4	: The file number selection in a program test
	INTERLOCK	: Interlock function effective
	EXT.DCV	: External DC power supply (Recommend: 5 to 24 V DC)

EXT SW

Input signal (contact input)	START/STOP/SW.EN (front socket SW enable)
Output signal	LED light signal (40 mA max. load current)

PC Interface (Either RS-232C or GP-IB can be enabled.)

RS-232C	Transmission mode Start-stop synchronization, full duplex Transfer rate 9600 bps/ 19200 bps Data length 8 bit Parity None Stop bit 1 bit Hand shake No X flow, hardware flow control Delimiter CR, CR + LF for reception CR + LF for transmission
GP-IB	The GP-IB command system of this unit conforms to IEEE-488.2 (1987).

Connection of scanners

Up to 4 scanners can be connected.

START key priority order

RS-232C interface or GP-IB > REMOTE CONTROL BOX > External I/O >
START key on this units panel (However, this is when START is enabled
 using the RS-232C interface or GP-IB.)

11.1.5 Program Function

Number of the files	32 files (max.)
Number of the steps	50 steps (max.) / file
Setting items	Setting items for each step Types of tests: AC withstand-voltage test/DC withstand-voltage test/insulation-resistance test Test point: Scanner No. (each HIGH/LOW scanner No., or High-side No. against COM)/scanner control OFF Test settings: Condition settings for withstand-voltage and insulation-resistance tests

11.1.6 Other Functions

Memory function	This function allows test conditions to be saved. Withstand-voltage mode: test type (AC50 Hz/AC60 Hz/DC), test voltage, current determination for upper- and lower-limit values, test time, ramp-up/down time. Insulation-resistance mode: test voltage, resistance determination for upper- and lower-limit values, test time, and delay time Up to 10 test conditions can be saved or loaded for both voltage and insulation-resistance mode.
Pass hold function	Enable this function to hold the Pass state when detected, to facilitate confirmation.
Fail hold function	Enable this function to hold the Fail state when detected, to facilitate confirmation.
Hold function	Retains the measured value when the test is forcibly terminated.
Buzzer settings	Buzzer volume settings for test screening and errors (buzzer volume settings are to be performed for PASS and FAIL separately)
Momentary output	This function allows current output only when the START key is pressed. The START key on the remote control or the START signal via external I/O has the same effect.
Double action	Enable this function to allow testing to start only when the START key is pressed within about 0.5 seconds after the STOP key.
Fail mode	Enable this function to restrict hold release to the STOP key on the main unit.
PC command "START"	This function validates or invalidates START from a PC interface.
Interlock function	To set ON/OFF for the interlock function
Ramp-up screening	To set ON/OFF for screening during the ramp-up time (Withstand-voltage test)
Insulation-resistance range	Fixed range/ auto range (However, no determination is made when Auto Range is selected.)
TEST-signal output	To set ON/OFF for external I/O and TEST-signal output when TEST is flashing
Test end mode	Enable this mode to terminate an insulation-resistance test when the set time of the timer has elapsed (unrelated to screening), or to terminate the test at PASS or FAIL screening (only when the timer is set). (Insulation-resistance test)
Maximum output voltage	To set the upper-limit for the output voltage (common to withstand-voltage mode and insulation-resistance mode)
PC interface	To select an interface from among RS-232C (9,600 bps), RS-232C (19,200 bps), and GP-IB. When GP-IB is selected, address (0 to 30) is to be set.

11.2 General Specifications

Test function	Withstand-voltage test (AC50 Hz, AC60 Hz, DC), Insulation-resistance test
Test mode	Manual test mode: W/I Auto test mode: W (AC/DC) I I W (AC/DC) Program test mode: Tests set by program functions
Display	Fluorescent tube display (digital display), analog meter
Monitor function	Output voltage / Current / Measurement resistance
Monitor cycle	2 Hz or faster
Operating temperature and humidity	0 to 40°C (32 to 104°F), 80% RH or less (no condensation)
Storage temperature and humidity	-10 to 50°C (14 to 122°F), 90% RH or less (no condensation)
Operating temperature and humidity for guaranteed accuracy	23°C ± 5°C (73°F ± 9°F), 80% RH or less (no condensation) after 10 minutes minimum warm-up
Period of guaranteed accuracy	1 year
Product warranty period	3 years
Operating Environment	Indoors, Pollution Degree 2, max. 2000 m (6562 feet) height
Rated power supply voltage	100 to 120 VAC, 200 to 240 V AC (Voltage fluctuations of ±10% from the rated supply voltage are taken into account.)
Rated power supply frequency	50/60 Hz
Fuse	250VT10AL (100 to 120 V), 250VT5AL (200 to 240 V)
Dielectric strength	1.62 kVAC, 15 mA, 1 min. between power supply and frame
Maximum rated power	1000 VA
Backup battery and life	Approx. 10 years (25°C reference value)
Dimensions	Approx. 320W × 155H × 480D mm (12.60"W × 6.10"H × 18.90"D) (excluding projections)
Mass	Approx. 18 kg (634.9 oz.)
Accessories	9615 H.V. TEST LEAD (high voltage side and return, 1 each) Power cord*, Spare fuse*, Instruction manual *: To be designated at the time of ordering, in accordance with the power-supply voltage to be used
Options	3930 HIGH VOLTAGE SCANNER 9151-02 GP-IB CONNECTOR CABLE (2 m) 9267 SAFETY TEST DATA MANAGEMENT SOFTWARE 9637 RS-232C CABLE (9 pin - 9 pin/ 1.8 m) 9638 RS-232C CABLE (9 pin - 25 pin/ 1.8 m) 9613 REMOTE CONTROL BOX (SINGLE) 9614 REMOTE CONTROL BOX (DUAL)
Standard Applying	EMC EN61326 Class A Safety EN61010

Chapter 12

Maintenance and Inspection

12.1 Maintenance and Service

To ensure the safe operation of this unit, perform maintenance regularly.

- Be sure to read assiduously the various items highlighted in this manual for attention, in order to use the unit correctly.
- If the unit is not functioning properly, check the "Section 12.3 Troubleshooting" list. If a problem is found, contact your dealer or HIOKI representative. Pack the unit carefully so that it will not be damaged during transport, and write a detailed description of the problem. HIOKI cannot bear any responsibility for damage that occurs during shipment.
- If the unit has been subject to moisture, or if oil and dust have accumulated in the unit interior, the danger of electrical shock or fires resulting from the deterioration of insulation increases greatly. If the unit is ever subject to excessive moisture, oil, or dust, cease use immediately, and return the unit to us for maintenance.
- Periodic calibration is necessary to verify and maintain accuracy. If calibration becomes necessary, return the unit to us for maintenance.
- Replaceable Parts
Main parts to be replaced periodically, and their life times:(Useful life depends on the operating environment and frequency of use. Operation cannot be guaranteed beyond the following periods)

Part	Life
Fan Motor	Approx. 70000 hours
Lithium Battery	Approx. 10 years
Start Switch	Approx. 500000 cycles
Stop Switch	Approx. 500000 cycles
High voltage relay	Approx. 100000000 cycles

Part(9613/9614)	Life
Operate Switch	Approx. 25000 cycles
Start Switch	Approx. 1000000 cycles
Stop Switch	Approx. 1000000 cycles

- This product uses a lithium battery to back up it's memory. As the battery power is consumed, it's ability to store measurement conditions diminishes. In the event that measurement conditions can no longer be stored, please contact the manufacturer for repair service.
- Spare and replacement parts for this product are guaranteed to be available only until 7 years after manufacture of this model is terminated.

Cleaning

To clean the product, wipe it gently with a soft cloth moistened with water or mild detergent. Never use solvents such as benzene, alcohol, acetone, ether, ketones, thinners or gasoline, as they can deform and discolor the case.

12.2 Fuse Replacement



- To avoid electric shock, turn off the power switch and disconnect the H.V. TEST LEAD before replacing the fuse.
 - Replace the fuse only with one of the specified characteristics and voltage and current ratings. Using a non-specified fuse or shorting the fuse holder may cause a life-threatening hazard.
- Fuse type: 250VT10AL (100 to 120 V), 250VT5AL (200 to 240 V)**

1. Turn the power OFF, and disconnect the power cord.
2. Unlock the fastener on the fuse holder on the rear panel using a slotted screwdriver, and remove the fuse holder.

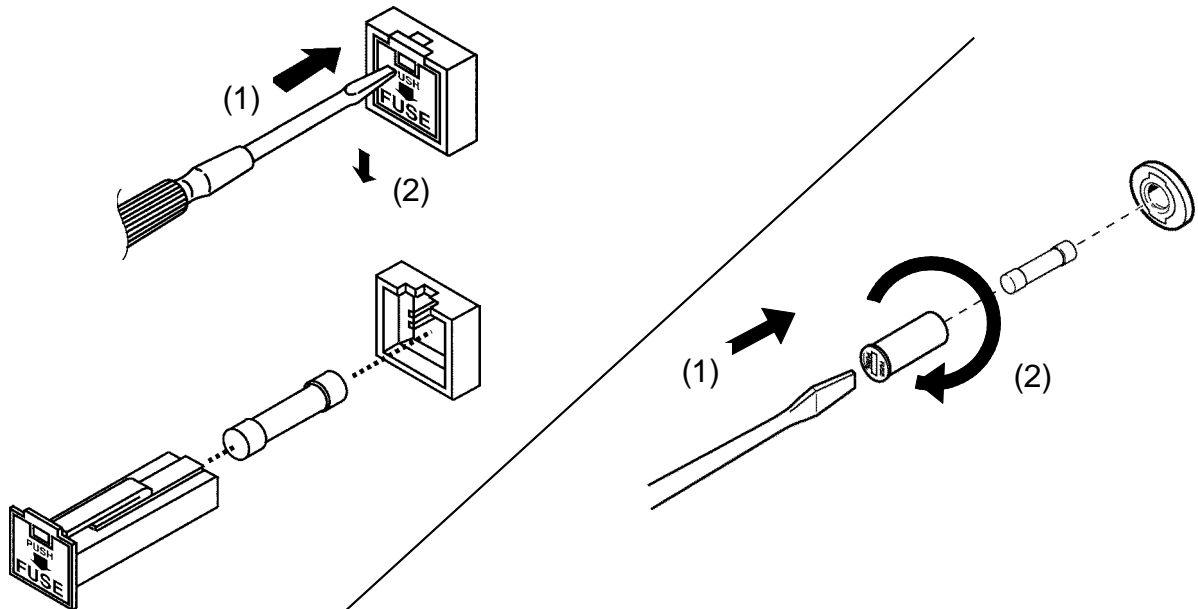

3. Replace the power fuse with a rated fuse. (The replacement method may differ depending on the shape of the fuse holder.)

4. Reset the fuse holder.

Fuse holder

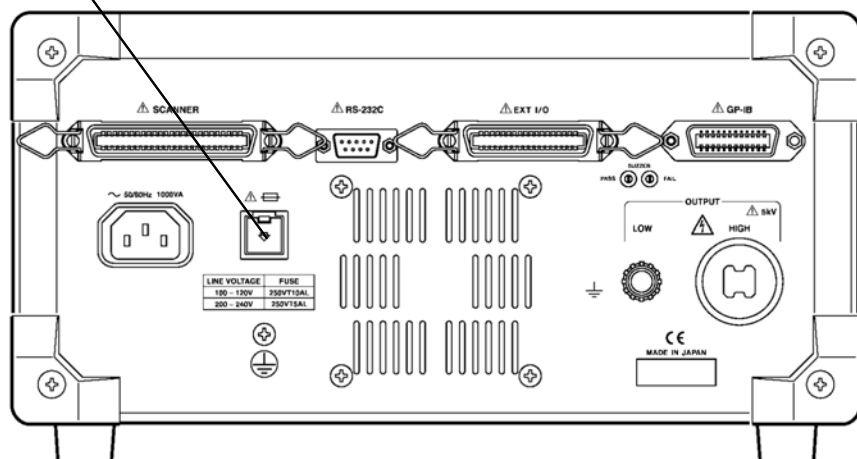

12.3 Troubleshooting

If damage is suspected, check the "Troubleshooting" section before contacting your dealer or Hioki representative.

Symptom	What to check and Solution
The screen does not illuminate when the power is turned on.	Is the power cord disconnected? Connect the power cord.
	Has the fuse blown? Replace the fuse.
The test will not begin even if the START key is pressed.	Is READY lit? Is EXT lit? The external I/O and the REMOTE CONTROL BOX have priority over the unit's START key. Turn off the power to disable the external I/O and the REMOTE CONTROL BOX, then turn on the power.
	Is Double Action set in Optional Functions? If Double Action is set, press the STOP key first and then press the START key.
	Is the STOP signal, at the LOW level, inputting via the external I/O connector? The START key has a lower priority than the STOP signal. Switch the STOP signal to the HIGH level when the START key is pressed.
	Does the STOP key remain pressed for any reason? The START key has a lower priority than the STOP key. Do not leave the STOP key pressed when the START key is pressed.
	Is the test voltage value greater than the output-voltage restricting value? Check the test voltage value and the output-voltage restricting value. Note that the unit does not start a test if the test voltage value is greater than the output-voltage restricting value. See Section 7.9 Setting of an Output-Voltage Restricting Value (p.119)

If any of the following should occur, stop using the unit, disconnect the power cord and probe, and contact your dealer or HIOKI representative.

- If you are certain that the unit is damaged.
- If the measurement you wish to perform is inoperative.
- If the unit was stored for a long period of time in high temperatures and humidity, or other undesirable conditions.
- If the unit was damaged in transit.

Notes on Transportation

- To ensure safe handling, when transporting the instrument, please use the original box and packing materials. However, do not use if the box is torn or out of shape, or if the packing materials are crushed.
- When packing the instrument, make sure to remove the test leads and power supply cords from the main device.
- When transporting, protect it from strong impact such as dropping it.

12.4 Displaying Errors

If an error occurs, the 3153 displays the following on the screen.

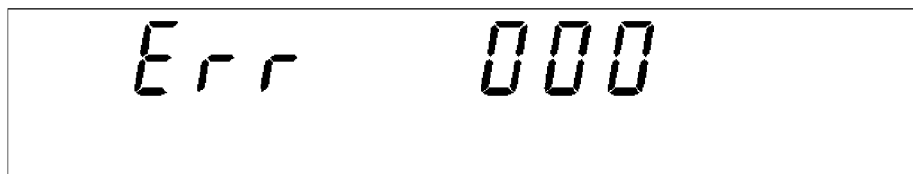

Err000	Interlock state. (See Section 9.1.4)
Err001	Analog-circuit error (PWM). Turn OFF the power switch on the unit, and then turn it ON again. If the unit is not restored, it may be malfunctioning. Contact your sales agent or nearest sales office.
Err002	Analog-circuit error (Vcc). This error can be caused by an abnormality in the power voltage, such as an instantaneous stop. Check the power voltage. Turn OFF the power switch on the unit, and then turn it ON again. If the unit is not restored, it may be malfunctioning. Contact your sales agent or nearest sales office.
Err003	System error has occurred. Turn off the main power switch, then turn it on again. If this action fails to reset the system, perform the all-system reset. (See 12.6, "System Reset.") If this action also fails to reset the system, the system may be malfunctioning. Contact your sales agent or nearest sales office.
Err O.H	Overheat error. The inside of the unit is overheated due to an overload or the like. (See Section 11.1.1) Leave the unit for several minutes without turning OFF the power switch. If the unit is not restored, it may be malfunctioning. Contact your sales agent or nearest sales office.

If the displayed number is outside the test setting range, follow the instructions for "Err003" in the table above.

When errors other than the above are displayed, the unit may be malfunctioning. Contact your sales agent or nearest sales office.

12.5 Removing the Lithium Battery



To avoid electrocution, turn off the power switch and disconnect the power cord and measurement cables before removing the lithium battery. When disposing of this product, remove the lithium battery and dispose of battery and product in accordance with local regulations.

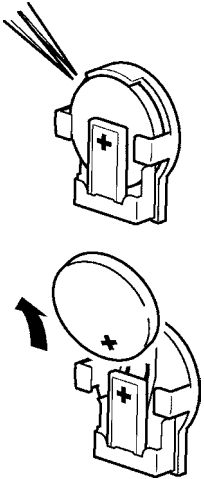

1. Turn OFF the power switch on the unit, and disconnect the power cord and probe.
2. Remove the 2 screws from the bottom of the unit using a Phillips screwdriver.
3. Remove the 4 legs (fastened with 4 screws) from the back of the unit using a Phillips screwdriver.
4. Remove the cover by sliding it backward.
5. The battery holder is in the position illustrated in the figure. Insert a pointed object such as tweezers between the battery and the battery holder, and remove the battery by lifting the battery.

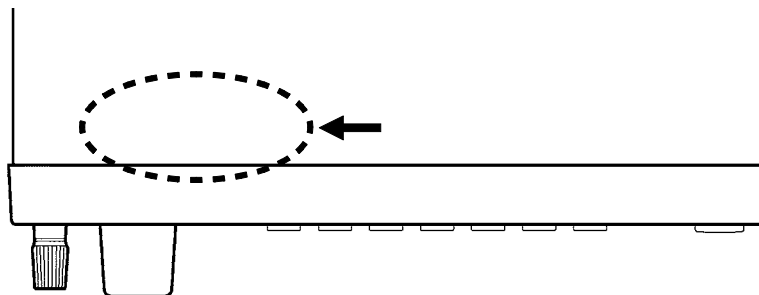

CALIFORNIA, USA ONLY

Perchlorate Material - special handling may apply.

See www.dtsc.ca.gov/hazardouswaste/perchlorate

12.6 Resetting the System

The two system reset methods specified below can be used (the content to be reset differs).

Method 1

Turn ON the main power switch while pressing the **SHIFT** key.

Contents to be reset: (1) + (2) + (3)

Method 2 (All system reset)

Turn ON the main power switch while pressing the **W** + **PROG** + **SHIFT** keys.

Contents to be reset: (1) + (2) + (3) + (4) + (5)

(1) Withstand-voltage mode

Test type	AC50 Hz
Test-voltage value	0.20 kV
Upper-limit value	0.2 mA
Upper-limit value setting	OFF
Lower-limit value	0.1 mA
Test time setting	ON
Test time	0.3 s
Ramp-up time setting	OFF
Ramp-up time	0.1 s
Ramp-down time setting	OFF
Ramp-down time	0.1 s

(2) Insulation resistance mode

Test-voltage value	50 V
Upper-limit value setting	OFF
Upper-limit value	9999 M
Lower-limit value	4000 M
Test time setting	ON
Test time setting	0.3 s
Delay time setting	OFF
Delay time	0.1 s

(3) Optional Functions

FAIL Hold, START protection function	1
Others	0

(4) Set-value memory

All files in withstand-voltage mode and insulation-resistance mode are reset to their initial values.

(5) Program files

Scanner	OFF
Proceed to the next step	OFF
Test setting	Initial setting (withstand-voltage mode)

Appendix

Appendix 1 9613 REMOTE CONTROL BOX (SINGLE)

The 9613 REMOTE CONTROL BOX (SINGLE) is equipped with a **START** key, a **STOP** key, and an OPERATE switch, which turns ON/OFF the REMOTE CONTROL BOX. The **STOP** key remains lit as long as a voltage is being output.

Ambient operating conditions	0 to 40°C (32 to 104°F), 80% RH or less (no condensation)
Ambient storage conditions	-10 to 50°C (14 to 122°F), 90% RH or less (no condensation)
Operating place	Indoors, max. 2000 m (6562 feet) height
Dimensions	Approx. 193W x 50H x 30D mm (7.60"W x 1.97"H x 1.18"D) (excluding projections)
Mass	Approx. 500 g (17.6 oz.)
Cord length	Approx. 1500 mm (59.06")

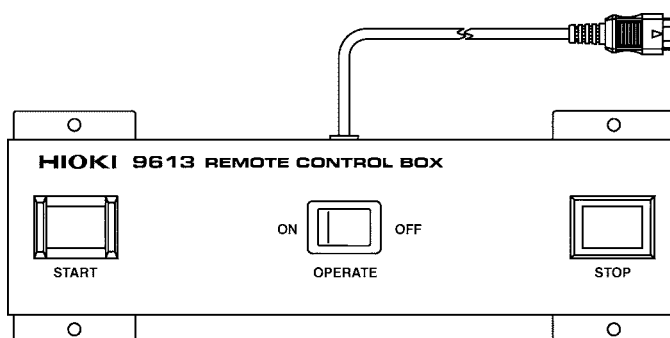

Appendix 2 9614 REMOTE CONTROL BOX (DUAL)

Unlike the 9613, the 9614 REMOTE CONTROL BOX (DUAL) has two **START** keys. Pressing both keys is equivalent to pressing the **START** key on the unit. By using the Momentary-OUT function in Optional Functions, the 9614 allows the REMOTE CONTROL BOX to be used with both hands, thus ensuring safer testing.

Ambient operating conditions	0 to 40°C (32 to 104°F), 80% RH or less (no condensation)
Ambient storage conditions	-10 to 50°C (14 to 122°F), 90% RH or less (no condensation)
Operating place	Indoors, max. 2000 m (6562 feet) height
Dimensions	Approx. 270W x 50H x 30D mm (10.63"W x 1.97"H x 1.18"D) (excluding projections)
Mass	Approx. 700 g (24.7 oz.)
Cord length	Approx. 1500 mm (59.06")

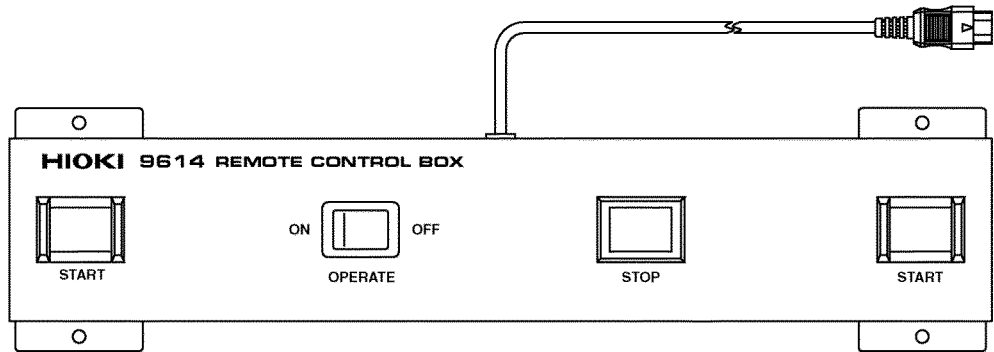

Appendix 3 9615 H.V. TEST LEAD (Standard Accessory)

Rated voltage	5 kVAC or 5 kVDC (High voltage side) 600 VAC or 600 VDC (Return side)
Rated current	150 mAAC or 150 mADC (High voltage side) 10 AAC or 10 ADC (Return side)
Dielectric strength	6.25 kVAC Sensitivity current 5 mA 1 minute (High voltage side) 1.35 kVAC Sensitivity current 5 mA 1 minute (Return side) Test point (between the core wire and the cable exterior)
Ambient operating conditions	0 to 40°C (32 to 104°F), 80% RH or less (no condensation)
Ambient storage conditions	-10 to 50°C (14 to 122°F), 90% RH or less (no condensation)
Operating place	Indoors, max. 2000 m (6562 feet) height
Dimensions	Approx. 1500 mm (59.06")
Mass	Approx. 100 g (3.5 oz.)

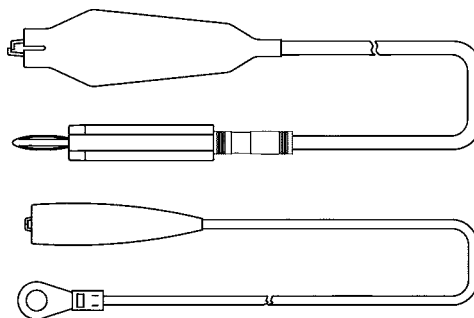

Appendix 4 Insulation Resistance Mode measurement range

The measurement range of the insulation resistance mode varies depending on the output voltage.

See the table on p. 221 for the measurement accuracy of each measurement range.

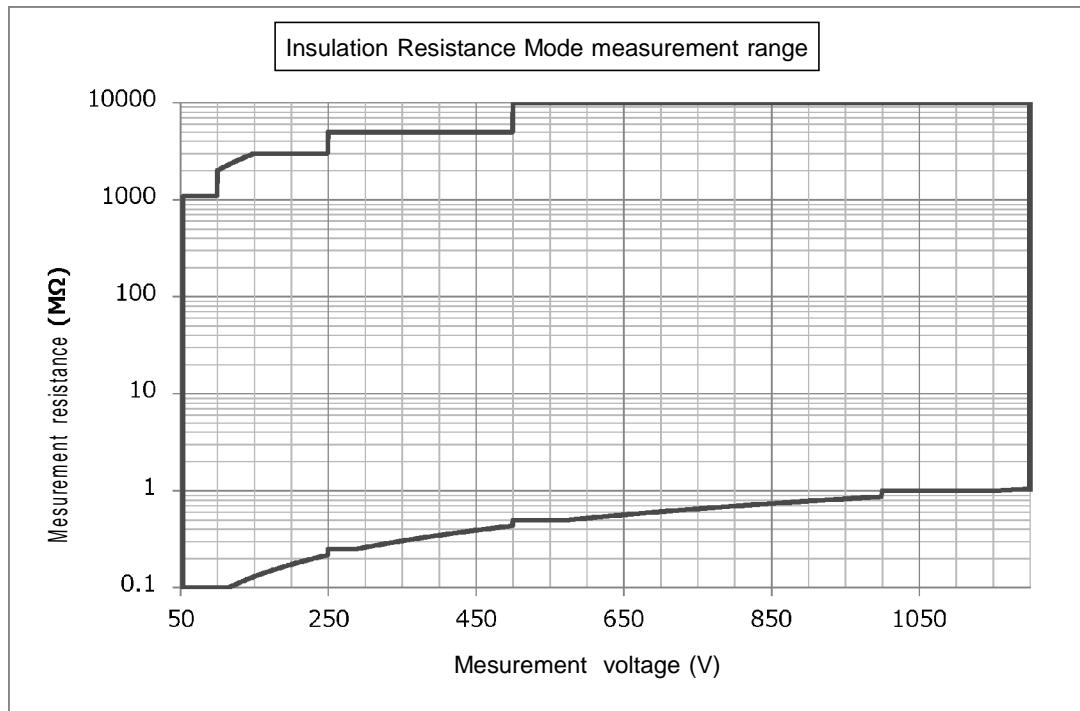

INDEX

- A -

Analog voltmeter 3,18,36,38,41,59,62,65
 Auto test mode 67
 Automatic discharge 42,66,82,105

- B -

Buzzer 5,154

- D -

DANGER lamp 3
 Delay time 53,165
 Delimiter 158,222
 Dimension 8
 Displaying error 231
 Disposal 232
 Double action 108,115

- E -

Event register 162,164,207
 External I/O
 22,36,38,41,46,59,62,65,86,99,101,104
 External I/O terminal 5,10,139
 External switch 3,7,15

- F -

FAIL hold function 108,111
 FAIL mode 108,116
 "FAIL" state 39,63,79,102
 File number 130,135
 Forced ending 21,45,69,85
 Fuse holder 5,227

- G -

GP-IB address 109,124,204
 GP-IB terminal 5

- H -

H.V. test lead 6,14,APPENDIX3
 HIGH terminal 3,5,14
 Hold function 108,112
 Hold state 100,102

- I -

Initial setting 108,109,234
 Input buffer 162
 Insulation resistance measurement range
 120
 Insulation resistance mode 43
 Insulation resistance test termination mode
 settings 121
 Inter-lock function 118,146

- K -

Key lock function 23,47,71,87
 Key-lock state 23,47,71,87

- L -

LOW terminal 3,5,14
 Load 134,165,225
 Lower limit value 26,50,164,165
 Lower limit value icon 22,46,130,135

- M -

Main power switch 3,12
 Measured current value 36,165
 Measured resistance 59,165
 Measured voltage value 36,59,165
 Measurement range 51,220,221
 Memory function 225
 Momentary Out 108,114

- O -

Operate switch 7,15
 Optional function 107
 Output queue 162
 Output-voltage restricting value 108,119

- P -

PASS HOLD function 108,110
 "PASS" state 37,60,76,100
 Parameter 160
 Power supply 12,226
 Priority for control 35,58,74,98,114
 Program mode 83
 Protective ground terminal 5,9

- R -

"READY" state 22,46,70,86
 RS-232C terminal 5
 Ramp timer 28,222
 Ramp-down time 28,162,222
 Ramp-up time 28,121,162,222
 Remote control box (dual hand) 7,APPENDIX2
 Remote control box (single hand) 7,APPENDIX1
 Remote state 4,211

- S -

START protection function 109,125
 Save 129,165,225
 Scanner connection terminal 5
 Screening during the ramp-up time 109,123
 "Setting" state 24,48
 Separator 161
 Set value memory 165
 Startup inspection 18
 Status byte register 164,206
 Step number 89
 Switch signal line plug 3,7,15
 System reset 233

- T -

TEST signal output 109,126
 "TEST" state 36,59,75,99
 Test time 27,52,164,165
 Test time elapsed 36,59,165
 Test voltage type 29
 Test voltage value 25,49,164,165
 Timing chart 149

- U -

Upper limit value 26,50,164,165
 Upper limit value icon 22,46,130,135

- V -

Volume adjustment knob 154

- W -

Withstand voltage mode 19

Warranty Certificate

HIOKI

Model	Serial number	Warranty period Three (3) years from date of purchase (___ / ___)
-------	---------------	--

Customer name: _____
Customer address: _____

Important

- Please retain this warranty certificate. Duplicates cannot be reissued.
- Complete the certificate with the model number, serial number, and date of purchase, along with your name and address. The personal information you provide on this form will only be used to provide repair service and information about Hioki products and services.

This document certifies that the product has been inspected and verified to conform to Hioki's standards. Please contact the place of purchase in the event of a malfunction and provide this document, in which case Hioki will repair or replace the product subject to the warranty terms described below.

Warranty terms

1. The product is guaranteed to operate properly during the warranty period (three [3] years from the date of purchase). If the date of purchase is unknown, the warranty period is defined as three (3) years from the date (month and year) of manufacture (as indicated by the first four digits of the serial number in YYMM format).
2. If the product came with an AC adapter, the adapter is warranted for one (1) year from the date of purchase.
3. The accuracy of measured values and other data generated by the product is guaranteed as described in the product specifications.
4. In the event that the product or AC adapter malfunctions during its respective warranty period due to a defect of workmanship or materials, Hioki will repair or replace the product or AC adapter free of charge.
5. The following malfunctions and issues are not covered by the warranty and as such are not subject to free repair or replacement:
 - 1. Malfunctions or damage of consumables, parts with a defined service life, etc.
 - 2. Malfunctions or damage of connectors, cables, etc.
 - 3. Malfunctions or damage caused by shipment, dropping, relocation, etc., after purchase of the product
 - 4. Malfunctions or damage caused by inappropriate handling that violates information found in the instruction manual or on precautionary labeling on the product itself
 - 5. Malfunctions or damage caused by a failure to perform maintenance or inspections as required by law or recommended in the instruction manual
 - 6. Malfunctions or damage caused by fire, storms or flooding, earthquakes, lightning, power anomalies (involving voltage, frequency, etc.), war or unrest, contamination with radiation, or other acts of God
 - 7. Damage that is limited to the product's appearance (cosmetic blemishes, deformation of enclosure shape, fading of color, etc.)
 - 8. Other malfunctions or damage for which Hioki is not responsible
6. The warranty will be considered invalidated in the following circumstances, in which case Hioki will be unable to perform service such as repair or calibration:
 - 1. If the product has been repaired or modified by a company, entity, or individual other than Hioki
 - 2. If the product has been embedded in another piece of equipment for use in a special application (aerospace, nuclear power, medical use, vehicle control, etc.) without Hioki's having received prior notice
7. If you experience a loss caused by use of the product and Hioki determines that it is responsible for the underlying issue, Hioki will provide compensation in an amount not to exceed the purchase price, with the following exceptions:
 - 1. Secondary damage arising from damage to a measured device or component that was caused by use of the product
 - 2. Damage arising from measurement results provided by the product
 - 3. Damage to a device other than the product that was sustained when connecting the device to the product (including via network connections)
8. Hioki reserves the right to decline to perform repair, calibration, or other service for products for which a certain amount of time has passed since their manufacture, products whose parts have been discontinued, and products that cannot be repaired due to unforeseen circumstances.

HIOKI E.E. CORPORATION

<http://www.hioki.com>

18-07 EN-3

HIOKI

<http://www.hioki.com>



**Our regional
contact
information**

HEADQUARTERS

81 Koizumi
Ueda, Nagano 386-1192 Japan

HIOKI EUROPE GmbH

Rudolf-Diesel-Strasse 5
65760 Eschborn, Germany
hioki@hioki.eu

1808EN

Edited and published by HIOKI E.E. CORPORATION

Printed in Japan

- CE declarations of conformity can be downloaded from our website.
- Contents subject to change without notice.
- This document contains copyrighted content.
- It is prohibited to copy, reproduce, or modify the content of this document without permission.
- Company names, product names, etc. mentioned in this document are trademarks or registered trademarks of their respective companies.