

2260B Series Multi-Range Programmable DC Power Supplies

Programming Manual

077104702 June 2022



077104702

Series 2260B

Multi-Range Programmable DC Power Supplies

PROGRAMMING MANUAL



ISO-9001 CERTIFIED MANUFACTURER

This manual contains proprietary information, which is protected by copyright. All rights are reserved. No part of this manual may be photocopied, reproduced or translated to another language without prior written consent.

The information in this manual was correct at the time of printing. However, we continue to improve our products and reserve the rights to change specification, equipment, and maintenance procedures at any time without notice.

Table of Contents

SAFETY INSTRUCTIONS	2
GETTING STARTED.....	6
2260B Series Overview	7
Appearance	10
Configuration Settings	17
REMOTE CONTROL.....	23
Interface Configuration	24
Socket Server Examples.....	37
Command Syntax	41
Command List.....	45
Status Register Overview	87
Error List.....	97
APPENDIX.....	106
2260B Default Settings.....	107
Error Messages & Messages	109
LED Display Format	110
INDEX.....	111

SAFETY INSTRUCTIONS

This chapter contains important safety instructions that you must follow during operation and storage. Read the following before any operation to insure your safety and to keep the instrument in the best possible condition.

Safety Symbols

These safety symbols may appear in this manual or on the instrument.



WARNING

Warning: Identifies conditions or practices that could result in injury or loss of life.



CAUTION

Caution: Identifies conditions or practices that could result in damage to the instrument or to other properties.



DANGER High Voltage



Attention Refer to the Manual



Protective Conductor Terminal



Earth (ground) Terminal



Do not dispose electronic equipment as unsorted municipal waste. Please use a separate collection facility or contact the supplier from which this instrument was purchased.

Safety Guidelines

General Guideline • Do not place any heavy object on the instrument.



CAUTION

- Avoid severe impact or rough handling that leads to damaging the instrument.
- Do not discharge static electricity to the instrument.
- Use only mating connectors, not bare wires, for the terminals.
- Do not block the cooling fan opening.
- Do not disassemble the instrument unless you are qualified.

(Measurement categories) EN 61010-1:2010 and EN 61010-2-030 specify the measurement categories and their requirements as follows. The 2260B falls under category II.

- Measurement category IV is for measurement performed at the source of low-voltage installation.
- Measurement category III is for measurement performed in the building installation.
- Measurement category II is for measurement performed on the circuits directly connected to the low voltage installation.
- 0 is for measurements performed on circuits not directly connected to Mains.

Power Supply



WARNING

- To avoid electrical shock connect the protective grounding conductor of the AC power cord to an earth ground.
-

Cleaning the Instrument

- Disconnect the power cord before cleaning.
 - Use a soft cloth dampened in a solution of mild detergent and water. Do not spray any liquid.
 - Do not use chemicals containing harsh material such as benzene, toluene, xylene, and acetone.
-

Operation Environment

- Location: Indoor, no direct sunlight, dust free, almost non-conductive pollution (Note below)
- Relative Humidity: 20%~ 85%
- Altitude: < 2000m
- Temperature: 0°C to 50°C

(Pollution Degree) EN 61010-1:2010 and EN 61010-2-030 specify the pollution degrees and their requirements as follows. The Instrument falls under degree 2.

Pollution refers to “addition of foreign matter, solid, liquid, or gaseous (ionized gases), that may produce a reduction of dielectric strength or surface resistivity”.

- Pollution degree 1: No pollution or only dry, non-conductive pollution occurs. The pollution has no influence.
 - Pollution degree 2: Normally only non-conductive pollution occurs. Occasionally, however, a temporary conductivity caused by condensation must be expected.
 - Pollution degree 3: Conductive pollution occurs, or dry, non-conductive pollution occurs which becomes conductive due to condensation which is expected. In such conditions, equipment is normally protected against exposure to direct sunlight, precipitation, and full wind pressure, but neither temperature nor humidity is controlled.
-

Storage environment

- Location: Indoor
 - Temperature: -15°C to 70°C
 - Relative Humidity: <90%
-

Disposal



Do not dispose this instrument as unsorted municipal waste. Please use a separate collection facility or contact the supplier from which this instrument was purchased. Please make sure discarded electrical waste is properly recycled to reduce environmental impact.

Power cord for the United Kingdom

When using the instrument in the United Kingdom, make sure the power cord meets the following safety instructions.

NOTE: This lead/appliance must only be wired by competent persons



WARNING: THIS APPLIANCE MUST BE EARTHED

IMPORTANT: The wires in this lead are coloured in accordance with the following code:

Green/ Yellow:	Earth
Blue:	Neutral
Brown:	Live (Phase)



As the colours of the wires in main leads may not correspond with the coloured marking identified in your plug/appliance, proceed as follows:

The wire which is coloured Green & Yellow must be connected to the Earth terminal marked with either the letter E, the earth symbol  or coloured Green/Green & Yellow.

The wire which is coloured Blue must be connected to the terminal which is marked with the letter N or coloured Blue or Black.

The wire which is coloured Brown must be connected to the terminal marked with the letter L or P or coloured Brown or Red.

If in doubt, consult the instructions provided with the equipment or contact the supplier.

This cable/appliance should be protected by a suitably rated and approved HBC mains fuse: refer to the rating information on the equipment and/or user instructions for details. As a guide, a cable of 0.75mm² should be protected by a 3A or 5A fuse. Larger conductors would normally require 13A types, depending on the connection method used.

Any exposed wiring from a cable, plug or connection that is engaged in a live socket is extremely hazardous. If a cable or plug is deemed hazardous, turn off the mains power and remove the cable, any fuses and fuse assemblies. All hazardous wiring must be immediately destroyed and replaced in accordance to the above standard.

GETTING STARTED

This chapter describes the power supply in a nutshell, including its main features and front / rear panel introduction. After going through the overview, please read the theory of operation to become familiar with the operating modes, protection modes and other safety considerations.



2260B Series Overview	7
Series lineup	7
Main Features	8
Appearance	10
2260B Front Panel	10
Rear Panel.....	13
Configuration Settings	17
Setting Configuration Settings	17
Configuration Table.....	18

2260B Series Overview

Series lineup

The 2260B series consists of 12 models, divided into 3 different model types covering 3 power capacities: 360W models, 720W models and 1080W models.



Note

Throughout the user manual, 2260B-30, 2260B-80, 2260B-250 or 2260B-800 will refer to any of the 2260B models with a maximum voltage rating of 30V, 80V, 250V or 800V, respectively.

Model name	Type	Voltage Rating	Current Rating	Power
2260B-30-36	360W models	0~30V	0~36A	360W
2260B-80-13	360W models	0~80V	0~13.5A	360W
2260B-250-4	360W models	0~250V	0~4.5A	360W
2260B-800-1	360W models	0~800V	0~1.44A	360W
2260B-30-72	720W models	0~30V	0~72A	720W
2260B-80-27	720W models	0~80V	0~27A	720W
2260B-250-9	720W models	0~250V	0~9A	720W
2260B-800-2	720W models	0~800V	0~2.88A	720W
2260B-30-108	1080W models	0~30V	0~108A	1080W
2260B-80-40	1080W models	0~80V	0~40.5A	1080W
2260B-250-13	1080W models	0~250V	0~13.5A	1080W
2260B-800-4	1080W models	0~800V	0~4.32A	1080W

Apart from the differences in output, each unit differs in size. The 720W and 1080W models are larger than the 360W models to accommodate the increase in power.

360 W models



720 W models



1080 W models



Main Features

Performance

- High performance/power
 - Power efficient switching type power supply
 - Low impact on load devices
 - Fast transient recovery time of 1ms
 - Fast output response time
-

Features

- OVP, OCP and OTP protection
 - Adjustable voltage and current slew rates
 - User adjustable bleeder control to quickly dissipate the power after shutdown to safe levels.
 - Extensive remote monitoring and control options
 - Support for series* and parallel connections.
*(30, 80 volt models only)
 - Power on configuration settings.
 - Web server monitoring and control
-

Interface

- Ethernet port
- Analog connector for analog voltage and current monitoring
- USB host and device port

Appearance

2260B Front Panel

2260B-30-72, 80-27, 250-9, 800-2 (720W)

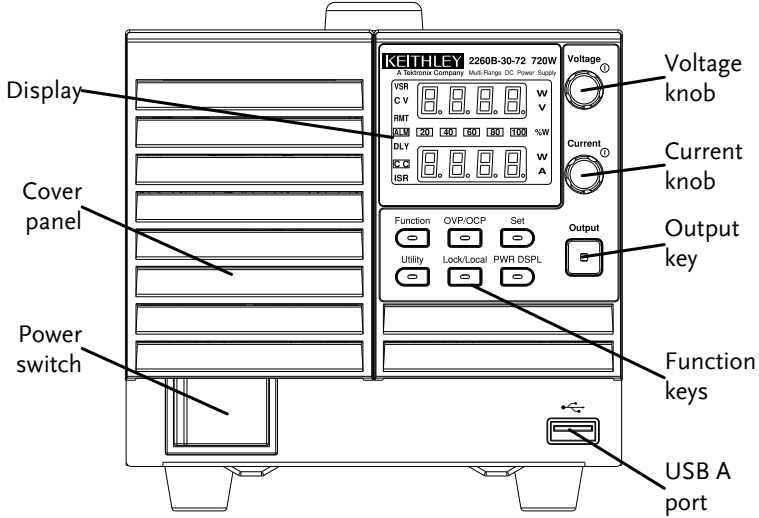

2260B-30-108, 80-40, 250-13, 800-4 (1080W)

2260B-30-36, 80-13, 250-4, 800-1 (360W)

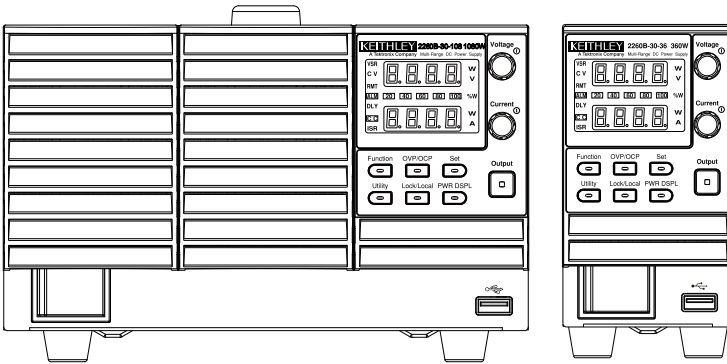

Function Keys The Function keys along with the Output key will light up when a key is active.

Function



The Function key is used to configure the power supply.

OVP/OCPP



Set the overcurrent or overvoltage protection levels.

Set



Sets the current and voltage limits.

Utility



Used to run customized Test sequence for testing.

Lock/Local



Locks or unlocks the panel keys to prevent accidentally changing panel settings.

PWR DSPL



Toggles the display from viewing V/A → V/W or A/W*.
*Press the Voltage knob for V/W, press the Current knob for A/W.

Display Indicators

VSR

Voltage Slew Rate

C V

Constant Voltage Mode

RMT

Remote Control Mode

ALM

Alarm on

DLY

Delay Output

C C

Constant Current Mode

ISR

Current Slew Rate

20 **40** **60**

Power bar

80 **100** % W

Indicates the current power output as a percentage.

Voltage Knob

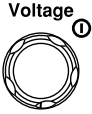

Sets the voltage.

Current Knob

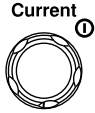

Sets the current.

Output



Press to turn on the output. The Output key will light up when the output is active.

USB

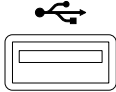

The USB A port is used to update the firmware. The firmware can only be updated at a service center.

Power Switch

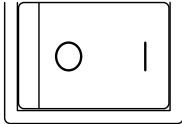

Used to turn the power on/off.

Rear Panel

2260B-30-72, 80-27 (720W)

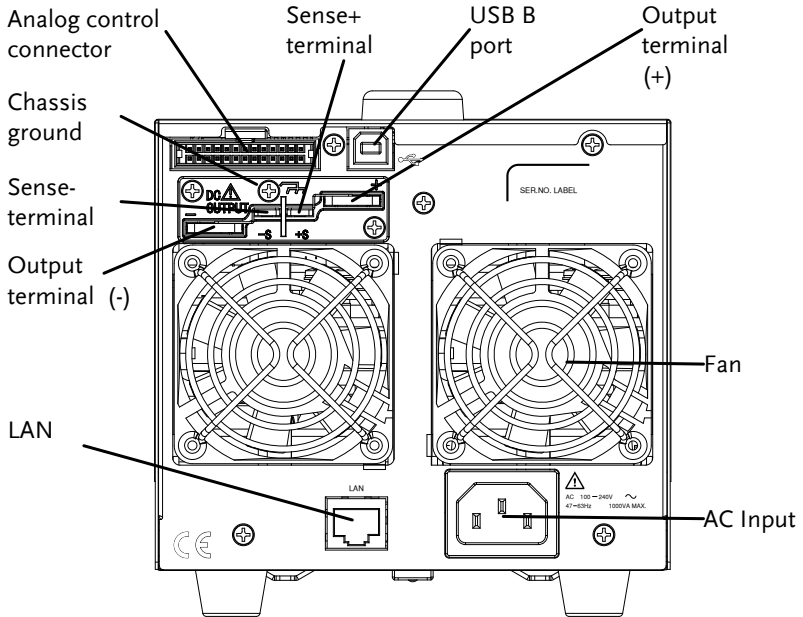

2260B-30-108, 80-40 (1080W)

2260B-30-36, 80-13 (360W)

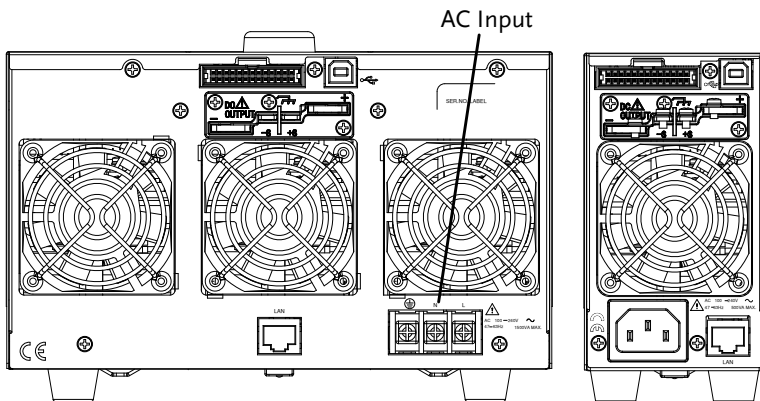

2260B-250-9, 800-2 (720W)

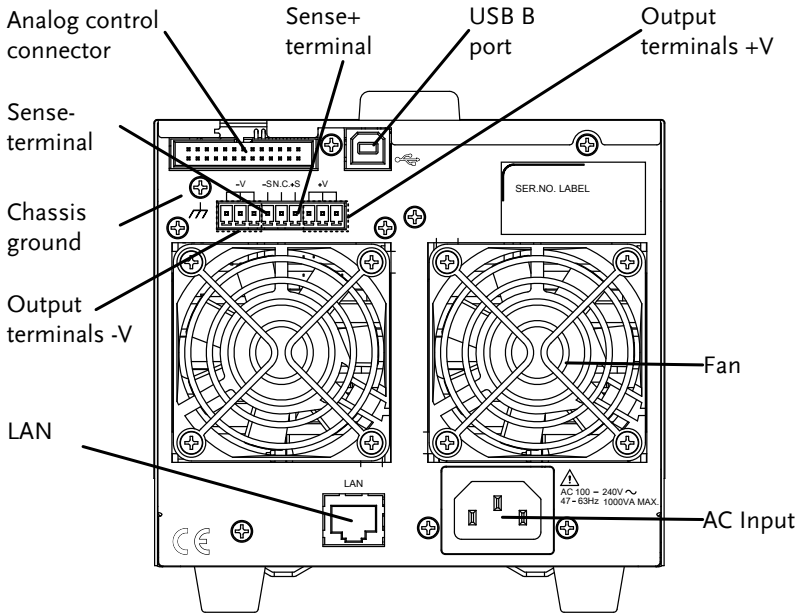

2260B-250-13, 800-4 (1080W)

2260B-250-4, 800-1 (360W)

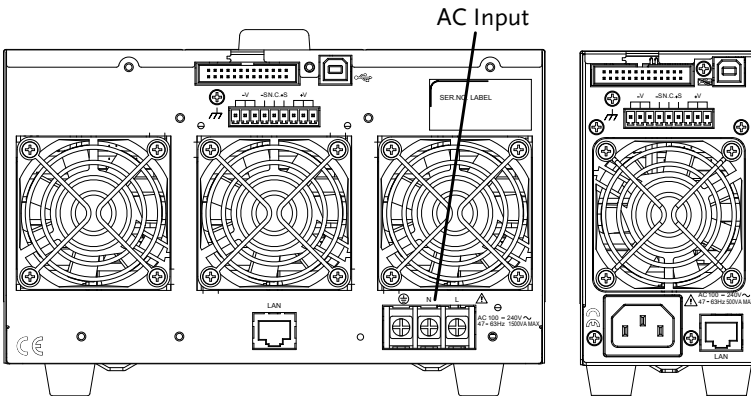

Analog Control Connector



Standard 26 pin MIL connector (OMRON XG4 IDC plug).

The analog control connector is used to monitor current and voltage output, machine status (OVP, OCP, OTP etc.), and for analog control of the current and voltage output.

Use an OMRON XG5 IDC socket as the mating socket.

Output Terminals (30, 80 volt models)

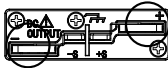

Positive (+) and negative (-) output terminals.



Chassis ground

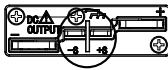

Sense (-S) and Sense (+S) terminals.

Output Terminals (250, 800 volt models)

The 250 and 800 volt models use a 9 pin connector and a plug for the output and sense terminal connections. The plug is a MC420-38109Z plug by DECA SwitchLab Inc. This plug is also available separately.

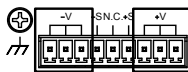

Positive (V+) and negative (V-) output terminals (3 of each).

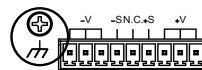

Chassis ground

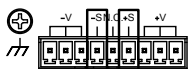

Sense (-S) and Sense (+S) terminals.

USB B port

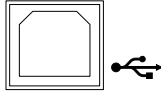

The USB B port is used for remote control.

Fans

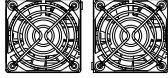

Temperature controlled fans

Ethernet Port

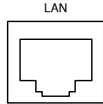

The Ethernet port is used for remote control and digital monitoring from a PC.

Line Voltage Input

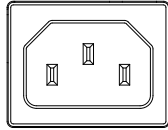

360W models:
2260B-30-36/80-13/250-4/ 800-1
720W models:
2260B-30-72/80-27/250-9/ 800-2

- Voltage Input: 100~240 VAC
- Line frequency: 50Hz/60 Hz (Automatically switchable)
- AC Input voltage range: 85VAC~265VAC
- Frequency: 47Hz~63Hz

Line Voltage Input

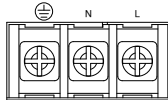

1080W models:
2260B-30-108/80-40/250-13/800-4

- Voltage Input: 100~240 VAC
- Line frequency: 50Hz/60 Hz (Automatically switchable)

Configuration Settings

Setting Configuration Settings

Background The normal configuration settings (F-01~F-61, F-88, F-89) are used to configure or view system settings. Use the following operation steps when configuring the interface settings used in the Remote Control chapter on page 23.

- Ensure the load is not connected.
- Ensure the output is off.



Note

Configuration settings F-90~F-95 cannot be edited in the Normal Function Settings. See the user manual for details.

The F-89 settings can only be viewed, not set.

Steps

1. Press the Function key. The function key will light up.

Function



2. The display will show F-01 on the top and the configuration setting for F-01 on the bottom.



3. Rotate the Voltage knob to change the F setting.

Range F-00~ F-61, F-88, F-89

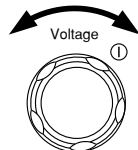

4. Use the Current knob to set the parameter for the chosen F setting.



5. Press the Voltage knob to save the configuration setting. Conf will be displayed when successful.

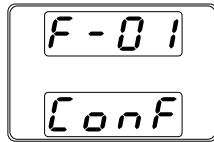
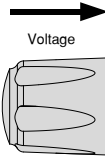

Exit

Press the Function key again to exit the configuration settings. The function key light will turn off.

Function



Configuration Table

Please use the configuration settings listed below when applying the configuration settings.

Normal Function Settings	Setting	Setting Range
Output ON delay time	F-01	0.00s~99.99s
Output OFF delay time	F-02	0.00s~99.99s
V-I mode slew rate select	F-03	0 = CV high speed priority 1 = CC high speed priority 2 = CV slew rate priority 3 = CC slew rate priority
Rising voltage slew rate	F-04	0.01V/s~60.00V/s (2260B-30-XX) 0.1V/s~160.0V/s (2260B-80-XX) 0.1V/s~500.0V/s (2260B-250-XX) 1V/s~1600V/s (2260B-800-XX)
Falling voltage slew rate	F-05	0.01V/s~60.00V/s (2260B-30-XX) 0.1V/s~160.0V/s (2260B-80-XX) 0.1V/s~500.0V/s (2260B-250-XX) 1V/s~1600V/s (2260B-800-XX)

Rising current slew rate	F-06	0.01A/s~72.00A/s (2260B-30-36)
		0.1A/s~144.0A/s (2260B-30-72)
		0.1A/s~216.0A/s (2260B-30-108)
		0.01A/s~27.00A/s (2260B-80-13)
		0.01A/s~54.00A/s (2260B-80-27)
		0.01A/s~81.00A/s (2260B-80-40)
		0.001A/s~9.000A/s (2260B-250-4)
		0.01A/s~18.00A/s (2260B-250-9)
		0.01A/s~27.00A/s (2260B-250-13)
		0.001A/s~2.880A/s (2260B-800-1)
		0.001A/s~5.760A/s (2260B-800-2)
0.001A/s~8.640A/s (2260B-800-4)		
Falling current slew rate	F-07	0.01A/s~72.00A/s (2260B-30-36)
		0.1A/s~144.0A/s (2260B-30-72)
		0.1A/s~216.0A/s (2260B-30-108)
		0.01A/s~27.00A/s (2260B-80-13)
		0.01A/s~54.00A/s (2260B-80-27)
		0.01A/s~81.00A/s (2260B-80-40)
		0.001A/s~9.000A/s (2260B-250-4)
		0.01A/s~18.00A/s (2260B-250-9)
		0.01A/s~27.00A/s (2260B-250-13)
		0.001A/s~2.880A/s (2260B-800-1)
		0.001A/s~5.760A/s (2260B-800-2)
0.001A/s~8.640A/s (2260B-800-4)		
Internal resistance setting	F-08	0.000Ω~0.833Ω (2260B-30-36)
		0.000Ω~0.417Ω (2260B-30-72)
		0.000Ω~0.278Ω (2260B-30-108)
		0.000Ω~5.926Ω (2260B-80-13)
		0.000Ω~2.963Ω (2260B-80-27)
		0.000Ω~1.975Ω (2260B-80-40)
		0.00Ω~55.55Ω (2260B-250-4)
		0.00Ω~27.77Ω (2260B-250-9)
		0.00Ω~18.51Ω (2260B-250-13)
		0.0Ω~555.5Ω (2260B-800-1)
		0.0Ω~277.8Ω (2260B-800-2)
0.0Ω~185.1Ω (2260B-800-4)		
Bleeder circuit control	F-09	0 = OFF, 1 = ON, 2 = AUTO
Buzzer ON/OFF control	F-10	0 = OFF, 1 = ON
Measurement Average Setting	F-17	0 = Low, 1 = Middle, 2 = High

Lock Mode	F-19	0 = Panel lock: allow output off 1 = Panel lock: allow output on/off
USB/GPIB settings		
Front panel USB State	F-20	0 = Absent, 1 = Mass Storage
Rear panel USB State	F-21	0 = Absent, 2 = USB-CDC, 3 = GPIB-USB adapter
Rear panel USB mode	F-22	0 = Disable, 1 = GPIB-USB adapter, 2 = USB CDC, Auto Detect Speed, 3 = USB CDC, Full Speed Only
GPIB address	F-23	0~30
LAN settings		
MAC Address-1	F-30	0x00~0xFF
MAC Address-2	F-31	0x00~0xFF
MAC Address-3	F-32	0x00~0xFF
MAC Address-4	F-33	0x00~0xFF
MAC Address-5	F-34	0x00~0xFF
MAC Address-6	F-35	0x00~0xFF
LAN	F-36	0 = Disable, 1 = Enable
DHCP	F-37	0 = Disable, 1 = Enable
IP Address-1	F-39	0~255
IP Address-2	F-40	0~255
IP Address-3	F-41	0~255
IP Address-4	F-42	0~255
Subnet Mask-1	F-43	0~255
Subnet Mask-2	F-44	0~255
Subnet Mask-3	F-45	0~255
Subnet Mask-4	F-46	0~255
Gateway-1	F-47	0~255
Gateway-2	F-48	0~255
Gateway-3	F-49	0~255
Gateway-4	F-50	0~255
DNS address -1	F-51	0~255
DNS address -2	F-52	0~255
DNS address-3	F-53	0~255
DNS address-4	F-54	0~255
Sockets active	F-57	0 = Disable, 1 = Enable
Web Server active	F-59	0 = Disable, 1 = Enable
Web password active	F-60	0 = Disable, 1 = Enable
Web setting password	F-61	0000~9999

System Settings		
Factory Set Value	F-88	0 = Disable 1 = Return to factory settings
Show Version	F-89	0, 1 = 2260B version 2, 3 = 2260B build year 4, 5 = 2260B build month/day 6, 7 = Keyboard CPLD version 8, 9 = Analog-Control CPLD version A, B = Reserved C, D = Kernel build year E, F = Kernel build month/day
Power On Configuration Settings*		
CV Control	F-90	0 = Panel control (local) 1 = External voltage control 2 = External resistance control (Ext-R $\searrow 10k\Omega = V_o, \max$) 3 = External resistance control (Ext-R $\triangle 10k\Omega = 0$)
CC Control	F-91	0 = Panel control (local) 1 = External voltage control 2 = External resistance control (Ext-R $\searrow 10k\Omega = I_o, \max$) 3 = External resistance control (Ext-R $\triangle 10k\Omega = 0$)
Power-ON Output	F-92	0 = OFF at startup 1 = ON at startup T001 ~ T010 = Run Test Sequence TXX at start up
Master/Slave	F-93	0 = Master/Local 1 = Master/Parallel1 2 = Master/Parallel2 3 = Slave/Parallel 4 = Slave/Series (Only 30V, 80V models)
External Out Logic	F-94	0 = High ON, 1 = Low ON
Power Switch trip	F-95	0 = Enable , 1 = Disable
Calibration Settings*		
Calibration	F-00	0000 ~ 9999



*Note

Power On and Calibration settings can only be set during power up.

REMOTE CONTROL

This chapter describes basic configuration of IEEE488.2 based remote control.

Interface Configuration	24
USB Remote Interface	24
Configure GPIB Interface.....	24
Configure Ethernet Connection.....	26
Web Server Configuration.....	26
Sockets Server Configuration	27
USB Function Check.....	28
Web Server Remote Control Function Check.....	31
Socket Server Function Check	31
Socket Server Examples.....	37
Visual Basic Example	37
C++ Example.....	38
LabVIEW Example.....	40
Command Syntax	41
Command List.....	45
Status Register Overview	87
Introduction to the Status Registers	87
The Status Registers	88
Questionable Status Register Group	89
Operation Status Register Group.....	91
Standard Event Status Register Group	93
Status Byte Register & Service Request Enable Register	95
Error List.....	97
Command Errors	97
Execution Errors.....	101
Device Specific Errors	103
Query Errors.....	104

Interface Configuration

USB Remote Interface

USB configuration	PC side connector	Type A, host
	2260B side connector	Rear panel Type B, slave
	Speed	1.1/2.0 (full speed/high speed)
	USB Class	CDC (communications device class)

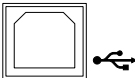
- Panel operation
1. Connect the USB cable to the rear panel USB B port. 
 2. Press the Function key to enter the Page 7 Normal configuration settings.
 3. Set the following USB settings:

F-22 = 2	Set the rear panel USB port to USB-CDC.
----------	---

Configure GPIB Interface

To use GPIB, the optional GPIB to USB adapter (2260B-GPIB-USB) must be used. The GPIB to USB adapter must be connected before the 2260B is turned on. Only one GPIB address can be used at a time.

- Configure GPIB
1. Ensure the 2260B is off before proceeding.
 2. Connect the USB cable from the rear panel USB B port on the 2260B to the USB A port on the GPIB to USB adapter.

3. Connect a GPIB cable from a GPIB controller to the GPIB port on the adapter.

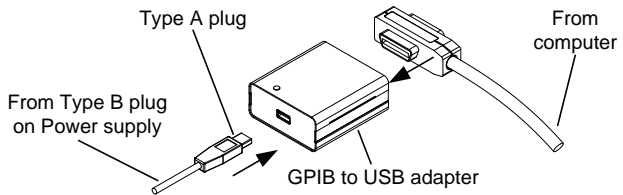

4. Turn the 2260B on.
5. Press the Function key to enter the Page 7 Normal configuration settings.

Set the following GPIB settings:

F-22 = 1

Set the rear panel USB port to
GPIB-USB

F-23 = 0~30

Set the GPIB address (0~30)

- GPIB constraints
- Maximum 15 devices altogether, 20m cable length, 2m between each device
 - Unique address assigned to each device
 - At least 2/3 of the devices turned On
 - No loop or parallel connection

Configure Ethernet Connection

The Ethernet interface can be configured for a number of different applications. Ethernet can be configured for basic remote control or monitoring using a web server or it can be configured as a socket server.

The 2260B series supports DHCP connections so the instrument can be automatically connected to an existing network or alternatively, network settings can be manually configured.

Ethernet configuration Parameters	MAC Address (display only)	LAN
	DHCP	IP Address
	Subnet Mask	Gateway
	DNS Address	Sockets Active
	Web Server Active	Web Password Active
	Web set password	0000~9999 (default 0000)

Web Server Configuration

Configuration This configuration example will configure the 2260B as a web server and use DHCP to automatically assign an IP address to the 2260B.

- Steps**
1. Connect an Ethernet cable from the network to the rear panel Ethernet port.

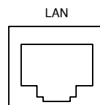

2. Press the Function key to enter the Page 7 Normal configuration settings.

Set the following LAN settings:

F-36 = 1	Enable LAN
F-37 = 1	Turn DHCP to enable
F-59 = 1	Turn the web server on



Note

It may be necessary to cycle the power or refresh the web browser to connect to a network.

Sockets Server Configuration

Configuration This configuration example will configure the 2260B for web sockets control.

The following configuration settings will manually assign the 2260B an IP address and enable web sockets. By default, the socket port number is 2268 and cannot be configured.

Steps

1. Connect an Ethernet cable from the network to the rear panel Ethernet port.

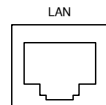

2. Press the Function key to enter the Page 7 Normal configuration settings.
3. Set the following LAN settings:

F-36 = 1	Enable LAN
F-37 = 0	Disable DHCP
F-39 = 172	IP Address part 1 of 4
F-40 = 16	IP Address part 2 of 4
F-41 = 5	IP Address part 3 of 4
F-42 = 133	IP Address part 4 of 4
F-43 = 255	Subnet Mask part 1 of 4
F-44 = 255	Subnet Mask part 2 of 4

F-45 = 128	Subnet Mask part 3 of 4
F-46 = 0	Subnet Mask part 4 of 4
F-43 = 172	Gateway part 1 of 4
F-44 = 16	Gateway part 2 of 4
F-45 = 21	Gateway part 3 of 4
F-46 = 101	Gateway part 4 of 4
F-57 = 1	Enable Sockets



Note

The socket function is only available for firmware version V1.12 or above. See the user manual to check your firmware version number.

USB Function Check

Background To test the USB functionality, National Instruments Measurement and Automation Explorer can be used. This program is available on the NI website, www.ni.com, via a search for the VISA Run-time Engine page, or “downloads” at the following URL, <http://www.ni.com/visa/>

Requirements Firmware: V1.12 or above
Operating System: Windows XP, 7



Note

The 2260B will appear as a COM port on the PC.

To check the COM port No, see the Device Manager in the PC. For Win 7; Control panel → Hardware and Sound → Device Manager.

Functionality check

1. Start the NI Measurement and Automation Explorer (MAX) program. Using Windows, press:

Start>All Programs>National Instruments>Measurement & Automation



2. From the Configuration panel access;

My System > Devices and Interfaces

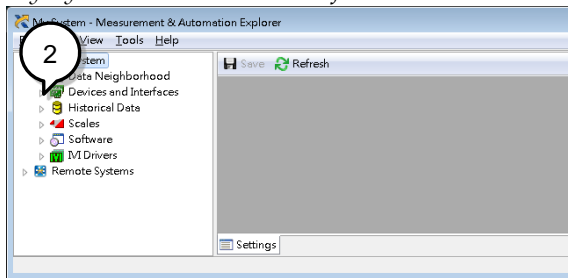

3. Select "COM7".

4. Press Open VISA Test Panel.

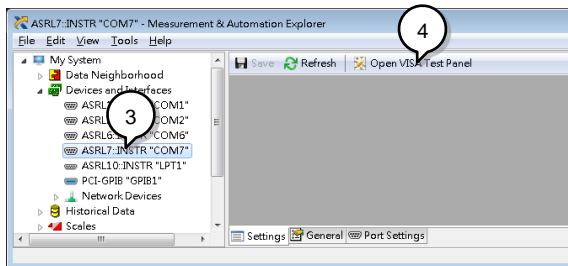

Note

The displayed COM port No. may differ with the

picture shown here. It depends on the virtual COM port number in your system. Here "COM7" is the Virtual COM port assigned to the 2260B.

5. Click the *Configuration* icon.
6. In the *I/O Settings* tab, select the *Enable Termination Character* check box. Ensure *Line Feed - \n* is selected as the line feed character.
7. Click *Apply Changes*.

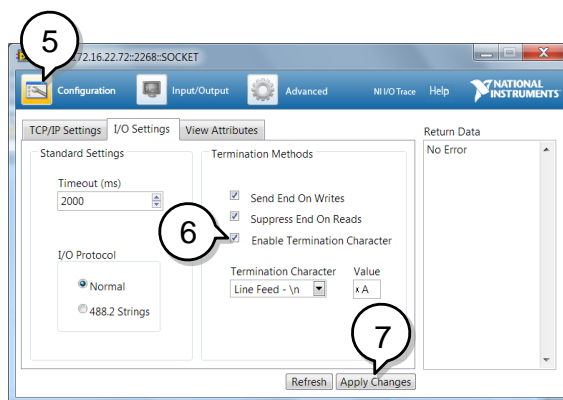

8. Click the *Input/Output* icon.
9. Ensure **IDN?\n* is selected in the *Select or Enter Command* dropdown text box.
10. Click the *Query* button.
11. The **IDN?* query should be returned to the buffer area:

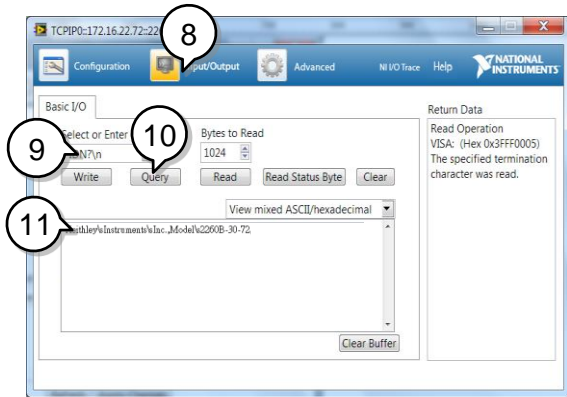

Web Server Remote Control Function Check

Functionality check

Enter the IP address of the power supply in a web browser after the instrument has been configured as a web server

http:// XXX.XXX.XXX.XXX

The web browser interface appears.

Socket Server Function Check

Background

To test the socket server functionality, National Instruments Measurement and Automation Explorer can be used. This program is available on the NI website, www.ni.com, via a search for the VISA Run-time Engine page, or “downloads” at the following URL, <http://www.ni.com/visa/>

Requirements Firmware: V1.12 or above
Operating System: Windows XP, 7

Functionality check 1. Start the NI Measurement and Automation Explorer (MAX) program. Using Windows, press:

Start>All Programs>National Instruments>Measurement & Automation



2. From the Configuration panel access;

My System>Devices and Interfaces>Network Devices

3. Click *Create New...*

4. Select *Visa TCP/IP Resource*.

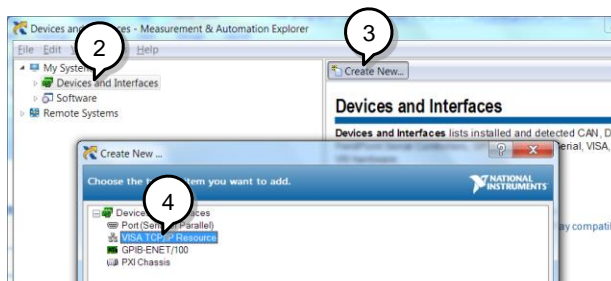

5. Select *Manual Entry of Raw Socket* from the popup window.
6. Click *Next*.

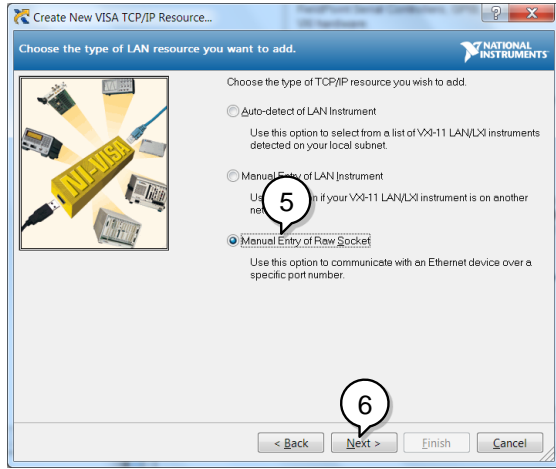

7. Enter the IP address and the port number of the 2260B. The port number is fixed at 2268.
8. Click the Validate button. A popup box will appear when successful.
9. Click *Next*.

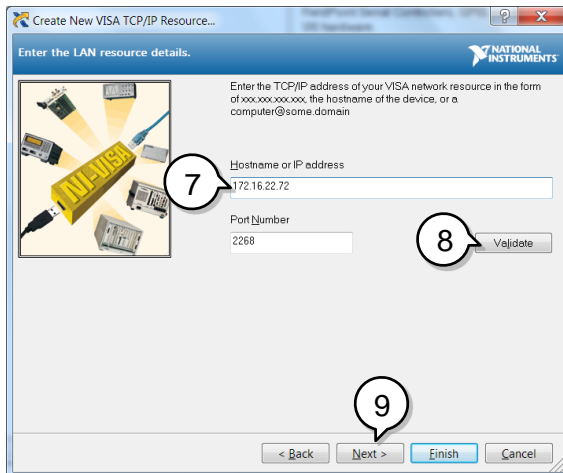

10. Next configure the Alias (name) of the 2260B connection. In this example the Alias is: PS_DC1

11. Click finish.

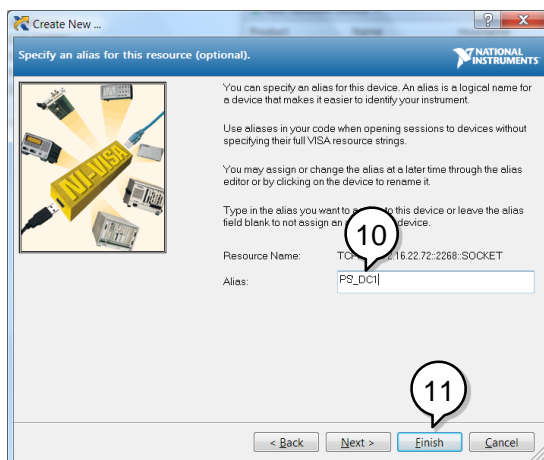

12. The IP address of the 2260B will now appear under Network Devices in the configuration panel. Select this icon now.

13. Press *Open VISA Test Panel*.

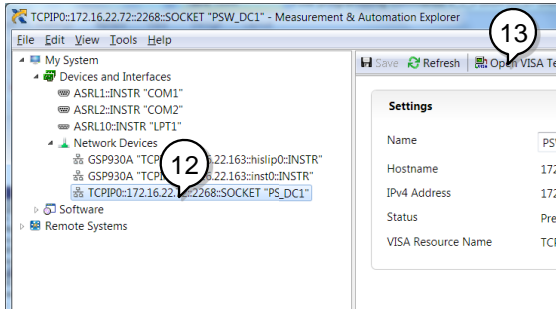

14. Click *Configuration* icon.

15. In the *I/O Settings* tab, select the *Enable Termination Character* check box. Ensure *Line Feed - \n* is selected as the line feed character.

16. Click *Apply Changes*.

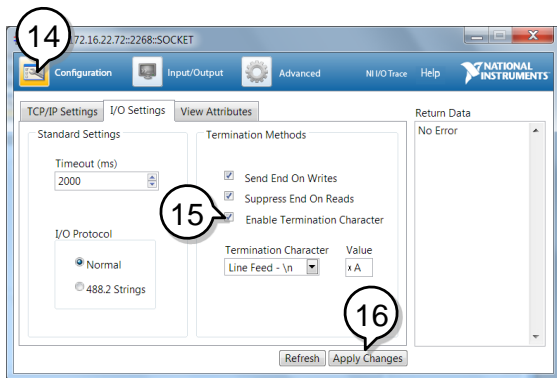

17. Click the *Input/Output* icon.
18. Ensure **IDN?\n* is selected in the *Select or Enter Command* dropdown text box.
19. Click the *Query* button.
20. The **IDN?* query should be returned to the buffer area.

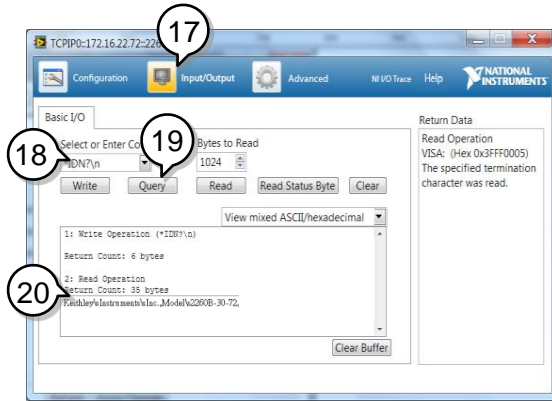

Socket Server Examples

Visual Basic Example

Background The following visual basic programming example uses the VISA COM 3.0 Type Library. The example will connect to the 2260B using the IP address of 172.15.5.133 over port 2268. The program will send the *IDN? query to the 2260B, print the return string and then close the connection.

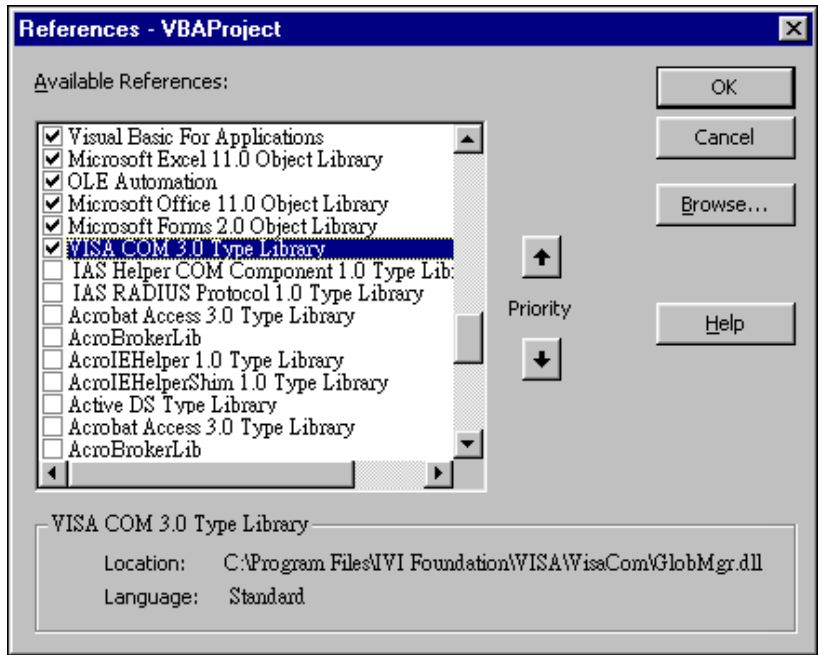

```
'Create VISA ResourceManager object
Dim rm As New VisaComLib.ResourceManager
Dim accessMode As VisaComLib.accessMode
Dim serial As String
Dim timeOut As Integer
Dim optionString As String
Dim 2260B As VisaComLib.IMessage
Dim 2260Bcom As VisaComLib.FormattedIO488
Dim 2260Bsfc As VisaComLib.IAsyncMessage
```

```
Private Sub CommandButton1_Click()
    accessMode = VisaComLib.accessMode.NO_LOCK

    timeOut = 0

    optionString = ""

    'Connect to the 2260B

    Set 2260B = rm.Open("TCPIP0::172.16.5.133::2268::SOCKET", _
        accessMode, _
        timeOut, _
        optionString)
    Set 2260Bsfc = 2260B
    2260Bsfc.TerminationCharacterEnabled = True

    'Query the System Identify Name
    2260B.WriteString ("*IDN?" & vbCrLf)

    Worksheets("Sheet1").Cells(1, 5) = 2260B.ReadString(256)

    'Close the communication
    2260B.Close
```

```
End Sub
```

C++ Example

Background The following program creates a connection to the 2260B and sets the voltage to 3.3 volts and the current 1.5 amps. The voltage and current reading is then read back and the connection is closed.



Note

Add visa32.lib to the project library when building the following sample program.

```
#include "stdio.h"
#include "string.h"
#include "visatype.h"
#include "visa.h"
#define IPAddr "172.16.20.181"
int main(int argc, char* argv[])
{
    ViSession defaultRm, instr;
    // Create VISA ResourceManager object
    ViStatus status = viOpenDefaultRM(&defaultRm);
    if (status < VI_SUCCESS)
    {
        // Initialization error
        return -1;
    }
    ViChar rsc[256];
    sprintf(rsc, "TCPiP0::%s::2268::SOCKET", IPAddr);
    ViAccessMode accessMode = VI_NO_LOCK;
    ViUInt32 timeout = 0;
    // Connect the device
    viOpen(defaultRm, rsc, accessMode, timeout, &instr);
    /* Set the timeout for message-based communication */
    status = viSetAttribute(instr, VI_ATTR_TMO_VALUE, 5000);
    status = viSetAttribute(instr, VI_ATTR_TERMCHAR, 10);
    status = viSetAttribute(instr, VI_ATTR_TERMCHAR_EN, VI_TRUE);
    ViUInt32 count;
    // Set the Voltage to 3.3, Current to 1.5
    ViBuf buf = (ViBuf)":volt 3.3::curr 1.5\n";
    viWrite(instr, buf, (ViUInt32)strlen((ViPChar)buf), &count);

    // Query the Voltage, and Current
    buf = (ViBuf)":apply?\n";
    status = viWrite(instr, buf, (ViUInt32)strlen((ViPChar)buf), &count);
    ViChar result[257];
    status = viRead(instr, (ViPBuf)result, 256, &count);
    if (status=VI_SUCCESS_TERM_CHAR)
    {
        result[count] = 0;
        printf("Voltage(V), Current(A)= %s\n", result);
    }else
        printf("Error\n");

    // Close the device
    viClose(instr);
    viClose(defaultRm);

    return 0;
}
```

LabVIEW Example

Background

The following picture shows a LabView programming example for the 2260B.

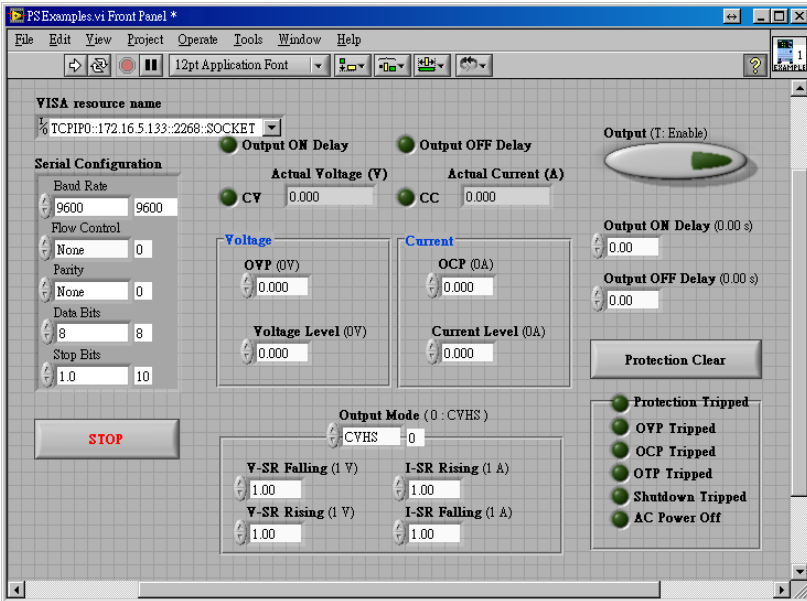

Command Syntax

Compatible Standard	IEEE488.2	Partial compatibility
	SCPI, 1999	Partial compatibility

Command Structure

SCPI commands follow a tree-like structure, organized into nodes. Each level of the command tree is a node. Each keyword in a SCPI command represents each node in the command tree. Each keyword (node) of a SCPI command is separated by a colon (:).

For example, the diagram below shows an SCPI sub-structure and a command example.

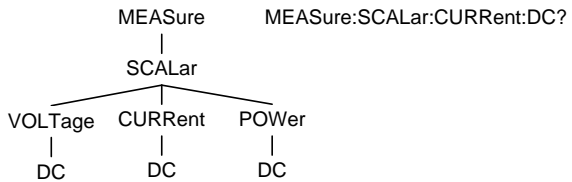

Command types

There are a number of different instrument commands and queries. A command sends instructions or data to the unit and a query receives data or status information from the unit.

Command types

Simple	A single command with/without a parameter
Example	*IDN?

Query	A query is a simple or compound command followed by a question mark (?). A parameter (data) is returned.
-------	--

Example	meas:curr:dc?
---------	---------------

Compound	Two or more commands on the same command line. Compound commands are separated with either a semi-colon (;) or a semi-colon and a colon (;:).
----------	---

A semi-colon is used to join two related commands, with the caveat that the last command must begin at the last node of the first command.

A semi-colon and colon are used to combine two commands from different nodes.

Example	meas:volt:dc?::meas:curr:dc?
---------	------------------------------

Command Forms Commands and queries have two different forms, long and short. The command syntax is written with the short form of the command in capitals and the remainder (long form) in lower case.

The commands can be written in capitals or lower-case, just so long as the short or long forms are complete. An incomplete command will not be recognized.

Below are examples of correctly written commands.

Long form	STATus:OPERation:NTRansition? STATUS:OPERATION:NTRANSITION? status:operation:ntransition?
Short form	STAT:OPER:NTR? stat:oper:ntr?

Square Brackets Commands that contain square brackets indicate that the contents are optional. The function of the command is the same with or without the square bracketed items, as shown below.

Both "DISPlay:MENU[:NAME]?" and "DISPlay:MENU?" are both valid forms.

Command Format

APPLY 1.5,5.2

1. Command header
2. Space
3. Parameter 1
4. Comma (no space before/after comma)
5. Parameter 2

Parameters	Type	Description	Example
	<Boolean>	Boolean logic	0, 1

<NR1>	integers	0, 1, 2, 3
<NR2>	decimal numbers	0.1, 3.14, 8.5
<NR3>	floating point	4.5e-1, 8.25e+1
<NRf>	any of NR1, 2, 3	1, 1.5, 4.5e-1
<string>	String parameters are any ASCII characters (ASCII: 20H to 7EH) that are enclosed in either single or double quotes. For example: 'STRING' or "STRING".	
<block data>	Definitive length arbitrary block data. A single decimal digit followed by data. The decimal digit specifies how many 8-bit data bytes follow.	

Message
Terminator

LF

Line feed code

Command List

Abort Commands	ABORt	48
Apply Commands	APPLY	48
Display Commands	DISPlay:MENU[:NAME]	49
	DISPlay[:WINDow]:TEXT:CLEAr	50
	DISPlay[:WINDow]:TEXT[:DATA]	50
	DISPlay:BLINK	51
Initiate Commands	INITiate[:IMMediate]:NAME	51
Measure Commands	MEASure[:SCALar]:CURRent[:DC]	52
	MEASure[:SCALar]:VOLTage[:DC]	52
	MEASure[:SCALar]:POWer[:DC]	52
Output Commands	OUTPut:DELAy:ON	53
	OUTPut:DELAy:OFF	53
	OUTPut:MODE	54
	OUTPut[:STATe][:IMMediate]	54
	OUTPut[:STATe]:TRIGgered	54
	OUTPut:PROTection:CLEAr	55
	OUTPut:PROTection:TRIPped	55
Sense Commands	SENSe:AVERAge:COUNT	56
Status Commands	STATus:OPERation[:EVENT]	57
	STATus:OPERation:CONDition	57
	STATus:OPERation:ENABle	57
	STATus:OPERation:PTRansition	58
	STATus:OPERation:NTRansition	58
	STATus:QUEStionable[:EVENT]	58
	STATus:QUEStionable:CONDition	59
	STATus:QUEStionable:ENABle	59
	STATus:QUEStionable:PTRansition	59
	STATus:QUEStionable:NTRansition	59
	STATus:PRESet	60

Source Commands	[SOURce:]CURRent[:LEVel][:IMMediate][:AMPLitude] 61
	[SOURce:]CURRent[:LEVel]:TRIGgered[:AMPLitude] .62
	[SOURce:]CURRent:PROTection[:LEVel]62
	[SOURce:]CURRent:PROTection:STATe63
	[SOURce:]CURRent:SLEW:RISing63
	[SOURce:]CURRent:SLEW:FALLing64
	[SOURce:]RESistance[:LEVel][:IMMediate][:AMPLitude]64
	[SOURce:]VOLTagE[:LEVel][:IMMediate][:AMPLitude]65
	[SOURce:]VOLTagE[:LEVel]:TRIGgered[:AMPLitude] .65
	[SOURce:]VOLTagE:PROTection[:LEVel]66
	[SOURce:]VOLTagE:SLEW:RISing66
	[SOURce:]VOLTagE:SLEW:FALLing67
Trigger Commands	TRIGger:TRANsient[:IMMediate]68
	TRIGger:TRANsient:SOURce68
	TRIGger:OUTPut[:IMMediate]69
	TRIGger:OUTPut:SOURce69
System Commands	SYSTem:CONFigure:BEEPer[:STATe]71
	SYSTem:CONFigure:BLEDer[:STATe]72
	SYSTem:CONFigure:BTRip[:IMMediate]72
	SYSTem:CONFigure:BTRip:PROTection72
	SYSTem:CONFigure:CURRent:CONTRol73
	SYSTem:CONFigure:VOLTagE:CONTRol73
	SYSTem:CONFigure:MSLave74
	SYSTem:CONFigure:OUTPut:EXTernal[:MODE]74
	SYSTem:CONFigure:OUTPut:PON[:STATe]75
	SYSTem:COMMunicate:ENABle75
	SYSTem:COMMunicate:GPIB[:SELF]:ADDReSS76
	SYSTem:COMMunicate:LAN:IPADdress77
	SYSTem:COMMunicate:LAN:GATEWay77
	SYSTem:COMMunicate:LAN:SMASk77
	SYSTem:COMMunicate:LAN:MAC78
	SYSTem:COMMunicate:LAN:DHCP78
	SYSTem:COMMunicate:LAN:DNS78
	SYSTem:COMMunicate:LAN:HOSTname79
	SYSTem:COMMunicate:LAN:WEB:PACTive79
	SYSTem:COMMunicate:LAN:WEB:PASSword79
	SYSTem:COMMunicate:USB:FRONt:STATe80
	SYSTem:COMMunicate:USB:REAR:STATe80
	SYSTem:ERRor80

	SYSTem:KEYLock:MODE	80
	SYSTem:KLOCK	81
	SYSTem:INFormation.....	81
	SYSTem:PRESet	82
	SYSTem:VERSion	82
Common	*CLS	83
Commands	*ESE.....	83
	*ESR.....	84
	*IDN	84
	*OPC.....	84
	*RST	85
	*SRE.....	85
	*STB	85
	*TRG.....	86
	*TST	86
	*WAI	86

Abort Commands

ABORt48

ABORt



Description The ABORt command will cancel any triggered actions.

Syntax ABORt

APPLY Commands

APPLY48

APPLY

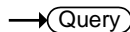
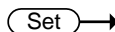

Description The APPLY command is used to set both the voltage and current. The voltage and current will be output as soon as the function is executed if the programmed values are within the accepted range. An execution error will occur if the programmed values are not within accepted ranges.

The Apply command will set the voltage/current values but these values will not be reflected on the display until the Output is On or if the DISPlay:MENU:NAME 3 (set menu) command is used.

Syntax APPLY {<voltage>|MIN|MAX},{<current>|MIN|MAX}]

Query Syntax APPLY?

Parameter	<voltage>	<NRf> 0% ~ 105% of the rated output voltage.
	<current>	<NRf> 0% ~ 105% of the rated output current.
	MIN	0 volts/0 amps
	MAX	Maxium value for the present range.
Return parameter	<NRf>	Returns the voltage and current.
Example	APPL 5.05,1.1	Sets the voltage and current to 5.05V and 1.1A.
Query Example	APPL?	+5.050, +1.100
		Returns voltage (5.05V) and current (1.1A) setting.

Display Commands

DISPlay:MENU[:NAME]49
DISPlay[:WINDow]:TEXT:CLEar50
DISPlay[:WINDow]:TEXT[:DATA]50
DISPlay:BLINK51

DISPlay:MENU[:NAME]

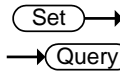

Description	The DISPlay MENU command selects a screen menu or queries the current screen menu.	
Syntax	DISPlay:MENU[:NAME] <NR1>	
Query Sytax	DISPlay:MENU[:NAME]?	
Parameter/ Return parameter	<NR1>	Description
	0	Measurement-Voltage / Measurement-Current
	1	Measurement-Voltage / Measurement-Power
	2	Measurement-Power / Measurement-Current
	3	Set Menu
	4	OVP / OCP Menu
	5~99	Not Used.
	100~199	F-00~99 Menu.

Example	DISP:MENU:NAME 0 Sets the display to the Voltage/Current display screen.
---------	---

DISPlay[:WINDow]:TEXT:CLear	
-----------------------------	---

Description	Clears the text on the main screen from the DISPlay[:WINDow]:TEXT[:DATA] command .
-------------	--

Syntax	DISPlay[:WINDow]:TEXT:CLear
--------	-----------------------------

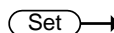

DISPlay[:WINDow]:TEXT[:DATA]	
------------------------------	---

Description	Sets or queries the data text that will be written to the display. Writing to the display will overwrite data that is currently on the screen. Overwriting a display area with a shorter string may or may not overwrite the screen. The string must be enclosed in either single or double quotes: 'STRING' or "STRING". Only ASCII characters 20H to 7EH can be used in the <string>. A null string, "", can also be used. This is the equivalent of using the DISPlay[:WINDow]:TEXT:CLear function.
-------------	--

Syntax	DISPlay[:WINDow]:TEXT[:DATA] <string>
--------	---------------------------------------

Query Syntax	DISPlay[:WINDow]:TEXT[:DATA]?
--------------	-------------------------------

Parameter/ Return parameter	<string> ASCII characters 20H to 7EH or a null string, "", can be used in the string parameter.
--------------------------------	---

Example	DISP:WIND:TEXT:DATA 'STRING' Writes STRING to the display.
---------	---

Query Example	DISP:WIND:TEXT:DATA? STRING Returns the text data string on the screen.
---------------	---

DISPlay:BLINK

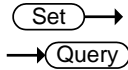

Description	Turns blink on or off for the display.	
Syntax	DISPlay:BLINK { 0 1 OFF ON }	
Query Syntax	DISPlay:BLINK?	
Parameter	0	<NR1>Turns blink OFF
	OFF	Turns blink OFF
	1	<NR1> Turns blink ON
	ON	Turns blink ON
Return parameter	0	<NR1>Turns blink OFF
	1	<NR1>Turns blink ON
Example	DISP:BLIN 1 Turns blink ON.	

Initiate Commands

INITiate[:IMMediate]:NAME51

INITiate[:IMMediate]:NAME



Description	The INITiate command starts the TRANsient or OUTPut trigger.	
Syntax	INITiate[:IMMediate]:NAME {TRANsient OUTPut}	
Parameter	TRANsient	Starts the TRANsient trigger.
	OUTPut	Starts the OUTPut trigger.
Example	INITiate:NAME TRANient Starts the TRANsient trigger.	

Measure Commands

MEASure[:SCALar]:CURRent[:DC]	52
MEASure[:SCALar]:VOLTage[:DC]	52
MEASure[:SCALar]:POWer[:DC]	52

MEASure[:SCALar]:CURRent[:DC]

Description Takes a measurement and returns the average output current

Syntax MEASure[:SCALar]:CURRent[:DC]?

Return parameter <NRf> Returns the current in amps.

MEASure[:SCALar]:VOLTage[:DC]

Description Takes a measurement and returns the average output voltage.

Syntax MEASure[:SCALar]:VOLTage[:DC]?

Return <NRf> Returns the voltage in volts.

MEASure[:SCALar]:POWer[:DC]

Description Takes a measurement and returns the average output power.

Syntax MEASure[:SCALar]:POWer[:DC]?

Return <NRf> Returns the power measured in watts.

Output Commands

OUTPut:DElay:ON.....	53
OUTPut:DElay:OFF.....	53
OUTPut:MODE.....	54
OUTPut[:STATe][:IMMediate].....	54
OUTPut[:STATe]:TRIGgered.....	54
OUTPut:PROTection:CLEar.....	55
OUTPut:PROTection:TRIPped.....	55

Set →

→ Query

OUTPut:DElay:ON

Description	Sets the Delay Time in seconds for turning the output on. The delay is set to 0.000 by default.
Syntax	OUTPut:DElay:ON <Nrf>
Query Syntax	OUTPut:DElay:ON?
Parameter	<Nrf> 0.00~99.99 seconds, where 0=no delay.
Return parameter	<Nrf> Returns the delay on time in seconds until the output is turned on.

Set →

→ Query

OUTPut:DElay:OFF

Description	Sets the Delay Time in seconds for turning the output off. The delay is set to 0.000 by default.
Syntax	OUTPut:DElay:OFF <Nrf>
Return Syntax	OUTPut:DElay:OFF?
Parameter	<Nrf> 0.00~99.99 seconds, where 0=no delay.
Return parameter	<Nrf> Returns the delay off time in seconds until the output is turned off.

OUTPut:MODE

Set →

→ Query

Description	Sets the 2260B output mode. This is the equivalent to the F-03 (V-I Mode Slew Rate Select) settings.	
Syntax	OUTPut:MODE {<NR1> CVHS CCHS CVLS CCLS}	
Return Syntax	OUTPut:MODE?	
Parameter	0	CV high speed priority
	CVHS	CV high speed priority
	1	CC high speed priority
	CCHS	CC high speed priority
	2	CV slew rate priority
	CVLS	CV slew rate priority
	3	CC slew rate priority
	CCLS	CC slew rate priority
Return parameter	<NR1>	Returns the output mode.

OUTPut[:STATe][:IMMediate]

Set →

→ Query

Description	Turns the output on or off.	
Syntax	OUTPut[:STATe][:IMMediate] { OFF ON 0 1 }	
Query Syntax	OUTPut[:STATe][:IMMediate]?	
Parameter	0	<NR1> Turns the output off.
	OFF	Turns the output off.
	1	<NR1> Turns the output on.
	ON	Turns the output on.
Return parameter	<NR1>	Returns output status of the instrument.

OUTPut[:STATe]:TRIGgered

Set →

→ Query

Description	Turns the output on or off when a software trigger is generated.	
Syntax	OUTPut[:STATe]:TRIGgered { OFF ON 0 1 }	
Query Syntax	OUTPut[:STATe]:TRIGgered?	

Parameter	0	<NR1>Turns the output off when a software trigger is generated.
	OFF	Turns the output off when a software trigger is generated.
	1	<NR1>Turns the output on when a software trigger is generated.
	ON	Turns the output on when a software trigger is generated.
Return parameter	<NR1>	Returns output trigger status of the instrument.

OUTPut:PROTEction:CLEar



Description	Clears over-voltage, over-current and over-temperature (OVP, OCP, OTP) protection circuits. It also clears the shutdown protection circuit. The AC failure protection cannot be cleared.
Syntax	OUTPut:PROTEction:CLEar

OUTPut:PROTEction:TRIPped



Description	Returns the state of the protection circuits (OVP, OCP, OTP).
Query Syntax	OUTPut:PROTEction:TRIPped?
Return parameter	0 <NR1>Protection circuits are not tripped.
	1 <NR1>Protection circuits are tripped.

Sense Commands

SENSe:AVERAge:COUNT56

SENSe:AVERAge:COUNT

Set →

→ Query

Description Determines the level of smoothing for the average setting. This is the equivalent to the F-17 function setting.

Syntax SENSe:AVERAge:COUNT {<NR1> | LOW | MIDDLE | HIGH}

Query Syntax SENSe:AVERAge:COUNT?

Parameter	0 LOW	Low level of smoothing.
	1 MIDDLE	Middle level of smoothing.
	2 HIGH	High level of smoothing.

Return parameter	<NR1>	Returns the level of smoothing.
	0	Low level of smoothing.
	1	Middle level of smoothing.
	2	High level of smoothing.

Example SENSe:AVERAge:COUNT 1
Sets the level of smoothing to middle.

Status Commands

STATus:OPERation[:EVENT]	57
STATus:OPERation:CONDition	57
STATus:OPERation:ENABle	57
STATus:OPERation:PTRansition	58
STATus:OPERation:NTRansition	58
STATus:QUEStionable[:EVENT]	58
STATus:QUEStionable:CONDition	59
STATus:QUEStionable:ENABle	59
STATus:QUEStionable:PTRansition	59
STATus:QUEStionable:NTRansition	59
STATus:PRESet	60

STATus:OPERation[:EVENT] → Query

Description Queries the Operation Status Event register and clears the contents of the register.

Syntax STATus:OPERation[:EVENT]?

Return <NR1> Returns the bit sum of the Operation Status Event register.

STATus:OPERation:CONDition → Query

Description Queries the Operation Status register. This query will not clear the register.

Syntax STATus:OPERation:CONDition?

Return <NR1> Returns the bit sum of the Operation Condition register.

Set →

STATus:OPERation:ENABle → Query

Description Sets or queries the bit sum of the Operation Status Enable register.

Syntax STATus:OPERation:ENABle <NRf>

Query Syntax STATus:OPERation:ENABle?

Parameter	<NRf>	0~32767
Return parameter	<NR1>	0~32767

STATus:OPERation:PTRansition

Description Sets or queries the bit sum of the positive transition filter of the Operation Status register.

Syntax STATus:OPERation:PTRansition <NRf>
STATus:OPERation:PTRansition?

Parameter	<NRf>	0~32767
Return parameter	<NR1>	0~32767

STATus:OPERation:NTRansition

Description Sets or queries the bit sum of the negative transition filter of the Operation Status register.

Syntax STATus:OPERation:NTRansition <NRf>

Query Syntax STATus:OPERation:NTRansition?

Parameter	<NRf>	0~32767
Return parameter	<NR1>	0~32767

STATus:QUESTIONable[:EVENT]

Description Queries the bit sum of the Questionable Status Event register. This query will also clear the contents of the register.

Query Syntax STATus:QUESTIONable[:EVENT]?

Parameter	<NRf>	0~32767
Return parameter	<NR1>	0~32767

STATus:QUEStionable:CONDition 

Description Queries the status (bit sum) of the Questionable Status register. This query will not clear the register.

Query Syntax STATus:QUEStionable:CONDition?

Parameter <NRf> 0~32767

Return parameter <NR1> 0~32767



STATus:QUEStionable:ENABle 

Description Sets or queries the bit sum of the Questionable Status Enable register.

Syntax STATus:QUEStionable:ENABle <NRf>

Query Syntax STATus:QUEStionable:ENABle?

Parameter <NRf> 0~32767

Return parameter <NR1> 0~32767



STATus:QUEStionable:PTRansition 

Description Sets or queries the bit sum of the positive transition filter of the Questionable Status register.

Syntax STATus:QUEStionable:PTRansition <NRf>

Return Syntax STATus:QUEStionable:PTRansition?

Parameter <NRf> 0~32767

Return parameter <NR1> 0~32767



STATus:QUEStionable:NTRansition 

Description Sets or queries the negative transition filter of the Questionable Status register.

Syntax STATus:QUEStionable:NTRansition <NRf>

Query Syntax STATus:QUEStionable:NTRansition?

Parameter	<NRF>	0~32767
Return parameter	<NR1>	0~32767

STATus:PRESet



Description This command resets the ENABLE register, the PTRansition filter and NTRansition filter on the Operation Status and Questionable Status Registers. The registers/filters will be reset to a default value.

Default Register/Filter Values	Setting
QUEStionable Status Enable	0x0000
QUEStionable Status Positive Transition	0x7FFF
QUEStionable Status Negative Transition	0x0000
Operation Status Enable	0x0000
Operation Status Positive Transition	0x7FFF
Operation Status Negative Transition	0x0000

Summary: The Questionable Status Enable registers and the Operation Status Enable registers are both reset to 0.

The Questionable Status and Operation Status Positive Transition filters are all set high (0x7FFF) and the Negative Transition filters are all set low (0x0000). I.e., only positive transitions will be recognized for the Questionable Status and Operation Status registers.

Syntax STATus:PRESet

Source Commands

[SOURce:]CURRent[:LEVel][:IMMediate][:AMPLitude] 61

[SOURce:]CURRent[:LEVel]:TRIGgered[:AMPLitude] 62

[SOURce:]CURRent:PROTection[:LEVel] 62

[SOURce:]CURRent:PROTection:STATe 63

[SOURce:]CURRent:SLEW:RISing 63

[SOURce:]CURRent:SLEW:FALLing 64

[SOURce:]RESistance[:LEVel][:IMMediate] 64

[:AMPLitude] 64

[SOURce:]VOLTag[:LEVel][:IMMediate][:AMPLitude] 65

[SOURce:]VOLTag[:LEVel]:TRIGgered[:AMPLitude] 65

[SOURce:]VOLTag:PROTection[:LEVel] 66

[SOURce:]VOLTag:SLEW:RISing 66

[SOURce:]VOLTag:SLEW:FALLing 67

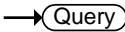
[SOURce:]CURRent[:LEVel][:IMMediate] 
 [:AMPLitude] 

Description	Sets or queries the current level in amps. For externally set current levels (from the analog control connector) the set current level is returned.						
Syntax	[SOURce:]CURRent[:LEVel][:IMMediate][:AMPLitude] {<NRf> MIN MAX}						
Query Syntax	[SOURce:]CURRent[:LEVel][:IMMediate][:AMPLitude]? [MIN MAX]						
Parameter/Return	<table border="0"> <tr> <td><NRf></td> <td>0~105% of the rated current output level.</td> </tr> <tr> <td>MIN</td> <td>Minimum current level.</td> </tr> <tr> <td>MAX</td> <td>Maximum current level.</td> </tr> </table>	<NRf>	0~105% of the rated current output level.	MIN	Minimum current level.	MAX	Maximum current level.
<NRf>	0~105% of the rated current output level.						
MIN	Minimum current level.						
MAX	Maximum current level.						
Example	<p>SOUR:CURR:LEV:IMM:AMPL? MAX</p> <p>37.800</p> <p>Returns the maximum possible current level in amps.</p>						

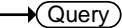
[SOURce:]CURRent[:LEVel]:TRIGgered 
[:AMPLitude] 

Description	Sets or queries the current level in amps when a software trigger has been generated.	
Syntax	[SOURce:]CURRent[:LEVel]:TRIGgered[:AMPLitude] {<NRf> MIN MAX}	
Query Syntax	[SOURce:]CURRent[:LEVel]:TRIGgered[:AMPLitude]? [MIN MAX]	
Parameter/Return	<NRf>	0%~105% of the rated current output in amps.
	MIN	Minimum current level.
	MAX	Maximum current level.
Example	SOUR:CURR:LEV:TRIG:AMPL? MAX 37.800 Returns the maximum possible current level in amps.	

[SOURce:]CURRent:PROTection[:LEVel] 

Description	Sets or queries the OCP (over-current protection) level in amps.	
Syntax	[SOURce:]CURRent:PROTection[:LEVel] {<NRf> MIN MAX}	
Query Syntax	[SOURce:]CURRent:PROTection[:LEVel]? [MIN MAX]	
Parameter/Return	<NRf>	10%~110% of the rated current output level.
	MIN	Minimum current level.
	MAX	Maximum current level.
Example	SOUR:CURR:PROT:LEV? MIN +3.600 Returns the minimum possible current level in amps.	

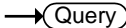
[SOURce:]CURRent:PROTection:STATe



Description	Turns OCP (over-current protection) on or off.	
Syntax	[SOURce:]CURRent:PROTection:STATe {0 1 OFF ON}	
Query Syntax	[SOURce:]CURRent:PROTection:STATe?	
Parameter/Return	0	<NR1> Turns the buzzer off.
	OFF	Turns the buzzer off.
	1	<NR1> Turns the buzzer on.
	ON	Turns the buzzer on.
Return parameter	<Bool>	Returns bleeder resistor status (0 or 1).
Example	SOUR:CURR:PROT:STAT OFF Turns OCP off.	

[SOURce:]CURRent:SLEW:RISing



Description	Sets or queries the rising current slew rate. This is only applicable for CC slew rate priority mode.	
Syntax	[SOURce:]CURRent:SLEW:RISing {<NRf> MIN MAX}	
Query Syntax	[SOURce:]CURRent:SLEW:RISing? [MIN MAX]	
Parameter/Return	<NRf>	0.01A/s~72.00A/s (2260B-30-36)
		0.1A/s~144.0A/s (2260B-30-72)
		0.1A/s~216.0A/s (2260B-30-108)
		0.01A/s~27.00A/s (2260B-80-13)
		0.01A/s~54.00A/s (2260B-80-27)
		0.01A/s~81.00A/s (2260B-80-40)
		0.001A/s~9.000A/s (2260B-250-4)
		0.01A/s~18.00A/s (2260B-250-9)
		0.01A/s~27.00A/s (2260B-250-13)
		0.001A/s~2.880A/s (2260B-800-1)
		0.001A/s~5.760A/s (2260B-800-2)
		0.001A/s~8.640A/s (2260B-800-4)
		MIN
	MAX	Maximum rising current slew rate.

Example SOUR:CURR:SLEW:RIS 72
Sets the rising current slew rate to 72A/s.

[SOURce:]CURRent:SLEW:FALLing  

Description	Sets or queries the falling current slew rate. This is only applicable for CC slew rate priority mode.	
Syntax	[SOURce:]CURRent:SLEW:FALLing {<NRf> MIN MAX}	
Query Syntax	[SOURce:]CURRent:SLEW:FALLing? [MIN MAX]	
Parameter/Return	NRf	0.01A/s~72.00A/s (2260B-30-36) 0.1A/s~144.0A/s (2260B-30-72) 0.1A/s~216.0A/s (2260B-30-108) 0.01A/s~27.00A/s (2260B-80-13) 0.01A/s~54.00A/s (2260B-80-27) 0.01A/s~81.00A/s (2260B-80-40) 0.001A/s~9.000A/s (2260B-250-4) 0.01A/s~18.00A/s (2260B-250-9) 0.01A/s~27.00A/s (2260B-250-13) 0.001A/s~2.880A/s (2260B-800-1) 0.001A/s~5.760A/s (2260B-800-2) 0.001A/s~8.640A/s (2260B-800-4)
	MIN	Minimum falling current slew rate
	MAX	Maximum falling current slew rate

Example SOUR:CURR:SLEW:FALL 1
Sets the falling current slew rate to 1A/s.

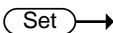
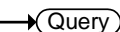
[SOURce:]RESistance[:LEVel][:IMMediate]  
[:AMPLitude]

Description	Sets or queries the internal resistance in ohms.	
Syntax	[SOURce:]RESistance[:LEVel][:IMMediate][:AMPLitude] {<NRf> MIN DEF MAX ?}	
Query Syntax	[SOURce:]RESistance[:LEVel][:IMMediate][:AMPLitude] ? [MIN MAX]	

Parameter/Return	<NRf>	Resistance in ohms: 0.000Ω~0.833Ω (2260B-30-36) 0.000Ω~0.417Ω (2260B-30-72) 0.000Ω~0.278Ω (2260B-30-108) 0.000Ω~5.926Ω (2260B-80-13) 0.000Ω~2.963Ω (2260B-80-27) 0.000Ω~1.975Ω (2260B-80-40) 0.00Ω~ 55.55Ω (2260B-250-4) 0.00Ω~ 27.77Ω (2260B-250-9) 0.00Ω~ 18.51Ω (2260B-250-13) 0.0Ω~ 555.5Ω (2260B-800-1) 0.0Ω~ 277.8Ω (2260B-800-2) 0.0Ω~ 185.1Ω (2260B-800-4)
	MIN	Minimum internal resistance in ohms
	MAX	Maximum internal resistance in ohms

Example SOUR:RES:LEV:IMM:AMPL 0.1
Sets the internal resistance to 100mΩ.

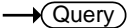
[SOURce:]VOLTage[:LEVel][:IMMediate] 
[:AMPLitude] 

Description	Sets or queries the voltage level in volts.	
Syntax	[SOURce:]VOLTage[:LEVel][:IMMediate][:AMPLitude] {<NRf> MIN MAX}	
Query Syntax	[SOURce:]VOLTage[:LEVel][:IMMediate][:AMPLitude]? [MIN MAX]	
Parameter/Return	<NRf>	0~105% of the rated output voltage in volts.
	MIN	Minimum voltage level
	MAX	Maximum voltage level

Example SOUR:VOLT:LEV:IMM:AMPL 10
Sets the voltage level to 10 volts.

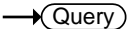
[SOURce:]VOLTage[:LEVel]:TRIGgered 
[:AMPLitude] 

Description	Sets or queries the voltage level in volts when a software trigger has been generated.	
-------------	--	--

Syntax	[SOURce:]VOLTage[:LEVel]:TRIGgered[:AMPLitude] {<NRf> MIN MAX}
Query Syntax	[SOURce:]VOLTage[:LEVel]:TRIGgered[:AMPLitude]? [MIN MAX]
Parameter/Return	<NRf> 0%~105% of the rated voltage output in volts. MIN Minimum current level. MAX Maximum current level.

Example SOUR:VOLT:LEV:TRIG:AMPL 10
Sets the voltage level to 10 volts when a software trigger is generated.

[SOURce:]VOLTage:PROTection[:LEVel]  

Description	Sets or queries the overvoltage protection level.
Syntax	[SOURce:]VOLTage:PROTection[:LEVel] {<NRf> MIN MAX}
Query Syntax	[SOURce:]VOLTage:PROTection[:LEVel]? [MIN MAX]
Parameter/Return	<NRf> 10%~110% of the rated output voltage in volts. MIN Minimum OVP level MAX Maximum OVP level

Example SOUR:VOLT:PROT:LEV MAX
Sets the OVP level to its maximum.

[SOURce:]VOLTage:SLEW:RISing  

Description	Sets or queries the rising voltage slew rate. This is only applicable for CV slew rate priority mode.
Syntax	[SOURce:]VOLTage:SLEW:RISing {<NRf> MIN MAX}
Query Syntax	[SOURce:]VOLTage:SLEW:RISing? [MIN MAX]
Parameter/Return	<NRf> 0.01V/s~60V/s (2260B-30-XX) 0.1V/s~160V/s (2260B-80-XX) 0.1V/s~500.0V/s (2260B-250-XX) 1V/s~1600V/s (2260B-800-XX) MIN Minimum rising voltage slew rate. MAX Maximum rising voltage slew rate.

Example SOUR:VOLT:SLEW:RIS MAX
 Sets the rising voltage slew rate to its maximum.

[SOURce:]VOLTage:SLEW:FALLing 

Description Sets or queries the falling voltage slew rate. This is only applicable for CV slew rate priority mode.

Syntax [SOURce:]VOLTage:SLEW:FALLing {<NRf>|MIN|MAX}

Query Syntax [SOURce:]VOLTage:SLEW:FALLing? [MIN|MAX]

Parameter/Return	<NRf>	0.01V/s~60V/s (2260B-30-XX) 0.1V/s~160V/s (2260B-80-XX) 0.1V/s~500.0V/s (2260B-250-XX) 1V/s~1600V/s (2260B-800-XX)
	MIN	Minimum voltage falling slew rate.
	MAX	Maximum voltage falling slew rate.

Example SOUR:VOLT:SLEW:FALL MIN
 Sets the falling voltage slew rate to its minimum.

Trigger Commands

The trigger commands generate and configure software triggers. This power supply supports the following two trigger functions.

- TRANSient

Specifies the current and voltage settings in advance and uses the trigger to set them. Please refer to VOLT:TRIG, CURR:TRIG on page 62 and 69 for details.

- OUTPut

Specifies the output on/ off settings in advance and uses the trigger to set them. Please refer to OUTP:TRIG on page 69 for details.

TRIGger:TRANSient[:IMMEDIATE]68
TRIGger:TRANSient:SOURce68
TRIGger:OUTPut[:IMMEDIATE]69
TRIGger:OUTPut:SOURce69

TRIGger:TRANSient[:IMMEDIATE] (Set) →

Description Generates a software trigger for the transient trigger system.

Syntax TRIGger:TRANSient[:IMMEDIATE]

TRIGger:TRANSient:SOURce (Set) → → (Query)

Description Sets or queries the trigger source for the transient system.

Syntax TRIGger:TRANSient:SOURce {BUS | IMMEDIATE}

Query Syntax TRIGger:TRANSient:SOURce?

Parameter/Return	BUS	Internal software trigger. Waits for the *TRG (or IEEE 488.1 "get" group execute trigger) command to start the trigger.
	IMMEDIATE	Starts the trigger immediately. (default)

Example: TRIG:TRAN:SOUR IMM
 Immediate Mode CURR:TRIG MAX
 VOLT:TRIG 5
 INIT:NAME TRAN
 The current changes to the maximum, and the voltage changes to 5V.

Example: TRIG:TRAN:SOUR BUS
 Bus Mode CURR:TRIG MAX
 VOLT:TRIG 5
 INIT:NAME TRAN
 TRIG:TRAN
 The current changes to the maximum, and the voltage changes to 5V.

TRIGger:OUTPut[:IMMediate] (Set) →

Description Generates a software trigger for the output trigger system.

Syntax TRIGger:OUTPut[:IMMediate]

(Set) →

TRIGger:OUTPut:SOURce → (Query)

Description Sets or queries the trigger source for the output system.

Syntax TRIGger:OUTPut:SOURce [BUS | IMMediate]

Query Syntax TRIGger:OUTPut:SOURce?

Parameter/Return	BUS	Internal software trigger. Waits for the *TRG (or IEEE 488.1 "get" group execute trigger) command to start the trigger.
	IMMediate	Starts the trigger immediately. (default)

Example: TRIG:OUTP:SOUR IMM
Immediate Mode OUTP:TRIG 1
INIT:NAME OUTP
The output changes to ON.

Example: TRIG:OUTP:SOUR BUS
Bus Mode OUTP:TRIG 1
INIT:NAME OUTP
TRIG:OUTP
The output changes to ON.

System Function Command

SYSTem:CONFigure:BEEPer[:STATe]	71
SYSTem:CONFigure:BLEeder[:STATe]	72
SYSTem:CONFigure:BTRip[:IMMediate]	72
SYSTem:CONFigure:BTRip:PROTection	72
SYSTem:CONFigure:CURRent:CONTRol	73
SYSTem:CONFigure:VOLTage:CONTRol	73
SYSTem:CONFigure:MSLave	74
SYSTem:CONFigure:OUTPut:EXTernal[:MODE]	74
SYSTem:CONFigure:OUTPut:PON[:STATe]	75
SYSTem:COMMunicate:ENABle	75
SYSTem:COMMunicate:GPIB[:SELf]:ADDReSS	76
SYSTem:COMMunicate:LAN:IPADdress	77
SYSTem:COMMunicate:LAN:GATEway	77
SYSTem:COMMunicate:LAN:SMASk	77
SYSTem:COMMunicate:LAN:MAC	78
SYSTem:COMMunicate:LAN:DHCP	78
SYSTem:COMMunicate:LAN:DNS	78
SYSTem:COMMunicate:LAN:HOSTname	79
SYSTem:COMMunicate:LAN:WEB:PACTive	79
SYSTem:COMMunicate:LAN:WEB:PASSword	79
SYSTem:COMMunicate:USB:FRONT:STATe	80
SYSTem:COMMunicate:USB:REAR:STATe	80
SYSTem:ERRor	80
SYSTem:KEYLock:MODE	80
SYSTem:KLOCK	81
SYSTem:INFormation	81
SYSTem:PRESet	82
SYSTem:VERSIon	82

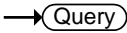
SYSTem:CONFigure:BEEPer[:STATe]  

Description	Sets or queries the buzzer state on/off.
Syntax	SYSTem:CONFigure:BEEPer[:STATe] {OFF ON 0 1}
Query Syntax	SYSTem:CONFigure:BEEPer[:STATe]?

Parameter	0 OFF	<NR1> Turns the buzzer off. Turns the buzzer off.
	1 ON	<NR1> Turns the buzzer on. Turns the buzzer on.
Return parameter	<Boolean>	Returns the buzzer status.

Set →

SYSTEM:CONFigure:BLEeder[:STATe]

→ Query

Description	Sets or queries the status of the bleeder resistor.	
Syntax	SYSTEM:CONFigure:BLEeder[:STATe]	
Query Syntax	{OFF ON AUTO 0 1 2}	
	SYSTEM:CONFigure:BLEeder[:STATe]?	
Parameter	0 OFF	<NR1> Turns the bleeder resistor off. Turns the bleeder resistor off.
	1 ON	<NR1> Turns the bleeder resistor on. Turns the bleeder resistor on.
	2	<NR1> Turns on/off the bleeder resistor automatically.
	AUTO	The bleeder resistor is automatically turned on when the output is turned on and turned off when the output is turned off.
Return parameter	<Boolean>	Returns bleeder resistor status.

SYSTEM:CONFigure:BTRip[:IMMEDIATE]

Set →

Description	Trips the power switch trip (circuit breaker) to turn the unit off (shut down the power).	
Syntax	SYSTEM:CONFigure:BTRip[:IMMEDIATE]	

Set →

SYSTEM:CONFigure:BTRip:PROTECTION

→ Query

Description	Enables/Disables the power switch trip (circuit breaker) when the OVP or OCP protection settings are tripped. This setting only applies after power has been cycled.	
-------------	--	--

Syntax	SYSTem:CONFigure:BTrip:PROTection {DISable ENABLE 0 1}	
Query Syntax	SYSTem:CONFigure:BTrip:PROTection?	
Parameter	0	<NR1> Enables the power switch trip for OVP or OCP.
	ENABLE	Enables the power switch trip for OVP or OCP.
	1	<NR1> Disables the power switch trip for OVP or OCP.
	DISable	Disables the power switch trip for OVP or OCP.
Return parameter	<Boolean>	Returns power switch trip setting.

Set →

SYSTem:CONFigure:CURRent:CONTRol

→ Query

Description Sets or queries the CC control mode (local control (panel), external voltage control, external resistance control). This setting is applied only after the power is cycled.

Syntax SYSTem:CONFigure:CURRent:CONTRol { 0 | 1 | 2 | 3 }

Query Syntax SYSTem:CONFigure:CURRent:CONTRol?

Parameter/Return	<NR1>	Description
	0	Local (Panel) control
	1	External voltage control
	2	External resistance control; 10kΩ = Io max, 0kΩ = Io min.
	3	External resistance control; 10kΩ = Io min, 0kΩ = Io max.

Set →

SYSTem:CONFigure:VOLTAge:CONTRol

→ Query

Description Sets or queries the CV control mode (local control, external voltage control, external resistance control). This setting is applied only after the power is cycled.

Syntax SYSTem:CONFigure:VOLTAge:CONTRol { 0 | 1 | 2 | 3 }

Query Syntax SYSTem:CONFigure:VOLTAge:CONTRol?

Parameter/Return	<NR1>	Description
	0	Local (Panel) control
	1	External voltage control
	2	External resistance control; 10kΩ = V _o max, 0kΩ = V _o min.
	3	External resistance control; 10kΩ = V _o min, 0kΩ = V _o max.

Set →

→ Query

SYSTem:CONFigure:MSLave

Description Sets or queries the unit operation mode. This setting is only applied after the power has been cycled.

Syntax SYSTem:CONFigure:MSLave { 0 | 1 | 2 | 3 | 4 }

Query Syntax SYSTem:CONFigure:MSLave?

Parameter/Return	<NR1>	Description
	0	Master/Local
	1	Master/Parallel 1 (2 units)
	2	Master/Parallel 2 (3 units)
	3	Slave/Parallel
	4	Slave/Series

Set →

→ Query

SYSTem:CONFigure:OUTPut:EXTernal [:MODE]

Description Sets the external logic as active high or active low. This setting is only applied after the power has been cycled.

Syntax SYSTem:CONFigure:OUTPut:EXTernal[:MODE]

Query Syntax SYSTem:CONFigure:OUTPut:EXTernal[:MODE]?

Parameter	0	Active high
	HIGH	Active high
	1	Active low
	LOW	Active low
Return Parameter	0	<boolean>Active high
	1	<boolean>Active low

Set →

SYSTEM:CONFigure:OUTPut:PON[:STATe] → Query

Description Sets the unit to turn the output ON/OFF at power-up. This setting is only applied after the power has been cycled.

Syntax SYSTEM:CONFigure:OUTPut:PON[:STATe]
{OFF|ON|0|1}

Query Syntax SYSTEM:CONFigure:OUTPut:PON[:STATe]?

Parameter	0	Output off at power up
	OFF	Output off at power up
	1	Output on at power up
	ON	Output on at power up
Return Parameter	0	Output off at power up
	1	Output on at power up

Set →

SYSTEM:COMMunicate:ENABLE → Query

Description Enables/Disables LAN, GPIB or USB remote interfaces as well as remote services (Sockets, Web Server). This setting is only applied after the power has been cycled.

Syntax SYSTEM:COMMunicate:ENABLE <mode>,<interface>

Query Syntax SYSTEM:COMMunicate:ENABLE? <interface>

Parameter	<mode>	
	OFF	Turns the selected mode off.
	0	Turns the selected mode off.
	ON	Turns the selected mode on. (Auto detect speed in USB)
	1	Turns the selected mode on. (Auto detect speed in USB)
	FULL	Full Speed (USB Only)
	2	Full Speed (USB Only)
	<interface>	
	GPIB	Select GPIB
	USB	Select USB
LAN	Select LAN	
SOCKets	Select Sockets	
WEB	Select the web server	
Return Parameter	0	The selected mode is off.
	1	The selected mode is on.

Example-1 SYST:COMM:ENAB 1,USB
 Turns the USB interface on.
 USB is auto detect speed.

Example-2 SYST:COMM:ENAB 2,USB
 Turns the USB interface on.
 USB is full speed only..

Query Example SYST:COMM:ENAB? USB
 1
 Queries the USB state, returns 1 (USB is on).

SYSTEM:COMMunicate:GPIB[:SELF]:ADDR Set →
 ess ← Query

Description	Sets or queries the GPIB address. This setting is only applied after the power has been cycled.
Syntax	SYSTEM:COMMunicate:GPIB[:SELF]:ADDRess <NR1>
Query Syntax	SYSTEM:COMMunicate:GPIB[:SELF]:ADDRess?
Parameter/Return	<NR1> 0~30

Example SYST:COMM:GPIB:SELF:ADDR 15
Sets the GPIB address to 15.

SYSTEM:COMMunicate:LAN:IPAddress  

Description Sets or queries LAN IP address. This setting is only applied after the power has been cycled.

Syntax SYSTEM:COMMunicate:LAN:IPAddress <string>

Query Syntax SYSTEM:COMMunicate:LAN:IPAddress?

Parameter/Return <string> LAN IP address in string format ("address")
Applicable ASCII characters: 20H to 7EH

Example SYST:COMM:LAN:IPAD "172.16.5.111"
Sets the IP address to 172.16.5.111.

SYSTEM:COMMunicate:LAN:GATEway  

Description Sets or queries the Gateway address. This setting is only applied after the power has been cycled.

Syntax SYSTEM:COMMunicate:LAN:GATEway <string>

Query Syntax SYSTEM:COMMunicate:LAN:GATEway?

Parameter/Return <string> Gateway address in string format ("address")
Applicable ASCII characters: 20H to 7EH

Example SYST:COMM:LAN:GATE "172.16.0.254"
Sets the LAN gateway to 172.16.0.254.

SYSTEM:COMMunicate:LAN:SMASK  

Description Sets or queries the LAN subnet mask. This setting is only applied after the power has been cycled.

Syntax SYSTEM:COMMunicate:LAN:SMASK <string>

Query Syntax SYSTEM:COMMunicate:LAN:SMASK?

Parameter/Return <string> Subnet mask in string format ("mask")
Applicable ASCII characters: 20H to 7EH

Example SYST:COMM:LAN:SMASK "255.255.0.0"
Sets the LAN mask to 255.255.0.0.

SYSTem:COMMunicate:LAN:MAC → (Query)

Description	Returns the unit MAC address as a string. The MAC address cannot be changed.
Query Syntax	SYSTem:COMMunicate:LAN:MAC?
Return parameter	<string> Returns the MAC address in the following format "FF-FF-FF-FF-FF-FF"
Example	SYST:COMM:LAN:MAC? 02-80-AD-20-31-B1 Returns the MAC address.

(Set) →

SYSTem:COMMunicate:LAN:DHCP → (Query)

Description	Turns DHCP on/off. Queries the DHCP status. This setting is only applied after the power has been cycled.
Syntax	SYSTem:COMMunicate:LAN:DHCP {OFF ON 0 1}
Query Syntax	SYSTem:COMMunicate:LAN:DHCP?
Parameter	0 DHCP off OFF DHCP off 1 DHCP on ON DHCP on
Return parameter	0 <boolean>DHCP off 1 <boolean>DHCP on

(Set) →

SYSTem:COMMunicate:LAN:DNS → (Query)

Description	Sets or queries the DNS address. This setting is only applied after the power has been cycled.
Syntax	SYSTem:COMMunicate:LAN:DNS <string>
Query Syntax	SYSTem:COMMunicate:LAN:DNS?
Parameter/Return	<string> DNS in string format ("mask") Applicable ASCII characters: 20H to 7EH
Example	SYST:COMM:LAN:DNS "172.16.1.252" Sets the DNS to 172.16.1.252.

SYSTEM:COMMunicate:LAN:HOSTname → 

Description	Queries the host name.
Query Syntax	SYSTEM:COMMunicate:LAN:HOSTname?
Return Parameter	<string> Host name in string format
Query Example	SYST:COMM:LAN:HOST? P-160054 Returns the host name (P-160054).



SYSTEM:COMMunicate:LAN:WEB:PACTIVE → 

Description	Sets or queries whether the web password is on or off. This setting is only applied after the power has been cycled.
Syntax	SYSTEM:COMMunicate:LAN:WEB:PACTIVE {OFF ON 0 1}
Query Syntax	SYSTEM:COMMunicate:LAN:WEB:PACTIVE?
Parameter	0 Web password off OFF Web password off 1 Web password on ON Web password on
Return parameter	0 <boolean> Web password off 1 <boolean> Web password on

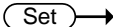

SYSTEM:COMMunicate:LAN:WEB:PASSword → 

Description	Sets or queries the web password. This setting is only applied after the power has been cycled.
Syntax	SYSTEM:COMMunicate:LAN:WEB:PASSword <NR1>
Query Syntax	SYSTEM:COMMunicate:LAN:WEB:PASSword?
Parameter/Return	<NR1> 0 ~ 9999
Example	SYST:COMM:LAN:WEB:PASS 1234 Set the web password as 1234.

SYSTem:COMMunicate:USB:FRONt:STATe → **Query**

Description Queries the front panel USB-A port state.

Query Syntax SYSTem:COMMunicate:USB:FRONt:STATe?

Return parameter	0	<NR1>Absent
	1	<NR1>Mass Storage

SYSTem:COMMunicate:USB:REAR:STATe → **Query**

Description Queries the rear panel USB-B port state.

Query Syntax SYSTem:COMMunicate:USB:REAR:STATe?

Return parameter	0	<NR1>Absent
	1	<NR1>USB-CDC
	2	<NR1>GPIB-USB

SYSTem:ERRor → **Query**

Description Queries the error queue. The last error message is returned and cleared. A maximum of 16 errors are stored in the error queue. Each remote interface I/O session (i.e., GPIB, USB, LAN, etc.) has its own error queue.

Query Syntax SYSTem:ERRor?

Paramter/Return	<NR1>,<string>	Returns an error code followed by an error message as a string. The string is returned as "string".
-----------------	----------------	---

Example SYSTem:ERRor?
-100, "Command error"

(Set) →

SYSTem:KEYLock:MODE → **Query**

Description Sets or queries the key lock mode. This setting is the equivalent of the F-19 function setting.

Syntax SYSTem:KEYLock:MODE {0|1}

Query Syntax SYSTem:KEYLock:MODE?

Parameter /	0	Panel lock: allow output off.
Return parameter	1	Panel lock: allow output on/off.

→ Set

SYSTem:KLOCK

→ Query

Description	Enables or disables the front panel key lock.	
Syntax	SYSTem:KLOCK { OFF ON 0 1 }	
Query Syntax	SYSTem:KLOCK?	
Parameter	0	Panel keys unlocked
	OFF	Panel keys unlocked
	1	Panel keys locked
	ON	Panel keys locked
Return parameter	0	<boolean>Panel keys unlocked
	1	<Boolean>Panel keys locked

SYSTem:INFormation

→ Query

Description	Queries the system information. Returns the machine version, build date, keyboard CPLD version and analog CPLD version.	
Query Syntax	SYSTem:INFormation?	
Return Parameter	<block data>	Definite length arbitrary block response data.
Query Example	SYST:INF? #3238MFRS XXXXXX,Model AAAAAA,SN BBBBBB,Firmware-Version 01.00.20120101,Keyboard- CPLD 0x030C,AnalogControl-CPLD 0x0421,Kernel- Buildon May 22 2011,MAC 02-80-ad-20-31-b1	

Returns the system information as a block data.
(XXXXXX= manufacturer, AAAAAA = model number,
BBBBBB = Serial Number)

SYSTem:PRESet**Set** →

Description	Resets all the settings to the factory default settings. See page 107 for details. This command is identical in effect to the *RST command.
-------------	---

Syntax	SYSTem:PRESet
--------	---------------

SYSTem:VERsion→ **Query**

Description	Returns the version of the SCPI specifications that the unit complies with.
-------------	---

Query Syntax	SYSTem:VERsion?
--------------	-----------------

Return	<1999.0> Always returns the SCPI version: 1999.0.
--------	---

IEEE 488.2 Common Commands

*CLS	83
*ESE	83
*ESR	84
*IDN	84
*OPC	84
*RST	85
*SRE	85
*STB	85
*TRG	86
*TST	86
*WAI	86

*CLS



Description The *CLS command clears the Standard Event Status, Operation Status and Questionable Status registers. The corresponding Enable registers in each of the above registers are not cleared.

If a <NL> newline code immediately precedes a *CLS command, the Error Que and the MAV bit in the Status Byte Register is also cleared.

Syntax *CLS

*ESE

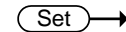

Description Sets or queries the Standard Event Status Enable register.

Syntax *ESE <NR1>

Query Syntax *ESE?

Parameter <NR1> 0~255

Return parameter <NR1> Returns the bit sum of the Standard Event Status Enable register.

*ESR → Query

Description Queries the Standard Event Status (Event) register. The Event Status register is cleared after it is read.

Query Syntax *ESR?

Return parameter <NR1> Returns the bit sum of the Standard Event Status (Event) register and clears the register.

*IDN → Query

Description Queries the manufacturer, model name, serial number, and firmware version of the unit.

Query Syntax *IDN?

Return parameter <string> Returns the instrument identification as a string in the following format:
 XXXXXX,AAAAAA,TW123456,01.00.20110101
 Manufacturer: XXXXXX
 Model number : AAAAAA
 Serial number : TW123456
 Firmware version : 01.00.20110101

Set →

*OPC → Query

Description The *OPC command sets the OPC bit (bit0) of the Standard Event Status Register when all current commands have been processed.
 The *OPC? Query returns 1 when all the outstanding commands have completed.

Syntax *OPC

Query Syntax *OPC?

Return parameter 1 Returns 1 when all the outstanding commands have completed.

*RST		(Set) →
Description	Resets all the settings to the factory default settings. See page 107 for details. This command is identical in effect to the SYSTEM:PRESet command.	
Syntax	*RST	
*SRE		(Set) → → (Query)
Description	Sets or queries the Service Request Enable register. The Service Request Enable register determines which registers of the Status Byte register are able to generate service requests.	
Syntax	*SRE <NR1>	
Query Syntax	*SRE?	
Parameter	<NR1>	0~255
Return parameter	<NR1>	Returns the bit sum of the Service Request Enable register.
*STB		→ (Query)
Description	Queries the bit sum of the Status Byte register with MSS (Master summary Status).	
Query Syntax	*STB?	
Return parameter	<NR1>	Returns the bit sum of the Status Byte register with the MSS bit (bit 6).

***TRG**

Set →

Description The *TRG command is able to generate a “get” (Group Execute Trigger). If the 2260B cannot accept a trigger at the time of the command, an error message is generated (-211, “Trigger ignored”).

Syntax *TRG

***TST**

→ Query

Description Executes a self test.

Query Syntax *TST?

Return parameter	0	Returns “0” if there are no errors.
	<NR1>	Returns an error code <NR1> if there is an error.

***WAI**

Set →

Description Prevents any other commands or queries from being executed until all outstanding commands have completed.

Syntax *WAI

Status Register Overview

To program the 2260B power supply effectively, the Status registers need to be understood. This chapter explains in detail how the Status registers are used and how to configure them.

Introduction to the Status Registers

Overview

The status registers are used to determine the status of the power supply. The status registers maintain the status of the protection conditions, operation conditions and instrument errors.

The 2260B Series have a number of register groups:

- Questionable Status Register Group
- Standard Event Status Register Group
- Operation Status Register Group
- Status Byte Register
- Service Request Enable Register
- Service Request Generation
- Error Queue
- Output Buffer

The next page shows the structure of the Status registers.

The Status Registers

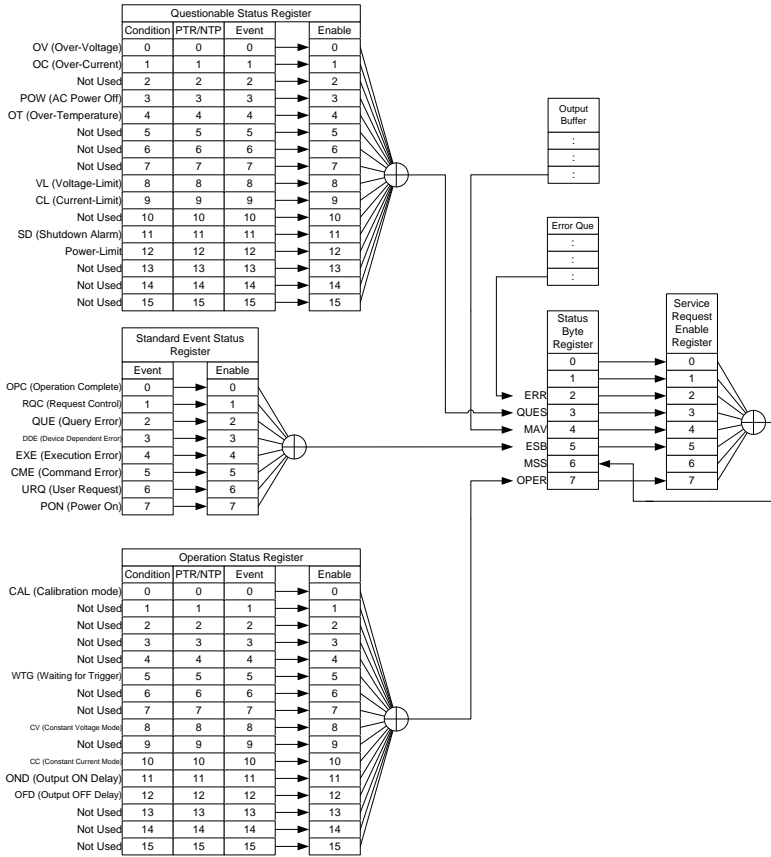

Questionable Status Register Group

Overview

The Questionable Status Register Group indicates if any protection modes or limits have been tripped.

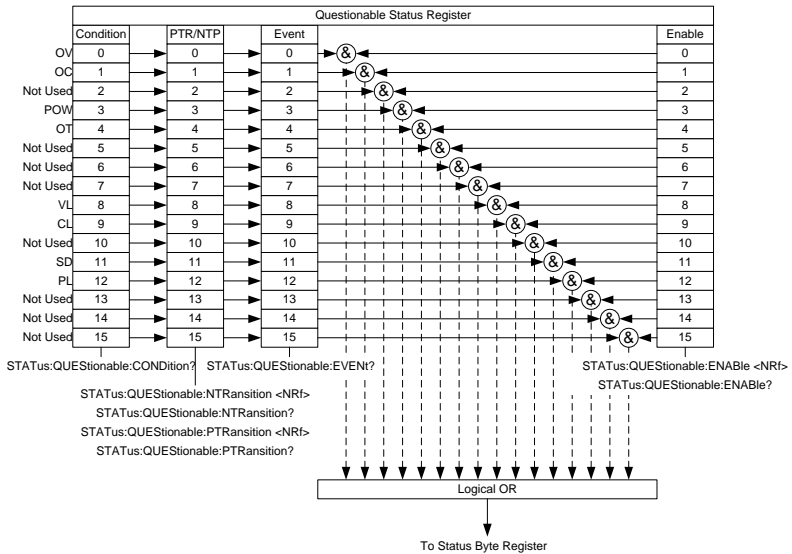

Bit Summary

Event	Bit #	Bit Weight
OV (Over-Voltage) Over voltage protection has been tripped	0	1
OC (Over-Current) Over current protection has been tripped	1	2
POW (AC Power Off) AC power switch is off	3	8

OT (Over Temperature)	4	16
Over temperature protection has been tripped		
VL (Voltage Limit)	8	256
Voltage limit has been reached		
CL (Current Limit)	9	512
Current limit has been reached		
SD (Shutdown Alarm)	11	2048
PL (Power-Limit)	12	4096

Condition Register The Questionable Status Condition Register indicates the status of the power supply. If a bit is set in the Condition register, it indicates that the event is true. Reading the condition register does not change the state of the condition register.

PTR/NTR Filters The PTR/NTR (Positive/Negative transition) register determines the type of transition conditions that will set the corresponding bit in the Event Registers. Use the Positive transition filter to view events that change from false to positive, and use the negative transition filter to view events that change from positive to negative.

Positive Transition	0→1
Negative Transition	1→0

Event Register The PTR/NTR Register will dictate the type of transition conditions will set the corresponding bits in the Event Register. If the Event Register is read, it will be cleared to 0.

Enable Register The Enable register determines which Events in the Event Register will be used to set the QUES bit in the Status Byte Register.

Operation Status Register Group

Overview

The Operation Status Register Group indicates the operating status of the power supply.

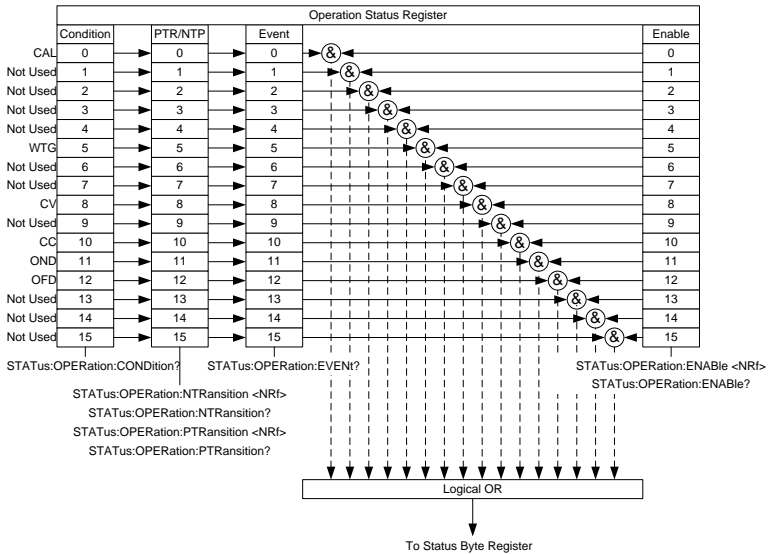

Bit Summary

Event	Bit #	Bit Weight
CAL (Calibration mode)	0	1
Indicates if the 2260B is in calibration mode.		
WTG (Waiting for trigger)	5	32
Indicates if the 2260B is waiting for a trigger.		

	CV (Constant voltage mode)	8	256
	Indicates if the 2260B is in CV mode.		
	CC (Constant current mode)	10	1024
	Indicates if the 2260B is in CC mode.		
	OND (Output ON Delay)	11	2048
	Indicates if Output ON delay time is active		
	OFD (Output OFF Delay)	12	4096
	Indicates if Output OFF delay time is active		
Condition Register	The Operation Status Condition Register indicates the operating status of the power supply. If a bit is set in the Condition register, it indicates that the event is true. Reading the condition register does not change the state of the condition register.		
PTR/NTR Filters	The PTR/NTR (Positive/Negative transition) register determines the type of transition conditions that will set the corresponding bit in the Event Registers. Use the Positive transition filter to view events that change from false to positive, and use the negative transition filter to view events that change from positive to negative.		
	Positive Transition	0→1	
	Negative Transition	1→0	
Event Register	The PTR/NTR Register will dictate the type of transition conditions will set the corresponding bits in the Event Register. If the Event Register is read, it will be cleared to 0.		

Enable Register The Enable register determines which registered Events in the Event Register will be used to set the OPER bit in the Status Byte Register.

Standard Event Status Register Group

Overview The Standard Event Status Register Group indicates if any errors have occurred. The bits of the Event register are set by the error event queue.

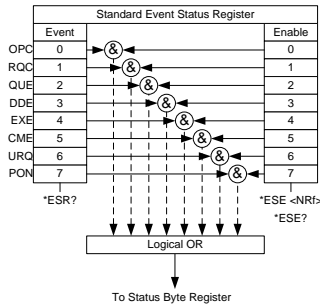

Bit Summary

Event	Bit #	Bit Weight
OPC (Operation complete)	0	1
The OCP bit is set when all selected pending operations are complete. This bit is set in response to the *OPC command.		
RQC (Request control)	1	2

	QUE (Query Error)	2	4
	The Query Error bit is set in response to an error reading the Output Queue. This can be caused by trying to read the Output Queue when there is no data present.		
	DDE (Device Dependent Error)	3	8
	Device specific error.		
	EXE (Execution Error)	4	16
	The EXE bit indicates an execution error due to one of the following: illegal command parameter, parameter out of range, invalid parameter, the command didn't execute due to an overriding operation condition.		
	CME (Command Error)	5	32
	The CME bit is set when a syntax error has occurred. The CME bit can also be set when a <GET> command is received within a program message.		
	URQ (User Request)	6	64
	PON (Power On)	7	128
	Indicates the power is turned on.		
Event Register	Any bits set in the event register indicate that an error has occurred. Reading the Event register will reset the register to 0.		
Enable Register	The Enable register determines which Events in the Event Register will be used to set the ESB bit in the Status Byte Register.		

Status Byte Register & Service Request Enable Register

Overview

The Status Byte register consolidates the status events of all the status registers. The Status Byte register can be read with the *STB? query and can be cleared with the *CLS command.

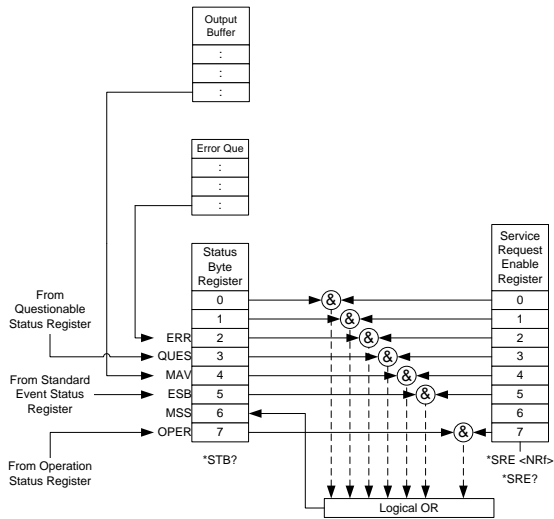

Bit Summary

Event	Bit #	Bit Weight
ERR (Error Event/Queue)	2	4
If data is present in the Error queue, the ERR bit will be set.		
QUES (Questionable Status Register)	3	8
The summary bit for the Questionable Status Register group.		
MAV (Message Available) This is set when there is data in the Output Queue waiting to be read.	4	16

	(ESB) Event Summary Bit. The ESB is the summary bit for the Standard Event Status Register group.	5	32
	MSS Bit The MSS Bit is the summary of the Status Byte Register and Service Request register (bits 1-5, 7). This will be set to 1.	6	64
	OPER (Operation Status Register) OPER bit is the summary bit for the Operation Status Register Group.	7	128
Status Byte Register	Any bits set in the Status byte register acts as a summary register for all the three other status registers and indicates if there is a service request, an error in the Error Queue or data in the Output Queue. Reading the Status Byte register will reset the register to 0.		
Service Request Enable Register	The Service Request Enable Register controls which bits in the Status Byte Register are able to generate service requests.		

Error List

Command Errors

Overview

An <error/event number> in the range [-199 , -100] indicates that an IEEE 488.2 syntax error has been detected by the instrument's parser. The occurrence of any error in this class shall cause the command error bit (bit 5) in the event status register (IEEE 488.2, section 11.5.1) to be set. One of the following events has occurred:

- An IEEE 488.2 syntax error has been detected by the parser. That is, a controller-to-device message was received which is in violation of the IEEE 488.2 standard. Possible violations include a data element which violates the device listening formats or whose type is unacceptable to the device.
- An unrecognized header was received. Unrecognized headers include incorrect device-specific headers and incorrect or unimplemented IEEE 488.2 common commands.

Events that generate command errors shall not generate execution errors, device-specific errors, or query errors; see the other error definitions in this chapter.

Error Code	Description
-100 Command Error	This is the generic syntax error for devices that cannot detect more specific errors. This code indicates only that a Command Error as defined in IEEE 488.2,11.5.1.1.4 has occurred.
-102 Syntax error	An unrecognized command or data type was encountered; for example, a string was received when the device does not accept strings.
-103 Invalid separator	The parser was expecting a separator and encountered an illegal character; for example, the semicolon was omitted after a program message unit, MEAS:VOLT:DC?:MEASCURR:DC?
-104 Data type error	The parser recognized a data element different than one allowed; for example, numeric or string data was expected but block data was encountered.
-108 Parameter not allowed	More parameters were received than expected for the header; for example, the KLOCK command only accepts one parameter, so receiving SYSTem:KLOCK 1,0 is not allowed.
-109 Missing parameter	Fewer parameters were received than required for the header; for example, the KLOCK command requires one parameter, so receiving KLOCK is not allowed.
-111 Header separator error	A character which is not a legal header separator was encountered while parsing the header; for example, no blank space followed the header, thus APPL 5, 1 is an error.

-112 Program mnemonic too long	The header contains more than twelve characters (see IEEE 488.2, 7.6.1.4.1).
-113 Undefined header	The header is syntactically correct, but it is undefined for this specific device; for example, *XYZ is not defined for any device.
-114 Header suffix out of range	The value of a numeric suffix attached to a program mnemonic, see Syntax and Style section 6.2.5.2, makes the header invalid.
-115 Unexpected number of parameters	The number of parameters received does not correspond to the number of parameters expected. This is typically due to an inconsistency with the number of instruments in the selected group.
-120 Numeric data error	This error, as well as errors -121 through -129, are generated when parsing a data element which appears to be numeric, including the nondecimal numeric types. This particular error message should be used if the device cannot detect a more specific error.
-121 Invalid character in number	An invalid character for the data type being parsed was encountered; for example, an alpha in a decimal numeric or a "9" in octal data.
-128 Numeric data not allowed	A legal numeric data element was received, but the device does not accept one in this position for the header.
-131 Invalid suffix	The suffix does not follow the syntax described in IEEE 488.2, 7.7.3.2, or the suffix is inappropriate for this device.

-141 Invalid character data	Either the character data element contains an invalid character or the particular element received is not valid for the header.
-148 Character data not allowed	A legal character data element was encountered where prohibited by the device.
-151 Invalid string data	A string data element was expected, but was invalid for some reason (see IEEE 488.2, 7.7.5.2); for example, an END message was received before the terminal quote character.
-158 String data not allowed	A string data element was encountered but was not allowed by the device at this point in parsing.
-160 Block data error	This error, as well as errors -161 through -169, are generated when parsing a block data element. This particular error message should be used if the device cannot detect a more specific error.
-161 Invalid block data	A block data element was expected, but was invalid for some reason (see IEEE 488.2, 7.7.6.2); for example, an END message was received before the length was satisfied.
-168 Block data not allowed	A legal block data element was encountered but was not allowed by the device at this point in parsing.
-178 Expression data not allowed	A legal expression data was encountered but was not allowed by the device at this point in parsing.

Execution Errors

Overview An <error/event number> in the range [-299 , -200] indicates that an error has been detected by the instrument's execution control block. The occurrence of any error in this class shall cause the execution error bit (bit 4) in the event status register (IEEE 488.2, section 11.5.1) to be set. One of the following events has occurred:

- A <PROGRAM DATA> element following a header was evaluated by the device as outside of its legal input range or is otherwise inconsistent with the device's capabilities.
- A valid program message could not be properly executed due to some device condition.

Execution errors shall be reported by the device after rounding and expression evaluation operations have taken place. Rounding a numeric data element, for example, shall not be reported as an execution error. Events that generate execution errors shall not generate Command Errors, device-specific errors, or Query Errors; see the other error definitions in this section.

Error Code	Description
-200 Execution error	This is the generic syntax error for devices that cannot detect more specific errors. This code indicates only that an Execution Error as defined in IEEE 488.2, 11.5.1.1.5 has occurred.

-201 Invalid while in local	Indicates that a command is not executable while the device is in local due to a hard local control (see IEEE 488.2, 5.6.1.5); for example, a device with a rotary switch receives a message which would change the switches state, but the device is in local so the message can not be executed.
-203 Command protected	Indicates that a legal password-protected program command or query could not be executed because the command was disabled.
-211 Trigger ignored	Indicates that a GET, *TRG, or triggering signal was received and recognized by the device but was ignored because of device timing considerations; for example, the device was not ready to respond. Note: a DT0 device always ignores GET and treats *TRG as a Command Error.
-213 Init ignored	Indicates that a request for a measurement initiation was ignored as another measurement was already in progress.
-220 Parameter error	Indicates that a program data element related error occurred. This error message should be used when the device cannot detect the more specific errors described for errors -221 through -229.
-221 Settings conflict	Indicates that a legal program data element was parsed but could not be executed due to the current device state (see IEEE 488.2, 6.4.5.3 and 11.5.1.1.5.).

-222 Data out of range	Indicates that a legal program data element was parsed but could not be executed because the interpreted value was outside the legal range as defined by the device (see IEEE 488.2, 11.5.1.1.5.).
-224 Illegal parameter value	Used where exact value, from a list of possible values, was expected.

Device Specific Errors

Overview An <error/event number> in the range [-399 , -300] or [1 , 32767] indicates that the instrument has detected an error which is not a command error, a query error, or an execution error; some device operations did not properly complete, possibly due to an abnormal hardware or firmware condition. These codes are also used for self-test response errors. The occurrence of any error in this class should cause the device-specific error bit (bit 3) in the event status register (IEEE 488.2, section 11.5.1) to be set. The meaning of positive error codes is device-dependent and may be enumerated or bit mapped; the <error message>string for positive error codes is not defined by SCPI and available to the device designer.

Note that the string is not optional; if the designer does not wish to implement a string for a particular error, the null string should be sent (for example, 42,""). The occurrence of any error in this class should cause the device-specific error bit (bit 3) in the event status register (IEEE 488.2, section 11.5.1) to be set. Events that generate device-specific errors shall not generate command errors, execution errors,

or query errors; see the other error definitions in this section.

Error Code	Description
-310 System error	Indicates that some error, termed “system error” by the device, has occurred. This code is device-dependent.
-320 Storage fault	Indicates that the firmware detected a fault when using data storage. This error is not an indication of physical damage or failure of any mass storage element.

Query Errors

Overview An <error/event number> in the range [-499 , -400] indicates that the output queue control of the instrument has detected a problem with the message exchange protocol described in IEEE 488.2, chapter 6. The occurrence of any error in this class shall cause the query error bit (bit 2) in the event status register (IEEE 488.2, section 11.5.1) to be set. These errors correspond to message exchange protocol errors described in IEEE 488.2, section 6.5. One of the following is true:

- An attempt is being made to read data from the output queue when no output is either present or pending;
- Data in the output queue has been lost.

Events that generate query errors shall not generate command errors, execution errors, or device-specific errors; see the other error definitions in this section.

Error Code	Description
-400 Query error	This is the generic query error for devices that cannot detect more specific errors. This code indicates only that a Query Error as defined in IEEE 488.2, 11.5.1.1.7 and 6.3 has occurred.

APPENDIX

2260B Default Settings	107
Error Messages & Messages	109
LED Display Format	110

2260B Default Settings

The following default settings are the factory configuration settings for the power supply.

Initial Settings	Default Setting	
Output	Off	
LOCK	0 (Disabled)	
Voltage	0V	
Current	0A	
OVP	Maximum	
OCP	Maximum	
Normal Function Settings	Setting	Default Setting
Output ON delay time	F-01	0.00s
Output OFF delay time	F-02	0.00s
V-I mode slew rate select	F-03	0 = CV high speed priority
Rising voltage slew rate	F-04	60.00V/s (2260B-30-XX)
		160.0V/s (2260B-80-XX)
		500.0V/s (2260B-250-XX)
		1600V/s (2260B-800-XX)
Falling voltage slew rate	F-05	60.00V/s (2260B-30-XX)
		160.0V/s (2260B-80-XX)
		500.0V/s (2260B-250-XX)
		1600V/s (2260B-800-XX)
Rising current slew rate	F-06	72.00A/s (2260B-30-36)
		144.0A/s (2260B-30-72)
		216.0A/s (2260B-30-108)
		27.00A/s (2260B-80-13)
		54.00A/s (2260B-80-27)
		81.00A/s (2260B-80-40)
		9.000A/s (2260B-250-4)
		18.00A/s (2260B-250-9)
		27.00A/s (2260B-250-13)
		2.880A/s (2260B-800-1)
5.760A/s (2260B-800-2)		
8.640A/s (2260B-800-4)		

Falling current slew rate	F-07	72.00A/s (2260B-30-36) 144.0A/s (2260B-30-72) 216.0A/s (2260B-30-108) 27.00A/s (2260B-80-13) 54.00A/s (2260B-80-27) 81.00A/s (2260B-80-40) 9.000A/s (2260B-250-4) 18.00A/s (2260B-250-9) 27.00A/s (2260B-250-13) 2.880A/s (2260B-800-1) 5.760A/s (2260B-800-2) 8.640A/s (2260B-800-4)
Internal resistance setting	F-08	0.000 Ω
Bleeder circuit control	F-09	1 = ON
Buzzer ON/OFF control	F-10	1 = ON
Measurement Average Setting	F-17	0 = Low
Lock Mode	F-19	0 = Panel lock: allow output off
USB/GPIB setting		
Rear Panel USB Mode	F-22	2 = USB CDC, Auto Detect Speed
GPIB address	F-23	8
LAN setting		
LAN	F-36	1 = Enable
DHCP	F-37	1 = Enable
Sockets active	F-57	1 = Enable
Web Server active	F-59	1 = Enable
Web password active	F-60	1 = Enable
Web setting password	F-61	0000
Power On Configuration		
CV Control	F-90	0= Panel control (local)
CC Control	F-91	0= Panel control (local)
Power-ON Output	F-92	0 = OFF at startup
Master/Slave	F-93	0 = Master/Local
External Out Logic	F-94	0= High ON
Power Switch trip	F-95	0 = Enable

The factory settings can be recalled by using the *RST or SYSTem:PRESet commands. Note that the power needs to be cycled before the factory settings for the USB, GPIB, LAN and Power On Configuration settings can take effect.

Error Messages & Messages

The following error messages or messages may appear on the 2260B screen during operation.

Error Messages	Description
Err 001	USB Mass Storage is not present
Err 002	No (such)file in USB mass storage
Err 003	Empty memory location
Err 004	File access error
 Note	For error messages other than Err 001 to Err 004, please contact your distributor for service repair.
Messages	Description
MSG 001	External control of output. Output off (F-94=0, High=on)
MSG 002	External control of output. Output off (F-94=1, Low=on)
MSG 003	F-93 is not zero. Unable to calibrate.

LED Display Format

Use the following table to read the LED display messages.

0	1	2	3	4	5	6	7	8	9	A	B	C	D
0	1	2	3	4	5	6	7	8	9	A	b	C	d
E	F	G	H	I	J	K	L	M	N	O	P	Q	R
E	F	G	H	I	J	K	L	M	N	O	P	Q	R
S	T	U	V	W	X	Y	Z	()	+	-	,		
S	T	U	V	W	X	Y	Z	()	+	-	,		

INDEX

- Caution symbol..... 2
- Cleaning the instrument 4
- Configuration
 - table.....18
- Connector plug manufacturer.. 15
- DECA SwitchLab..... 15
- Display format 110
- Disposal instructions..... 4
- Environment
 - safety instruction 4
- Error messages 109
- Ethernet
 - interface26
 - sockets.....27
 - web server26
- Front panel diagram..... 10
- Ground
 - symbol.....2
- LED conversion..... 110
- List of features 8
- Messages 109
- Model differences 7
- Power on/off
 - safety instruction..... 16
- Rear panel diagram 13
- Remote control 23
 - Command list 45
 - Command syntax..... 41
 - Error list 97
 - GPIB configuration 24
 - Status registers 87
 - USB configuration..... 24, 37, 38, 40
- Service operation
 - about disassembly..... 3
- Socket server function check 28, 31
- UK power cord 5
- Warning symbol..... 2
- Web server function check..... 31

Specifications are subject to change without notice.
All Keithley trademarks and trade names are the property of Keithley Instruments.
All other trademarks and trade names are the property of their respective companies.

Keithley Instruments

Corporate Headquarters • 28775 Aurora Road • Cleveland, Ohio 44139 • 440-248-0400 • 1-800-833-9200 • tek.com/keithley

