

R&S® SMCV100B

Vector Signal Generator

User Manual



1179059702
Version 08

ROHDE & SCHWARZ
Make ideas real



This document describes the R&S®SMCV100B, stock no. 1432.7000.02 and its options:

- R&S®SMCVB-B103 Frequency range 4 kHz to 3 GHz (1433.2002.xx)
- R&S®SMCVB-KB106 Frequency range extension to 6 GHz (1433.2202.xx)
- R&S®SMCVB-KB107 Frequency range extension to 7 GHz (1433.2402.xx)
- R&S®SMCVB-K19 Digital baseband interface (1434.4073.xx)
- R&S®SMCVB-K31 High output power (1434.4115.xx)
- R&S®SMCVB-K62 AWGN (Additional white Gaussian noise) (1434.3654.xx)
- R&S®SMCVB-K197 Basic AM/FM/PhiM (via baseband) (1434.3619.xx)
- R&S®SMCVB-K198 Pulse Modulation (via baseband) (1434.3631.xx)
- R&S®SMCVB-K199 Custom digital modulation (1434.3990.xx)
- R&S®SMCVB-K200 Waveform package (1434.5728.xx)
- R&S®SMCVB-K505 ARB waveform streaming (1434.5328.xx)
- R&S®SMCVB-K511 ARB memory extension to 512 MSamples (1434.3519.xx)
- R&S®SMCVB-K512 ARB memory extension to 1 GSample (1434.3531.xx)
- R&S®SMCVB-K519 Enable broadcast standards (1434.3690.xx)
- R&S®SMCVB-K521 Extension to 120 MHz RF modulation bandwidth (1434.3554.xx)
- R&S®SMCVB-K522 Extension to 160 MHz RF modulation bandwidth (1434.3577.xx)
- R&S®SMCVB-K523 Extension to 240 MHz RF modulation bandwidth (1434.4050.xx)
- R&S®SMCVB-K547 Improved modulation frequency response (1434.4138.xx)
- R&S®SMCVB-K709 Low phase noise (1434.3590.xx)
- R&S®SMCVB-K980 HUMS (Health and Utilization Monitoring Service) (1434.5757.xx)

This manual describes firmware version FW 5.20.043.xx and later of the R&S®SMCV100B.

© 2023 Rohde & Schwarz

Muehldorfstr. 15, 81671 Muenchen, Germany

Phone: +49 89 41 29 - 0

Email: info@rohde-schwarz.com

Internet: www.rohde-schwarz.com

Subject to change – data without tolerance limits is not binding.

R&S® is a registered trademark of Rohde & Schwarz GmbH & Co. KG.

The Bluetooth® word mark and logos are registered trademarks owned by Bluetooth SIG, Inc. and any use of such marks by Rohde & Schwarz is under license.

CDMA2000® is a registered trademark of the Telecommunications Industry Association (TIA-USA).

The terms HDMI, HDMI High-Definition Multimedia Interface, HDMI trade dress and the HDMI Logos are trademarks or registered trademarks of HDMI Licensing Administrator, Inc.

All other trademarks are the properties of their respective owners.

1179.0597.02 | Version 08 | R&S®SMCV100B

Throughout this manual, products from Rohde & Schwarz are indicated without the ® symbol, e.g. R&S®SMCV100B is indicated as R&S SMCVB, R&S®SFE is indicated as R&S SFE, R&S®SFE100 is indicated as R&S SFE100, R&S®SMW200A is indicated as R&S SMW. Linux® is abbreviated as Linux.

Contents

1	Safety and regulatory information.....	15
1.1	Safety instructions.....	15
1.2	Labels on R&S SMCV100B.....	17
1.3	Warning messages in the documentation.....	18
1.4	Where to find key documents on Rohde & Schwarz.....	18
1.5	Korea certification class B.....	18
2	Welcome.....	20
2.1	Key features.....	20
2.2	What's new.....	21
2.3	Documentation overview.....	21
2.3.1	Getting started manual.....	21
2.3.2	User manuals and help.....	22
2.3.3	Service manual.....	22
2.3.4	Instrument security procedures.....	22
2.3.5	Printed safety instructions.....	22
2.3.6	Data sheets and brochures.....	22
2.3.7	Release notes and open source acknowledgment (OSA).....	23
2.3.8	Application notes, application cards, white papers, etc.....	23
2.3.9	Videos.....	23
3	Getting started.....	24
3.1	Preparing for use.....	24
3.1.1	Lifting and carrying.....	24
3.1.2	Unpacking and checking.....	24
3.1.3	Choosing the operating site.....	24
3.1.4	Setting up the R&S SMCV100B.....	25
3.1.5	Considerations for test setup.....	26
3.1.6	Connecting to power.....	27
3.1.7	Connecting to LAN.....	27
3.1.8	Connecting a monitor.....	28
3.1.9	Connecting USB devices.....	29
3.1.10	Connecting to RF coaxial connectors.....	29

3.1.11	Connecting to RF 50 Ω	31
3.1.12	Connecting to Ref In/Ref Out.....	31
3.1.13	Connecting to Dig. IQ HS x.....	31
3.1.14	Connecting to IP Data.....	32
3.1.15	Switching on or off.....	34
3.2	Instrument tour.....	35
3.2.1	Front panel tour.....	35
3.2.2	Rear panel tour.....	39
3.3	Trying out the instrument.....	42
3.3.1	Generating an unmodulated carrier.....	43
3.3.2	Generating a digitally modulated signal.....	44
3.3.3	Triggering the instrument with an external signal.....	47
3.3.4	Enabling and configuring a marker signal.....	51
3.3.5	Verifying the generated signal with the graphics display.....	53
3.3.6	Saving and recalling settings.....	56
3.3.7	Generating a DAB signal.....	58
3.4	System overview.....	60
3.4.1	Brief introduction to the instrument's concept.....	60
3.4.2	Signal flow at a glance.....	61
3.4.3	Internal baseband source ("Baseband" block).....	62
3.4.4	Digital baseband input/output ("BB input"/ "I/Q digital" block).....	62
3.4.5	Additional white gaussian noise ("AWGN" block).....	63
3.4.6	"I/Q stream mapper" block.....	63
3.4.7	I/Q modulator ("I/Q mod" block).....	63
3.4.8	RF ("RF" block).....	63
3.4.9	Applications examples of the R&S SMCV100B.....	63
3.5	Instrument control.....	64
3.5.1	Possible ways to operate the instrument.....	64
3.5.2	Means of manual interaction.....	64
3.5.3	Understanding the display information.....	65
3.5.4	Accessing the functionality.....	70
3.5.5	Entering data.....	71
3.5.6	Getting information and help.....	72

3.5.7	Remote control.....	74
3.5.8	Remote operation over VNC.....	74
4	Configuring internal baseband signals.....	75
4.1	Overview of the signal generation modes.....	75
4.2	Accessing the functions in the baseband domain.....	76
4.3	Generating signals according to broadcast standards.....	77
4.4	Common functions and settings in the baseband domain.....	80
4.4.1	Basics on signals, modulation types and filters.....	80
4.4.2	Common settings.....	100
4.5	Generating custom digital modulated signals.....	106
4.5.1	Required options.....	106
4.5.2	About the custom digital modulation.....	106
4.5.3	Custom digital modulation settings.....	107
4.5.4	How to create data and control lists.....	124
4.5.5	References.....	127
4.6	Using the arbitrary waveform generator (ARB).....	137
4.6.1	Required options.....	137
4.6.2	About ARB.....	138
4.6.3	ARB settings.....	143
4.6.4	How to create, generate and play waveform files.....	152
4.6.5	How to work with waveform libraries.....	168
4.6.6	How to stream waveforms from an external storage device.....	171
4.6.7	Tags for waveforms, data and control lists.....	173
4.7	Reducing the crest factor.....	190
4.8	Generating multi-segment waveform files.....	190
4.8.1	Required options.....	191
4.8.2	About the multi-segment waveforms.....	191
4.8.3	Multi-segment settings.....	196
4.8.4	How to create and work with multi-segment waveform files.....	212
4.8.5	Reference to triggering of multi-segment waveforms.....	217
4.9	Generating multi-carrier signals.....	220
4.9.1	Required options.....	221
4.9.2	About the multi-carrier waveforms.....	221

4.9.3	Multi-carrier settings.....	223
4.9.4	How to use the multi-carrier function.....	235
4.10	Generating FM/PhiM/AM/Pulse modulation signals.....	238
4.10.1	FM/PhiM/AM configuration and settings.....	238
4.10.2	Pulse modulation configuration and settings.....	242
4.11	Shifting and boosting the baseband signal.....	244
4.11.1	About baseband offsets.....	244
4.11.2	Baseband offsets settings.....	247
4.11.3	How to improve signal characteristics by shifting the baseband signal.....	248
5	Configuring external baseband signals.....	249
5.1	Overview of the input and output signals and interfaces.....	249
5.1.1	Overview of the baseband signal sources.....	250
5.1.2	Overview of the baseband and RF output signals.....	250
5.1.3	Interdependencies.....	251
5.1.4	Important signal parameters and interface's characteristics.....	251
5.2	System configuration settings.....	254
5.2.1	I/Q stream mapper settings.....	254
5.2.2	External RF and I/Q settings.....	255
5.2.3	Overview.....	266
5.3	Digital baseband input settings.....	267
5.3.1	General settings.....	269
5.3.2	Signal input settings.....	270
5.4	I/Q digital output settings.....	272
5.4.1	General settings.....	273
5.4.2	Channels settings.....	275
5.4.3	Signal output settings.....	277
5.5	Generating time-aligned baseband signals.....	278
5.5.1	Triggering several instruments with a common trigger signal.....	278
6	Adding noise to and impairing the signal.....	280
6.1	Adding noise to the signal.....	280
6.1.1	Required options.....	280
6.1.2	About the AWGN generator.....	280
6.1.3	AWGN block.....	284

6.1.4	AWGN settings.....	285
6.1.5	How to configure the noise generator for receiver tests.....	292
6.2	Impairing the signal.....	294
6.2.1	Required options.....	294
6.2.2	About the linear I/Q impairments.....	294
6.2.3	Digital impairments settings.....	296
7	Applying I/Q vector modulation.....	298
7.1	Required options.....	298
7.2	About the I/Q modulator.....	298
7.3	I/Q modulator settings.....	298
7.4	Optimizing I/Q modulation performance.....	301
8	Configuring the RF signal.....	302
8.1	Required options.....	303
8.2	How to access the RF settings.....	303
8.3	How to activate the RF signal output.....	303
8.4	How to set the frequency and level.....	304
8.5	RF frequency settings.....	306
8.6	RF level settings.....	308
8.7	RF phase settings.....	311
8.8	Reference oscillator.....	312
8.8.1	Required options.....	312
8.8.2	Reference frequency settings.....	312
8.8.3	Reference output settings.....	315
8.8.4	Adjustment settings.....	316
8.9	Varying the RF signal in list or sweep mode.....	317
8.9.1	Signal generation and triggering in the sweep and list modes.....	318
8.9.2	About sweep mode.....	326
8.9.3	About list mode.....	329
8.9.4	Significant parameters and functions.....	330
8.9.5	Sweep mode settings.....	333
8.9.6	List mode settings.....	341
8.9.7	List editor.....	347
8.9.8	How to generate a signal in list or sweep mode.....	351

8.10	Improving level performance.....	352
8.10.1	Attenuator.....	353
8.10.2	User correction.....	355
8.10.3	Using power sensors.....	367
8.10.4	To calibrate the power level with an R&S NRP power sensor.....	383
9	Configuring a multi-instrument setup.....	387
9.1	Synchronizing instruments.....	387
9.2	Connecting to R&S SMW.....	387
9.3	Configuring the setup.....	389
9.4	Multi-instrument settings.....	392
10	Monitoring signal characteristics.....	394
10.1	Displaying baseband signal characteristics in real-time.....	394
10.1.1	Required options.....	394
10.1.2	About the graphical signal display.....	394
10.1.3	Graphics configuration settings.....	401
10.1.4	Graphical signal display settings.....	405
10.1.5	How to verify the generated signal with the graphics display.....	406
11	File and data management.....	413
11.1	About the file system.....	413
11.2	Restoring the (default) instrument configuration.....	416
11.2.1	Preset, set to default and factory preset settings.....	418
11.2.2	How to identify parameters which are not in a preset state.....	418
11.2.3	How to recall user settings automatically after preset.....	419
11.2.4	Reference.....	420
11.3	Protecting data.....	420
11.4	Saving and recalling instrument settings.....	421
11.4.1	Save/recall settings.....	422
11.4.2	How to save and recall instrument settings.....	425
11.5	Accessing files with user data.....	426
11.5.1	File select settings.....	426
11.6	Exporting and importing remote command lists.....	428
11.7	Loading, importing and exporting lists.....	428

11.8	Using the file manager.....	428
11.8.1	File manager settings.....	429
11.8.2	Map network share settings.....	430
11.8.3	How to display all saved files.....	432
11.8.4	How to map a network folder.....	432
11.9	How to transfer files from and to the instrument.....	434
11.9.1	Removing file system protection.....	435
11.9.2	Accessing the file system of the R&S SMCV100B over FTP.....	436
11.9.3	Accessing the R&S SMCV100B file system using SMB (Samba).....	437
11.9.4	Using a USB storage device for file transfer.....	439
11.9.5	Using a file server for test files exchange.....	439
11.10	Creating screenshots of current settings.....	440
11.10.1	Hardcopy settings.....	440
11.10.2	How to save a hardcopy of the display.....	443
12	General instrument functions.....	444
12.1	Customizing the user interface.....	444
12.1.1	Display and keyboard settings.....	445
12.1.2	Display update settings.....	446
12.1.3	Defining the RF signal state on power on.....	447
12.1.4	How to set the initial instrument settings.....	448
12.2	Configuring global connectors.....	449
12.2.1	Required options.....	449
12.2.2	About global connectors.....	449
12.2.3	Trigger marker clock settings.....	451
12.2.4	RF connectors settings.....	453
12.2.5	Global connectors settings.....	454
12.2.6	How to enable signals and perform signal to connector mapping.....	457
12.3	Checking parameters and dependencies.....	458
12.4	Organizing frequently used settings as favorites.....	460
12.4.1	User menu settings.....	461
12.4.2	How to use the user menu for fast adjustments.....	462
12.4.3	Define user key actions settings.....	464
12.4.4	How to assign actions to the [★ (User)] key.....	465

12.5	Managing licenses and license keys.....	466
12.5.1	Manage license keys settings.....	466
12.5.2	Using the license server.....	470
12.5.3	How to move a portable license.....	479
12.6	Using the security settings.....	481
12.6.1	Protection level settings.....	482
12.6.2	Setting security parameters.....	483
12.6.3	Configuring LAN services.....	488
12.6.4	Password management.....	491
12.6.5	How to prevent unauthorized access.....	493
12.7	Undoing or restoring actions.....	496
12.8	Shutting down and rebooting the instrument.....	498
13	Network operation and remote control.....	499
13.1	Overview of remote access modes.....	500
13.2	Remote control interfaces and protocols.....	501
13.2.1	LAN interface.....	502
13.2.2	LXI browser interface.....	503
13.3	Remote control programs and libraries.....	504
13.4	Status reporting system.....	507
13.4.1	Hierarchy of the status registers.....	507
13.4.2	Structure of a SCPI status register.....	509
13.4.3	Status byte (STB) and service request enable register (SRE).....	511
13.4.4	Event status register (ESR) and event status enable register (ESE).....	512
13.4.5	Questionable status register (STATus:QUESTionable).....	513
13.4.6	Operation status register (STATus:OPERation).....	513
13.4.7	Application of the status reporting system.....	513
13.4.8	Reset values of the status reporting system.....	515
13.5	Remote access settings.....	516
13.5.1	Network settings.....	518
13.5.2	VISA resource strings.....	521
13.5.3	Instrument emulations settings.....	522
13.5.4	Remote connections settings.....	523
13.5.5	HUMS settings.....	525

13.5.6	HUMS enhanced settings.....	527
13.5.7	QR code.....	535
13.6	LXI settings.....	536
13.6.1	LXI status settings.....	536
13.6.2	LXI browser settings.....	537
13.7	To configure the instrument for remote access.....	543
13.7.1	To find the VISA resource string.....	543
13.7.2	To configure the acces over LAN.....	544
13.8	To establish a remote control session over LAN.....	547
13.8.1	To establish the connection with the LXI web browser.....	548
13.8.2	To establish the connection using VXI-11 protocol.....	548
13.8.3	To establish the connection using socket communication.....	553
13.9	To trace messages with the LXI web browser interface.....	554
13.10	To return to manual operation.....	555
13.11	To automate tasks with remote command scripts.....	555
13.11.1	Show SCPI command.....	558
13.11.2	Displaying an SCPI list.....	558
13.11.3	SCPI recording export settings.....	559
13.11.4	How to record / create SCPI lists.....	560
13.11.5	How to convert and save SCPI lists.....	563
13.11.6	How to find out the SCPI commands for GUI functions.....	564
13.12	To operate the instrument using VNC.....	565
13.12.1	How to enable the VNC service.....	565
13.12.2	How to set up remote operation from a desktop system.....	566
13.12.3	How to set up remote operation from a smart device.....	568
13.13	References.....	571
13.13.1	LXI functionality.....	571
13.13.2	Code generator templates.....	571
13.13.3	Remote control states.....	573
14	Remote control commands.....	574
14.1	Conventions used in SCPI command descriptions.....	574
14.2	Programming examples.....	575
14.3	Common commands.....	575

14.4	Preset commands	580
14.5	MMEMory subsystem	581
14.5.1	File naming conventions.....	582
14.5.2	Accessing files in the default or in a specified directory.....	583
14.5.3	Programming examples.....	584
14.5.4	Remote control commands.....	586
14.6	CALibration subsystem	592
14.7	DIAGnostic subsystem	596
14.8	HUMS remote control commands	599
14.9	DISPlay subsystem	606
14.10	FORMat subsystem	611
14.11	HCOPy subsystem	612
14.11.1	Hard copy settings.....	613
14.11.2	Automatic naming.....	615
14.12	KBOard subsystem	617
14.13	OUTPut subsystem	618
14.14	SENSe, READ, INITiate and SLISt subsystems	621
14.15	SCONfiguration subsystem	635
14.15.1	Multi instrument configuration.....	638
14.15.2	I/Q stream mapping.....	639
14.15.3	External RF and I/Q instruments.....	640
14.16	SOURce subsystem	649
14.16.1	Connector settings.....	649
14.16.2	SOURce:BBIN subsystem.....	653
14.16.3	SOURce:BB subsystem.....	660
14.16.4	SOURce:CORRection subsystem.....	751
14.16.5	SOURce:FREQUency subsystem.....	759
14.16.6	SOURce:INPut subsystem.....	765
14.16.7	SOURce:IQ subsystem.....	765
14.16.8	SOURce:IQ:OUTPut subsystem.....	766
14.16.9	SOURce:LIST subsystem.....	771
14.16.10	SOURce:PHASe subsystem.....	784
14.16.11	SOURce:POWer subsystem.....	785

14.16.12	SOURce:ROSCillator subsystem.....	796
14.16.13	SOURce:SWEEP subsystem.....	800
14.17	SYSTem subsystem.....	808
14.18	STATus subsystem.....	831
14.19	TEST subsystem.....	835
14.20	TRIGger subsystem.....	836
14.21	UNIT subsystem.....	838
15	Troubleshooting and notifications.....	840
15.1	Notifications.....	840
15.1.1	Volatile notifications.....	840
15.1.2	Permanent notifications.....	841
15.2	SCPI notifications.....	841
15.3	Device-specific notifications.....	841
15.4	Querying notifications.....	843
15.5	Resolving network connection failures.....	845
15.6	Resolving errors during internal adjustments.....	845
15.7	Measuring USB cable quality.....	846
15.8	Requesting instrument configuration and specifications.....	847
15.8.1	Hardware configuration settings.....	847
15.8.2	Versions/options settings.....	848
15.8.3	How to query instrument configuration.....	850
15.9	Collecting information for technical support.....	851
15.10	Contacting customer support.....	852
16	Transporting.....	854
17	Maintenance, storage and disposal.....	855
17.1	Cleaning.....	855
17.2	Storage.....	855
17.3	Performing maintenance tasks.....	855
17.3.1	Date and time.....	856
17.3.2	Check front panel.....	858
17.3.3	Internal adjustments.....	860
17.3.4	Selftest.....	865

17.3.5	FPGA/uC update settings.....	868
17.4	Disposal.....	870
	Annex.....	871
A	Reference.....	871
A.1	Extensions for user files.....	871
A.2	Unit shortcuts.....	871
	Glossary: List of the often used terms and abbreviations.....	874
	List of remote commands (base unit).....	879
	Index.....	895

1 Safety and regulatory information

The product documentation helps you use the product safely and efficiently. Follow the instructions provided here and in the following chapters.

Intended use

The product generates radio frequency (RF) signals for the development, production and verification of electronic components, modules or devices. The product is intended for industrial use, for example for production and conformance testing, maintenance and engineering laboratories.

Use the product only for its designated purpose. Any other use is considered improper use. Observe the operating conditions and performance limits stated in the data sheet.

Target audience

This document targets at all users, including technicians, operators, administrators and maintenance personnel. The required skills and experience of the users depend on the test setup and application of the product.

Where do I find safety information?

Safety information is part of the product documentation. It warns you of potential dangers and gives instructions on how to prevent personal injury or damage caused by dangerous situations. Safety information is provided as follows:

- In [Chapter 1.1, "Safety instructions"](#), on page 15. The same information is provided in many languages as printed "Safety Instructions". The printed "Safety Instructions" are delivered with the product.
- Throughout the documentation, safety instructions are provided when you need to take care during setup or operation.

1.1 Safety instructions

Products from the Rohde & Schwarz group of companies are manufactured according to the highest technical standards. To use the products safely, follow the instructions provided here and in the product documentation. Keep the product documentation nearby and offer it to other users.

Use the product only for its intended use and within its performance limits. Intended use and limits are described in the product documentation such as the data sheet, manuals and the printed "Safety Instructions". If you are unsure about the appropriate use, contact Rohde & Schwarz customer service.

Using the product requires specialists or specially trained personnel. These users also need sound knowledge of at least one of the languages in which the user interfaces and the product documentation are available.

Reconfigure or adjust the product only as described in the product documentation or the data sheet. Any other modifications can affect safety and are not permitted.

Never open the casing of the product. Only service personnel authorized by Rohde & Schwarz are allowed to repair the product. If any part of the product is damaged or broken, stop using the product. Contact Rohde & Schwarz customer service at <https://www.rohde-schwarz.com/support>.

Lifting and carrying the product

The maximum weight of the product is provided in the data sheet. You can lift or carry the product by yourself, if you can manage the weight on your own. Alternatively, you can use lifting or transporting equipment. Follow the instructions provided by the equipment manufacturer.

Choosing the operating site

Only use the product indoors. The product casing is not waterproof. Water that enters can electrically connect the casing with live parts, which can lead to electric shock, serious personal injury or death if you touch the casing. If Rohde & Schwarz provides accessories designed for your product, e.g. a carrying bag, you can use the product outdoors.

Unless otherwise specified, you can operate the product up to an altitude of 2000 m above sea level. The product is suitable for pollution degree 2 environments where nonconductive contamination can occur. For more information on environmental conditions such as ambient temperature and humidity, see the data sheet.

Setting up the product

Always place the product on a stable, flat and level surface with the bottom of the product facing down. If the product is designed for different positions, secure the product so that it cannot fall over.

If the product has foldable feet, always fold the feet completely in or out to ensure stability. The feet can collapse if they are not folded out completely or if the product is moved without lifting it. The foldable feet are designed to carry the weight of the product, but not an extra load.

If stacking is possible, keep in mind that a stack of products can fall over and cause injury.

If you mount products in a rack, ensure that the rack has sufficient load capacity and stability. Observe the specifications of the rack manufacturer. Always install the products from the bottom shelf to the top shelf so that the rack stands securely. Secure the product so that it cannot fall off the rack.

Connecting to power

The product is an overvoltage category II product. Connect the product to a fixed installation used to supply energy-consuming equipment such as household appliances and similar loads. Keep in mind that electrically powered products have risks, such as electric shock, fire, personal injury or even death. Replace parts that are relevant to safety only by original parts, e.g. power cables or fuses.

Take the following measures for your safety:





- Before switching on the product, ensure that the voltage and frequency indicated on the product match the available power source. If the power adapter does not adjust automatically, set the correct value and check the rating of the fuse.
- Only use the power cable delivered with the product. It complies with country-specific safety requirements. Only insert the plug into an outlet with protective conductor terminal.
- Only use intact cables and route them carefully so that they cannot be damaged. Check the power cables regularly to ensure that they are undamaged. Also ensure that nobody can trip over loose cables.
- If you connect the product to an external power supply, use the one delivered with the product or recommended in the product documentation. The external power supply must conform to the country-specific regulations.
- Only connect the product to a power source with a fuse protection of maximum 20 A.
- Ensure that you can disconnect the product from the power source at any time. Pull the power plug to disconnect the product. The power plug must be easily accessible. If the product is integrated into a system that does not meet these requirements, provide an easily accessible circuit breaker at the system level.

Cleaning the product

Use a dry, lint-free cloth to clean the product. When cleaning, keep in mind that the casing is not waterproof. Do not use liquid cleaning agents.

Meaning of safety labels

Safety labels on the product warn against potential hazards.

	<p>Potential hazard</p> <p>Read the product documentation to avoid personal injury or product damage.</p>
	<p>Electrical hazard</p> <p>Indicates live parts. Risk of electric shock, fire, personal injury or even death.</p>
	<p>Hot surface</p> <p>Do not touch. Risk of skin burns. Risk of fire.</p>
	<p>Protective conductor terminal</p> <p>Connect this terminal to a grounded external conductor or to protective ground. This connection protects you against electric shock if an electric problem occurs.</p>

1.2 Labels on R&S SMCV100B

Labels on the casing inform about:

- Personal safety, see "[Connecting to power](#)" on page 16.

- Product and environment safety, see [Table 1-1](#).
- Identification of the product, see the serial number on the [rear panel](#).

Table 1-1: Labels regarding R&S SMCV100B and environment safety

	Labeling in line with EN 50419 for disposal of electrical and electronic equipment after the product has come to the end of its service life. For more information, see Chapter 17.4, "Disposal" , on page 870.
---	---

1.3 Warning messages in the documentation

A warning message points out a risk or danger that you need to be aware of. The signal word indicates the severity of the safety hazard and how likely it will occur if you do not follow the safety precautions.

WARNING

Potentially hazardous situation. Could result in death or serious injury if not avoided.

CAUTION

Potentially hazardous situation. Could result in minor or moderate injury if not avoided.

NOTICE

Potential risks of damage. Could result in damage to the supported product or to other property.

1.4 Where to find key documents on Rohde & Schwarz

Certificates issued to Rohde & Schwarz that are relevant for your country are provided at www.rohde-schwarz.com/key-documents, e.g. concerning:

- Quality management
- Environmental management
- Information security management
- Accreditations

1.5 Korea certification class B



이 기기는 가정용(B급) 전자파 적합기기로서 주로 가정에서 사용하는 것을 목적으로 하며, 모든 지역에서 사용할 수 있습니다.

2 Welcome

The R&S SMCV100B vector signal generator features a new Direct-RF DAC concept for RF signal generation. This concept enables I/Q modulation and up-conversion in the digital domain which eliminates I and Q imbalance errors and LO leakage as known from traditional analog I/Q modulators.

The R&S SMCV100B options concept is fully software defined. You can fully upgrade the R&S SMCV100B without installation of additional hardware options. Upgrading also includes the upgrade of the RF frequency, memory, I/Q modulation bandwidth and all further R&S SMCV100B options for the whole variety of applications.

The intuitive, touchscreen-based operating concept makes the R&S SMCV100B ergonomic and practical to use. Thanks to its design for flexible customization, the instrument is prepared to meet future requirements. Options can be easily added via software key codes, allowing customers to upgrade additional functionalities like bandwidth, output power or even frequency range according to their requirements.

2.1 Key features

Outstanding key features of the R&S SMCV100B are:

- First multi-standard platform for broadcast, navigation, cellular and wireless applications
- Fully software-defined vector signal generator
- Modern RF signal generation concept from 8 kHz to 7.125 GHz
- High RF output power of up to 25 dBm
- Modulation bandwidth up to 240 MHz with internal baseband
- Powerful internal baseband generator with internal broadcast real-time coder, Custom Digital Modulation and internal baseband signal generation with ARB
- Support of various broadcast standards covering multiple fields of application:
 - Terrestrial broadcast: ATSC 3.0, ATSC-M/H, DTMB, DVB-T2, DVB-T, ISDB-T, ISDB-T_{SB}, T-DMB/DAB
 - Satellite broadcast: DVB-S2, DVB-S
 - Cable broadcast: DVB-C, J.83/B
 - Audio broadcast: DRM/DRM+, Audio AM/FM, RDS/RDBS/DARC
- Support of digital standard waveforms such as 5G NR, LTE including eMTC/NB-IoT, WLAN IEEE 802.11a/b/g/n/j/p/ac/ax/be, GNSS
- Intuitive operation via 5" touchscreen with block diagram as key element
- Graphical signal monitoring at practically every point in the signal flow
- SCPI macro recorder and code generator for generating executable remote control code from manual operating steps (for MATLAB®, CVI, etc.)
- Easily extendable with software options
- Full remote compatibility with R&S SFE/R&S SFE100

For more information, see data sheet.

2.2 What's new

This manual describes firmware version FW 5.20.043.xx and later of the R&S®SMCV100B.

Compared to the previous version, the documentation of firmware version FW 5.20.043.xx provides the new features listed below:

- Telemetry SOQPSK-TG modulation and related settings added for custom digital modulation, see "[Set according to Standard](#)" on page 109 and [Table 4-5](#).
- Checking parameter and settings dependencies, see [Chapter 12.3, "Checking parameters and dependencies"](#), on page 458.
- HUMS settings including device tags and enhanced protocol settings, see [Chapter 13.5.5, "HUMS settings"](#), on page 525 and [Chapter 13.5.6, "HUMS enhanced settings"](#), on page 527.
- NRP closed loop power control to achieve a constant input power at the DUT in real time, see [Chapter 8.10.3.3, "NRP power control"](#), on page 372.
- Delayed internal adjustment settings to start the internal adjustments at a specified time and automatic shut-down of the instrument when completed, see [Chapter 17.3.3.2, "Delayed adjustment settings"](#), on page 862.
- Recommendations updated for connecting USB devices to the front panel USB connectors and rear panel USB connectors, see [Chapter 3.1.9, "Connecting USB devices"](#), on page 29.
- Editorial changes

2.3 Documentation overview

This section provides an overview of the R&S SMCV100B user documentation. Unless specified otherwise, you find the documents at:

www.rohde-schwarz.com/manual/smcv100b

2.3.1 Getting started manual

Introduces the R&S SMCV100B and describes how to set up and start working with the product. Includes basic operations, typical measurement examples, and general information, e.g. safety instructions, etc. A printed version is delivered with the instrument.

2.3.2 User manuals and help

Separate manuals for the base unit and the software options are provided for download:

- **Base unit manual**
Contains the description of all instrument modes and functions. It also provides an introduction to remote control, a complete description of the remote control commands with programming examples, and information on maintenance, instrument interfaces and error messages. Includes the contents of the getting started manual.
- **Software option manual**
Contains the description of the specific functions of an option. Basic information on operating the R&S SMCV100B is not included.

The contents of the user manuals are available as help in the R&S SMCV100B. The help offers quick, context-sensitive access to the complete information for the base unit and the software options.

All user manuals are also available for download or for immediate display on the Internet.

2.3.3 Service manual

Describes the performance test for checking compliance with rated specifications, firmware update, troubleshooting, adjustments, installing options and maintenance.

The service manual is available for registered users on the global Rohde & Schwarz information system (GLORIS):

<https://gloris.rohde-schwarz.com>

2.3.4 Instrument security procedures

Deals with security issues when working with the R&S SMCV100B in secure areas. It is available for download on the internet.

2.3.5 Printed safety instructions

Provides safety information in many languages. The printed document is delivered with the product.

2.3.6 Data sheets and brochures

The data sheet contains the technical specifications of the R&S SMCV100B. It also lists the options and their order numbers and optional accessories.

The brochure provides an overview of the instrument and deals with the specific characteristics.

See www.rohde-schwarz.com/brochure-datasheet/smcv100b

2.3.7 Release notes and open source acknowledgment (OSA)

The release notes list new features, improvements and known issues of the current firmware version, and describe the firmware installation.

The software makes use of several valuable open source software packages. An open-source acknowledgment document provides verbatim license texts of the used open source software.

See www.rohde-schwarz.com/firmware/smcv100b

2.3.8 Application notes, application cards, white papers, etc.

These documents deal with special applications or background information on particular topics.

See www.rohde-schwarz.com/application/smcv100b

2.3.9 Videos

Find various videos on Rohde & Schwarz products and test and measurement topics on YouTube: <https://www.youtube.com/@RohdeundSchwarz>

3 Getting started

This chapter contains the same information as the getting started manual.

3.1 Preparing for use

Here, you can find basic information about setting up the product for the first time.

3.1.1 Lifting and carrying

See "[Lifting and carrying the product](#)" on page 16.

3.1.2 Unpacking and checking

1. Unpack the R&S SMCV100B carefully.
2. Retain the original packing material. Use it to protect the control elements and connectors when transporting or shipping the R&S SMCV100B later.
See also [Chapter 16, "Transporting"](#), on page 854.
3. Using the delivery notes, check the equipment for completeness.
4. Check the equipment for damage.

If the delivery is incomplete or equipment is damaged, contact Rohde & Schwarz.

3.1.3 Choosing the operating site

Specific operating conditions ensure proper operation and avoid damage to the product and connected devices. For information on environmental conditions such as ambient temperature and humidity, see the data sheet.

For safety information, see "[Choosing the operating site](#)" on page 16.

Electromagnetic compatibility classes

The electromagnetic compatibility (EMC) class indicates where you can operate the product. The EMC class of the product is given in the data sheet.

- Class B equipment is suitable for use in:
 - Residential environments
 - Environments that are directly connected to a low-voltage supply network that supplies residential buildings

- Class A equipment is intended for use in industrial environments. It can cause radio disturbances in residential environments due to possible conducted and radiated disturbances. It is therefore not suitable for class B environments. If class A equipment causes radio disturbances, take appropriate measures to eliminate them.

3.1.4 Setting up the R&S SMCV100B

See also:

- ["Setting up the product"](#) on page 16
- ["Intended use"](#) on page 15

3.1.4.1 Placing the R&S SMCV100B on a bench top

To place the product on a bench top

1. Place the product on a stable, flat and level surface. Ensure that the surface can support the weight of the product. For information on the weight, see the data sheet.
2. **CAUTION!** Foldable feet can collapse. For safety information, see ["Setting up the product"](#) on page 16.

Always fold the feet completely in or out. With folded-out feet, do not place anything on top or underneath the product.

3. **WARNING!** A stack of products can fall over and cause injury. Never stack more than three products on top of each other. Instead, mount them in a rack.

Stack as follows:

- If the products have foldable feet, fold them in completely.
- All products must have the same dimensions (width and length).
- Do not exceed a total load of 50 kg placed on the product at the bottom of the stack.

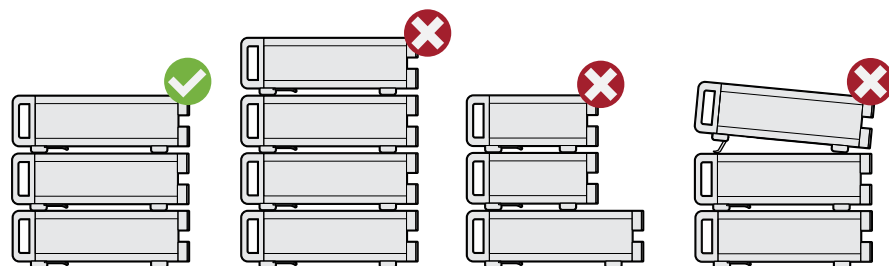

- Left = Stacked correctly
 Middle left = Stacked incorrectly, too many products
 Middle right = Stacked incorrectly, different dimensions
 Right = Stacked incorrectly, folded-out feet

4. **NOTICE!** Overheating can damage the product.

Prevent overheating as follows:

- Keep a minimum distance of 10 cm between the fan openings of the product and any object in the vicinity to provide sufficient airflow and ventilation.
- Do not place the product next to heat-generating equipment such as radiators or other products.

3.1.4.2 Mounting the R&S SMCV100B in a rack

To prepare the rack

1. Observe the requirements and instructions in "[Setting up the product](#)" on page 16.
2. **NOTICE!** Insufficient airflow can cause overheating and damage the product. Design and implement an efficient ventilation concept for the rack.

To mount the R&S SMCV100B in a rack

1. Use an adapter kit that fits the dimensions of the R&S SMCV100B to prepare the instrument for rack mounting.
 - a) Order the rack adapter kit designed for the R&S SMCV100B. For the order number, see the data sheet.
 - b) Mount the adapter kit. Follow the assembly instructions provided with the adapter kit.
2. Lift the R&S SMCV100B to shelf height.
3. Push the R&S SMCV100B onto the shelf until the rack brackets fit closely to the rack.
4. Tighten all screws at the rack brackets with a tightening torque of 1.2 Nm to secure the R&S SMCV100B in the rack.

To unmount the R&S SMCV100B from a rack

1. Loosen the screws at the rack brackets.
2. Bring the lifting equipment to shelf height.
3. Remove the R&S SMCV100B from the rack.
4. If placing the R&S SMCV100B on a bench top again, unmount the adapter kit from the R&S SMCV100B. Follow the instructions provided with the adapter kit.

3.1.5 Considerations for test setup

Cable selection and electromagnetic interference (EMI)

Electromagnetic interference (EMI) can affect the measurement results.

To suppress electromagnetic radiation during operation:

- Use high-quality shielded cables, especially for the following connector types:
 - BNC
Double-shielded BNC cables.
How to: ["To connect to pluggable connectors"](#) on page 30
 - USB
Double-shielded USB cables.
How to: [Chapter 3.1.9, "Connecting USB devices"](#), on page 29.
 - LAN
At least CAT6 STP cables.
How to: [Chapter 3.1.7, "Connecting to LAN"](#), on page 27
- Always terminate open cable ends.
- Ensure that connected external devices comply with EMC regulations.
- Use the cable R&S DIGIQ-HS for connection to the Dig. IQ HS x interfaces of the instrument. The cable is available under order number 3641.2948.03.
How to: [Chapter 3.1.13, "Connecting to Dig. IQ HS x"](#), on page 31
- Use an SFP+ to RJ-45 adapter and an RJ-45 cable for connection to the IP Data interface of the instrument. We recommend that you use the adapter "FCLF850P2BTL" from Finisar available under order number 3627.0570.00.
How to: [Chapter 3.1.14, "Connecting to IP Data"](#), on page 32

Signal input and output levels

Information on signal levels is provided in the data sheet. Keep the signal levels within the specified ranges to avoid damage to the R&S SMCV100B and connected devices.

3.1.6 Connecting to power

For safety information, see ["Connecting to power"](#) on page 16.

1. Plug the AC power cable into the AC power connector on the rear panel. Only use the AC power cable delivered with the R&S SMCV100B.
2. Plug the AC power cable into a power outlet with ground contact.
The required ratings are listed next to the AC power connector and in the data sheet.

3.1.7 Connecting to LAN

Network environment

Before connecting the product to a local area network (LAN), consider the following:

- Install the latest firmware to reduce security risks.
- For internet or remote access, use secured connections if applicable.

- Ensure that the network settings comply with the security policies of your company. Contact your local system administrator or IT department before connecting your product to your company LAN.
- When connected to the LAN, the product may potentially be accessed from the internet, which may be a security risk. For example, attackers might misuse or damage the product.

To connect to LAN

- ▶ Connect the LAN socket on the rear panel via an RJ-45 cable to the LAN. Using DHCP (dynamic host configuration protocol), the R&S SMCV100B assigns the IP address automatically.

If connected to the LAN, the R&S SMCV100B displays the IP address at the left bottom of the block diagram.

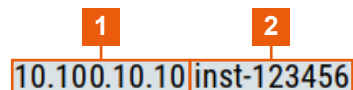

10.100.10.10 inst-123456

1 = IP address
2 = Hostname

If disconnected from the LAN, the R&S SMCV100B displays the IP address 0.0.0.0.

See also [Chapter 13.7, "To configure the instrument for remote access"](#), on page 543.

3.1.8 Connecting a monitor

This section describes how to connect a monitor for direct operation of the R&S SMCV100B. You can skip the following procedure, if you only operate the R&S SMCV100B remotely.

1. Connect the monitor to the "Display Port" socket of the R&S SMCV100B on the rear panel.
The "Display Port" socket does not support dual-mode Display Port (DP++). Use an active adapter if you connect to HDMI cables, for example.
2. At the monitor, connect the cable to one of the following sockets:
 - Display Port: Connect it to the Display Port socket of the monitor.
 - HDMI: You need an active adapter Display Port to HDMI. Passive adapters do not work.
 - VGA: You need an active adapter, Display Port to VGA. Passive adapters do not work.

If the monitor provides touch functionality, an additional connection can be required, for example, a USB connection. Refer to the documentation of your monitor.

3.1.9 Connecting USB devices

You can connect or disconnect all USB devices from the R&S SMCV100B during operation.

To connect USB storage devices

USB storage devices, such as memory sticks, allow data transfer from or to the R&S SMCV100B. You can also use them for firmware updates.

- ▶ Connect the USB storage device to the USB type A connector on the front panel. Connect the device directly, without connecting cable. Connecting cables can cause electromagnetic radiation and impair a measurement result.

To connect USB devices with external power supply

1. **NOTICE!** Connected devices with external power supply can feed back current into the 5 V power supply of the USB interface and thus damage the R&S SMCV100B. Ensure that there is no connection between the positive pole of the power supply and the +5 V power pin of the USB interface (VBUS).
2. Connect the USB storage device to a USB connector on the rear panel.

To connect a keyboard

- ▶ Connect the keyboard to a USB connector on the rear panel.

When connected, the R&S SMCV100B detects the keyboard automatically. A detected keyboard has the default layout English – US.

To connect a mouse

- ▶ Connect the mouse to a USB connector on the rear panel.

When connected, the R&S SMCV100B detects the mouse automatically.

To connect power sensors

Connect power sensors of the R&S NRP families to a USB connector on the rear panel.

See [Chapter 8.10.3, "Using power sensors"](#), on page 367.

3.1.10 Connecting to RF coaxial connectors

Here, you find information on how to prepare and to connect to RF coaxial connectors of the R&S SMCV100B. Use these RF connectors, for example, for output of the RF signal or for input of an external reference signal.

To prepare for connecting

1. **NOTICE!** Damaged or not clean connections can lead to RF insertion loss and mismatch, and even premature wear of the connectors.
Before connecting to the port, inspect the RF connector visually. Check that it is clean, undamaged and mechanically compatible.
2. **NOTICE!** DC voltage at the RF connector can damage the instrument. Never apply DC voltage to the RF input connectors.
Make sure that the values are within the DC limits given in the data sheet.
3. If your test setup has a DC component at the RF input, insert a DC blocker.
4. Use a high-quality RF cable that matches the RF connector type.
See "[Cable selection and electromagnetic interference \(EMI\)](#)" on page 26.
5. You can connect to two kinds of connectors:
 - "[To connect to screwable connectors](#)" on page 30
 - "[To connect to pluggable connectors](#)" on page 30

To connect to screwable connectors

The R&S SMCV100B provides screwable RF connectors as in [Table 3-1](#).

- **NOTICE!** Excessive tightening can damage the connectors.

To connect the cable with the connector, proceed as follows:

- a) Carefully align the connector of the cable and the connector along a common axis.
- b) Mate the connectors along the common axis until the male pin of the inner connector engages with the female socket of the outer connector.
- c) Turn the nut of the outer connector until the connectors are firmly coupled.
- d) Using a calibrated torque wrench torque the nut to the limit as in the table below. Hold the opposite connector part stationary with a spanner.

Table 3-1: Connector name, type, size, torque limit and nut opening

Connector		Torque limit		Nut opening	
Type	Name	lb-Inch	Nm	Inch	mm
N	RF 50 Ω	13.3	1.5	3/4	20

To connect to pluggable connectors

The R&S SMCV100B provides pluggable Bayonet Neill-Concelman (BNC) connectors.

- To connect the RF cable with the BNC connector, proceed as follows:
- a) Carefully align the connector of the cable and the BNC connector along a common axis.
 - b) Mate the connectors along the common axis until the male pin of the connector of the cable engages with the female socket of the BNC connector.

For information on how to handle and maintain the RF port, to minimize measurement deviations and ensure its longevity, see the application note [1MA99](#).

If you want to mount test port adapters to your RF connector, see the application note [1MA100](#).

3.1.11 Connecting to RF 50 Ω

To connect to "RF 50 Ω "

1. Before connecting to the "RF 50 Ω " connector on the front panel, proceed as follows:
 - a) Prepare the "RF 50 Ω " connector. See ["To prepare for connecting"](#) on page 30.
 - b) If activated, deactivate the RF output. In the block diagram, select the block "RF" > "RF Level" > "RF On > Off".
2. Connect to the "RF 50 Ω " connector. See ["To connect to screwable connectors"](#) on page 30.

To prevent RF output switch-off

- ▶ **NOTICE!** If you set a too high output level without a load connected to the instrument, the reverse power can exceed a limit forcing the R&S SMCV100B to switch off the RF output.

Connect a load with sufficient return loss as given in the data sheet.

3.1.12 Connecting to Ref In/Ref Out

To connect to "Ref In"/"Ref Out"

For connection, the R&S SMCV100B provides BNC connectors (reference signal frequency $f_{\text{ref}} < 1$ GHz) or SMA connectors ($f_{\text{ref}} = 1$ GHz).

1. Before connecting, prepare the Ref In/Ref Out connectors on the rear panel. See ["To prepare for connecting"](#) on page 30.
2. Connect to the "Ref In"/"Ref Out" connectors:
 - $f_{\text{ref}} < 1$ GHz: ["To connect to pluggable connectors"](#) on page 30
 - $f_{\text{ref}} = 1$ GHz: ["To connect to screwable connectors"](#) on page 30

3.1.13 Connecting to Dig. IQ HS x

The Dig. IQ HS x connector comprises a QSFP+ (Quad Small Form-factor Pluggable) socket that has two components: a QSFP+ cage and a QSFP+ connector. The QSFP+ cable is equipped with the QSFP+ plug.

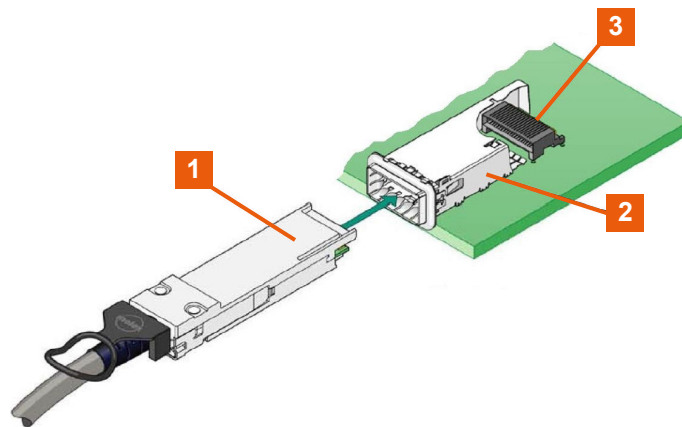

- 1 = QSFP+ plug
 2 = QSFP+ cage
 3 = QSFP+ connector

To connect to Dig. IQ HS x interface

1. For connection, use the QSFP+ cable R&S DIGIQ-HS.
 See "[Cable selection and electromagnetic interference \(EMI\)](#)" on page 26.
2. Hold the QSFP+ plug of the cable by its panes.
3. Turn the QSFP+ cable, so that the release tab shows upwards.
4. Insert and push the QSFP+ plug into the QSFP+ cage.

To disconnect from Dig. IQ HS x interface

1. **NOTICE!** If you pull the cable, you can damage the cable and the Dig. IQ HS x connector.
 Pull the release tab.
2. Pull the QSFP+ plug out of the QSFP+ cage.

See also:

- [Chapter 5.3, "Digital baseband input settings"](#), on page 267.
- [Chapter 5.4, "I/Q digital output settings"](#), on page 272.

3.1.14 Connecting to IP Data

The IP Data connector comprises an SFP+ (Small Form-factor Pluggable) socket that has two components an SFP+ cage and an SFP+ connector.

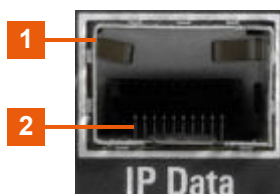

- 1 = SFP+ cage
- 2 = SFP+ connector

To connect to IP Data interface

1. For connection, use an SFP+ to RJ-45 adapter and an RJ-45 cable.
See "[Cable selection and electromagnetic interference \(EMI\)](#)" on page 26.

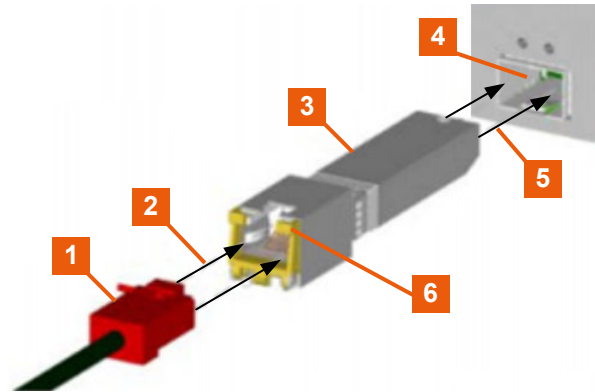

Figure 3-1: Connecting to the IP Data interface

- 1 = RJ-45 cable and plug
 - 2 = Axis of connection
 - 3 = SFP+ to RJ-45 adapter
 - 3a = Bracket for mounting and releasing the adapter
 - 4 = SFP+ socket of the IP Data connector
2. Connect the SFP+ to RJ-45 adapter to the SFP+ socket of the IP Data connector on the rear panel ([Connecting to the IP Data interface](#)).
 - a) Turn the adapter, so that the release bracket joints show upwards.
 - b) At the RJ-45 socket of the adapter, open the release bracket, so that the bracket shows upward.
 - c) Insert and push the adapter into the cage of the SFP+ socket of the IP Data connector.
 - d) To mount the adapter, push the release bracket down to close the bracket.
The adapter is connected to the IP Data connector.
 3. Plug the RJ-45 cable into the RJ-45 socket of the adapter.

To disconnect from IP Data interface

1. Unplug the RJ-45 cable.
2. Open the release bracket.
3. Carefully pull the SFP+ to RJ-45 adapter out of the SFP+ socket of the IP Data interface.

Use the IP Data interface as input of external coding IP data for broadcast baseband signals.

See also chapter "Local IP Data Network Settings" in the corresponding broadcast standard user manuals.

3.1.15 Switching on or off

The following table provides an overview of power states, LEDs and positions of the power switch.

Table 3-2: Overview of power states

State	LED	Position of power switch
Off	● gray	[0]
Standby	● orange	[I]
Ready	● green	[I]

To switch on the R&S SMCV100B

The R&S SMCV100B is off but connected to power. See [Chapter 3.1.6, "Connecting to power"](#), on page 27.

1. Set the switch on the power supply to position [I] on the rear panel.
The LED of the [On/Standby] key on the front panel is orange.
2. Wait until the oven-controlled oscillator (OCXO) warms up. For the warm-up time, see the data sheet.
3. Press the [On/Standby] key on the front panel.
The LED changes to green. The R&S SMCV100B boots.

After booting, the R&S SMCV100B starts up displaying the block diagram on the screen on the front panel.

To check start-up functions

When starting for the first time, the R&S SMCV100B starts with the default settings. When restarting, the R&S SMCV100B recalls the instrument configuration before shut-down.

See [Chapter 11.4, "Saving and recalling instrument settings"](#), on page 421.

When switched on, the R&S SMW automatically monitors main functions. You can query erroneous functions. In addition to automatic monitoring, you can perform maintenance tasks. See the following:

- [Chapter 15.4, "Querying notifications"](#), on page 843

To handle surges

Surges at the AC power connector can force a restart of the R&S SMCV100B. The R&S SMCV100B restarts with the instrument configuration of the last start-up and loses intermediate configurations. Save intermediate configurations, if needed. To

avoid instrument restart, make sure that peak power levels are within the specified ranges in the data sheet.

To shut down the product

The product is in the ready state.

- ▶ Press the [On/Standby] key.

The operating system shuts down. The LED changes to orange.

In the standby state, the power switch circuits and the OCXO are active. To deactivate them, disconnect the instrument from the power supply.

To disconnect from power

The R&S SMCV100B is in the standby state.

1. **NOTICE!** Risk of data loss. If you disconnect the product from power when it is in the ready state, you can lose settings and data. Shut it down first.
Set the toggle switch on the power supply to position [0].
The LED of the [On/Standby] key is switched off.
2. Disconnect the R&S SMCV100B from the power source.

3.2 Instrument tour

This chapter explains the control elements and the connectors of the R&S SMCV100B. The views of the front panel and the rear panel help you to get familiar with the instrument and to perform first steps. For specifications of the interfaces, see the data sheet.

The meanings of the labels on the R&S SMCV100B are described in [Chapter 1.2, "Labels on R&S SMCV100B"](#), on page 17.

3.2.1 Front panel tour

This section provides an overview of the control elements and connectors of the front panel of the R&S SMCV100B. On the [rear panel](#), you find all further connectors.



Figure 3-2: Front panel view

- 1 = On/Standby
- 2 = USB
- 3 = Utility keys
- 4 = Touchscreen
- 5 = Rotary knob
- 6 = Function keys and Editing keys
- 7 = Connectors

3.2.1.1 Touchscreen

The block diagram and the most important settings are displayed on the screen on the front panel. Also, the screen display provides status and setting information and allows you to quickly reconfigure the signal flow. The screen is touch-sensitive, offering an alternative means of user interaction for quick and easy handling of the instrument.

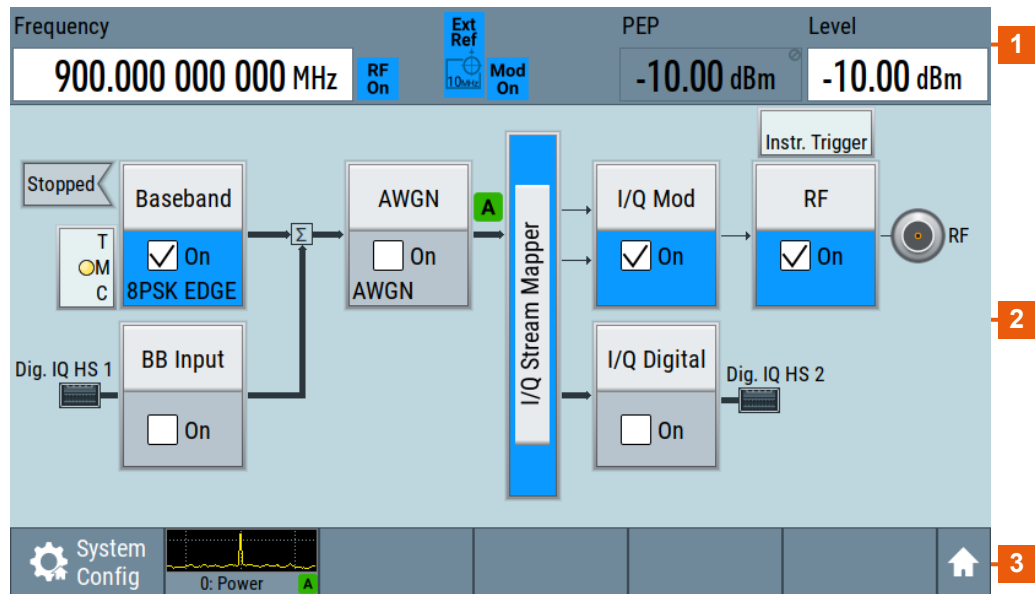

Figure 3-3: Touchscreen elements

- 1 = Status bar (frequency and level display)
- 2 = Block diagram
- 3 = Taskbar/softkey bar

Any user interface elements that react to a click by a mouse pointer also react to a tap on the screen, and vice versa. Using the touchscreen, you can perform the following tasks (among others) by the tap of your finger:

- Changing a setting
- Selecting new settings
- Scrolling through a list or a table of parameters
- Saving or recalling settings
- Opening and closing dialogs

See also:

- [Chapter 3.5.2, "Means of manual interaction"](#), on page 64, for operating the touchscreen.
- [Chapter 17.1, "Cleaning"](#), on page 855, for instructions on cleaning the screen.

3.2.1.2 Keys

On/Standby

The [On/Standby] key switches the instrument from the standby to the ready state or vice versa.

The LED below the [On/Standby] key indicates the instrument state, see [Chapter 3.1.15, "Switching on or off"](#), on page 34.

Utility keys

The utility keys cause the R&S SMCV100B to return to a defined instrument state and provide information on the instrument and assistance.

For more information, refer to [Chapter 12, "General instrument functions"](#), on page 444.

Table 3-3: Utility keys

Utility key	Assigned functions
[Preset]	Sets the instrument to a defined state
[Save/Rcl]	Saves and loads instrument setting Accesses the file manager
[Help]	Displays context-sensitive help text

Function keys

Function keys provide access to most common generator settings and functions.

A detailed description of the corresponding functions is provided in the user manual.

Table 3-4: Function keys

Function key	Assigned functions
[Home]	Brings the block diagram to the foreground. Active dialogs are minimized.
[Freq/Level]	Pressing once: Activates frequency entry. Pressing twice: Activates level entry. Toggles between frequency and level entry.
[★ (User)]	Key with a customizable function.
[RF on/off]	Switches the RF output on and off. Press the key again to restore the last active status. Status is displayed in the "Status bar".

Editing keys

Editing keys enable you to confirm an entry, delete individual characters, or exit the current operation.

Table 3-5: Editing keys

Type of key	Description
[Esc] key	Closes all kinds of dialog boxes, if the edit mode is not active. Quits the edit mode, if the edit mode is active. Equals selecting the "Cancel" button in dialogs, if provided. For "Edit" dialog boxes, the following applies: <ul style="list-style-type: none"> • If data entry has been started, it retains the original value and closes the dialog box. • If data entry has not been started or has been completed, it closes the dialog box.

Navigation controls

The navigation controls include a rotary knob, navigation keys, and the display keys. They allow you to navigate within the display or within dialog boxes.

Rotary knob

The rotary knob has several functions:

- Increments (clockwise direction) or decrements (counterclockwise direction) numeric instrument parameters at a defined step width.
- Moves the selection, e.g. to a function block in the block diagram.
- Shifts the selection bar within focused areas (e.g. lists).
- Activates editing of entries or confirms and terminates entries.
- Opens a context-sensitive menu, when it is pressed and held.

3.2.1.3 Connectors

The RF 50 Ω connector and USB connector are on the front panel.

USB

Female USB (universal serial bus) 2.0 connector of type A (host USB). You can connect, for example, a keyboard, a mouse or a USB memory stick.

Further USB connectors of type A are available on the rear panel.

How to: [Chapter 3.1.9, "Connecting USB devices"](#), on page 29.

RF 50 Ω

N-type female connector for output of the RF signal.

How to: [Chapter 3.1.11, "Connecting to RF 50 \$\Omega\$ "](#), on page 31

3.2.2 Rear panel tour

This section provides an overview of the connectors on the rear panel of the instrument. For technical data of the connectors, refer to the data sheet.

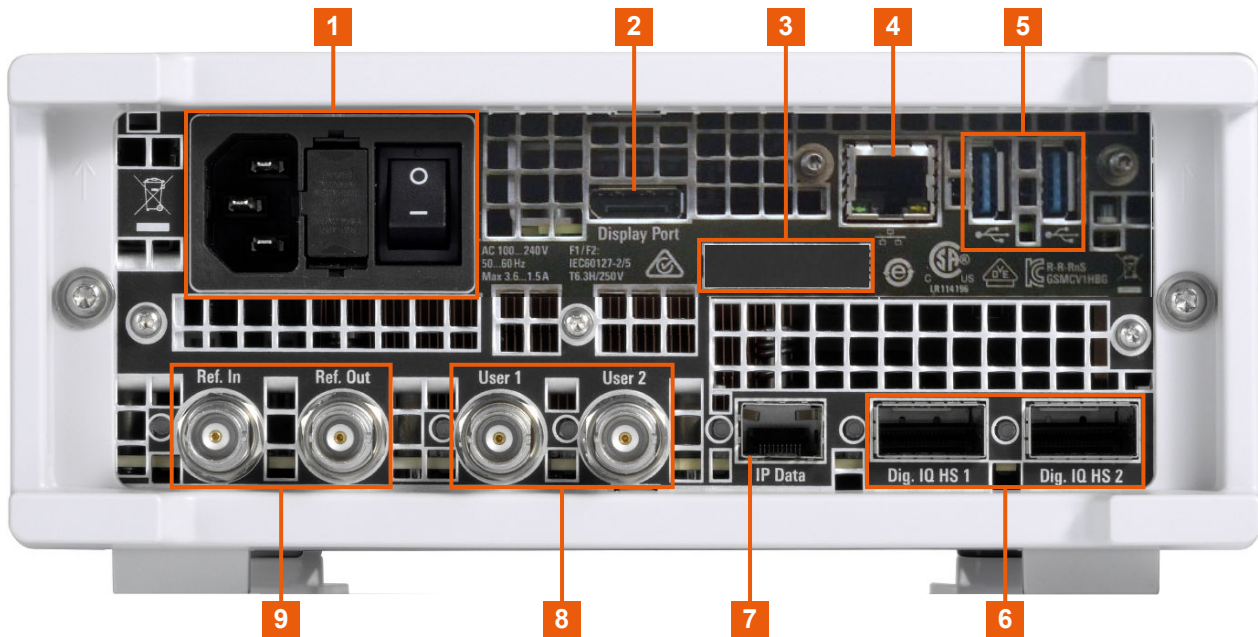

Figure 3-4: Rear panel

- 1 = AC power supply connector and switch
- 2 = Display Port
- 3 = Serial number (six digits in the string 1432.7000.02-<serial number>-<checksum>)
- 4 = LAN
- 5 = USB
- 6 = Dig. IQ HS x
- 7 = IP Data
- 8 = User x
- 9 = Ref In/Ref Out

3.2.2.1 Connectors

AC power supply connector and switch

Mains power switch for performing the following tasks:

- Connecting the internal power supply to the power source
- Disconnecting the internal power supply from the power source

How to: [Chapter 3.1.6, "Connecting to power"](#), on page 27.

Display Port

Display Port monitor connector.

How to: [Chapter 3.1.8, "Connecting a monitor"](#), on page 28

LAN

RJ-45 connector to connect the R&S SMCV100B to a LAN for remote control, remote operation, and data transfer.

How to: [Chapter 3.1.7, "Connecting to LAN"](#), on page 27

USB

Two female USB (universal serial bus) 3.0 connectors of type A (host USB). They have the same functionality as the USB connectors on the front panel, but provide higher data rates. See "USB" on page 39.

How to: [Chapter 3.1.9, "Connecting USB devices"](#), on page 29.

Dig. IQ HS x

Connectors for the input/output of high-speed digital I/Q signals, for example, from and to Rohde & Schwarz instruments.

[Table 3-6](#) lists the interface designation (input/output) and the required option.

For more information, see data sheet.

Table 3-6: Overview of Dig. IQ HS x interfaces and required options

Interface	Designation	Required option
Dig. IQ HS 1	"BB Input"	R&S SMCVB-K19 digital baseband interface
Dig. IQ HS 2	"I/Q Digital Out"	

The interface is a QSFP+ (Quad Small Form-factor Pluggable) module. It supports max. bandwidth of up to 50 Gsample/s with optical active cables.

How to: [Chapter 3.1.13, "Connecting to Dig. IQ HS x"](#), on page 31

IP Data

Interface for input of IP data for real-time encoding in broadcast baseband signals.

The interface comprises a SFP+ (Small Form-factor Pluggable) socket.

How to: [Chapter 3.1.14, "Connecting to IP Data"](#), on page 32

User x

BNC multipurpose connectors for defining input signals and output signals.

[Table 3-7](#) lists the signals assigned to the User x connectors in the default instrument state.

Table 3-7: Default configuration of the User x connectors

Connector	Direction	Default assigned signal
"User 1"	"Output"	"Baseband Marker 1"
"User 2"	"Input"	"Global Clock"

A dedicated LED indicates the connector status:

- ● green: an input connector
- ● yellow: an output connector
- ● red: error
- ● no light / gray: the connector is not active
- ● blinking LED: connection indication as a result of the "Identify Connector" function

See also [Chapter 12.2, "Configuring global connectors"](#), on page 449.

Ref In/Ref Out

Input/output for external reference signal.

BNC connectors for reference signals from 1 MHz to 100 MHz.

How to: [Chapter 3.1.12, "Connecting to Ref In/Ref Out"](#), on page 31

3.3 Trying out the instrument

This chapter introduces the most important functions and settings of the R&S SMCV100B step by step.

The complete description of the functionality and its usage is given in the R&S SMCV100B user manual. Basic instrument operation is described in [Chapter 3.5, "Instrument control"](#), on page 64.

Prerequisites

- R&S SMCV100B equipped with its minimum configuration:
 - Base unit
 - Frequency option R&S SMCVB-B103
- The R&S SMCV100B is connected to the power supply, and started up as described in [Chapter 3.1, "Preparing for use"](#), on page 24.

For the first signal generation tasks, you use the internal baseband and reference signal, so you do not need any additional signal source. More complex signal generation tasks, however, require an instrument equipped with additional options and/or external signals. Each task description lists its prerequisites.



The screenshots in this description show a fully equipped instrument. Consider that, the block diagram displayed on your particular instrument can differ from the one used in the example.

Touchscreen operation

For detailed information on touchscreen operation, see [Chapter 3.5.2, "Means of manual interaction"](#), on page 64.

The following sections provide introductory operation examples using the touchscreen.

- [Generating an unmodulated carrier](#)..... 43
- [Generating a digitally modulated signal](#)..... 44
- [Triggering the instrument with an external signal](#).....47
- [Enabling and configuring a marker signal](#)..... 51
- [Verifying the generated signal with the graphics display](#)..... 53
- [Saving and recalling settings](#)..... 56
- [Generating a DAB signal](#).....58

3.3.1 Generating an unmodulated carrier

We start out by generating a simple unmodulated signal. The R&S SMCV100B has a minimum configuration as in "Prerequisites" on page 42.

1. On the R&S SMCV100B front panel, press the Preset key to start out in a defined instrument configuration.
2. Set the frequency:
 - a) On the "Status Bar", tap the "Frequency" field.
 - b) On the on-screen keypad, enter 1.955 and press the "GHz" key.



The on-screen keypad closes and the frequency value is displayed.

3. On the "Status Bar", tap the "Level" field and enter the level in the same way.

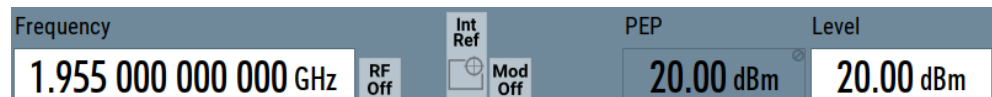

4. Select "Block Diagram > RF Block > On" to enable the output of the generated unmodulated signal.

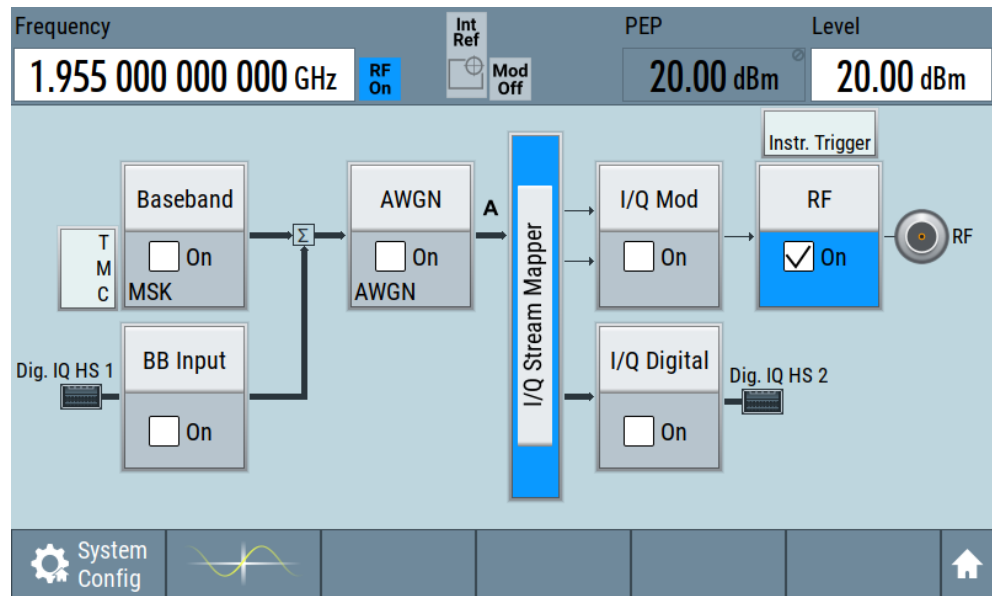

Figure 3-5: Block diagram: Generating an unmodulated signal

The 1.955 GHz signal is output at the RF 50 Ω connector at the front panel of the R&S SMCV100B.



Connect RF 50 Ω of the R&S SMCV100B to a signal analyzer, for example R&S®FSW, to display the generated signal.

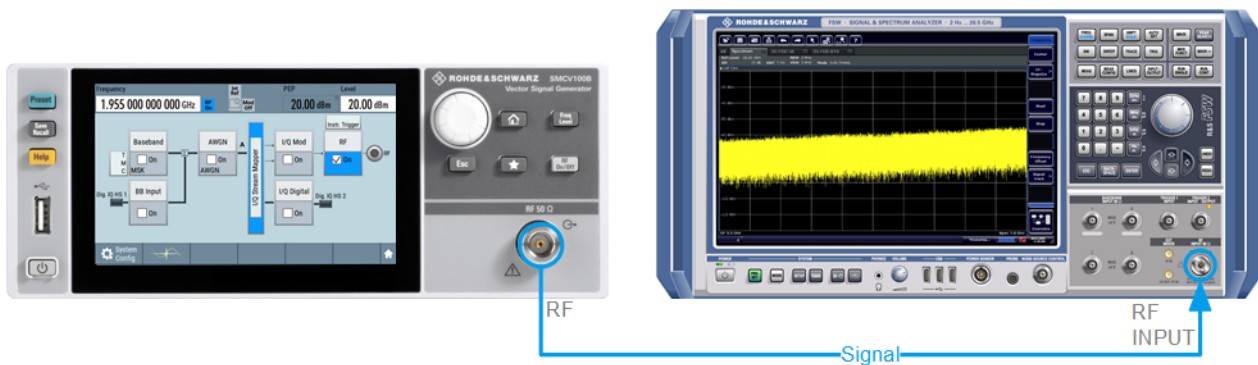

Figure 3-6: Simplified test setup

For the required settings of the signal analyzer, refer to its user manual or its online help.

3.3.2 Generating a digitally modulated signal

This example shows you how to generate a simple WCDMA-3GPP (QPSK 45° offset) signal with the help of the "Custom Digital Modulation" functionality.

Prerequisites

- Minimum configuration as in "Prerequisites" on page 42
- Option custom digital modulation R&S SMCVB-K199

The initial situation is not the instrument's preset state but rather the configuration described in [Chapter 3.3.1, "Generating an unmodulated carrier"](#), on page 43.

1. In the block diagram, select "Baseband" and navigate to the section "Misc > Custom Digital Mod...".

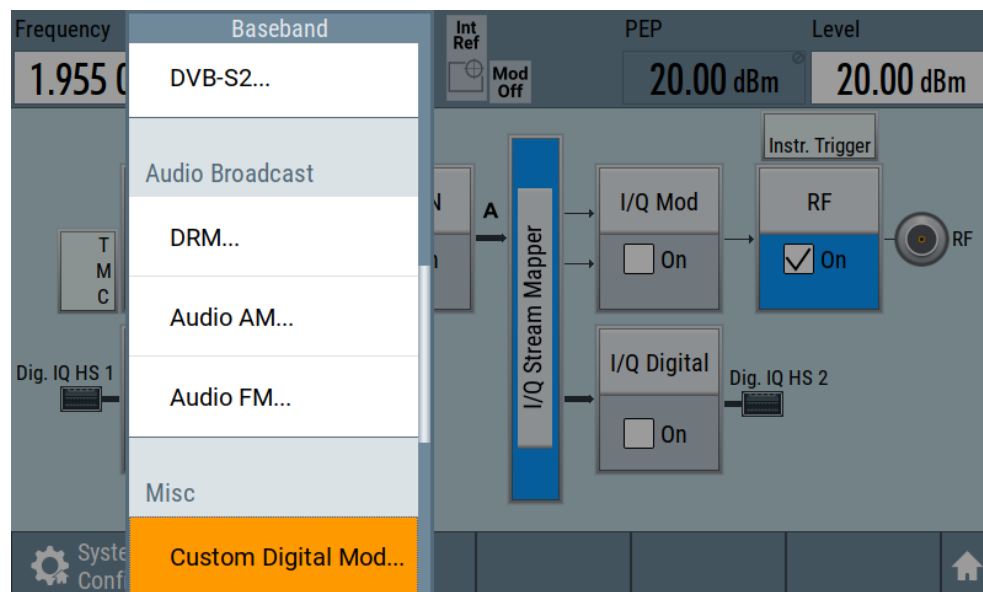

The "Custom Digital Modulation" dialog opens.

2. In the "Custom Digital Modulation" dialog, select "General > Set according to Standard > WCDMA-3GPP".
3. Select "General > State > On" to enable signal generation.

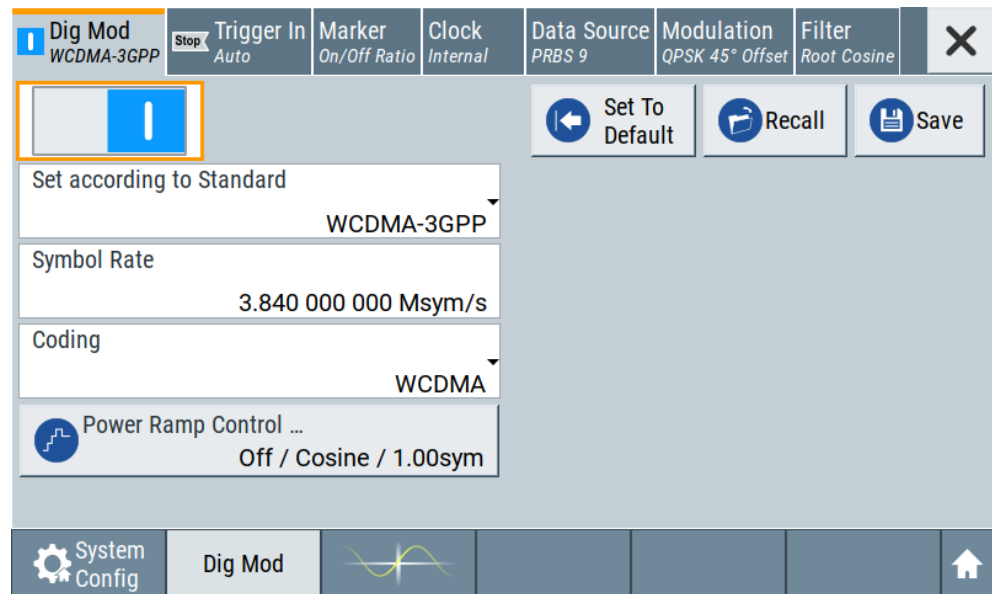

The instrument activates automatically "I/Q Mod", uses the internal trigger and clock signals, and generates a WCDMA-3GPP signal, modulated with a QPSK 45° offset modulation.

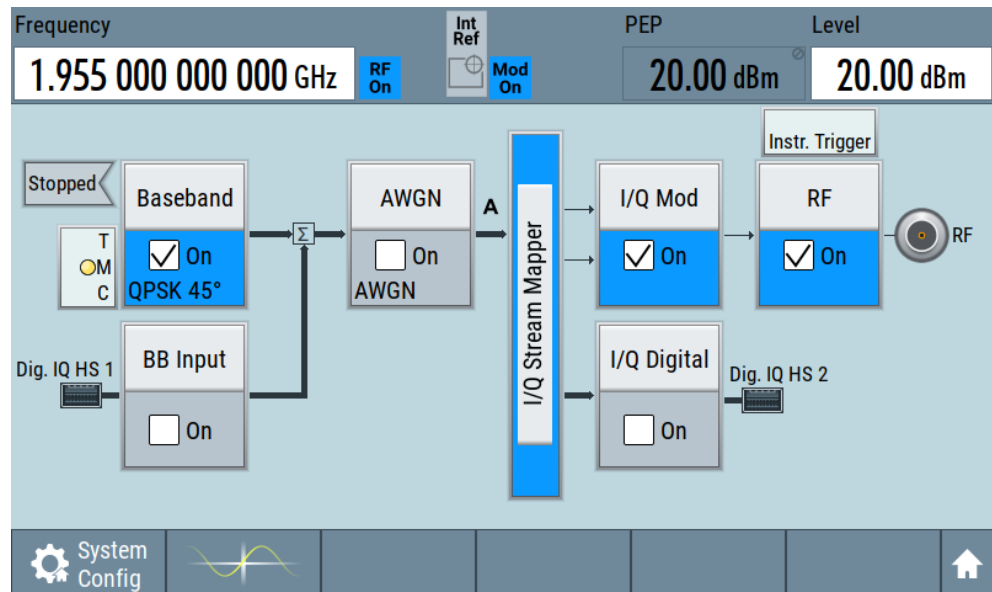

Figure 3-7: Block diagram: Generating a digitally modulated signal

- Optionally, select the "Modulation" tab and observe the used "Modulation Type".

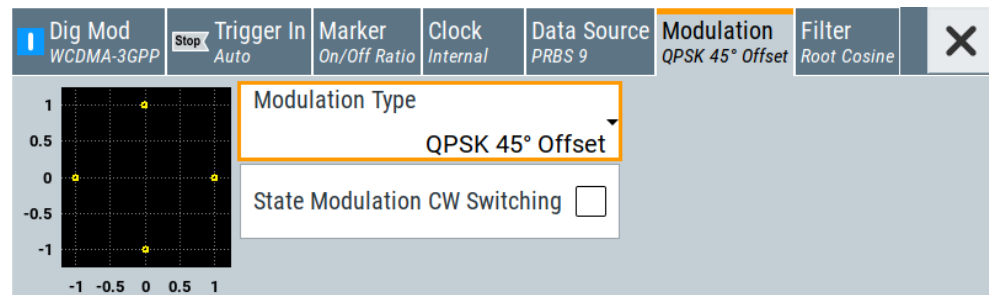

Figure 3-8: Display of the used modulation type

3.3.3 Triggering the instrument with an external signal

The following configurations are rather theoretical cases, because you rarely use the R&S SMCV100B as a standalone instrument. Usually, the instrument would be connected to a device under test (DUT) and/or other measurement equipment.

Prerequisites

- Minimum configuration as in ["Prerequisites"](#) on page 42
- Option custom digital modulation R&S SMCVB-K199

As a rule, whenever a test setup requires two or more devices, provide them with a common reference frequency. Some test setups require control of the signal generation start and an exact generation start time, determined by a defined trigger event. For example, by triggering the instrument internally or externally from the DUT.

The example below illustrates the general principle of external triggering and extends the configuration performed in [Chapter 3.3.2, "Generating a digitally modulated signal"](#), on page 44 by the configuration of the required trigger signal and connector settings.

This test setup requires one signal analyzer, like the R&S®FSW, as additional equipment.

To start signal generation synchronous to an external global trigger signal

The configuration requires three main steps with the following goals:

1. Observe the current connector configuration. Define an input connector for the external global trigger signal.
See ["To verify the current connector configuration"](#) on page 48
2. Configure the baseband to use the external global trigger signal as trigger source.
See ["To reconfigure the trigger settings"](#) on page 49
3. Connect the instrument and the external trigger source.
See ["To connect the instrument and the external trigger source"](#) on page 50

To verify the current connector configuration

The R&S SMCV100B is equipped with multipurpose bi-directional User connectors. Because the signal direction, input or output, and the signal mapping are configurable, we recommend that you check the current configuration before cabling or further instrument's configurations.

- To display an overview of the current mapping of the logical signals to the connectors, perform one of the following:
 - In the block diagram, select the Trigger/Marker/Clock status LEDs on the left side of the "Baseband" block.



- Select "Baseband > Trigger Marker Clock".

	Logical Signal	Connector	Show
Trigger Source	Internal		
Clock Source	Internal		
Marker	On/Off Ratio	User 1	

Diagram Legend
 T = Trigger
 M = Marker
 C = Clock
 = Signal is available at Output Connector
 = Signal Source is external

Global Connectors ...

The instrument uses its internal trigger and clock signals, and the default mapping of the marker signals to the User connectors.

- To access the related connector settings, perform one of the following:
 - Select "Global Connector Settings"
 - Tap the connector name, for example select the connector "User 1"

Connector	Direction	Signal
User 1	Output	Baseband Marker
User 2	Input	Global Trigger

Figure 3-9: Signal mapping to the global connectors

The "Global Connectors" dialog displays the current connectors configuration. The settings are configurable, but in this example we use the default mapping.

- Alternatively, select "Block Diagram > Baseband > Misc > Custom Digital Mod", select the "Trigger In" tab and select "Global Connector Settings".

In the current mapping, the two global connectors **User x** on the rear panel are configured as follows:

- "Baseband Marker" signal is output at the "User 1" connector.
The LED next to the connector is ● orange.
- The "User 2" connector is an input for the "Global Trigger" signal.
The LED next to the connector is ● green.



Find the physical location of each connector

Use the built-in "Trigger Marker Clock > Show " function to display the location of the selected connector. A blinking marker on the front/rear panel view also indicates the selected connector.

To reconfigure the trigger settings

We assume that the instrument is configured as described in [Chapter 3.3.2, "Generating a digitally modulated signal"](#), on page 44 and the default connector mapping is maintained (see [Figure 3-9](#)).

- In the block diagram, select "Baseband > Misc > Custom Digital Mod > Trigger In".
- Select the following settings:
 - "Mode > Armed Auto"
 - "Source > External Global Trigger".

Dig Mod	Trigger In	Marker	Clock	Data Source	Modulation	Filter	
WCDMA-3GPP	Stop Arm Auto	On/Off Ratio	Internal	PRBS 9	QPSK 45° Offset	Root Cosine	X
Mode	Armed Auto	Stopped					
Source	External Global Trigger	Sync. Output To Ext. Trigger					<input checked="" type="checkbox"/>
External Delay Unit	Symbol						
External Delay	0.00 Symbols	Actual External Delay				0.000 0 µs	
Global Connectors ...							

- Select "Global Connector Settings > Routing".
- For "User 2", select "Direction > Input" and "Signal > Global Trigger".

Connector	Direction	Signal
User 1	Output	Baseband Marker
User 2	Input	Global Trigger

The instrument expects an external global trigger event. In the current configuration, the "Global Trigger" signal has to be supplied at the input connector User 2. The Trigger/Marker/Clock status LEDs in the block diagram confirm that an external trigger signal is selected; the signal generation is however stopped.

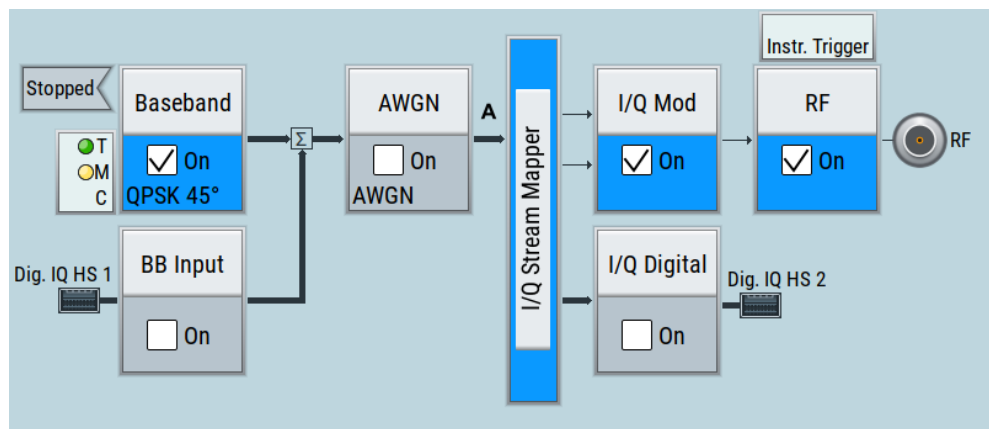

To connect the instrument and the external trigger source

1. Use a suitable cable to connect the external trigger source to the User 2 connector of the R&S SMCV100B. See [Figure 3-10](#).

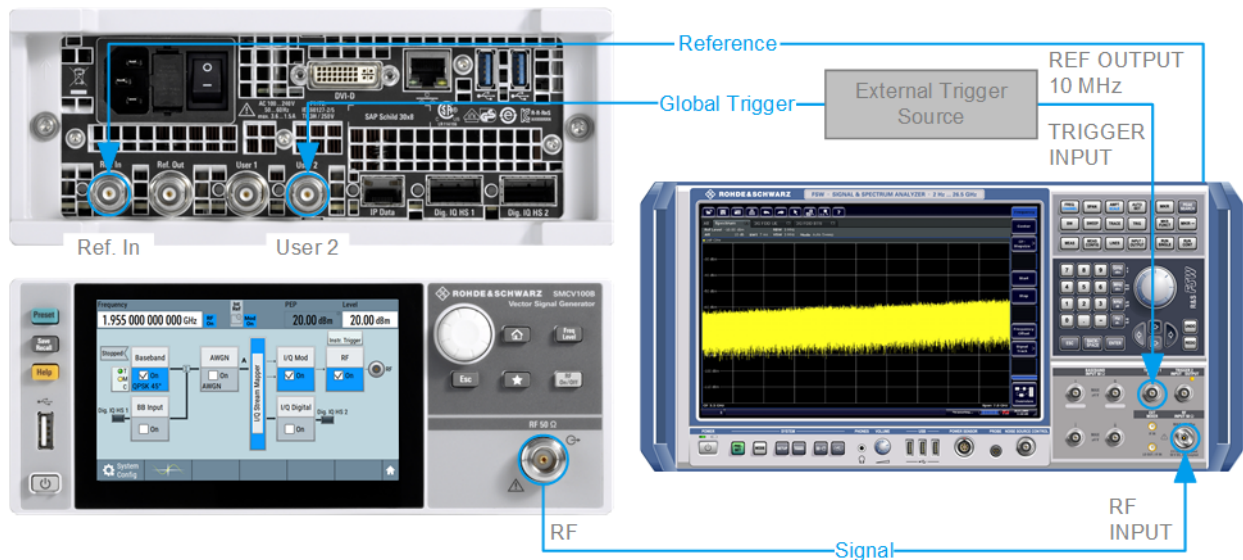

Figure 3-10: Simplified representation of a test setup**

** = The figure depicts the cabling as a general principle; particular test setups do not require all connections at the same time

The Figure 3-10 depicts the location of the connectors and explains the connection as principle. In practice, you would rather "substitute" the analyzer by a DUT, like a base station (BS).

Other than in the example, the DUT can be the source for the reference signal. Instead of using an external trigger source, the DUT can also send, for example, a frame trigger signal to the R&S SMCV100B. The R&S SMCV100B acts still as the signal source.

2. Use suitable cables to connect to **RF 50 Ω** and **Ref. In** connectors of the R&S SMCV100B to the signal analyzer or the DUT.
The R&S®FSW supplies the 10 MHz external reference signal.

Upon the receiving of an external trigger event, the R&S SMCV100B starts the signal generation and then generates a continuous signal. An "Arm" stops the signal generation. A subsequent trigger event causes a restart of the signal generation.



To learn more about this topic, refer to:

- [Chapter 4.4.1.3, "Baseband trigger signals"](#), on page 86

3.3.4 Enabling and configuring a marker signal

Test setups often require synchronization of an external device with the generated data stream. For this purpose, the R&S SMCV100B can output maximum two marker signals (or markers) also to the generated signal.

The R&S SMCV100B provides four regular marker signals. You can output two of the marker signals, one to each of the "User 1"/"User 2" connectors.

With suitable marker settings for instance, you can mark slot or frame boundaries or mark the start of a particular modulation symbol.

Prerequisites

- Minimum configuration as in "Prerequisites" on page 42
- Option custom digital modulation R&S SMCVB-K199

This example extends further the configurations performed in [Chapter 3.3.2, "Generating a digitally modulated signal"](#), on page 44. We assume a default connector mapping (see [Figure 3-9](#)).

This test setup requires one oscilloscope, like the R&S®RTO, as additional equipment.

1. In the block diagram, select "Block Diagram > Baseband > Misc > Custom Digital Mod > Marker" tab.

2. Select "Marker Mode > Marker 1 > Pulse" and "Divider = 32".

Generated is a periodic marker with marker frequency of 120 KHz. The signal is output at the User 1 connector of the R&S SMCV100B (see [Figure 3-9](#)).

3. Use a suitable cable to connect the User 1 connector of the R&S SMCV100B to the monitoring instrument, for example an oscilloscope like R&S®RTO. See [Figure 3-11](#).

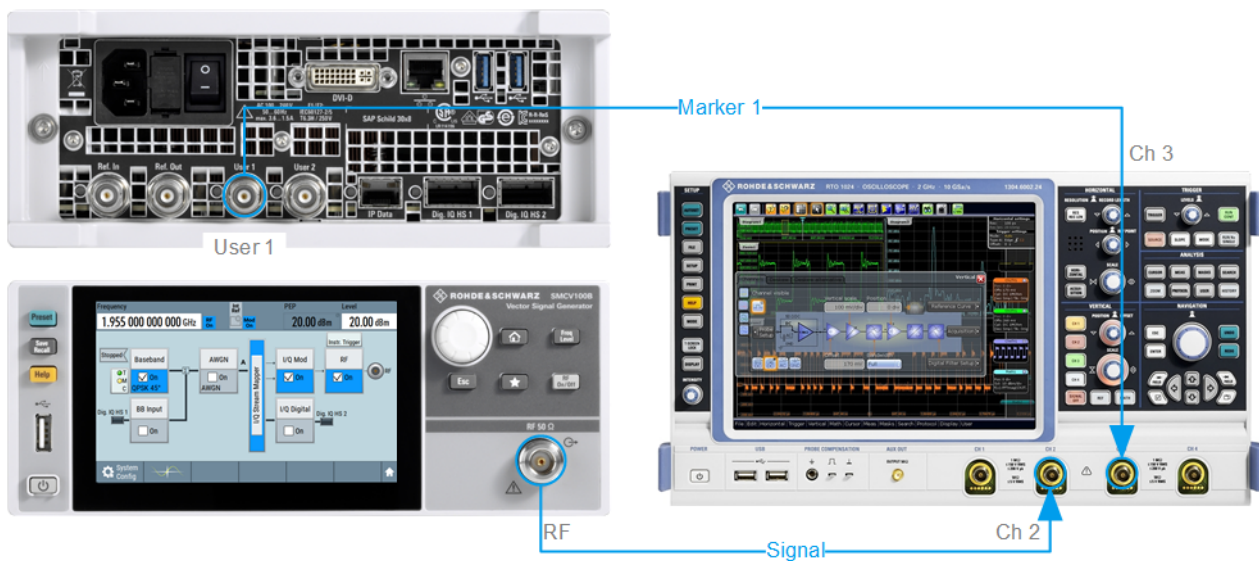

Figure 3-11: Simplified representation of a test setup for signal monitoring**

** = The figure depicts the cabling as a general principle

4. Use a suitable cable to connect the "RF 50 Ω" on page 39 connector of the R&S SMCV100B to the monitoring instrument.



To learn more about this topic, refer to [Chapter 4.4.1.2, "Regular marker output signals"](#), on page 84.

3.3.5 Verifying the generated signal with the graphics display

It is often useful to check the spectra of the configured signals, before you enable the RF output of the instrument. The R&S SMCV100B has a minimum configuration as in ["Prerequisites"](#) on page 42

The R&S SMCV100B provides a build-in function to represent the generated signal on a graphical signal display. We demonstrate this feature by showing the characteristics at one particular point of the signal processing chain. You can, however, display the signal characteristics at other different stages.

This example shows you how to use this graphical display to verify the generated signal. Use the signal generated in [Chapter 3.3.4, "Enabling and configuring a marker signal"](#), on page 51.

To access the graphical signal display functionality

- ▶ Perform one of the following:
 - Select "Taskbar > System Configuration > Graphics".

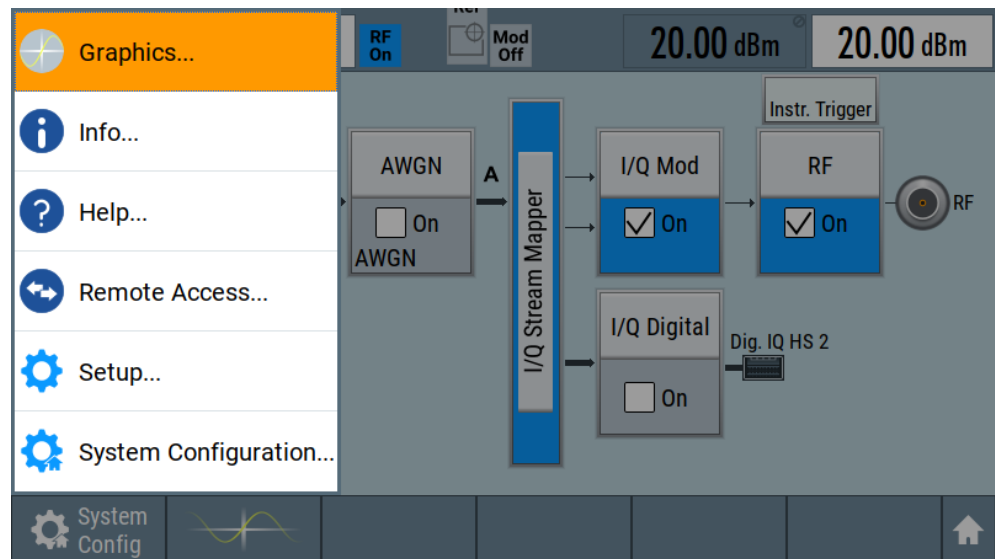

- On the "Taskbar", tap the wave icon.

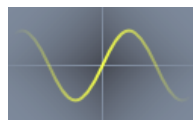

The "Graphics Configuration" dialog opens.

To visualize the signal

1. In the "Graphics Configuration" dialog, select "Mode > Constellation".

2. Select "Source > Baseband".
3. Select "Add" to enable signal display.

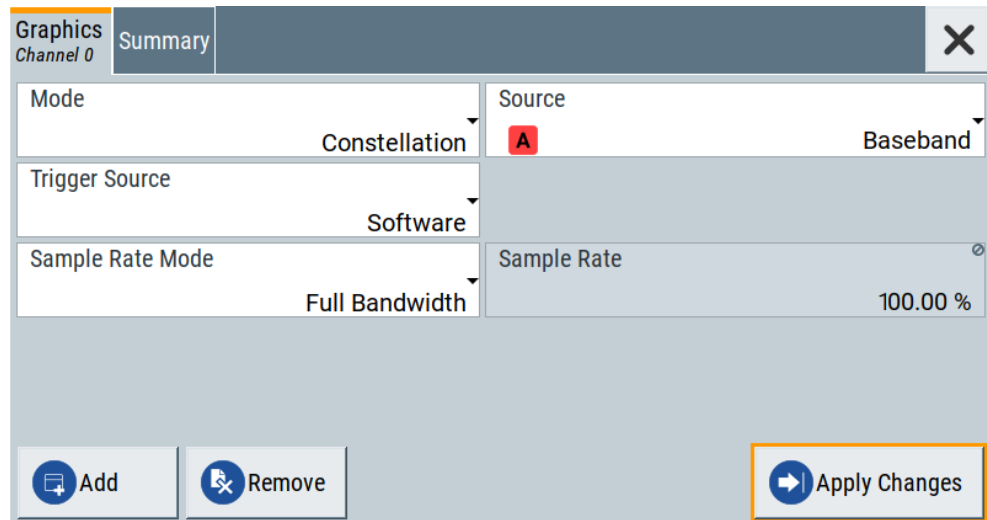

In the "Summary" tab, you can verify, that "Channel 0" graphic is visible in the table:

Channel	Mode	Source	Trigger	Sample Rate
0	Constellation	Baseband	Software	Full Bandwidth

A new thumbnail (minimized view) indicating the active diagram appears in the "Taskbar".

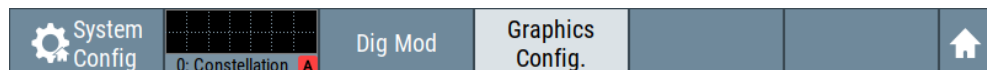

4. Press the thumbnail graphic.
The graphic enlarges and the diagram is displayed in a normal size.

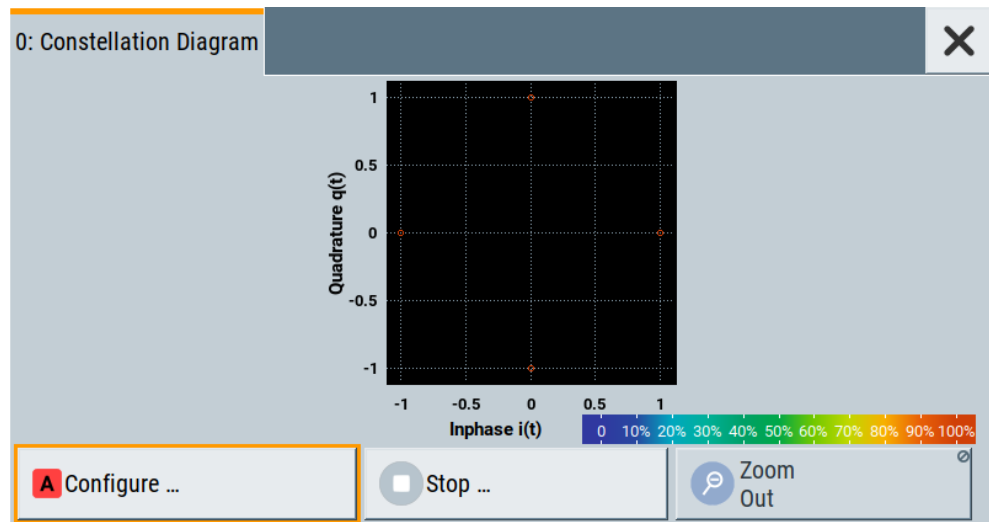

The "Constellation Diagram" displays the 3GPP FDD signal.

5. To retrieve more information, zoom in. In some diagrams you can select "Show Marker" to measure the distance, for example, between two signals. In principle, the zoom in function works like the two-finger pinching for magnifying images on your cellphone.
6. In the "Constellation Diagram" dialog, select "Configure" to return to the "Graphics Configuration" dialog. Close the "Graphics Configuration" dialog.

This action has no effect on the configured graphics but on the dialog itself.

The block diagram displays the current signal routing. It indicates that frequency and power offsets are enabled and displays the acquisition points for the real-time diagrams minimized in the "Taskbar".

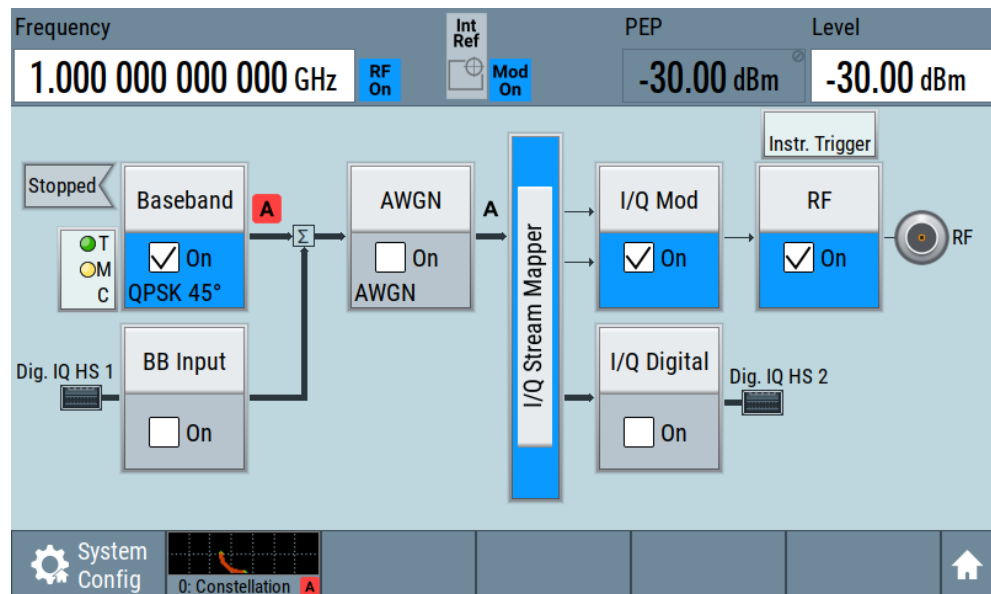

See also [Chapter 10, "Monitoring signal characteristics"](#), on page 394.

3.3.6 Saving and recalling settings

To restore the results of our measurements later, we save the instrument settings to a file.

To save the instrument settings to a file

We assume, a test configuration as described in [Chapter 3.3.4, "Enabling and configuring a marker signal"](#), on page 51.

1. Press the [Save/Rcl] key on the front panel.
2. In the "Save/Recall" dialog box, select "Operation Mode > Save".
Tap the "Filename", use the on-screen keyboard, and enter *MyTestSignal*.

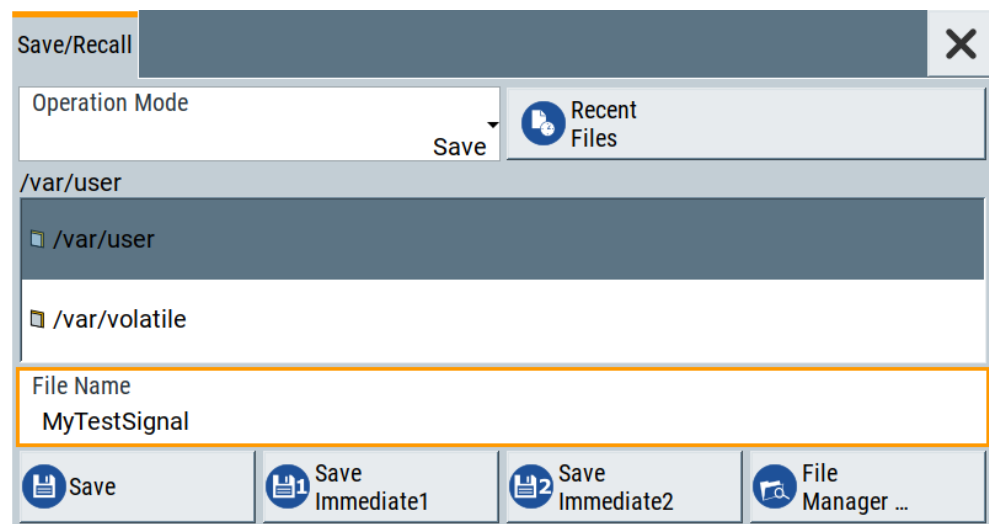

3. Tap the "Save" button.

The file `MyTestSignal.savrcltxt` is saved in the default directory `/var/user`.

To load saved instrument settings

You can restore the settings to the instrument at any time using the settings file.

1. Press the Preset button to restore the default instrument settings.
2. Press the Save/Rcl key.
3. In the "Save/Recall" dialog, select "Recall" operation.
Navigate to the directory of the saved file. Select the `MyTestSignal` file.

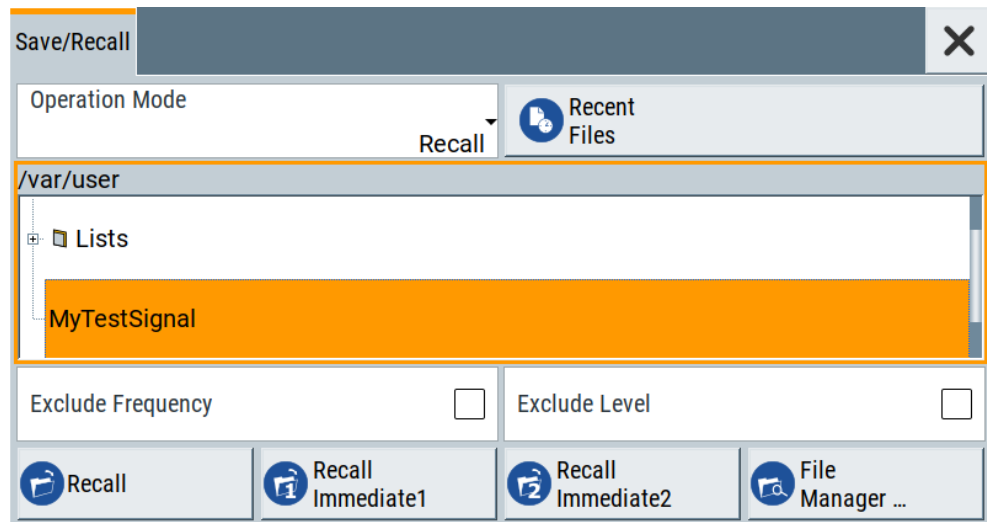

4. Tap the "Recall" button.

All instrument settings are restored and the display resembles the instrument display right before the settings were saved.

To display all parameters with values different to their preset values

After loading saved instrument setting, visualize all parameters that have been changed from their default state.

1. In the block diagram, open the context-sensitive menu:
 - a) Imitate a right-click.
 - b) Tap and hold on an empty space in the block diagram for about one second.
2. In the context-sensitive menu, select "Mark All Parameters Changed from Preset".



All changed parameters are highlighted.

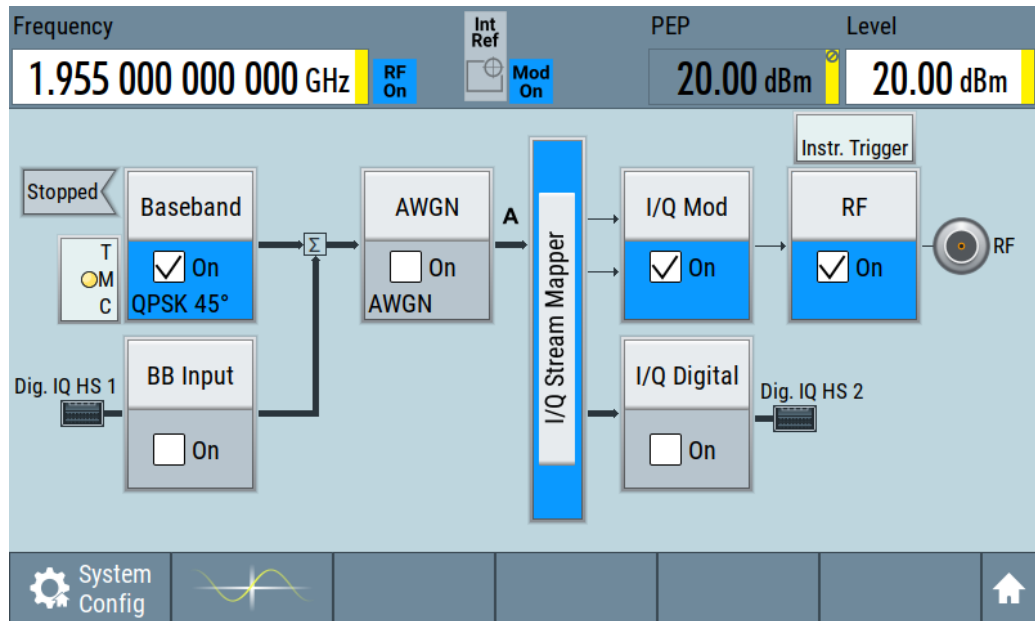

See also [Chapter 11, "File and data management"](#), on page 413.

3.3.7 Generating a DAB signal

The main application field of the R&S SMCV100B is the generation of digital signals in accordance with broadcast standards, like DAB, DVB-T2 or ATSC3.0, to name a few. This example uses the digital broadcast standard DAB.

You can access and interact with the instrument and experience the advantages provided by the additional options.

Prerequisites

- Minimum configuration as in ["Prerequisites"](#) on page 42
- Option "Enable broadcast standard" R&S SMCVB-K519
- Option DAB/T-DMB R&S SMCVB-K156

To generate a DAB test signal

1. On the R&S SMCV100B front panel, press the Preset key to start out in a defined instrument configuration.
2. In the block diagram, select "Baseband > T-DMB/DAB".

The "T-DMB/DAB" dialog appears and displays the general settings provided for the digital standard.

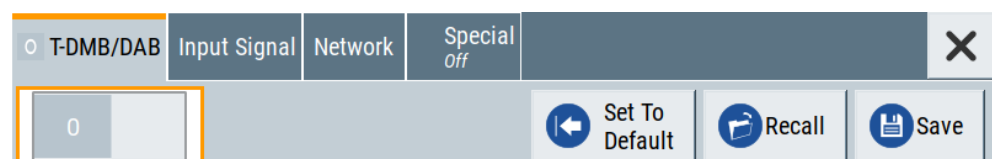

As in the user interfaces of all broadcast standards, the "T-DMB/DAB" dialog is divided into several tabs. The "T-DMB/DAB" tab comprises the primary settings of the standard.

Also, the functions for storing and recalling settings and provides access to further functions and dialogs. The more complex the digital standard itself is, the more comprehensive the further dialog and tab structure.

3. In the "Input Signal" tab, select "Source > Test Signal".
The test signal is a signal with audio content.

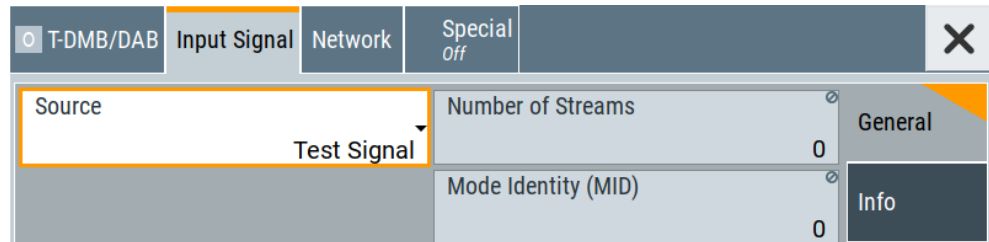

Tip: On the front panel, press the Help key to retrieve detailed information on the current settings and on the contents of the predefined files.

4. In the "T-DMB/DAB" tab, select "State > On".

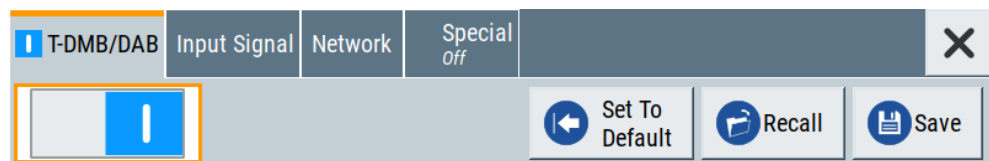

5. On the "Status Bar", set "Frequency" and "Level" of the DAB test signal:
 - a) Tap the "Frequency" field, to enter the center frequency, for example *174.928 MHz*.
 - b) Tap the "Level" field, to enter the RMS level, for example *20.00 dBm*.

6. On the "Status Bar", activate the RF output: Set "RF On > RF On".

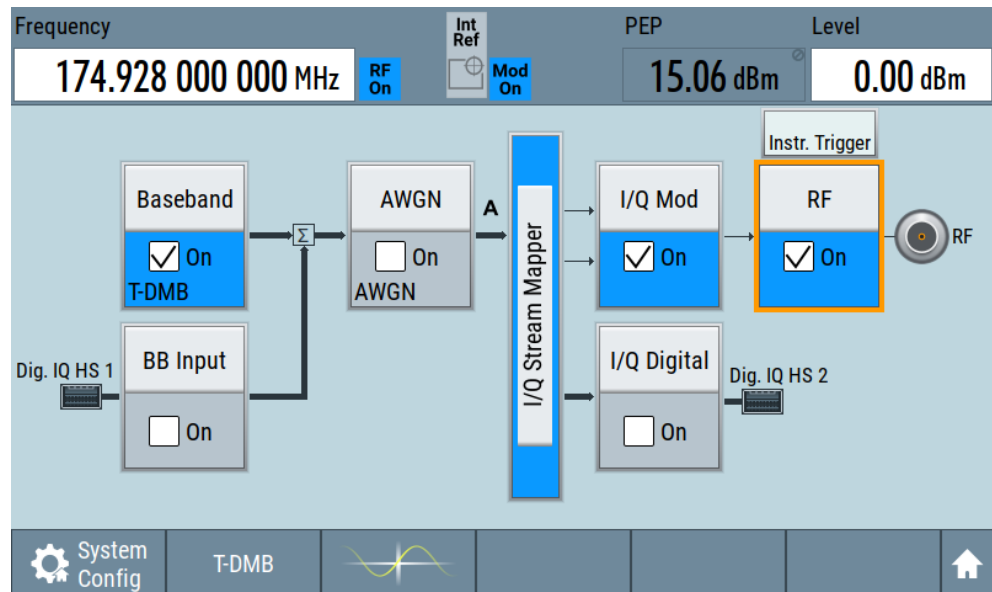

The instrument generates a DAB test signal with the set frequency, and level.



With these first steps, you have gained an impression of the provided functionality.

For a comprehensive description of the full range of capabilities, refer to the user manual "DAB Digital Standard for R&S SMCV100B".

3.4 System overview

This section helps you to get familiar with the R&S SMCV100B. It provides an introduction to the general concept of the instrument. This section also introduces the main blocks in the signal generation flow.

For information on how to access functions and interact with the R&S SMCV100B, refer to [Chapter 3.5, "Instrument control"](#), on page 64.

3.4.1 Brief introduction to the instrument's concept

The R&S SMCV100B offers excellent RF and baseband characteristics. The baseband section of the R&S SMCV100B is fully digital. It contains the hardware for generating and processing I/Q signals in realtime or generating signals with an arbitrary waveform generator.

3.4.2 Signal flow at a glance

The R&S SMCV100B is equipped with a large touchscreen, that displays a block diagram. The block diagram represents the signal flow and the general stages the signal generation goes through. Depending on the options the R&S SMCV100B is equipped with, the appearance of the block diagram changes.

The following examples do not cover all possible cases but aim to introduce the way the block diagram depicts the installed options.

- Minimum configuration example of a base unit and frequency option R&S SMCVB-B103.

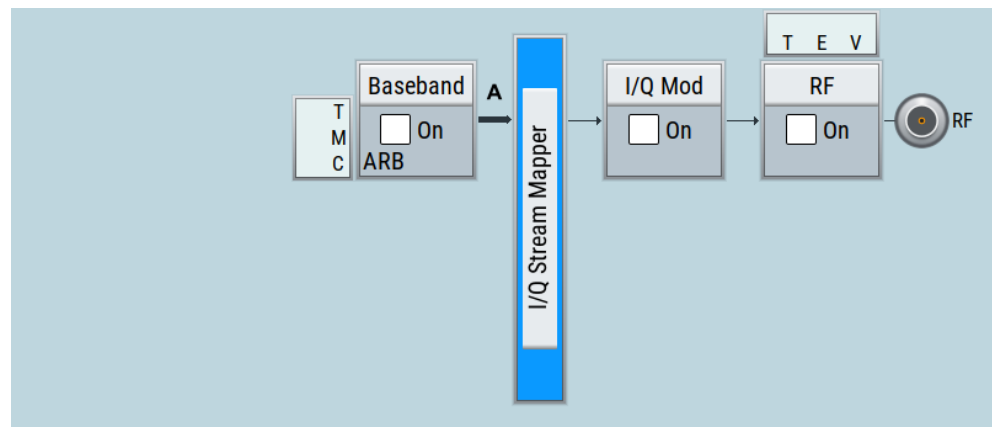

- An example of a fully equipped instrument. The block diagram displays all blocks for installed software options. Arrows within the block diagram indicate the signal flow.

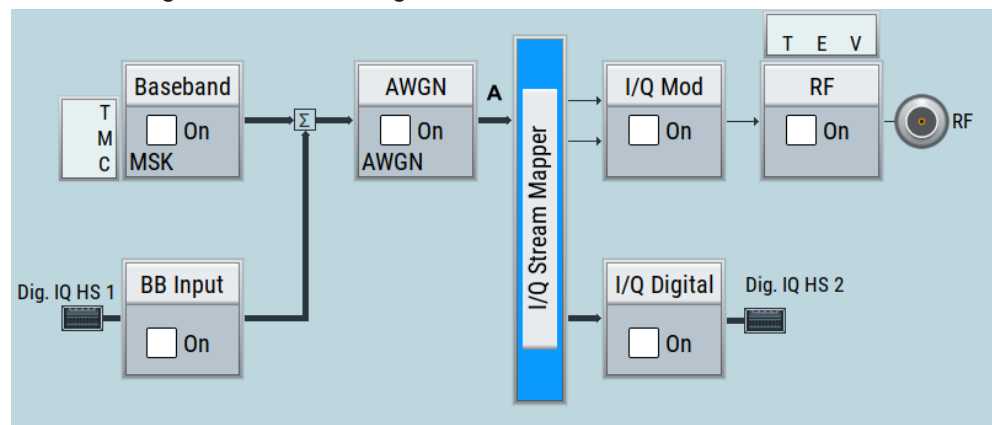

The cross-reference between the installed options and the displayed settings

The [Table 3-8](#) is an excerpt of the available options and lists only the options required *to display* a functional block in the block diagram. The information assumes R&S SMCV100B minimum configuration comprising base unit and frequency option R&S SMCVB-B103.

For exact information on the available options, and on the minimum requirements and the interdependencies between the provided options, refer to the R&S SMCV100B data sheet.

Table 3-8: Required options per functional block (excerpt)

Functional block	Required option
"Baseband"	-
"BB Input"	R&S SMCVB-K19
"AWGN"	R&S SMCVB-K62
"I/Q Stream Mapper"	-
"I/Q Mod"	-
"I/Q Digital"	R&S SMCVB-K19
"RF"	-

3.4.3 Internal baseband source ("Baseband" block)

The "Baseband" block represents the source of the baseband signals (basebands).

This functional block is the access point to:

- *The internal baseband generator*
The baseband generator contains modules for real-time signal generation ("Custom Digital Modulation" requires R&S SMCVB-K199) and an arbitrary waveform generator (ARB).
- *The available digital standards*
Generation of digital signals in accordance with the supported standards requires additional software options. For example, option R&S SMCVB-K162 generates signals according to the ATSC 3.0 standard.
- *The baseband offsets function*
Signals from the baseband generator can be shifted in frequency and phase.

3.4.4 Digital baseband input/output ("BB input"/ "I/Q digital" block)

The "BB Input" and the "I/Q Digital" blocks are the access point to the settings of the digital interfaces Dig. IQ HS x.

Equipped with option R&S SMCVB-K19, the R&S SMCV100B is able to receive digital baseband signals and to output digital baseband signals. You can use both interfaces in parallel: Dig. IQ HS 1 is input and Dig. IQ HS 2 is output of the digital baseband signals.

The digital baseband inputs and outputs can be used together with other Rohde & Schwarz instruments, like signal generators. A Rohde & Schwarz signal generator for instance can serve as digital signal source in test configuration requiring two baseband sources.

The "BB Input" block is the access point to the settings of:

- *The external digital I/Q signals*
The external digital I/Q signals are further processed in the baseband section.
- *The baseband offsets function*

The external and internal baseband signals can be shifted in frequency and phase. The "I/Q Digital" block is the access point to the settings of the digital I/Q output signals.

3.4.5 Additional white gaussian noise ("AWGN" block)

The "AWGN" block is displayed only in instruments equipped with the option R&S SMCVB-K62. This block controls the additional white Gaussian noise generator (AWGN). An additive white noise is required for measurements of mobile radio base stations.

3.4.6 "I/Q stream mapper" block

As one of the access points to the system configuration settings, the "I/Q Stream Mapper" provides direct access for mapping the generated I/Q streams to the available output connectors. That is, to the RF 50 Ω output connector and to the Dig. IQ HS 2 output connectors.

3.4.7 I/Q modulator ("I/Q mod" block)

The "I/Q Mod" block represents the I/Q modulator.

This functional block is the access point to:

- The I/Q modulation of the internal baseband signal
- The digital I/Q impairments

3.4.8 RF ("RF" block)

The "RF" block represents the RF settings of the instrument.

This block is the access point to:

- RF frequency and level settings, and the reference frequency, user correction, etc.
- The list and sweep modes

3.4.9 Applications examples of the R&S SMCV100B

The R&S SMCV100B can be optimally adapted to the requirements of different applications:

- Generation of digitally modulated signals using
 - The internal baseband generator
 - The externally applied digital baseband signals
- Generation of wanted signals or interfering signals for receiver tests

- Generation of signals with up to 240 MHz signal bandwidth (R&S SMCVB-K523)

3.5 Instrument control

This chapter provides an overview on how to work with the R&S SMCV100B.

It covers the following topics:

• Possible ways to operate the instrument.....	64
• Means of manual interaction.....	64
• Understanding the display information.....	65
• Accessing the functionality.....	70
• Entering data.....	71
• Getting information and help.....	72
• Remote control.....	74
• Remote operation over VNC.....	74

3.5.1 Possible ways to operate the instrument

There are three ways to operate the R&S SMCV100B:

- Manual operation:
Use the touchscreen, hard keys and rotary knob, or an optional mouse and/or keyboard.
- Remote control:
Create programs to automatize repeating settings, tests and measurements. The instrument is connected to a computer running the program.
This way of operation is described in [Chapter 13, "Network operation and remote control"](#), on page 499.
- Remote operation from a computer:
Remote monitoring and control of the instrument from a connected computer is based on the common cross-platform technology VNC (Virtual Network Computing). On the remote computer, any standard web browser (supporting Java) or a dedicated VNC client (like Ultr@VNC) can be used. See also [Chapter 3.5.8, "Remote operation over VNC"](#), on page 74.

The following sections show how to operate the instrument manually.

3.5.2 Means of manual interaction

For the manual interaction with the R&S SMCV100B, you have several methods that you can use as an alternative to perform a task:

- Touchscreen:
Touchscreen operation is the most direct way to interact. Almost all control elements and actions on the screen are based on the standard operating system concept. You can tap any user interface element to set parameters in dialog boxes, enter data, scroll within a dialog etc., as if you work with a mouse pointer.

Tapping the screen works like clicking mouse buttons:

- Touch quickly = click: Selects a parameter or provokes an action.
 - Touch and hold = right-click: Opens a context-sensitive menu.
 - Touch and swipe = drag: Scrolls through the contents of a display element larger than the screen, e.g. a list or a table.
- Function keys and rotary knob:
The front panel provides nearly all functions and controls to operate the instrument in the classic way, without touchscreen.
 - Optional mouse and/or keyboard:
These devices work like known from PCs. The navigation keys on the front panel correspond to the keys on the keyboard.

This manual describes the manual interaction with the instrument via the touchscreen. It mentions the alternative methods using the keys on the instrument or the on-screen keypads if it deviates from the standard operating procedures. The usage of the touchscreen and navigation keys is described in [Chapter 3.5.4, "Accessing the functionality"](#), on page 70.

Throughout the manual, the term "select" refers to any of the following methods:

- Using a finger on the touchscreen
- Using a mouse pointer in the display
- Using a key on the instrument or on a keyboard

3.5.3 Understanding the display information

The block diagram of the R&S SMCV100B displays all main settings and generator states, divided into three main operation areas.

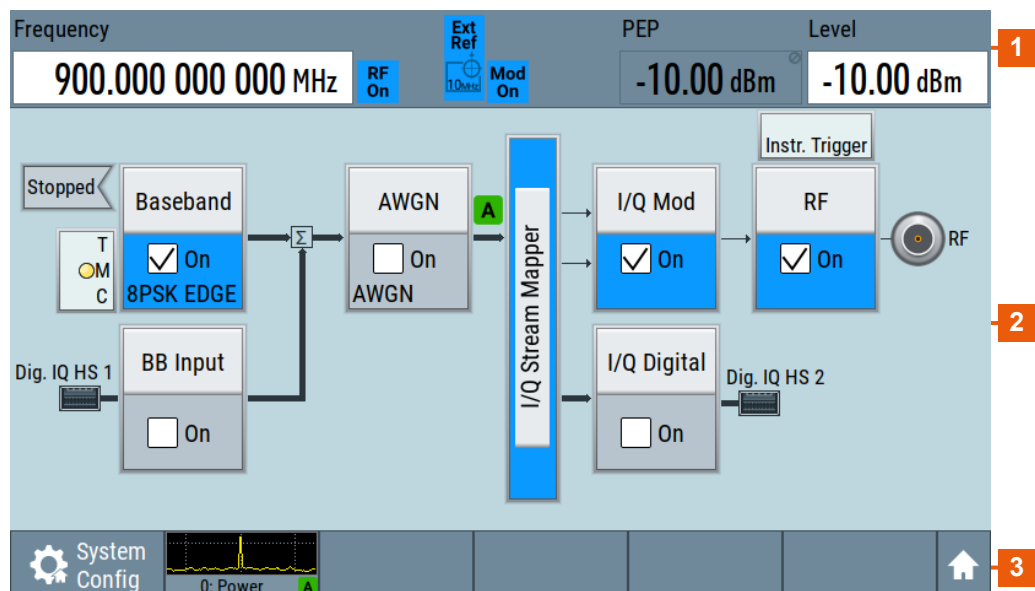

Figure 3-12: Block diagram

- 1 = Status bar (frequency and level display)
- 2 = Block diagram
- 3 = Taskbar/softkey bar

- [Status bar](#).....66
- [Block diagram](#)..... 66
- [Taskbar](#).....67
- [Additional display characteristics](#)..... 68

3.5.3.1 Status bar

The status bar at the top of the screen indicates the RF frequency and the level of the output signal provided to the DUT. You can set both parameters directly here.

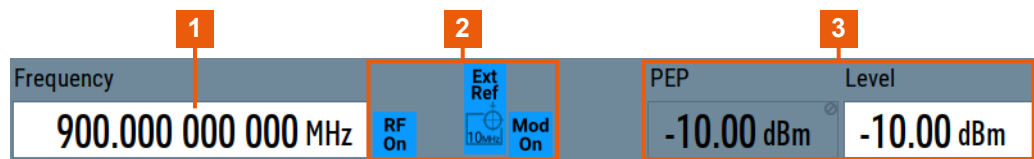

- 1 = Frequency display
- 2 = Status buttons
- 3 = Level display

The status buttons indicate key parameters that are set for the output signal. Most of the status buttons are virtual keys that you can use to open a corresponding menu or dialog.

3.5.3.2 Block diagram

The block diagram shows the current configuration and the signal flow in the generator with the aid of function blocks, connected by signal lines. The following figure displays the most common elements that can appear in the block diagram. However, it does not necessarily represent a useful configuration.

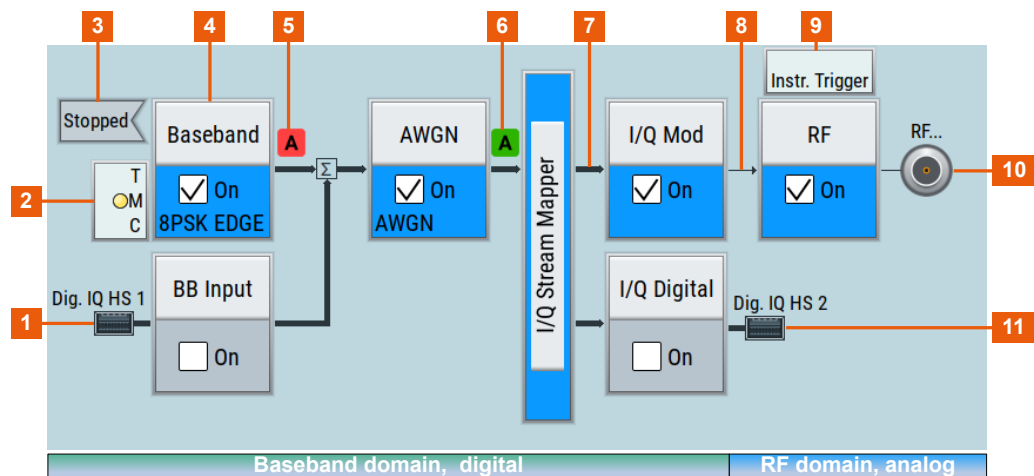

- 1, 10, 11 = Connector icons (digital, RF)
- 2, 9 = Control signal block
- 3 = Status indicator
- 4 = Functional block
- 5, 6 = Graphics indicator
- 7 = Signal line (digital)
- 8 = Signal line (analog)

Starting from left up to the "I/Q Mod" functional block, you can see the functional blocks provided in the baseband domain. After the I/Q modulation on the analog RF carrier, the analog section implies the routing to the "RF" functional block.

Legend	Item	Description
1, 10, 11	Connector icon	Represents the interfaces for signal input and output. <ul style="list-style-type: none"> • Digital I/Q HS signal connector input and output (1, 11) • RF signal connector output (10) Icons vary depending on the frequency.
2, 9	Control signal block	Indicates information on the control signals like signal content, input or output and provides quick access to the corresponding configuration dialog. A dedicated control block is displayed to the left of the baseband block (2) and above the RF block (9).
3	Status indicator	Indicates whether the signal is running or waiting for a trigger.
4	Functional block	Represents a basic task in signal generation. The push button provides access to any number of associated actions to accomplish the task. The On/Off (checkbox) and the block label quickly activates the basic task.
5, 6	Graphics indicator	Denotes that the signal is displayed graphically: <ul style="list-style-type: none"> • Baseband signal after the baseband block (5) • Stream signal before mapping (6)
7, 8	Signal line <ul style="list-style-type: none"> • digital • analog 	Shows the currently configured signal flow: <ul style="list-style-type: none"> • Thick lines represent digital I/Q streams (7). • Thin lines represent analog signals (8).

3.5.3.3 Taskbar

The "Taskbar" contains labeled softkeys and minimized views (thumbnails) of active graphics and dialogs.

Initially, it shows the permanently assigned softkeys. The softkey with the sine wave denotes that no signal is activated for graphical representation.

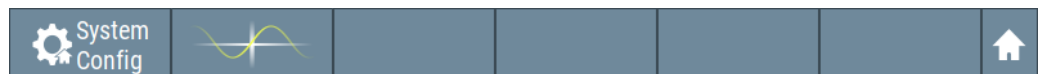

Figure 3-13: Taskbar in default state

Whenever you open a settings or graphics dialog, it is automatically assigned to the "Taskbar". The softkeys shown in the following figure represent the variants.

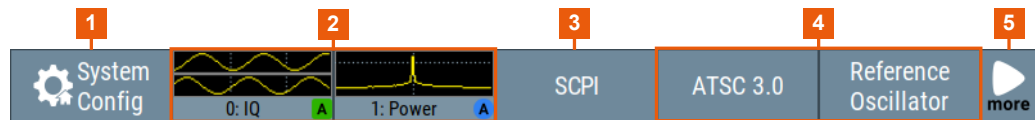

Figure 3-14: Taskbar fully assigned

- 1 = System configuration
- 2 = Graphics
- 3 = Remote control connections
- 4 = Dialogs
- 5 = Diagram / more

1	System Config	Provides access to general system configurations like setup, display, or remote.
2	Graphics	Shows that a signal is represented graphically.
3	Remote	Shows the established remote connections when the instrument is remotely controlled. Tip: An indicator in the status bar shows the current remote control status.
4	Dialogs	Shows a dialog as a thumbnail, the dialog name, and the name of signal channel.
5	Diagram / more	The diagram icon as shown in Figure 3-13 minimizes all dialogs indicated on the screen. The block diagram is in the foreground. The "More" softkey indicates that more dialogs are open than can be displayed in the taskbar. Use this softkey to open a selection list with the remaining active dialogs, and the "Diagram" function.

3.5.3.4 Additional display characteristics

The following section provides a short insight on the indication of the screen in general, and significant elements that you see under specific operating modes, in dialogs or settings.

- **Appearance of active elements**
 - *Active* elements like On/Off switches, state buttons have a **blue** background.
 - *Selected* elements are framed or highlighted **orange**.
 - *Inactive* elements are **gray**.
- **On-Screen keypads**
As additional means of interacting with the instrument without having to connect an external keyboard, either a numerical or alphanumerical on-screen keypad appears when you activate an entry field (see [Chapter 3.5.5, "Entering data"](#), on page 71).
- **Info line**
The "Info line" shows brief status information and error messages. It appears when an event generates a message. If selected, the R&S SMCV100B shows information on static errors and the error history.

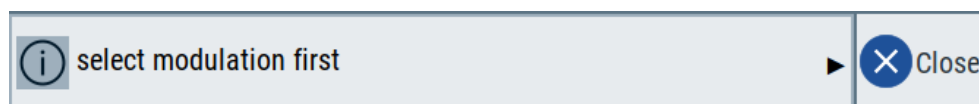

- **Key parameters indicated in tab labels**

Most dialogs are divided into tabs with logically grouped parameters. The tab label expresses the content and can also contain status indicators or the set value of a key parameter.

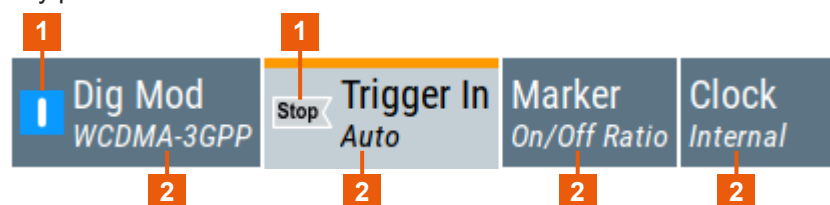

1 = Status indicators

2 = Key parameter values

- **Scroll bar handle**

An arrow icon that appears when you touch a scroll bar helps you to scroll in a dialog or list.

- **Progress indicators**

A busy icon indicates a currently running process. If a process takes some time, a progress bar shows the current state.

- **Context-sensitive menus**

Within the entire screen display, including single parameters, you can access context-sensitive menus that provide some additional functions.

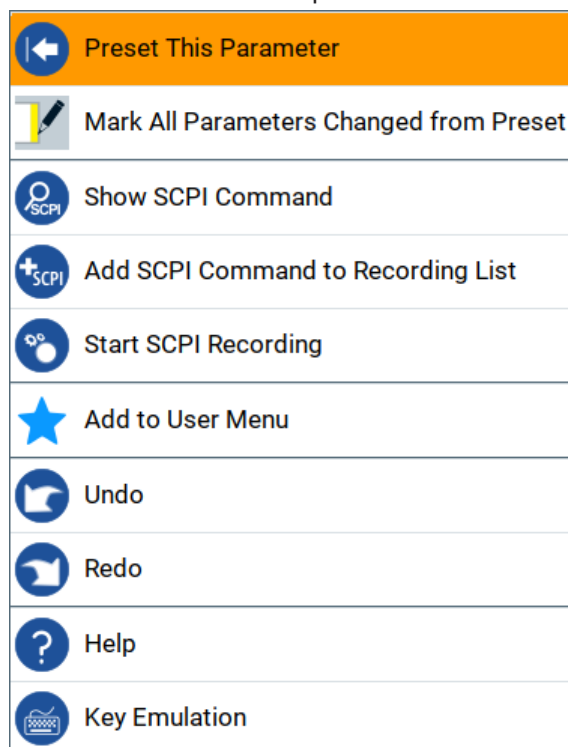

3.5.4 Accessing the functionality

All functionalities are provided in dialog boxes as known from computer programs. You can control the instrument intuitively with the touchscreen. This section provides an overview of the accessing methods.

The instrument's functions and settings can be accessed by selecting one of the following elements:

- System and function keys on the front panel of the instrument
- Taskbar/softkeys on the touchscreen
- Context-sensitive menus for specific elements on the touchscreen, or with the rotary knob (press and hold).
- Elements on the status bar in the touchscreen
- Displayed setting on the touchscreen that means block diagram and all settings available in dialogs.

To open a dialog box

- ▶ Perform one of the following actions:
 - Tap the required block, and then the menu entry.
 - Tap the minimized view (thumbnail) on the taskbar.
- Some of the utility keys access a dedicated dialog, too.

To minimize a dialog box

- ▶ To return to the block diagram, tap the "Home" button.

To close a dialog box

To close a dialog box, you have the same controls as you know from computers or devices with touchscreen.

- ▶ Perform one of the following actions:
 - Tap the "Close" icon in the upper right corner.
 - Press the [Esc] key on the front panel.
 - Drag and drop a minimized dialog from the taskbar to the block diagram.

To select an option in a dialog box

- ▶ Tap the required option.

To select an option in a list

If many options are available - for example, for the trigger mode - the options are provided in a list. The current selection is shown on the list button.

1. Tap in the list.
2. To navigate through the list, try out the following:
 - Using a mouse, scroll in the list to tap the required option.

- Use the rotary knob.

3.5.5 Entering data

Some parameters have their own key on the front panel.

For data input in dialog boxes, the instrument provides on-screen keypads for entering numeric and alphanumeric values. Thus, you can always set the parameters via the touchscreen, the front panel, or an external keyboard.

To correct an entry

1. Using the arrow keys, move the cursor to the right of the entry you want to delete.
2. On the on-screen keyboard, press "Clear".
3. Enter your correction.

To complete the entry

- ▶ On the on-screen keyboard, press "Enter" .

To abort the entry

- ▶ Press the [Esc] key.
The dialog box closes without changing the settings.

3.5.5.1 Entering numeric parameters

To enter values with the on-screen keypad

For numeric settings, the instrument displays the numeric keypad. The units specified correspond to the units of the parameter.

1. Enter the numeric value.

Tip: For quick entry, you can enter a value in exponential representation, e.g. $1e7$ for 10000000 .

2. Tap the unit button to complete the entry.

The unit is added to the entry.

Tip: For quick unit change, you can enter shortcuts, e.g. for a frequency value $1e8h$ for 100 MHz .

For an overview of shortcuts supported by the R&S SMCV100B, see [Chapter A.2, "Unit shortcuts"](#), on page 871.

3. If the parameter does not require a unit, confirm the entered value by pressing "Enter".

If you edit numeric data in tables, the entry field must be in edit mode: Press the rotary knob to activate the edit mode.

3.5.5.2 Entering alphanumeric parameters

If a field requires alphanumeric input, you can use the on-screen keyboard to enter letters and (special) characters.

3.5.5.3 Undo and redo actions

Accessed via the context-sensitive menus, "Undo" allows you to restore one or more actions on the instrument. Depending on the available memory, the "Undo" steps can restore all actions.

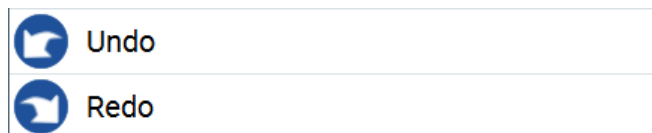

"Redo" restores a previously undone action.

3.5.6 Getting information and help

In some dialog boxes, graphics are included to explain the way a setting works.

For further information, you can use the following sources:

- Tooltips give the value range of the parameter.
- The context help provides functional description on a setting.
- The general help explains a dialog box, provides instructions, and general information.

To display context help

- ▶ To access a help topic, perform one of the following:
 - a) Tap and hold the parameter for which you need information and tap "Help" in the context menu.
 - b) Tap the parameter and press the [Help] key.

The "Help" dialog opens. You can browse the help for further information.

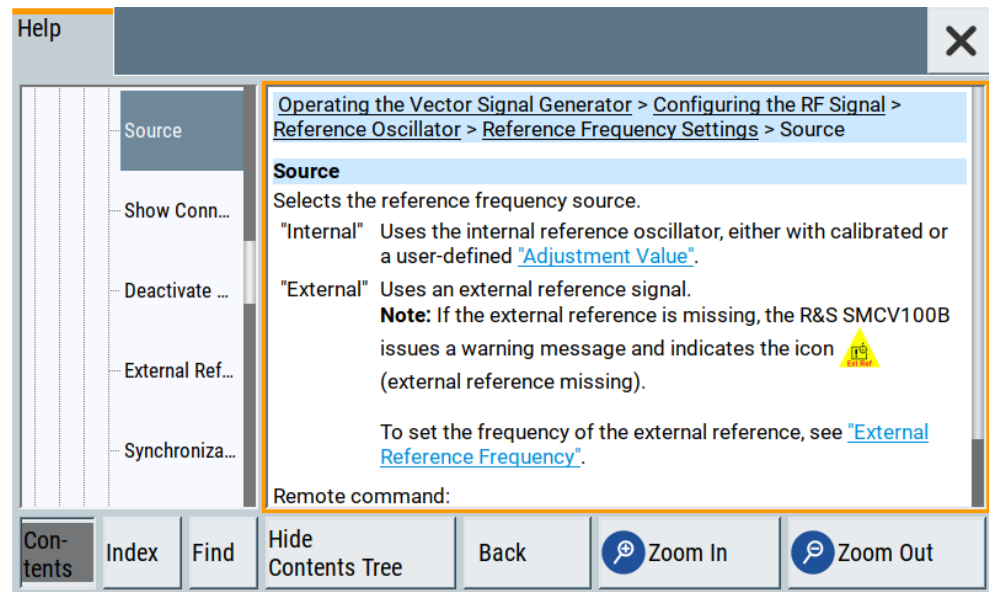

Contents of the help dialog box

The help dialog box covers two main areas:

- "Contents" - contains a table of help contents
- "Topic" - contains a specific help topic

The help system also provides an "Index" and a "Find" area, and "Zoom" functions that are accessed via the corresponding buttons.

To open general help

- ▶ Press the yellow [Help] key on the front panel.

If a dialog box is opened, the help topic for the current tab is shown. Otherwise the "Contents" page appears.

Navigating in the table of contents and in the help topics

1. To move through the displayed contents entries, tap on an entry and scroll or use a connected mouse.
Entries with a plus sign contain further entries.
2. To display a help topic, tap on the topic name or double-click the topic name.
3. To follow a cross-reference, tap on the link text.
4. To return to the previous page, select "Back".
This function scrolls back all steps you have performed before.
5. Use the "scroll bars" to shift the visible section of content shown.
6. To maximize the "Topics" area, tap the "Hide Contents Tree" button to hide the contents tree.

Using the index

1. Select the "Index" button.
2. Enter the first characters of the topic you are interested in.
The entries starting with these characters are displayed.
3. Tap on the index entry.
The corresponding help topic is displayed.

3.5.7 Remote control

In addition to working with the R&S SMCV100B interactively, located directly at the instrument, it is also possible to operate and control it from a remote PC.

The R&S SMCV100B supports various methods for remote control:

- Connecting the instrument to a LAN (see [Chapter 3.1.7, "Connecting to LAN"](#), on page 27)
- Using the LXI browser interface in a LAN



For remote control, you can use the R&S VISA (Virtual Instrument Software Architecture) library provided for download at the Rohde & Schwarz website <http://www.rohde-schwarz.com/rsvisa>.

How to configure the remote control interfaces is described in [Chapter 13, "Network operation and remote control"](#), on page 499.

3.5.8 Remote operation over VNC

The VNC is an application which can be used to access and control the instrument from a remote computer through a LAN connection. While the instrument is in operation, the instrument screen contents are displayed on the remote computer, and VNC provides access to all applications, files, and network resources of the instrument. Thus, remote operation of the instrument is possible.



Instrument control from a remote computer

To access the basic utility functions of the R&S SMCV100B, perform a right mouse click the block diagram and select "Key Emulation".

A key panel to the right of the block diagram gives access to the utility functions provided by the front panel keys.

The VNC is an add-on program, included in operating system Linux/Unix, and available as a free-of-charge download on the internet.

See also [Chapter 13.12, "To operate the instrument using VNC"](#), on page 565.

4 Configuring internal baseband signals

The R&S SMCV100B is a vector signal generator with internal signal generation and real-time functionality and with integrated arbitrary waveform generator.

The instrument enables you to generate various digital modulation signals in accordance with the definitions in the corresponding specifications or with user-definable characteristics. Signals are generated in real time or played from a data storage device with external and internal data. The instrument provides an interface for the loading of externally computed modulation signals in form of waveform files.

4.1 Overview of the signal generation modes

The R&S SMCV100B can generate the signal in the following ways:

- ["Generating digital modulated signals according to various broadcast standards"](#) on page 75
- [Generating a real-time signal](#)
- [Playing a waveform](#)

Generating digital modulated signals according to various broadcast standards

Provided the instrument is equipped with the required digital standard options, the instrument can generate digital standards in accordance with the corresponding specifications.

The required options are specified in the description of the respective digital standard (see the corresponding user manual).

See also [Chapter 4.3, "Generating signals according to broadcast standards"](#), on page 77.

Generating a real-time signal

- While utilizing the *internal* signal generator, the R&S SMCV100B generates the digital modulation signals with user-definable characteristics in real time. See also [Chapter 4.5, "Generating custom digital modulated signals"](#), on page 106.
- If the required options are installed, the *internal* signal generator of the R&S SMCV100B also generates frequency, phase, amplitude and pulse modulation signals in real time. See also [Chapter 4.10, "Generating FM/PhiM/AM/Pulse modulation signals"](#), on page 238.
- If the required options are installed, *externally supplied real-time* baseband signals can be added to the internally generated signals. See also [Chapter 5.3, "Digital baseband input settings"](#), on page 267.

Playing a waveform

The R&S SMCV100B is equipped with an arbitrary waveform generator (ARB) used to generate test signals and to process waveform files. Waveforms are files with settings provided for repeatable tests with the same test signal. Irrespectively of the way these waveform files are generated, they are always played from the instrument. That is, the signal calculation is performed in advance and the instrument reacts as a player.

- Externally computed waveform files can be loaded in the instrument over the LAN or USB.
Create waveforms, for example, with the signal generation software R&S WinIQ-SIM2 or the R&S®Pulse Sequencer software.
- The instrument provides different functions to generate waveforms *internally*.
 - Some of the digital standards firmware options provide the possibility to save the current signal settings into a waveform file. These waveform files can be loaded in and processed as multi-carrier or multi-segment signal by the ARB generator.
See also [Chapter 4.6, "Using the arbitrary waveform generator \(ARB\)"](#), on page 137.
 - Multi-carrier waveforms consisting of carriers modulated by different baseband signals can be configured and created internally. Such multi-carrier waveform files are required to simulate complex multi-carrier scenarios with different baseband signals, e.g. CDMA2000®, 3GPP FDD, or signals in accordance with the LTE-Advanced specifications.
See also [Chapter 4.9, "Generating multi-carrier signals"](#), on page 220.

4.2 Accessing the functions in the baseband domain

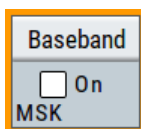

1. In the block diagram, select the "Baseband" block and navigate through the context menu.

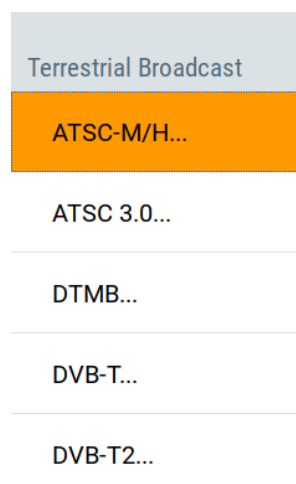

The "Baseband" block comprises all functions and settings concerning the baseband signal. The functions and settings include all generation modes as described in the [Chapter 4.1, "Overview of the signal generation modes"](#), on page 75.

2. By default, baseband signal generation is off.

To activate the baseband generator, in the block diagram, select the "Baseband" block and set "Baseband > On".

Note: The internal baseband generator ("Baseband" block) and the external digital baseband input ("BB Input") cannot run simultaneously. They deactivate each other.

A short designation indicates the digital standard or modulation currently selected.

For information, see:

- [Chapter 4.5, "Generating custom digital modulated signals"](#), on page 106
- [Chapter 4.6, "Using the arbitrary waveform generator \(ARB\)"](#), on page 137
- The description of the digital standards
- [Chapter 4.11, "Shifting and boosting the baseband signal"](#), on page 244

4.3 Generating signals according to broadcast standards

The R&S SMCV100B generates digital signals in accordance with the specifications of the main audio broadcast standards, terrestrial broadcast standards and satellite broadcast standards.

Since the signals are digital baseband signals, broadcast standards in this chapter are also denoted digital standards. For the required digital standard option, see the corresponding digital standard sections below.

ATSC-M/H

The digital standard requires an instrument equipped with the ATSC / ATSC-MH option R&S SMCVB-K161.

The option provides functionality to generate signals in accordance with the ATSC-M/H standard.

For details, see the R&S SMCV100B ATSC-M/H user manual.

ATSC 3.0

The digital standard requires an instrument equipped with the ATSC 3.0 option R&S SMCVB-K162.

The ATSC 3.0 option provides functionality to generate signals in accordance with the ATSC 3.0 standard.

For details, see the R&S SMCV100B ATSC 3.0 user manual.

DTMB

The digital standard requires an instrument equipped with the DTMB option R&S SMCVB-K166.

The option provides functionality to generate signals in accordance with the DTMB (digital terrestrial multimedia broadcast) standard.

For details, see the R&S SMCV100B DTMB user manual.

DVB-T

The digital standard requires an instrument equipped with the DVB-T option R&S SMCVB-K163.

The option provides functionality to generate signals in accordance with DVB-T standard. The standard complies with specification ETSI EN 300 744 (DVB-T and DVB-H).

For details, see the R&S SMCV100B DVB-T user manual.

DVB-T2

The digital standard requires an instrument equipped with the DVB-T2 option R&S SMCVB-K164.

The option provides functionality to generate signals in accordance with DVB-T2 standard. The standard complies with specification ETSI EN 302 755 (DVB-T2).

For details, see the R&S SMCV100B DVB-T2 user manual.

ISDB-T

The digital standard requires an instrument equipped with the ISDB-T/TSB option R&S SMCVB-K165.

The option provides functionality to generate signals in accordance with ISDB-T/ISDB-T_{SB} standard.

For details, see the R&S SMCV100B ISDB-T user manual.

T-DMB/DAB

The digital standard requires an instrument equipped with the DAB/T-DMB option R&S SMCVB-K156.

The option provides functionality to generate signals in accordance with DAB and T-DMB standard.

The DAB standard complies with specification ETSI EN 300 401 "Radio Broadcasting Systems Digital Audio Broadcasting (DAB) to mobile portable and fixed receivers".

The input interface complies with specification ETS 300 799 "Digital Audio Broadcasting (DAB) Distribution Interfaces; Ensemble Transport Interface".

For details, see the R&S SMCV100B T-DMB/DAB user manual.

DVB-S

The digital standard requires an instrument equipped with the DVB-S / DVB-S2 option R&S SMCVB-K167.

The option provides functionality to generate signals in accordance with DVB-S digital video broadcast standards. It also provides functionality to generate basic DVB-S2 signals.

DVB-S is the first-generation DVB standards for satellite services and complies with specification EN 300 421.

For details, see the R&S SMCV100B DVB-S/DVB-S2 user manual.

DVB-S2

The digital standard requires an instrument equipped with the following options:

- DVB-S / DVB-S2 option R&S SMCVB-K167
- DVB-S2x option R&S SMCVB-K168.

The option provides functionality to generate advanced signals in accordance with DVB-S2 and DVB-S2x standards.

DVB-S2 is the second-generation DVB standards for satellite services.

For details, see the R&S SMCV100B DVB-S2x user manual.

DVB-C

The digital standard requires an instrument equipped with the DVB-C/ISDB-C option R&S SMCVB-K157.

The option provides functionality to generate signals in accordance with DVB-C standard. The standard complies with specification ETSI EN 300 429.

For details, see the R&S SMCV100B DVB-C user manual.

J.83/B

The digital standard requires an instrument equipped with the J.83/B option R&S SMCVB-K158.

The option provides functionality to generate signals in accordance with DVB-C standard. The standard complies with specification ITU-T J.83.

For details, see the R&S SMCV100B J.83/B user manual.

DRM

The digital standard requires an instrument equipped with the DRM option R&S SMCVB-K160.

The option provides functionality to generate signals in accordance with the DRM (digital radio mondiale) standard. The standard complies with specification ETSI ES 201 980.

For details, see the R&S SMCV100B DRM user manual.

AM/FM/RDS

The digital standard requires an instrument equipped with the AM/FM/RDS option R&S SMCVB-K155.

The option provides functionality to generate digital audio broadcast signals, such as AM signals, FM mono signals and FM stereo signals. FM stereo signals require the RDS (radio data system) coder.

For details, see the R&S SMCV100B AM/FM/RDS user manual.

4.4 Common functions and settings in the baseband domain

This chapter describes basic signal generation settings that are common to many generation tasks, regardless of the selected baseband source or digital standard. If you perform a specific signal generation task, be sure to check the specific description for settings that can deviate from these common settings. For example, a specific signal generation task is to generate a signal according to a digital standard.

4.4.1 Basics on signals, modulation types and filters

This section provides general information on common topics and basic principles.

- [Data, clock and control signals and sources in the baseband](#)..... 80
- [Regular marker output signals](#)..... 84
- [Baseband trigger signals](#).....86
- [Supported modulation signals](#).....94
- [Supported coding schemes](#).....95
- [Supported baseband filters](#)..... 96
- [Methods for optimizing the crest factor](#)..... 98

4.4.1.1 Data, clock and control signals and sources in the baseband

This section describes common characteristics of the signals used for generating the baseband signal for all standards. Common characteristics do not depend on the used generation mode.

The selection in the dialogs at any given time depends on the parameter and standard concerned. It is clear from the selection list offered in the dialog. Some parameters are therefore not available in certain cases.

Characteristics specific to particular standards are described in the corresponding user manual.

For the generation of modulation signals, the instrument uses the following input signals:

- [Internal modulation data](#)
- [Clock signals](#)

- [Control signals](#)

Signal sources

The data, the clock and the trigger signals can be both internally generated and supplied from an external source. Control signals however are always generated internally.

Depending on the current configuration, the internally generated data and marker signals are output on one or several connectors. The output capabilities of the instrument and the required connectors are configurable.

See also [Chapter 12.2, "Configuring global connectors"](#), on page 449.

Internal modulation data

The R&S SMCV100B uses the following internal modulation data sources:

- **Data lists**

Data lists are externally or internally created binary lists with modulation data.

The instrument provides standard file select function for loading of existing data lists, creating internally new data lists or editing an existing one. Internally, data lists are created in the dedicated "Data List" editor (see [Chapter 4.5.3.7, "Data list editor"](#), on page 118). A separate file is created for each list and saved on the instrument's hard disk. The filename is user-defined; the file extension is `*.dm_iqd`.

The maximum length of a data list is determined by the size of the data list memory (see data sheet). There is no restriction on the number of lists that can be saved. Settings for file handling, like transferring external data lists to the instrument, or renaming of folders and files, are accessed via the standard "File Manger" function. (See also [Chapter 11, "File and data management"](#), on page 413).

- **Data patterns**

Simple data patterns such as binary 0 ("All 0") strings or 1 ("All 1") strings or variable bit strings with a maximum length of 64 bits can be used as internal modulation data.

- **PRBS data**

The PRBS generators deliver pseudo-random binary sequences of differing length and duration. They are known as maximum length sequences. PRBS sequences are generated with the aid of ring shift registers with feedback points determined by the polynomial.

The pseudo-random sequence from a PRBS generator is uniquely defined by the register number and the feedback. The [Table 4-1](#) describes the available PRBS generators.

For PRBS15 and PRBS23, a CCITT V.52-compliant data inversion is performed in the feedback path automatically.

Table 4-1: Overview of PRBS generators

PRBS generator	Length in bits	Feedback to	GUI selection
9-bit	$2^9 - 1 = 511$	Registers 4, 0	PRBS 9/PN9
11-bit	$2^{11} - 1 = 2047$	Registers 2, 0	PRBS 11/PN11
15-bit	$2^{15} - 1 = 32767$	Registers 1, 0	PRBS 15/PN15

PRBS generator	Length in bits	Feedback to	GUI selection
16-bit	$2^{16} - 1 = 65535$	Registers 5, 3, 2, 0	PRBS 16/PN16
20-bit	$2^{20} - 1 = 1048575$	Registers 3, 0	PRBS 20/PN20
21-bit	$2^{21} - 1 = 2097151$	Registers 2, 0	PRBS 21/PN21
23-bit	$2^{23} - 1 = 8388607$	Registers 5, 0	PRBS 23/PN23

Example:

By way of example, the diagram on [A 9-bit PRBS generator](#) shows a 9-bit generator with feedback to registers 4 and 0 (output). The generated serial data is converted internally, e.g 2 Bit/Symbol if QPSK is used.

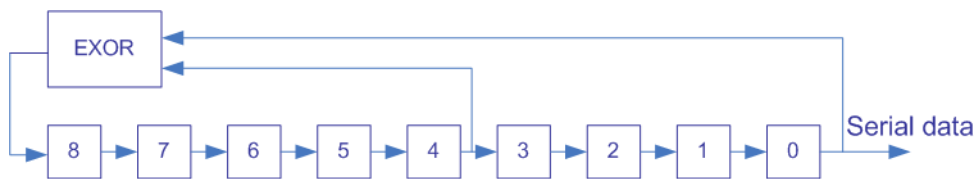

Figure 4-1: A 9-bit PRBS generator

Related settings:

- [Chapter 4.5.3.3, "Data source"](#), on page 110
- [Chapter 4.5.3.7, "Data list editor"](#), on page 118
- [Chapter 4.5.3.8, "Control and marker lists editor"](#), on page 120
- "Data Source" selection in the dialogs of the firmware options

Clock signals

The instrument requires a clock reference for generating the timing pulse and uses its internal clock reference for that purpose.

Currently, you cannot output the internally generated symbol clock signal.

Synchronizing data signals and clock signals

The synchronization is always based on the positive edge of the clock.

Related settings:

- [Chapter 4.4.2.3, "Clock settings"](#), on page 105
- [Chapter 12.2, "Configuring global connectors"](#), on page 449

Control signals

The following control signals are processed in the R&S SMCV100B:

- "Burst Gate" for power ramping
- "Level Attenuation" for power ramping
- "CW/Mod" for controlling the CW (continuous wave) mode

A dedicated internal "Control Data Editor" is provided for defining the control signals. Refer to [Chapter 4.5.3.8, "Control and marker lists editor"](#), on page 120 for a description on the provided settings.

Continuous wave mode

The "CW" signal turns off digital modulation. The signal is output in unmodulated form.

Power ramping and level attenuation

The R&S SMCV100B uses the two control signals "Burst Gate" and "Lev_Att" to trigger the power ramping and level attenuation functions.

The instrument internally generates control signals as configured in [Chapter 4.5.3.8, "Control and marker lists editor"](#), on page 120; the signals can be output on the User x connectors.

- *Burst gate control signal*
The "Burst Gate" signal is a rectangular pulse signal with variable low and high periods. Signal generation is restricted to the gate high periods. If the power ramping function is enabled, each transition between two gate periods of the "Burst Gate" signal triggers the generation of a ramp. Further settings define the form and the steepness of this ramp, see ["Impact of the power ramping settings on the generated signal"](#) on page 83.
- *Level attenuation control signal*
The "Lev_Att" signal is a rectangular pulse signal with variable low and high periods. Level attenuation is applied, if the "Lev_Att" signal is high. If level attenuation is enabled, the modulation signal level is attenuated by a defined value.

Related settings:

- [Chapter 4.5.3.6, "Power ramp control settings"](#), on page 116



Possible applications

- Use the "Level Attenuation" function to simulate radio stations located at various distances.
- Use the "Power Ramp" function if it is necessary to control the RF output signal envelope synchronously, e.g. by the generation of TDMA signals.

Both the GSM/EDGE and the TD-SCDMA firmware options are equipped with embedded power ramping function. In the GSM/EDGE standard for example, a maximum of 7 different level attenuation values can be defined and allocated separately to the 8 slots independently of one another.

Impact of the power ramping settings on the generated signal

The [Figure 4-2](#) explains the power ramping function in principle. The "Burst Gate" signal defines the start of the rising and falling edges of the envelope of the output signal, and the "Lev Att" signal defines the start and end of level attenuation. The signal level during the attenuation period is a configurable value.

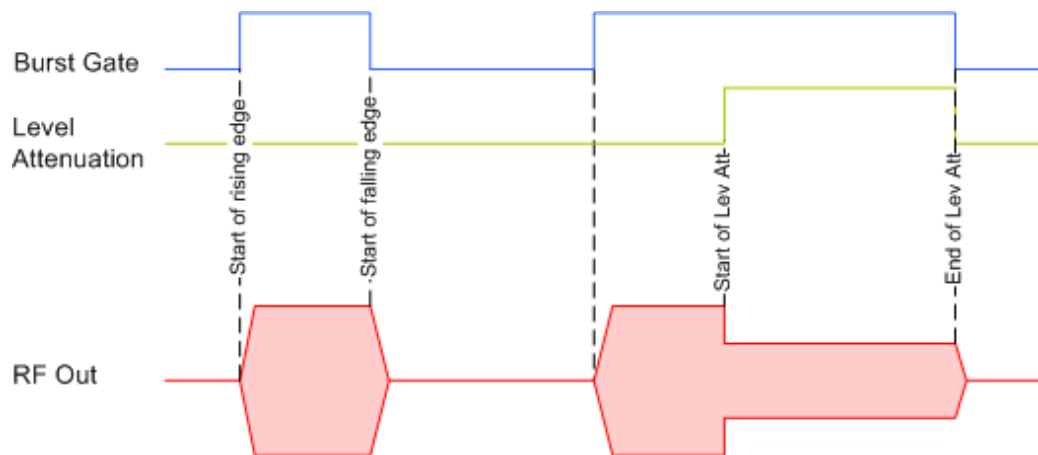

Figure 4-2: Signal behavior when power ramping and level attenuation are enabled

Several parameters are provided for precise definition of the form and the steepness of ramp. The Figure 4-3 depicts the impact of the provided settings.

- Ramp function: defines the shape of the rising and falling edges
- Ramp time: defines the duration of the rising and the falling ramp
- Rise/fall delay: offsets the falling edge of the envelope at the beginning/end of a burst

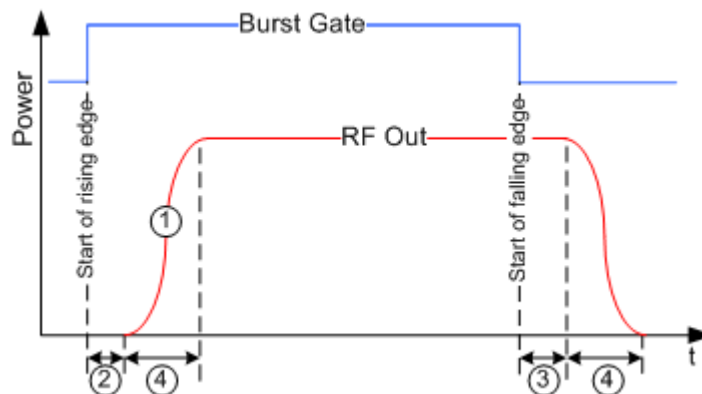

Figure 4-3: Impact of the ramp settings

- 1 = "Ramp Function"
 2, 3 = "Rise Delay", "Fall Delay"
 4 = "Ramp Time"

4.4.1.2 Regular marker output signals

The R&S SMCV100B can add *additional signals* to the generated signal. Marker signals (or markers) are digital signals which can be used to synchronize external devices to the generated data stream. For example, with suitable marker settings, a slot clock or frame clock can be selected, or the start of a particular modulation symbol can be marked.

Two marker output signals are available; they can be output at the User x connectors.

Related settings:

- [Chapter 4.4.2.2, "Marker settings"](#), on page 104
- [Chapter 12.2, "Configuring global connectors"](#), on page 449
- Marker settings in the dialogs of the firmware options

Marker modes

Marker mode restart

The generated marker signal is a single "On" pulse. The rising edge of this pulse is generated at the signal generation start and at each subsequent signal restart time. This marker can be used to monitor the effects of the selected trigger, e.g. trigger causing restarts of the signal generation.

Marker mode pulse

Periodic marker with consecutive On and Off periods of equal length. The first On period starts at the beginning of the first generated sample/symbol. The marker frequency is defined by a "Divider". The frequency is derived as follows:

<Frequency> = "Symbol/Sample Rate" / "Divider", respectively

<Frequency> = "Sampling Frequency" / "Divider".

Example:

"Symbol Rate = 1 Msym/s", "Divider = 2"

The marker frequency is 500 kHz, corresponding to a marker period of 2 μ s. Each On and Off period has a length of 1 μ s, corresponding to one symbol period. With a divider of 4 (6, 8 ...), the length of each On and Off period is increased to 2 (3, 4, ...) symbol periods.

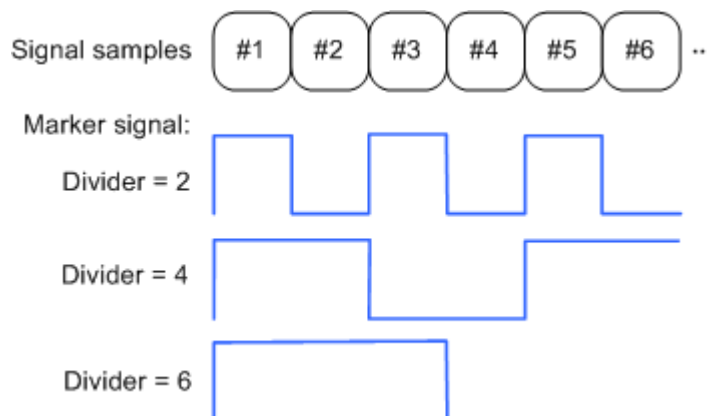

Marker mode pattern

Periodic marker where each period is defined by a bit pattern with a maximum length of 64 bits. A "1" ("0") in the pattern denotes an On (Off) signal segment with a duration of one sample/symbol period.

Example:

In the following example, the marker signal is defined by a pattern *100100...*

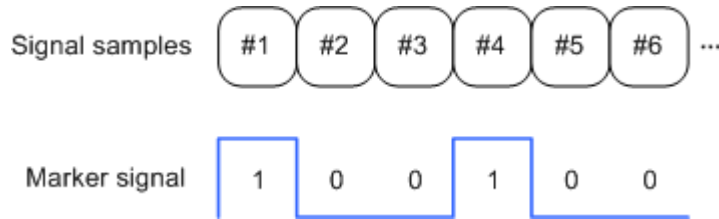
**Marker mode On/Off ratio**

Similar to "Pulse" but with independent lengths of the On and Off periods. The length of the periods is entered as several symbols/sample periods.

Example:

In the following example, the marker signal is defined by an "On Time" = 1 and "Off Time" = 2.

**Marker mode CList**

The instrument generates a marker signal that is defined in the selected control list. The R&S SMCV100B provides a graphical interface for convenient definition of control signals among others also for the marker signals.

Delaying marker signals

In all the examples listed in "[Marker modes](#)" on page 85, the marker starts at the beginning of the first generated sample/symbol (sample/symbol no. 1). It is possible though to delay the start of the marker by an integer number of symbols/sample periods.

4.4.1.3 Baseband trigger signals

The R&S SMCV100B provides several trigger modes, different trigger sources, and some additional trigger settings to suppress or delay the trigger events. This section provides an overview of the provided baseband trigger settings and the impact of the trigger settings on the signal generation.

The current signal generation status ("Running" or "Stopped") is continuously displayed in the corresponding dialog, indicated in the header of the tab and in the block diagram of the instrument. This indication is important when an external trigger is applied.

For information on the trigger signals used in the RF domain, see [Chapter 8.9.1, "Signal generation and triggering in the sweep and list modes"](#), on page 318.

Trigger

The trigger signals are internally generated or externally supplied signals which start signal generation at a particular point in time. However, signal generation can also take place without triggering. In this case, the signal generation starts immediately after the modulation is enabled.

Trigger event

A trigger event is caused by the received trigger signal. Another possibility to provoke a trigger event is to execute trigger manually. The "Arm" function stops the signal generation until subsequent trigger event occurs.

- [Trigger sources](#)..... 87
- [Impact of the trigger modes on the signal generation](#)..... 87
- [Impact of the additional trigger settings](#)..... 91
- [Receiving and providing trigger signals](#)..... 94

Trigger sources

The provided trigger sources are divided into two main groups, internally generated or externally supplied trigger signals.

- Internal ("Internal")
Internal trigger signals are generated by the instrument itself.
- External ("External Global Trigger")
External trigger signal is generated by an external trigger source.
The instrument expects the trigger signal at one of the User x connectors. Refer to [Configuring global connectors](#) for information on how to configure the required settings.



The trigger mode setting, the selection of the trigger source and the setting of a delay and trigger suppression in the case of external triggering are carried out independently. However, the polarity and impedance characteristics of the external signals are identical for all basebands using this signal.

A signal which marks the trigger event can be output at the User x connectors.

Related settings:

- [Chapter 4.4.2.1, "Trigger settings"](#), on page 101
- [Chapter 12.2.5, "Global connectors settings"](#), on page 454

Impact of the trigger modes on the signal generation

A trigger event affects the signal generation in different way, depending on the selected trigger mode. The [Table 4-2](#) gives an overview of the provided trigger modes and their impact.

Table 4-2: Impact of the trigger events on the generated signal

"Trigger Mode"	Signal generation mode ¹⁾	1st Trigger event "Exec. Trigger" or "External" trigger signal	Subsequent trigger event "Exec. Trigger" or "External" trigger signal	Trigger event "Arm"
"Auto" See Figure 4-5	Continuous	-	-	-
"Retrigger" See Figure 4-6	Continuous	Initial start	Restart	-
"Armed_auto" See Figure 4-7	Continuous	Initial start	Restart (only after previous "Arm")	Stop
"Armed_retrigger" See Figure 4-8	Continuous	Initial start	Restart	Stop
"Single" See Figure 4-4	Single length determined by "Trigger Signal Duration"	Initial start	Restart	-

¹⁾ The instrument generates a continuous signal or a single signal.

- Single signal generation means that the signal generation stops after one cycle. That is, after the signal with signal length determined by the "Trigger Signal Duration" has been generated.
- Continuous transmission means that the signal is generated repeatedly without delay and until the data generation is stopped explicitly. However, any parameter change within the processing chain (baseband, fading simulator, or stream mapping) causes a signal generation restart.

The following is a list of the trigger modes together with their short description. An example of their impact on the generated signal is given. The provided examples are intended to show the triggering mechanism in principle. To simplify the description, an internal trigger event ("Execute Trigger") is used. An external trigger event has the same effect on the signal generation. In the examples on the figures below, the instrument's processing time is ignored.

- **Single**
The instrument starts the signal generation only when a trigger event occurs. The signal is generated once. Its signal length is set with the parameter "Trigger Signal Duration".
Every subsequent trigger event causes a restart.

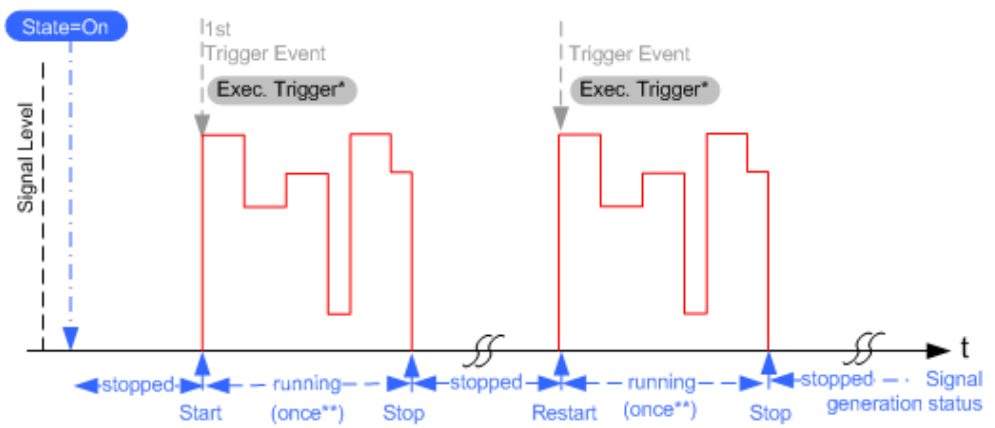

Figure 4-4: Trigger mode single

* = Internal trigger event (to simplify the description)

** = The signal is generated once to the length specified with "Trigger Signal Duration"

- Auto

In auto trigger mode, the instrument generates a continuous signal.

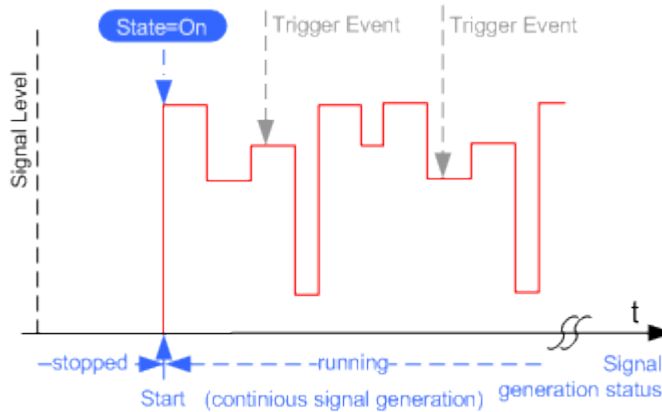

Figure 4-5: Trigger mode auto

- Retrigger

The instrument generates a continuous signal. With enabled retrigger, a new trigger event aborts the current generation cycle and restarts the signal generation from the beginning.

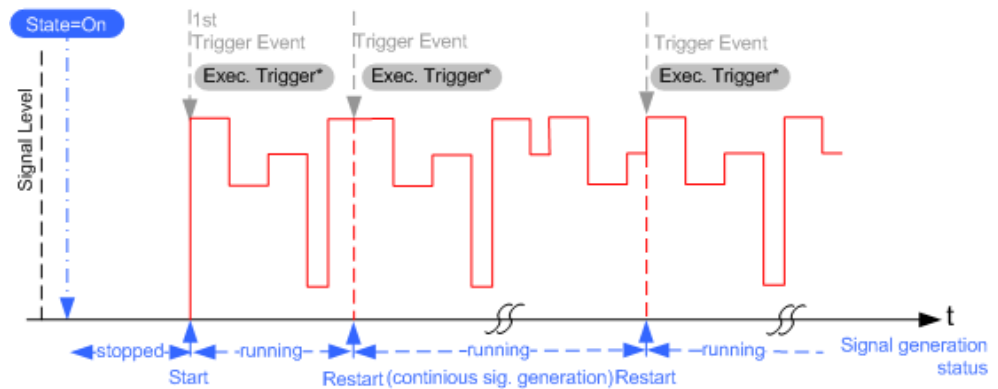

Figure 4-6: Trigger mode retrigger

* = Internal trigger event (to simplify the description)

Compare the shape and the length of the red curve in single mode and in retrigger mode. The first part of the curve in retrigger mode is shorter. The signal generation is interrupted due to the subsequent trigger event.

- **Armed auto**
The instrument starts the signal generation only when a trigger event occurs and then generates a continuous signal. An "Arm" stops signal generation. A subsequent trigger event causes a restart of the signal generation.

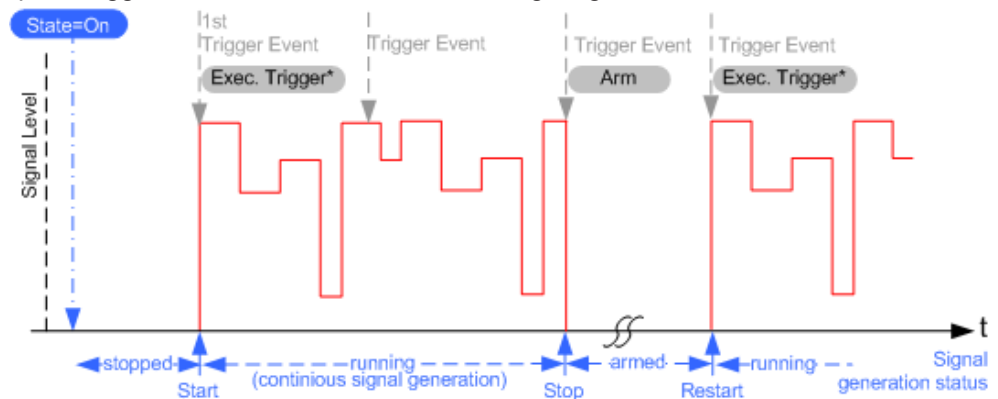

Figure 4-7: Trigger mode armed auto

* = Internal trigger event (to simplify the description)

- **Armed retrigger**
The instrument starts the signal generation only when a trigger event occurs and then generates a continuous signal. Every subsequent trigger event causes a restart of the signal generation.
An "Arm" stops the signal generation. A subsequent trigger event causes a restart.

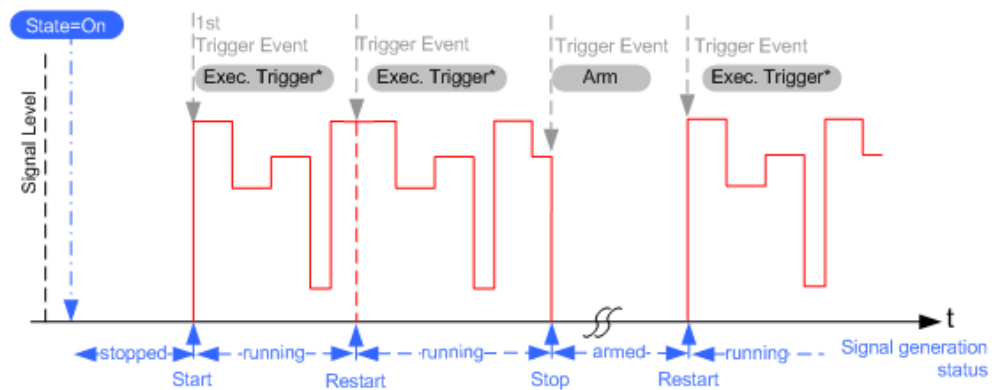

Figure 4-8: Trigger mode armed retrigger

* = Internal trigger event (to simplify the description)

Impact of the additional trigger settings

The R&S SMCV100B provides a set of settings to configure the behavior upon receiving of a trigger signal. For example:

- Suppressing trigger events
- Delaying the instrument's response on trigger events
- Adjusting the signal calculation start time in relation to the trigger event.

Avoiding accidental trigger events

The following trigger settings enhance the flexibility of the trigger system and can help to avoid accidental trigger events.

- "Threshold Trigger Input"
Defines the voltage level of the trigger signal where the R&S SMCV100B generates a trigger event. Trigger signals below the trigger threshold are ignored.
- "Trigger Input Slope"
Specifies the edge (rising or falling edge) of the trigger signal that is to provide the trigger event.
- "Impedance Trigger Input"
Specifies the input impedance of the trigger signal.

Starting the signal generation with the first sample

By default, the instrument starts the signal calculation simultaneously with the receiving of the external trigger event. Because of the signal propagation time and the instrument's processing time, the first samples are cut off and no signal is output.

This default behavior, however, can cause problems if short signal sequences are generated. To overcome this problem, the instrument provides the special parameter "Sync. Output to (External) Trigger". If this parameter is disabled, the signal output begins after elapsing of the processing time and starts with sample 0. That is, the complete signal is output (compare both figures in [Table 4-3](#)).

Table 4-3: Impact of the parameter Sync. Output to (External) Trigger

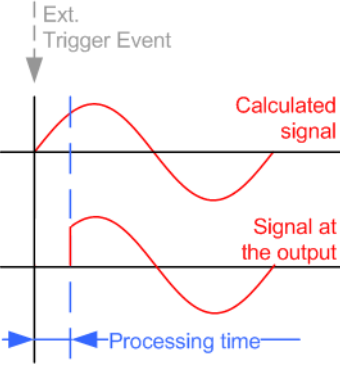
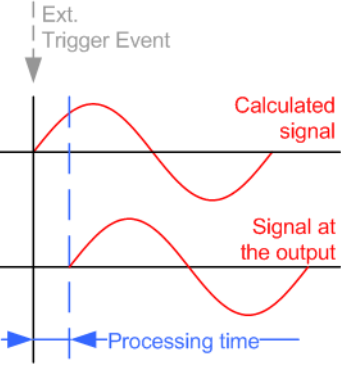
"Sync. Output to (External) Trigger = On"	"Sync. Output to (External) Trigger = Off"
 <p data-bbox="405 748 906 844">Suitable for long signal sequences The output signal is synchronous to the trigger event after elapsing of the internal processing time.</p>	 <p data-bbox="925 748 1426 844">Suitable for triggering of short signal sequences with signal duration comparable with the processing time of the instrument</p>

Suppressing and delaying trigger events

The main focus of the following features is the mobile communication standards.

- "(External) Trigger Delay"

You can apply a definable number of symbols to delay the **start** trigger event of an externally supplied trigger signal

This feature is useful to:

 - Simulate the time delay between a base station signal and a user equipment signal, for example during base station tests
 - Compensate for known propagation delays or a timing offset in the test setups
- "(External) Trigger Inhibit"

You can suppress the effect of a restarted trigger signal in the "Retrigger" trigger mode for a definable number of symbols.

During base station tests, for example, this feature enables the trigger suppression for a definable number of frames and yet the signal can still be generated synchronously. In each frame, the base station generates a trigger which would cause a signal generation restart every time but for the suppression.

Example:

A trigger delay of 1000 samples means that after a trigger event, any subsequent trigger signal is ignored for the space of 1000 samples.

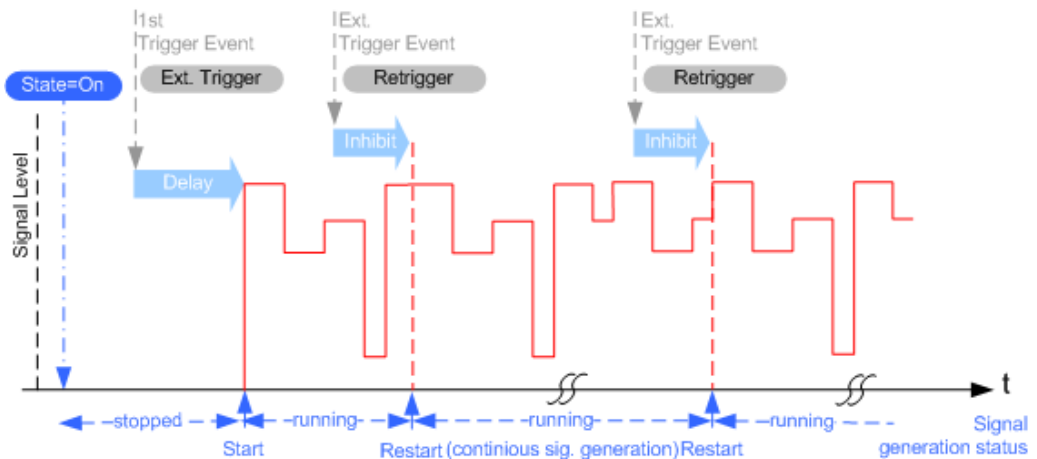

Figure 4-9: Trigger delay and trigger inhibit in trigger mode retrigger

Specifying delay and inhibit values

Trigger delay and inhibit values are expressed in the units of the generated signal, e.g. in samples or symbols. You can also define the exact delay or inhibit period as a time value, e.g. in seconds.

Trigger delay values t_{delay} depend on the instrument hardware. The table illustrates an exemplary instrument configuration and related t_{delay} values in samples (or symbols) and in seconds.

Option	Max. r_s / MHz	t_{delay} / samples	t_{delay} / s
Base unit	750	0 to depends on sample rate	0 to 1466

For more information, see the data sheet.

Example: Trigger delay and ARB clock frequency

The example is based on an ARB signal with 1 MHz clock frequency ("Baseband > ARB > Clock Frequency = 1 MHz").

Step 1: Enable the following settings:

- "ARB > Trigger In > Mode > Armed Auto"
- "ARB > Trigger In > Source > External Global Trigger 1"
- "ARB > Trigger In > External Delay Unit > Samples"
- "ARB > Trigger In > External Delay = 100 Samples"

The parameter "Actual External Delay = 100 us" displays the time delay in seconds.

External Delay Unit	Sample	Processing Time	---
External Delay	100.00 Samples	Actual External Delay	100.000 0 μ s

Step 2: Enable the following settings:

- "ARB > Trigger In > External Delay Unit > Time"
- "ARB > Trigger In > Specified External Delay = 10 us"
Logically, the "Actual External Delay" changes to 10 us.

External Delay Unit	Time	Processing Time	---
Specified External Delay	100.000 0 µs	Actual External Delay	100.000 0 µs

Step 3:

- Switch to "ARB > Trigger In > External Delay Unit > Samples".

The value of "ARB > Trigger In > External Delay" is 10 samples.

External Delay Unit	Sample	Processing Time	---
External Delay	10.00 Samples	Actual External Delay	10.000 0 µs

Receiving and providing trigger signals

In test setups that combine the signal of two or more instruments it is often required that:

- The signal generation starts at a defined moment
- The signal generation starts simultaneously (or with an exactly defined delay) in all involved instruments.

For information on triggering the R&S SMCV100B externally, see [Chapter 3.3.3, "Triggering the instrument with an external signal"](#), on page 47.

4.4.1.4 Supported modulation signals

The R&S SMCV100B supports a range of predefined digital and analog modulation signals. All related signals are baseband signals and digitally modulated onto the analog RF carrier.

In communication techniques, commonly used digital modulation schemes are based on keying. From the several existing keying techniques, this instrument supports ASK (amplitude shift keying), FSK (frequency shift keying), PSK (phase shift keying), and QAM (quadrature amplitude modulation).

The digital modulation procedure is described by mapping. That is, by the assignment of I and Q values (PSK and QAM) or frequency shifts (FSK) to every modulation symbol. The resulting modulated signal is graphically represented by a constellation diagram, in that each possible symbol is represented by a discrete point on a complex plane. The number of used bits per symbol is a modulation parameter. The exact position of the symbols on the constellation diagram is determined by the used coding scheme. You can also change the symbol position by applying rotation.

Most of the provided modulation schemes are implemented according to a communication standard. The QAM procedures 16QAM, 32QAM, 64QAM, for instance, have been

produced in accordance with ETSI standard ETS 300429 for digital video broadcasting (DVB). The QAM procedures 256QAM and 1024QAM are not specified in this standard, but have been produced according to the same basic principles.

For all FSK procedures you can set the symbol rate f_{SYMB} up to a maximum value, see data sheet. The frequency deviation (FSK deviation) of the MSK modulation is permanently set to $\frac{1}{4}$ of the symbol rate. Also a variable FSK modulation with definable deviation per symbol is available and for even greater flexibility. A user-defined modulation mapping can be applied, see ["User mapping"](#) on page 95.

User mapping

A user-defined modulation-mapping file can also be selected as modulation-mapping source. Valid files have the extension `*.vam` and can be created with the Rohde & Schwarz software tool-mapping wizard. The mapping wizard "mapwiz" is a tool from Rohde & Schwarz designed for editing modulation schemes (for example QPSK, 32QAM).

The main purpose of "mapwiz" is the assignment of logical symbol numbers to constellation points and the selection of modulation-specific parameters. Also, the tool supports the creation of nearly any arbitrarily chosen constellation diagram. The output of "mapwiz" is a mapping file (`*.vam`) that can be imported into a R&S SMCV100B. The program was developed on a 32-bit Microsoft Windows platform under MATLAB.

For more information, see "Introduction to "mapwiz" Mapping Editor" at the Rohde & Schwarz webpage.

The remote commands required to define the modulation settings are described in [Chapter 14.16.3.2, "SOURce:BB:DM subsystem"](#), on page 663.

Related settings:

- [Chapter 4.5.3.4, "Modulation settings"](#), on page 112

4.4.1.5 Supported coding schemes

Coding is a technique used to improve the signal properties and signal reception and is required only when using some types of modulation. In general, the coding schemes are applied before modulation. The modulation symbols are coded directly before I and Q values or frequency shifts are assigned. The applied coding is directly related to the selected modulation methods. The relation implies that coding schemes are not freely combinable with the modulation methods.

Refer to [Chapter 4.5.5.1, "Common coding algorithms"](#), on page 130 for overview on the available coding combinations. This section also defines the modulation types for which the various coding procedures can be used.

Related settings:

- ["Coding"](#) on page 109

4.4.1.6 Supported baseband filters

In the wireless transmission technique, filters are applied to shape the baseband signal before it is modulated on the RF. The selected baseband filter type and shape affect the output stream, especially while generating broadband signals. If the filter is too narrow, it cuts the signal. If the filter is too wide, the signal could be distorted by some unwanted signals.

To fulfill wide range of requirements, the R&S SMCV100B offers a wide selection of predefined baseband filters. The predefined filters are designed for the special spectrum characteristics of the different communication standards. However, depending on the selected filter form one or more filter parameters are provided for even more precise adjustment of the filter characteristic. You can select, for example, steeper edges or change the transition bandwidth. For more information on the provided settings, see ["Impact of the filter parameters"](#) on page 96.

The selection of user-defined filters offers even more flexibility. Use these filters if you need to filter with filters of complex or proprietary form are required. For more information, refer to ["User filter"](#) on page 96.

Predefined baseband filters

See [Chapter 4.5.5.2, "Predefined baseband filters"](#), on page 132 for an overview of available baseband filters.

User filter

The user filter file must have extension `*.vaf` and can be created with the Rohde & Schwarz software tool filter wizard.

The filter wizard (filtwiz) is a tool from Rohde & Schwarz designed for creating filter files that can be imported on a R&S SMCV100B. Its main purpose is the conversion of user-defined finite impulse response (FIR) filters into the filter format (`*.vaf`). Beyond this filt wiz provides designs for standard filters, e.g. root raised cosine (RRC), Gaussian.

The program was developed on a 32-bit Microsoft Windows platform under MATLAB.

For more information, see "Introduction to "filtwiz" Filter Editor" at the Rohde & Schwarz webpage.

The remote commands required to define the filter settings are described in [Chapter 14.16.3.2, "SOURce:BB:DM subsystem"](#), on page 663 and the corresponding section in the user manual of each firmware option.

Related settings:

- [Chapter 4.5.3.5, "Filter settings"](#), on page 114
- Filter settings in the dialogs of the firmware options

Impact of the filter parameters

The following is a simple description of the filter parameters and the way they affect the main filter characteristics. Changing filter parameters is an effective way to ensure that

the entire bandwidth of the desired signal is allowed to pass and adjust the filter form to reach the spectrum mask requirements.

Cut Off Frequency

The cut-off frequency or corner frequency is a filter characteristic that defines the frequency at the 3 dB down point. This frequency is bound to the transition band; here the filter characteristic changes from the passband to the stopband, where the signal is suppressed.

Rolloff Factor

The rolloff factor is a measure for the excess bandwidth compared to the ideal bandwidth of a "brick like" filter. The roll off factor affects the steepness of the filter flanks. A "Rolloff Factor" = 0 would result in the steepest theoretically possible flanks ; values near to 1 make the flanks more flat.

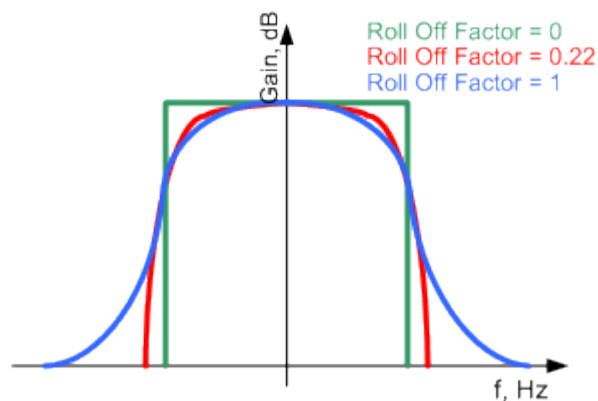

Passband

The passband describes the frequency span that the filter passes unchanged. The total passband of a filter is given as follows:

$$\text{Bandwidth} = (1 + \text{"Roll Off Factor"}) * \text{"Symbol Rate"}$$

Cut Off Frequency Shift

The "Cut Off Frequency Shift" affects the cut-off frequency in the way that the filter flanks are "moved" and the passband increases by "Cut Off Frequency Shift" * "Sample Rate":

$$\text{Cut Off Frequency} = (1 + \text{"Cut Off Frequency Shift"}) * \text{"Sample Rate"}$$

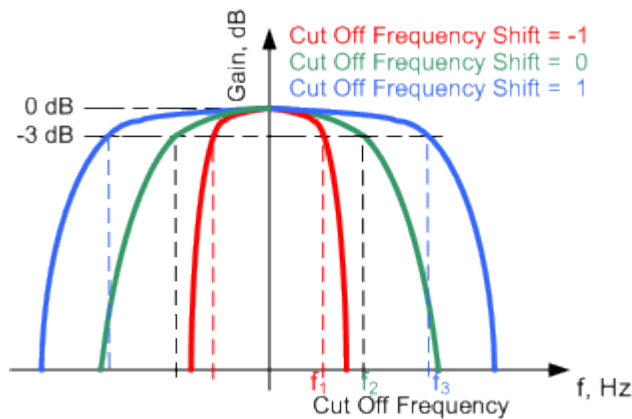

- A "Cut Off Frequency Shift" = -1 results in a very narrow-band filter
- Increasing the value up to 1 makes the filter more broad-band
- By "Cut Off Frequency Shift" = 0, the -3 dB point is at the frequency determined by the half of the selected "Sample Rate".

4.4.1.7 Methods for optimizing the crest factor

Communication standards utilizing higher order modulation techniques or using multiple carrier and complex signals consisting of the signals of more than one digital standard can feature a high crest factor. The signals of some digital standards can have high crest factors also particularly with many channels and long sequences.

The **crest factor** represents the ratio of the peak voltage value to the RMS voltage value, i.e. the peak to average ratio (**PAR**). The higher the crest factor and the resulting dynamics of a signal, the greater the requirement for a power amplifier fed by the signal to be linear. A high crest factor arises for instance, when in a multi carrier signal the carriers feature an identical start phase. This is based on the fact that the carriers are periodically superposed that leads to high peak voltages in relation to the RMS voltage values.

High crest factors entail two basic problems:

- The nonlinearity of the power amplifier (compression) causes intermodulation which expands the spectrum (spectral regrowth).
- Since the level of the D/A converter is relative to the maximum value, the average value is converted with a relatively low resolution. This leads to a high quantization noise.

Both effects increase the adjacent-channel power.

Direct approaches

At the individual signal generation stages, the R&S SMCV100B offers different direct approaches aimed to reduce the crest factor. While the corresponding parameters are enabled, the implemented algorithms ensure minimizing the crest factor or achieving of predefined target crest factor by applying of automatic settings. Methods of reducing the crest factor differ regarding both the optimization achievable and the time required for computation.

The provided crest factor reduction methods include:

- Internal calculation of optimized carrier phases for the individual carriers in a multi carrier signal
- Automatic calculation of the carrier start phases in a multi-carrier continuous wave signal

Applying clipping and filtering

Another common and simple approach for achieving a lower PAR is the combination of clipping and filtering. In several of the firmware options, like 3GPP FDD or CDMA2000, the instrument provides the possibility to enable baseband clipping and to select the baseband filter and, when applicable, to adjust the filter characteristics.

- **Clipping** is a technique that applies a wanted distortion to the signal. The principle includes specifying a threshold, finding out the signal peaks once the defined limits are exceeded and clipping them off. The level limit is specified as a percentage of the highest peak value. Because clipping is done before filtering, the procedure does not influence the spectrum. The error vector magnitude (EVM) however increases.

The instrument offers two clipping modes:

– **Vector $|I + q|$**

The clipping limit is related to the amplitude $|I + q|$. The I and Q components are mapped together, the angle is retained.

– **Scalar $|I| + |q|$**

The clipping limit is related to the absolute maximum of all the I and Q values $|I| + |q|$. The I and Q components are mapped separately, the angle changes.

However, signal clipping not only changes the peak value but also the average value and the effect on the crest factor is unpredictable.

Example:

The following figures demonstrate the effect of the clipping on the crest factor for typical scenarios.

Enabled is clipping with vector mode ($|I+q|$), using a signal configuration with 2 active channels.

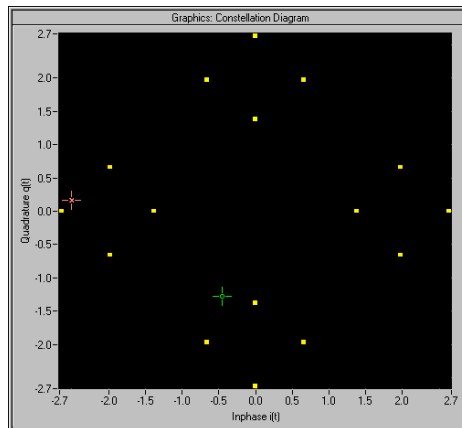

Constellation diagram of the signal without clipping, shows the level mapping

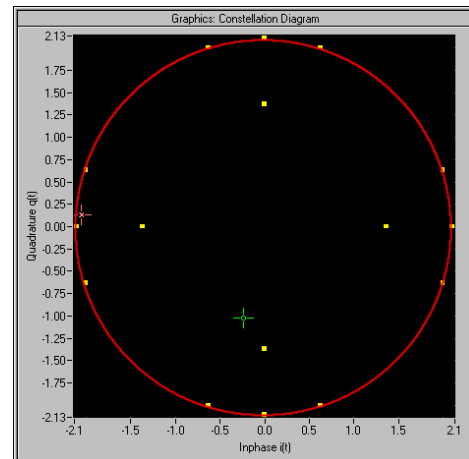

Constellation diagram with clipping level 80%, vector mode ($|I+q|$). The circle emphasizes the changed constellation points

- **Filtering** is applied subsequently. The used filters are specially designed so that they filter out the distortion.

4.4.2 Common settings

The start dialog of each digital standard follows a repeating dialog structure that comprises the tabs "General", "Trigger In", "Marker" and "Clock".

The "General" tab comprises the primary settings of the standard, the functions for storing and recalling settings. It also provides access to further functions and dialogs, like the "Filter" settings.

The "Trigger In", "Marker" and "Clock" tabs comprise the settings related to the corresponding function.

In the following, we use the "Custom Digital Modulation" dialog to explain the provided common settings. The related remote-control commands are listed in the order "Custom Digital Modulation", "ARB", "Multi Carrier CW".



This section focuses on the available settings.

For more information refer to:

- [Chapter 4.4.1.3, "Baseband trigger signals"](#), on page 86.
- [Chapter 4.4.1.2, "Regular marker output signals"](#), on page 84
- ["Clock signals"](#) on page 82



Routing and enabling a trigger

Use the [Global connector settings](#) to configure the signal mapping, the polarity, the trigger threshold and the input impedance of the input connectors.

To route and enable a trigger signal, perform the following *general steps*:

- Define the signal source and the effect of a trigger event.
Select the "Trigger In > Mode" and "Trigger In > Source".
- Define the connector where the selected signal is provided.
Use the "Global Connectors" settings.

4.4.2.1 Trigger settings

Access:

- ▶ Select "Baseband > Custom Digital Mod > Trigger In".

This tab comprises the settings for selecting and configuring the trigger, like trigger source, mode, and delay, and to arm or trigger an internal trigger manually. The current signal generation status is displayed in the header of the tab together with information on the enabled trigger mode. As in the "Marker" and "Clock" tabs, this tab provides also access to the settings of the related connectors.

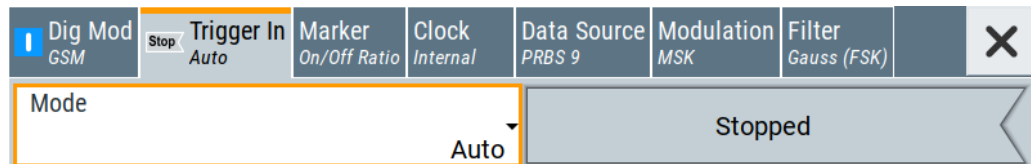

Settings:

Mode.....	101
Signal Duration.....	102
Running/Stopped.....	102
Arm.....	102
Execute Trigger.....	102
Source.....	102
Sync. Output to External Trigger/Sync. Output to Trigger.....	103
External / Trigger Inhibit.....	103
(External) Delay Unit.....	103
(Specified) External Delay/(Specified) Trigger Delay.....	103
Actual Trigger Delay/Actual External Delay.....	104

Mode

Selects a regular trigger signal: "Auto", "Retrigger", "Armed_Auto", "Armed_Retrigger", or "Single".

Refer to "[Impact of the trigger modes on the signal generation](#)" on page 87 for a detailed description of the provided trigger modes.

Remote command:

[\[:SOURce<hw>\]:BB:DM\[:TRIGger\]:SEquence](#) on page 676

[\[:SOURce<hw>\]:BB:ARBitrary\[:TRIGger\]:SEquence](#) on page 724

Signal Duration

Enters the length of the signal sequence to be output in the "Single" trigger mode.

Use this parameter to output part of the signal deliberately, an exact sequence of the signal, or a defined number of repetitions of the signal.

Remote command:

[\[:SOURce<hw>\]:BB:DM:TRIGger:SLENgth](#) on page 676

[\[:SOURce<hw>\]:BB:ARBitrary:TRIGger:SLUNit](#) on page 725

Running/Stopped

With enabled modulation, displays the status of signal generation for all trigger modes.

- "Running"
The signal is generated; a trigger was (internally or externally) initiated in triggered mode.
- "Stopped"
The signal is not generated and the instrument waits for a trigger event.

Remote command:

[\[:SOURce<hw>\]:BB:DM:TRIGger:RMODe?](#) on page 677

[\[:SOURce<hw>\]:BB:ARBitrary:TRIGger:RMODe?](#) on page 724

Arm

Stops the signal generation until subsequent trigger event occurs.

Remote command:

[\[:SOURce<hw>\]:BB:DM:TRIGger:ARM:EXECute](#) on page 677

[\[:SOURce<hw>\]:BB:ARBitrary:TRIGger:ARM:EXECute](#) on page 725

Execute Trigger

For internal trigger source, executes trigger manually.

Remote command:

[\[:SOURce<hw>\]:BB:DM:TRIGger:EXECute](#) on page 677

[\[:SOURce<hw>\]:BB:ARBitrary:TRIGger:EXECute](#) on page 725

Source

The following sources of the trigger signal are available:

- "Internal"
The trigger event is executed manually by the "Execute Trigger".
- "External Global Trigger"
The trigger event is the active edge of an external trigger signal provided and configured at the User x connectors.

The polarity, the trigger threshold, and the input impedance of the input connectors can be configured in the "Global connector settings" dialog.

See ["Trigger sources"](#) on page 87

See also [Chapter 12.2, "Configuring global connectors"](#), on page 449.

Remote command:

`[:SOURce<hw>] :BB:DM:TRIGger:SOURce` on page 676

`[:SOURce<hw>] :BB:ARBitrary:TRIGger:SOURce` on page 724

Sync. Output to External Trigger/Sync. Output to Trigger

Enables signal output synchronous to the trigger event.

For a detailed description of the impact of this parameter, see ["Impact of the additional trigger settings"](#) on page 91.

Remote command:

`[:SOURce<hw>] :BB:DM:TRIGger:EXtErnal:SYNChronize:OUTPut`

on page 677

`[:SOURce<hw>] :BB:ARBitrary:TRIGger[:EXtErnal] :SYNChronize:OUTPut`

on page 725

External / Trigger Inhibit

Sets the duration with that any following trigger event is suppressed. In "Retrigger" mode for example, a new trigger event does not cause a restart of the signal generation until the specified inhibit duration does not expire.

Applies for:

- External trigger signal

For more information, see ["Impact of the additional trigger settings"](#) on page 91.

Remote command:

`[:SOURce<hw>] :BB:DM:TRIGger[:EXtErnal] :INHibit` on page 679

`[:SOURce<hw>] :BB:ARBitrary:TRIGger[:EXtErnal] :INHibit` on page 727

(External) Delay Unit

Determine whether the trigger delay is expressed in samples or directly defined as a time period (seconds).

To specify the delay, use the [\(Specified\) External Delay/\(Specified\) Trigger Delay](#)

The parameter [Actual Trigger Delay/Actual External Delay](#) displays the delay converted in time.

See also ["Specifying delay and inhibit values"](#) on page 93.

Remote command:

`[:SOURce<hw>] :BB:DM:TRIGger:DELay:UNIT` on page 678

`[:SOURce<hw>] :BB:ARBitrary:TRIGger:DELay:UNIT` on page 726

(Specified) External Delay/(Specified) Trigger Delay

The name of the parameter and the units the delay is expressed in, changes depending on the parameter [\(External\) Delay Unit](#).

Delays the trigger event provided by:

- The external trigger source

Use the settings to:

- Synchronize the instrument with the device under test (DUT) or other external devices

For more information, see:

- ["Impact of the additional trigger settings"](#) on page 91

- ["Specifying delay and inhibit values"](#) on page 93

The parameter [Actual Trigger Delay/Actual External Delay](#) displays the delay converted in time.

Remote command:

```
[ :SOURce<hw> ] :BB:DM:TRIGger [ :EXternal ] :DELay on page 678
[ :SOURce<hw> ] :BB:DM:TRIGger [ :EXternal ] :TDELay on page 678
[ :SOURce<hw> ] :BB:ARBitrary:TRIGger [ :EXternal ] :DELay on page 726
[ :SOURce<hw> ] :BB:ARBitrary:TRIGger [ :EXternal ] :TDELay on page 727
```

Actual Trigger Delay/Actual External Delay

Displays the time (in seconds) an external trigger event or a trigger event from the other path is delayed with.

See also ["Specifying delay and inhibit values"](#) on page 93.

Remote command:

```
[ :SOURce<hw> ] :BB:DM:TRIGger [ :EXternal ] :RDELay? on page 679
[ :SOURce<hw> ] :BB:ARBitrary:TRIGger [ :EXternal ] :RDELay? on page 727
```

4.4.2.2 Marker settings

Access:

- ▶ Select "Baseband > Custom Dig Mod > Marker".

This tab provides access to the settings necessary to select and configure the marker output signal, like the marker mode or marker delay settings.

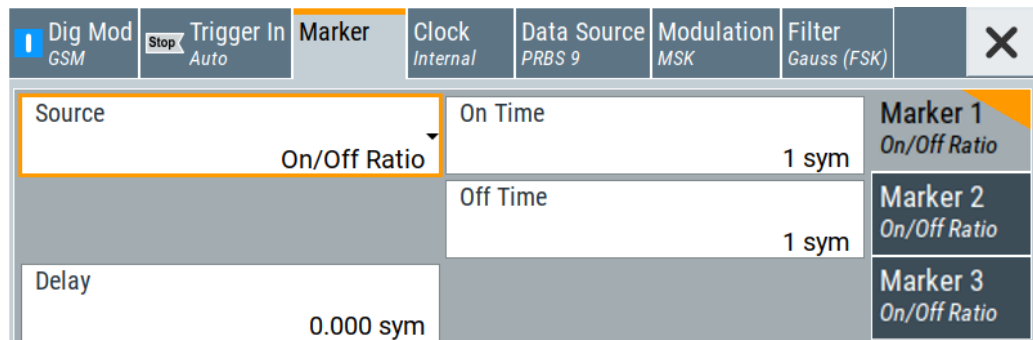

Settings:

[Marker Mode](#)..... 104
[Marker x Delay](#)..... 105

Marker Mode

Basic marker configuration for up to three marker channels. The contents of the dialog change with the selected marker mode.

Use the settings to define the shape and periodicity of the markers. See [Chapter 4.4.1.2, "Regular marker output signals"](#), on page 84 for description of the regular marker signals.

The instrument routes the generated marker signals to the selected output connectors.

See also [Chapter 12.2, "Configuring global connectors"](#), on page 449.

"CList" A marker signal as defined in the selected control list.

Remote command:

[:SOURce<hw>] :BB:DM:TRIGger:OUTPut<ch>:MODE on page 679

[:SOURce<hw>] :BB:DM:TRIGger:OUTPut<ch>:PULSe:DIVider on page 680

[:SOURce<hw>] :BB:DM:TRIGger:OUTPut<ch>:PULSe:FREQuency?
on page 681

[:SOURce<hw>] :BB:DM:TRIGger:OUTPut<ch>:PATtern on page 680

[:SOURce<hw>] :BB:DM:TRIGger:OUTPut<ch>:OFFTime on page 680

[:SOURce<hw>] :BB:DM:TRIGger:OUTPut<ch>:ONTime on page 680

ARB: see ["Marker Mode"](#) on page 151

Marker x Delay

Delays the marker signal at the marker output relative to the signal generation start.

Variation of the parameter "Marker x Delay" causes signal recalculation.

Remote command:

[:SOURce<hw>] :BB:DM:TRIGger:OUTPut<ch>:DELay on page 681

[:SOURce<hw>] :BB:ARBItrary:TRIGger:OUTPut<ch>:DELay on page 729

4.4.2.3 Clock settings

Access:

- ▶ Select "Baseband > Custom Dig Mod > Clock".

The tab provides clock source settings.

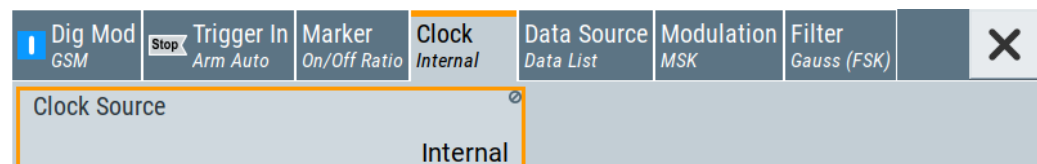

Settings:

[Clock Source](#)..... 105

Clock Source

Selects the clock source.

- "Internal"

The instrument uses its internal clock reference.

See also ["Clock signals"](#) on page 82.

See also [Chapter 12.2, "Configuring global connectors"](#), on page 449.

Remote command:

[:SOURce<hw>] :BB:DM:CLOCK:SOURCE on page 681

[:SOURce<hw>] :BB:ARBItrary:CLOCK:SOURCE on page 730

4.4.2.4 Global connector settings

The "Input Signal" dialog, the "Trigger/Marker/Clock" dialog and "Trigger In", "Marker" and "Clock" tabs in "Baseband > ARB/Custom Digital Mod" configuration dialogs provide quick access to the related connector settings. Click the "Global Connectors" button to access the settings.

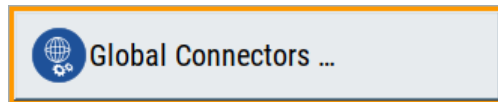

See also [Chapter 12.2, "Configuring global connectors"](#), on page 449.

4.5 Generating custom digital modulated signals

The R&S SMCV100B can generate digital modulation signals with user-definable characteristics. The baseband filtering and the symbol rate can be set within wide limits.

4.5.1 Required options

The equipment layout for generating the digital modulation signals includes:

- Base unit
- Option custom digital modulation (R&S SMCVB-K199)

4.5.2 About the custom digital modulation

An introduction to the supported filter, modulation, and coding schemes are provided in:

- [Chapter 4.4.1.6, "Supported baseband filters"](#), on page 96
- [Chapter 4.4.1.4, "Supported modulation signals"](#), on page 94
- [Chapter 4.4.1.5, "Supported coding schemes"](#), on page 95.

Interdependency between selected modulation type and coding scheme and handling of conflicting settings

The applied coding is directly related to the selected modulation methods. The available coding schemes listed in [Chapter 4.5.5.1, "Common coding algorithms"](#), on page 130 are not freely combinable with modulation methods.

Obviously, having selected a modulation procedure, not every combination of the further modulation parameters "Symbol Rate" and "Coding" is possible. These restrictions inevitably result in conflicting settings if you change a parameter and leads to a prohibited combination.

An inappropriate change of a parameter triggers a settings conflict, which is indicated by a message on the "Info" line in the display. Although the R&S SMCV100B displays

the selected settings, the generated modulation signal does not correspond to this display. The displayed message disappears when a conflict-free setting is selected.

Refer to [Chapter 15, "Troubleshooting and notifications"](#), on page 840 for a list of the possible settings conflicts and messages in digital modulation.

4.5.3 Custom digital modulation settings

Access:

- ▶ Select "Baseband > Custom Digital Mod".

The "Custom Digital Modulation" dialog enables direct selection of the data source, standard, symbol rate, coding, modulation type and filter.

The dialog is divided into several tabs. In each case, the current setting is displayed in the tab name.

The remote commands required to define these settings are described in [Chapter 14.16.3.2, "SOURce:BB:DM subsystem"](#), on page 663.

Settings:

• General settings	107
• Trigger, marker and clock settings	110
• Data source	110
• Modulation settings	112
• Filter settings	114
• Power ramp control settings	116
• Data list editor	118
• Control and marker lists editor	120

4.5.3.1 General settings

Access:

- ▶ Select "Baseband > Custom Digital Mod".

This tab provides access to the default and the save/recall settings, and to a quick selection of a digital modulation according to predefined communication standard.

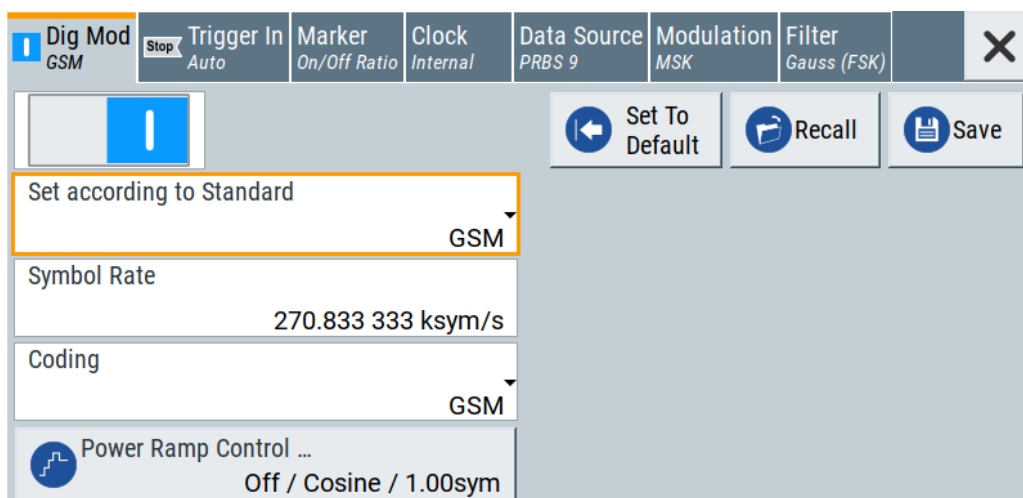
**Settings:**

State.....	108
Set To Default.....	108
Save/Recall.....	108
Set according to Standard.....	109
Symbol Rate.....	109
Coding.....	109
Power Ramp Control.....	110

State

Enables/disables digital modulation. Switching on digital modulation turns off all other digital standards.

The digital modulation is generated in real time (no precalculated signal), and therefore while the digital modulation is enabled, all parameter changes directly affect the output signal.

Remote command:

[:SOURce<hw>] :BB:DM:STATe on page 665

Set To Default

Calls default settings. The values are listed in [Table 4-4](#).

Remote command:

[:SOURce<hw>] :BB:DM:PRESet on page 666

Save/Recall

Accesses the "Save/Recall" dialog, that is the standard instrument function for saving and recalling the complete dialog-related settings in a file. The provided navigation possibilities in the dialog are self-explanatory.

The settings are saved in a file with predefined extension. You can define the filename and the directory, in that you want to save the file.

See also [Chapter 11, "File and data management"](#), on page 413.

Remote command:

[:SOURce<hw>] :BB:DM:SETTing:CATalog? on page 667

[:SOURce<hw>] :BB:DM:SETTing:DELeTe on page 668

[:SOURce<hw>] :BB:DM:SETTing:LOAD on page 668

[:SOURce<hw>] :BB:DM:SETTing:STORe on page 668

Set according to Standard

Selects a predefined communication standard.

Communication standard

Selects a predefined communication standard. If selected, the firmware automatically sets standard-compliant values for the following parameters: "Modulation Type", "Symbol Rate", "Filter" and "Coding". For "Set according to Standard" > "Telemetry - SOQPSK-TG", the "Data Source" is "Data List" only. See [Chapter 4.5.3.3, "Data source"](#), on page 110.

See [Table 4-5](#) for an overview of the available standards and standard-compliant settings of the modulation parameters.

"User" Set automatically, this value indicates a modification made on at least one of the parameters.

Use the "Save/Recall" function to save and recall customized settings.

"CW in Baseband"

Generates a continuous wave signal as a BPSK modulated signal with "Data Source = All 1".

This signal is useful for phase coherence applications, and a test signal for testing and debugging.

Note: The selection "CW in Baseband" changes also the data source to "All 1". Subsequent change to a communication standard maintains this data source.

Remote command:

[:SOURce<hw>] :BB:DM:STANdard on page 666

Symbol Rate

Selects the symbol rate. The value range of this parameter depends on the selected modulation type; the range is automatically redefined.

An error message appears if the selected symbol rate is outside of the redefined range. The symbol rate is set automatically to the maximum allowed value for the new modulation.

Remote command:

[:SOURce<hw>] :BB:DM:SRATe on page 666

Coding

Selects the coding (see [Chapter 4.4.1.5, "Supported coding schemes"](#), on page 95).

The dialog shows only the coding settings that are permissible for the selected modulation type and installed options (see [Table 4-7](#)). All other coding methods are grayed out.

A subsequent modification to a modulation type for which the selected coding is not available, automatically disables the coding ("Coding = Off").

Remote command:

[:SOURce<hw>] :BB:DM:CODing on page 671

Power Ramp Control

Accesses the power ramp control dialog, see [Chapter 4.5.3.6, "Power ramp control settings"](#), on page 116.

4.5.3.2 Trigger, marker and clock settings

These tabs provide standard settings.

For detailed description, see:

- [Chapter 4.4.2.1, "Trigger settings"](#), on page 101
- [Chapter 4.4.2.2, "Marker settings"](#), on page 104
- [Chapter 4.4.2.3, "Clock settings"](#), on page 105
- [Chapter 4.4.2.4, "Global connector settings"](#), on page 106

4.5.3.3 Data source

Access:

- ▶ Select "Baseband > Custom Digital Mod > Data Source".

This tab provides access to the settings necessary to select and configure the data source, like access to data and list editors or direct selection of PRBS data.

For an overview of the supported data sources, refer to [Chapter 4.4.1.1, "Data, clock and control signals and sources in the baseband"](#), on page 80.

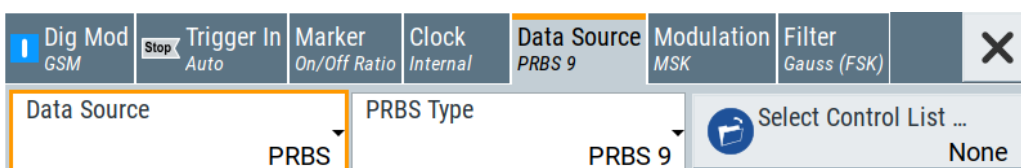

Settings:

Data Source	110
Select Data List	111
Select Control List	111
Connector Settings	112

Data Source

Selects the data source (see [Chapter 4.4.1.1, "Data, clock and control signals and sources in the baseband"](#), on page 80).

The following data sources are available:

- "All 0, All 1" A sequence containing 0 data or 1 data is internally generated.
- "PRBS, PRBS Type" Selects internally generated PRBS data in accordance with the IUT-T. Use the parameter "PRBS Type" to define the length.
Remote command:
`[:SOURce<hw>] :BB:DM:PRBS [:LENGth]` on page 667
- "Pattern" Use the "Pattern" box to define a bit pattern with a maximum length of 64 bits.
Remote command:
`[:SOURce<hw>] :BB:DM:PATtern` on page 667
- "Data List" Binary data from data lists are used, see [Select Data List](#).
Remote command:
`[:SOURce<hw>] :BB:DM:DLISt:CATalog?` on page 682
`[:SOURce<hw>] :BB:DM:DLISt:SElect` on page 682
- Remote command:
`[:SOURce<hw>] :BB:DM:SOURce` on page 666

Select Data List

Accesses the standard "Select List" dialog to select an existing data list or to create a one.

Data lists can be generated externally or internally in the data editor.

- Select the "Select Data List > navigate to the list file *.dm_iqd > Select" to select an existing data list.
- Use the standard "File Manager" function to transfer external data lists to the instrument.
- Use the "New" and "Edit" functions to create internally new data list or to edit an existing one, see [Chapter 4.5.3.7, "Data list editor"](#), on page 118.

See also [Chapter 4.5.4.2, "How to create and assign a data list"](#), on page 125

Remote command:

- `[:SOURce<hw>] :BB:DM:DLISt:CATalog?` on page 682
`[:SOURce<hw>] :BB:DM:DLISt:SElect` on page 682
`[:SOURce<hw>] :BB:DM:DLISt:COpy` on page 685
`[:SOURce<hw>] :BB:DM:DLISt:DELeTe` on page 683

Select Control List

Accesses the standard "Select List" dialog to select an existing control list or to create a one.

Control lists can be generated externally or internally in the "Control and Marker Lists" editor.

- Select the "Select Control List > navigate to the list file *.dm_iqc > Select" to select an existing control list.
- Use the standard "File Manager" function to transfer external lists to the instrument.
- Use the "New" and "Edit" functions to create internally new list or to edit an existing one, see [Chapter 4.5.3.8, "Control and marker lists editor"](#), on page 120.

Irrespectively on the way they are created, control lists are not automatically used (see "How to assign and activate control signals from a control list" on page 125).

Remote command:

[:SOURce<hw>] :BB:DM:CLISt:CATAlog? on page 682

[:SOURce<hw>] :BB:DM:CLISt:SELEct on page 682

[:SOURce<hw>] :BB:DM:CLISt:COPI on page 685

[:SOURce<hw>] :BB:DM:CLISt:DELEte on page 683

Connector Settings

Accesses the connectors settings.

See also [Chapter 12.2, "Configuring global connectors"](#), on page 449.

4.5.3.4 Modulation settings

Access:

- ▶ Select "Baseband > Custom Digital Mod > Modulation".

This tab provides access to the modulation settings, e.g modulation type, FSK deviation, or modulation depth. The dialog shows the theoretical constellation diagram of the selected modulation.



This section focuses on the available settings. For background information on how the settings affect the signal and the filter characteristics, refer to [Chapter 4.4.1.4, "Supported modulation signals"](#), on page 94.

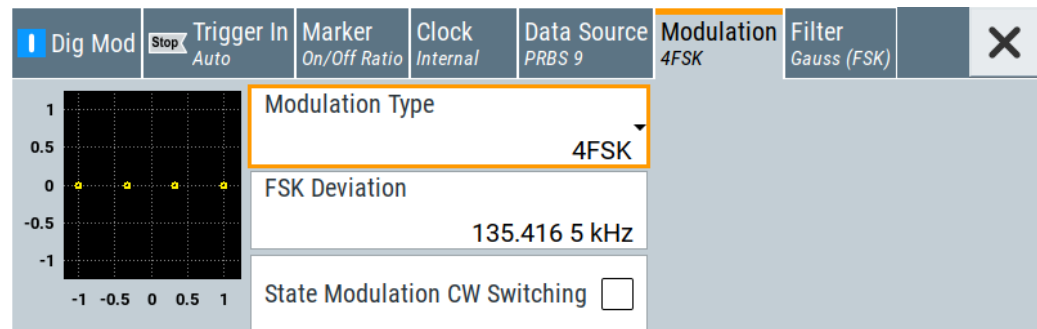

Settings:

Modulation Type.....	113
Load User Mapping.....	113
ASK Depth.....	113
FSK Deviation.....	113
Angle Alpha.....	113
FSK Type.....	114
Deviation xxxx.....	114
Gamma/Gamma 1.....	114
State Modulation CW Switching.....	114

Modulation Type

Selects a modulation type. The associated symbol mapping is displayed.

If the selected "Coding" is not allowed with the configured modulation type, the value of the parameter [Coding](#) is set to "Off".

Refer to [Table 4-6](#) for an overview of the allowed combinations.

Remote command:

`[:SOURce<hw>] :BB:DM:FORMat` on page 671

Load User Mapping

Accesses the "Select List File User Mapping" dialog to select the mapping table (see ["User mapping"](#) on page 95). The dialog provides all standard file management functions.

Remote command:

`[:SOURce<hw>] :BB:DM:MLIST:SElect` on page 682

`[:SOURce<hw>] :BB:DM:MLIST:CATalog?` on page 682

`[:SOURce<hw>] :BB:DM:MLIST:DElete` on page 683

ASK Depth

Sets the modulation depth m for ASK modulation.

$$m = (Amplitude_{max} - Amplitude_{min}) / (Amplitude_{max} + Amplitude_{min})$$

Remote command:

`[:SOURce<hw>] :BB:DM:ASK:DEPTH` on page 672

FSK Deviation

Sets the frequency deviation for FSK modulation. The range of values depends on the selected [Symbol Rate](#) (see data sheet).

Whenever "MSK" is selected, the deviation corresponds to 1/4 of the symbol rate and cannot be changed.

Remote command:

`[:SOURce<hw>] :BB:DM:FSK:DEVIation` on page 672

Angle Alpha

For AQPSK modulation, sets the angle alpha between the point (0,0) and the I axis.

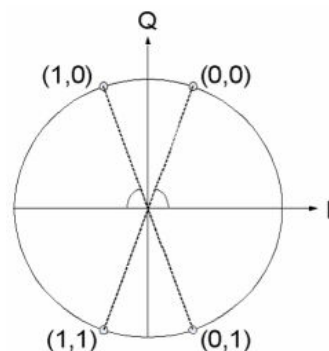

Remote command:

`[:SOURce<hw>] :BB:DM:AQPSk:ANGLE` on page 671

FSK Type

For "Variable FSK", selects the FSK modulation type.

Available are 4FSK, 8FSK and 16FSK.

Remote command:

`[:SOURCE<hw>] :BB:DM:FSK:VARIABLE:TYPE` on page 673

Deviation xxxx

For "Variable FSK", sets the deviation of the associated symbol. The number of symbols depends on the selected modulation type. The value of each symbol is indicated in binary format, i.e. x can be 1 or 0.

Remote command:

`[:SOURCE<hw>] :BB:DM:FSK:VARIABLE:SYMBOL<ch0>:DEVIATION` on page 672

Gamma/Gamma 1

Selects the gamma function γ for the 16APSK and 32APSK modulations.

The values in brackets indicate the used code rate according to the DVB-S2 specification.

Remote command:

`[:SOURCE<hw>] :BB:DM:APSK16:GAMMA` on page 673

`[:SOURCE<hw>] :BB:DM:APSK32:GAMMA` on page 673

State Modulation CW Switching

Enables/disables switching between the digitally modulated and an unmodulated (CW) signal.

Remote command:

`[:SOURCE<hw>] :BB:DM:SWITCHING:STATE` on page 674

4.5.3.5 Filter settings

Access:

- ▶ Select "Baseband > Custom Digital Mod > Filter".

This tab provides access to the filter settings, like filter type and if available further filter settings. A simplified diagram shows the filter characteristic of the selected filter.

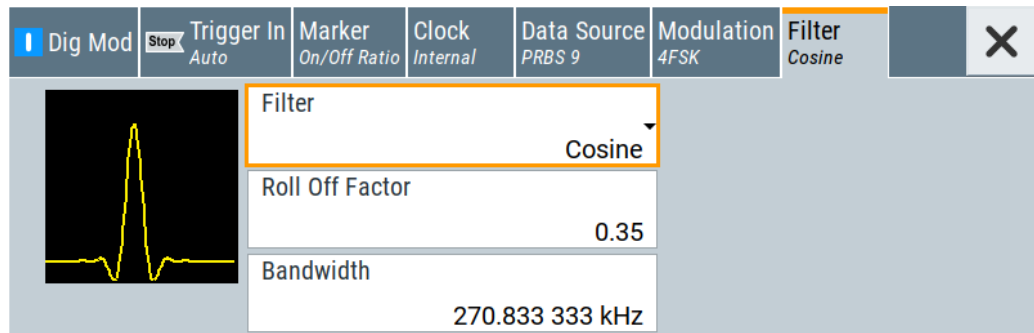

This section focuses on the available settings. For background information on how the settings affect the signal and the filter characteristics, refer to [Chapter 4.4.1.6, "Supported baseband filters"](#), on page 96.

**Settings:**

Filter.....	115
Filter Parameter.....	115
Cutoff Frequency Factor.....	115
Bandwidth.....	116
Load User Filter.....	116

Filter

Selects the baseband filter.

Refer to [Chapter 4.5.5.2, "Predefined baseband filters"](#), on page 132 for an overview of the available filter types, their filter shapes and filter parameters.

Remote command:

`[:SOURce<hw>] :BB:DM:FILTer:TYPE` on page 669

Filter Parameter

Sets the corresponding filter parameter.

The filter parameter offered ("Rolloff Factor" or "BxT") depends on the currently selected filter type.

Remote command:

`[:SOURce<hw>] :BB:DM:FILTer:PARAmeter:APCO25` on page 669

`[:SOURce<hw>] :BB:DM:FILTer:PARAmeter:COSine[:ROLLoff]` on page 669

`[:SOURce<hw>] :BB:DM:FILTer:PARAmeter:GAUSSs` on page 669

`[:SOURce<hw>] :BB:DM:FILTer:PARAmeter:PGAuss` on page 669

`[:SOURce<hw>] :BB:DM:FILTer:PARAmeter:RCOSine` on page 669

`[:SOURce<hw>] :BB:DM:FILTer:PARAmeter:SPHase` on page 669

Cutoff Frequency Factor

(Available for filter parameter "Lowpass" and "APCO25 (LSM)".)

Sets the value of the cutoff frequency factor. The cutoff frequency of the filter can be adjusted to reach spectrum mask requirements.

Remote command:

`[:SOURce<hw>] :BB:DM:FILTer:PARAmeter:LPASs` on page 669

`[:SOURce<hw>] :BB:DM:FILTer:PARAmeter:LPASSEVM` on page 669

`[:SOURce<hw>] :BB:DM:FILTer:PARAmeter:APCO25Lsm:GAUSSs` on page 669

`[:SOURce<hw>] :BB:DM:FILTer:PARAmeter:APCO25Lsm:LOWPass` on page 669

Bandwidth

Determines the bandwidth of the cosine filter, so that the function in $H(f) = 0$ is fulfilled for $f \geq (1 + \text{rolloff}) * \text{bandwidth} / 2$.

Remote command:

`[:SOURCE<hw>] :BB:DM:FILTer:PARAmeter:COStine:BANdwidth` on page 669

Load User Filter

Calls the dialog "Select User Filter" for selecting a user-defined filter file with extension `*.vaf` (see "User filter" on page 96). The dialog provides access to the standard file management functions, like save, load, delete.

Remote command:

`[:SOURCE<hw>] :BB:DM:FLISt:SElect` on page 682

`[:SOURCE<hw>] :BB:DM:FLISt:CATalog?` on page 682

`[:SOURCE<hw>] :BB:DM:FLISt:DElete` on page 683

4.5.3.6 Power ramp control settings

Access:

- ▶ Select "Baseband > Custom Digital Modulation > General > Power Ramp Control".

Cust Dig Mod : Power Ramp			
State	0	Source	Internal
Ramp Function	Cosine	Ramp Time	1.00 sym
Rise Delay	0.00 sym	Fall Delay	0.00 sym
Attenuation	15.0 dB		
Power Ramping / Level Attenuation			
In Baseband Only	<input checked="" type="checkbox"/>		

The dialog comprises the settings used to configure the power ramping, like the source of the control signals, the form of the ramp function and the applied attenuation.

See also "Power ramping and level attenuation" on page 83.



Power ramping is possible up to a symbol rate of 5 MHz. A higher symbol rate disables the power ramping automatically and an error message is output.

Settings:

State.....	117
Source.....	117
Ramp Function.....	117
Ramp Time.....	117
Rise Delay.....	117
Fall Delay.....	118
Attenuation.....	118
In Baseband Only.....	118

State

Enables/disables power ramping.

Remote command:

[:SOURce<hw>] :BB:DM:PRAMP [:STATe] on page 676

Source

Defines the source for the power ramp control signals.

"Internal" The control signals as defined in the internal control list are used for control purposes.
See also [Chapter 4.5.4.1, "How to create and assign a control list"](#), on page 124.

Remote command:

[:SOURce<hw>] :BB:DM:PRAMP :SOURce on page 674

Ramp Function

Selects the ramp function that describes the shape of the rising and falling edges during power ramp control, see [Figure 4-3](#).

"Linear" The transmitted power rises and falls linear fashion.

"Cosine" The transmitted power rises and falls with a cosine-shaped edge, resulting in a more favorable spectrum than the "Linear" setting.

Remote command:

[:SOURce<hw>] :BB:DM:PRAMP :SHAPE on page 674

Ramp Time

Enters the power ramping rise time and the fall time for a burst. The setting is expressed in symbols. See also [Figure 4-3](#).

Remote command:

[:SOURce<hw>] :BB:DM:PRAMP :TIME on page 674

Rise Delay

Sets the offset in the rising edge of the envelope at the start of a burst, see [Figure 4-3](#).

A positive value delays (the envelope length decreases) and a negative value causes an advance (the envelope length increases). The setting is expressed in symbols.

Remote command:

[:SOURce<hw>] :BB:DM:PRAMP :RDELaY on page 675

Fall Delay

Sets the offset in the falling edge of the envelope at the end of a burst, see [Figure 4-3](#).

A positive value delays (the envelope length increases) and a negative value causes an advance (the envelope length decreases). The setting is expressed in symbols.

Remote command:

[:SOURce<hw>] :BB:DM:PRAMP:FDELaY on page 675

Attenuation

Determines the level by that the average signal level is attenuated during the signal attenuation period, during the time, that the "Lev_Attn" signal is high. See also [Figure 4-2](#).

For information about the required control signal, refer to "[Power ramping and level attenuation](#)" on page 83.

Remote command:

[:SOURce<hw>] :BB:DM:PRAMP:ATTenuation on page 675

In Baseband Only

Restricts power ramping to the baseband signal.

"Off"	Level attenuation is affected via the attenuator stages in the RF section; only the remaining part is attenuated in the baseband. The signal is issued at the RF output with the defined level values.
"On"	Level attenuation is affected in the baseband only.

Note:

This setting is mandatory in the following cases:

- When only the baseband signal is issued at the I/Q outputs
It is thus ensured that, with power ramping active, this signal is output with the defined level values.
- For two-path instruments, when one baseband signal is applied to two RF paths.

Remote command:

[:SOURce<hw>] :BB:DM:PRAMP:BBONly [:STATe] on page 675

4.5.3.7 Data list editor

The R&S SMCV100B provides the following ways to create a data list file:

- To use the dedicated "Data List Editor" and create a file with extension *.dm_iqd, see "[To create data lists manually](#)" on page 126
- To use the tag-oriented format and create a data list file, see "[To create a data list file using tag file format](#)" on page 166.
- To use SCPI commands and create a file in binary format, see "[To create a data list in binary format](#)" on page 167.

Access:

1. Select "Baseband > Custom Digital Mod > Data Source > Data List".
2. Select "Select Data List".

3. Navigate to the required directory.
4. Select "New".
5. Enter a filename.
For example, in the directory `/var/user/`, enter "Filename" = `dl_3gpp`

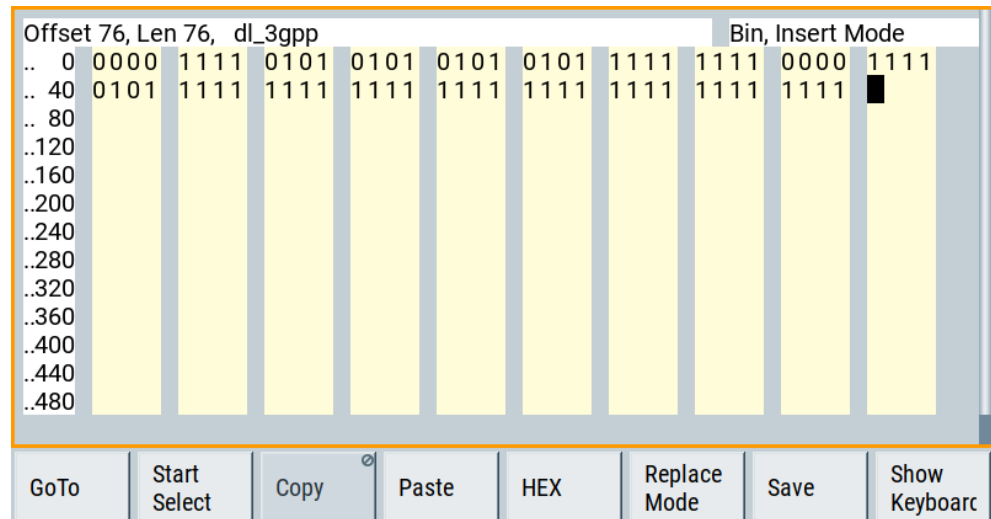

The "Data List Editor" is a list of binary values with a maximum length of 2^{31} bits. This value corresponds to a file size of approx. 268 Mbyte.

To increase readability, the bits are displayed in groups of four (binary format) or two (hexadecimal format). Also, above the list are displayed: The current cursor position and the length of the list and the list filename are displayed above the list. The offset starts with the value 0 which corresponds to the bit position on the left side of the first row, i.e. the beginning of the list. On the left edge of the editor, the last three offset positions are specified at the beginning of the row.

An existing list can be edited in the insert or replace mode. The upper right corner shows the current mode.

SCPI command:

`[:SOURce<hw>] :BB:DM:DLIST:SElect` on page 682

`[:SOURce<hw>] :BB:DM:DLIST:DATA` on page 686

`[:SOURce<hw>] :BB:DM:DLIST:DATA:APPend` on page 687

The buttons below the binary list simplify the editing.

Settings:

GoTo	119
Start Select/Undo Select	120
Copy, Cut, Paste	120
HEX/BIN	120
Replace/Insert Mode	120
Save	120

GoTo

Opens the entry window for the bit position. The cursor marks the bit at the selected position.

Start Select/Undo Select

Defines the current cursor position as the start position for the range to be selected. To define the stop position, select "GoTo > Go To Offset" and define the offset.

Selecting "Undo Select" deactivates the selected range.

Copy, Cut, Paste

Standard copy, cut, and paste functions.

HEX/BIN

Switches between hexadecimal and binary display.

Every 4 bits group is displayed as a hexadecimal value. To increase readability, the hexadecimal values in turn are displayed in pairs of two.

The hex functions are automatically assigned to the numeric keys at the front panel.

Replace/Insert Mode

Switches between replace and insert mode to enter new or replace old values.

Save

Saves the changes into the selected data list file.

4.5.3.8 Control and marker lists editor

The R&S SMCV100B provides the following ways to create a file containing control signals:

- To use the tag-oriented format and create a control list file, see ["To create a control list using tag file format"](#) on page 164.
- To use SCPI commands and create a file in binary format, see ["To create a control list in binary format"](#) on page 165.
- To use the dedicated "Control Data Editor" and create a file in ASCII format and with extension `*.dm_iqc`.
The "Control Data Editor" is described in this section. Refer to ["To create a control list in ASCII format manually"](#) on page 124 for step-by-step instructions.

To access the "Control Data Editor":

1. Select "Baseband > Custom Digital Mod > Data Source".
2. Select "Select Control List".
3. Navigate to the required directory, for example `/var/user/`.
Select "New".
4. In the "Filename" field, enter the name of the new control list, for example `dl_3gpp`.

5. Select "Edit".



The dedicated internal "Control Data Editor" is an intuitive graphical interface provided for defining and managing of:

- Marker signals
- Control signals, like the CW, "Hop", "Burst Gate", and "Lev_Att" control signals (see also "Control signals" on page 82)

A separate file with the file extension `*.dm_iqc` is created for each defined control signal and held on the instrument's hard disk. Control lists created with the editor are files in an ASCII file format.

In the "Control Data Editor" dialog, the available marker and control signals are displayed color-coded. The "Select Ramp to Edit" is a graphical display of the signal characteristics. To define the ramp for the individual markers or control signals, tap on the desired position or use the provided support functions "<Signal> Table" and "Cursor Position". To simplify the settings, use the predefined preset ramp characteristics in the "<Signal> Preset Type" section. The scaling of the x-axis is always adapted to the overall length of the control list to provide constant overview of all defined ramps. For detailed representation, zoom the displayed area around the current cursor position.

In the "Configure Control Signal" section, a status checkbox indicates whether the individual marker or control signal is assigned or enabled (see [Chapter 4.5.4.1, "How to create and assign a control list"](#), on page 124).

SCPI command:

`[:SOURce<hw>] :BB:DM:CLISt:CATalog?` on page 682

`[:SOURce<hw>] :BB:DM:CLISt:SElect` on page 682

Settings:

Configure Control Signal	122
Select Ramp to Edit	122
Total List Length	122
Preset Type	122
Cursor Position	123

Positions Control Signal.....	123
Zoom/Visible.....	123
Save/Save As.....	123

Configure Control Signal

Displays the color the marker/control signal has been assigned.

The status checkbox indicates whether the individual marker or control signal is assigned or enabled (see [Chapter 4.5.4.1, "How to create and assign a control list"](#), on page 124).

Remote command:

n.a.

Select Ramp to Edit

Graphical representation for editing of the marker/control signals.

Refer to [Chapter 4.5.4.1, "How to create and assign a control list"](#), on page 124 for an overview of the editing capabilities of the display.

Remote command:

```
{[TRACE] LIST [#]: Pos0:State0; Pos1:State1; ...PosN-1:StateN-1}
```

on page 181

[\[:SOURCE<hw>\]:BB:DM:CLIST:DATA](#) on page 685

Total List Length

Enters the length of the definition range of the control list in bits. The starting value is always bit 0. The entire definition range is displayed, i.e. the bit scale is adapted to the entry. If the definition range is decreased, the ramps outside the range are lost.

When used, the control list is always repeated over the length of the definition range if the length of the data list exceeds the length of the control list.

Tip: With long control lists, it is useful to zoom the displayed area around the current cursor position ("Zoom in").

Remote command:

```
{CONTROL LENGTH: ControlLength}
```

 on page 177

Preset Type

Triggered with "Preset", presets for the ramp characteristic of the selected control signal as defined with the "Preset Type".

"All Up, All Down"

Continuously high/low marker/control signal.

"Ramp Up, Ramp Down"

A ramp from low to high or from high to low is configured in the center of the displayed signal area; ramp position can be later shifted as required.

"Ramp Up/Down, Ramp Down/Up"

Created is a ramp sequence of low to high and high to low transitions, respectively high to low, and low to high transitions. The ramps are symmetrically distributed around the center of the displayed signal area but be later shifted as required.

Remote command:
n.a.

Cursor Position

Displays/enters the cursor position in the graphical display

If the entered value exceeds the selected length of the definition range, the length is adjusted automatically.

Remote command:
n.a.

Positions Control Signal

Select "Edit ..." to access a dialog with representation of the ramps of the selected signal in table form.

	Ramp Position	Ramp State
0	0	Low
1	82	High
2	284	Low
3	468	High
4	767	Low
5		

Accept

The bit position is specified in the "Ramp Position" column, the high or low signal status in the "Ramp State" column. Use the last blank row to enter new ramps.

To apply the changes, press "Accept".

Remote command:
n.a.

Zoom/Visible

Zooms the displayed area of the control list. The designation of the button changes from "Zoom in" to "Zoom out".

With long control lists, it is helpful to display only a part of the control list. In such cases, set the "Visible/Bits Visible" to determine the number of symbols/bits to be displayed and select "Zoom" to focus the displayed area around the current "Cursor Position".

Ramps outside the displayed area are not lost by zooming.

Remote command:
n.a.

Save/Save As

Saves the changes in the selected control list file or in a new file.

Remote command:
n.a.

4.5.4 How to create data and control lists

This section provides step-by-step instructions on configuring and using the provided settings. For details on individual functions and settings, see [Chapter 4.5.3, "Custom digital modulation settings"](#), on page 107.

4.5.4.1 How to create and assign a control list

The R&S SMCV100B provides the following ways to create a file containing control signals:

- To use the dedicated [Control and marker lists editor](#) and create a file in ASCII format and with extension `*.dm_iqc`, see ["To create a control list in ASCII format manually"](#) on page 124
- To use the tag-oriented format and create a control list file, see ["To create a control list using tag file format"](#) on page 164.
- To use SCPI commands and create a file in binary format, see ["To create a control list in binary format"](#) on page 165.

To create a control list in ASCII format manually

Use the intuitive build in [Control and marker lists editor](#) dialog:

1. To open the "Control Data Editor":
 - a) Select "Baseband > Custom Digital Mod > Data Source > Select Control List".
 - b) Select a file.
You can select an existing file or a "New".

If the selected file is an existing one, the dialog shows the used settings. If you create a file, the control list is empty.
2. Adjust the control signals as required.
 - a) In the graphic editor "Select Ramp to Edit", select the color-coded trace of the required signal.
 - b) Tap at a position which requires a ramp. The number of ramps per marker is unlimited.
 - c) To remove a ramp, place the cursor at the desired ramp position.
On the connected keyboard, press "Del".
 - d) For faster marker and control signal definition, use the predefined ramp functions ("Preset Type"). Apply them with "Preset".
 - e) If necessary, readjust the ramps with the help of the "Edit" function.
 - f) Define the "Total List Length".
 - g) To display only a part of the control list, set the "Visible/Bits Visible" to determine the number of displayed symbols/bits.
Select "Zoom" to focus the displayed area around the current "Cursor Position".

Ramps outside the displayed area are not lost.

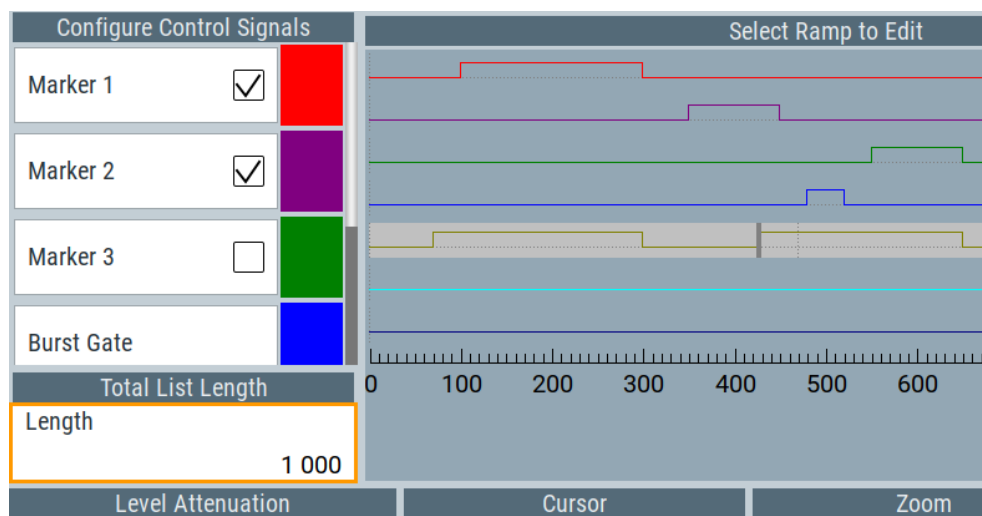

Figure 4-10: Example of control list settings

3. Select "Save" or "Save As" to save the used settings as a control list file.

The created file is an ASCII file with the extension *.dm_iqc.

Enable the instrument to use the control list, e.g. for the marker and/or other control signals.

Enabled control signals are indicated as active in the "Configure Control Signal" section.

How to assign and activate control signals from a control list

Irrespectively on the way they are created, generated control lists are not automatically used.

To use a marker/control signal from a control list and to output this signal at the supported connector, perform the following:

- ▶ Enable the R&S SMCV100B to use the control list for marker output 2.
Output this signal at the User2 connector:
 - a) Select "Baseband > Custom Digital Modulation > Marker > Marker 2 Mode > CList".
 - b) Select "Baseband > Custom Digital Modulation > Marker > Global Connectors > Routing".
Select "User 2 > Direction = Output", "User 2 > Signal = Baseband Marker 2".

4.5.4.2 How to create and assign a data list

The R&S SMCV100B provides the following ways to create a data list file:

- To use the dedicated [Data list editor](#) and create a file with extension *.dm_iqd, see ["To create data lists manually"](#) on page 126

- To use the tag-oriented format and create a data list file, see "[To create a data list file using tag file format](#)" on page 166.
- To use SCPI commands and create a file in binary format, see "[To create a data list in binary format](#)" on page 167.

To create data lists manually

Use the intuitive build in [Data list editor](#) dialog:

1. To access the "Data List Editor":
 - a) Select "Baseband > Custom Digital Mod > Data Source > Data List"
 - b) Select "Select Data List"
 - c) Navigate to the required directory, for example `/var/user/`.
 - d) Select "New". Enter "File Name" = `dl`.

The "Data List Editor" opens; the data list is empty.

2. Enter a sequence of 0 and 1, for example `01110101`.

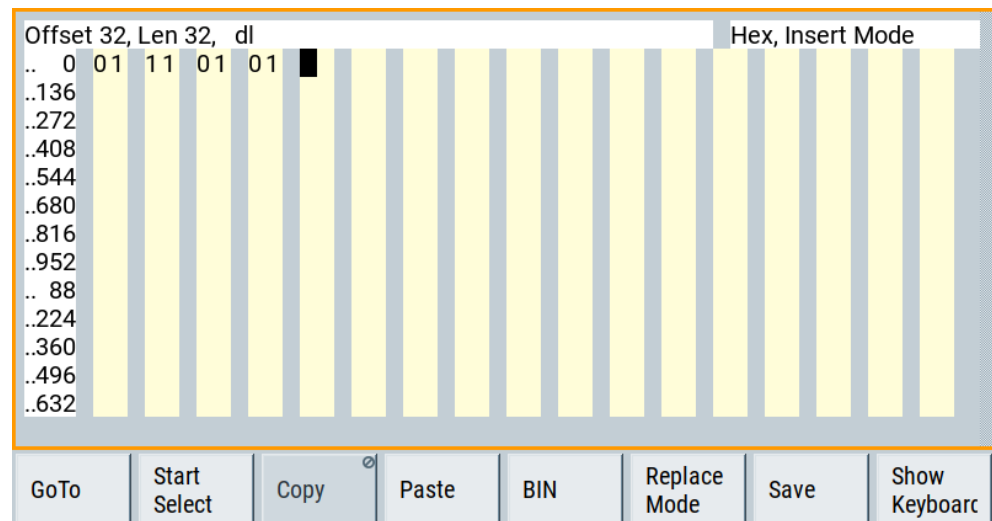

Figure 4-11: Example of data list

3. Select "Save" to save the used settings as a data list file.
The instrument saves the `dl.dm_iqd` file in the `/var/user/` directory.

How to assign and activate data lists

Irrespectively on the way they are created, generated data lists are not automatically used.

- ▶ To enable the R&S SMCV100B to use the data list as data source for the custom digital modulation:
 - a) Select "Baseband > Custom Digital Modulation > Data Source > Data List"
 - b) Select "Select Data List"
 - c) Navigate through the file system.

d) To select the file, confirm with "Select".

4.5.5 References

Table 4-4: Custom digital modulation default values

Parameter	Value
"State"	Not affected
"Data Source"	"PRBS 9"
"Standard"	"GSM"
"Symbol Rate"	"270.833 ksymb/s"
"Coding"	"GSM"
"Modulation Type"	"MSK"
"Filter"	"Gauss (FSK)"
Filter parameter "B*T"	"0.3"
Trigger	"Mode > Auto", "Source > Internal"
Clock	"Source > Internal"
"Power Ramp Control" settings:	
"Attenuation"	"15.0 dB"
"Ramp Time"	"1.00 sym"
"Ramp Function"	"Cosine"
"Rise Delay"	"0.00 sym"
"Fall Delay"	"0.00 sym"
"Source"	"Internal"
"State"	"Off"

Table 4-5: Communication standards with their predefined settings

Standard	Modulation	Symbol rate	Filter	Coding	Parameter for SCPI command
APCO Phase1 C4FM	4FSK, Deviation: 1.8 kHz	4.8 ksymb/s	APCO25, roll off = 0.2	APCO25(FSK)	APCOPH1C4fm
APCO Phase1 CQPSK	pi/4-DQPSK	4.8 ksymb/s	Cosine, roll off = 0.2, BW = 4.8 kHz	APCO25(PSK)	APCOPH1CQpsk
APCO Phase2 H-CPM	4FSK, Deviation: 3 kHz	6 ksymb/s	APCO25 (H-CPM)	APCO25(FSK)	APCOPH2HCpm
APCO Phase2 H-DQPSK	pi/4-DQPSK	6 ksymb/s	Cosine, roll off = 1, BW = 7.2 kHz	APCO25(PSK)	APCOPH2HDQpsk
APCO Phase2 H-D8PSK Wide	pi/8-D8PSK	4 ksymb/s	Cosine, roll off = 1, BW = 7.2 kHz	APCO25(8PSK)	APCOPH2HD8PSKW

Standard	Modulation	Symbol rate	Filter	Coding	Parameter for SCPI command
APCO Phase2 H-D8PSK Narrow	pi/8-D8PSK	4 ksym/s	Cosine, roll off = 1, BW = 5 kHz	APCO25(8PSK)	APCOPH2HD8PSKN
APCO Phase1 LSM	pi/4-DQPSK	4.8 ksym/s	APCO25 (LSM), Gauss Cut Off: 2.04 kHz, Low-pass Cut Off: 6.2 kHz	APCO25(PSK)	APCOPH1Lsm
APCO Phase1 WCQPSK	pi/4-DQPSK	4.8 ksym/s	Cosine, roll off = 1, BW = 7.2 kHz	APCO25(PSK)	APCOPH1Wcqpsk
Bluetooth	2FSK, Deviation: 160 kHz	1.0 Msym/s	Gauss, B*T = 0.5	Off	BLUetooth
CW in Baseband	BPSK	1 Msym/s	Gauss, B*T = 0.5	Off	CWBPsK
CDMA2000 Forward	QPSK	1.2288 Msym/s	cdmaOne + Equalizer	cdma2000	CFORward
CDMA2000 Reverse	Offset QPSK	1.2288 Msym/s	cdmaOne	cdma2000	CREVerse
DECT	2FSK, Deviation: 288 kHz	1.152 Msym/s	Gauss, B*T = 0.5	Off	DECT
ETC (ARIB STD T55)	ASK, Depth: 100 %	1.024 Msym/s	Split Phase, B*T = 2.0	Off	ETC
GSM	MSK	270.833333 ksym/s	Gauss, B*T = 0.3	GSM	GSM
GSM EDGE	8PSK EDGE (3pi/8 8PSK)	270.833333 ksym/s	Gauss linear	Off	GSMEdge
NADC	pi/4 DQPSK	24.3 ksym/s	Root cosine, alpha = 0.35	NADC	NADC
PDC	pi/4 DQPSK	21.0 ksym/s	Root cosine, alpha = 0.50	PDC	PDC
PHS	pi/4 DQPSK	192.0 ksym/s	Root cosine, alpha = 0.50	PHS	PHS
TD-SCDMA	QPSK 45° Offset	1.28 Msym/s	Root cosine, alpha = 0.22	Off	TCSCdma
Telemetry SOQPSK-TG	2FSK, Deviation: 1.25 MHz (0.25 * symbol rate)	5.0 Msym/s	SOQPSK	Off	SOQPSKTG
TETRA	pi/4 DQPSK	18.0 ksym/s	Root cosine, alpha = 0.35	TETRA	TETRa
WCDMA 3GPP	QPSK 45° Offset	3.84 Msym/s	Root cosine, alpha = 0.22	WCDMA 3GPP	W3GPP
Worldspace	QPSK	1.84 Msym/s	Root cosine, alpha = 0.40	Off	WORLdspace
TFTS	pi/4 DQPSK	22.1 ksym/s	Root cosine, alpha = 0.40	TFTS/ TETRA	TFTS

Table 4-6: Permissible coding combinations for modulation symbols and modulation type

	Off	Differ- ential	Phase Diff.	Diff.+ Gray	Gray	GSM	NADC, PDC, PHS, TETRA, APCO25 (PSK), PWT	TFTS/ TETR A	INMARSAT, ICO, WCDMA, cdma2000	VDL	APCO2 5 (FSK)	APCO25 (8PSK)
ASK	X	X		X	X							
BPSK	X	X		X	X							
pi/2 DBPSK	X				X							
QPSK	X	X		X	X				X			
QPSK EDGE	X											
QPSK45° Off- set	X	X		X	X							
Pi/4 QPSK	X	X			X							
Pi/4 DQPSK	X				X	X	X					
8PSK	X	X		X	X					X		
AQPSK	X	X		X	X							
OQPSK	X	X		X	X							
8PSK_EDGE	X											
Pi/8 D8PSK	X				X							X
MSK	X	X		X	X	X						
2FSK	X	X		X	X	X						
4FSK	X	X		X	X					X		
8FSK	X	X		X	X							
16FSK	X	X		X	X							
32FSK	X											
64FSK	X											
16QAM	X	X	X	X	X							
16QAM EDGE	X											
32QAM	X	X	X	X	X							
32QAM EDGE	X											
64QAM	X	X	X	X	X							
128QAM	X	X	X	X	X							
256QAM	X	X	X	X	X							
1024QAM	X	X	X	X	X							

	Off	Differ- ential	Phase Diff.	Diff.+ Gray	Gray	GSM	NADC, PDC, PHS, TETRA, APCO25 (PSK), PWT	TFTS/ TETR A	INMARSAT, ICO, WCDMA, cdma2000	VDL	APCO2 5 (FSK)	APCO25 (8PSK)
16APSK	X											
32APSK	X											

4.5.5.1 Common coding algorithms



In the notation used below, a_n denotes the n^{th} input symbol and b_n denotes the correspondingly coded output symbol. Individual bits in the symbols from the LSB (least significant bit) to the MSB (most significant bit) are denoted by a_{0n} , a_{1n} , etc. The same applies to the output symbols.

Common coding types are listed in [Table 4-7](#).

Table 4-7: Common coding algorithms

Coding	Coding algorithm	Applicable for K bit/symbol
"None"	$b_n = a_n$	$k = 1...8$
"Differential"	$b_n = (a_n + b_{-1}) \text{ modulo } 2^k$	$k = 1...7$
"Differential + Gray"	Gray coding with additional differential coding	$k = 1...7$
"Phase Differential"	$b_{1n} = [\text{NOT } (a_{1n} \text{ EXOR } a_{0n}) \text{ AND } (a_{1n} \text{ EXOR } b_{1(n-1)})] \text{ OR } [(a_{1n} \text{ EXOR } a_{0n}) \text{ AND } (a_{1n} \text{ EXOR } b_{0(n-1)})]$ $b_{0n} = [\text{NOT } (a_{1n} \text{ EXOR } a_{0n}) \text{ AND } (a_{0n} \text{ EXOR } b_{0(n-1)})] \text{ OR } [(a_{1n} \text{ EXOR } a_{0(n-1)}) \text{ AND } (a_{0n} \text{ EXOR } b_{1(n-1)})]$	-

"Coding > Phase Differential/INMARSAT" correspond to system standards Inmarsat-M and DVB according to ETS 300 429. You can use INMARSAT coding for modulation types with 2 bits/symbol, such as QPSK.

Examples

The following examples illustrate how some of the different common coding schemes combined with a modulation method influence the signal.

Example: Differential coding for QPSK modulation with K = 2 bit/symbol

Decimal display; the value range for modulation symbols is $a_n = \{0, 1, 2, 3\}$.

According to [Table 4-7](#) and for $k = 2$, the recursive coding is defined as $b_n = (a_n + b_{n-1}) \text{ modulo } 4$.

Depending on the state of a preceding modulation symbol b_{n-1} , the coded modulation symbol b_n is obtained, for example, from modulation symbol, $a_n = 2$ as follows:

b_{n-1}	0	1	2	3
b_n	2	3	0	1

With differential coding, the assignment of modulation symbols a_n (binary indication: MSB, LSB) to the phase differences shown in the following table is generated:

Table 4-8: Phase difference for QPSK

Modulation symbol a_n	00	01	10	11
Phase difference	0°	90°	180°	270°

Example: Differential coding for modulation type pi/4DQPSK

With differential coding switched on at the same time, the obtained constellation diagram for pi/4DQPSK is similar to that of 8PSK. Phase shifts are however assigned to the individual modulation symbols. The [Table 4-9](#) shows the assignment of modulation symbols a_n (binary indication: MSB, LSB) to phase shifts of the I/Q vector in relation to the selected coding.

Table 4-9: Phase shifts for pi/4DQPSK

Modulation symbol a_n	00	01	10	11
"Coding = Off"	+ 45°	+ 135°	- 135°	- 45°
"Coding = NADC, PDC, PHS, TETRA, or APCO25 (PSK)"	+ 45°	+ 135°	- 45°	- 135°
"Coding = TFTS"	- 135°	+ 135°	- 45°	+ 45°

Example: Gray and differential coding for 8PSK modulation

When this coding scheme is used, the gray coding according to the gray code is performed before the differential coding. The later uses the recursive coding algorithm quoted above (see [Table 4-7](#)). The assignment of modulation symbols a_n (binary indication: MSB, LSB) to the phase differences shown in the following table is generated:

Table 4-10: Differential coding according to VDL¹⁾

Modulation symbol d_n	000	001	010	011	100	101	110	111
Phase difference	0°	45°	135°	90°	270°	315°	225°	180°

¹⁾ "Differential coding according to VDL" can be used for modulation types with 3 bits/symbol, e.g. 8PSK.

4.5.5.2 Predefined baseband filters

The Table 4-11 shows the filters that are available, together with their associated parameters. The filter characteristic is displayed in graphical form.

Table 4-11: Overview of the baseband filters

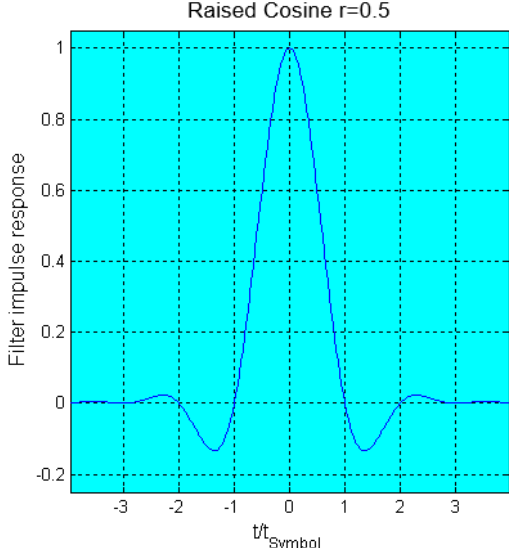
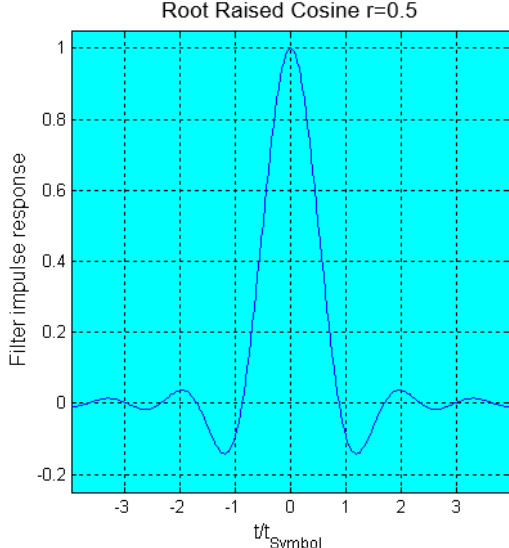
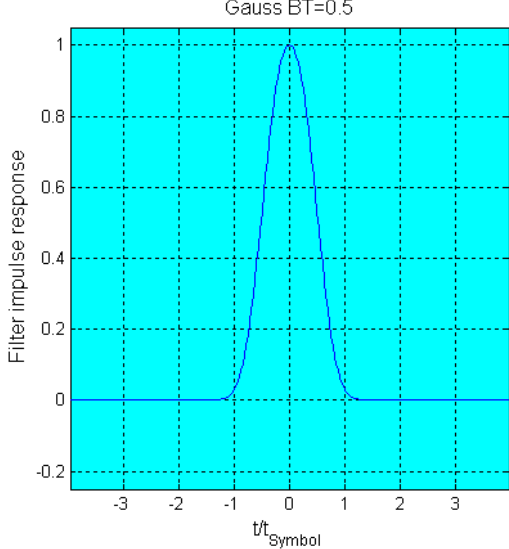
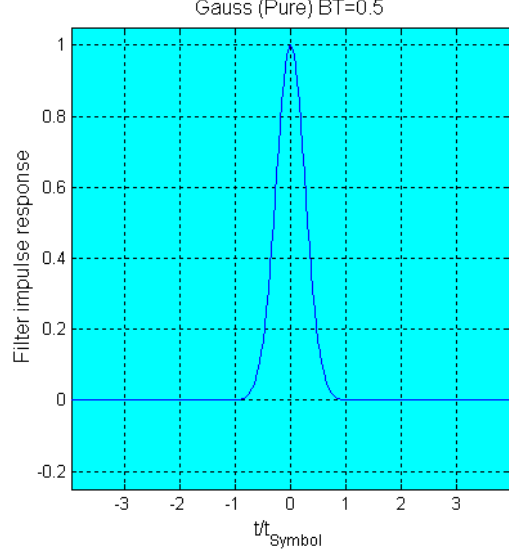
<p>"Raised Cosine (RC)" "Roll Off Factor"</p>	<p>"Root Raised Cosine (RRC)" "Roll Off Factor"</p>
 <p>Raised Cosine r=0.5</p>	 <p>Root Raised Cosine r=0.5</p>
<p>"Gauss (FSK)" "B*T"</p>	<p>"Gauss (Pure)" "B*T"</p>
 <p>Gauss BT=0.5</p>	 <p>Gauss (Pure) BT=0.5</p>
<p>"Gauss Linearized"</p>	<p>"Edge Narrow Pulse Shape"</p>

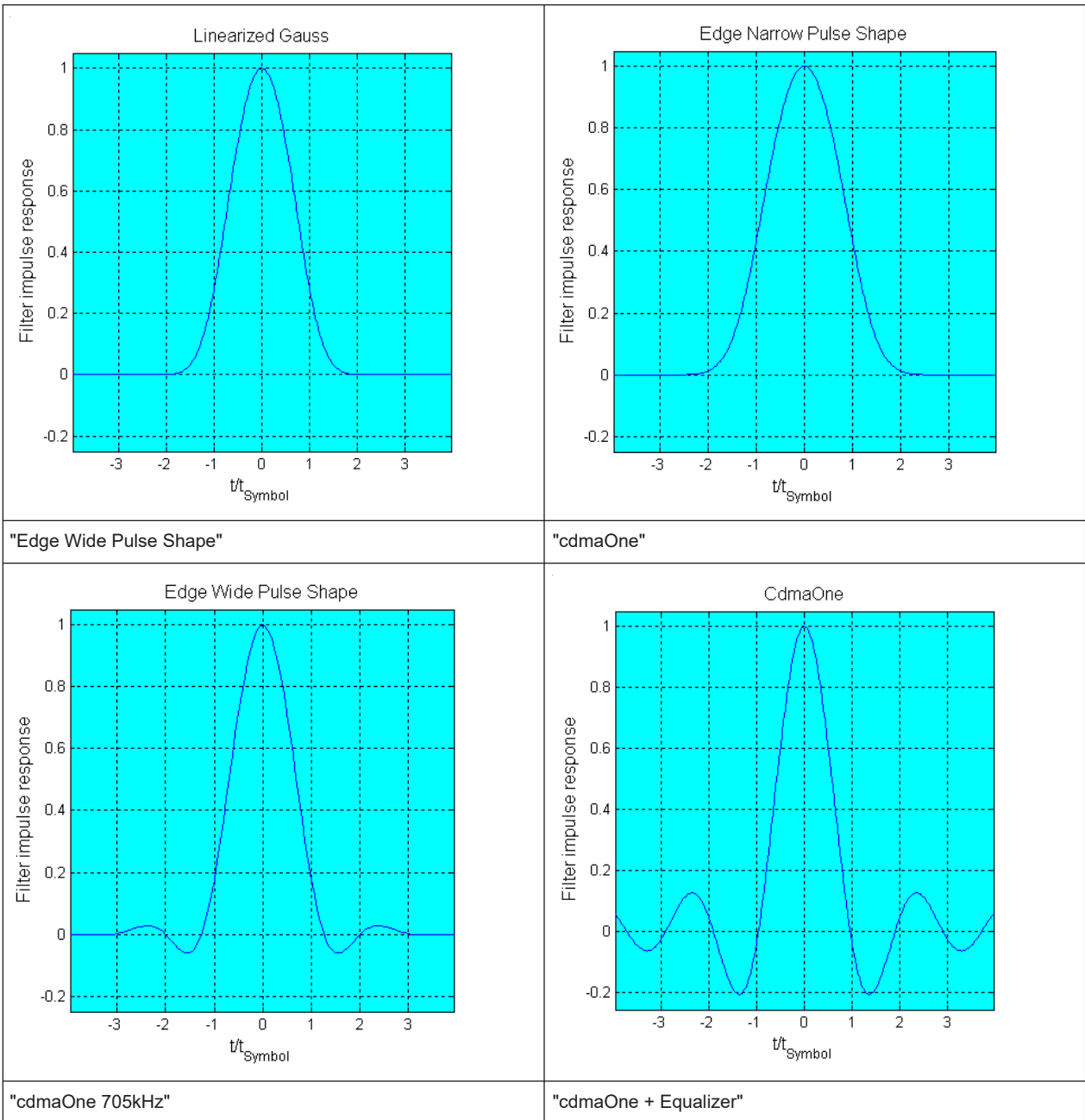

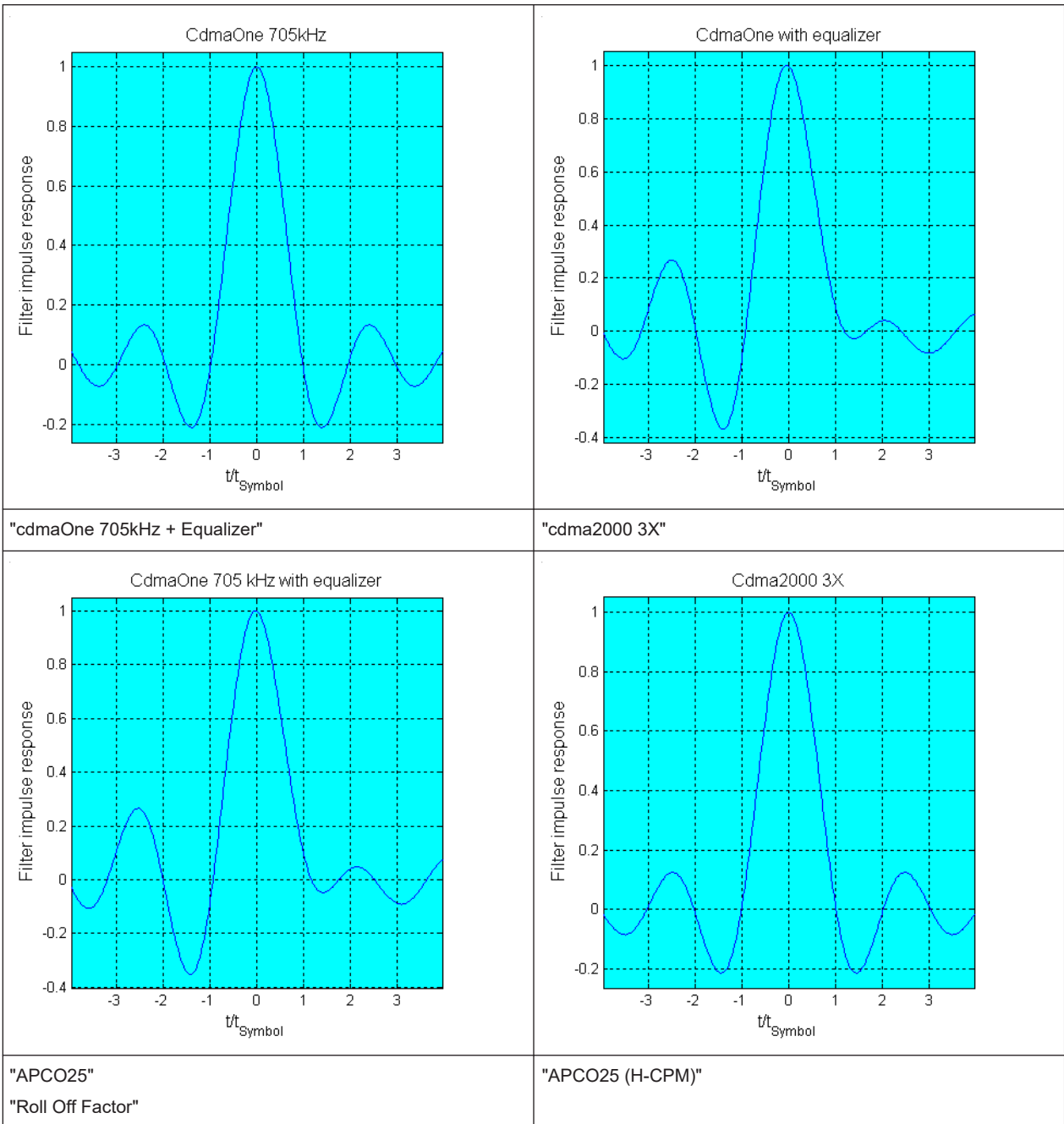

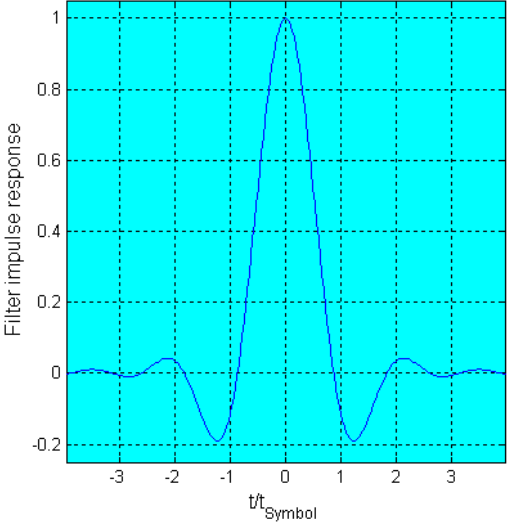
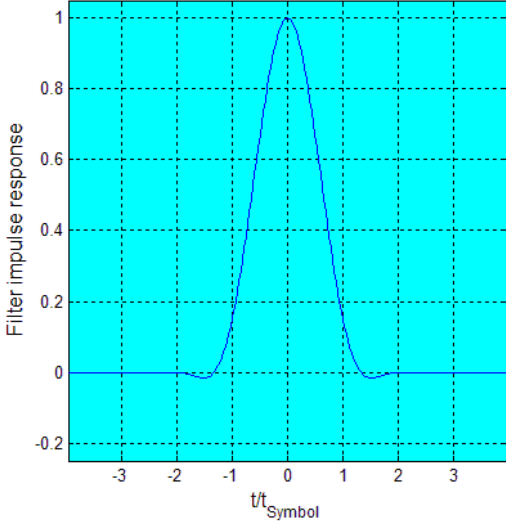
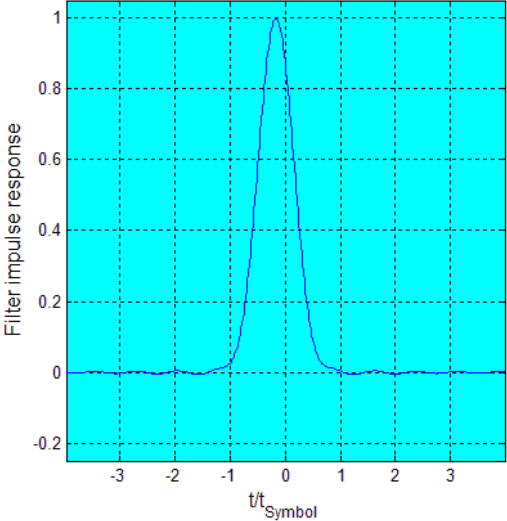
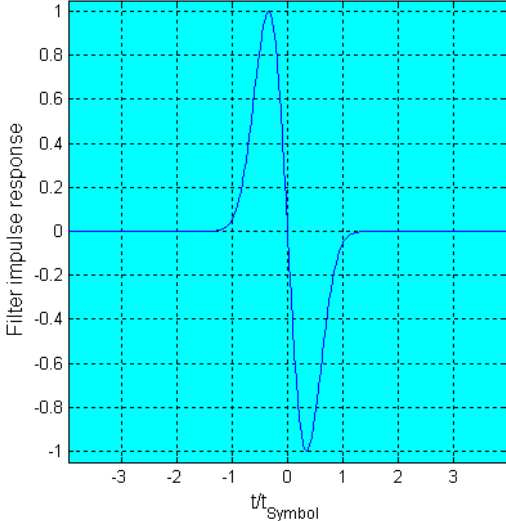
<p style="text-align: center;">APCO25 r=0.5</p> 	<p style="text-align: center;">APCO H-CPM</p> 
<p>"APCO25 (LSM)" "Gauss Cut Off Frequency" "Lowpass Cut Off Frequency"</p>	<p>"Split Phase" "B*T"</p>
<p style="text-align: center;">APCO LSM</p> 	<p style="text-align: center;">Splitphase BT=0.5</p> 
<p>"Rectangular"</p>	<p>"Dirac"</p>

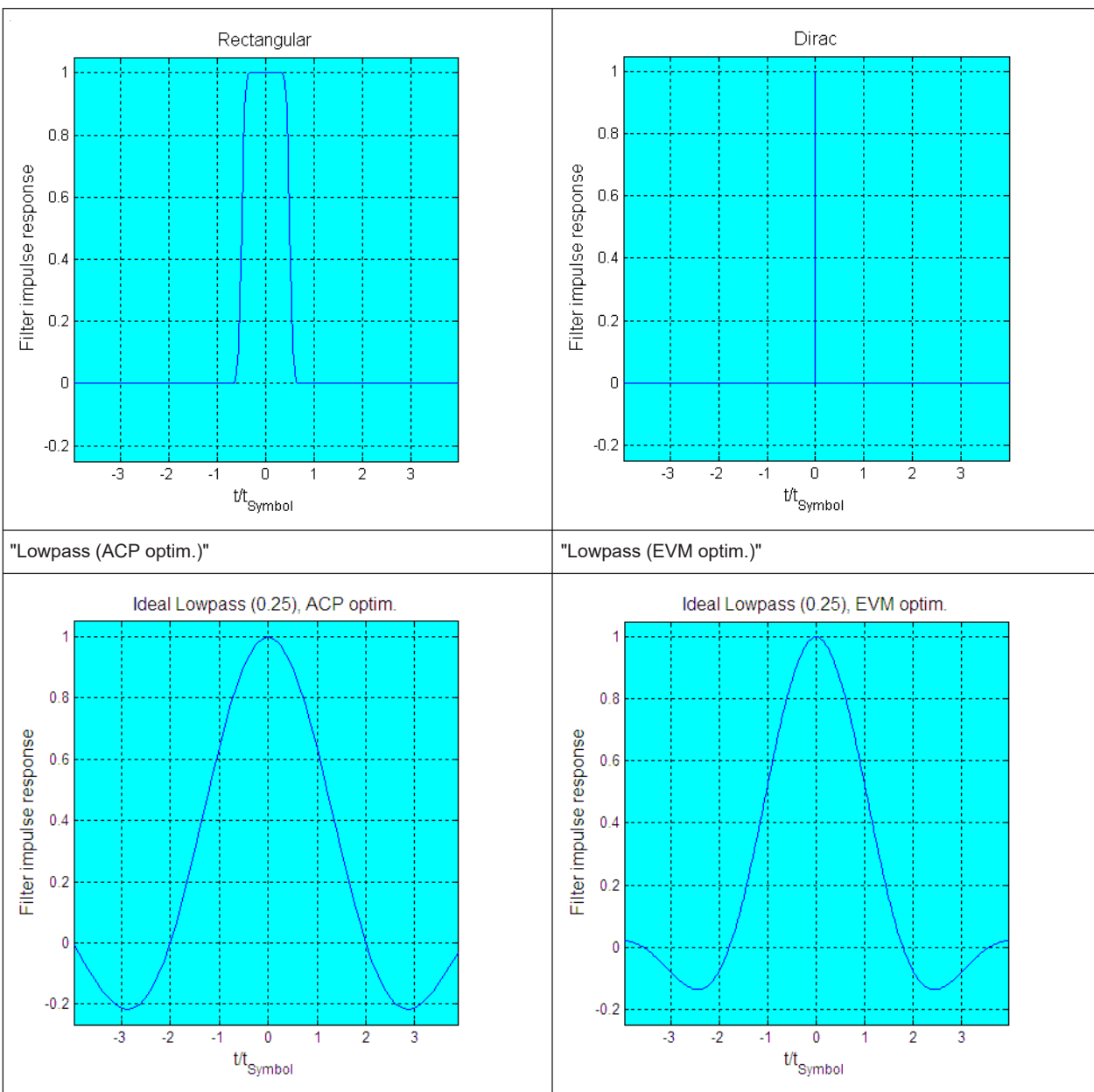

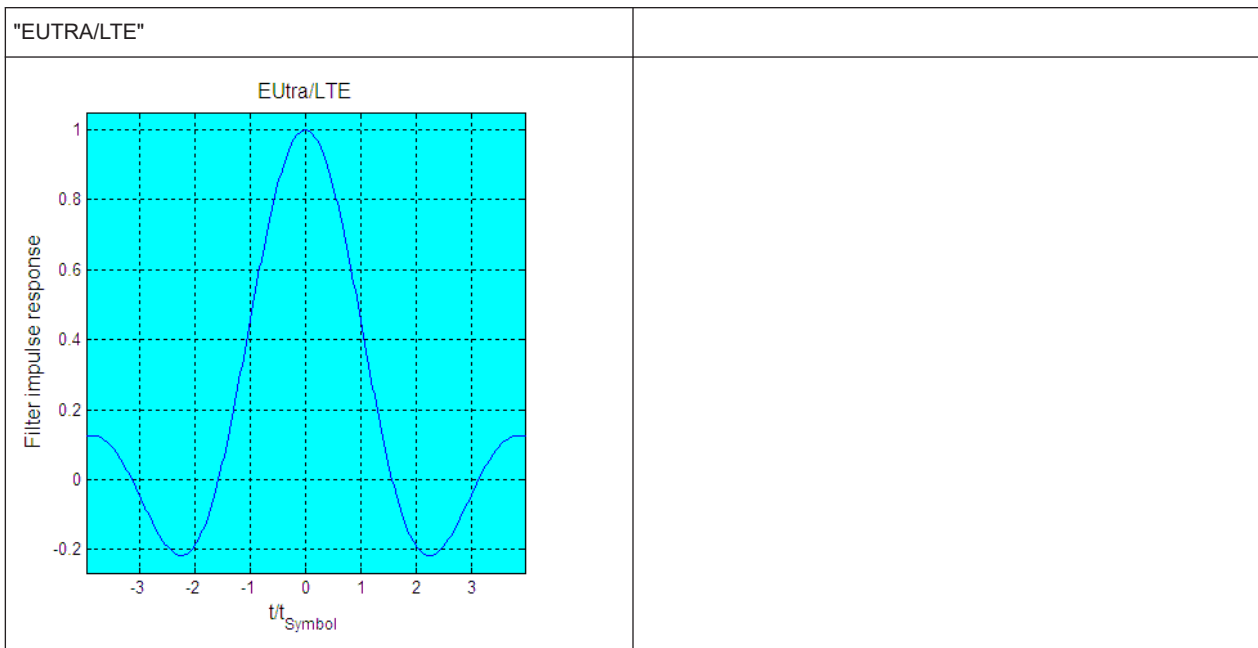

4.6 Using the arbitrary waveform generator (ARB)

The arbitrary waveform generator (ARB) is an I/Q modulation source of the R&S SMCV100B. The ARB allows the playback and output of any externally calculated modulation signals in the form of waveform files. The ARB can also generate multi-carrier or multi-segment signals from the waveform files.

4.6.1 Required options

The equipment layout for processing of waveform files includes:

- Base unit, including arbitrary waveform generator (64 MSample ARB memory, 60 MHz RF bandwidth)
- Digital standard waveform option (R&S SMCVB-K2xx/K4xx) to play a waveform file generated by the signal generation software R&S WinIQSIM2.
For example, if you purchase option Digital Standard EUTRA/LTE R&S SMCVB-K255, you can process EUTRA/LTE waveform file generated by R&S WinIQSIM2.
- Optional, ARB memory extension (R&S SMCVB-K511/-K512)
- Optional, ARB waveform streaming (R&S SMCVB-K505)
Required for direct streaming from a mass memory (internal SSD, external HDD or USB flash memory). Perform streaming at 75 MHz maximum clock frequency with no restrictions to the waveform file length.
- Optional, waveform libraries (R&S SMCVB-KVxx)
Required for playing waveforms of a waveform library. The libraries contain waveform files for various broadcast signals.

You can output waveform signals at several connectors. Dedicated connector output requires the following options:

- Output at the RF connector: RF frequency option (e.g. R&S SMCVB-B103)
- Output at the Dig. IQ HS x connectors: option digital baseband interface (R&S SMCVB-K19)

For more information, see data sheet.

4.6.2 About ARB

This section provides background information on the ARB functionality and the impact of the provided settings.

For a description of the multi-carrier, multi-segment and multi-carrier continuous wave functions, refer to:

- [Chapter 4.9, "Generating multi-carrier signals"](#), on page 220
- [Chapter 4.8, "Generating multi-segment waveform files"](#), on page 190

4.6.2.1 Waveform files sources

In ARB mode, the R&S SMCV100B uses ARB waveform files to obtain the digital I/Q data of the baseband signal. The R&S SMCV100B can play back any waveform file saved on a network drive but it can also generate and play back simple waveforms for test purposes.

What is a waveform?

A waveform is a file with specified file format containing raw IQ samples. The IQ values are calculated in advance and saved in waveform files with a predefined extension *.wv.

When waveforms are created by the R&S SMCV100B, the instrument inserts a waveform header at the beginning of each created ARB file. The header of the generated I/Q data files consists of "tags" which are enclosed in braces { }.

For detailed description on all available tags and for information on how to query them or to create waveforms manually, refer to [Chapter 4.6.7, "Tags for waveforms, data and control lists"](#), on page 173.

Waveform file sources

Depending on whether the R&S SMCV100B creates the waveform files itself or not, the following waveform file sources can be distinguished:

- **Internally generated waveforms**
The ARB generator enables the calculation and the generation of multi-segment and multi-carrier waveform files. The ARB generator provides also a built-in function to create a test waveform (e.g. a sine or rectangle signal) and keep it as a file or in the RAM.

Several digital standards provide the special function "Generate Waveform File". With this function, the calculated signals are saved as a waveform file that you can play back using the ARB generator.

- **Externally generated or created waveforms**

The ARB generator processes externally created waveform files, for example:

- The *waveform files generated* by the software R&S WinIQSIM2, the R&S ARB Toolbox, the R&S Pulse Sequencer
- Streaming of large waveform files from an internal solid-state drive (SSD) or an externally connected mass memory (HDD, USB flash drive).
- *Signals calculated* using a mathematical program such as MATLAB.
See [Chapter 4.6.7, "Tags for waveforms, data and control lists"](#), on page 173.

Irrespective of the way they are created, you can load the externally generated waveform files into the instrument via one of the available interfaces, e.g., USB or LAN. Usually, the waveform file is saved on one of the network drives which are accessible for the operating system.

- **Waveform libraries**

The R&S SMCV100B provides waveform libraries (R&S SMCVB-KVxx) containing a wide range of ready-made signals for testing systems with different transmission parameters. The libraries contain waveforms for numerous broadcast transmission standards.

For more information, see the user manual of the waveform library at:

www.rohde-schwarz.com/manual/smcv100b/ksxx-kvxx-stream-and-waveform-libraries-user-manuals-manuals-gb1_78701-972224.html

Related settings

See:

- [Chapter 4.6.3, "ARB settings"](#), on page 143

Related step-by-step descriptions

See:

- [Chapter 4.6.4, "How to create, generate and play waveform files"](#), on page 152
- [Chapter 4.6.4.5, "How to define periodically repeating traces"](#), on page 162
- [Chapter 4.6.4.4, "How to manually create a waveform using tag file format"](#), on page 158
- [Chapter 4.6.4.6, "How to create a control list using tag file format"](#), on page 164
- [Chapter 4.6.4.7, "How to create a data list using tag file format"](#), on page 166
- [Chapter 4.6.4.8, "Editing waveform files, data and control lists"](#), on page 167
- [Chapter 4.6.5, "How to work with waveform libraries"](#), on page 168

4.6.2.2 Playing and streaming waveform files

Depending on the way the loaded waveforms are processed, an ARB works in one of the following modes:

- Play back from the internal memory

In the most common case, the ARB generator plays back a waveform file with a selectable clock frequency. The R&S SMCV100B loads the entire file into the ARB memory from where the IQ samples are played repeatedly.

Playing back files is limited by the ARB memory size, e.g. 64 MSample, for a R&S SMCV100B base unit. Available ARB memory extensions are listed in the R&S SMCV100B data sheet.

- **Streaming**
Perform direct streaming from a mass memory at 75 MHz maximum clock frequency with no restrictions to the waveform file length. If HDD streaming is active, the instrument streams the modulation data directly from an internal solid-state drive (SSD) or an external storage device connected to the instrument via USB. We recommend that you use HDD streaming for processing of large files that require more memory than the internal SSD offers.

4.6.2.3 ARB test signals

The following test signals are available:

- **"Sine" test signal:** Two sinewave signals with a selectable (but equal) number of samples per period and equal frequencies. When the generation is triggered, the number of samples per period, together with the frequency of the test signal, determine the ARB clock frequency: "Clock Frequency" = "Frequency" * "Samples per Period".

Note: Because the resulting clock rate must not exceed the maximum ARB clock rate (see data sheet), the number of sample values is automatically restricted depending on the selected frequency.

The first sine signal is mapped on the I samples, the second on the Q samples.

The two signals differ by a selectable phase offset. For a -90 deg offset, the result is a unit vector in the I/Q plane, rotating counter-clockwise and starting at $I = 0$, $Q = -1$. For a 0 deg offset, the I and Q samples are on the diagonal of a unit square ($I(t) = Q(t)$).

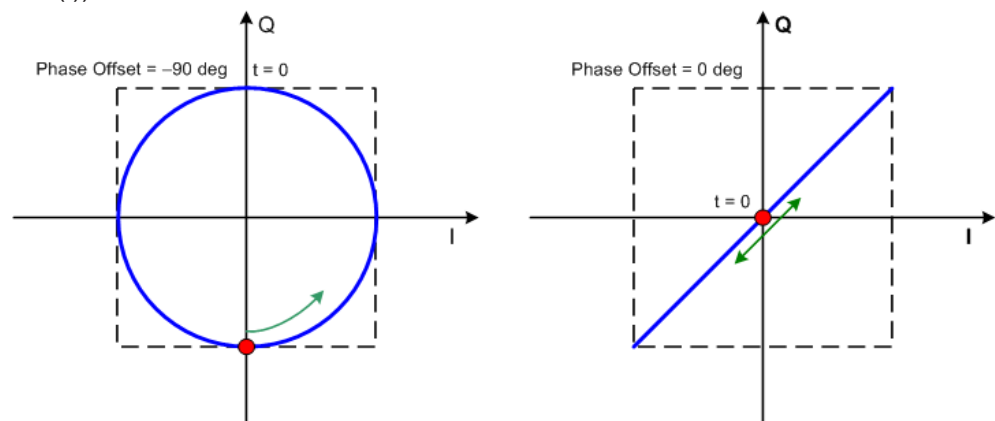

In general, the I/Q samples are located on a deformed circle which is confined to the dashed square in the upper diagrams.

- **"Rect" test signal:** Rectangle signal with selectable but equal On and Off periods and amplitude. The period is defined by the selected frequency: $\langle \text{Period} \rangle = 1 / \text{"Frequency"}$.

Using the arbitrary waveform generator (ARB)

The signal is mapped on both the I and Q samples. The mapping results in two distinct points in the I/Q plane. The "Offset DC" shifts both points along the diagonal $I(t) = Q(t)$.

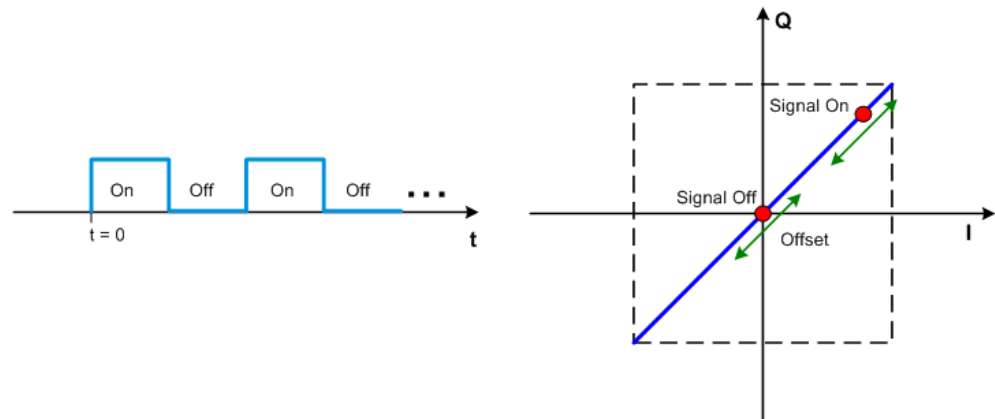

- "Const I/Q" test signal:** Continuous test signal with constant IQ and constant clock frequency of 10 kHz. The values for each I and Q components are selectable but constant. They are defined as a decimal number, which is decimal-to-binary converted internally. The signal is provided as a 16-bit wide digital signal for both I and Q channels. You can output the signal directly at the BNC connectors I and Q outputs of the instrument.

4.6.2.4 Waveform sample rate

The Arbitrary Waveform Generator includes a resampling unit that interpolates the input samples to target a certain digital output I/Q sample rate. The input sample rate f_{input} is retrieved from the waveform (the default sample rate tag) or is defined by the corresponding parameter in the ARB user interface.

The [Figure 4-12](#) depicts the stages involved in the processing and resampling of a waveform in the ARB.

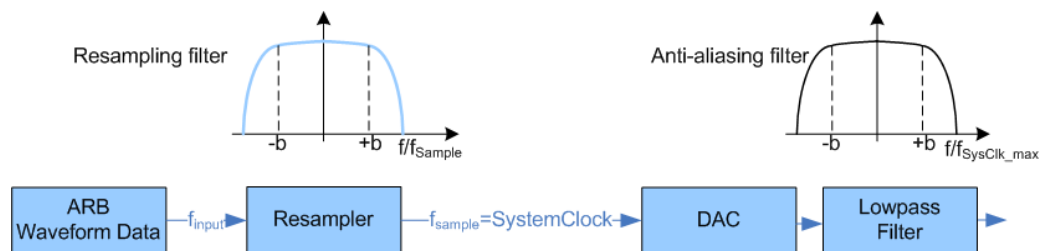

Figure 4-12: Processing of the waveform files in the ARB

f_{input} = Waveform sample rate
 b = Usable bandwidth factor
 f_{sysClk_max} = $SystemClock_{max}$ = $SampleRate_{max}$

Where:

- f_{sysClk_max} = $SystemClock_{max}$ = $SampleRate_{max}$ = 300 MHz

- $b = 0.4165$

Impact of the resampling filter

As illustrated in [Figure 4-12](#), the filter in the resampling stage is distortion-free for signals with the following maximum baseband bandwidth:

$$Usable_Bandwidth_{max} [MHz] = b * f_{input}$$

The usable bandwidth factor b equals $b = 0.4165$.

An externally created waveform file has to provide a sample rate f_{input} that is high enough for perfect signal reconstruction. For distortion-free resampling the lower bound of the required sample rate f_{input} is then calculated as follows:

$$f_{input} \geq Usable_Bandwidth / b$$

Thus, a modulation signal with a sample rate $f_{input} = 300$ MHz fed in the baseband generator ensures the $Usable_Bandwidth_{max}$. After the DAC, this signal features a $RF_Bandwidth_{max} = 2 * b * f_{input} = 2 * b * 300$ MHz = 240 MHz.

Impact of the oversampling factor

Waveforms generated by the R&S WinIQSIM2 software can be optimized by choosing a suitable integer oversampling factor.

Conventional ARB generators often assume oversampling factors of 4. The ARB generator of the R&S SMCV100B requires low oversampling factors and still provides excellent signal quality in terms of EVM and ACP.

A reduced sample rate saves significantly the amount of memory or allows an increased signal cycle time, and vice versa.

4.6.2.5 Impact of enabled number of marker signals on waveform length

The R&S SMCV100B provides the possibility to define marker signals that are sent to the marker outputs in synchronicity with the I/Q output signals. Marker signals can be either predefined or later defined.

The I/Q data and marker data are located in separate memory areas of the SDRAM and can be independently configured. Each marker signal requires 1 bit of the available memory size. Sometimes, it is useful to generate a modulation signal without extra marker signals to increase the maximum waveform length.

The following example explains the dependency between the number of enabled marker signals, the available memory size, and the resulting waveform length.

Example: Calculating the maximum waveform length

The calculation in this example assumes R&S SMCV100B equipped with option R&S SMCVB-K511 (512 Msamples).

- Total memory size = 512 MB
- Required memory size (per complex sample) = 32 bits + 4 bits = 36 bits = 4.5 bytes, where:
 - The raw I/Q samples are saved as 16-bit values;
That is, for I/Q data = 2 x 16 bits = 32 bits (16 bits per I/Q channel)
 - Each software defined marker requires 1 bit;
That is, for 4 enabled markers = 4 x 1 bit = 4 bits
- Maximum waveform length (with 3 markers) = 512 MB / 4.5 bytes = 113 Msamples
- Theoretical maximum waveform length (no markers) = 512 MB / 4 bytes = 128 Msamples

Hence, a memory size of 512 MB yields a maximum waveform length of 116 Msamples, if three markers are enabled. The maximum waveform length increases to 128 Msamples, if the internal hardware markers are used, and the complete memory is available for I/Q data.

The minimum length of a waveform is 512 samples. A waveform shorter than this value is automatically repeated until it reaches the minimum length.

4.6.3 ARB settings

Access:

- ▶ Select "Baseband > ARB".

The "ARB" dialog enables direct selection of the waveform file to be processed, the selection of a test signal or access to the multi-segment and multi-carrier settings.

The remote commands required to define these settings are described in [Chapter 14.16.3.3, "SOURce:BB:ARbitrary subsystem"](#), on page 687.

Settings:

- [ARB general settings](#)..... 143
- [Sine test signals](#)..... 147
- [Rectangular test signal](#)..... 148
- [Constant IQ test signal](#)..... 150
- [Trigger, marker and clock settings](#)..... 151

4.6.3.1 ARB general settings

Access:

- ▶ Select "Baseband > ARB".

This tab provides access to the default ARB settings, selecting a waveform file and enabling the ARB generator.

Further settings depend on selected "System Configuration" and waveform type:

- If a single segment waveform is used, the tab provides also settings for configuring the test signal and access to the settings for calculating a multi-segment or a multi-carrier waveform.
- If a multi-segment waveform is loaded, the tab expands and displays the dedicated section "Multi Segment Waveform Options".

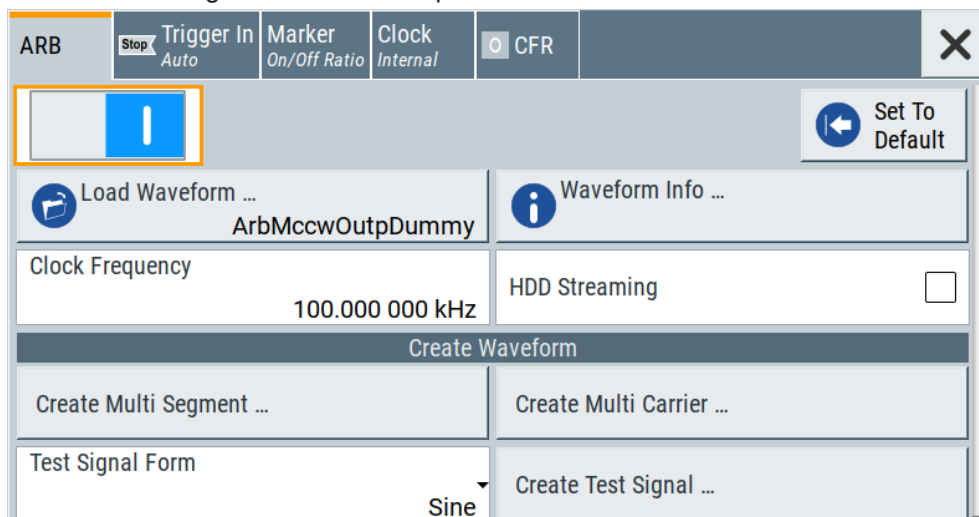

This section comprises the settings necessary to configure the segment to be output and adjust the trigger for the switch between the segments of the multi-segment waveform. The parameters displayed depend on the selected trigger source. The provided parameters are identical with the parameters in the section "Next Segment Trigger In" in the "Trigger" tab; for information see [Chapter 4.8.3.5, "Multi-segment waveform trigger settings"](#), on page 208.

Settings:

State.....	144
Set To Default.....	145
Load Waveform/File.....	145
Waveform Info.....	145
Clock Frequency.....	146
HDD Streaming.....	146
Create Multi Segment.....	146
Create Multi Carrier.....	147
Test Signal Form.....	147
Create Test Signal.....	147

State

Enables/disables ARB modulation. Switching on the ARB generator turns off all the other digital standards and digital modulation types in the same signal path.

The output is based on the waveform file that is loaded. The name of the waveform file is displayed next to "Load Waveform". When a multi-segment waveform is loaded, the display expands and lists more settings, grouped in the "Multi Segment Waveform Options" section.

Note: ARB generator cannot be activated.

You cannot activate the ARB generator in the following cases:

- **No or empty waveform file**

If no waveform file is loaded, as in the default state, "None" is displayed next to "Load Waveform". An error message indicates that no or empty waveform file is selected.

Select a waveform file, before switching on the ARB.

Remote command:

[\[:SOURce<hw>\]:BB:ARBitrary:STATe](#) on page 696

Set To Default

Calls default settings, see [Table 4-12](#).

Table 4-12: ARB default settings

Parameter	Value
State	Off
Clock Frequency	1 MHz
Trigger Mode	Auto
Trigger Source	Internal
Marker State	Off
Marker Mode	Unchanged
Clock Source	Internal

Remote command:

[\[:SOURce<hw>\]:BB:ARBitrary:PRESet](#) on page 696

Load Waveform/File

Accesses the standard "File Select" function of the instrument. The provided navigation possibilities in the dialog are self-explanatory.

The waveform files are files with predefined file extension *.wv. When a file is selected, the dialog displays short information about the selected waveform.

Enable the ARB generator ("ARB > State > On") to trigger the instrument to load and process the selected waveform file.

Remote command:

[\[:SOURce<hw>\]:BB:ARBitrary:WAVEform:SElect](#) on page 701

Waveform Info

Opens a dialog with detailed information about the currently selected waveform. The display depends on whether the selected waveform file is a multisegment one or not. All parameters are read-only.

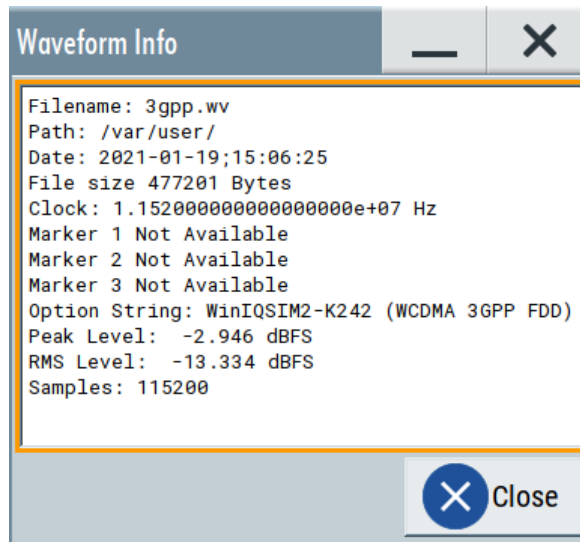

Remote command:

For non-multi segment waveform files, use the `Tag` commands (see [Chapter 4.6.7, "Tags for waveforms, data and control lists"](#), on page 173).

Clock Frequency

Displays or sets the ARB output clock rate.

The value of this parameter is set to the clock rate defined in the loaded waveform file (`{CLOCK}` tag). The value can be changed afterwards.

Note: The clock frequency must match the value of the externally applied clock source.

Remote command:

`[:SOURCE<hw>] :BB:ARbitrary:CLOCK` on page 703

HDD Streaming

Option: R&S SMCVB-K505

Activates ARB waveform streaming from a mass memory. The internal solid-state drive or an external mass memory (HDD, USB flash memory) can provide as memory.

Connect the external memory to one of the USB connectors. We recommend that you connect to the USB 3.0 connectors on the rear panel, to provide sufficient streaming quality.

How to: ["To activate waveform streaming"](#) on page 172

If streaming is activated, you can only use trigger modes "Auto" and "Armed Auto" and marker modes "Restart". See also ["Mode"](#) on page 101 and ["Marker Mode"](#) on page 104.

Remote command:

`[:SOURCE<hw>] :BB:ARbitrary:WAVEform:HDDStreaming:STATE` on page 704

Create Multi Segment

Accesses the dialog for creating multi-segment waveforms (see [Chapter 4.8, "Generating multi-segment waveform files"](#), on page 190).

Create Multi Carrier

Accesses the dialog for creating multi-carrier waveforms (see [Chapter 4.9, "Generating multi-carrier signals"](#), on page 220).

Test Signal Form

Selects the form of the test signal. A choice between a sinusoidal, rectangular, AWGN or test signal with constant I/Q is provided.

To access further settings, select [Create Test Signal](#).

Remote command:

`[:SOURce<hw>] :BB:ARBitrary:SIGnal:TYPE` on page 697

Create Test Signal

Opens the dialog with further setting for the selected [Test Signal Form](#), see:

- [Chapter 4.6.3.2, "Sine test signals"](#), on page 147
- [Chapter 4.6.3.3, "Rectangular test signal"](#), on page 148
- [Chapter 4.6.3.4, "Constant IQ test signal"](#), on page 150

4.6.3.2 Sine test signals

Access:

- ▶ Select "Baseband > ARB > General > Test Signal Form > Sine" and press "Create Test Signal".

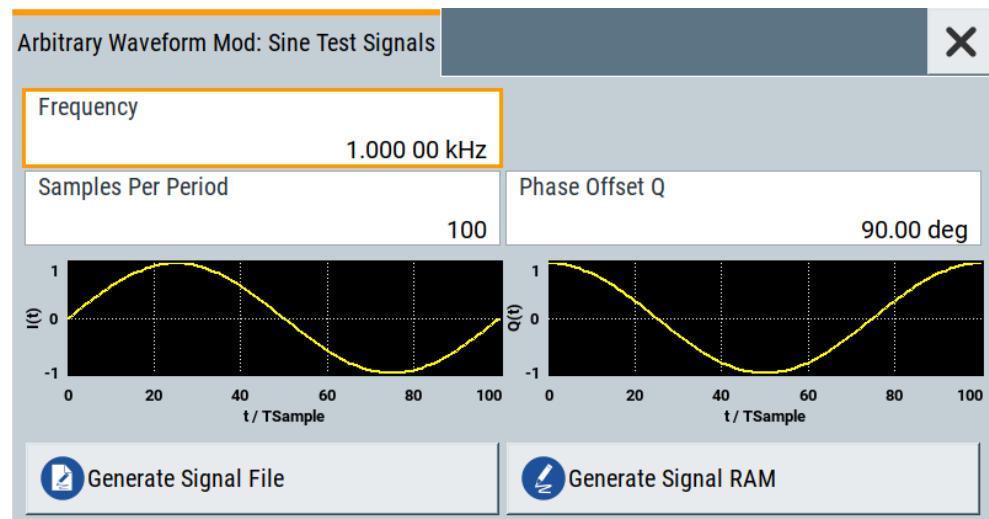

This dialog provides settings for configuration of a sinusoidal test signal. A sine wave is generated on the I path, and a sine wave of the same frequency but phase-shifted is generated on the Q path. For more information, refer to [Chapter 4.6.2.3, "ARB test signals"](#), on page 140.

The dialog displays the characteristic of the currently selected signal.

Settings:

Frequency.....	148
Samples per Period.....	148
Phase Offset Q.....	148
Generate Signal File.....	148
Generate Signal RAM.....	148

Frequency

Enters the frequency of the test signal.

Remote command:

[\[:SOURce<hw>\]:BB:ARbitrary:TSIGnal:SINE:FREQuency](#) on page 699

Samples per Period

Enters the number of sample values required from the sine wave per period.

The maximum allowed value is determined by the maximum ARB clock rate (see data sheet) and the selected frequency.

Remote command:

[\[:SOURce<hw>\]:BB:ARbitrary:TSIGnal:SINE:SAMPles](#) on page 699

Phase Offset Q

Enters the phase offset of the sine-wave signal on the Q channel relative to the sine-wave signal on the I channel.

Remote command:

[\[:SOURce<hw>\]:BB:ARbitrary:TSIGnal:SINE:PHASe](#) on page 699

Generate Signal File

Generates a signal and saves it as a waveform file on the hard disk. Use the standard "File Select" function to save the file.

Remote command:

[\[:SOURce<hw>\]:BB:ARbitrary:TSIGnal:SINE:CREate:NAMed](#) on page 700

Generate Signal RAM

Generates a signal and uses this signal as output straight away. The instrument saves the file using a predefined filename.

Remote command:

[\[:SOURce<hw>\]:BB:ARbitrary:TSIGnal:SINE:CREate](#) on page 700

4.6.3.3 Rectangular test signal

Access:

1. Select "Baseband > ARB > General > Test Signal Form > Rect".

2. Select "Create Test Signal".

Arbitrary Waveform Mod: Rect Test Signal

Frequency: 1.000 00 kHz

Samples Per Period: 100

Amplitude: 0.800 FS

Offset DC: 0.000 FS

Generate Signal File Generate Signal RAM

This dialog provides settings for configuration of a rectangular test signal. A rectangular test signal with a duty factor of 0.5 is created. Amplitude and offset are adjustable. Both paths, I and Q, use the same signal.

For more information, refer to [Chapter 4.6.2.3, "ARB test signals"](#), on page 140.

Settings:

Frequency.....	149
Samples per Period.....	149
Amplitude.....	149
Offset DC.....	150
Generate Signal File.....	150
Generate Signal RAM.....	150

Frequency

Enters the frequency of the test signal.

Remote command:

`[:SOURce<hw>] :BB:ARbitrary:TSIGnal:RECTangle:FREQuency` on page 698

Samples per Period

Enters the number of sample values required for the rectangular signal per period.

The maximum allowed value is determined by the maximum ARB clock rate (see data sheet) and the selected frequency.

Remote command:

`[:SOURce<hw>] :BB:ARbitrary:TSIGnal:RECTangle:SAMPles` on page 698

Amplitude

Enters the digital amplitude of the rectangular wave. The abbreviation FS means full-scale.

Remote command:

`[:SOURce<hw>] :BB:ARbitrary:TSIGnal:RECTangle:AMPLitude` on page 697

Offset DC

Enters a DC component.

Remote command:

[\[:SOURce<hw>\]:BB:ARbitrary:TSIGnal:RECTangle:OFFSet](#) on page 698

Generate Signal File

Generates a signal and saves it as a waveform file on the hard disk. Use the standard "File Select" function to save the file.

Remote command:

[\[:SOURce<hw>\]:BB:ARbitrary:TSIGnal:RECTangle:CREate:NAMed](#)
on page 700

Generate Signal RAM

Generates a signal and uses it as outputs straight away. The instrument saves the file using a predefined filename.

Remote command:

[\[:SOURce<hw>\]:BB:ARbitrary:TSIGnal:SINE:CREate](#) on page 700

4.6.3.4 Constant IQ test signal

Access:

1. Select "Baseband > ARB > General > Test Signal Form > Const IQ".
2. Select "Create Test Signal".

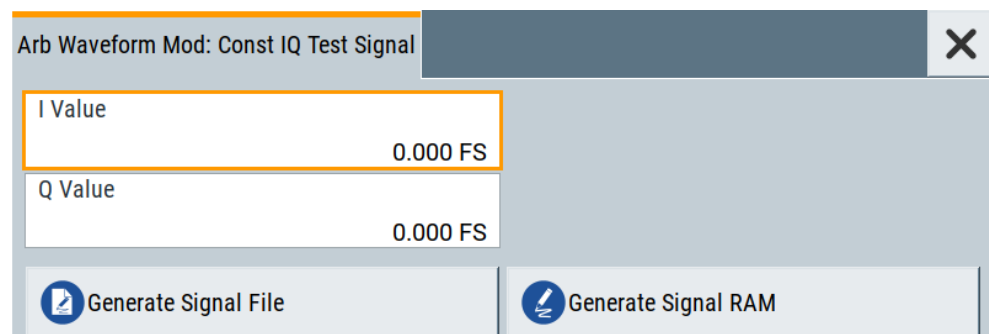

This dialog provides settings for configuration of a continuous test signal with constant IQ. The I and Q values for each path are adjustable but constant. For more information, refer to [Chapter 4.6.2.3, "ARB test signals"](#), on page 140.

Settings:

I Value, Q Value	150
Generate Signal File	151
Generate Signal RAM	151

I Value, Q Value

Enters the value for the I respectively Q component of the test signal.

Remote command:

`[:SOURce<hw>] :BB:ARBitrary:TSIGnal:CIQ:I` on page 697

`[:SOURce<hw>] :BB:ARBitrary:TSIGnal:CIQ:Q` on page 697

Generate Signal File

Generates a signal and saves it as a waveform file on the hard disk. Use the standard "File Select" function to save the file.

Remote command:

`[:SOURce<hw>] :BB:ARBitrary:TSIGnal:CIQ:CREate:NAMed` on page 700

Generate Signal RAM

Generates a signal and uses this signal as output straight away. The instrument saves the file using a predefined filename.

Remote command:

`[:SOURce<hw>] :BB:ARBitrary:TSIGnal:CIQ:CREate` on page 700

4.6.3.5 Trigger, marker and clock settings

These tabs provide standard settings.

For detailed description, see:

- [Chapter 4.4.2.1, "Trigger settings"](#), on page 101
- [Chapter 4.4.2.2, "Marker settings"](#), on page 104
- [Chapter 4.4.2.3, "Clock settings"](#), on page 105
- [Chapter 4.4.2.4, "Global connector settings"](#), on page 106

The following settings are specific to the ARB dialog.

Processing Time	151
Marker Mode	151
Delay (Time)	152

Processing Time

Displays the internal processing time.

The processing time is the elapsed time between the input of the external trigger event and the output of the baseband signal. An additional delay applies to the RF signal with respect to the baseband signal depending on the RF frequency. For more information, see ["Starting the signal generation with the first sample"](#) on page 91.

Remote command:

`[:SOURce<hw>] :BB:ARBitrary:TRIGger:PTIME?` on page 726

Marker Mode

Basic marker configuration for up to three marker channels. The contents of the dialog change with the selected marker mode.

Use the settings to define the shape and periodicity of the markers. See [Regular marker output signals](#) for description of the regular marker signals.

Note: The marker trace in the waveform file remains unchanged in any case. It is not overwritten, even if something else than Unchanged has been selected.

The instrument routes the generated marker signals to the selected output connectors. See also [Chapter 12.2, "Configuring global connectors"](#), on page 449.

"Unchanged" The marker signal remains unchanged as defined in the waveform file.

Remote command:

`[:SOURce<hw>] :BB:ARBitrary:TRIGger:OUTPut<ch>:MODE` on page 728

`[:SOURce<hw>] :BB:ARBitrary:TRIGger:OUTPut<ch>:PULSe:DIVider` on page 729

`[:SOURce<hw>] :BB:ARBitrary:TRIGger:OUTPut<ch>:PULSe:FREQuency?` on page 729

`[:SOURce<hw>] :BB:ARBitrary:TRIGger:OUTPut<ch>:PATtern` on page 728

`[:SOURce<hw>] :BB:ARBitrary:TRIGger:OUTPut<ch>:OFFTime` on page 728

`[:SOURce<hw>] :BB:ARBitrary:TRIGger:OUTPut<ch>:ONTime` on page 728

Delay (Time)

Shows the [marker delay](#) time in microseconds, milliseconds or seconds depending on the set marker delay.

Remote command:

`[:SOURce<hw>] :BB:ARBitrary:TRIGger:OUTPut<ch>:DINSec?` on page 730

4.6.4 How to create, generate and play waveform files

This section provides step-by-step instructions on configuring and using the provided settings. For details on individual functions and settings, see [Chapter 4.6.3, "ARB settings"](#), on page 143.

Some test cases do not require a real-time generation of signal according to a digital standard. For these test cases, the replay of a previously generated waveform is sufficient. In such cases, you can generate the required test waveform file in one of the following ways:

- Internally, with the "Create ARB Test Signal" function, see [Chapter 4.6.4.1, "How to create and save ARB test signals"](#), on page 153
- Externally, for example:
 - With the free of charge software R&S WinIQSIM2, see [Chapter 4.6.4.3, "How to use waveform files with R&S WinIQSIM2"](#), on page 154
 - With the software R&S ARB Toolbox
 - Calculated using a mathematical program such as MATLAB, see [Chapter 4.6.4.4, "How to manually create a waveform using tag file format"](#), on page 158.

Provided the R&S SMCV100B is equipped with the required option, you can load this waveform file and subsequent process it with the instrument.

This section provides examples on the internal waveform file generation and on the external generation with the R&S WinIQSIM2.

4.6.4.1 How to create and save ARB test signals

If your test case requires a simple sine or square test file, consider to use the provided ARB test signals.

To generate a sine test signal

1. Select "Baseband > ARB"
2. Select "Create Test Signal > Sine".
3. Adjust the "Sine Test Signal" settings as required.
4. Select "Generate Signal File".

A standard file-select dialog opens.

- a) Navigate to the directory, in that you want to save the file, e.g. `/var/user/`.
- b) Enter a filename (e.g. `sine_waveform`).
- c) Click "Save".

The R&S SMCV100B saves the generated waveform file and automatically loads it in the ARB.

5. Select "ARB > State > On".

The R&S SMCV100B processes the waveform file.

4.6.4.2 How to load and play waveform files

Irrespective on the way a waveform file is generated, you can transfer it to the instrument, load it in the ARB and play it.

To load and play a waveform file

1. Transfer an externally created waveform file to the instrument (see [Chapter 11.9, "How to transfer files from and to the instrument"](#), on page 434).

2. Select "Baseband > ARB"

3. Select "Load Waveform".

A standard file-select dialog opens.

- a) Navigate to the directory, that the waveform file contains.
- b) Select the waveform file, e.g., `/var/user/lte_waveform`.
- c) Click "Select".

The "ARB" dialog confirms that the waveform file is loaded.

4. Select "ARB > State > On".

The R&S SMCV100B processes the waveform file.

4.6.4.3 How to use waveform files with R&S WinIQSIM2

The following example illustrates how to use R&S WinIQSIM2 to generate an EUTRA/LTE waveform and load it in the ARB of the R&S SMCV100B.

The workflow consists of three main steps, each described in a separate step-by-step instruction:

- Configuring the connection between the R&S WinIQSIM2 and the R&S SMCV100B
- Generating of a waveform file with the required settings
- Transferring the waveform file to and playing it with the R&S SMCV100B.



This section does not describe the R&S WinIQSIM2 but focuses only the task-related settings.

For more information on configuration and working with the R&S WinIQSIM2, refer to description "R&S WinIQSIM2 User Manual".

To define the R&S SMCV100B as destination instrument

In this example, we assume that the R&S WinIQSIM2 is installed on a remote controller. This remote controller is connected over LAN to the R&S SMCV100B.

The general instrument settings of the destination instrument affect various functions, like, the maximum size of the file the waveform is saved in. We recommend that you configure the destination instrument before you generate the waveform with the R&S WinIQSIM2.

1. In the R&S WinIQSIM2, select "File > New" to preset the software to a defined state.
2. In the block diagram, select "Vector Sig Gen > Instruments".

The "Configure Instruments" dialog opens. The list of configured instruments is empty.

3. Select "Configure Instruments > Scan".

The software scans the network for connected and active instruments.

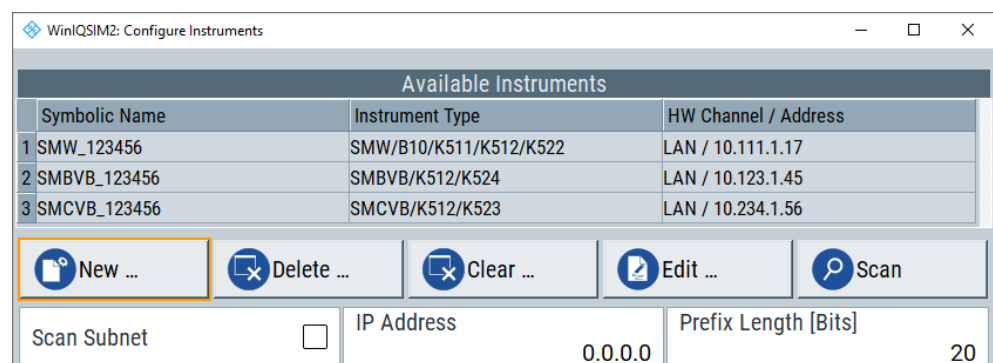

Alternatively, use the "New" function to add the R&S SMCV100B manually to the list of instruments.

4. Close the dialog.
5. In the block diagram, select "Vector Sig Gen" block and select the R&S SMCV100B form the list.

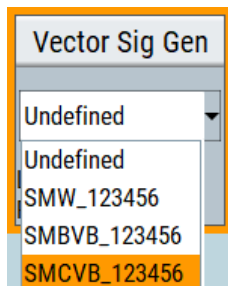

6. In the block diagram, select "ARB Sig Gen" block and select the R&S SMCV100B form the list.

The two lines to the "Vector Sig Gen" and "ARB Sig Gen" blocks on the block diagram confirm that a remote connection to the R&S SMCV100B is established.

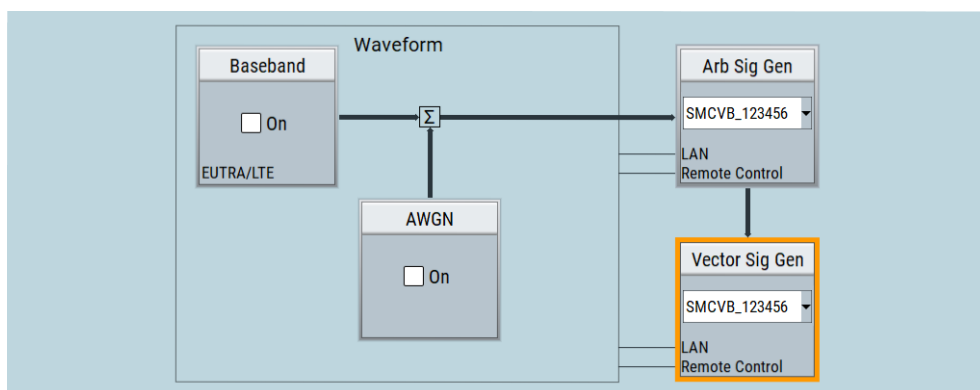

To generate a waveform file with R&S WinIQSIM2

1. In the block diagram of R&S WinIQSIM2, select "Baseband > EUTRA/LTE/IoT".
2. Adjust the settings as required, for example:
 - a) Select "Link Direction > Downlink (OFDMA)"
 - b) Select a predefined test model, for example, "Test Models > E-TM1_1__10MHz".
3. Enable "EUTRA/LTE/IoT > State > On".

Using the arbitrary waveform generator (ARB)

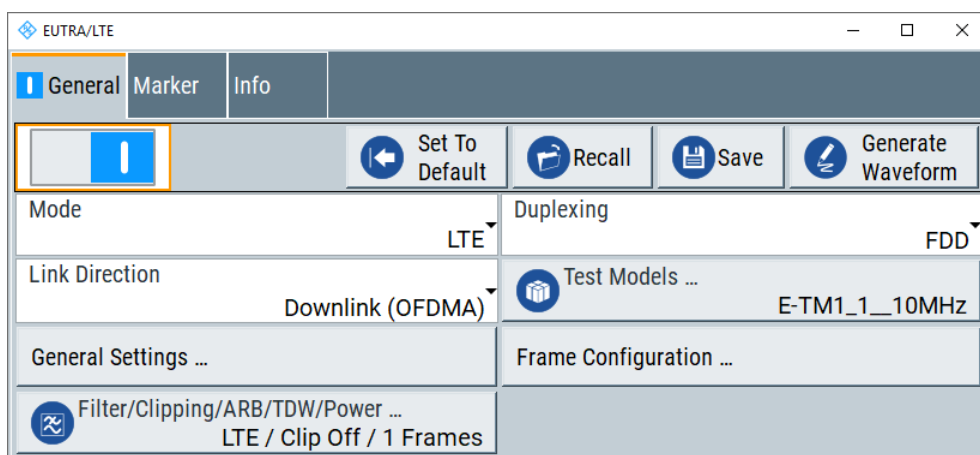

The R&S WinIQSIM2 calculates the signal and displays important signal parameters, like the used "Sample Rate" and "Number of Samples".

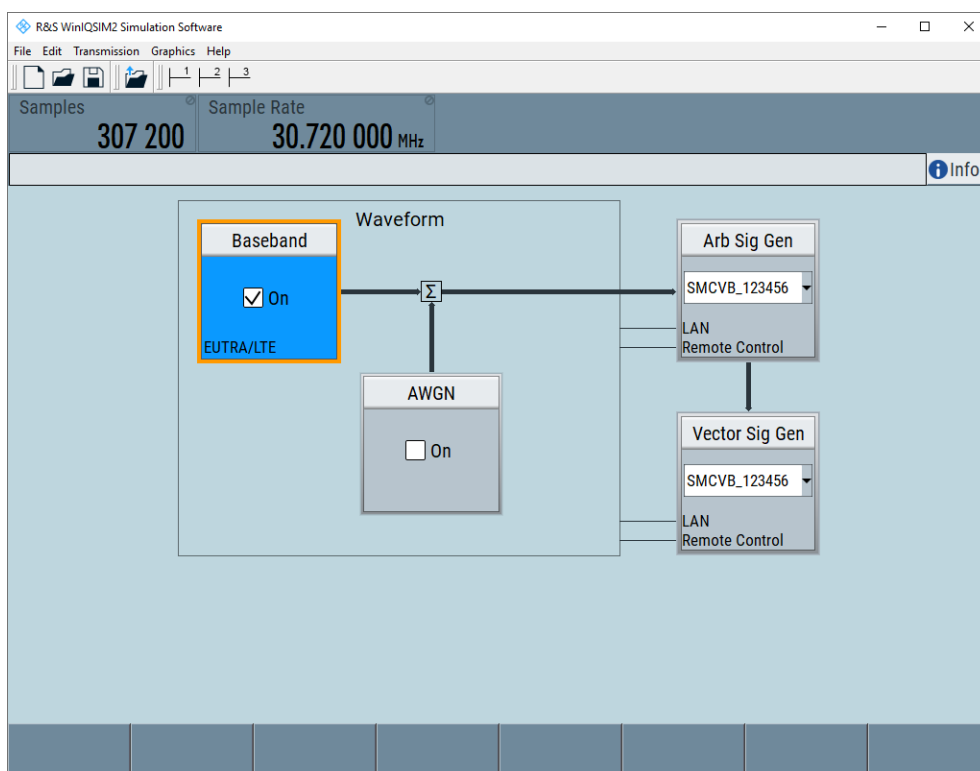



Use "Graphics > Graphic 1 (Complete)" view to retrieve more information on the generated signal.

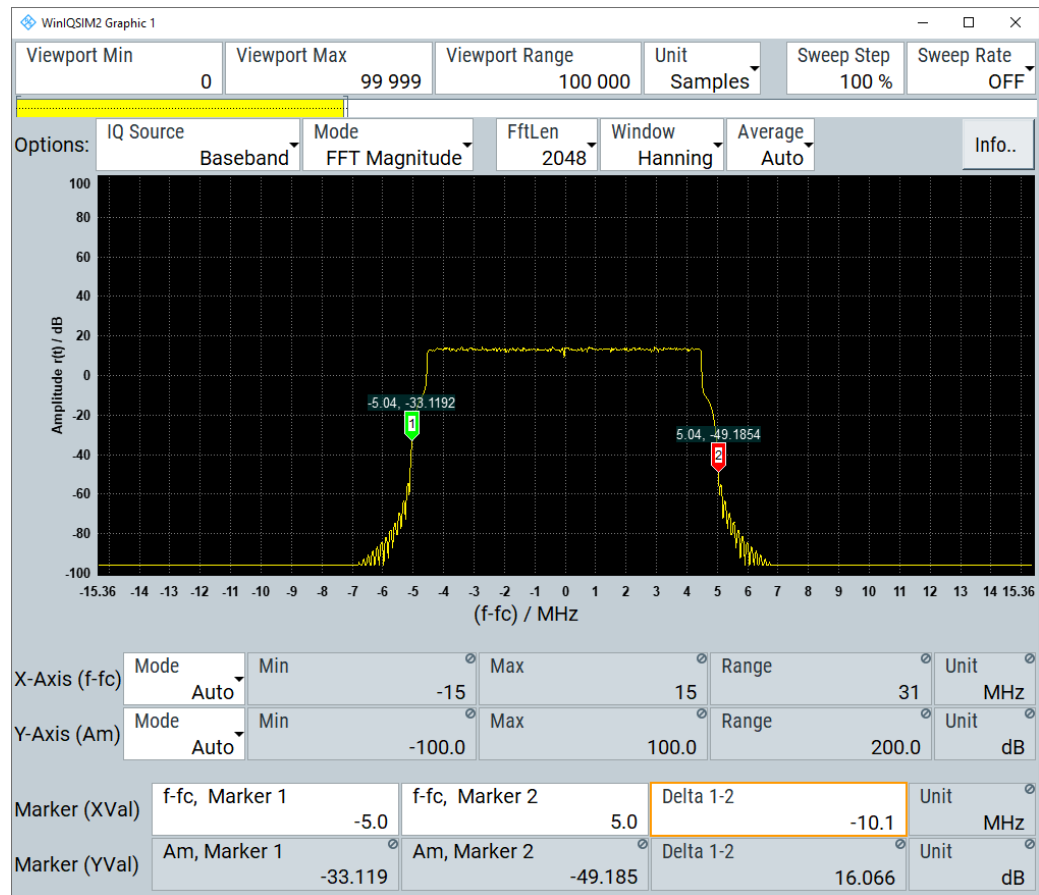

The display confirms the expected EUTRA/LTE 10 MHz spectrum.

To transfer the waveform file to the R&S SMCV100B

1. In the R&S WinIQSIM2, select "Transmission > Transmit".
2. In the "Waveform Transmission to Arbitrary Waveform Generator" dialog, select:
 - a) "Transmit from > Internal (WinIQSIM2)"
 - b) "Transmit to > Instrument".
 - c) Select "File".
 - d) Define the filename of the transmitted file.
 - e) Activate "Automatically Load and Start Waveform".
 - f) Select the required baseband, for example, "Path A".
 - g) Add a comment to the waveform.
 - h) Select "Transmit".

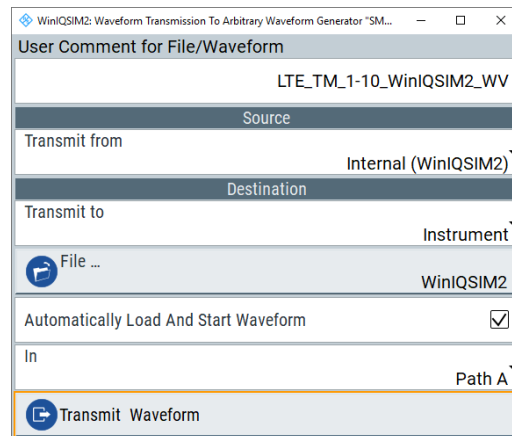

The waveform is transmitted to the default directory of the R&S SMCV100B.

3. In the R&S SMCV100B, select "Baseband > ARB".

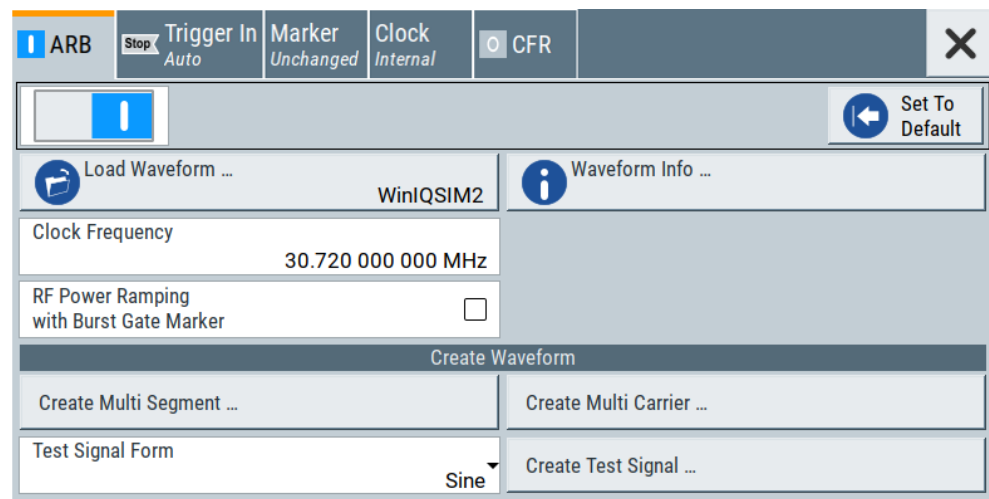

The dialog confirms that the ARB is enabled and plays the transmitted waveform.

4.6.4.4 How to manually create a waveform using tag file format

The provided example uses a sine function in the I channel and a cosine function in the Q channel, each with 20 points. The example uses a short program written in the programming language C to calculate the sine and cosine values (see [Example "C-program for creating a waveform file"](#) on page 161). They are saved in the file `SICO.txt`. The decimal values in `SICO.txt` are normalized such that they are between -1.0 and $+1.0$. The data is converted into binary format. The appropriate mandatory tags are added and the data is packed into the `WAVEFORM` tag. As result, the waveform file `SICO.wv` is generated.

This example follows the general principle of creating of a waveform manually, using the tag file format. The [Figure 4-13](#) illustrates this general workflow.

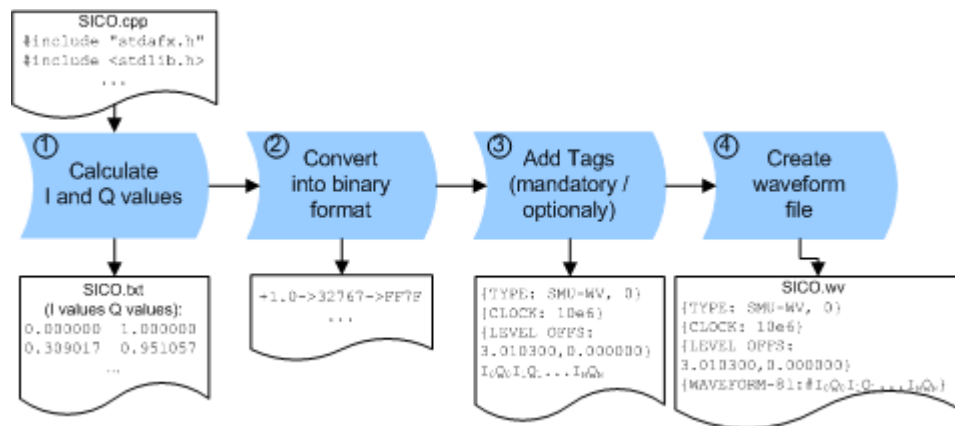

Figure 4-13: Principle of creating a waveform manually

The following steps outline how to create the waveform file `SICO.wv`:

1. Calculate the sine and cosine values, e.g. use the `SICO.cpp` program.

The result is saved in the file `SICO.txt`.

```

0.000000 1.000000
0.309017 0.951057
0.587785 0.809017
0.809017 0.587785
0.951057 0.309017
1.000000 -0.000000
0.951057 -0.309017
0.809017 -0.587785
0.587785 -0.809017
0.309017 -0.951057
-0.000000 -1.000000
-0.309017 -0.951056
-0.587785 -0.809017
-0.809017 -0.587785
-0.951056 -0.309017
-1.000000 0.000000
-0.951056 0.309017
-0.809017 0.587785
-0.587785 0.809017
-0.309017 0.951057
  
```

Figure 4-14: Contents of `SICO.txt`: first column Sine (I), second column Cosine (Q)

2. Convert the values from the file `SICO.txt` into binary format consisting of 16-bit signed integer numbers. The numeric range between -1.0 and $+1.0$ corresponds to the modulation range of the waveform 16-bit D/A converter of -32767 to $+32767$.

```

+1.0 -> 32767 -> = 0x7FFF
0.0 -> 0 -> = 0x0000
-1.0 -> -32767 -> = 0x8001
  
```

The [Figure 4-15](#) shows the calculation and conversion steps. The highlighted columns contain the resulting I and Q values represented in Little endian format.

Sample n	deg = $360/20 * n$	I = sin(deg)	I _{quant,dec} = I * FS = I * (2 ¹⁵ -1)	I _{quant,hex}	I _{quant,hex} (little-endian waveform file representation)	Q = cos(deg)	Q _{quant,dec} = I * FS = I * (2 ¹⁵ -1)	Q _{quant,hex}	Q _{quant,hex} (little-endian waveform file representation)
0	0	0.000000	0	0000	0000 I ₀	1.000000	32767	7FFF	FF7F Q ₀
1	18	0.309017	10126	278E	8E27	0.951057	31163	79BB	BB79
2	36	0.587785	19260	4B3C	3C4B	0.809017	26509	678D	8D67
3	54	0.809017	26509	678D	8D67	0.587785	19260	4B3C	3C4B
4	72	0.951057	31163	79BB	BB79	0.309017	10126	278E	8E27
5	90	1.000000	32767	7FFF	FF7F	0.000000	0	0000	0000
6	108	0.951057	31163	79BB	BB79	-0.309017	-10126	D872	72D8
7	126	0.809017	26509	678D	8D67	-0.587785	-19260	B4C4	C4B4
8	144	0.587785	19260	4B3C	3C4B	-0.809017	-26509	9873	7398
9	162	0.309017	10126	278E	8E27	-0.951057	-31163	8645	4586
10	180	0.000000	0	0000	0000	-1.000000	-32767	8001	0180
11	198	-0.309017	-10126	D872	72D8	-0.951057	-31163	8645	4586
12	216	-0.587785	-19260	B4C4	C4B4	-0.809017	-26509	9873	7398
13	234	-0.809017	-26509	9873	7398	-0.587785	-19260	B4C4	C4B4
14	252	-0.951057	-31163	8645	4586	-0.309017	-10126	D872	72D8
15	270	-1.000000	-32767	8001	0180	0.000000	0	0000	0000
16	288	-0.951057	-31163	8645	4586	0.309017	10126	278E	8E27
17	306	-0.809017	-26509	9873	7398	0.587785	19260	4B3C	3C4B
18	324	-0.587785	-19260	B4C4	C4B4	0.809017	26509	678D	8D67
19	342	-0.309017	-10126	D872	72D8	0.951057	31163	79BB	BB79

Figure 4-15: I and Q values calculation and conversion

- Use an ASCII editor which is able to handle binary data. Create and add the following mandatory tags before this binary data set can be further processed:

- CLOCK
- LEVEL OFFS

An example of the SICO.wv file contents could be:

```
{TYPE: SMU-WV, 0}{CLOCK: 10e6}{LEVEL OFFS: 3.010300,0.000000}
0000FF7F8E27BB79 ... 72D8BB79
```

To simplify the example, the checksum is set to 0, i.e. the instrument does not evaluate a checksum.

Tip: The tags TYPE, CLOCK, LEVEL OFFS and WAVEFORM are mandatory for each waveform. All other tags are optional and can be inserted after the TYPE tag in arbitrary order.

- Pack the binary data into a WAVEFORM tag with the described structure.

```
{WAVEFORM-Length: #I0Q0I1Q1I2Q2 ... InQn}
```

- Calculate the Length
Length = Number of I/Q pairs * 4 + 1 = 20*4 + 1 = 81 bytes
- Place the string {WAVEFORM-81: # at the beginning of the data set
- Place the symbol } at the end of the data set

The contents of the waveform file SICO.wv for 20 I/Q pairs is now ready for operation and reads:

```
{TYPE: SMU-WV, 0}
{CLOCK: 10e6}
{LEVEL OFFS: 3.010300,0.000000}
{WAVEFORM-81: #I0Q0I1Q1...InQn}
```

Note: There is no readable representation for binary values in this document. This is why we use the sequence I0Q0I1Q1...InQn to characterize the binary code in the present example.

The following figure shows this waveform in a data editor.

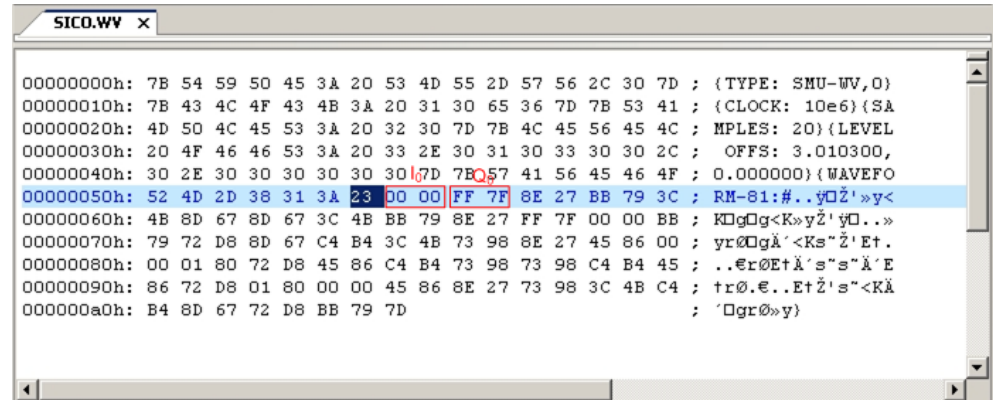

Example: C-program for creating a waveform file

C-program SICO.cpp for creating the file SICO.txt containing 20 sine and cosine pairs, converting them into binary data and creating the waveform file SICO.wv.

```
// SICO.cpp
// Defines the entry point for the console application

#include "stdafx.h"
#include <stdlib.h>
#include <stdio.h>
#include <math.h>

int _tmain(int argc, _TCHAR* argv[])
{
    const unsigned int samples = 20;
    const float pi = 3.141592654f;
    int i;

    // SICO.txt
    // Creating the file SICO.txt containing 20 sine and cosine pairs
    float grad, rad;
    FILE *fp;
    fp = fopen("SICO.txt", "w");
    if (fp == 0)
        return;
    for (i=0; i<samples; i++)
    {
        grad = (360.0f / (float)samples) * (float)i;
        rad = grad * (pi / 180.0f);
        fprintf(fp, "%f %f\n", sin(rad), cos(rad));
    }
    fclose(fp);
}
```

```

// SICO.wv
// Generating a binary data set from the I/Q pairs in the file SICO.txt
// and storing the result to file SICO.wv
FILE *fp_sour, *fp_dest;
float i_float, q_float;
unsigned short i_usint, q_usint;
fp_sour = fopen("SICO.TXT", "rt");
if (fp_sour == 0)
    return -1;
fp_dest = fopen("SICO.WV", "wb");
if (fp_dest == 0)
{
    fclose(fp_sour);
    return -1;
}
// Write required tags to waveform file
fprintf(fp_dest, "{TYPE: SMU-WV,0}");
fprintf(fp_dest, "{CLOCK: 10e6}");
fprintf(fp_dest, "{SAMPLES: %d}", samples);
// RMS, Peak
fprintf(fp_dest, "{LEVEL OFFS: %f,%f}", -1.0f * 20.0f * log10(1.0f/sqrt(2.0f)), 0.0f);
fprintf(fp_dest, "{WAVEFORM-%d:#", (samples * 4) + 1);
for (i=0; i<samples; i++)
{
    // Read I/Q pair from ASCII file
    if (fscanf(fp_sour, "%f %f", &i_float, &q_float) == EOF)
        break;
    // Convert I/Q pair to unsigned short
    i_usint = (unsigned short)floor((i_float * 32767.0) + 0.5);
    q_usint = (unsigned short)floor((q_float * 32767.0) + 0.5);
    // Write converted I/Q pair to waveform file
    fwrite(&i_usint, 2, 1, fp_dest);
    fwrite(&q_usint, 2, 1, fp_dest);
}
fprintf(fp_dest, "}");
fclose(fp_dest);
fclose(fp_sour);
return 0;
}

```

4.6.4.5 How to define periodically repeating traces

If a marker trace is required that marks for example each frame start, it is sufficient to define the trace ones and repeat it over the length of a waveform. This is useful if you describe a long waveform and a periodical marker is required.

The following examples use marker traces; control lists are processed in the same way.

To define periodical marker trace

The waveform in the example on [Figure 4-16](#) consists of 3 frames, each frame is 100-samples long. The waveform is processed continuously ("Trigger Mode > Auto").

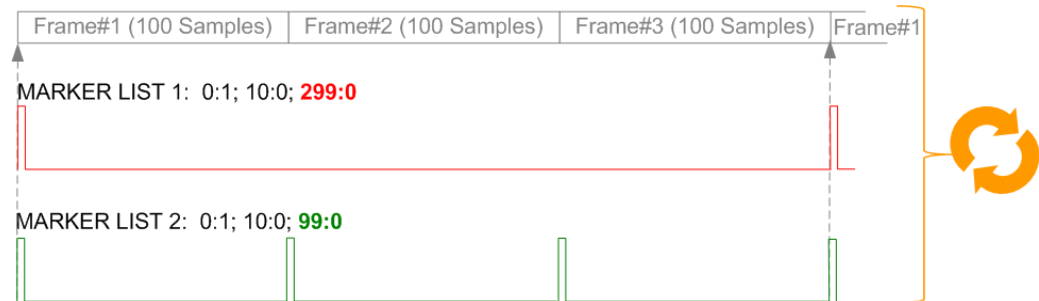

Figure 4-16: Example: Defining marker traces (CONTROL LENGTH tag is not used)

To define a restart marker and a frame start marker, use the following tags:

1. The waveform is 300 samples long, i.e. set `{SAMPLES: 300}`.
2. Set two `[TRACE] LIST` tags:
 - For Marker 1 that acts as a restart marker:
`{MARKER LIST 1: 0:1; 10:0; 299:0}`
 - For Marker 2 that marks each frame start:
`{MARKER LIST 2: 0:1; 10:0; 99:0}`
3. Do not use the `CONTROL LENGTH` tag.

The length of the repeated patterns is determined by the last sample number in the `[TRACE] LIST`, that is the last `{Pos:State}`.

Example: How the CONTROL LENGTH tag influences the processing of the traces

For the example on [Figure 4-16](#), use the same marker traces and set the CONTROL LENGTH tag, e.g. {CONTROL LENGTH: 150}.

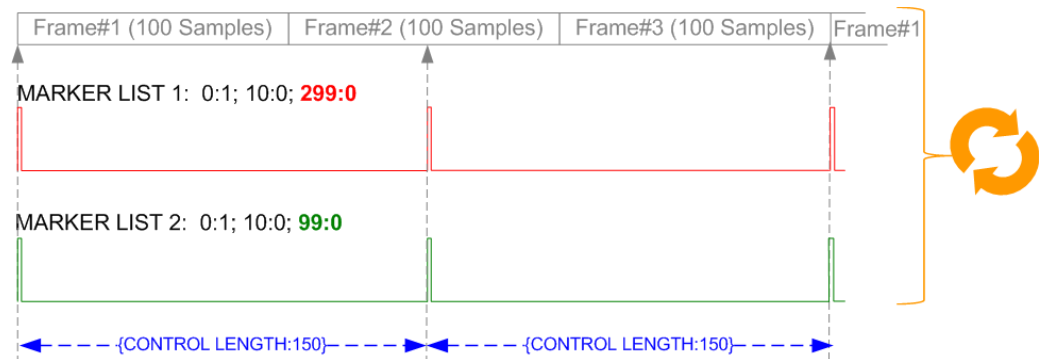

Figure 4-17: Example: Processing of control signals if the CONTROL LENGTH tag is used

The length of **all** control signals is determined by the CONTROL LENGTH. Observe how the marker traces are processed. In this example, both marker traces are repeated each 150 samples.

4.6.4.6 How to create a control list using tag file format

The R&S SMCV100B provides the following ways to create a file containing control signals:

- to use the dedicated "Control Data Editor" and create a file in ASCII format and with extension *.dm_iqc, see ["To create a control list in ASCII format manually"](#) on page 124
- To use the tag-oriented format and create a data list file, see ["To create a data list file using tag file format"](#) on page 166.
- To use SCPI commands and create a file in binary format, see ["To create a data list in binary format"](#) on page 167.

To create a control list using tag file format

To create an ASCII control list file directly, use the provided tag commands.

1. Use a hex data editor and create the **mandatory** tags:
 - TYPE
 - [TRACE] LIST

The [TRACE] LIST tag defines the individual markers or control traces in a combined {Pos:State} way within the control list period (CONTROL LENGTH).

2. Use a hex data editor and create the **recommended** tag CONTROL LENGTH.
This tag defines the *periodicity* of the total control list
3. Add the required optional tags.

They can be inserted after the `TYPE` tag in arbitrary order.

An example of the control list file contents could be:

```
{TYPE:SMU-CL}{COPYRIGHT:Rohde&Schwarz}
{DATE:2012-06-11;15:00:09}{HOP LIST:0:0;498:1;506:0}
{CW MODE LIST:0:0;380:1}{LEVATT LIST 3:0:0;464:1}
{BURST LIST:0:0;122:1;270:0;582:1;924:0}
{MARKER LIST 4:0:0;706:1;764:0}
{MARKER LIST 3:0:0;530:1;633:0}
{MARKER LIST 2:0:0;350:1;457:0}
{MARKER LIST 1:0:0;108:1;160:0}
{CONTROL LENGTH:1000}
```

The [Figure 4-10](#) shows the representation of the created control list in the "Control Data Editor".

Compare the displayed ramp values of "Marker 1" and the "Total List Length" with the values in the corresponding tags.

Note: In the provided example, the tags have been separated by line breaks for better reading.

See also [Example "How to assign and activate control signals from a control list"](#) on page 166.

To create a control list in binary format

Generation of a control list in binary format is not necessary but possible.

- ▶ Use the commands `BB:DM:CLIST:...` to generate a control list in binary format (see ["Handling list files"](#) on page 682 and the example in `[:SOURce<hw>] :BB:DM:CLIST:DATA` on page 685).

See also [Example "How to assign and activate control signals from a control list"](#) on page 166.

Example: How to assign and activate control signals from a control list

Note: Irrespectively on the way they are created, generated control lists are not automatically used.

We assume, that a control list `clist.dm_iqc` containing information on marker 2, burst gate and level attenuation control signals is created and saved in the directory `/var/user/temp/`.

The following example shows how to enable the R&S SMCV100B to:

- Use the control list for a particular marker output, e.g. the "Custom Digital Modulation > Marker 2".
- Use the Burst Gate and Level Attenuation control signals as defined in a control list.

```
:MMEM:CDIRectory "/var/user/temp"
:SOURce1:BB:DM:CLISt:CATalog?
// Response: clist
:SOURce1:BB:DM:CLISt:SElect "clist"
:SOURce1:BB:DM:TRIGger:OUTPut2:MODE CLISt

:SOURce1:BB:DM:PRAMp:SOURce INTernal
```

4.6.4.7 How to create a data list using tag file format

The R&S SMCV100B provides the following ways to create a data list file:

- To use the dedicated "Data List Editor" and create a file with extension `*.dm_iqd`, see ["To create data lists manually"](#) on page 126.
- To use the tag-oriented format and create a data list file, see ["To create a data list file using tag file format"](#) on page 166.
- To use SCPI commands and create a file in binary format, see ["To create a data list in binary format"](#) on page 167.

To create a data list file using tag file format

- ▶ Use a hex data editor and create the mandatory tags: `{TYPE}`, `{DATA BITLENGTH}` and `{DATA LIST}`
Consider the tag syntax and rules.

The following is an example of the data list file content. The tags are separated by line breaks for better reading. The text in brackets is short explanation.

For details, see the tag description:

- `TYPE`
- `{DATA BITLENGTH}`
- `{DATA LIST-Length}`

```
{TYPE:SMU-DL} {COPYRIGHT:Rohde&Schwarz}
{DATE:201-06-11;15:00:09}
{DATA BITLENGTH: 8}
{DATA LIST-2: #d0d1...d7}
```

(1 byte containing 8 data bits `d0` to `d7` in binary format, where `d0` is the MSB)

See also:

- [Figure 4-11](#) for representation of the created data list in the "Data List Editor".
- [Example "How to assign and activate a data list"](#) on page 167

To create a data list in binary format

- ▶ Use the commands `BB:DM:DLIST:...`, see ["Handling list files"](#) on page 682.

```
:MME:CDIRectory "/var/user"
// Create a new data list file.
:SOURce1:BB:DM:DLIST:SElect "dl_new"
// Append data to the data list and query the content.
:FORMat ASCii
:SOURce1:BB:DM:DLIST:DATA:APPend 0,1,1,1,0,1,0,1
:SOURce1:BB:DM:DLIST:DATA?
// Response: 0,1,1,1,0,1,0,1
```

See also [Example "How to assign and activate a data list"](#) on page 167.

Example: How to assign and activate a data list

Note: Irrespectively on the way they are created, generated data lists are not automatically used.

We assume, that a data list `dl.dm_iqd` is created and saved in the directory `/var/user/`.

The following example shows how to enable the R&S SMCV100B to use this data list as data source for the custom digital modulation.

```
:MME:CDIRectory "/var/user"
:SOURce1:BB:DM:DLIST:CATalog?
// Response: dl
:SOURce1:BB:DM:DLIST:SElect "dl"
```

4.6.4.8 Editing waveform files, data and control lists

You can edit the internally and externally crated waveform files, data and control lists. The waveform, data and control lists files contain binary and ASCII data.

Consider the following rules while editing files with binary data.

Rules for editing binary data (waveforms, data and control lists)

- **Use hex data editor**
Always use a hex data editor to edit files containing binary data. Editing of binary data file with a text editor, even if you only change the ASCII part of the file, corrupts the file.
- **Adapt the length information in the {EMPTYTAG}**
If you change the content of a waveform file, change also the {EMPTYTAG-Length} value.
For example, if you add a tag or add bytes to an existing tag, reduce the length information by the number of newly introduced bytes.

4.6.5 How to work with waveform libraries

The R&S SMCV100B offers waveform libraries containing waveform files (*.wv) with a wide range of ready-made signals for testing systems with different transmission parameters.

Key features

- Support of numerous broadcast transmission standards
- Efficient use with dedicated streams and waveforms

For an overview of ARB options, see [Chapter 4.6.1, "Required options"](#), on page 137.

Required options

The equipment layout for processing files of waveform libraries includes:

- R&S SMCV100B base unit, including arbitrary waveform generator (64 MSample ARB memory, 60 MHz RF bandwidth)
- Waveform library option (R&S SMCVB-KVxx)

For stream library key features and required options, see chapter "TS Player" in the digital broadcast standard user manual.

To access R&S SMCV100B libraries

R&S SMCV100B stream and waveform libraries are available for download for registered users on the "Vector Signal Generator Customer Web" at the global Rohde & Schwarz information system (GLORIS).

1. For access, register at <https://gloris.rohde-schwarz.com>:
In section "How to register", follow the instructions provided in the introduction video "How to register for GLORIS".
2. For access to the "Vector Signal Generator Customer Web", register the R&S SMCV100B:
 - a) In the menu "Support&Services", select "My Products" > "Register my product".
 - b) To register the R&S SMCV100B, click "Add Equipment".
 - c) In the section "Information about your product", specify order number ("Material no.") and serial number ("Serial No.") of the R&S SMCV100B.

Home News Center [Support&Services](#)

My Products > Vector Signal Generator Customer Web

Downloads

My Products

Vector Signal Generator Customer Web

Lifecycle Support Status Information

Service Portfolio

Register my product

Add Equipment

Information about your product

Identify product by: Device ID Material & Serial No.

*Material no.:

*Serial No.:

Add equipment < Back to list

3. After product registration, log in at GLORIS.
4. In the menu bar, select "Support&Services > My Products > Vector Signal Generator Customer Web".

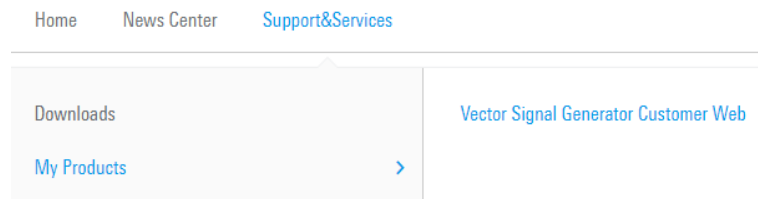

The "R&S SMCV100B Customer Web" page opens.

5. In the selection field "Product Selection for VSG", select "R&S®SMCV100B".

A webpage opens and displays search results for products related to the R&S SMCV100B.

Product Related Documents



To download a library file

This procedure describes how to download library files. It provides a step-by-step description for download of a stream library file. The download of waveform library files is analogous.

1. Access the "Product Related Documents" web page as described in "[To access R&S SMCV100B libraries](#)" on page 168.
2. In the search navigation bar, select "Firm-/Software" > "Waveform & Streams".

The search lists all information related to stream and waveform libraries of the R&S SMCV100B:

- R&S SMCVB-KSxx results relate to stream libraries.
- R&S SMCVB-KVxx results relate to waveform libraries.

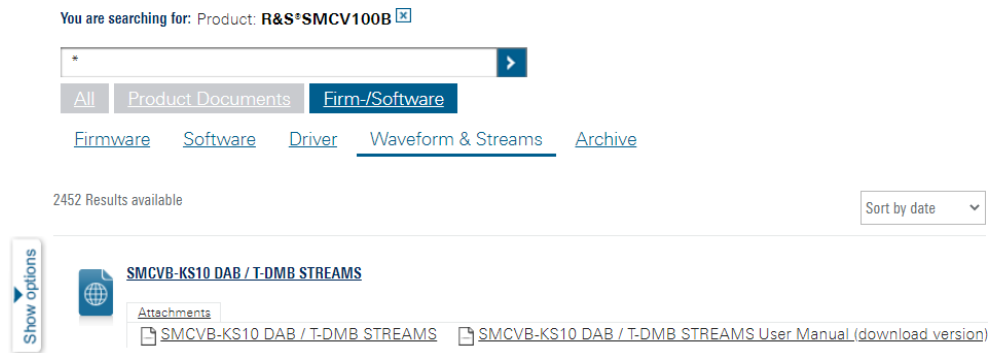

3. Optionally, deactivate the filtering to display all waveform and stream library content.
 - a) On the left menu, select "Show options".
 - b) Click "Filtering on. Reset all filters."

Filtering on. Reset all filters.

4. Optionally, to filter for stream library content enter *KS in the search input field.

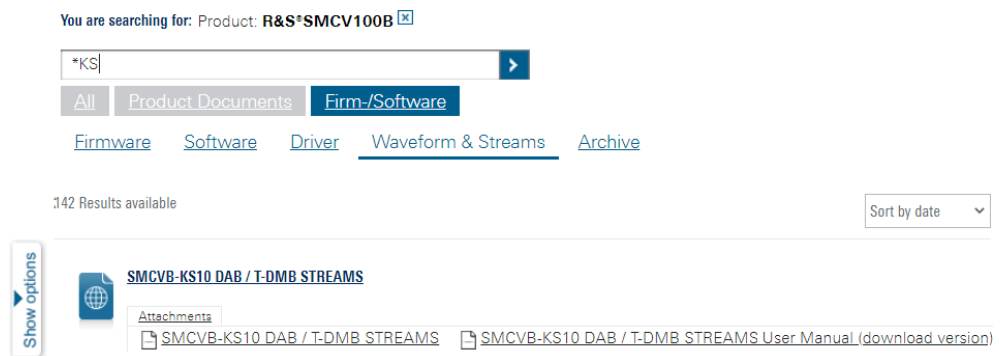

5. In the search result list, navigate to the required library.
6. To download required library files, click the download link in the "Attachments" section of library product page.
For example, for DAB/T-DMB streams, click the download link "R&S SMCVB-KS10 DAB / T-DMB STREAMS".

A download dialog opens to select and save files of the stream library.

To save a library file

You can save the library file to several storage locations:

- External storage device (HDD, memory stick): Use external USB storage device to save large files or complete libraries. Connect the storage device to one of the USB 3.0 connectors on the rear panel of the R&S SMCV100B. If detected correctly, you can access the files on the R&S SMCV100B in the `/usb/` directory in file-select dialogs.
The R&S SMCV100B supports the following storage formats: ext2/ext3/ext4, FAT16/FAT32, NTFS (read-only), ISO9660, UDF

- Internal memory (SSD): Use the internal memory to save single files to the user directory `/var/user/` of the R&S SMCV100B, for example, using FTP via a LAN connection.

For more information on the content of the libraries, see the user manual of the library, e.g., for DAB/T-DMB streams, see "R&S SMCVB-KS10 DAB / T-DMB Streams" user manual.

To load and play a waveform library file

1. Load the waveform file from its storage location:
 - External storage device (HDD, memory stick): Load the file from the `/usb/` directory.
 - Internal memory (SSD): Load the file from the user directory `/var/user/`

Note: Library files are encrypted files. Loading the library file at the R&S SMCV100B requires installation of the corresponding library option. See "Required options" on page 168.
2. To load the file at the R&S SMCV100B, select the file in the dialog "Baseband" > "ARB" > "Load Waveform".
3. To select the file, navigate to the storage location (1).
4. Select "ARB" > "State" > "On".
The R&S SMCV100B processes the waveform file.
5. In the block diagram, select "RF" > "On"
The waveform file is modulated onto the RF carrier and output at the RF 50 Ω connector.

See also [Chapter 4.6.4, "How to create, generate and play waveform files"](#), on page 152. For streaming library files, select the file in the "TS Player" application of the corresponding digital broadcast standard baseband configuration. See also chapter "Configuring the input signal" in the digital broadcast standard user manual.

4.6.6 How to stream waveforms from an external storage device

This section provides step-by-step instructions on how to set up the R&S SMCV100B for streaming large waveform files from an externally connected hard disc drive (HDD).

Required options

See [Chapter 4.6.1, "Required options"](#), on page 137.

The following procedures help you to set up the R&S SMCV100B for ARB waveform streaming.

To set up and connect the external waveform source

1. Provide an HDD as waveform streaming source.

The R&S SMCV100B supports the following storage formats: ext2/ext3/ext4, FAT16/FAT32, NTFS (read-only), ISO9660, UDF

2. Save the waveform file on the HDD.
3. Connect the HDD to one of the USB 3.0 connectors on the rear panel of the instrument. See [Chapter 3.1.9, "Connecting USB devices"](#), on page 29.

See also [Chapter 11.9.4, "Using a USB storage device for file transfer"](#), on page 439.

To activate waveform streaming

1. Select "Baseband > ARB".
2. In the "ARB" tab, load the waveform file:
 - a) Select "Load Waveform".
 - b) In the "Load Waveform" dialog, navigate to the directory of the HDD:
/USB/HDD
 - c) On the HDD, select the waveform file, e.g. "Test.wv":
/USB/HDD/SMCVB_Test/Test.wv

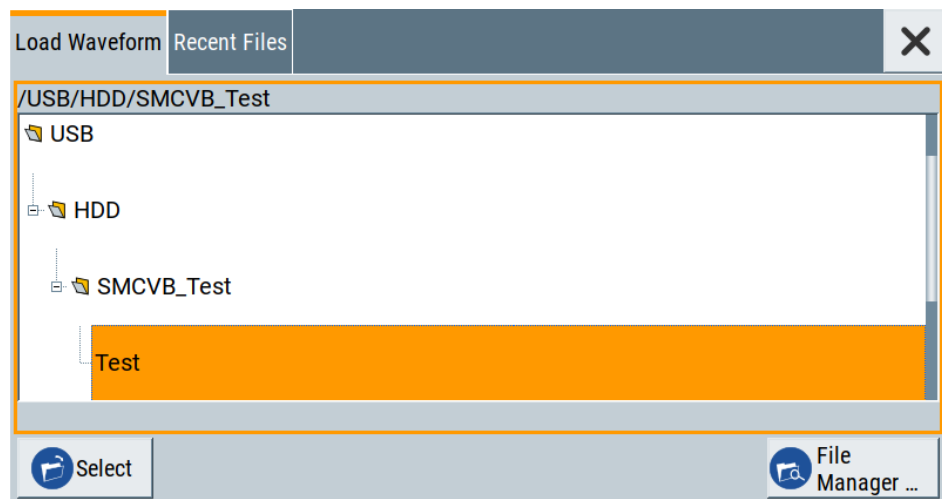

3. Select "HDD Streaming > On".
4. Optionally, configure trigger and marker settings.
 - a) In the "Trigger In" tab, select "Mode > Auto".
 - b) In the "Marker" tab, select "Mode > Restart".
5. Select "ARB > State > On".

The R&S SMCV100B processes the waveform stream signal.

To output the waveform stream signal

1. Specify RF frequency and RF level.

2. In the block diagram, select "RF > On".

The waveform stream signal is modulated onto the RF carrier and output at the RF 50 Ω connector.

4.6.7 Tags for waveforms, data and control lists

The R&S SMCV100B uses a simple tag-oriented format for externally or internally generated waveforms, data and control lists. Files with this format can be transmitted from an external computer to the instrument and vice versa. These files are transmitted as a binary data block, using SCPI command `[:SOURce<hw>] :BB:ARBitrary:WAVEform:DATA`, `[:SOURce<hw>] :BB:DM:DLISt:DATA`, and `[:SOURce<hw>] :BB:DM:CLISt:DATA`.

Tag general format

Tags are self-contained information units, enclosed in braces `{ }`. Their general format is `{Name: Data}` or `{Name-Length: Data}`. The colon separates the name part and the data part. The colon can be followed by a space for the sake of legibility.

- The **Name** identifies the tag. It is always expressed in capital letters.
- The **Data** is tag-specific, and usually it is in ASCII plain text.
- The **Length** specifies the number of bytes in a `WAVEFORM` tag, `DATA LIST` tag, or `EMPTYTAG`.
Length is an ASCII integer value, defining the number of bytes from the colon `:` to the end brace `}`

Rules

Each waveform file must begin with the `TYPE` tag. The sequence of the remaining tags is arbitrary. For each tag, an indication shows whether it must be included in the file concerned (mandatory) or may be included (optional).

Unknown tags are not analyzed by the R&S SMCV100B; they are left unchanged and saved without an error message for a possible further read back.

R&S SMU waveforms can also be loaded on the instrument, where they are converted internally into an R&S SMCV100B waveform.



In all examples of file contents listed in this section, the tags have been separated by line breaks for better reading.

Tag description

This section describes the **mandatory TYPE tag** followed by description of all other tags, grouped per file type and listed in an alphabetical order. Some tags are valid for all three file types. If a tag is valid only for a single file type, e.g. only for a waveform, this fact is indicated in the description.

Related step-by-step descriptions

See:

- Chapter 4.6.4.5, "How to define periodically repeating traces", on page 162
- Chapter 4.6.4.4, "How to manually create a waveform using tag file format", on page 158
- Chapter 4.6.4.6, "How to create a control list using tag file format", on page 164
- Chapter 4.6.4.7, "How to create a data list using tag file format", on page 166
- Chapter 4.6.4.8, "Editing waveform files, data and control lists", on page 167

Tags description

- [Common tags](#)..... 174
- [Tags for single and multi-segment waveforms](#)..... 176
- [Tags for data lists](#)..... 187
- [Tags for control lists](#)..... 188

4.6.7.1 Common tags

The following tags are common to all file types. For description of the dedicated tags, see

{TYPE: magic, xxxxxxxx}

(mandatory, must be the first tag in the file)

Identifies the file as a valid R&S SMCV100B file. It must be present and must be the first in the waveform. If a file of the same name exists on the target medium, it is overwritten.

Setting parameters:

magic	Designates the file type and has the following values: SMU-WV A valid R&S SMCV100B waveform. SMU-MWV A valid R&S SMCV100B multi-segment waveform. SMU-DL A valid R&S SMCV100B data list. SMU-CL A valid R&S SMCV100B control list.
xxxxxxx	Is an ASCII-coded checksum of the data part of the <code>WAVEFORM</code> tag in the file. This value is always 0 for data lists and control lists. The checksum for waveforms is used for detecting transmission errors. If the <code>TYPE</code> tag contains 0 or a non-numeric value for the checksum, it is ignored. It is calculated in accordance with the algorithm given below, where:

`start` is a pointer to the first byte after the # character in the WAVEFORM tag

`length` is the number of bytes between `start` and the closing curly bracket (excluding the latter; `length` must be divisible by 4 without a remainder.

```
UINT32 checksum(void *start, UINT32 length)
{
    UINT32 i, result = 0xA50F74FF;
    for(i=0; i < length/4; i++)
        result = result ^ ((UINT32 *)start)[i];
    return(result);
}
```

The checksum is currently not verified when waveforms are loaded.

Example:

```
{TYPE: SMU-WV,106656}
BB:ARB:WAV:TAG? 'TYPE'
Queries the content of the TYPE tag.
Response: 'SMU-WV,106656'
This is a valid waveform.
```

{COMMENT: string}

The tag contains a plain text ASCII string of arbitrary length. The string is not analyzed in the R&S SMCV100B. It is used to describe the file. The string is allowed to contain all printable ASCII characters except the closing curly bracket.

Example:

```
{COMMENT: File with data for 3GPP enhanced
channels}
BB:ARB:WAV:TAG? 'COMMENT'
Queries the content of the COMMENT tag of the selected wave-
form file.
Response: 'File with data for 3GPP enhanced
channels'
The comment on the waveform reads "File with data for 3GPP
enhanced channels".
```

Usage:

Setting only

{COPYRIGHT: string}

The tag contains an ASCII string of arbitrary length. The string is not analyzed in the R&S SMCV100B. It is used to save copyright information about the file content.

Example:

```
{COPYRIGHT: Rohde&Schwarz}
BB:ARB:WAV:TAG? 'COPYRIGHT'
Queries the content of the COPYRIGHT tag of the selected wave-
form file.
Response: 'Rohde&Schwarz'
Copyright resides with Rohde & Schwarz.
```

Usage: Setting only

{DATE: yyyy-mm-dd;hh:mm:ss}

(optional)

The tag contains the date and time at which the file was created. The year must be expressed as four digits. The instrument does not analyze this tag.

Example: {DATE: 2009-04-02;14:32:12}
 BB:ARB:WAV:TAG? 'DATE'
 Queries the content of the DATE tag of the selected waveform file.
 Response: '2009-04-02;14:32:12'
 The waveform was created on April 2, 2009 at 14 hrs 32 min

Usage: Setting only

4.6.7.2 Tags for single and multi-segment waveforms

The following tags apply to waveforms and multi-segment waveforms, additionally to the tags listed in [Chapter 4.6.7.1, "Common tags"](#), on page 174.

{CLOCK: frequency}.....	177
{CONTROL LENGTH: ControlLength}.....	177
{EMPTYTAG-Length: #EmptySequence}.....	178
{LEVEL OFFS: RMSOffset_dB,PeakOffset_dB}.....	179
{MARKER MODE [#]: GENERATOR}.....	180
{SAMPLES: Samples}.....	180
{BURST LIST [#]: Pos0:State0; Pos1:State1; ...PosN-1:StateN-1}.....	181
{CW MODE LIST [#]: Pos0:State0; Pos1:State1; ...PosN-1:StateN-1}.....	181
{HOP LIST [#]: Pos0:State0; Pos1:State1; ...PosN-1:StateN-1}.....	181
{LEVATT LIST [#]: Pos0:State0; Pos1:State1; ...PosN-1:StateN-1}.....	181
{MAP LIST [#]: Pos0:State0; Pos1:State1; ...PosN-1:StateN-1}.....	181
{MARKER LIST [#]: Pos0:State0; Pos1:State1; ...PosN-1:StateN-1}.....	181
{[TRACE] LIST [#]: Pos0:State0; Pos1:State1; ...PosN-1:StateN-1}.....	181
{WAVEFORM-Length: #I0Q0I1Q1...IxQx...IN-1QN-1...}.....	182
{MWV_SEGMENT_COUNT: NumOfSeg}.....	183
{MWV_SEGMENT_DURATION: SegDur0, SegDur1, ..., SegDurN-1}.....	183
{MWV_SEGMENT_LENGTH: SamplesSeg0, SamplesSeg1, ..., SamplesSegN-1}.....	183
{MWV_SEGMENT_START: SampleStartOffsetSeg0, SampleStartOffsetSeg1, ..., SampleStartOffsetSegN-1}.....	184
{MWV_SEGMENT_CLOCK_MODE: Mode}.....	184
{MWV_SEGMENT_CLOCK: ClockSeg0, ClockSeg1, ..., ClockSegN-1}.....	184
{MWV_SEGMENT_LEVEL_MODE: Mode}.....	185
{MWV_SEGMENT_LEVEL_OFFS: RMSOffs_dBSg0,PeakOffs_dBSg0, ..., RMSOffs_dBSgN-1, PeakOffs_dBSgN-1}.....	185
{MWV_SEGMENT_SETTINGS_FILE: SegSettingFilePath}.....	186

{MWV_SEGMENT_FILES: "FileNameSeg0.wv", "FileNameSeg1.wv", ..., "FileNameSegN-1.wv"}.....	186
{MWV_SEGMENTx_COMMENT: text}.....	186
{CONTROL LIST WIDTH4–Length: #m0m1...mx...mM-1}.....	186

{CLOCK: frequency}

(mandatory for waveforms)

The tag specifies the clock frequency at which the waveform has to be output, in Hz (on multi-segment waveforms this tag contains the maximal clock of all segments).

A query of `ARB:CLOCK?` after loading the waveform returns the value set using the `CLOCK` tag. This value can later be altered with the command `ARB:CLOCK?`.

Example:

```
{CLOCK: 54000000}
BB:ARB:WAV:TAG? 'CLOCK'
```

Queries the content of the `CLOCK` tag.
Response: 54000000
The clock frequency is set to 54 MHz.

Usage: Setting only

{CONTROL LENGTH: ControlLength}

(optional / recommended for marker and control lists)

The tag specifies the length of *all* control or marker list in ASCII format.

The control length influences the way the marker and control lists are processed, in particular the way traces are repeated; see [Figure 4-18](#).

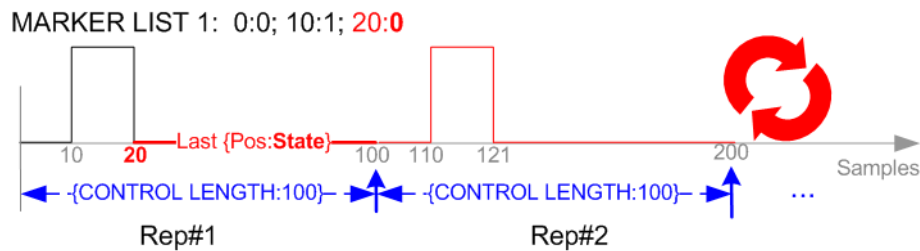

Figure 4-18: Example: Processing of MARKER TRACE if CONTROL LENGHT is specified

If the `CONTROL LENGTH` tag is not used, the marker and control list length are determined by the last position, that is the last `{Pos:State}` couple, defined in the particular `[TRACE] LIST` tag; see [Figure 4-19](#).

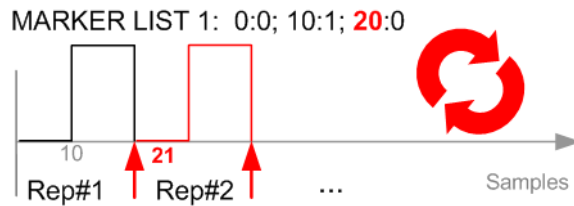

Figure 4-19: Example: Processing of MARKER TRACE if CONTROL LENGTH is not used

To maintain marker signals and waveform data synchronized, set the `CONTROL LENGTH` to be equal to the number of samples specified with the tag `SAMPLES`.

See also [Chapter 4.6.4.5, "How to define periodically repeating traces"](#), on page 162.

Example:

```
{CONTROL LENGTH: 500}
SOURCE:BB:ARBITRARY:CLIST:TAG? 'CONTROL LENGTH'
Queries the length of the control list.
Response: 500
```

Manual operation: See ["Total List Length"](#) on page 122

{EMPTYTAG-Length: #EmptySequence}

(mandatory in automatically generated one and multi-segment waveforms)

This tag is empty, i.e. contains no data, and is used as placeholder.

Setting parameters:

Length An ASCII integer value that specifies the number of bytes in the `EMPTYTAG`, i.e. defines the number of bytes from the colon `:` to the end brace `}`

Note: If you change the content of a waveform file, change also the `{EMPTYTAG-Length}` value. For example, if you add a tag or add bytes to a tag, reduce the length by the number of newly introduced bytes.

EmptySequence An empty sequence containing blanks only. The number of used blanks is calculated as the difference between the hex addresses of the `{WAVEFORM}` tag and the hash sign `#` in the `{EMPTYTAG}`.

The `{WAVEFORM}` tag always starts at hex address `#4000`.

Example:

```
{TYPE:SMU-WV, 837236424}
{COPYRIGHT:2003 Rohde&Schwarz SMU}
{DATE:2012-07-11;14:38:01}
{SAMPLES:80000}
{CLOCK:86666666.666666666}
{VECTOR MAX:1.000000038569158}
{LEVEL OFFS:3.333553817875577e-07,0}
{MARKER LIST 1:0:1;1:0;1249:0}
{MARKER LIST 2:0:1;1:0;1249:0}
{MARKER LIST 3:0:1;1:0;1249:0}
{MARKER LIST 4:0:1;1:0;1249:0}
{EMPTYTAG-15947:# ...}
{WAVEFORM-320017:#IQIQIQ...}
```

The example waveform file contains 436 (0x1b4) bytes before the # sign in the EMPTYTAG; the hex address of the # sign is 0x1b5. The {WAVEFORM} starts at 0x4000. The EMPTYTAG contains 15946 blanks and has a length of (15946+1) bytes.

Usage: Setting only

{LEVEL OFFS: RMSOffset_dB,PeakOffset_dB}

(recommended for waveforms)

The tag determines the level of the ARB signal in the waveform file. The offset levels define the offset of RMS and peak value relative to the 16-bit full scale modulation (-32767 to + 32767) = 0 dB.

Setting parameters:

RMSOffset_dB	<p>Defines the RMS level offset of the signal relative to full scale ARB signal in the WAVEFORM tag. The offset is defined in ASCII float format. The value is always positive.</p> <p>A 3 dB value indicates that the RMS level of the signal is 3 dBs below the full scale.</p> <p>full scale = max. amplitude of vector of I/Q samples = $S_{IQ} _{max} = \sqrt{I^2+Q^2}_{max} = 0$ dB</p>
PeakOffset_dB	<p>Defines the peak level offset of the signal relative to full scale for the ARB signal in the WAVEFORM tag. The offset is defined in ASCII float format.</p> <p>The value usually equals 0 dB as usually the I/Q samples (signed 16-bit integer values) are modulated to full scale: Full scale = 0 dB = max. amplitude of vector of I/Q samples = $S_{IQ} _{max} = \sqrt{I^2+Q^2}_{max} = (2^{15})-1 = 32767$.</p> <p>A positive PeakOffset_dB value indicates that a headroom to full scale is provided when generating the waveform. A negative PeakOffset_dB value indicates that overrange is likely for some samples, i.e. clipping might occur.</p> <p>The crest factor can be calculated from the two values as follows:</p>

$$\text{Crest Factor} = |\text{PeakOffset_dB} - \text{RMSOffset_dB}|$$
Example:

```
{LEVEL OFFS: 3.45,2}
```

```
BB:ARB:WAV:TAG? 'LEVEL OFFS'
```

Queries the content of the LEVEL OFFS tag of the selected waveform file.

```
Response: 3.45,2
```

The level of the waveform is below full scale, clipping does not occur.

Usage:

Setting only

{MARKER MODE [#]: GENERATOR}**(Optional for waveforms)**

The tag defines how the marker signals are generated. The tag is included in the waveforms, created by the R&S WinIQSIM2 software.

- Tag not used

The marker signals defined with the tag **MARKER LIST** are converted into a separate binary control list. When the waveform is loaded into the ARB, this control list is also loaded automatically and processed synchronous with the waveform.

Note: This method reduces the maximum waveform length (given as number of samples). The number of available samples is limited, because each marker requires 4 bits per I/Q sample, additionally to the 32 bits required to describe an I/Q sample.

- Tag is used

The marker signals defined with the tag **MARKER LIST** are processed internally; additional control list is not created. If the tag is used for **all 3 markers**, the whole ARB memory is available for the I/Q samples.

Note: If this tag is used, the maximum number of marker states defined with the tag **MARKER LIST** is 64, i.e. Pos₆₃:State₆₃

Setting parameters:

[#] 1 to 3

Sets the marker number.

Example:

```
{MARKER MODE 1: GENERATOR}
```

```
{MARKER MODE 2: GENERATOR}
```

```
{MARKER MODE 3: GENERATOR}
```

Usage:

Setting only

{SAMPLES: Samples}**(recommended for waveforms)**

The tag contains the number of I/Q samples in the waveform in ASCII format.

On multi-segment waveforms, this tag contains the total I/Q samples of all segments.

Example: {SAMPLES: 1000}
 BB:ARB:WAV:TAG? 'SAMPLES'
 Queries the content of the SAMPLES tag of the selected waveform file.
 Response: 1000
 The waveform contains 1000 I/Q samples.

Usage: Setting only

See also [Chapter 4.6.4.5, "How to define periodically repeating traces"](#), on page 162.

{BURST LIST [#]: Pos0:State0; Pos1:State1; ...PosN-1:StateN-1}
{CW MODE LIST [#]: Pos0:State0; Pos1:State1; ...PosN-1:StateN-1}
{HOP LIST [#]: Pos0:State0; Pos1:State1; ...PosN-1:StateN-1}
{LEVATT LIST [#]: Pos0:State0; Pos1:State1; ...PosN-1:StateN-1}
{MAP LIST [#]: Pos0:State0; Pos1:State1; ...PosN-1:StateN-1}
{MARKER LIST [#]: Pos0:State0; Pos1:State1; ...PosN-1:StateN-1}
{[TRACE] LIST [#]: Pos0:State0; Pos1:State1; ...PosN-1:StateN-1}
 (mandatory for control lists / optional for waveforms)

The tag contains the data for the marker and control signals in the control list or the marker signals of ARB waveforms.

Traces are processed different, depending on the selected [CONTROL LENGTH](#). See for example [Chapter 4.6.4.5, "How to define periodically repeating traces"](#), on page 162.

The processing of the marker traces ([MARKER LIST](#)) depends additionally on the presence of the tag [MARKER MODE](#).

Setting parameters:

[TRACE]	MARKER BURST LEVATT CW MODE HOP MAP Name of the marker or control signal. For ARB waveforms, it is only meaningful to define marker signals; in the ARB multi-segment waveforms these tags are ignored!
[#]	1 to 3 Sets the marker or control trace number; supported is only LEVATT LIST 1.
Pos	Specifies in ASCII format the position (i.e. sample number or data value), with effect from which the binary State of the marker or of the control signal changes. If the tag MARKER MODE is used, the maximum number of marker states is 64, i.e. Pos ₆₃ :State ₆₃ .
State	0 1 Specifies the binary state of the marker or of the control signal from Pos _N to Pos _{N+1} exclusive in ASCII format.

- Example:** `{MARKER LIST 1: 0:0;10:1;20:0;30:1}`
`BB:DM:CLIS:TAG? 'MARKER LIST 1'`
 Queries the content of the `MARKER LIST 1` tag of the selected control list file.
 Response: `'0:0;10:1;20:0;30:1'`
 The marker setting for samples 0 to 9 = 0 (low), for 10 to 19 = 1 (high) and for 20 to 29 = 0. From sample 30 onward the marker setting = 1.
- Example:** `{LEVATT LIST 1: 0:0;10:1;20:0;30:1}`
`BB:DM:CLIS:TAG? 'LEVATT LIST 1'`
 Queries the content of the `LEVATT LIST 1` tag of the selected control list file.
 Response: `'0:0;10:1;20:0;30:1'`
 Level attenuation applies to data values 10 to 19 (high) and from data value 30 onward.
- Usage:** Setting only
- Manual operation:** See "[Select Ramp to Edit](#)" on page 122

{WAVEFORM-Length: #I0Q0I1Q1...IxQx...IN-1QN-1...}

(mandatory for waveforms)

Setting parameters:

- Length** Specifies the number of bytes in a `WAVEFORM` tag and is calculated as follows:

$$\text{Length} = \text{Number of I/Q pairs} * 4 \text{ (2 bytes per I and 2 bytes per Q value)} + 1 \text{ byte (the length of the \#)}$$
- IxQx** `IxQx...` represents binary data (16-bit signed integer in 2's complement notation) containing the I and Q component alternately and starting with the I component. Each component consists of 2 bytes in Little endian format representation, i.e. least significant byte (LSB) first.
 The values of the 2 bytes in an I component and a Q component are in the range 0x0 to 0xFFFF (-32767 to +32767). This value is transferred to the D/A converter.
 This tag is also used to store multi-segment waveforms. The I/Q streams of the individual waveforms are directly concatenated to one collectively waveform I/Q stream.
 The number of segments and the start offset and length of the individual segments inside the total waveform I/Q stream is determined by the additional tags `MWV_SEGMENT_COUNT`, `MWV_SEGMENT_START`, and `MWV_SEGMENT_LENGTH`.
 Further `MWV_SEGMENT_...` tags are also available, for example for level and clock information.

- Example:** **One segment waveform**
 {WAVEFORM-401:#I₀,Q₀,I₁,Q₁,I₂,Q₂,...I₉₉,Q₉₉}
 100 I/Q pairs with 4 bytes each are transmitted - none multi-segment
- Example:** **Multi-segment waveform**
 {WAVEFORM-1201:
 #I_{0,Seg0},Q_{0,Seg0},I_{1,Seg0},Q_{1,Seg0},...I_{99,Seg0},Q_{99,Seg0},I_{0,Seg1},Q_{0,Seg1},I_{1,Seg1},
 Q_{1,Seg1},... I_{199,Seg1},Q_{199,Seg1}}
 2 segments: segment 0 with 100 I/Q pairs; segment 1 with 200 I/Q pairs. Each I/Q pair consists of 2*16 bit = 4 bytes
- Usage:** Setting only

{MWV_SEGMENT_COUNT: NumOfSeg}**(mandatory for multi-segment waveforms)**

The tag contains the number of segments in the multi-segment waveform in ASCII integer format.

- Example:** {MWV_SEGMENT_COUNT: 2}
 Multi-segment waveform with 2 segments

Usage: Setting only

{MWV_SEGMENT_DURATION: SegDur0, SegDur1, ..., SegDurN-1}**(optional for multi-segment waveforms)**

The tag gives the time duration (in seconds) per segment.

- Example:** {MWV_SEGMENT_DURATION: 1, 0.5}
 Multi-segment waveform with 2 segments, lasting 1 s and 0.5 s each.

Usage: Setting only

{MWV_SEGMENT_LENGTH: SamplesSeg0, SamplesSeg1, ..., SamplesSegN-1}**(mandatory for multi-segment waveforms)**

The tag contains a list of I/Q sample lengths for every segment in the multi-segment waveform in ASCII integer format.

- Example:** {MWV_SEGMENT_LENGTH: 100, 200}
 2 segments: 100 samples in segment 0 and 200 samples in segment 1.

Usage: Setting only

{MWV_SEGMENT_START:**SampleStartOffsetSeg0, SampleStartOffsetSeg1, ..., SampleStartOffsetSegN-1}****(mandatory for multi-segment waveforms)**

The tag contains a list of I/Q sample start offsets for every segment in the multi-segment waveform in ASCII integer format.

Example:`{MWV_SEGMENT_START: 0,100}`

2 segments with 100 samples in segment 0 and 200 samples in segment 1.

The start offset of first segment is 0 samples, start offset of next segment 1 is the sample length of segment 0 = 100 samples.

Usage:

Setting only

{MWV_SEGMENT_CLOCK_MODE: Mode}**(mandatory for multi-segment waveforms)**

The tag contains a string in ASCII format which supplies the clock rate mode, that was used for calculation of the multi-segment output waveform (see also "[Clock](#)" on page 203).

The tag `CLOCK` contains always the highest clock rate of all segments. The tag `MWV_SEGMENT_CLOCK` contains the clock rates of the individual segments.

Setting parameters:

Mode

UNCHANGED

The segments may have different clock rates; each segment is output with the clock rate defined in its waveform file.

HIGHEST

All segments are output at the highest available clock rate.

USER

All segments are output at the clock rate defined by the user.

Note: Only upsampling is allowed, no downsampling!

Example:`{MWV_SEGMENT_CLOCK_MODE: UNCHANGED}`**Usage:**

Setting only

{MWV_SEGMENT_CLOCK: ClockSeg0, ClockSeg1, ..., ClockSegN-1}**(mandatory for multi-segment waveforms)**

The tag contains a list of clock frequencies for every segment in the multi-segment waveform in ASCII floating point format.

Example: `{MWV_SEGMENT_CLOCK: 100e6,80e6}`
 2 segments: clock of segment 0 is 100 MHz, clock of segment 1 is 80 MHz.
Note: If the segments have different clock frequencies, there are some restrictions on signal output, i.e. seamless switching between segments is only possible, if all segments have the same clock frequency. Software resampling (upsampling) can be used to bring all segments to the same clock.

Usage: Setting only

{MWV_SEGMENT_LEVEL_MODE: Mode}

(optional for multi-segment waveforms)

The tag contains a string in ASCII format which supplies the clock rate mode, that was used for calculation of the multi-segment output waveform.

Setting parameters:

Mode **UNCHANGED**
 Concerning the level settings, the segments are output exactly as defined in the individual files.
 The value displayed with the parameter "Task bar > Level" applies only to the segment with the highest RMS value. The remaining segments are output at a lower level than the displayed value.
EQUALRMS
 Segments are output so that all segments have the same RMS value. The value displayed with the parameter "Task bar > Level" applies to all segments.

Example: `{MWV_SEGMENT_LEVEL_MODE: UNCHANGED}`

Usage: Setting only

{MWV_SEGMENT_LEVEL_OFFS:

RMSOffs_dBSg0,PeakOffs_dBSg0, ..., RMSOffs_dBSgN-1, PeakOffs_dBSgN-1}

(mandatory for multi-segment waveforms)

The tag contains a list of level pairs in ASCII floating point format, one pair for every segment in the multi-segment waveform. The first value of a level pair defines the rms offset and the second value the peak offset relative to the 16-bit full scale modulation $(-32767; + 32767) = 0$ dB. The meaning of one level value pair is the same as in the [LEVEL OFFS](#) tag for normal waveforms.

Example: `{MWV_SEGMENT_LEVEL_OFFS: 3.0,0.0,6.0,0.0}`
 2 segments: RMS level of segment 0 is 3 dB below full scale;
 RMS level of segment 1 is 6dB below full scale.
 Peak level of both segments is 0 dB full scale.

Usage: Setting only

{MWV_SEGMENT_SETTINGS_FILE: SegSettingFilePath}**(optional for multi-segment waveforms)**

The tag contains the file path and filename of the multi-segment file, used for the calculation of the multi-segment waveform.

Example: {MWV_SEGMENT_SETTINGS_FILE:
 "/var/user/Settings.inf_mswv"}
 Multi-segment file path and filename.

Usage: Setting only

{MWV_SEGMENT_FILES:**"FileNameSeg0.wv", "FileNameSeg1.wv", ..., "FileNameSegN-1.wv"}****(optional for multi-segment waveforms)**

The tag contains a list of file names for every segment in the multi-segment waveform in ASCII format.

Example: {MWV_SEGMENT_FILES: "/var/user/temp/sine.wv",
 "/var/user/temp/rect.wv"}

Usage: Setting only

{MWV_SEGMENTx_COMMENT: text}**(optional for multi-segment waveforms)**

The tag contains a user comment for a specific segment $x = [0 \dots \text{NumOfSeg}-1]$ in the multi-segment waveform in ASCII format.

Example: {MWV_SEGMENT1_FILES: segment 1 contains a QPSK
 signal.}

Usage: Setting only

{CONTROL LIST WIDTH4–Length: #m0m1...mx...mM-1}**(optional for waveforms and multi-segment waveforms)**

The tag contains a binary marker element stream, which is output synchronously to the I/Q sample sequence. One marker element m_x consists of 4 bit, which are assigned to the 3 possible marker traces of the instrument (1 bit per marker trace). One 4-bit marker element is required for every I/Q sample in the WAVEFORM tag. Hence, the number of marker elements m should be equal to the number of I/Q samples. The CONTROL_LENGTH tag has to contain the number of all marker elements m .

MSB 7	Byte						LSB 1
Marker element m_x (synchronous to I/Q Sample x)				Marker element m_{x+1} (synchronous to I/Q Sample $x+1$)			
Marker 4	Marker 3	Marker 2	Marker 1	Marker 4	Marker 3	Marker 2	Marker 1

Figure 4-20: Marker element in 4-bit binary format bit order

For standard waveforms, the `MARKER LIST x` tags are a more compact way to define markers. In principle, however, the `CONTROL LIST WIDTH4` format can also be used instead of the `MARKER LIST x` tags.

For multi-segment waveforms, the `CONTROL LIST WIDTH4` format is required for marker definition. The binary marker streams of the individual segments are directly concatenated (without any gap) to one collectively marker stream.

Setting parameters:

Length Defines the number of bytes in the `CONTROL LIST WIDTH4` tag in ASCII Format and is calculated as follows:

$$\text{Length} = \text{Size of "\#"} (1 \text{ byte}) + \text{Number of marker elements } m_x^* (4 \text{ bit}) / (8 \text{ bits/byte})$$

The value is rounded up for byte alignment.

mx Marker element in 4-bit binary format.

Example: `{CONTROL LIST WIDTH4-51: #m0m1...mx...m99}`
100 marker elements, each marker element with 4 bits

Usage: Setting only

4.6.7.3 Tags for data lists

The following tags apply to data lists, additionally to the tags listed in [Chapter 4.6.7.1, "Common tags"](#), on page 174.

<code>{DATA BITLENGTH: BitLength}</code>	187
<code>{DATA LIST-Length: #d0d1...dx...dN-1...}</code>	188

`{DATA BITLENGTH: BitLength}`

(mandatory for data lists)

The tag defines the length of the data field in the `DATA LIST` tag in bits in ASCII format.

Example:

```
{DATA BITLENGTH: 444}
BB:DM:DLIS:SEL "/var/user/dl"
BB:DM:DLIS:TAG? "dl", "DATA BITLENGTH"
Queries the content of the DATA BITLENGTH tag of the
selected data list file.
Response: '444'
The data list is 444 bits long.
```

Usage: Setting only

{DATA LIST-Length: #d0d1...dx...dN-1...}

(mandatory for data lists)

The tag contains the actual bit sequence of the data list in binary format.

Setting parameters:

Length Defines the number of bytes in the DATA LIST tag in ASCII Format (see {WAVEFORM-Length: #IQQ0I1Q1...IxQx...IN-1QN-1...} for details).

dx Data bits in binary format (8-bit unsigned characters, MSB first).

Example: {DATA LIST-17: #d0d1...dx...d127}
16 bytes containing 128 data bits, first bit is the MS bit of the first byte.

Usage: Setting only

4.6.7.4 Tags for control lists

The following tags apply to control lists, additionally to the tags listed in [Chapter 4.6.7.1, "Common tags"](#), on page 174.

{CONTROL LENGTH: ControlLength}.....	188
{BURST LIST [#]: Pos0:State0; Pos1:State1; ...PosN-1:StateN-1}.....	189
{CW MODE LIST [#]: Pos0:State0; Pos1:State1; ...PosN-1:StateN-1}.....	189
{HOP LIST [#]: Pos0:State0; Pos1:State1; ...PosN-1:StateN-1}.....	189
{LEVATT LIST [#]: Pos0:State0; Pos1:State1; ...PosN-1:StateN-1}.....	189
{MAP LIST [#]: Pos0:State0; Pos1:State1; ...PosN-1:StateN-1}.....	189
{MARKER LIST [#]: Pos0:State0; Pos1:State1; ...PosN-1:StateN-1}.....	189
{[TRACE] LIST [#]: Pos0:State0; Pos1:State1; ...PosN-1:StateN-1}.....	189

{CONTROL LENGTH: ControlLength}

(optional / recommended for marker and control lists)

The tag specifies the length of *all* control or marker list in ASCII format.

The control length influences the way the marker and control lists are processed, in particular the way traces are repeated; see [Figure 4-18](#).

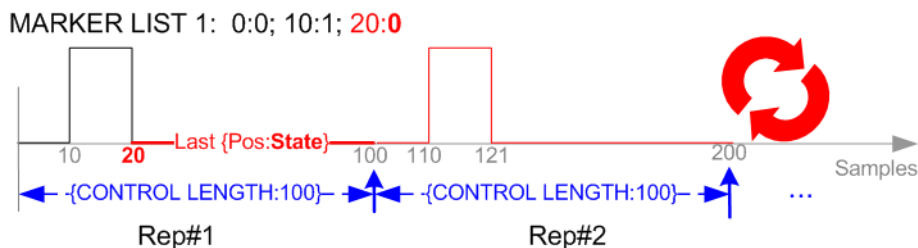

Figure 4-21: Example: Processing of MARKER TRACE if CONTROL LENGHT is specified

If the `CONTROL LENGTH` tag is not used, the marker and control list length are determined by the last position, that is the last `{Pos:State}` couple, defined in the particular `[TRACE] LIST` tag; see [Figure 4-19](#).

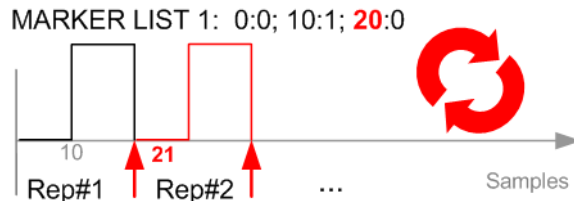

Figure 4-22: Example: Processing of MARKER TRACE if CONTROL LENGTH is not used

To maintain marker signals and waveform data synchronized, set the `CONTROL LENGTH` to be equal to the number of samples specified with the tag `SAMPLES`.

See also [Chapter 4.6.4.5, "How to define periodically repeating traces"](#), on page 162.

Example:

```
{CONTROL LENGTH: 500}
SOURCE:BB:ARBITRARY:CLIST:TAG? 'CONTROL LENGTH'
Queries the length of the control list.
Response: 500
```

Manual operation: See ["Total List Length"](#) on page 122

```
{BURST LIST [#]: Pos0:State0; Pos1:State1; ...PosN-1:StateN-1}
{CW MODE LIST [#]: Pos0:State0; Pos1:State1; ...PosN-1:StateN-1}
{HOP LIST [#]: Pos0:State0; Pos1:State1; ...PosN-1:StateN-1}
{LEVATT LIST [#]: Pos0:State0; Pos1:State1; ...PosN-1:StateN-1}
{MAP LIST [#]: Pos0:State0; Pos1:State1; ...PosN-1:StateN-1}
{MARKER LIST [#]: Pos0:State0; Pos1:State1; ...PosN-1:StateN-1}
{[TRACE] LIST [#]: Pos0:State0; Pos1:State1; ...PosN-1:StateN-1}
```

(mandatory for control lists / optional for waveforms)

The tag contains the data for the marker and control signals in the control list or the marker signals of ARB waveforms.

Traces are processed different, depending on the selected `CONTROL LENGTH`. See for example [Chapter 4.6.4.5, "How to define periodically repeating traces"](#), on page 162.

The processing of the marker traces (`MARKER LIST`) depends additionally on the presence of the tag `MARKER MODE`.

Setting parameters:

```
[TRACE] MARKER | BURST | LEVATT | CW MODE | HOP | MAP
Name of the marker or control signal.
For ARB waveforms, it is only meaningful to define marker signals; in the ARB multi-segment waveforms these tags are ignored!
```

[#]	1 to 3 Sets the marker or control trace number; supported is only <code>LEVATT LIST 1</code> .
Pos	Specifies in ASCII format the position (i.e. sample number or data value), with effect from which the binary <code>State</code> of the marker or of the control signal changes. If the tag <code>MARKER MODE</code> is used, the maximum number of marker states is 64, i.e. <code>Pos₆₃:State₆₃</code> .
State	0 1 Specifies the binary state of the marker or of the control signal from <code>Pos_N</code> to <code>Pos_{N+1}</code> exclusive in ASCII format.
Example:	<pre>{MARKER LIST 1: 0:0;10:1;20:0;30:1}</pre> <pre>BB:DM:CLIS:TAG? 'MARKER LIST 1'</pre> <p>Queries the content of the <code>MARKER LIST 1</code> tag of the selected control list file.</p> <pre>Response: '0:0;10:1;20:0;30:1'</pre> <p>The marker setting for samples 0 to 9 = 0 (low), for 10 to 19 = 1 (high) and for 20 to 29 = 0. From sample 30 onward the marker setting = 1.</p>
Example:	<pre>{LEVATT LIST 1: 0:0;10:1;20:0;30:1}</pre> <pre>BB:DM:CLIS:TAG? 'LEVATT LIST 1'</pre> <p>Queries the content of the <code>LEVATT LIST 1</code> tag of the selected control list file.</p> <pre>Response: '0:0;10:1;20:0;30:1'</pre> <p>Level attenuation applies to data values 10 to 19 (high) and from data value 30 onward.</p>
Usage:	Setting only
Manual operation:	See " Select Ramp to Edit " on page 122

4.7 Reducing the crest factor

Reducing the crest factor of waveforms is a function that requires the additional option Crest Factor Reduction (R&S SMCVB-K548).

See user manual R&S SMCVB-K548 Crest Factor Reduction.

4.8 Generating multi-segment waveform files

Modern chip technologies implement several communication standards within one chip and rise special verification and test requirements. To fulfill the requirements of these test systems and to enable rapid alternation between different waveforms with differing

test signals, the R&S SMCV100B provides the functionality to generate multi-segment waveform files.

This section introduces the concept of the multi-segment waveform files, together with description of the provided settings and some typical configuration examples.

4.8.1 Required options

See [Chapter 4.6.1, "Required options"](#), on page 137.

Multi-segment waveform files require the corresponding Digital Standard options (R&S SMCV100B-K2xx) of all included standards.

4.8.2 About the multi-segment waveforms

A multi-segment waveform is a composed signal that contains several multiple independent waveforms called segments. Each segment is an independent waveform that can be output with its own marker and clock settings.

The [Figure 4-23](#) shows the principle of building a multi-segment waveform.

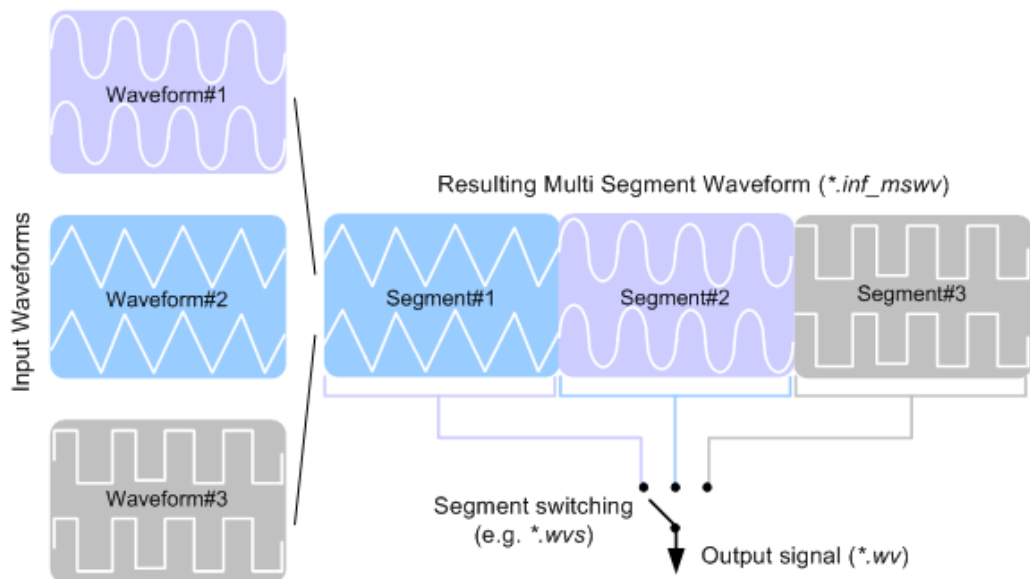

Figure 4-23: ARB Multi-Segment Waveform Concept

It is also possible to create and output a blank segment, i.e. segments containing a zero signal.

Typical applications for the multi-segment mode are described in section [Chapter 4.8.4, "How to create and work with multi-segment waveform files"](#), on page 212.

4.8.2.1 Multi-segment waveforms processing

Processing of the waveform is triggered by the "Create" or "Create and Load" function. To process the waveform, the instrument loads the entire multi-segment waveform into the memory. It is therefore possible to alternate between the individual waveforms without delay due to loading. You can define the output order of the segments, and the segment intended to be output at any given moment.

When the created waveform is loaded, the graphical interface displays information on clock rate, number of samples and creation day. You can also acquire information about the waveform in the dedicated "Waveform Info" dialog.

4.8.2.2 ARB sequencer mode

If high switch over speeds is required, the test signals can be continuously scrolled through with the aid of an external trigger or by applying a predefined "Play List". The R&S SMCV100B provides the possibility to define a sequence of different segments and to determine whether a segment is played once or repeated several times and to adjust the transition between the segments.

For the correct and fast processing and for seamless transition between the multiple waveforms, segments with a common sample rate are required. If the combined waveforms features different sample rates, they have to be adapted to a common sample rate by resampling. Another advantage of this procedure is the scaling of the instantaneous amplitude of the various waveforms to a common RMS level.

4.8.2.3 File concept

To provide flexible configuration, the building of a composed multi-segment waveform file involves different stages; by completing of each of them, the R&S SMCV100B creates and stores a dedicated file. The following files are used:

- **Configuration list:** is a dedicated file with details on how a multi-segment waveform is made up from different waveforms, the level and the clock rate settings, and the filename. The file extension is `*.inf_mswv`.
You can create any number of configurations as a basis for defining further multi-segment waveforms.
- **Output file:** is the created output multi-segment waveform file. The R&S SMCV100B stores it under a user definable name; as with the standard waveforms, the used file extension is `*.wv`. The instrument appends additional information to the header of the composed waveform file, e.g. user comments.
- **Sequencing list:** are files created in the "Multi Segment Waveform Sequencing" dialog, i.e. when the ARB sequencer mode is used (see [Chapter 4.8.2.2, "ARB sequencer mode"](#), on page 192).
The sequencing list file has an extension `*.wvs` and is automatically assigned to but independent from the multi-segment file. By default, both files have the same name and are located in the same file directory. You can create more than one sequencing list file per multi-segment waveform file.
The sequencing list file carries information only about the segment number, the corresponding waveform filenames are retrieved from the assigned multi-segment

waveform file. That is, the same sequencing list file can be reused for different multi-segment waveform files with the same number of segments.

Changes and recalculations of a multi-segment waveform file cause a recheck whether the assigned sequencing list files are still valid. A message is displayed to inform about necessary corrections in the “play list”.

4.8.2.4 Impact of the marker settings

The general purpose of the marker signal is the triggering of the DUT (device under test) and the synchronization with other measurement instruments.

For better flexibility, the instrument provides several possibilities to define marker signals:

- **Segment markers**
Because the multiple segments are standalone waveforms, they can already carry marker signals. You can define how the instrument processes these available marker signals. The instrument can ignore them or use them in the composed multi-segment waveform.
- **Additional segment restart and sequence restart markers**
Additional marker signal can be defined to restart the multi-segment sequence or to restart each of the multiple segments. A marker output configured and defined for one of these purposes overwrites markers that use the same output connector and that are defined in the individual waveforms.

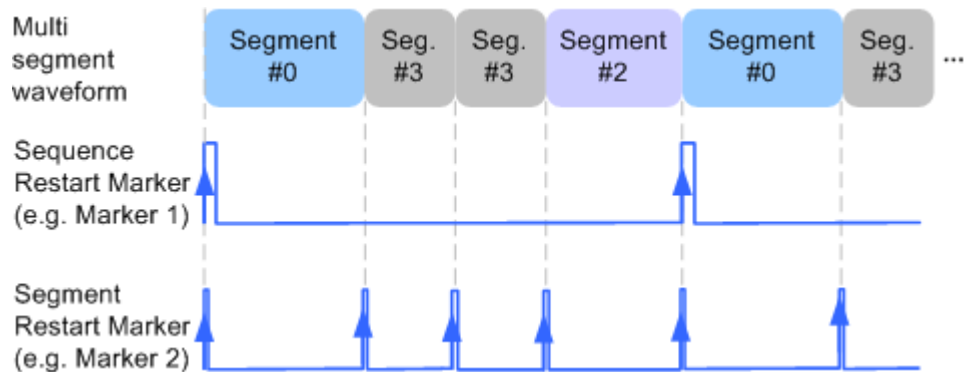

Figure 4-24: Example of marker signals

The segment begin is defined by the low-high slope of the marker, which applies for switching between two segments and if there is a segment replay.

- **General marker signals for the composed multi-segment waveform**
The "ARB" dialog provides also access to the standard marker settings. Settings other than "unchanged" overwrite existing marker in the waveforms or markers defined for the multi-segment waveform.

The [Figure 4-25](#) shows schematically how the instrument evaluates the priorities of the different marker signals, if multiple marker signals are mapped to the same connector.

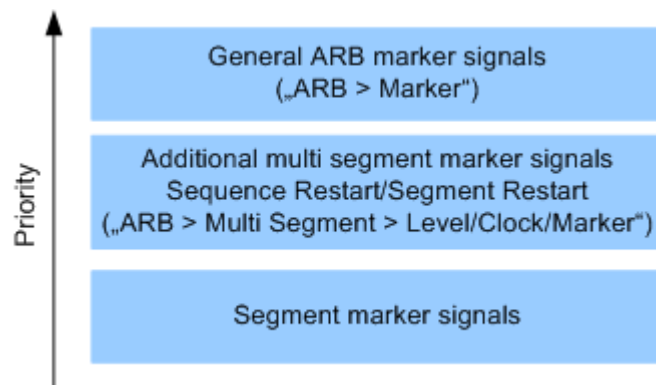

Figure 4-25: Marker priority used by assigning of marker signals to a hardware connector

4.8.2.5 Impact of the trigger settings and next segment settings

The ARB dialog is equipped with the standard (regular) trigger settings. These settings are provided for triggering of the composed multi-segment waveform as a **sequence**, i.e. as one file. The functions provided in the "Trigger" tab and their effect are described in [Chapter 4.4.1.3, "Baseband trigger signals"](#), on page 86.

This section focuses on the additional settings provided for triggering of the individual segments building the composed multi-segment waveform. These settings are enabled and visible only if a multi-segment waveform is loaded for processing. The settings are grouped in the "Multi Segment Waveform Options/Next Segment Trigger In" section.

The [Figure 4-26](#) illustrates how trigger events affect the processing of the multi-segment waveforms.

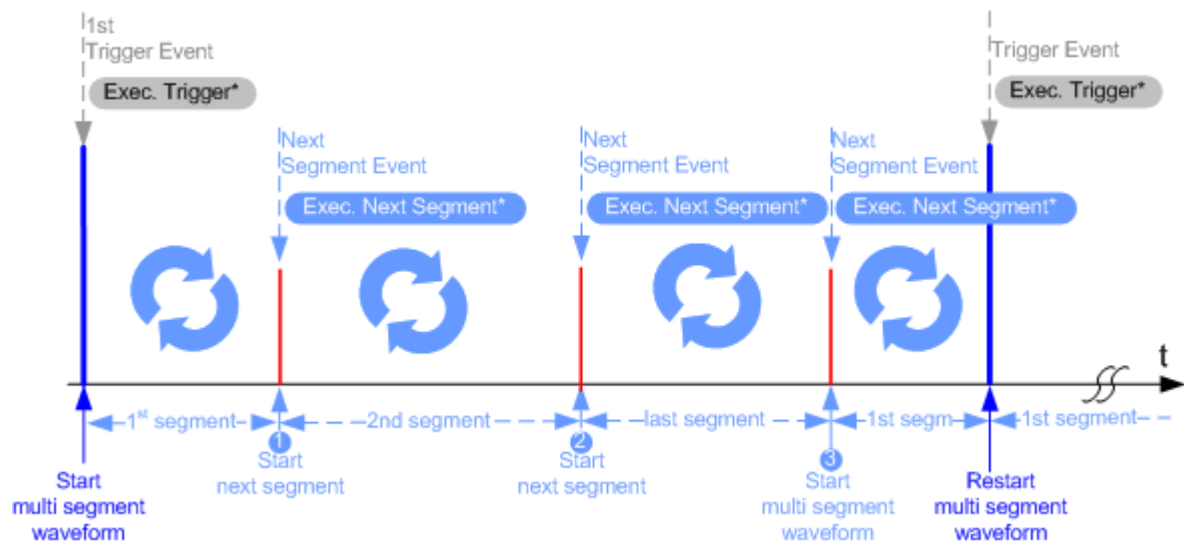

Figure 4-26: Principle of segment triggering

- * = To simplify the description, an internal next segment trigger event ("Exec. Next Segment") and an internal trigger event ("Execute Trigger") are used; an external trigger event has the same effect on the signal generation.
- 1, 2 = Any next segment trigger event (internal or external) causes a switch over to the subsequent available segment in the waveform. The currently output segment (segment filename and segment index) is indicated at "Current Segment".
- 3 = When the last segment of the multi-segment waveform is output, the sequence starts again with the output of the first segment after the subsequent trigger event. Hence, a sequence of external next segment trigger events can be used to cyclically output the segments in the multi-segment file.

Defining the Next Segment Source

As with the standard trigger system, provided are the following two sources for the next segment signal:

- **Internal:** the switch over to the subsequent segment is triggered manually with the "Execute Next Segment" function.
To trigger a switch over to any segment within the multi-segment waveform, change the value of the parameter "Segment".
- **External:** the instrument expects a trigger event ("Global Next Segment") on one of the two provided and configured User connectors.

Defining the Subsequent Segment

By default, the instrument replays the segments in incremental order, e.g. Segment#1, Segment#2, etc. If other order is required, use one of the following possibilities to define the segment to be played next:

- **Next Segment:** defines the subsequent segment while triggering the segments manually, i.e. by "Next Segment Source > Internal"
- **Sequencing List:** the subsequent segment is defined in the selected play list.

Defining the Transition between the Segments

The R&S SMCV100B provides the parameter "Next Segment Mode" to define the transition to the subsequent segment (see the graphs in [Transition examples](#)).

- **Next Segment:** by receiving a Next Segment Event, the ARB aborts immediately the playing of the current waveform and starts playing the next segment waveform (see [Table 4-13](#)).
- **Next Segment Seamless:** by receiving a Next Segment Event, the ARB completes the processing of the current waveform before starting the next segment waveform (see [Table 4-13](#)).
Use this setting to avoid signal gaps and wrap-around problems. Seamless transition requires segments with equal clock rates.
Another way to generate a multi-segment signal without signal gaps between the segments is to use the provided ARB sequencer mode (see [Chapter 4.8.3.4, "Multi-segment waveform sequencing"](#), on page 204).

The [Table 4-13](#) shows two examples of the transition from a sine-wave signal segment to a sawtooth segment (I channel, upper curve) in the case of next segment external triggering. The left graphic displays an abrupt transition; the right graphic, the **seamless** transition case.

Table 4-13: Transition examples

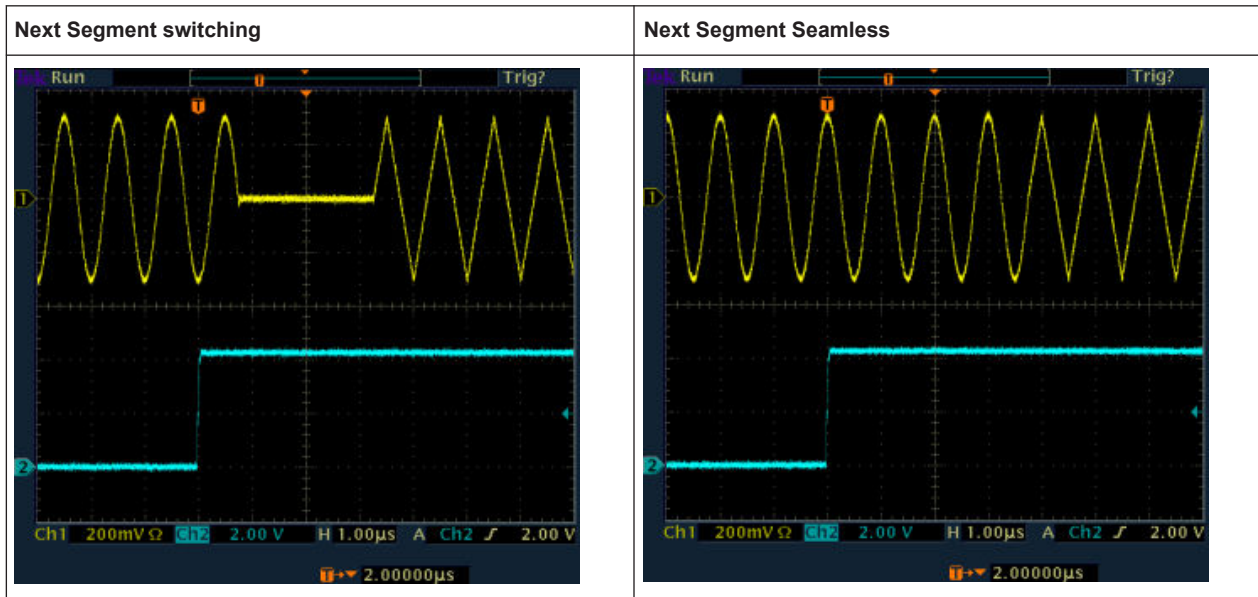

Understanding the Trigger Examples

A simplified diagram in the ARB dialog is intended to explain the effect of the triggering on the signal processing. The currently enabled settings for trigger and next segment mode are considered.



The curves plotted in the dialog are textbook examples, "not measured" waveforms. They are intended to visualize the trigger and the next segment settings more clearly.

- The triangle on the top line denotes a trigger event. A filled triangle on the bottom line denotes a next segment event.
- A green sine wave (or other shape) over a full period indicates one replay cycle of a segment. A shorter example signal indicates a replay cycle which was interrupted, e.g. due to a next segment event (compare the two graphics in Table 4-14).

Table 4-14: Trigger examples in the ARB dialog

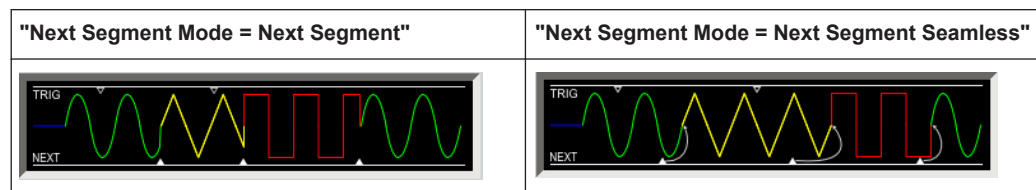

4.8.3 Multi-segment settings

Access:

1. Select "Baseband > ARB > General > Create Multi Segment".

The "ARB: Multi Segment" dialog enables direct assignment of waveforms to the multiple segments, adjusting the clock, level, and marker settings of the composed waveform and selecting the output file.

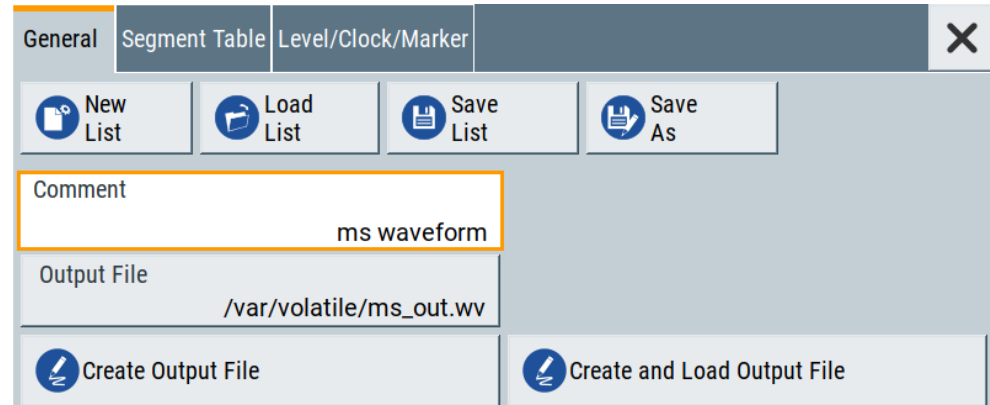

For description on the provided settings, refer to:

[Chapter 4.8.3.1, "Setting for handling the multi-segment files and output file settings"](#), on page 198,

[Chapter 4.8.3.2, "Segment table"](#), on page 200 and

[Chapter 4.8.3.3, "Level / clock / marker settings"](#), on page 202

2. Select "ARB: Multi Segment > General" > **"Create and Load Output File"** to store and load current multi-segment file.
3. Select "Multi Segment" > **"Sequencing List"** to access the settings for configuring a sequencing "Play List" for fast automatic processing of the multi-segment waveform.

For a description of the provided settings, refer to [Chapter 4.8.3.4, "Multi-segment waveform sequencing"](#), on page 204.

4. Select "Baseband > ARB > General".

The "Load Waveform" confirms that the current multi-segment file is loaded (file-name as defined with "Output File").

Note: The provided settings depend on the current waveform.

The "Sequencing List" function for instance requires that:

- Multi segment file is created, i.e. you have executed **"Create Output File/ Create and Load Output File"**.
- "Sequence Table" contains **more than one segment**.

5. Select "Baseband > ARB > Trigger In (MSW)".

For a description of the provided settings, refer to [Chapter 4.8.3.5, "Multi-segment waveform trigger settings"](#), on page 208.

6. Select "Baseband > ARB > General > State > On" to process the configured multi-segment waveform.

The remote commands required to define these settings are described in [Chapter 14.16.3.3, "SOURce:BB:ARbitrary subsystem"](#), on page 687.

• Setting for handling the multi-segment files and output file settings	198
• Segment table	200
• Level / clock / marker settings	202
• Multi-segment waveform sequencing	204
• Multi-segment waveform trigger settings	208

4.8.3.1 Setting for handling the multi-segment files and output file settings

Access:

1. Select "Baseband > ARB > General > Create Multi Segment".

The "General" tab comprises standard functions for file handling, like selecting and loading of files, or determining the output filename.

2. Perform one of the following:

- Select "New List" to create a multi-segment waveform file
- Select "Load List" to load an existing one

3. Add a comment and select "Output File" to define the filename the multi-segment waveform is created at.

Note: The provided settings depend on the current waveform.

The "Sequencing List" function for instance requires that:

- Multi segment file is created, i.e. you have executed "**Create Output File/ Create and Load Output File**".
- "Sequence Table" contains **more than one segment**.

Settings:

New List	198
Load List	198
Save List/Save List As	199
Sequencing List	199
Comment	199
Output file	199
Create/Create and Load	199

New List

Accesses the standard "Create Multi Segment Waveform List" function to enter the name of the new file.

Remote command:

`[:SOURce<hw>] :BB:ARbitrary:WSEgment:CONFigure:SElect` on page 711

Load List

Accesses the standard "File Select" function to select the configuration file to be edited.

Remote command:

`[:SOURce<hw>] :BB:ARbitrary:WSEgment:CONFigure:CATalog?` on page 710

`[:SOURce<hw>] :BB:ARbitrary:WSEgment:CONFigure:SElect` on page 711

Save List/Save List As...

Saves the current entries of the [Segment table](#) in a configuration list (file), including the level mode, clock mode, segment marker mode, and output filename settings.

See also [Chapter 4.8.2.3, "File concept"](#), on page 192.

Consider also the following remote control commands:

- To define the configuration file (* .inf_mswv) used by the calculation of the output file:
 - [:SOURCE<hw>]:BB:ARbitrary:WSEGment:CREate
 - [:SOURCE<hw>]:BB:ARbitrary:WSEGment:CLOad
- To define the filename of the output waveform file (* .wv):
 - [:SOURCE<hw>]:BB:ARbitrary:WSEGment:CONFigure:OFILe

Remote command:

n.a.

Sequencing List

Accesses the dedicated dialog for configuring the associated play lists, see [Chapter 4.8.3.4, "Multi-segment waveform sequencing"](#), on page 204.

This function is enabled, if a multi segment file is created or created and loaded.

Remote command:

n.a.

Comment

Adds a comment to the composed multi-segment file.

Remote command:

[:SOURCE<hw>]:BB:ARbitrary:WSEGment:CONFigure:COMMENT on page 711

Output file

Accesses the standard "File Select" dialog function and requests the filename for the multi-segment waveform to be calculated.

An output filename is required for further processing of the multi-segment waveform:

- For the internal storage triggered by the "Save List" function
- For the calculation and creation of the multi-segment waveform, triggered by the "Create" or "Create and Load" function.

Remote command:

[:SOURCE<hw>]:BB:ARbitrary:WSEGment:CONFigure:OFILe on page 711

Create/Create and Load

- "Create"
 - Creates a multi-segment waveform using the current entries in the [Segment table](#).
- "Create and Load"
 - Creates a multi-segment waveform and loads it in the ARB generator.

The R&S SMCV100B stores the multi-carrier waveform as file with filename as specified with parameter [Output file](#).

Depending on the configuration of the multi-carrier waveform, calculation takes some time. Use the "Abort" function, to interrupt the calculation.

Remote command:

To define the configuration file (*.inf_mswv) used by the calculation of the output file:

[:SOURce<hw>] :BB:ARBitrary:WSEgment:CREate

Or [:SOURce<hw>] :BB:ARBitrary:WSEgment:CLoad

To define the filename of the output waveform file (*.wv):

[:SOURce<hw>] :BB:ARBitrary:WSEgment:CONFigure:OFILe

4.8.3.2 Segment table

Access:

1. Select "Baseband > ARB > General > Multi Segment".
2. In the "ARB: Multi Segment > General" dialog, select an existing list.
3. Select "ARB: Multi Segment > Segment Table".
4. Select "Append" to add *existing* waveform segments.
5. Select "Append Blank" to add a blank segment and configure the "Blank Segment Settings" as required.

General	Segment Table	Level/Clock/Marker						X
Filename	Clock Rate	Samples	Period	Path	Comment	Info		
0 3gpp.wv	11.520 MHz	115200	10.000 ms	/var/volatile/		Info...		
1 lite_tc_10MHz.wv	30.720 MHz	307200	10.000 ms	/var/volatile/		Info...		
2 arb.wv	4.915 MHz	393216	80.000 ms	/var/volatile/		Info...		
3 Blank	100.000 kHz	1000	10.000 ms		Blank segment			

Append ...	Delete	Shift Segment Up	Shift Segment Down
Blank Segment			
Clock Rate	Samples	Period	Append Blank
100.000 000 kHz	1 000	10.000 000 ms	

This section explains the settings, necessary to create and adjust the contents of the multi-segment file.

Settings:

Segment Table.....	200
Append/Delete/Shift Seg. Up/Down.....	201
Blank Segment.....	201

Segment Table

The table lists the individual waveforms (segments) of the selected multi-segment waveform. The information about the segments is retrieved from the tags of the corresponding waveform files.

"Segment#"	Indication of segment index. Within the manual and remote control configuration, this segment index indicates the segment explicitly. Tip: Use the segment index, for example, to define the subsequent sequence to be output in Next Segment Mode "Next Segment" or "Next Segment Seamless".
"Waveform"	Indication of the waveform filename of the segment.
"Clock Rate"	Indication of the clock rate of the selected waveform.
"Samples"	Indication of the number of samples in the segment.
"Period"	Indication of the segment duration.
"Path"	Indication of the location of the waveform file used for the corresponding segment.
"Comment"	Indication of the possible comment contained in the waveform.
"Info"	Indication of the possible comment contained in the waveform.

Remote command:

[\[:SOURCE<hw>\]:BB:ARbitrary:WSEgment:CONFigure:SEGment:CATalog?](#)
on page 706

Append/Delete/Shift Seg. Up/Down

Standard handling functions:

"Append"	Opens the standard "File Select" dialog for navigation to and selection of the waveform file to be added on the end of the existing list. Only non-multi segment waveforms can be loaded.
"Delete"	Removes the selected entry from the table. The waveform file itself is however not deleted.
"Shift Seg.# Up/Down"	Rearranges the segments, i.e. moves the selected segment up and down.

Remote command:

[\[:SOURCE<hw>\]:BB:ARbitrary:WSEgment:CONFigure:SEGment:APPend](#)
on page 711

[\[:SOURCE<hw>\]:BB:ARbitrary:WSEgment:CONFigure:DELeTe](#) on page 711

Blank Segment

Comprises the settings of a blank segment. A blank segment is a zero signal with defined clock rate and number of samples.

"Clock Rate"	Selects the clock rate of the blank segment.
--------------	--

Remote command:

[\[:SOURCE<hw>\]:BB:ARbitrary:WSEgment:CONFigure:BLANK:APPend](#) on page 709

- "Samples" Selects the number of samples for the blank segment.
Remote command:
`[:SOURce<hw>] :BB:ARBitrary:WSEGment:CONFigure:BLANk:APPend` on page 709
- "Period" Displays the resulting period for the blank segment.
- "Append Blank" Adds the blank segment to the multi-segment file.
Remote command:
`[:SOURce<hw>] :BB:ARBitrary:WSEGment:CONFigure:BLANk:APPend` on page 709

4.8.3.3 Level / clock / marker settings

Access:

1. Select "Baseband > ARB > General > Multi Segment".
2. In the "ARB: Multi Segment > General" dialog, select an existing list.
3. Select "ARB: Multi Segment > Segment Table" and configure the segments.
4. Select "ARB: Multi Segment > Level/Marker/Clock".

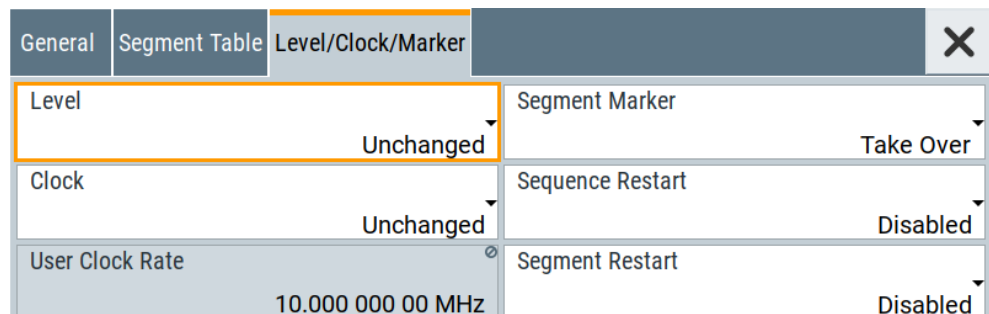

The "Level/Marker/Clock" tab provides the parameters necessary to adjust the level, marker and clock settings for the selected multi-segment waveform file.

Settings:

Level.....	202
Clock.....	203
User Clock Rate.....	203
Segment Marker.....	203
Sequence Restart.....	204
Segment Restart.....	204

Level

Defines the way the instrument determines the output level of each of the multiple waveforms.

- "Unchanged" Concerning the level settings, the segments are output exactly as defined in the individual files. The "Level" display applies only to the segment with the highest RMS value. Sometimes, the remaining segments are output at a lower level than the displayed value.
- "Equal RMS" Segments are output so that all segments have the same RMS value. The "Level" display applies to all segments.

Remote command:

```
[ :SOURce<hw> ]:BB:ARbitrary:WSEgment:CONFigure:LEVel[:MODE]
on page 710
```

Clock

Defines the way the instrument determines the clock rate of each of the multiple waveforms.

- "Unchanged" Each segment is output with the clock rate defined in its waveform file.
Note: Segments with equal clock rates are required for "Next Segment Mode > Next Segment Seamless".
- "Highest" All segments are output at the highest available clock rate.
Note: Trade-off between fast switch over and computing time. This mode provides short switch over times between segments. However, the computing time increases because the individual segments are resampled.
- "User" All segments are output at the clock rate defined by the parameter "User Clock".
This mode is a trade-off between fast switch over and computing time, too.

Remote command:

```
[ :SOURce<hw> ]:BB:ARbitrary:WSEgment:CONFigure:CLOCK:MODE
on page 710
```

User Clock Rate

Defines the sample rate used for multi-segment waveform output, if "Clock Mode > User" is selected.

Remote command:

```
[ :SOURce<hw> ]:BB:ARbitrary:WSEgment:CONFigure:CLOCK on page 710
```

Segment Marker

Defines the way the marker information within the separate segments is processed, see also [Chapter 4.8.2.4, "Impact of the marker settings"](#), on page 193.

- "Ignore" The marker information carried in the individual segment waveform files is not considered.
- "Take Over" The output waveform file contains the marker information as configured in the individual waveform files.

Remote command:

```
[ :SOURce<hw> ]:BB:ARbitrary:WSEgment:CONFigure:MARKer:MODE
on page 708
```

Sequence Restart

Enables/disables the generation of an extra restart marker in the output waveform file.

If additional marker generation is enabled, the existing marker signals in the individual segment waveform files are not considered, see also [Chapter 4.8.2.4, "Impact of the marker settings"](#), on page 193.

"Disable" No additional marker is generated.

"Marker 1, 2, 3"

Generates a restart marker signal at the beginning of the first segment of the complete multi-segment sequence.

Remote command:

`[:SOURce<hw>] :BB:ARbitrary:WSEgment:CONFigure:MARKer:FSEgment`
on page 708

Segment Restart

Enables/disables the generation of an extra restart marker in the output waveform file.

If additional marker generation is enabled, the existing marker signals in the individual segment waveform files are not considered, see also [Chapter 4.8.2.4, "Impact of the marker settings"](#), on page 193.

"Disable" No additional marker is generated.

"Marker 1, 2, 3"

Generates a restart marker signal at the beginning of each segment. The segment begin is defined by the low-high slope of the marker signal, which applies for switching between two segments and if there is a segment replay.

Remote command:

`[:SOURce<hw>] :BB:ARbitrary:WSEgment:CONFigure:MARKer:ESEgment`
on page 708

4.8.3.4 Multi-segment waveform sequencing

Access:

1. Select "Baseband > ARB > General > Create Multi Segment".
2. In the "ARB: Multi Segment > General" dialog, select an existing list.
3. Select "ARB: Multi Segment > Segment Table" and configure a waveform with more than one segment.
4. Select "ARB: Multi Segment > Level/Marker/Clock" and adjust the clock settings so that all segments use the same clock rate.
5. Select "ARB: Multi Segment > General" > **"Create Output File/Create and Load Output File"**.
6. Select "Sequencing List..."
7. Select "New" or "Load" to load a sequencing list file.

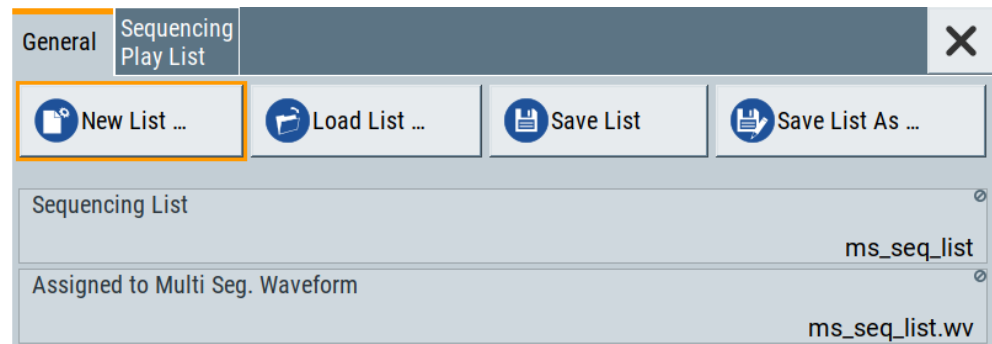

8. Select "ARB: Multi Segment Waveform Sequencing > Sequencing Play List" to create a "play list".

A new sequencing list contains no information.

9. Use the "Append/Delete" and "Up/Down" functions to configure the order the segments are processed.

The user interface shows the configured play list in form of a "Sequencing Graphic".

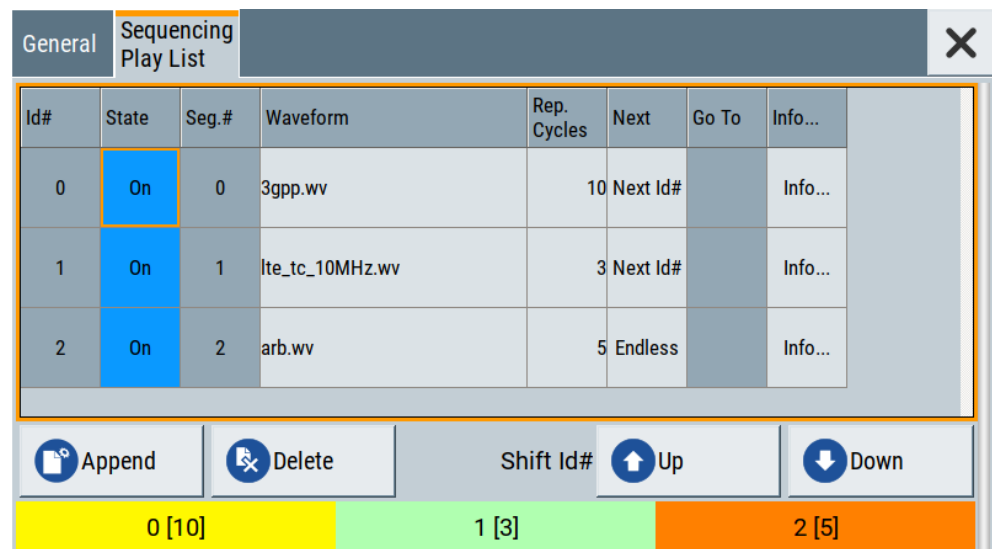

Refer to "[Sequencing play list settings](#)" on page 207 for description of the provided settings.

10. Select "ARB: Multi Segment Waveform Sequencing > General > Save" to store the "play list".
11. Select "ARB: Multi Segment > General > Create and Load Output File" to store and load current multi-segment file.
12. To enable the instrument to use the configured "play list", select "ARB > Next Segment Waveform Options > Next Segment Mode > Sequencer".



All segments in a “play list” must have the same clock rate.

Settings:

- [General settings](#).....206
- [Sequencing play list settings](#).....207

General settings

Access:

- ▶ Select "Baseband > ARB > General > Multi Segment > Sequencing List..."

Settings:

- [New/Load Sequencing List](#)..... 206
- [Save List/Save List As](#)..... 206
- [Sequencing List](#).....206
- [Assigned to Multi Seg. Waveform](#)..... 206

New/Load Sequencing List

Accesses the standard "Select Sequencing List" function to define the name of the new play list file or select of an existing one.

Remote command:

`[:SOURce<hw>] :BB:ARbitrary:WSEgment:SEquence:SElect` on page 706

Save List/Save List As

Saves the current entries of the table in a play list file. Play list files have the file extension *.wvs.

The default filename of the play list file is the same as the multi-segment waveform filename, but it can be changed.

Sequencing List

Displays the name of the selected sequencing list file, i.e. the file with the “play list” settings (see [Chapter 4.8.2.3, "File concept"](#), on page 192).

Remote command:

n.a.

Assigned to Multi Seg. Waveform

Displays the name of the multi-segment waveform file the current sequencing list file is assigned to.

Remote command:

n.a.

Sequencing play list settings

Access:

- ▶ Select "Baseband > ARB > General > Multi Segment > Sequencing List... > Sequencing Play List".

Id#	State	Seg.#	Waveform	Rep. Cycles	Next	Go To	Info...
0	On	0	3gpp.wv	10	Next Id#		Info...
1	On	1	lte_tc_10MHz.wv	3	Next Id#		Info...
2	On	2	arb.wv	5	Endless		Info...

Buttons: Append, Delete, Shift Id#, Up, Down

Summary: 0 [10] (Yellow), 1 [3] (Green), 2 [5] (Orange)

Settings:

Sequencing Play List.....207

- L Next.....208
- L Append.....208
- L Delete.....208
- L Shift Id# Up/Down.....208

Sequencing Graphic.....208

Sequencing Play List

The "Sequencing Play List" table defines the sequence order the waveform file segments are processed and how many times each of them is repeated.

- "Id#" Indicates the row number.
- "State" Enables/disables the selected row. Only active segments are processed.
- "Segment##" Indicates the segment index.
The sequencing list file carries information only about the segment index, the corresponding filenames are retrieved from the assigned multi-segment waveform file.
- "Waveform" Indicates the waveform file mapped to the corresponding segment.
The filename is retrieved from the assigned multi-segment waveform file.
Available are only waveform files from the pool of segments of the selected multi-segment waveform file.

"Repetition Cycles"

Sets the number of times the selected segment is cyclically repeated before the next segment in the sequence is processed.

"Info"

Opens a dialog with detailed information about the currently selected waveform.

Remote command:

See ["Append"](#) on page 208

Next ← Sequencing Play List

Determines the action after completing the current one, like for instance which segment is processed after the processing of the current one is finished.

"Next Id#"

The next active segment in the play list is processed.

"Blank"

After the processing of the current segment is completed, the signal output is stopped until a signal restart like a retrigger signal is received.

A restart signal causes a complete restart of the sequencing play list.

"Endless"

The current segment is replayed until a signal restart like a retrigger signal is received and the complete sequencing play list is restarted. Only active segments are considered.

"Goto Id#"

Determines the row number of the segment to be processed next. This feature is limited to the first 32 rows.

Append ← Sequencing Play List

Inserts a new row at the end of the sequencing play list table.

Remote command:

[\[:SOURCE<hw>\]:BB:ARbitrary:WSEgment:SEquence:SElect](#) on page 706

[\[:SOURCE<hw>\]:BB:ARbitrary:WSEgment:SEquence:APPend](#) on page 707

Delete ← Sequencing Play List

Deletes the selected row.

Shift Id# Up/Down ← Sequencing Play List

Rearranges the rows, i.e. moves the selected row up and down.

Sequencing Graphic

Displays the play list graph according to the current configuration.

The graph shows the segment sequence, the segment number, and the number of times, the segment is repeated; considered are only the active segments.

4.8.3.5 Multi-segment waveform trigger settings

The settings in the "Trigger In (MSW)" tab are visible, only if a multi-segment waveform is loaded into the ARB.

Access:

1. Enable and load a multi-segment waveform in the ARB, see [Chapter 4.8.3, "Multi-segment settings"](#), on page 196.
2. Select "Baseband > ARB > Trigger In (MSW)".

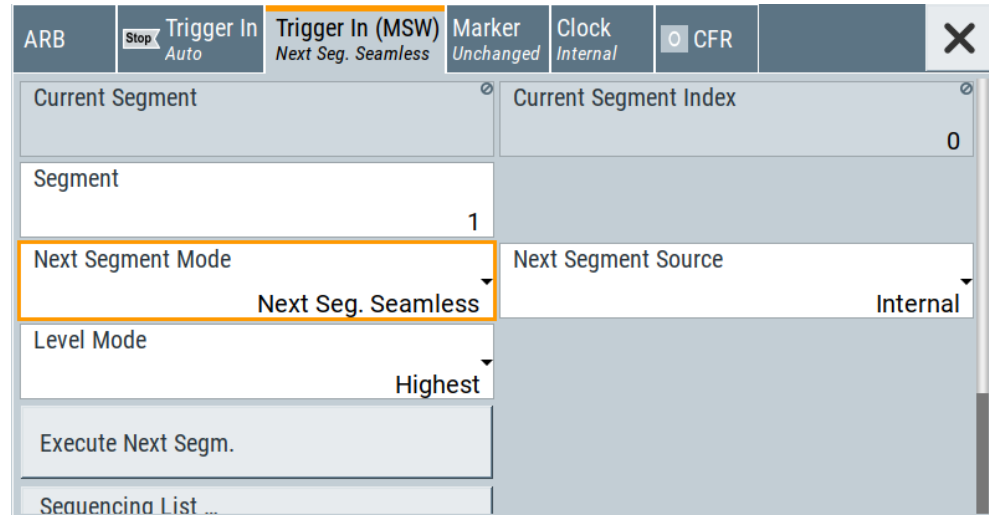

The "Next Segment Trigger In" section comprises the settings necessary to adjust the trigger for switching between the segments of a multi-segment waveform. The parameters displayed depend on the selected trigger source.

Settings:

Current Segment/Current Segment Index	209
Segment	209
Next Segment Mode	210
Next Segment Source	211
Level Mode	211
Execute Next Segment	211
Sequencing List	211
Trigger Example	211

Current Segment/Current Segment Index

Indicates the waveform segment (segment filename and index) that is output.

Remote command:

`[:SOURce<hw>] :BB:ARbitrary:WSEgment?` on page 705

`[:SOURce<hw>] :BB:ARbitrary:WSEgment:NAME?` on page 705

Segment

Selects the waveform segment to be output after the segment indicated as "Current Segment". This parameter determines the start segment when switching on the ARB and enables switching over to any other segment.

The following events cause a switch over:

- An external next segment trigger event

- An internal segment trigger, that is a change in the segment index in the "Segment" field

Use the parameter [Next Segment Mode](#) to define whether the new segment is generated immediately or only after the previous segment has been fully generated (wrap around). The subsequent trigger event after the last segment causes the first segment to be output again.

For more information, see [Chapter 4.8.2.5, "Impact of the trigger settings and next segment settings"](#), on page 194.

Remote command:

`[:SOURce<hw>] :BB:ARbitrary:WSEgment:NEXT` on page 705

Next Segment Mode

Defines the way the **switch over between the segments** in a multi-segment waveform is executed.

The regular trigger mode for starting the waveform generation and **triggering the whole multi-segment sequence** is set with the parameters in the "ARB > Trigger" tab. The segment currently being output is displayed at "Current Segment". The "Trigger Example" graph displays schematically the waveform output, depending on the activated trigger and the next segment settings.

For background information, refer to [Chapter 4.8.2.5, "Impact of the trigger settings and next segment settings"](#), on page 194.

For detailed information on how the regular trigger signal affects the multi-segment waveform processing in combination with the different values for "Next Segment Mode", refer to [Chapter 4.8.5, "Reference to triggering of multi-segment waveforms"](#), on page 217.

Note: The seamless switch over and the sequencer mode require segments with equal sample rate.

"Same Segment"

The processing of the multi-segment waveform file is similar to the processing of a non-multi segment waveform, i.e. there is no switching to consecutive segment upon the receiving of a trigger event. To trigger switching between the segments, change the segment index in the "Segment" field.

"Next Segment"

The current segment ceases to be output when a trigger event for a new segment occurs, and the new segment starts to be output after a system-imposed signal gap.

"Next Segment Seamless"

If all segments have the same sample rate, the new segment is not output until the whole of the current segment has been output (wrap around), i.e. the signal transition is seamless.

"Sequencer"

The waveform files are processed according to the order and repetition cycles defined in the special sequencing list file (*.wvs) assigned to the multi-segment waveform file. This "play list" is defined in the [Multi-segment waveform sequencing](#) dialog.

Remote command:

`[:SOURce<hw>] :BB:ARbitrary:TRIGger:SMODE` on page 708

Next Segment Source

Determines whether the next segment is switched upon receiving of an external trigger signal or upon executing of software next segment trigger (see [Figure 4-26](#)).

This parameter is disabled, if a sequencing play list is used.

"Internal" Switch over to any segment is triggered manually with the "Execute Next Segment" function.

"External Global Next Segment"

The trigger event for switching to the next segment is input as configured on one of the User x connectors.

See also [Chapter 12.2, "Configuring global connectors"](#), on page 449.

Remote command:

`[:SOURce<hw>] :BB:ARbitrary:WSEgment:NEXT:SOURce` on page 706

Level Mode

Sets how the instrument levels the individual segments in a multi-segment signal. The parameter is important, if waveforms with different crest factors are used.

"Highest" All segments are output at the highest available crest factor.

"Unchanged" Each segment is output with the crest factor defined in its waveform file.

Remote command:

`[:SOURce<hw>] :BB:ARbitrary:WSEgment:LMODE` on page 706

Execute Next Segment

For "Next Segment Source = Internal", triggers manually switch over to the subsequent segment in the multi-segment file. The subsequent segment can be any segment within the multi-segment file and is defined by the parameter "Segment"

This parameter is disabled, if a sequencing play list is enabled.

Remote command:

`[:SOURce<hw>] :BB:ARbitrary:WSEgment:NEXT:EXECute` on page 705

Sequencing List

Opens a dialog box for defining the "play lists", see [Chapter 4.8.3.4, "Multi-segment waveform sequencing"](#), on page 204.

Remote command:

`[:SOURce<hw>] :BB:ARbitrary:WSEgment:SEquence:SElect` on page 706

Trigger Example

Displays an example of a multi-segment waveform. The currently enabled trigger and next segment mode are considered. After the instrument is switched on, the graph of the last loaded waveform is displayed.

Note: The curves plotted in this dialog box are textbook examples, "not measured" waveforms. They are intended to visualize the trigger and next segment settings more clearly.

Remote command:
n.a.

4.8.4 How to create and work with multi-segment waveform files

This section provides step-by-step instructions on how to configure and use the multi-segment settings. The [Figure 4-27](#) shows the essential stages of multi-segment waveform configuration, together with the corresponding user interface dialogs and if applicable, the corresponding file extensions. Perform the necessary settings, enable the signal generation, and provide trigger signal.

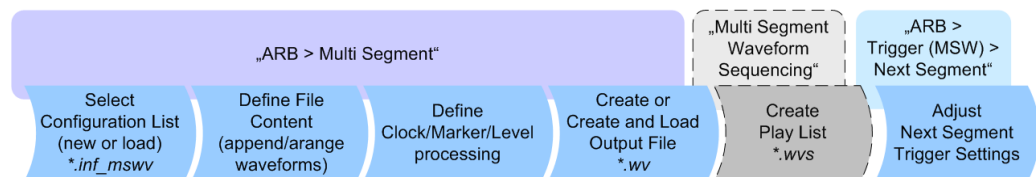

Figure 4-27: Basic workflow for generation of multi-segment waveforms

Generating a multi-segment waveform file (basic workflow)

1. In the "ARB > Create Multi Segment > General" dialog, select "New List" to create an empty list.
2. Use the "ARB: Multi Segment > Segment Table > Append" function to add two or more waveform files.
3. In the "ARB: Multi Segment > Level/Clock/Marker" dialog, adjust the "Level", "Clock", and "Segment Marker" settings.
4. Select the "ARB > Multi Segment > General > Output File" and enter filename.
5. Select "ARB > Multi Segment > General > Save List" to store the configuration file.
6. Select "ARB > Multi Segment > General > Create Output File" or "Create and Load Output File" to create and load the multi-segment waveform.
7. Select "ARB > Multi Segment > General > State > On".



The following description emphasizes on the settings required to fulfill the particular task or achieve the desired performance; standard basic settings are not discussed. All provided examples use the example segment sequence as shown on [Figure 4-28](#).

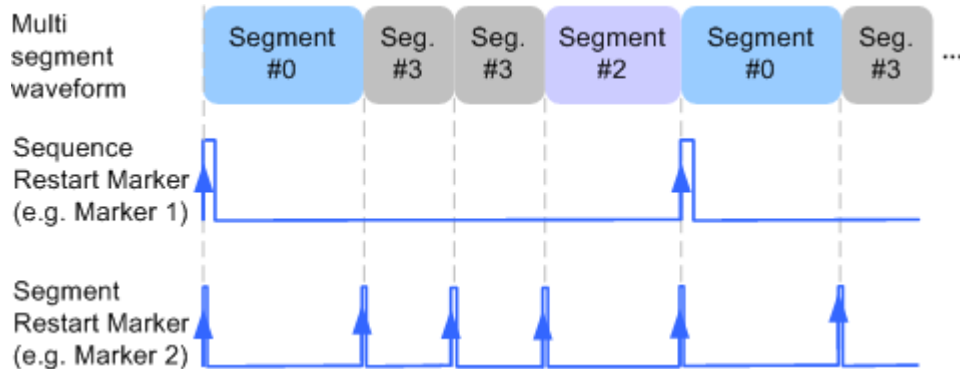

Figure 4-28: Example: multi-segment sequence with marker signals

See how to:

- ["To apply a manual segment switch to the output segments in the required order"](#) on page 213
- ["To generate a multi-segment signal without signal interruptions"](#) on page 214
- ["To enable an external triggering for high-speed switch over"](#) on page 215
- ["To configure a multi-segment sequence using the play list function"](#) on page 216
- ["To add marker signals"](#) on page 217

To apply a manual segment switch to the output segments in the required order

When testing DUTs using different test signals, it may be necessary to switch dynamically and flexibly between any of the test signals, for instance depending on the outcome of the previous test. The following settings enable flexible dynamic switch over between the segments in a multi-segment waveform.

We assume, that a multi-segment sequence composed of 4 segments (Seg#0, Seg#1, Seg#2 and Seg#3) is created and loaded in the ARB (see ["Generating a multi-segment waveform file \(basic workflow\)"](#) on page 212). The required output order of the segments is Seg#0, Seg#3 [2], Seg#2. The instrument is operated manually, the ARB generator is in active state, and the instrument output is switched on.

1. Select "ARB > Trigger In (MSW) > Next Segment Mode = Next Segment"
The transition between the segments is abrupt.
2. To enable manual next segment triggering, select "ARB > Trigger In (MSW) > Next Segment Source = Internal".
3. To enable manual triggering, select "ARB > Trigger In > Mode = Armed Auto".
Select "ARB > Trigger In > Source = Internal".
4. Execute "ARB > Trigger In > Execute Trigger" to trigger the signal generation.

The "ARB > Trigger In (MSW)" settings display the currently output segment: "Current Segment Name = Seg#0" and "Current Segment Index = 0". Seg#0 is output continuously.

5. Set "ARB > Trigger In (MSW) > Segment = 3" to output the second segment in the sequence order.

The parameter "ARB > Trigger In (MSW) > Current Segment Index" changes to segment index 3. Seg#3 is output continuously.

6. Execute "ARB > Trigger In > Execute Trigger" to restart Seg#3.
7. Set "ARB > Trigger In (MSW) > Segment = 2" to output the third segment in the sequence order.

Seg#2 is output continuously.

To switch over to Seg#0, change the "ARB > Trigger In (MSW) > Current Segment Index", etc.

Tip: The ARB sequencer mode provides the necessary settings to achieve the same goal in a more convenient way, see ["To configure a multi-segment sequence using the play list function"](#) on page 216



Faster flexible dynamic switch over

When using **remote control** via an external computer, the following settings enable switching times of approx. 20 ms for segments with the same sample rate and approx. 200 ms for segments with different sample rates:

- "ARB > Trigger In (MSW) > Next Segment Mode = Next Segment"
- "ARB > Trigger In > Trigger Mode = Auto"
- "ARB > Trigger In > Trigger Source = Internal"

To generate a multi-segment signal without signal interruptions

Testing receivers requires a continuous output of different test signals without interrupting the signal. The test signals then produce a complex total signal with no signal gaps on switch over. Control procedures can use a simulated back channel of the receiver (trigger line or remote control).



Switching times depend on the length of the segment currently being output, because switch over to the next segment does not take place until the current segment ends.

To overcome wrap-around problems and generate multi-segment signals without signal gaps between the segments, consider the following settings:

1. Enable "ARB > Trigger In (MSW) > Next Segment Mode = Next Segment Seamless"
2. Select "ARB > Trigger In > Trigger Mode = Auto"
3. Select "ARB > Trigger In > Trigger Source = Internal"

4. A segment ("Current Segment") is output continuously as long as the value of the parameter "Segment" is not changed. Change the value of the parameter "ARB > Trigger In (MSW) > Segment" to select the segment index processed after completing the current one.
5. The seamless transition between the segments requires waveforms with equal clock rate.
If the waveforms feature different sample rates, select "ARB > Multi Segment > Level/Clock/Marker > Clock Mode = Highest" or "Clock Mode = User" to resample the waveforms.

To enable an external triggering for high-speed switch over

To test DUTs/chips using different test signals at high throughput requires fast switch over (for instance when testing ATE devices during manufacture).

We assume, that the required multi-segment sequence is created and loaded in the ARB (see ["Generating a multi-segment waveform file \(basic workflow\)"](#) on page 212). The segments are *output in incremental order*. The instrument is operated manually, the ARB generator is in active state, and the instrument output is switched on. An external global or local trigger source is connected to the instrument and the corresponding connectors are configured.

The following settings enable **switching times of approx. 5 us** and the test signals are scrolled through with the aid of an external trigger signal:

1. Select "ARB > Trigger In (MSW) > Next Segment Mode = Next Segment".
2. Select "ARB > Trigger In (MSW) > Next Segment Source = External (NEXT)".
3. Do not change the displayed segment index (parameter "ARB > Trigger In (MSW) > Segment").
4. Enable "ARB > Trigger > Trigger Mode = Auto"
5. Select "ARB > Trigger > Trigger Source = External Global"
6. If the waveforms in the multi-segment file feature different sample rates, select "ARB > Multi Segment > Level/Clock/Marker > Clock Mode = Highest" or "Clock Mode = User" to resample the waveforms.

The switch over between the segments is triggered by receiving of an external trigger event. The segments are output in incremental order, i.e. Seg#0, Seg#1, etc. The currently processed segment ("Current Segment") is output continuously as long as a new trigger event is received. A new trigger event aborts the output of the current segment immediately and starts the processing of the next one in the sequence.

Tip: To output the segments in any order, use the ARB sequencer mode, see ["To configure a multi-segment sequence using the play list function"](#) on page 216.

For general description on the configuration of the trigger and connector settings: See also [Chapter 12.2, "Configuring global connectors"](#), on page 449.

To configure a multi-segment sequence using the play list function



The ARB Sequencer mode requires waveform files with equal clock rate!

We assume, that a multi-segment sequence composed of four segments (Seg#0, Seg#1, Seg#2 and Seg#3) is created and loaded in the ARB (see "To apply a manual segment switch to the output segments in the required order" on page 213). The required output order of the segments is Seg#0, Seg#3 [2], Seg#2. The instrument is operated manually, the ARB generator is in active state, and the instrument output is switched on.

The following settings show an example of how to configure this segment output order with the help of the ARB sequencing function.

1. In the "ARB > Multi Segment" dialog, load the previously created list and execute "Create and Load".
2. Select "ARB > Multi Segment > General > Sequencing List".
The "Multi Segment Waveform Sequencing" dialog opens. A new play list is created and assigned to the current multi-segment waveform file.
3. Select "ARB: Multi Segment Waveform Sequencing > Sequencing Play List" and use the "Append" function to add new rows to the list and configure the settings as follows:
 - a) Id#0: Seg#0, "Rep. Cycles = 1", "Next = Next Id#"
 - b) Id#1: Seg#3, "Rep. Cycles = 2", "Next = Next Id#"
 - c) Id#2: Seg#2, "Rep. Cycles = 1", "Next =Goto Id", "Go To = 0" (creates a loop to the first segment in the sequence)

General		Sequencing Play List						
Id#	State	Seg.#	Waveform	Rep. Cycles	Next	Go To	Info...	
0	On	0	arb_sine.wv	1	Next Id#		Info...	
1	On	1	arb_constIQ.wv	2	Next Id#		Info...	
2	On	2	arb_rect.wv	1	Goto Id	0	Info...	

Append	Delete	Shift Id#	Up	Down
0 [1]	1 [2]	2 [1]	Goto Id#0	

4. Select "ARB: Multi Segment Waveform Sequencing > General > Save List" to store the configured play list.
5. To enable the instrument to use this play list, select "ARB > Trigger (MSW) > Next Segment Mode > Sequencer".
6. Select "ARB > Trigger (MSW) > Trigger Mode = Armed Auto"

7. Select "ARB > Trigger (MSW) > Trigger Source = Internal"

The segments are played back (output) as defined in the sequencing list, i.e. the switch over to the next segment is performed automatically according to the rules and segment order defined in the "Sequencing Play List".

To add marker signals

We assume, that a multi-segment sequence composed of the segments Seg#0 [1], Seg#3 [2], Seg#2 [1] is created and loaded in the ARB (see ["To configure a multi-segment sequence using the play list function"](#) on page 216). The multi-segment sequence starts with Seg#0 and this segment is output once. The instrument is operated manually, the ARB generator is in active state, and the instrument output is switched on.

To add marker signals at the beginning of each segment and at the beginning of the sequence (see [Figure 4-28](#)), two additional marker signals, "Marker 2" and "Marker 1", are enabled and inserted into the multi-segment waveform.

1. Select "ARB > Marker > Marker Mode > Marker 1/Marker2 = Unchanged" to enable taking over of the marker signals defined inside the multi-segment sequence. If necessary, adjust the marker delay settings.
2. Select the "Block Diagram > Trigger/Marker/Clock" and map the "Logical Signals > Marker 1/Marker 2" to the desired connectors ("Global Connectors > User x > Direction = Output" and "Signal = Baseband Marker 1/Baseband Marker 2")
3. In the "ARB > Multi Segment > Level/Clock/Marker" dialog, select "Segment Marker = Ignore"
4. Enable "Level/Clock/Marker > Sequence Restart = Marker 1"
5. Enable "Level/Clock/Marker > Segment Restart = Marker 2"

An extra restart marker signal is generated at the beginning of each segment and the beginning of the waveform. These restart markers *overwrite* the existing Marker 1 and Marker 2 trace signals defined in the waveforms of the individual segments.

4.8.5 Reference to triggering of multi-segment waveforms

Signal generation of multi-segment waveforms takes place differently according to the trigger selected in the "ARB > Trigger In" section. The sections provide a detailed explanation of the effect of a trigger event on the multi-segment waveform processing, depending on the enabled "Next Trigger Mode". Refer to [Chapter 4.8.2.5, "Impact of the trigger settings and next segment settings"](#), on page 194 for background information.

4.8.5.1 Triggering in "Next trigger mode = same segment"

Depending on the trigger setting, the currently selected segment is continuously output either immediately or after a trigger event.

Table 4-15: Waveform triggering: "Next Trigger Mode = Same Segment", "Trigger Source = Internal"

"Trigger Mode"	Description
"Auto"	Output starts at once and the segment is generated continuously. Trigger events are ignored. If the segment is changed in "Segment", output of the current segment is stopped and the new segment is output immediately, following a system-imposed signal gap.
"Armed_Auto"	Output starts after the first trigger event. The segment is then generated continuously. Further trigger events are ignored. If the segment is changed in "Segment", signal output is stopped and the new segment is not output until a trigger occurs.
"Retrigger"	Output starts at once and the segment is generated continuously, a trigger event causes a restart. If the segment is changed in "Segment", output of the current segment is stopped and the new segment is output immediately, following a system-imposed signal gap.
"Armed_Retrigger"	Output starts after the first trigger event. The segment is then generated continuously. Further trigger events cause a restart. If the segment is changed in "Segment", signal output is stopped and the new segment is not output until a trigger occurs.
"Single"	Output starts after the first trigger event. The segment is then generated once. Further trigger events cause a restart. If the segment is changed in "Segment", signal output is not stopped. The new segment is not output until a trigger occurs.

4.8.5.2 Triggering in "Next trigger mode = next segment"

Depending on the trigger setting, the segment selected under "Segment" is output either immediately or after a trigger event. If the segment index is changed in "Segment", the new segment is not output until a trigger occurs.

Table 4-16: Waveform triggering: "Next Trigger Mode = Next Segment", "Trigger Source = Internal"

"Trigger Mode"	Description
"Auto"	Output starts at once and the segment is generated continuously. If the segment index is changed in "Segment", output of the current segment is stopped and the new segment is output immediately, following a system-imposed signal gap.
"Armed_Auto"	Output starts after the first trigger event. The segment is then generated continuously. If the segment index is changed in "Segment", output of the current segment is stopped and the new segment is output immediately, following a system-imposed signal gap.
"Single"	Output starts after the first trigger event. The segment is then generated once. Further trigger events cause a restart. If the segment index is changed in "Segment", the new segment is not output until a trigger occurs.

Table 4-17: Waveform triggering: "Next Trigger Mode = Next Segment", "Trigger Source = External"

"Trigger Mode"	Description
"Auto"	<p>Output starts at once and the segment is generated continuously.</p> <p>Further trigger events are ignored. Each next segment trigger event switches over to outputting the subsequent segment, following a system-imposed signal gap.</p> <p>If the segment index is changed in "Segment", output of the current segment is stopped and the new segment is output immediately, following a system-imposed signal gap.</p> <p>The subsequent trigger event after the last segment causes the first segment to be output again.</p>
"Armed_Auto"	<p>Output starts after the first trigger event. The segment is then generated continuously.</p> <p>Further trigger events are ignored. Each next segment trigger event switches over to outputting the subsequent segment, following a system-imposed signal gap.</p> <p>If the segment is changed in "Segment", signal output is stopped and the new segment is not output until a trigger occurs.</p> <p>The subsequent trigger event after the last segment causes the first segment to be output again.</p>
"Single"	<p>Output starts after the first trigger event. The segment is then generated once.</p> <p>Each trigger event (re-) starts the segment; each next segment trigger event switches over to outputting the subsequent segment.</p> <p>If the segment is changed in "Segment", signal output is not stopped. The new segment is not output until a trigger occurs.</p> <p>The subsequent trigger event after the last segment causes the first segment to be output again.</p>

For description of the "Retrigger" and "Armed_Retrigger" trigger modes, see [Table 4-15](#).

4.8.5.3 Triggering in "Next trigger mode = next segment seamless"

The segment selected under "Segment" is output. This mode is only available if all segments have the same sample rate.

Table 4-18: Waveform triggering: "Next Trigger Mode = Next Segment Seamless", "Trigger Source = Internal"

"Trigger Mode"	Description
"Auto"	Output starts at once and the segment is generated continuously. If the segment is changed in "Segment", the new segment is output seamlessly after the output of the current segment is complete.
"Armed_Auto"	Output starts after the first trigger event. The segment is then generated continuously. If the segment is changed in "Segment", signal output is stopped and the new segment is not output until a trigger occurs.
"Single"	Output starts at once and the segment is generated continuously. Each trigger event (re-) starts the segment; each next segment trigger event switches over to outputting the subsequent segment once the output of the current segment has been completed. If the segment is changed in "Segment", the new segment is output seamlessly after the output of the current segment is complete.

Table 4-19: Waveform triggering: "Next Trigger Mode = Next Segment Seamless", "Trigger Source = External"

"Trigger Mode"	Description
"Armed_Auto"	Output starts after the first trigger event. The segment is then generated continuously. Each trigger event (re-) starts the segment; each next segment trigger event switches over to outputting the subsequent segment once the output of the current segment has been completed. If the segment is changed in "Segment", signal output is stopped and the new segment is not output until a trigger occurs.

For description of the "Retrigger" and "Armed_Retrigger" trigger modes, see [Table 4-15](#).

4.8.5.4 Triggering in "Next trigger mode = sequencer"

The waveform files are processed according to the order and repetition cycles defined in the special sequencing list file (* .wvs) assigned to the multi-segment waveform file.

4.9 Generating multi-carrier signals

To simulate complex multi-carrier scenarios with different baseband signals, the R&S SMCV100B provides the possibility to generate multi-carrier waveforms. These waveforms can consist of up to 512 carriers, each modulated by the same or by different user-selectable baseband signal.

The multi-carrier waveform is a practical solution for the generation of a complex broadband signal, for example:

- Multi-carrier waveforms build from signals *of different* communication standards (e.g. CDMA2000 or 3GPP FDD)

- Multi-carrier waveforms composed of several signals from *the same* communication standard as in LTE Advanced.

4.9.1 Required options

See [Chapter 4.6.1, "Required options"](#), on page 137.

Multi-carrier waveform files require the corresponding digital standard options (R&S SMCV100B-K2xx) of all included standards.

4.9.2 About the multi-carrier waveforms

This chapter provides background information on the ARB functionality for generating of multicarrier signals and the impact of the provided settings. Refer to [Chapter 4.9.4, "How to use the multi-carrier function"](#), on page 235 for information on how to use the provided settings to configure a multicarrier signal.

The multi-carrier waveforms are convenient way to configure the broadband test signals required for transmitter or receiver tests. Even complex multi-carrier scenarios composed of signals from different digital standards can be created and used for these tests.

Because the multi-carrier files are processed by the ARB generator, the composed waveform file must be created before it is loaded to and played by the ARB. The R&S SMCV100B saves the created multi-carrier waveform file under user definable name; as with the single carrier waveforms, the used file extension is *.wv. The instrument appends additional information to the header of the composed waveform file. When the created waveform is loaded, the graphical interface displays information on clock rate, number of samples and creation day.

Differences between multi-carrier waveform generation and multi-carrier continuous wave generation

By default, the ARB multi-carrier waveform application does not generate a multi-carrier continuous wave (CW) signals that are aligned to the center frequency. Signals generated by the digital standard "Multi Carrier CW" are aligned to the center frequency.

To generate a multi-carrier CW signal, create a constant DC input signal, see ["Create Test Signal"](#) on page 147. Select a signal period, that is matching the carrier frequency distances.

To reach a smooth transition between end and start signal, make sure that the actual carrier frequency offset is rounded: Select "Mode > Equidistant Carrier Spacing" to set a frequency resolution that is the inverse of the signal period of the output signal. See [Chapter 4.9.2.1, "Defining the carrier frequency"](#), on page 222.

General principle for composing the multi-carrier signal

The following is a list of the general steps used for composing the multicarrier signal:

- In the default mode, the up to 512 carriers are equally spaced and centered toward the RF frequency or the baseband DC line.
The carrier spacing is adjustable within the total available bandwidth. Make sure, that the total RF bandwidth of the composed multicarrier signal does not exceed the available RF bandwidth, see data sheet.
- Another possibility is to define the center frequency of each of the carrier individually, see also [Chapter 4.9.2.1, "Defining the carrier frequency"](#), on page 222.
- Each carrier can be separately defined in terms of power, phase and modulated input signal.
To define the leveling of the composed multicarrier signal, use the parameter [Power Reference](#)
- Optionally, crest factor optimization can be applied (see [Chapter 4.9.2.2, "Optimizing the crest factor"](#), on page 223).
- After all multi-carrier processing steps are completed, the instrument calculates the resulting peak and RMS power over the total signal. This value is then written in the waveform file.

4.9.2.1 Defining the carrier frequency

There are two ways to define the carrier frequency of the individual carriers in the multicarrier signal:

- Enabling the **arbitrary carrier frequency** distribution and specifying the carrier frequency of each carrier individually.
- Using the built-in **equidistant carrier spacing** distribution function.
That is, enabling the carriers to be equally spaced and centered toward the RF frequency. The carrier frequencies are automatically calculated depending on the selected number of carriers and the carrier spacing.
The maximum carrier spacing is a function of the available total bandwidth and the selected number of carriers. It is calculated as follows:
$$\text{Max Carrier Spacing} = \text{Total bandwidth} / (\text{Number of Carriers} - 1)$$

To avoid wrap-around problems, the effective applied carrier spacing can be slightly modified.

The value of the carrier spacing is rounded in that way that the carrier closest to the center RF frequency shows no phase jump. It is assumed that the carrier is unmodulated.

- For odd number of carriers:
$$\text{RoundedCarrierSpacing} = 1 / \text{OutputSignalDuration} * \text{round}(\text{CarrierSpacing} * \text{OutputSignalDuration})$$
- For even number of carriers:
$$\text{RoundedCarrierSpacing} = 2 / \text{OutputSignalDuration} * \text{round}(0.5 * \text{CarrierSpacing} * \text{OutputSignalDuration})$$

The R&S SMCV100B provides the parameter [Mode](#) for this purpose.

4.9.2.2 Optimizing the crest factor

An introduction to the topic is provided in [Chapter 4.4.1.7, "Methods for optimizing the crest factor"](#), on page 98. This section focuses on the settings provided for and related to the multicarrier signals.

The R&S SMCV100B provides a crest factor reduction in form of an automatic optimization upon selected values for the following parameters:

- **Crest factor optimization mode:** determines whether the phase settings are selectable or internally calculated to fulfill a requirement for the crest factor value.
- **Clipping:** reduces the peak power of the resulting multicarrier signal according to the input parameter "Target Crest Factor"
The resulting clipped peak power is the sum of the RMS level of the unclipped multicarrier signal and the parameter "Target Crest Factor".
Because clipping reduces also the RMS level, the resulting crest factor of the clipped signal is slightly above the "Target Crest Factor".
- **Target crest factor:** determines the target crest factor. A value above the crest factor of the unclipped multicarrier signal has no effect.
- **Filter cut off frequency:** determines the filter parameter of the final lowpass filter. When the cutoff frequency is set as half of the output sample rate, a final lowpass filter improves the spectrum of the clipped multicarrier signal. However, it can also increase the resulting crest factor.

4.9.3 Multi-carrier settings

Access:

- ▶ Select "Baseband > ARB > General > Create Multi Carrier".

The "ARB: Multi Carrier" dialog enables direct configuration of the carrier distribution around the center frequency and adjusting some parameters for improving the signal characteristics.

The dialog is divided into several tabs. In each case, the current setting is displayed in the tab name. The tab "Carrier Table" enables the selection of the waveform files to be processed. Use the "Carrier Graph" to visualize the configured signal.

The remote commands required to define these settings are described in [Chapter 14.16.3.3, "SOURce:BB:ARbitrary subsystem"](#), on page 687.

Settings:

- [General settings](#).....224
- [Carrier table settings](#).....230
- [Carrier table assistant](#).....232
- [Carrier graph](#).....234

4.9.3.1 General settings

Access:

- Select "Baseband > ARB > General > Create Multi Carrier".

This tab comprises settings for selecting the output waveform file, enabling the generation, and the configuration of the carrier distribution.

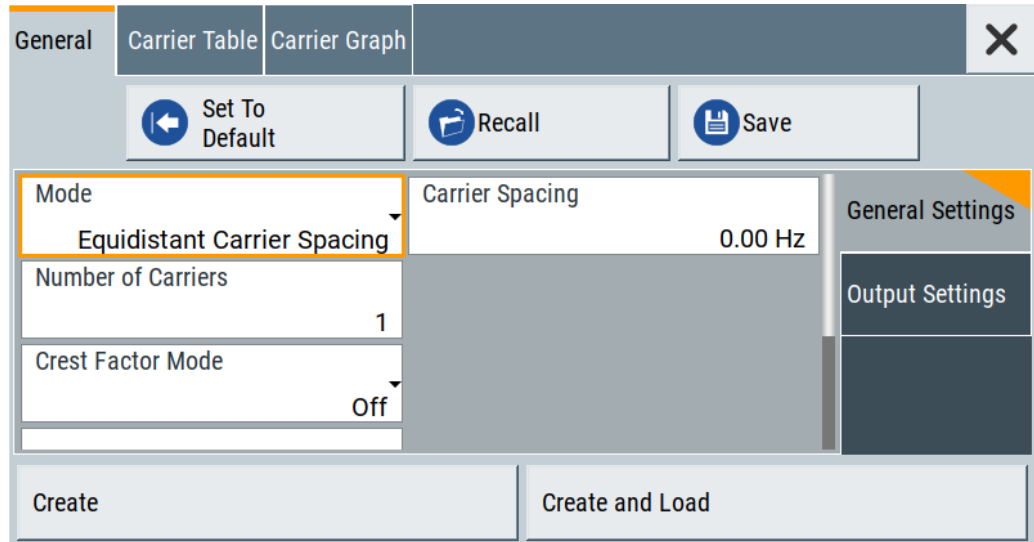

Settings:

Set to Default.....	224
Save/Recall Frame.....	225
Mode.....	225
Number of Carriers.....	225
Carrier Spacing.....	226
Crest Factor Mode.....	226
Clipping.....	226
Target Crest Factor.....	226
Filter Cutoff Frequency.....	226
Signal Period Mode.....	227
Signal Period.....	227
Power Reference.....	227
Output Settings.....	229
└ Output File.....	229
└ Clock Rate.....	229
└ File Size.....	229
Create/Create and Load.....	229

Set to Default

Calls the default settings.

Parameter	Value
"Number of Carriers"	"1"
"Carrier Spacing"	"0 MHz"
"Crest Factor Mode"	"Off"
"Signal Period Mode"	"Longest file wins"

Remote command:

`[:SOURCE<hw>] :BB:ARbitrary:MCARrier:PRESet` on page 713

Save/Recall Frame

Accesses the standard "Save/Recall" dialog, i.e. the standard instrument function for storing and recalling the complete dialog-related settings. Refer to [Chapter 11.4, "Saving and recalling instrument settings"](#), on page 421 for a detailed description.

The multi-carrier settings are saved as files with predefined file extension `*.arb_multcarr`. The filename and the directory are user-definable.

Remote command:

`[:SOURCE<hw>] :BB:ARbitrary:MCARrier:SETTing:CATalog?` on page 713

`[:SOURCE<hw>] :BB:ARbitrary:MCARrier:SETTing:LOAD` on page 713

`[:SOURCE<hw>] :BB:ARbitrary:MCARrier:SETTing:STORe` on page 713

Mode

Selects the way the carriers are distributed within the available bandwidth.

"Equidistant Carrier Spacing"

Sets an equidistant carrier spacing distribution, i.e. the carriers are equally spaced and centered toward the RF frequency. The carrier frequencies are automatically calculated depending on the selected number of carriers and the carrier spacing.

"Arbitrary Carrier Frequency"

Enables the specification of the carrier frequency of each carrier individually.

Remote command:

`[:SOURCE<hw>] :BB:ARbitrary:MCARrier:CARRier:MODE` on page 714

Number of Carriers

Sets the number of carriers for the multi-carrier waveform. By default the multi-carrier table lists one carrier. A maximum of 512 carriers can be configured and activated.

When the number of carriers is increased, new lines are added at the end of the table. If these carriers already have been defined before, the settings are preset according to the former settings. Otherwise the parameters are preset with the default values.

See also [Chapter 4.9.2.1, "Defining the carrier frequency"](#), on page 222.

Remote command:

`[:SOURCE<hw>] :BB:ARbitrary:MCARrier:CARRier:COUNT` on page 714

Carrier Spacing

Sets the frequency spacing between adjacent carriers of the multi-carrier waveform.

The carriers are arranged symmetrically around the RF carrier and the maximum carrier spacing is limited to:

$$\text{"Carrier Spacing"} = \text{Baseband bandwidth} / (\text{"Number of Carriers"} - 1).$$

The baseband bandwidth depends on the installed options (see the data sheet).

For more information, see [Chapter 4.9.2.1, "Defining the carrier frequency"](#), on page 222.

Remote command:

`[:SOURce<hw>] :BB:ARbitrary:MCARrier:CARRier:SPACing` on page 714

Crest Factor Mode

Selects the mode for optimizing the crest factor by calculating the carrier phases. For more information, refer to [Chapter 4.9.2.2, "Optimizing the crest factor"](#), on page 223.

The following modes are available:

- "Off" There is no automatic setting for minimizing or maximizing the crest factor. The "Phase" setting as defined in the carrier table is in use.
- "Minimize" The crest factor is minimized by internally calculating optimized carrier phases. The phase setting displayed in the carrier table is invalid.
- "Maximize" The crest factor is maximized by internally calculating optimized carrier phases. The phase setting displayed in the carrier table is invalid.

Remote command:

`[:SOURce<hw>] :BB:ARbitrary:MCARrier:CFACTOR:MODE` on page 715

Clipping

Switches the baseband clipping on and off.

Clipping reduces the peak power of the resulting multicarrier signal according to the input parameter "Target Crest Factor". For more information, refer to [Chapter 4.9.2.2, "Optimizing the crest factor"](#), on page 223.

Remote command:

`[:SOURce<hw>] :BB:ARbitrary:MCARrier:CLIPping[:STATe]` on page 716

Target Crest Factor

Sets the value of the target crest factor, if baseband clipping is enabled.

A "Target Crest Factor" above the crest factor of the unclipped multicarrier signal has no effect. For more information, refer to [Chapter 4.9.2.2, "Optimizing the crest factor"](#), on page 223.

Remote command:

`[:SOURce<hw>] :BB:ARbitrary:MCARrier:CLIPping:CFACTOR` on page 715

Filter Cutoff Frequency

Sets the cutoff frequency of the final lowpass filter, if baseband clipping is enabled.

When the cutoff frequency is set as half of the output sample rate, a final lowpass filter improves the spectrum of the clipped multicarrier signal. This process can increase the resulting crest factor. See also [Chapter 4.9.2.2, "Optimizing the crest factor"](#), on page 223.

Remote command:

`[:SOURCE<hw>] :BB:ARbitrary:MCARrier:CLIPping:CUToff` on page 716

Signal Period Mode

Defines the way the resulting signal period of the multi-carrier waveform is calculated. The resulting period is always calculated for all carriers in the carrier table irrespective of their state (ON/OFF). Use the "Carrier Table > Info" function to obtain information on the sample rate and file length data of each carrier.

Note: Wrap-around and timing problems can occur when I/Q signals of different length are used. Thus, demodulation of a carrier can be difficult or even impossible.

We recommend that you proceed as follows:

- Consider the timing when creating the input I/Q files.
- Adjust the signal duration to the carrier which is then demodulated.
(In this case, the other carriers are for interfering the signal only.)

These problems do not arise with signals of the same standard (e.g. 3GPP).

The following modes are available:

"Longest File Wins"

The longest I/Q file in the carrier table defines the resulting signal period. Shorter I/Q files are periodically repeated.

"Shortest File Wins"

The shortest I/Q file in the carrier table defines the resulting signal period. Only the first part of longer I/Q files is used.

"User"

The signal period is set manually ([Signal Period](#)). Shorter I/Q files are repeated periodically, and only the first part of longer I/Q files is used.

"Least Common Multiple"

The output file duration is the least common multiple of all input file durations.

Remote command:

`[:SOURCE<hw>] :BB:ARbitrary:MCARrier:TIME:MODE` on page 716

Signal Period

Sets the signal period in signal duration mode "User". Shorter I/Q files are repeated periodically, and only the first part of longer I/Q files is used.

Remote command:

`[:SOURCE<hw>] :BB:ARbitrary:MCARrier:TIME` on page 715

Power Reference

Defines the way the individual carriers in a composed multi carrier signal are leveled. The difference between the provided modes is especially important if signals with different crest factors are composed together into a multi carrier signal.

"RMS" The individual carriers are leveled based on their RMS power and the configured "Carrier Gain".

Example:

A multi carrier signal is composed from two waveform files.

First carrier "Gain" = 0 dB

Second carrier "Gain" = -3 dB

In the resulting multi carrier signal, the *RMS power* of the second carrier signal is 3 dB lower than the RMS power of the first carrier signal.

"Peak" The individual carriers are leveled based on their peak power and the configured "Carrier Gain".

Example:

A multi carrier signal is composed from two waveform files.

First carrier "Gain" = 0 dB

Second carrier "Gain" = -3 dB

In the resulting multi carrier signal, the *peak power* of the second carrier signal is 3 dB lower than the peak power of the first carrier signal.

Example: Multi carrier signal composed of waveforms with different crest factor

A multi carrier signal is composed from two waveform files with the following characteristics:

3GPP FDD signals with the same "Sample Rate" but *different "Crest Factors"*.

"Peak" = 0 dBFS

"Carrier Gain" = 0 dB

State	Carrier Freq. Offs. / MHz	Gain / dB	Phase / deg	Delay / ns	File	Info	!!!
0 On	-5.000 000	0.00	0.00		0 /var/user/te1	Info...	
1 On	5.000 000	0.00	0.00		0 /var/user/te2	Info...	

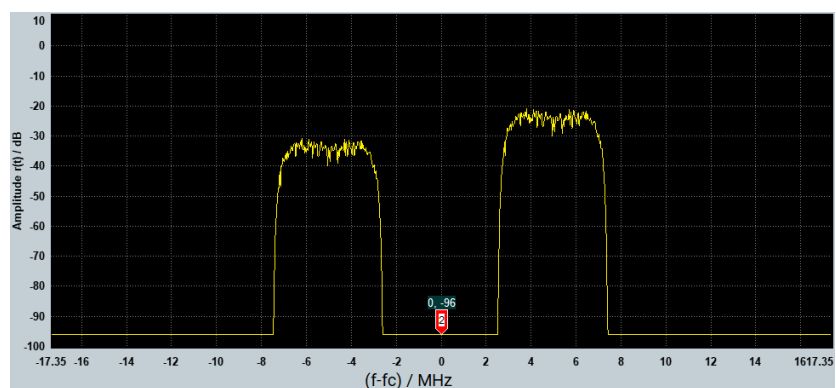

The Peak values of the carrier signals are equal, the RMS values are different.

Remote command:

[\[:SOURce<hw>\]:BB:ARbitrary:MCARrier:POWer:REference](#) on page 717

Output Settings

The output settings indicate the name, the file size, and the clock rate of the currently calculated multi-carrier output file.

Output File ... ArbMccwOutpDummy	General Settings
Clock Rate 0.000Hz	Output Settings
File Size 0Samples	
Create	Create and Load

Output File ← Output Settings

Accesses the standard "File Select" function to specify the output filename of the multi-carrier waveform to be calculated. As with normal waveforms, the file extension is * .wv.

To trigger the calculation and storage of this multi-carrier waveform, select "Create" or "Create and Load".

Remote command:

[\[:SOURce<hw>\]:BB:ARbitrary:MCARrier:OFILe](#) on page 717

Clock Rate ← Output Settings

Displays the resulting sample rate at which the multi-carrier waveform is output by the ARB generator.

The output clock rate depends on the following:

- Number of carriers
- Carrier spacing
- Input sample rate of the leftmost or rightmost carriers.

Remote command:

[\[:SOURce<hw>\]:BB:ARbitrary:MCARrier:CLOCK?](#) on page 718

File Size ← Output Settings

Displays the resulting number of samples of the multi-carrier waveform.

Remote command:

[\[:SOURce<hw>\]:BB:ARbitrary:MCARrier:SAMPles?](#) on page 715

Create/Create and Load

Creates a multi-carrier waveform defined by the multi-carrier table and general setting entries.

If you start calculation with the "Create and Load" function, the instrument creates the waveform and loads it in the ARB generator.

This multi-carrier waveform is saved with filename specified in "Output File". Depending on the configuration of the multi-carrier waveform, calculation can take some time. To stop the calculation, use the "Abort" function.

Remote command:

`[:SOURCE<hw>] :BB:ARbitrary:MCARrier:CREate` on page 718

`[:SOURCE<hw>] :BB:ARbitrary:MCARrier:CLoad` on page 717

4.9.3.2 Carrier table settings

Access:

1. Select "Baseband > ARB > General > Multi Carrier".
2. Select "ARB: Multi Carrier > Carrier Table"

State	Carrier Freq. Offs. / MHz	Gain / dB	Phase / deg	Delay / ns	File	Info	!!!
0 On	-7.500 000	0.00	0.00		0 /var/user/3gpp-1-16.wv	Info...	
1 On	-2.500 000	0.00	0.00		0 /var/user/3gpp-1-16.wv	Info...	
2 On	2.500 000	0.00	0.00		0 /var/user/3gpp-1-16.wv	Info...	
3 On	7.500 000	0.00	0.00		0 /var/user/3gpp-1-16.wv	Info...	

This tab comprises the settings of the individual carriers. A selectable carrier range can be set with the aid of the optional "Carrier Table Assistant".

The settings of all available carriers are displayed in table form. Previously applied assistant settings can be further refined. The number of lines corresponds to the number of carriers.



The "Phase / deg" settings are only valid if optimization of the crest factor is disabled ("Crest Factor Mode" = "Off").

Use the "Carrier Graph" tab to visualize the selected multi-carrier configuration.

Settings:

Number of Carriers.....	231
No.....	231
State.....	231
Carrier Freq [MHz].....	231
Gain.....	231

Phase.....	231
Delay.....	231
File.....	232
Info.....	232
!!!.....	232

Number of Carriers

Defines the number of carriers of the multi-carrier waveform.

This parameter is identical to the one in the "General Setting" section.

Remote command:

`[:SOURce<hw>] :BB:ARbitrary:MCARrier:CARRier:COUNT` on page 714

No

Indicates the carrier index ranging from 0 to (number of carriers -1).

Remote command:

Individual carriers are set by the index at the keyword `CARR`

State

Switches On/Off a carrier.

Remote command:

`[:SOURce<hw>] :BB:ARbitrary:MCARrier:CARRier<ch>:STATE` on page 718

Carrier Freq [MHz]

Sets the carrier frequency.

Note: The carrier frequency can only be set in "Arbitrary Carrier frequency" mode. For "Equidistant Carrier Spacing", the carrier spacing is determined automatically.

Remote command:

`[:SOURce<hw>] :BB:ARbitrary:MCARrier:CARRier<ch>:FREQuency`
on page 718

Gain

Sets the gain of a carrier.

Remote command:

`[:SOURce<hw>] :BB:ARbitrary:MCARrier:CARRier<ch>:POWER` on page 719

Phase

Sets the starting phase of a carrier.

Remote command:

`[:SOURce<hw>] :BB:ARbitrary:MCARrier:CARRier<ch>:PHASE` on page 719

Delay

Sets the starting delay of a carrier.

Remote command:

`[:SOURce<hw>] :BB:ARbitrary:MCARrier:CARRier<ch>:DELay` on page 719

File

Accesses the standard "File Select" function for selecting the input file. The input file contains the I/Q signal that is modulated onto the carrier.

Remote command:

[\[:SOURCE<hw>\]:BB:ARbitrary:MCARrier:CARRier<ch>:FILE](#) on page 720

Info

Indicates the sample rate, number of I/Q value pairs (number of samples), and the signal period of the selected file.

Remote command:

n.a.

!!!

Indicates an occurred conflict by means of a warning triangle. A conflict arises when the carriers overlap and is also indicated in the header of the "Carrier Table" tab.



Remote command:

[\[:SOURCE<hw>\]:BB:ARbitrary:MCARrier:CARRier<ch>:CONFLICT?](#)
on page 720

4.9.3.3 Carrier table assistant

Access:

1. Select "Baseband > ARB > General > Multi Carrier".
2. Select "ARB: Multi Carrier > Carrier Table > Carrier Table Assistant"

Number of Carriers	4	
Carrier Start	0	Carrier Stop 0
Carrier State	<input checked="" type="checkbox"/>	
Gain Start	0.00 dB	Gain Step 0.00 dB
Phase Start	0.00 deg	Phase Step 0.00 deg
Delay Start	0 ns	Delay Step 0 ns
 Input Waveform File ...		3gpp-1-16
 Apply Assistant Settings		

The "Carrier Table Assistant" dialog enables the configuration of a selectable subset of carrier. The provided settings are an optional way to create a multi-carrier scenario within a specified carrier range.

Settings:

Carrier State.....	233
Carrier Start/Start.....	233
Gain Start.....	233
Gain Step.....	233
Phase Start.....	233
Phase Step.....	234
Delay Start.....	234
Delay Step.....	234
Input Waveform File.....	234
Apply Assistant Settings.....	234

Carrier State

Switches the carriers in the range "Carrier Start" to "Carrier Stop" on/off.

Remote command:

`[:SOURCE<hw>] :BB:ARbitrary:MCARrier:EDIT:CARRier:STATe` on page 720

Carrier Start/Start

Defines the start/stop index of the carrier range to which the assistant settings are intended to apply.

Remote command:

`[:SOURCE<hw>] :BB:ARbitrary:MCARrier:EDIT:CARRier:START` on page 720

`[:SOURCE<hw>] :BB:ARbitrary:MCARrier:EDIT:CARRier:STOP` on page 720

Gain Start

Sets the gain of the carrier marked by "Carrier Start".

Remote command:

`[:SOURCE<hw>] :BB:ARbitrary:MCARrier:EDIT:CARRier:POWER[:START]`
on page 721

Gain Step

Sets the step width that is used to increment the gain.

The resulting carrier gain in the carrier table equals:

$$\text{Gain} = \text{"Gain Start"} + n * \text{"Gain Step"}$$

n is a value between 0 and the difference of "Carrier Stop" and "Carrier Start".

Remote command:

`[:SOURCE<hw>] :BB:ARbitrary:MCARrier:EDIT:CARRier:POWER:STEP`
on page 721

Phase Start

Sets the phase of the carrier marked by "Carrier Start".

Remote command:

```
[ :SOURCE<hw> ] :BB:ARbitrary:MCARrier:EDIT:CARRier:PHASe [ :START ]  
on page 722
```

Phase Step

Sets the step width that is used to increment the phase.

The resulting phase in the carrier table equals:

$$\text{Phase} = \text{"Phase Start"} + n \cdot \text{"Phase Step"}$$

n is a value between 0 and the difference of "Carrier Stop" and "Carrier Start".

Remote command:

```
[ :SOURCE<hw> ] :BB:ARbitrary:MCARrier:EDIT:CARRier:POWer:STEP  
on page 721
```

Delay Start

Sets the delay of the carrier marked by "Carrier Start".

Remote command:

```
[ :SOURCE<hw> ] :BB:ARbitrary:MCARrier:EDIT:CARRier:DELay [ :START ]  
on page 723
```

Delay Step

Sets the step width that is used to increment the delay.

The resulting delay in the carrier table equals:

$$\text{Delay} = \text{"Delay Start"} + n \cdot \text{"Delay Step"},$$

n is a value between 0 and the difference of "Carrier Stop" and "Carrier Start".

Remote command:

```
[ :SOURCE<hw> ] :BB:ARbitrary:MCARrier:EDIT:CARRier:DELay:STEP  
on page 722
```

Input Waveform File

Accesses the standard "File Select" function for selecting the input file. The input file contains the I/Q signal to be modulated onto *all carriers* of the selected carrier range.

Remote command:

```
[ :SOURCE<hw> ] :BB:ARbitrary:MCARrier:EDIT:CARRier:FILE on page 723
```

Apply Assistant Settings

Transfers the assistant settings to the carrier table.

Remote command:

```
[ :SOURCE<hw> ] :BB:ARbitrary:MCARrier:EDIT:CARRier:EXECute  
on page 723
```

4.9.3.4 Carrier graph

Access:

1. Select "Baseband > ARB > General > Multi Carrier".

2. Select "ARB: Multi Carrier > Carrier Graph"

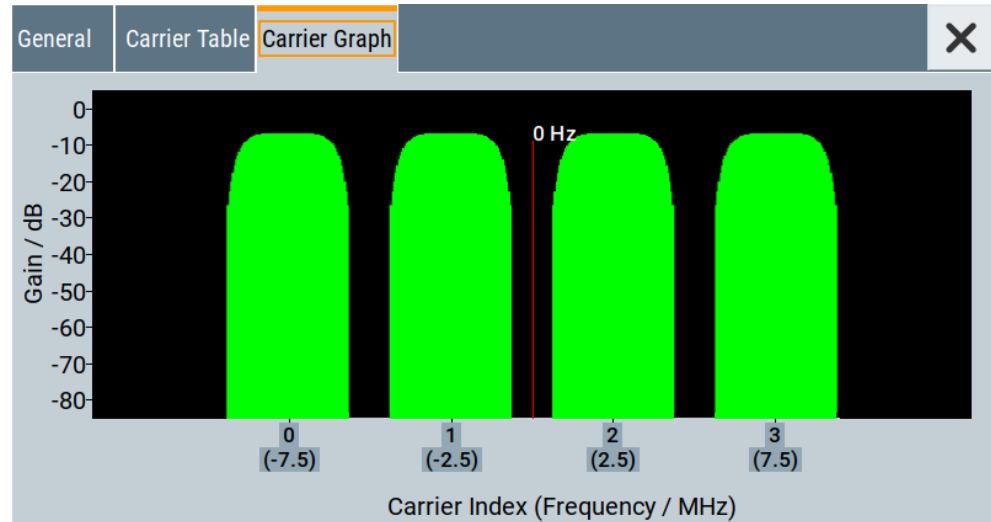

The carrier graph is a graphical representation of the current multi-carrier configuration in the frequency domain.

The height of the bars corresponds to the gain of each individual carrier. The bars width indicates the bandwidth of the carriers signals.

4.9.4 How to use the multi-carrier function

This section provides step-by-step instructions on how to configure and use the multi-carrier settings.

To create a multi-carrier waveform file (general workflow)

Perform the following general steps:

1. To configure the general settings, select "Baseband > ARB > General"
2. To configure the carrier table select "ARB > Multi Carrier > Carrier Table"
3. To enter the filename of the multi-carrier waveform, select "ARB > Multi Carrier > Output File"
4. To save and load multi-carrier waveform, select "ARB > Multi Carrier > Create or Create and Load")



To generate a multi-carrier signal for standard transmitter test

High-power amplifiers of multi-carrier base stations face increased requirements in terms of linearity and acceptable intermodulation performance.

To set up a standard transmitter test, proceed as follows:

1. Open the "Baseband > 3GPP FDD" dialog. Perform the following:
 - a) select "3GPP FDD > Basestations > Test Setups/Models"
 - b) select "3GPP FDD: Downlink/Test Model > Test_Model_1_16channels".

- c) Confirm with "Select".
2. To enable signal generation, select "3GPP FDD > General > ON".
3. To create a 3GPP ARB file, select "3GPP FDD > Generate Waveform".
Enter the name of the waveform, that you want to generate, for example:
3gpp_1_16.
4. Confirm with "Save"
5. To set up a multi-carrier scenario with 4 carriers and a carrier spacing of 5 MHz, select "Baseband > ARB > Multi Carrier".
Perform the following:
 - a) In the "General" dialog, select "Number of Carriers = 4" and "Carrier Spacing = 5 MHz".
 - b) To load the generated waveform file to all 4 carriers, select "Carrier Table > Carrier Table Assistant". Select "Carrier Start = 0" and "Carrier Stop = 3".
 - c) To load the generated waveform file to all 4 carriers, select "ARB Multi Carrier Table > Input Waveform File". Select the generated waveform file 3gpp_1_16.
 - d) Select "ARB Multi Carrier Table > Carrier State > On".

Number of Carriers	4	
Carrier Start	0	Carrier Stop 0
Carrier State	<input checked="" type="checkbox"/>	
Gain Start	0.00 dB	Gain Step 0.00 dB
Phase Start	0.00 deg	Phase Step 0.00 deg
Delay Start	0 ns	Delay Step 0 ns
 Input Waveform File ...		3gpp-1-16
 Apply Assistant Settings		

- e) Select "ARB Multi Carrier Table > Apply Assistant Settings". Close the dialog.
The "ARB: Multi Carrier > Carrier Table" dialog confirms the configuration.

General		Carrier Table	Carrier Graph						✕
Number of Carriers		4		Carrier Table Assistant ...					
State	Carrier Freq. Offs. / MHz	Gain / dB	Phase / deg	Delay / ns	File	Info	!!!		
0 On	-7.500 000	0.00	0.00		0 /var/user/3gpp-1-16.wv	Info...			
1 On	-2.500 000	0.00	0.00		0 /var/user/3gpp-1-16.wv	Info...			
2 On	2.500 000	0.00	0.00		0 /var/user/3gpp-1-16.wv	Info...			
3 On	7.500 000	0.00	0.00		0 /var/user/3gpp-1-16.wv	Info...			

6. Select "ARB: Multi Carrier > Carrier Graph" to visualize the configuration.

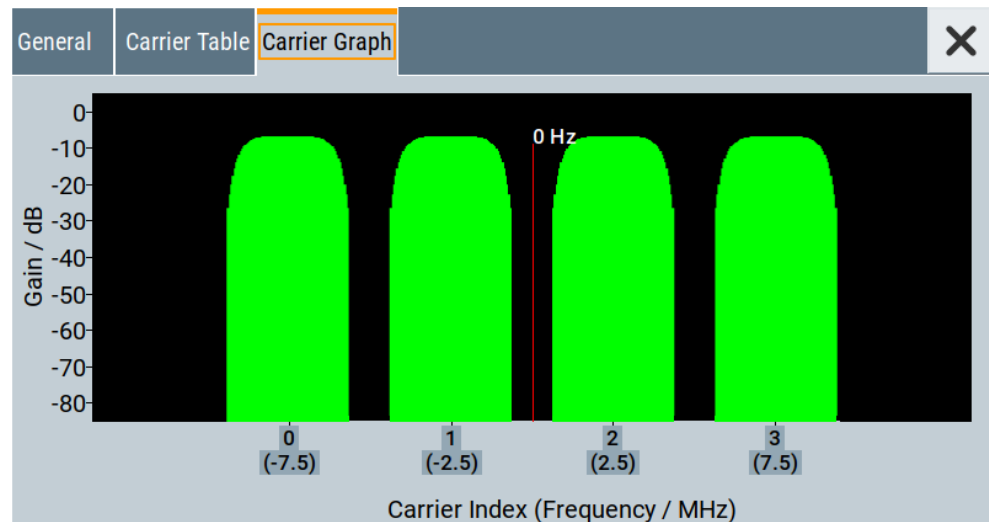

7. Select "ARB: Multi Carrier > General > Output Settings > Output File" and enter the name of the output file, for example `4x5MHz_3gpp_1_16`.
8. To trigger signal calculation and to load the waveform in the ARB generator, select "ARB: Multi Carrier > General > Create/Create and Load" function.
9. Select "ARB > General > Load Waveform".
Confirm that you loaded the generated multi-carrier waveform.
10. Select "ARB > State > On" to enable the ARB generator.

4.10 Generating FM/PhiM/AM/Pulse modulation signals

Required options

Additional to the [minimum configuration](#), generating FM/Phi(Φ)M/AM/Pulse modulation signals at the R&S SMCV100B requires additional options:

- Option Basic AM/FM/PhiM (R&S SMCVB-K197)
- Option Pulse Modulation (R&S SMCVB-K198)

Signal routing to the instrument output

You can output "FM/ Φ M/AM/Pulse Modulation" signals at the RF output connector. Routing to these signals to the digital I/Q output interface is not possible, the "I/Q Digital" block is not configurable.

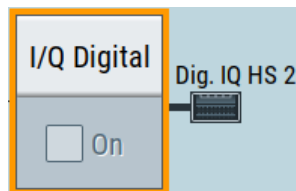

Settings

- [FM/PhiM/AM configuration and settings](#)..... 238
- [Pulse modulation configuration and settings](#)..... 242

4.10.1 FM/PhiM/AM configuration and settings

Option: R&S SMCVB-K197

Access:

- ▶ Select "Baseband > FM/ Φ M/AM".

The dialog provides settings to generate digital baseband signals for frequency modulation (FM), phase modulation (PhiM/ Φ M) and amplitude modulation (AM). You can generate FM and AM signals and Φ M and AM signals in parallel. FM and Φ M cannot be generated at the same time. Activating the FM state deactivates the Φ M state and vice versa.

Settings:

- [FM settings](#).....238
- [PhiM settings](#).....240
- [AM settings](#)..... 241

4.10.1.1 FM settings



Access:

1. Select "Baseband > FM/ΦM/AM > FM".
2. If enabled, the baseband block displays "FM > On".

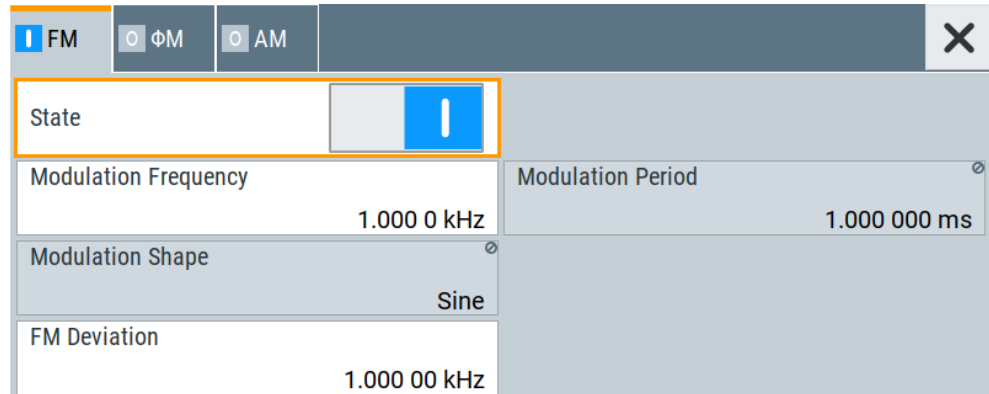

The tab provides settings necessary to configure basic frequency modulation.

The remote commands required to define these settings are described in "FM commands" on page 731.

Settings:

State.....239
 Modulation Frequency.....239
 Modulation Period.....239
 Modulation Shape.....239
 FM Deviation.....240

State

Activates the standard and deactivates all the other digital standards and digital modulation modes in the same path.

Remote command:

[:SOURce<hw>] :BB:GENeral:FM[:STATe] on page 732

Modulation Frequency

Sets the frequency of modulation signal.

Remote command:

[:SOURce<hw>] :BB:GENeral:FM:FREQuency on page 732

Modulation Period

Displays the period of the modulation signal.

Remote command:

[:SOURce<hw>] :BB:GENeral:FM:PERiod on page 732

Modulation Shape

Displays the shape of the modulation signal.

Remote command:

[:SOURce<hw>] :BB:GENeral:FM:SHAPE on page 732

FM Deviation

Sets the frequency modulation deviation in kHz.

Remote command:

[:SOURce<hw>] :BB:GENeral:FM:DEVIation on page 731

4.10.1.2 PhiM settings



Access:

1. Select "Baseband > FM/ΦM/AM > ΦM".
2. If enabled, the baseband block displays "ΦM > On".

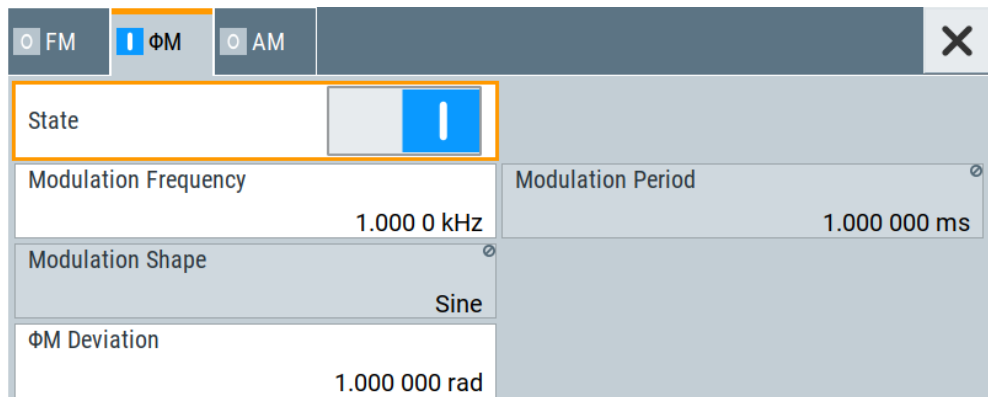

The tab provides settings necessary to configure basic phase modulation.

The remote commands required to define these settings are described in "PM commands" on page 734.

Settings:

State.....240
 Modulation Frequency.....240
 Modulation Period..... 241
 Modulation Shape..... 241
 PhiM Deviation..... 241

State

Activates the standard and deactivates all the other digital standards and digital modulation modes in the same path.

Remote command:

[:SOURce<hw>] :BB:GENeral:PM [:STATe] on page 735

Modulation Frequency

Sets the frequency of modulation signal.

Remote command:

[:SOURce<hw>] :BB:GENeral:PM:FREQuency on page 735

Modulation Period

Displays the period of the modulation signal.

Remote command:

[:SOURce<hw>] :BB:GENeral:PM:PERiod on page 735

Modulation Shape

Displays the shape of the modulation signal.

Remote command:

[:SOURce<hw>] :BB:GENeral:PM:SHAPE on page 735

PhiM Deviation

Sets the deviation of the phase modulation ΦM in radians or degrees.

The maximal deviation depends on the RF frequency and the selected modulation mode. The value is clipped automatically, if the set is too high for the particular frequency.

Remote command:

[:SOURce<hw>] :BB:GENeral:PM:DEVIation on page 734

4.10.1.3 AM settings



Access:

1. Select "Baseband > FM/ ΦM /AM > AM".
2. If enabled, the baseband block displays "AM > On".

Modulation Mode	State	Modulation Frequency	Modulation Period	Modulation Shape	AM Depth
FM	Off				
ΦM	Off				
AM	On	1.000 0 kHz	1.000 000 ms	Sine	30.0 %

The tab provides settings necessary to configure basic amplitude modulation.

The remote commands required to define these settings are described in "[AM commands](#)" on page 733.

Settings:

State.....	242
Modulation Frequency.....	242
Modulation Period.....	242
Modulation Shape.....	242
AM Depth.....	242

State

Activates the standard and deactivates all the other digital standards and digital modulation modes in the same path.

Remote command:

`[:SOURce<hw>] :BB:GENeral:AM[:STATe]` on page 734

Modulation Frequency

Sets the frequency of modulation signal.

Remote command:

`[:SOURce<hw>] :BB:GENeral:AM:FREQuency` on page 733

Modulation Period

Displays the period of the modulation signal.

Remote command:

`[:SOURce<hw>] :BB:GENeral:AM:PERiod` on page 733

Modulation Shape

Displays the shape of the modulation signal.

Remote command:

`[:SOURce<hw>] :BB:GENeral:AM:SHAPE` on page 734

AM Depth

Sets the depth of the modulation signal in percent.

The depth is limited by the maximum peak envelope power (PEP).

Remote command:

`[:SOURce<hw>] :BB:GENeral:AM:DEPTH` on page 733

4.10.2 Pulse modulation configuration and settings

Option: R&S SMCVB-K198

Access:

1. Select "Baseband > Pulse Modulation".

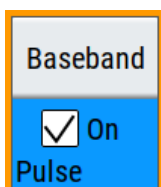

2. If enabled, the baseband block displays "Pulse > On".

Pulse Modulation		X	
State	<input checked="" type="checkbox"/>		
Pulse Mode	Single		
Pulse Period	10.000 µs	Pulse Width	2.000 µs
Transition Type	Fast	Video Polarity	Normal

The tab provides settings necessary to configure pulse modulation.

The remote commands required to define these settings are described in "[PULM commands](#)" on page 736.

Settings:

State.....	243
Pulse Mode.....	243
Pulse Period.....	243
Pulse Width.....	244
Double Pulse Delay.....	244
Double Pulse Width.....	244
Transition Type.....	244
Video Polarity.....	244

State

Activates the standard and deactivates all the other digital standards and digital modulation modes in the same path.

Remote command:

`[:SOURce<hw>] :BB:GENeral:PULM[:STATe]` on page 738

Pulse Mode

Sets the pulse mode.

"Double" The signal consists of a double pulse.

"Single" The signal consists of a single pulse.

Remote command:

`[:SOURce<hw>] :BB:GENeral:PULM:MODE` on page 736

Pulse Period

Sets the pulse period in microseconds.

Remote command:

`[:SOURce<hw>] :BB:GENeral:PULM:PERiod` on page 737

Pulse Width

Sets the pulse width in microseconds.

Remote command:

[\[:SOURCE<hw>\]:BB:GENERAL:PULM:WIDTH](#) on page 737

Double Pulse Delay

Requires "Pulse Mode > Double".

Sets the double pulse delay in microseconds.

Remote command:

[\[:SOURCE<hw>\]:BB:GENERAL:PULM:DOUBLE:DELAY](#) on page 736

Double Pulse Width

Requires "Pulse Mode > Double".

Sets the double pulse width in microseconds.

Remote command:

[\[:SOURCE<hw>\]:BB:GENERAL:PULM:DOUBLE:WIDTH](#) on page 736

Transition Type

Sets the transition type of the pulse modulation signal that is the slew rate (slope).

"Smooth" Flattens the slew rate, resulting in longer rise/fall times. Use this mode if you are working with devices that are sensitive to steep slopes.

"Fast" Enables fast transitions with short rise and fall times.

Remote command:

[\[:SOURCE<hw>\]:BB:GENERAL:PULM:TRANSITION:TYPE](#) on page 737

Video Polarity

Defines the video polarity.

"Normal" The pulse has normal video polarity.

"Inverse" The pulse has inverted video polarity.

Remote command:

[\[:SOURCE<hw>\]:BB:GENERAL:PULM:VIDEO:POLARITY](#) on page 737

4.11 Shifting and boosting the baseband signal

The R&S SMCV100B provides settings to frequency offset the internally generated and externally supplied baseband signal.

4.11.1 About baseband offsets

The applied baseband frequency and phase offset and path gain affect the signal on the output of the corresponding block, "Baseband" or "BB Input". The shifting of the central frequency of the baseband signal is one of the tasks of the resampler.

4.11.1.1 Impact of the frequency offset

For some applications, it is helpful to shift the baseband signal with a user-defined baseband frequency offset to a different center frequency to improve signal characteristics.

The frequency offset function shifts the center frequency of the wanted baseband signal. The function also provides a quick way to shift the used frequency band in the RF frequency domain without modifying the RF settings.

See [Chapter 4.11.3, "How to improve signal characteristics by shifting the baseband signal"](#), on page 248.

Limitations

The complex I/Q bandwidth of the shifted useful signal must not exceed the total available baseband bandwidth (see data sheet). The setting range of the frequency offset is then calculated as follows:

$$-(TotalBasebandBandwidth/2) + f_{use}/2 \leq f_{offset} \leq (TotalBasebandBandwidth/2) - f_{use}/2,$$

where

f_{use} is the complex useful bandwidth of the I/Q signal before the offset

f_{offset} is the frequency offset

The [Figure 4-29](#) illustrates the setting range of the frequency offset.

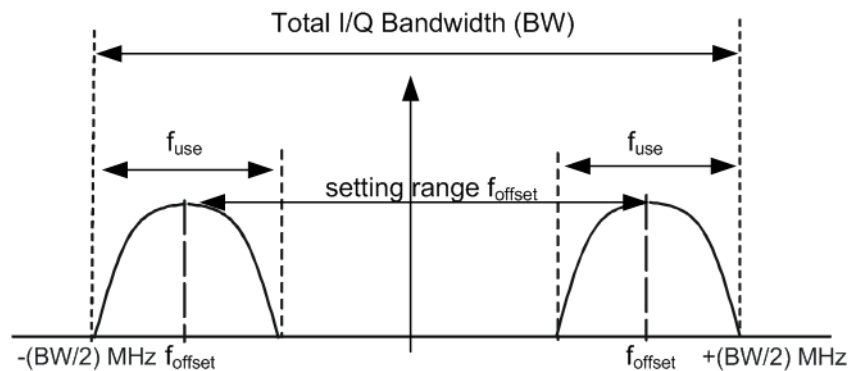

Figure 4-29: Setting range of frequency offset

Example: To calculate the maximum frequency offset

This example uses the following signal:

- Standard: "Baseband > Custom Digital Modulation"
- "Set according to Standard > WCDMA-3GPP"
- "Symbol Rate = 3.84 Msym/s" (3.84 MHz)
- "Filter > Root Cosine"
- "Roll Off Factor = 0.22"

The complex useful bandwidth of filtered signal is calculated as follows (see ["Impact of the filter parameters"](#) on page 96):

- $f_{use} = (1 + \text{"Roll Off Factor"}) * \text{"Symbol Rate"}$
- $f_{use} = (1 + 0.22) * 3.84 \text{ MHz} = 4.6848 \text{ MHz}$

For an instrument with a total available I/Q bandwidth of 160 MHz, the valid range of values for the frequency offset is then:

- $-160 \text{ MHz}/2 + 4.6848 \text{ MHz}/2 \leq f_{offset} \leq 160 \text{ MHz}/2 - 4.6848 \text{ MHz}/2$ or
- $-77.6576 \text{ MHz} \leq f_{offset} \leq 77.6576 \text{ MHz}$

To observe the effect of offsetting the frequency

Use the built-in real-time graphical display ("System Configuration > Graphics > Power Spectrum") and observe the power spectrum of the signal with and without frequency offset:

- See [Chapter 3.3.5, "Verifying the generated signal with the graphics display"](#), on page 53.
- See ["To set and verify a baseband frequency offset"](#) on page 408.

4.11.1.2 Impact of the phase offset

The "Phase Offset" determines the phase offset between the different baseband signals. A phase offset rotates each point of an I/Q constellation diagram by the specified phase offset.

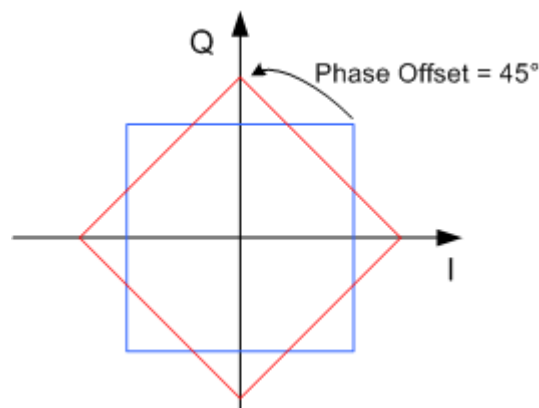

Figure 4-30: I/Q constellation diagram: Effect after offsetting the phase by an angle of 45 °

To observe the effect of offsetting the phase

Use the built-in real-time graphical display ("System Configuration > Graphics > Constellation") and observe that the points on the I/Q constellation diagram are turning counterclockwise.

See [Chapter 10.1, "Displaying baseband signal characteristics in real-time"](#), on page 394.

4.11.2 Baseband offsets settings

Access:

- Select "Baseband > Baseband Offsets" or "BB Input > Baseband Offsets".

The "Baseband Offsets" dialog provides the settings necessary to add frequency and/or phase offset.

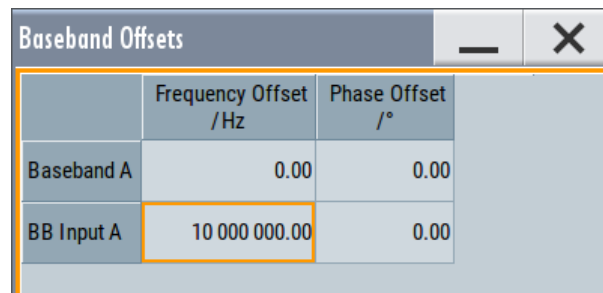

	Frequency Offset /Hz	Phase Offset /°
Baseband A	0.00	0.00
BB Input A	10 000 000.00	0.00

The block diagram shows an icon Δf on the signal path to indicate an applied frequency offset.

Settings:

Frequency Offset	247
Phase Offset	248

Frequency Offset

Enters the frequency offset for the internal or external baseband signal and shifts the useful baseband signal in the center frequency.

Use function, for example, to shift the baseband signal relative to the AWGN signal.

See:

- [Chapter 4.11.1.1, "Impact of the frequency offset"](#), on page 245 for detailed information on the calculation of the frequency offset value range
- [Chapter 4.11.3, "How to improve signal characteristics by shifting the baseband signal"](#), on page 248

Remote command:

`[:SOURce<hw>] :BB:F0FFset` on page 660

`[:SOURce<hw>] :BBIN:F0FFset` on page 660

Phase Offset

Enters the phase offset for the baseband signal (see [Chapter 4.11.1.2, "Impact of the phase offset"](#), on page 246).

The phase offset affects the signal on the "Baseband block" output.

Use this parameter, for example, to change the start phase of the baseband signal.

Remote command:

`[:SOURce<hw>] :BB:POFFset` on page 661

`[:SOURce<hw>] :BBIN:POFFset` on page 661

4.11.3 How to improve signal characteristics by shifting the baseband signal

Shifting of the generated baseband signal is useful in the following cases:

- You analyze the generated signal with a signal analyzer and the displayed signal spectrum indicates a carrier leakage (a signal drop) at the current RF frequency.

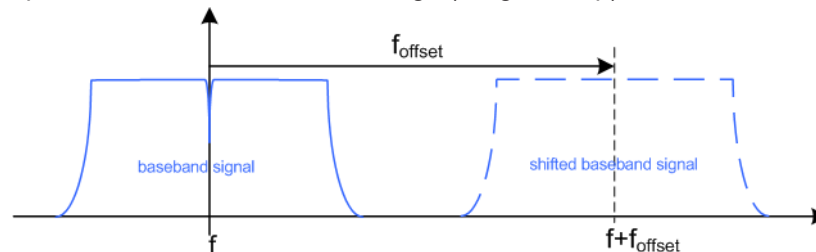

Shifting the baseband signal to a different center frequency can eliminate the carrier leakage problem.

In the following examples, we assume that:

- The R&S SMCV100B generates a baseband signal
- A spectrum analyzer is connected to the R&S SMCV100B, the analyzed is configured and measures the required signal characteristics.

To shift the generated baseband signal

- ▶ Select "Baseband > Baseband Offsets > Frequency Offset" and apply an offset to the generated baseband signal.

To verify characteristics of the generated signal

- ▶ Use the built-in real-time graphical display.
See [Chapter 3.3.5, "Verifying the generated signal with the graphics display"](#), on page 53.

To observe the effect of applied frequency offset and gain

- ▶ Use the built-in real-time graphical display.
See [Chapter 3.3.5, "Verifying the generated signal with the graphics display"](#), on page 53.

5 Configuring external baseband signals

R&S SMCV100B is rarely used as a standalone instrument. Usually, the instrument is connected to a device under test (DUT) or other measurement equipment.

Test setups have different requirements, for example:

- Test setups comprising two or more instruments often require a common reference frequency.
- Generation of beamforming signals requires phase coherent signals.
- Some test setups also require control of the signal generation start and an exact generation start time, for example determined by a defined trigger event.
- In other cases, you would need time-aligned simultaneous signals between multiple instruments.
- etc.

R&S SMCV100B provides several settings that help fulfilling these requirements. This section explains main principles and gives an overview of the related settings and step-by-step instructions.

• Overview of the input and output signals and interfaces	249
• System configuration settings	254
• Digital baseband input settings	267
• I/Q digital output settings	272
• Generating time-aligned baseband signals	278

5.1 Overview of the input and output signals and interfaces

Designed as a signal generator with various application fields, the R&S SMCV100B uses a hardware concept that enables you to define and customize some of the input and output signals and interfaces. Depending on the configuration, digital interfaces can be used as input or output connectors. The different logical settings of the same physical interface are grouped in different dialogs.

Logical signals, streams and channels at the interfaces

This section provides **background information** and introduction to the topics. For an overview of the interfaces and their characteristics, refer to:

- [Chapter 5.1.1, "Overview of the baseband signal sources"](#), on page 250
- [Chapter 5.1.2, "Overview of the baseband and RF output signals"](#), on page 250
- [Chapter 5.1.4, "Important signal parameters and interface's characteristics"](#), on page 251

5.1.1 Overview of the baseband signal sources

The [Table 5-1](#) gives an overview of the available input signals and the connectors they are supplied at. Any of the specified input signals can be processed by the I/Q modulator and output at the RF outputs.

Table 5-1: Physical input signals

Type	Input signal	Input connector	GUI element	Refer to
BB	Internal digital signal	-	"Baseband"	Chapter 4, "Configuring internal baseband signals" , on page 75
BB	External digital signal	Dig. IQ HS 1	"BB Input"	Chapter 5.3, "Digital baseband input settings" , on page 267

Input interface for the external digital baseband signal

The digital interface Dig. IQ HS 1 can be used as input for digital signals. The interface provides direct communication with other Rohde & Schwarz instruments, like:

- Signal generators
- R&S FSW signal and spectrum analyzer
- R&S IQW I/Q wideband recorder

Application examples of the externally supplied digital baseband signal

Provided the instrument is equipped with the required options, the externally applied signals can be used for and further processed as follows:

- Used as a standalone baseband source and processed separately, e.g. detuned, or loaded with noise or directly applied to the I/Q modulator
- Used as a user-specific signal **instead of** the internally generated signal

5.1.2 Overview of the baseband and RF output signals

As shown in [Table 5-2](#), the R&S SMCV100B can output the digital baseband signal at the digital I/Q interface Dig. IQ HS 2 or at the analog RF output connector RF 50 Ω .

Table 5-2: Physical output signals

Type	Output signal	Output connector	GUI element	Refer to
RF	RF signal	RF 50 Ω	"RF"	Chapter 8, "Configuring the RF signal" , on page 302
BB	Digital signal	Dig. IQ HS 2	"I/Q Digital" Dig. IQ HS 2	Chapter 5.4, "I/Q digital output settings" , on page 272

You can only use one output at a time, see [Chapter 5.1.3, "Interdependencies"](#), on page 251.

5.1.3 Interdependencies

The following functions deactivate each other. You can only use one of these functions at a time:

- The internal baseband generator ("Baseband" block) and the external digital baseband input ("BB Input" block)
- The RF output ("RF" block) and the digital I/Q output ("I/Q Digital" block)

5.1.4 Important signal parameters and interface's characteristics

Correct signal processing of the externally supplied input signals in the instrument and correct processing of the output signal in the next connected instrument require information of signal parameters. These signal parameters are sampling rate, crest factor and signal level, expressed as peak or as RMS level value.

Sample rate

The sample rate of the digital input and output signal can be defined manually or automatically retrieved from the input and estimated for the output signal. The bandwidth and thus the sample rate of the digital input signal is not limited by the installed sample rate options.

For more information, see data sheet.

Crest factor

According to its definition, the crest factor gives the difference in level between the peak level and RMS level value in dB (see [Figure 5-1](#)).

The R&S SMCV100B uses the crest factor to calculate the power levels that is the instrument compensates the RMS levels of the externally supplied signal by the crest factor. For example, the crest factor of the external signal is important for the calculation of the RF output power.

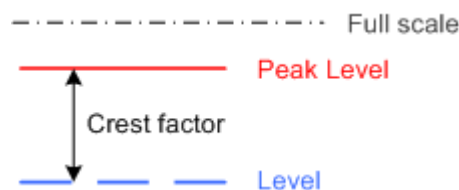

Figure 5-1: Relation between the level settings

Test setups often involve an up-converter connected to the I/Q connectors of the generator or feeding of external signal to the digital input of the R&S SMCV100B. As a rule, whenever an I/Q signal is transferred between two instruments, *the crest factor and the peak levels of the two involved instruments have to be coordinated.*

To ensure proper signal settings and correct results, check if the peak level values and crest factor values are equal. Equal values hold for the I/Q outputs of the R&S SMCV100B and the I/Q inputs of the up-converter are equal.

In the R&S SMCV100B, level values are represented as relative to full-scale values (see [Figure 5-1](#)).



Where to find the necessary values

- Dialog "BB Input"
[Chapter 5.3, "Digital baseband input settings"](#), on page 267
- Dialog "Digital I/Q Out"
[Chapter 5.4, "I/Q digital output settings"](#), on page 272

Why the instrument monitors the signal internally and how to avoid overflow

The R&S SMCV100B constantly monitors the input and output digital signal and indicates an overflow status.

- Overflow of the **input signal** (crest factor and peak level) is indicated if the entered "Peak Level" (in dBFS) value does not correspond to the real value
Tip: The overflow status is indicated as long as the signal level is not reduced and the peak level value corrected. Trigger "Auto Level Set" to collect the required values and adjusts the settings automatically.
- Overflow of the **output signal** is indicated if the digital signal is clipped, i.e. if the level of the output signal, or the noise level (AWGN) are too high.

5.1.4.1 Specific characteristics of the digital I/Q interface

What is a "digital channel" and how are the channels distributed to the basebands

The external digital signals supplied at the Dig. IQ HS x interfaces of the instrument can contain more than one, possibly even multiplexed, digital channels. The R&S SMCV100B processes each of these digital channels as a separate signal.

Fulfilling the prerequisites for a correct signal processing of the externally supplied digital baseband signal

The [Chapter 5.1.4, "Important signal parameters and interface's characteristics"](#), on page 251 emphasizes why and which signal parameters are important for the correct internal signal processing of externally supplied signals in the R&S SMCV100B. This section focuses on the way that these requirements are fulfilled and explains how the instrument deals with signals deviating from the expected values:

- **Crest factor, peak level and RMS level**

These values can be adjusted in one of the following ways:

- Adjusted manually
If you have knowledge about these values, it is best to enter them directly
- Estimated automatically by the internal measurement function
Use the function [Auto Level Set](#) to trigger the R&S SMCV100B to measure the input signal, estimate the peak level and RMS level and calculate the crest factor out of them.

Tip: For a correct signal leveling:

- 1) Enable an appropriate measurement time.
- 2) Execute one measurement for each baseband source.
- 3) Set the measurement period to a time value that is long enough to capture several periods of the input signal.

– Determined automatically

The R&S SMCV100B can receive the values from the connected transmitter. If the external digital signal source is a second Rohde & Schwarz instrument, it signals the peak level and the RMS level of the signal over the digital input interface. To enable the R&S SMCV100B to receive these values, enable the parameter "DIG IQ Auto Setting" on page 272.

In the second automatic way, the R&S SMCV100B adjusts the corresponding input fields with the measured/received values. The internal gain control mechanism uses these received values to adjust the input signal gain to achieve an optimal dynamic range.

- **Sample rate**

External input signals with sample rates different than the system clock are resampled, as illustrated on [Figure 5-2](#).

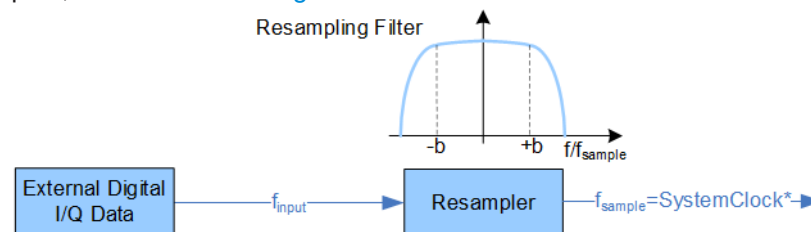

Figure 5-2: Resampling principle of external digital baseband signals

* = Max. sample rate depends on connected device

f_{input} = Max. sample rate

The R&S SMCV100B can process digital signals with sample rate $f_{input} = 400$ Hz to 100 MHz, where the maximum value ($f_{sample, max}$) depends on the capabilities of the connected transmitting/receiving device.

- **Maximum modulation bandwidth**

A baseband signal with a sample rate $f_{sample} < f_{sample, max}$ (i.e. smaller than the used system clock) is interpolated, see [Figure 5-2](#). The resulting modulation bandwidth is calculated as *sample rate* * 0.8.

With a sample rate $f_{sample, max}$ of exactly 600 MSamples/s, the modulation bandwidth is 240 MHz.



Estimating or defining the sample rate

The sample rate of the signal at the digital interface can be determined with one of the following methods:

- **Estimated sample rate**
Enable the instrument to evaluate the received I/Q data clock
- **User-defined sample rate**
Provide both the external signal source and the receiving instrument with a common external reference signal and set the sample rate value.

5.2 System configuration settings

The settings in this dialog comprise the I/Q mapping and the processing of the generated I/Q streams. From this dialog, you can control and configure the connections to instruments connected to the RF and I/Q connectors.

Required options

The equipment layout includes:

- Base unit
- Option digital baseband outputs R&S SMCVB-K19
- Optional, option frequency R&S SMCVB-KB106

Settings:

- [I/Q stream mapper settings](#).....254
- [External RF and I/Q settings](#).....255
- [Overview](#).....266

5.2.1 I/Q stream mapper settings

Access:

- ▶ In the block diagram, select "I/Q Stream Mapper".

I/Q Stream Mapper		External RF and I/Q	Overview		
	Frequency Offs /Hz	Phase Offs /°	RF	Dig. IQ HS 2	
Stream A	0.00	0.00			

The dialog provides the settings for routing of the signal streams to the available output connectors.

Settings:

Frequency Offset.....	255
Phase Offset.....	255
Map Stream X to Connector.....	255

Frequency Offset

Sets an absolute frequency offset f_{offset} .

Tip: Use this parameter to shift the used frequency band in the RF frequency section without modifying the RF settings.

Phase Offset

Sets the phase offset of the corresponding stream.

Map Stream X to Connector

The mapping of the generated stream to the output connectors is represented as a stream matrix. A blue circle at a matrix element routes the stream to the selected connector.

Remote command:

`:SCONfiguration:OUTPut:MAPPING:RF:STReam<st>:STATe` on page 639

`:SCONfiguration:OUTPut:MAPPING:HSDigital:CHANnel<di>:STReam<st>:STATe` on page 639

5.2.2 External RF and I/Q settings

With the settings in the "External RF and I/Q" tab, you can control external devices and instruments from the R&S SMCV100B, if all prerequisites are fulfilled. See "[Prerequisites for control of external instruments from the R&S SMCV100B](#)" on page 255.

**Prerequisites for control of external instruments from the R&S SMCV100B**

The following connections between the R&S SMCV100B and the external instruments are required:

- **Physical remote control connection** over LAN
The remote control connection to the external instruments must be in status **connected**, see [Remote Connection Status](#).
- **Physical signal connection** for the digital I/Q signal
- For the most test setups, the instruments must use a **common reference frequency signal**.

Suitable reference frequency signal sources are:

- An external common reference source
- The distributed reference frequency of the R&S SMCV100B.

Access:

- ▶ Select "Taskbar > System Config > System Configuration > External RF and I/Q".

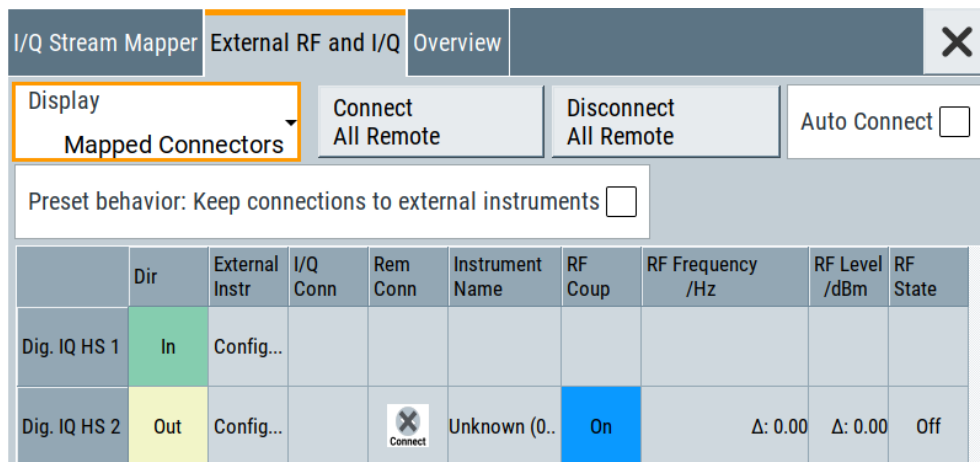

The dialog provides an overview of all available I/Q input and output connectors and comprises the settings necessary to establish the connection to the external instruments. Displayed is an overview of the currently connected external instruments together with relevant information like the connection status and the RF level and frequency that these external instruments use.

The dialog provides access to some additional short information on each of the connected instruments. It also provides a show connector function for an easy localization of the selected connector on the instrument front or rear panel.

Settings:

- [Connections configuration and connection status overview settings](#)..... 256
- [External instrument configuration settings](#)..... 260

5.2.2.1 Connections configuration and connection status overview settings

Access:

- ▶ Select "Taskbar > System Config > System Configuration > External RF and I/Q".

Settings:

[Display](#)..... 257

[Auto Connect](#)..... 257

[Connect/Disconnect All Remote](#)..... 257

[Preset behavior: Keep connections to external instruments](#)..... 258

[Connector Name](#)..... 258

[Direction](#)..... 258

[External Instrument](#)..... 258

[I/Q Connection](#)..... 259

[Remote Connection Status](#)..... 259

[Instrument Name](#)..... 259

RF Couple.....	260
(Delta) RF Frequency/ RF Level.....	260
RF State.....	260

Display

Filters the displayed connectors upon one of the following criteria:

"All Connectors"

No filter is applied.

"Mapped Connectors"

Displayed are only the connectors to which a stream is mapped.

Note: To prevent faults, use this filter before you further configure the external instruments.

"Input Connectors/Output Connectors"

Filters the display according to connector direction.

Remote command:

`:SCONfiguration:EXTernal:DISPlay` on page 640

Auto Connect

With enabled auto connect function, the instrument automatically detects connected external instruments and establishes the required connection.

If the "Auto Connect > Off", however, after a R&S SMCV100B startup you have to revise the test setup and perform the following:

- Check whether the necessary connections between the R&S SMCV100B and the external instruments are still existing.
- Prove that the remote control of the particular instruments is required.
- Trigger the [Connect All Remote](#) function.

Remote command:

`:SCONfiguration:EXTernal:ACONnect` on page 640

Connect/Disconnect All Remote

Triggers the instrument to:

- Establish the remote connections to all configured [External Instruments](#).
- To terminate all existing remote connections.
The external instruments are not removed from the list of external instruments.
Only the remote connection status changes.

Remote connection status can be toggled with the parameter [Remote Connection Status](#).

Note:

External instruments connected to the R&S SMCV100B are preset (`:DEVice:PRESet`) whenever:

- The connection to the external instrument is established or terminated ("Connect/Disconnect All Remote" or "Rem. Conn > On/Off")
- The R&S SMCV100B is preset ([Preset]).

To ensure that the remote connections to the external instruments will be automatically established after instrument's start-up or a reboot, set [Auto Connect](#) > "On".

Remote command:

`:SCONfiguration:EXTernal:REMOte:CONNect[:ALL]` on page 641

`:SCONfiguration:EXTernal:REMOte:DISConnect[:ALL]` on page 641

Preset behavior: Keep connections to external instruments

Sets the effect of R&S SMCV100B preset ([Preset] or *RST) on the following:

- The connection status between the instrument and the connected external instruments.
- The R&S SMCV100B itself and the preset values.
- The connected instruments.

"Preset behavior..."	Off	On
R&S SMCV100B and preset values	Standard R&S SMCV100B preset See Table 11-1 .	
Connection status	Terminated ("Disconnect All Remote")	Unchanged
Connected instruments	External instrument preset (<code>:DEvice:PRESet</code>)	External instrument preset

Remote command:

`:SCONfiguration:EXTernal:PBEHaviour` on page 641

Connector Name



Displays the connector name.

Remote command:

Via keyword in the SCPI syntax, e.g. `HSDigital<ch>`

Direction

Displays the connector direction as a color coded field.

Connector	Direction/Color	Enabled in the "I/Q Stream Mapping"
Dig. IQ HS 1		-
Dig. IQ HS 2		Yes

Remote command:

`:SCONfiguration:EXTernal:HSDigital:DIRection?` on page 641

External Instrument

Accesses a dialog with settings that help you to establish the connection to the external instruments.

Note:

Each external instrument must be connected via LAN the R&S SMCV100B.

In most test setups, all instruments must use a common reference frequency signal, either from an external common reference source or using the distributed reference frequency of the R&S SMCV100B.

I/Q Connection

Depends on the interface type.

- Digital I/Q interfaces:
Indicates the status of the I/Q connection of the digital interfaces.
The indication includes a status LED and an icon for the used connector (Dig. IQ HS 1 and Dig. IQ HS 2) used.

Indication	Designation
● green LED and an icon	The Dig. IQ HS 1 interface is used as an input connector.
● yellow LED and an icon	The Dig. IQ HS 2 interface is used as an output connector.
No icon displayed	No connection

Remote command:

`:SCONfiguration:EXTernal:HSDigital<ch>:IQConnection:STATE?`

on page 641

Remote Connection Status

Indicates the status of the remote connection. Click the status indicator to toggle the remote connection status.

To connect/disconnect all external instruments, use the functions [Connect/Disconnect All Remote](#).

Note:

External instruments connected to the R&S SMCV100B are preset (`:DEVIce:PRESet`) whenever:

- The connection to the external instrument is established or terminated ("Connect/Disconnect All Remote" or "Rem. Conn > On/Off")
- The R&S SMCV100B is preset ([Preset]).

Note: An active "Rem. Conn." and an "RF State > On" do not mean that an I/Q stream is mapped to this connector.

Use the "System Configuration > External Rf and I/Q > Display > Mapped Connectors" filter to list only the connectors with a mapped I/Q stream.

Remote command:

`:SCONfiguration:EXTernal:HSDigital:REMote:DISConnect` on page 647

`:SCONfiguration:EXTernal:HSDigital:REMote:INFO?` on page 647

Instrument Name

Displays useful information on the connected external instrument, like the instrument designation and the RF path the RF settings are coupled to.

Remote command:

`:SCONfiguration:EXTernal:HSDigital<ch>:INAME?` on page 642

`:SCONfiguration:EXTernal:HSDigital:REMote:INFO?` on page 647

RF Couple

If enabled, this parameter couples all major RF setting (like the "RF Frequency", the "RF Level" and the "RF State") of the external instrument to the R&S SMCV100B.

The R&S SMCV100B acts as a primary instrument, i.e the external instruments synchronize their settings and the RF output state to the R&S SMCV100B. You can apply delta frequency and level offset to the signal.

Remote command:

`:SCONfiguration:EXTernal:HSDigital:RF:COUpling` on page 642

(Delta) RF Frequency/ RF Level

In uncoupled mode, sets the RF frequency and RF level of the external instrument.

With enabled "RF Coupled" parameter, applies a frequency and level offset. The RF frequency of the external instrument is calculated as follows:

$$RF_{ExtInstr} = RF_{Instrument} + \Delta_{Freq}$$

Both the RF frequency and the RF frequency offset are applied at the external instrument.

Remote command:

`:SCONfiguration:EXTernal:HSDigital:RF:FREQuency` on page 643

`:SCONfiguration:EXTernal:HSDigital:RF:FREQuency:OFFSet` on page 643

`:SCONfiguration:EXTernal:HSDigital:RF:POWer` on page 643

`:SCONfiguration:EXTernal:HSDigital:RF:POWer:OFFSet` on page 643

RF State

With enabled "RF Coupled" parameter, displays the RF output state of the connected external instrument. The parameter is coupled to the state of the RF output of the R&S SMCV100B.

In uncoupled mode, enables/disables the RF output in the external instrument.

Remote command:

`:SCONfiguration:EXTernal:HSDigital:RF:STATe` on page 644

5.2.2.2 External instrument configuration settings

Access:

1. Select "Taskbar > System Config > System Configuration > External RF and I/Q".
2. Navigate to the required connector.
Select "External Instruments > Config ...".

The "<Dig. Conn. Name>: External Instrument Configuration" dialog opens and displays the "External Instrument Configuration > Remote Config" settings.

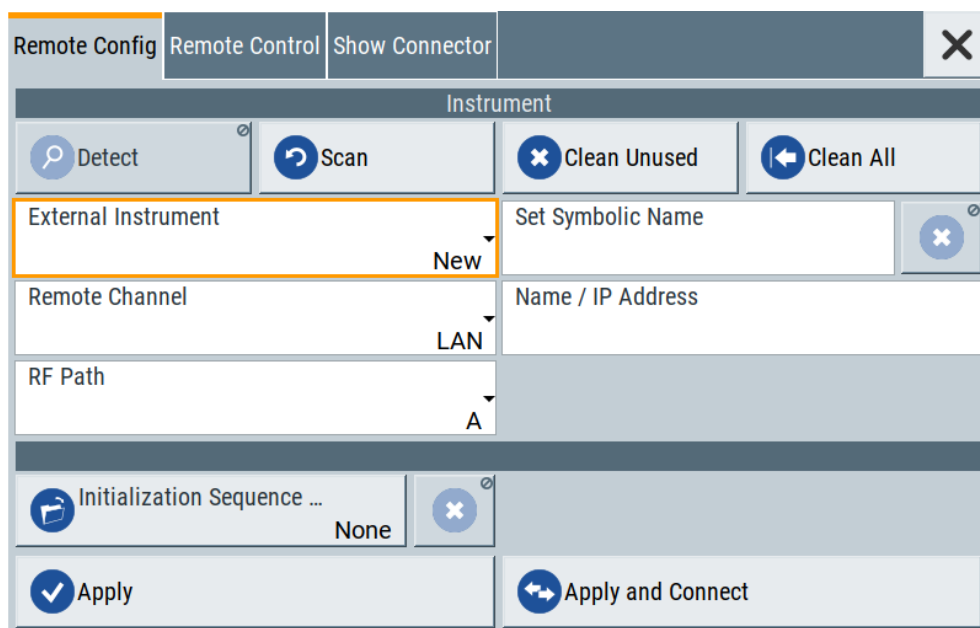

Settings:

Remote config settings.....261

Remote control settings..... 264

Show connector..... 266

Remote config settings

Access:

- ▶ Select "Taskbar > System Config > System Configuration > External RF and I/Q > External Instruments > Config ...".

Settings:

Detect/Scan.....262

Clean Unused/Clean All.....262

External Instrument.....262

Set Symbolic Name.....263

Remote Channel..... 263

Hostname or IP Address.....263

Device ID.....263

RF Path.....263

Initialization Sequence.....263

Remove Initialization Sequence.....264

Apply.....264

Apply and Connect.....264

Detect/Scan

If you connect an external instrument, you can fill in the required information in the "External Instrument Configuration" dialog manually or use one of the provided "Detect/Scan" functions. Both functions consider the connections via the supported interfaces, USB or LAN.

The parameter [External Instrument](#) lists the pool of available instruments.

Scans the network for connected supported instruments, like:

R&S SMW equipped as wideband instrument (R&S SMW-B9)

Note: The scan function searches throughout the entire network and can last several minutes.

Note: The first initialization of an instrument connected to a network can last several minutes. During their initialization, instruments are not detected by the detect/scan function.

"Detect" Searches for external instruments connected to this particular digital interface of the R&S SMCV100B.

Remote command:

`:SCONfiguration:EXTernal:HSDigital<ch>:REMote:DETECT?` on page 646

"Scan" Scans the network for connected supported instruments, like:

Note: The scan function searches throughout the entire network and can last several minutes.

Remote command:

`:SCONfiguration:EXTernal:REMote:SCAN` on page 644
`:SCONfiguration:EXTernal:REMote:SCAN:STATe?`
 on page 644

Clean Unused/Clean All

Triggers the instrument to clean at once all unused LAN connections. This function allows you to retrieve a new pool of valid instruments.

The "Clean All" function removes all configured settings from the "External RF and I/Q". USB connections to external instruments are not affected.

Remote command:

`:SCONfiguration:EXTernal:REMote:PURGe` on page 648
`:SCONfiguration:EXTernal:REMote:CLEan` on page 648

External Instrument

Lists all available instruments, found by the [Detect/Scan](#) function.

To connect an external instrument, use one of the following:

- Enable "Select Instrument > New" and configure the settings manually
- Select "Select Instrument", navigate through the pool of available instruments, and select the required. The required settings are retrieved and updated automatically.

Select "None" to disable the connection.

Execute "Apply" to confirm the settings.

Remote command:

[:SCONfiguration:EXTernal:REMote:LIST?](#) on page 645

[:SCONfiguration:EXTernal:REMote:ADD](#) on page 645

[:SCONfiguration:EXTernal:HSDigital:REMote:ISElect](#) on page 646

Set Symbolic Name

Sets the alias name of the instrument.

Remote command:

[:SCONfiguration:EXTernal:REMote:ADD](#) on page 645

[:SCONfiguration:EXTernal:HSDigital:REMote:INFO?](#) on page 647

Remote Channel

Selects the hardware channel (USB or LAN) used by the remote channel to the external instrument.

Remote command:

[:SCONfiguration:EXTernal:REMote:ADD](#) on page 645

[:SCONfiguration:EXTernal:HSDigital:REMote:INFO?](#) on page 647

Hostname or IP Address

Displays/sets the hostname or IP address of the connected external instrument.

Remote command:

[:SCONfiguration:EXTernal:REMote:ADD](#) on page 645

[:SCONfiguration:EXTernal:HSDigital:REMote:INFO?](#) on page 647

Device ID

Sets/displays the device identifier that is a unique string with the following structure:

<frontend type>-<serial number>

For a defined "External Instrument", the information is read out automatically.

Remote command:

[:SCONfiguration:EXTernal:REMote:ADD](#) on page 645

RF Path

In a two-path instrument, determines the RF output to be used.

Remote command:

[:SCONfiguration:EXTernal:REMote:ADD](#) on page 645

[:SCONfiguration:EXTernal:HSDigital:REMote:INFO?](#) on page 647

Initialization Sequence

Accesses the standard "File Select" dialog for loading an existing initialization file (extension *.iec).

When you establish the connection to an external instrument, i.e. [Remote Connection Status](#) is active, the R&S SMCV100B performs the following:

- Sends the command [:DEVICE:PRESet](#)
- Sends the content of the initialization sequence file to reconfigure the external instrument

If necessary, perform further settings and configuration of the external instruments.

Remote command:

`:SCONfiguration:EXTernal:REMote:INITialization:CATalog?`

on page 647

`:SCONfiguration:EXTernal:HSDigital:REMote:INITialization:FILE`

on page 648

Remove Initialization Sequence

Deletes the loaded sequence.

Apply

Confirms the settings and displays the external instrument in the "External RF and I/Q" dialog.

Remote command:

`:SCONfiguration:EXTernal:HSDigital:REMote:ISElect` on page 646

Apply and Connect

Confirms the settings and triggers the connection establishment. In the connected instruments, the status of this active remote connection is displayed by the "Remote" indication.

Remote command:

`:SCONfiguration:EXTernal:HSDigital:REMote:ISElect` on page 646

`:SCONfiguration:EXTernal:HSDigital:REMote:CONNECT` on page 646

Remote control settings

Access:

1. Select "Taskbar > System Config > System Configuration > External RF and I/Q".
2. Navigate to the required connector.
Select "External Instruments > Config ...".

- In the "<Dig. Conn. Name>: External Instrument Configuration" dialog, select "Remote Control".

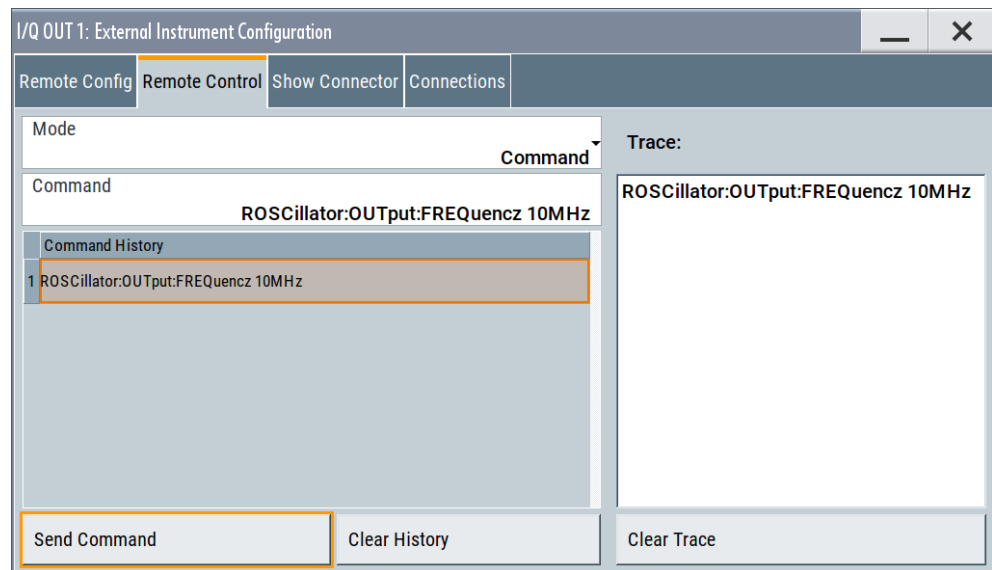

In this dialog, you can send individual SCPI commands or a sequence of SCPI commands to the connected instruments.

The sent commands and their results are displayed in the "Command Trace" field, as long as the trace is not deleted "Clear Trace". The sent commands are also listed in the "History" list. As long as this history list is not deleted ("Clear History"), you can select a command from the list and send it again.

Settings:

Mode.....	265
Command, Send Command.....	265
File, Sequence, Send Sequence.....	266
History, Clear History.....	266
Commands Trace, Clear Trace.....	266

Mode

You can send a single command ("Command") or a command sequence ("Sequence") to the connected instrument.

Command, Send Command

Entry field for the SCPI commands.

You can enter a new command or select a previously sent command from the "History".

If the remote connection is active, select "Send Command" to execute the command.

Remote command:

:SCONfiguration:EXTernal:HSDigital<ch>:REMote:SEND on page 648

File, Sequence, Send Sequence

Accesses the standard "File Select" dialog for loading of user-defined files with extension *.iec.

The provided navigation possibilities in the dialog are self-explanatory.

When a file is selected, its name and content are displayed, and the first command is selected. You can send the commands one by one ("Send Command") or send the entire sequence at once ("Send Sequence").

After a command is sent, the next command from the sequence is selected.

See also "[Initialization Sequence](#)" on page 263.

History, Clear History

List of the sent commands.

As long as this history list is not cleared ("Clear History"), you can select a command from the list and send it again.

Commands Trace, Clear Trace

List of the sent commands and their results, where the results are displayed in blue color.

To delete the trace, select "Clear Trace".

Show connector

Access:

1. Select "Taskbar > System Config > System Configuration > External RF and I/Q".
2. Navigate to the required connector.
Select "External Instruments > Config ...".
3. In the "<Dig. Conn. Name>: External Instrument Configuration" dialog, select "Show Connector".

The dialog displays the location of the selected connector.

The "Show Connector" function triggers the instrument to identify the connector on the rear panel. The LED next to the selected connector blinks.

5.2.3 Overview

You can check current connections, interfaces, input signals and output signals of the R&S SMCV100B in the "Overview" tab.

Access:

- ▶ Select "System Configuration" > "Overview".

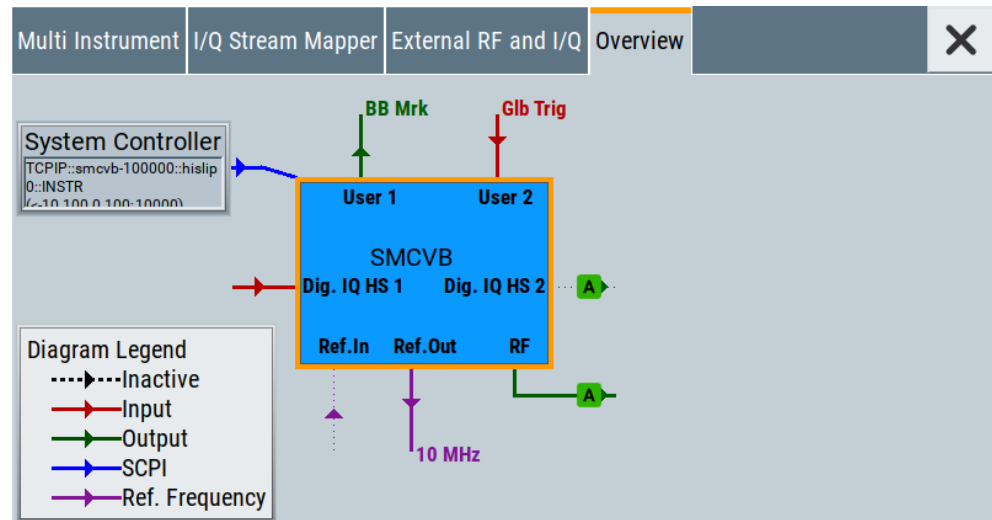

The overview tab shows information on the following:

- Input signals and output signals: Type (RF, reference, HS Dig IQ, User 1/2) and state (active, inactive)
- Input and output interfaces
- Current stream mapping to the output interfaces.
See [Chapter 5.2.1, "I/Q stream mapper settings"](#), on page 254.
- Connected controller ("System Controller") and connection ("SCPI").
See [Chapter 5.2.2, "External RF and I/Q settings"](#), on page 255.
- Connections for remote control of connected external devices

Hotspots for fast access to the required settings

Several of the displayed elements are hotspots. Select an element to access the related dialog.

5.3 Digital baseband input settings

The R&S SMCV100B provide the Dig. IQ HS 1 interface to feed an **external digital baseband signal** into the signal path.

Required options

The equipment layout for applying an external baseband signal includes:

- Base unit
- Option frequency R&S SMCVB-B103
- Option digital baseband input/output R&S SMCVB-K19
(incl. the digital interface Dig. IQ HS 1 used as input)

For more information, see data sheet.

To access and configure the "Baseband Input" settings

The **"BB Input"** block provides access to the settings for frequency offset and path gain, and to the available configuration parameters of the external signal.

The digital baseband input interface **Dig. IQ HS 1** is located on the R&S SMCV100B rear panel, see [Chapter 5.1, "Overview of the input and output signals and interfaces"](#), on page 249.

In the default instrument state, the block diagram displays the connector in an unfolded state. The digital input interface is inactive.

1. To fold out the **"BB Input"** block, select the connector symbol.

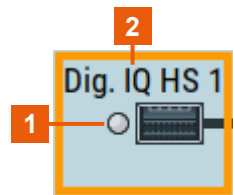
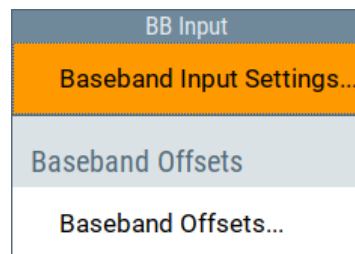

Figure 5-3: Representation of the digital baseband input interface Dig. IQ HS 1

1 = Digital input interface state: gray = inactive; blue = active
2 = Connector name

If you click on "BB Input", you can access frequency offset settings or baseband input settings.



2. To access the frequency offset settings, select "BB Input > Baseband Offsets". See [Chapter 4.11, "Shifting and boosting the baseband signal"](#), on page 244.
3. To access the dialog box for configuring the external signal input, select "BB Input > Digital I/Q In > Baseband Input Settings".

The "Baseband Input Settings" dialog provides settings necessary to define the used connector. Also, it provides settings to adjust the signal parameters, like the sample rate and the baseband input level.

In this dialog, you access the settings of the Dig. IQ HS 1 connector.

4. To set the input connector, select "BB Input > General > Interface > Dig. IQ HS x"
5. To enable the input signal, try one of the following:
 - Select "BB Input > On".
 - Select "BB Input > Baseband Input Settings > State > On".

The remote commands required to define these settings are described in [Chapter 14.16.2, "SOURce:BBIN subsystem"](#), on page 653.

Settings:

- [General settings](#).....269
- [Signal input settings](#).....270

5.3.1 General settings

Access:

- ▶ Select "BB Input > Digital I/Q In > Baseband Input Settings".

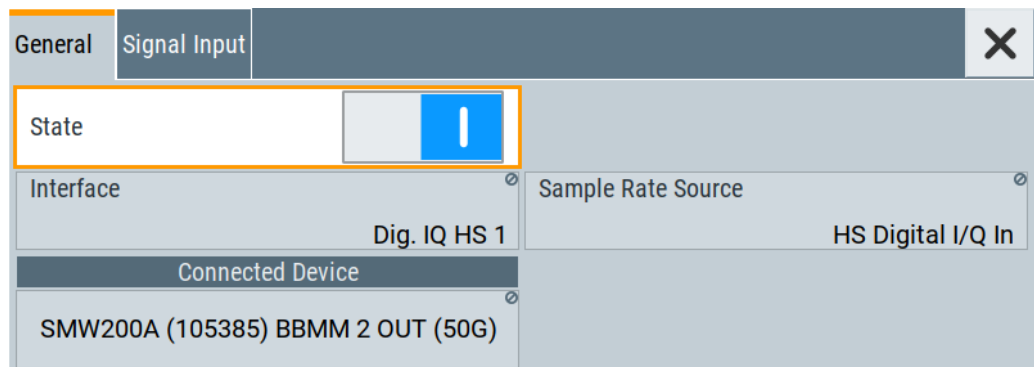

Settings:

- [State](#).....269
- [Interface](#).....269
- [Sample Rate Source](#).....269
- [Connected Device](#).....270

State

Enables the feeding of the selected external digital signals into the baseband.

Remote command:

[\[:SOURce<hw>\]:BBIN:STATe](#) on page 654

Interface

Displays the digital interface for input, that is Dig. IQ HS 1.

Remote command:

[\[:SOURce<hw>\]:BBIN:DIGital:INTERface](#) on page 654

Sample Rate Source

Indicates the digital interface used to estimate the sample rate.

"HS Digital I/Q In"

Estimates the sample rate value based on the information transmitted by the transmitter.

Resulting value per channel is displayed by the parameter [Sample Rate](#).

Remote command:

[:SOURce<hw>] :BBIN:SRATe:SOURce on page 657

Connected Device

If the connection to the external device is properly established and signal transmission is active, this parameter displays information on the instrument connected to the Dig. IQ HS 1 interface:

- Name and serial number of the connected instrument
- The transmitter sample rate, if supported by the transmitter

"None" indicates that no device is connected.

Remote command:

[:SOURce<hw>] :BBIN:CDEvice? on page 655

5.3.2 Signal input settings

Access:

1. Select "BB Input > Digital I/Q In > Baseband Input Settings > Interface = HS DIG I/Q".
2. Select "Signal Input".

Name	Sample Rate / MHz	Crest Factor / dB	Peak Level / dBFS	Level / dBFS	BB
0 BBMM2_CH0	100.000 000 000	10.87	0.00	-10.87	

Aggregated Link Sample Rate (MHz): 100.00 / 300.00

DIG IQ Auto Setting

Measurement Period Auto Level Set

2 s

Settings:

[Channel Table](#)..... 271

 L [Number](#)..... 271

 L [Name](#)..... 271

 L [Sample Rate](#)..... 271

 L [Crest Factor](#)..... 271

L Peak Level.....	271
L Level.....	271
L BB.....	271
Aggregated Link Sample Rate.....	272
DIG IQ Auto Setting.....	272
Measurement Period.....	272
Auto Level Set.....	272

Channel Table

Displays information on the up to 8 digital channels at the Dig. IQ HS 1 interface:

Number ← Channel Table

Subsequent number.

Name ← Channel Table

Channel indication, set by the transmitter.

Remote command:

[:SOURce<hw>] :BBIN:CHANnel<ch0>:NAME on page 655

Sample Rate ← Channel Table

Indicates the used sample rate per channel.

For information on the max. sample rate and the aggregated sample rate, depending on the number of active channels, observe the indication [Aggregated Link Sample Rate](#).

Remote command:

[:SOURce<hw>] :BBIN:CHANnel<ch0>:SRATe on page 656

Crest Factor ← Channel Table

If [DIG IQ Auto Setting](#) > "Off", sets the crest factor per channel.

Remote command:

[:SOURce<hw>] :BBIN:CHANnel<ch0>:POWer:CFACTOR on page 656

Peak Level ← Channel Table

If [DIG IQ Auto Setting](#) > "Off", sets the peak level per channel. The value is set as attenuation in digital baseband domain.

Remote command:

[:SOURce<hw>] :BBIN:CHANnel<ch0>:POWer:PEAK on page 656

Level ← Channel Table

Indicates the level, set automatically depending on the selected peak level and crest factor.

Remote command:

[:SOURce<hw>] :BBIN:CHANnel<ch0>:POWer:RMS on page 656

BB ← Channel Table

Activates the channel.

You can only activate one channel at a time. Toggle the state of the channel to test all channels one after another.

Remote command:

`[:SOURce<hw>] :BBIN:CHANnel<ch0> :BB:STATe` on page 655

Aggregated Link Sample Rate

Indicates the aggregated sample rate and the maximum sample rate, where:

- The aggregated sample rate is the sum of the sample rates of all active channels. It cannot exceed the maximum sample rate.
- The R&S SMCV100B supports two standard max. sample rate values. This parameter indicates the currently selected one, where the max. sample rate is selected depending on the capabilities of the transmitter/receiver.

For more information, see data sheet.

Remote command:

`[:SOURce<hw>] :BBIN:SRATe:SUM?` on page 657

`[:SOURce<hw>] :BBIN:SRATe:MAX?` on page 658

DIG IQ Auto Setting

Activates an automatic adjustment of the baseband input signal.

The R&S SMCV100B receives peak level, level and crest factor values directly from the connected transmitter and recognizes changes automatically.

Remote command:

`[:SOURce<hw>] :BBIN:DIGital:ASETting:STATe` on page 658

Measurement Period

Sets the recording duration for measuring the baseband input signal by "Auto Level Set".

Note: For accurate level measurements, set the measurement period to a time value that is long enough to capture several periods of the input signal.

Remote command:

`[:SOURce<hw>] :BBIN:MPERiod` on page 658

Auto Level Set

Starts measuring the input signal for estimating the crest factor, the peak level, and the Level of the input signal.

Remote command:

`[:SOURce<hw>] :BBIN:ALEVel:EXECute` on page 659

5.4 I/Q digital output settings

Required options

The equipment layout for output of a baseband signal includes:

- Base unit

- Option digital baseband input/output R&S SMCVB-K19 (incl. the digital interface Dig. IQ HS 2 used as output)



The current firmware does not support output of baseband signal at the Dig. IQ HS 2 interface.

For more information, see data sheet.

To access and configure the "I/Q Digital Output" settings

The connector is located on the [rear panel](#).

In the default instrument state, the block diagram displays the Dig. IQ HS 2 connector in a folded state. The digital output interface is inactive (gray LEDs).

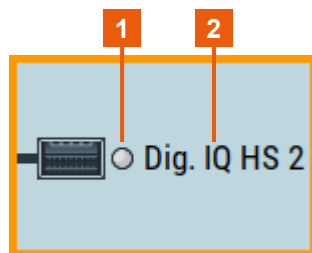

Figure 5-4: Unfolded view of the digital output interface Dig. IQ HS 2

1 = Digital output interface state: gray = inactive; blue = active
2 = Digital output connector name

1. Select the Dig. IQ HS 2 symbol to unfold the "I/Q Digital" block.
You access the settings of the Dig. IQ HS 2 connector.
2. To access the dialog box for configuring the digital output signal, select "I/Q Digital > I/Q Digital Out".

The remote commands required to define these settings are described in [Chapter 14.16.8.1, "SOURCE:IQ:OUTPut:DIGital commands"](#), on page 766.

5.4.1 General settings

Access:

- ▶ Select "I/Q Digital > I/Q Digital Out".

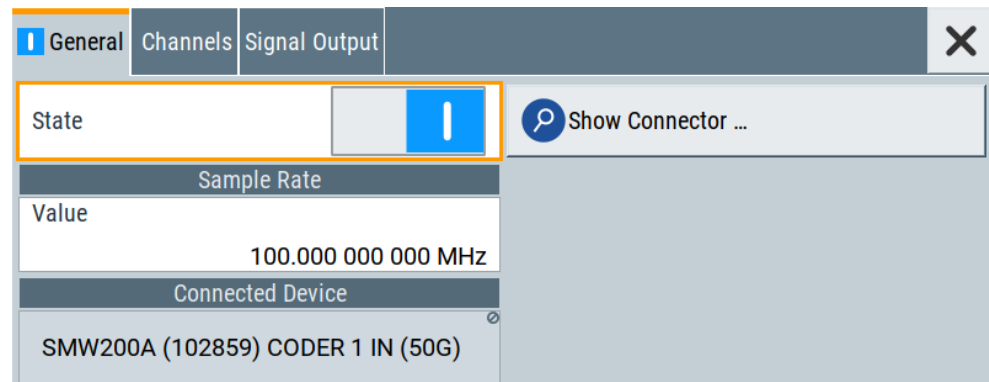
**Settings:**

State.....	274
Show Connector.....	274
Value.....	274
Connected Device.....	274

State

Displays the digital I/Q output state, that is deactivated.

Remote command:

[\[:SOURce<hw>\]:IQ:OUTPut:DIGital:STATe](#) on page 767

**Show Connector**

Accesses a dialog that displays the physical location of the selected connector on the front/rear panel of the instrument.

A blinking LED on the front/rear panel indicates the selected connector, too (see [Chapter 12.2.2.3, "Status indicators"](#), on page 450).

Value

Sets/displays the sample rate of the digital I/Q output signal. The maximal sample rate depends on the connected receiving device.

Remote command:

[\[:SOURce<hw>\]:IQ:OUTPut:DIGital:SRATe](#) on page 768

Connected Device

If the connection to the external device is properly established and signal transmission is active, this parameter displays information on the instrument connected to the Dig. IQ HS 1 interface:

- Name and serial number of the connected instrument
- The transmitter sample rate, if supported by the transmitter

"None" indicates that no device is connected.

Remote command:

[\[:SOURce<hw>\]:IQ:OUTPut:DIGital:CDEvice?](#) on page 768

5.4.2 Channels settings

Access:

- ▶ Select "I/Q Digital > I/Q Digital Settings > Channels".

Name	Stream	Sample Rate / MHz	Active
0	CH0	A	100.000 000 000

Aggregated Link Sample Rate (MHz): 100.00 / 300.00

The channels are displayed in table form, where the number of rows corresponds to the number of channels.

Settings:

Number.....	275
Name.....	275
Stream.....	275
Sample Rate.....	275
Peak Level.....	275
Level.....	276
Active.....	276
Aggregated Link Sample Rate.....	276

Number

Subsequent number.

Name

Sets the name of the channel of the used interface.

Remote command:

`[:SOURce] :IQ:OUTPut:DIGital:CHANnel<st0>:NAME` on page 770

Stream

Indicates the streams that are routed to the channel.

Sample Rate

Sets the sample rate per channel.

For information on the max. sample rate and the aggregated sample rate, depending on the number of active channels, observe the indication [Aggregated Link Sample Rate](#).

Remote command:

`[:SOURce] :IQ:OUTPut:DIGital:CHANnel<st0>:SRATE` on page 770

Peak Level

Setting this parameter requires "Set Level Via > Peak Level".

Sets the peak level of the output signal relative to full scale of 0.5 V (in terms of dB full scale).

Option: R&S SMCVB-B9/-K19

Parameter is read-only in the configuration "Mode > Advanced" and "Signal Outputs > Analog&Digital".

Remote command:

For the output signal of a channel of the Dig. IQ HS x interfaces:

[\[:SOURCE\]:IQ:OUTPut:DIGital:BBMM<ch>:CHANnel<st0>:POWer:PEP](#)

on page 768

Level

Setting this parameter requires "Set Level Via > Level".

Sets the RMS level of the output signal relative to full scale of 0.5 V (in terms of dB full scale).

Remote command:

For the output signal of a channel of the Dig. IQ HS x interfaces:

[\[:SOURCE\]:IQ:OUTPut:DIGital:BBMM<ch>:CHANnel<st0>:POWer:LEVel](#)

on page 769

Active

Activates the channel.

Remote command:

[\[:SOURCE\]:IQ:OUTPut:DIGital:CHANnel<st0>:STATe](#) on page 771

Aggregated Link Sample Rate

Indicates the aggregated sample rate and the maximum sample rate, where:

- The aggregated sample rate is the sum of the sample rates of all active channels. It cannot exceed the maximum sample rate.
- The R&S SMCV100B supports two standard max. sample rate values. This parameter indicates the currently selected one, where the max. sample rate is selected depending on the capabilities of the transmitter/receiver.

For more information, see data sheet.

Remote command:

[\[:SOURCE\]:IQ:OUTPut:DIGital:SRATe:SUM?](#) on page 771

[\[:SOURCE\]:IQ:OUTPut:DIGital:SRATe:MAX?](#) on page 771

5.4.3 Signal output settings

Access:

- ▶ Select "I/Q Digital > I/Q Digital Settings > Signal Output".

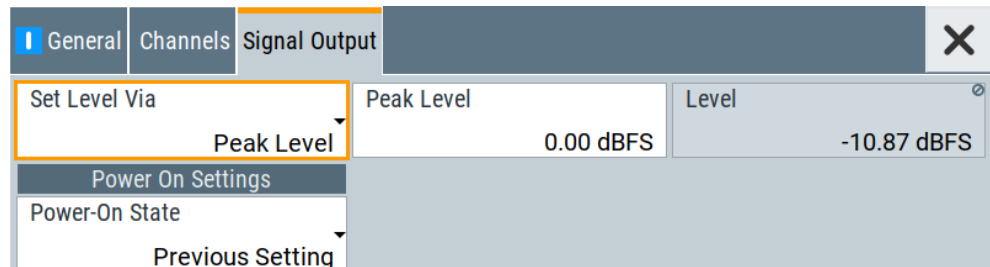

The tab comprises settings necessary to configure the I/Q digital signal output parameters.

Settings:

Signal output level settings.....	277
L Set Level Via.....	277
L Peak Level.....	277
L Level.....	278
Power-On State.....	278

Signal output level settings

Comprises the level settings of the digital IQ output signal. The signal level is expressed as a peak or RMS level value.

Note: The "Level" display always refers to both signal components, i.e. $SQR(I^2+Q^2)$.

Set Level Via ← Signal output level settings

Selects whether the signal level is expressed as a peak or as RMS level value.

Remote command:

`[:SOURce] :IQ:OUTPut:DIGital:POWer:VIA` on page 768

Peak Level ← Signal output level settings

Setting this parameter requires "Set Level Via > Peak Level".

Sets the peak level of the output signal relative to full scale of 0.5 V (in terms of dB full scale).

Option: R&S SMCVB-B9/-K19

Parameter is read-only in the configuration "Mode > Advanced" and "Signal Outputs > Analog&Digital".

Remote command:

For the output signal of a channel of the Dig. IQ HS x interfaces:

`[:SOURce] :IQ:OUTPut:DIGital:BBMM<ch>:CHANnel<st0>:POWer:PEP`
on page 768

Level ← Signal output level settings

Setting this parameter requires "Set Level Via > Level".

Sets the RMS level of the output signal relative to full scale of 0.5 V (in terms of dB full scale).

Remote command:

For the output signal of a channel of the Dig. IQ HS x interfaces:

`[:SOURce] :IQ:OUTPut:DIGital:BBMM<ch>:CHANnel<st0>:POWer:LEVel`

on page 769

Power-On State

Selects the state which the I/Q digital output connector Dig. IQ HS 2 is to resume after the instrument is switched on.

"I/Q Out Off" On power-on, the output is deactivated.

"Previous Setting"

Resumes the state that was active before the last switch off.

Remote command:

`[:SOURce<hw>] :IQ:OUTPut:DIGital:PON` on page 770

5.5 Generating time-aligned baseband signals

In test setups that combine the signal of two or more instruments it is often required that:

- The signal generation starts at a defined moment
- The signal generation starts simultaneously (or with an exactly defined delay) in all involved instruments.

One possible way to achieve quasi-simultaneous signal start is to trigger the instruments by the same trigger event, for example from a **common trigger source**.

Because of the trigger signal propagation time and the signal processing time, however, this method does not achieve precise time aligned signals.

To generate **synchronous and time aligned signals** with multiple instruments, use the primary-secondary instrument mode.

This section explains how to use the provided settings to define the signal generation start in the basebands of **multiple instruments**.

- [Triggering several instruments with a common trigger signal](#).....278

5.5.1 Triggering several instruments with a common trigger signal

Using the same trigger event on several instruments is useful to synchronize the transmitted and received signals. Some test cases also require that you control the signal generation start and determine the exact generation start time by a defined trigger event. The signal generation start can be controlled, for example, by triggering the instrument internally or externally from the DUT.

To share common trigger signal:

- Let the primary instrument R&S SMCV100B#1 generate a dedicated signal that triggers all R&S SMCV100B instruments.
See [Example "Triggering several R&S SMCV100B instruments simultaneously"](#) on page 279.
- Connect all instruments to a common external trigger source.

See [Chapter 3.3.4, "Enabling and configuring a marker signal"](#), on page 51.

Example: Triggering several R&S SMCV100B instruments simultaneously

This example shows you how to trigger the several R&S SMCV100B instruments simultaneously. Also, it shows, how to connect several R&S SMCV100B instruments and distribute the trigger signal generated by a primary instrument.

Required cabling and connections:

- Connect the instruments in a star network, concerning the trigger signal.
That is, connect the "User 1" output of the R&S SMCV100B#1 to the "User 2" input of all R&S SMCV100B instruments and the R&S SMCV100B#1 itself.
- Always use cables of the same length. Use cables that are as short as possible.

Required configurations at the R&S SMCV100B#1:

- Set the following for "User 1" connector: "System Config." > "Setup" > "Global Connectors" > "User 1" > "Direction" > "Output". The output signal is the marker signal "Baseband Marker".
- Select "Baseband" > "<Digital_Standard>" > "Trigger In" > "Trigger Source" > "External Global Trigger".

Required configurations at all R&S SMCV100B instruments:

- Use the default settings for the "User 2" connector: "Direction" > "Input" and "Signal" > "Global Trigger".
- Select "Baseband" > "<Digital_Standard>" > "Trigger In" > "Trigger Source" > "External Global Trigger".

To trigger the signal generation from the R&S SMCV100B#1, select "Execute Trigger".

The R&S SMCV100B#1 generates a short high signal and outputs it at the "User 1" connector. The signal acts as a common external trigger signal for all R&S SMCV100B instruments and all basebands.

6 Adding noise to and impairing the signal

The test case scenarios in accordance with the specifications often require a not "clean" signal but rather a signal that is impaired or interfered. To fulfill such requirements, the R&S SMCV100B is equipped with a noise generator and provides the possibility to impair the digital I/Q signal.

This section describes the following functions:

- [Adding noise to the signal](#).....280
- [Impairing the signal](#).....294

6.1 Adding noise to the signal

This section introduces the concept of the AWGN generator (Additive White Gaussian Noise). The section also describes the settings for generation of noise, sine wave interferer, and adding noise to the generated signal.

6.1.1 Required options

The equipment layout for generating an AWGN signal includes:

- Base unit
- Option Noise Generator (R&S SMCVB-K62)

6.1.2 About the AWGN generator

Provided the required options are installed, the R&S SMCV100B allows you to superimpose noise on the generated signal. The built-in internal noise generator generates an AWGN signal (Additive White Gaussian Noise) with selectable bandwidth and adds it to the digital baseband signal. The main characteristic of this kind of noise signal is the Gaussian distribution of the noise power density and uniform frequency distribution.

Generation of the AWGN signal

The Gaussian noise is generated with a feedback shift register with subsequent probability transformation. The switching configuration is such that ideal statistical characteristics are achieved:

- I and Q paths are decorrelated from each other.
- Small probabilities are ensured via the crest factor of ~15 dB
- The period of the noise signal is relatively long and depends on the selected system bandwidth.
- Scalable lowpass filters are used to produce a noise level with both a broad dynamic range and a broad bandwidth range.

AWGN modes

The AWGN generator generates signal in one of the following different modes:

- **"Additive Noise"**: the generated noise signal superimposes the interference-free useful signal



- **"Noise Only"**: a pure noise signal is generated and modulated to the carrier; the connection to the baseband is interrupted.

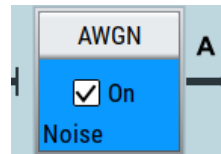
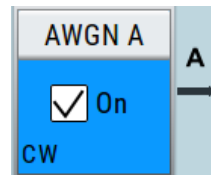

Figure 6-1: Representation of an AWGN > Mode > Noise Only in the block diagram

- **"CW Interferer"**: a sinusoidal signal with an adjustable frequency offset and carrier-to-interferer (C/I) power ratio is added to the baseband signal.



Signal and noise parameters

The Figure 6-2 illustrates the relation between the signal and noise parameters.

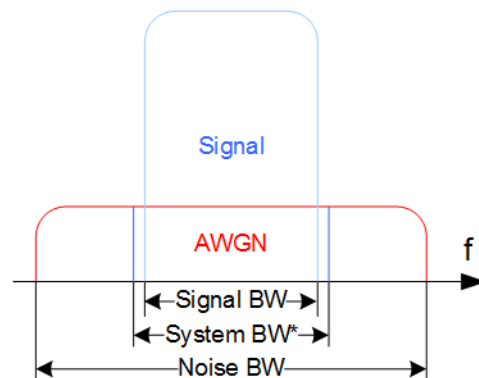

Figure 6-2: Graphical representation of the relation between system bandwidth and noise bandwidth (Minimum Noise/System BW = 2)

System BW* = Occupied BW

The **system bandwidth** is a measure for the transmitted RF bandwidth. The selected value is usually the occupied bandwidth and is therefore a value greater than the pure signal bandwidth.

In the most test cases, the signal and the noise power are not defined directly but with the target signal-to-noise ratio (SNR) or **carrier/noise ratio**.

The **carrier power** is a measure for the *signal without the noise distribution*. This indication corresponds to the "Level" value in the "Status bar" (see [Figure 6-3](#)).

To ensure flat noise within the selected system bandwidth, the **noise bandwidth** has to be larger than the system bandwidth. The minimum noise bandwidth is sometimes part of the specifications and is calculated as follows:

"Noise Bandwidth" = "System Bandwidth" x "Minimum Noise/System Bandwidth Ratio"

Logically, the calculated noise bandwidth does not exceed the total available bandwidth of the instrument, as specified in the data sheet.

By default, the **noise power** within the system bandwidth is not defined directly but calculated depending on the selected system bandwidth and the desired SNR. The noise power over the noise bandwidth is calculated respectively.

The noise signal is not generated arbitrarily for a particular bandwidth, but instead it is generated in steps. Noise therefore also occurs outside the set system bandwidth, which means that the total measurable noise power usually exceeds the displayed value "Noise Power".

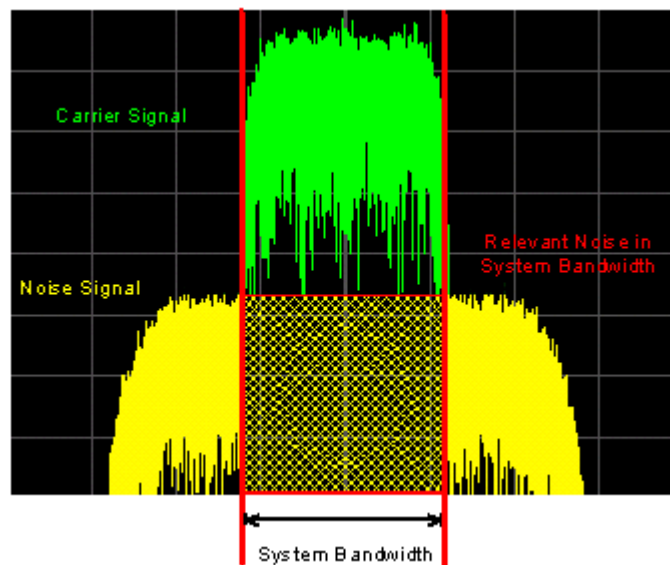

For a correct measurement of the noise power within the system bandwidth, we recommend that you measure the channel power with a signal analyzer.

In the "Additive Noise" mode, the output signal is the *signal with the noise distribution*. Hence, the power level at the RF output corresponds to the **carrier+noise power** (see [Figure 6-3](#)).

The noise power of digitally modulated signal is characterized by the parameter E_b/N_0 indicating the ratio of bit energy to noise power density. The correlation to the SNR is as follows:

C/N or $S/N = (E_b/N_0) \cdot (f_{bit}/B_{sys})$, where B_{sys} is the system bandwidth.

Bit Rate $f_{\text{bit}} = \text{"Symbol Rate"} * \text{Modulation Value}$



Where the bit rate value is retrieved from?

The parameter "AWGN > Noise Power / Output Results > Bit Rate" indicates the value used by the C/N or E_b/N_0 calculation. The value is retrieved automatically depending on the configured baseband signal:

- For signals generated by the "Custom Digital Mod", the bit rate is determined by the selected standard (see parameter "Custom Dig Mod > General" > "Symbol Rate" and "Custom Dig Mod > Modulation Type").
- For signals generated in accordance to a digital standard, the bit rate is often a standalone parameter. Some test cases however, for example the 3GPP base station tests (TS 25.141), specify the E/N settings that apply to channel-coded data or block segments. Set the parameter "Bit Rate" to the required value, e.g. the bit rate before or after channel coding.

Understanding the displayed information

The following example explains the impact of the AWGN settings on the signal and noise parameters.

See [Figure 6-3](#) for an example of an AWGN generation with the following configuration:

- "Baseband"
 - "Custom Digital Modulation > Set acc. to standard > WCDMA-3GPP"
 - "State > On".
 - "Symbol Rate = 3.840 Msym/s"
- "AWGN"
 - "General > Mode > Additive Noise"
 - "General > Min Noise/System Bandwidth Ratio = 3"
 - "General > State > On"
 - "Noise Power / Output Results > Show Results for Output > RF"
 - "Noise Power / Output Results > Reference Mode > Carrier"
 - "Noise Power / Output Results > Carrier/Noise Ratio = 10 dB"
- "RF > On"

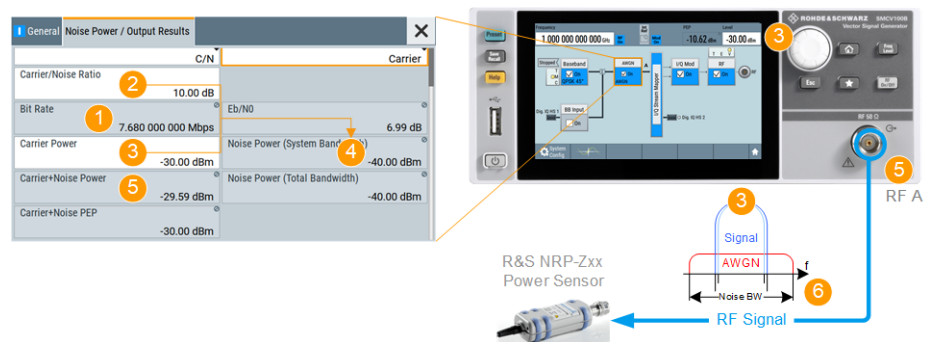

Figure 6-3: AWGN: Understanding the displayed information

- 1 = Bit Rate derived from the selected "Symbol Rate = 3.840 Msym/s"
- 2 = Selected Carrier/Noise Ratio
- 3 = Noise Power calculated from the "Carrier Power" and the "Carrier/Noise Ratio" = $-30 \text{ dBm} - 10 \text{ dB} = -40 \text{ dBm}$
- 4, 7, 10 = Carrier Power = Status bar > Level = -30 dBm
- 5, 8 = Carrier+Noise Power = power at the RF 50 Ω output; i.e. the power a connected power meter would measure
- 6, 9 = Noise Bandwidth = System Bandwidth*Minimum Noise/System Bandwidth Ratio = $3.840 \text{ MHz} * 3 = 11.520 \text{ MHz}$



Use the built-in graphical signal monitoring function of the instrument to display the signal characteristics in real-time, see ["To observe the effect of enabled additive noise \(AWGN\)"](#) on page 411.

Application fields

Typically, the noise generator is required for the following tests:

- In receiver sensibility tests with predefined SNR of the receiver, see ["To configure the AWGN for receiver sensibility tests"](#) on page 292
- In bit-error or block-error measurements, depending on the set signal-to-noise ratio (SNR)
- Whenever a pure noise signal is required

6.1.3 AWGN block

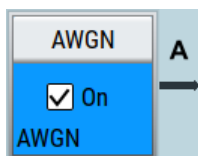

The "AWGN" block provides access to the settings for the **AWGN generator**, see [Chapter 6.1.4, "AWGN settings"](#), on page 285. The label in the AWGN block indicates the AWGN mode that is activated. The quickest way to activate or deactivate the AWGN generator is the "On/Off" switch in the AWGN block.

6.1.4 AWGN settings

Access:

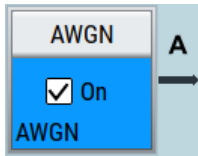

1. Select "Block Diagram > AWGN".

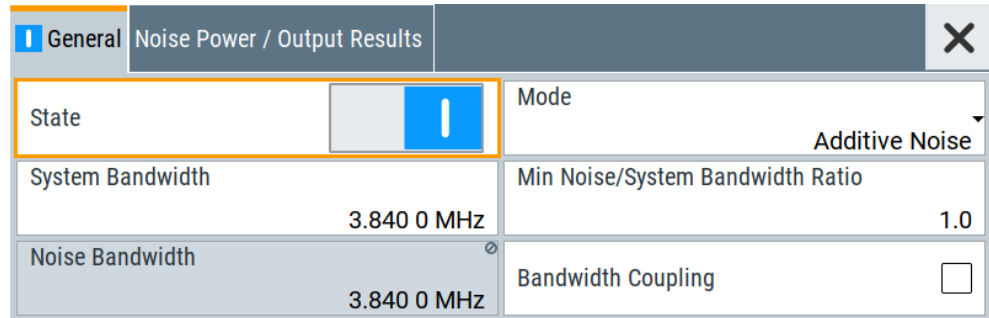

The dialog contains the settings for noise level configuration and CW interfering parameters.

2. To activate the AWGN generator, select "Block Diagram > AWGN > On".

The remote commands required to define these settings are described in [Chapter 14.16.3.5, "SOURce:AWGN subsystem"](#), on page 738.

Settings:

6.1.4.1 General settings

Access:

- ▶ Select "Block Diagram > AWGN".

Settings:

State.....	285
Mode.....	286
System Bandwidth.....	286
Minimum Noise/System Bandwidth Ratio.....	286
Bandwidth Coupling.....	286
Target CW Frequency Offset.....	287

State

Activates/deactivates the generation of an AWGN signal. The interferer (AWGN or CW interferer, depending on the selected mode) is generated after the generator is activated.

Remote command:

[:SOURce<hw>] :AWGN:STATe on page 740

Mode

Activates/deactivates the generation of an AWGN signal. The interferer (AWGN or CW interferer, depending on the selected mode) is generated after the generator is activated.

"Additive Noise"

The AWGN noise signal with selectable system bandwidth is added to the baseband signal.

"Noise Only"

The pure AWGN noise signal with selectable system bandwidth is modulated to the carrier. The connection to the baseband is interrupted.

"CW Interferer"

A sine with a defined frequency offset is added to the baseband signal.

This mode is disabled in "System Configuration" with more than 4 input streams.

Remote command:

`[:SOURce<hw>] :AWGN:MODE` on page 740

System Bandwidth

For "Additive Noise" and "Noise Only" modes, sets the RF bandwidth to which the set carrier/noise ratio relates.

Within this frequency range, the signal is superimposed with a noise signal which level corresponds exactly to the set C/N or S/N ratio.

For more information, refer to the description of [Figure 6-2](#).

Remote command:

`[:SOURce<hw>] :AWGN:BWIDth` on page 741

Minimum Noise/System Bandwidth Ratio

For "Additive Noise" and "Noise Only" modes, sets the ratio of minimum noise bandwidth to system bandwidth, as required by some standards.

"Noise Bandwidth" = "System BW" x "Minimum Noise/System BW Ratio"

The parameter [Noise Bandwidth](#) displays the resulting noise bandwidth. Because the noise power density is a constant value, increasing the noise/system bandwidth ratio increases the noise bandwidth.

The calculation of level from the selected C/N or S/N ratio in relation to system bandwidth is not influenced.

Remote command:

`[:SOURce<hw>] :AWGN:BWIDth:RATio` on page 741

Bandwidth Coupling

Requires "Mode > Additive Noise/Noise Only". Activating bandwidth coupling requires an activated digital broadcast baseband signal, e.g. "Baseband > ATSC-M/H > ATSC-M/H > On".

Activates bandwidth coupling. If activated, the AWGN "System Bandwidth" couples to the digital broadcast baseband signal bandwidth. The baseband signal bandwidth is derived from the "Used Bandwidth" or "Symbol Rate" of the active coder of the digital broadcast standard.

Also the "Minimum Noise/System Bandwidth Ratio" is updated corresponding to the coupled "System Bandwidth".

"Bandwidth Coupling" is deactivated for "Audio AM", "Audio FM" and all other base-band signals, e.g. custom digital modulated signals.

Remote command:

[:SOURce<hw>] :AWGN:BWIDth:COUPling[:STATe] on page 741

Target CW Frequency Offset

In "CW Interferer" mode, sets the desired frequency of the sine wave.

Remote command:

[:SOURce<hw>] :AWGN:FREQuency:TARGet on page 745

6.1.4.2 Noise power/output results settings

Access:

- Select "AWGN > Noise Power/Output Results".

General		Noise Power / Output Results	
Display Mode	RF	Reference Mode	Carrier
Set Noise Power Via	C/N		
Carrier/Noise Ratio	0.00 dB		
Bit Rate	100.000 000 kbps	Eb/N0	15.84 dB
Carrier Power	-30.00 dBm	Noise Power (System Bandwidth)	-30.00 dBm
Carrier+Noise Power		Noise Power (Total Bandwidth)	

The available settings depend on the selected [Mode](#).

Settings:

Show Powers For Output.....	288
Set Noise Power Via.....	288
Reference Mode.....	288
Bit Rate.....	288
Carrier/Noise Ratio, Signal/Noise Ratio.....	289
E_b/N_0	289
Carrier Power, Signal Power.....	289
Noise Power (System Bandwidth), Interferer Power.....	290
Noise Power (Total Bandwidth).....	291

Carrier + Noise Power, Signal + Noise Power (System Bandwidth), Carrier + Interferer Power, Signal + Interferer Power.....	291
Carrier + Noise PEP, Signal + Noise PEP (Total Bandwidth), Carrier + Interferer PEP, Signal + Interferer PEP.....	291
Noise Bandwidth.....	292
Resulting CW Frequency Offset.....	292

Show Powers For Output

Sets the output to which the displayed settings are related to.

This setting also influences:

- The way the interfering parameters are displayed, e.g. if the SNR value is defined as C/N or as S/N.
- The value units:
 - The values related to the RF outputs are displayed in dBm
 - The values related to the baseband outputs - in dB

Remote command:

[:SOURce<hw>] :AWGN:DISP:MODE on page 742

Set Noise Power Via

In "Additive Noise" mode, selects the way the noise power is determined.

The following correlation applies:

"C/N or S/N" = $(E_b/N_0) * (f_{bit}/B_{sys})$, where:

- "C/N or S/N" is the carrier/noise ratio
- " E_b/N_0 " is the ratio of bit energy to noise power density
- "Bit Rate" f_{bit} = "Symbol Rate" x Modulation Value
- B_{sys} is the system bandwidth.

See also [Chapter 6.1.2, "About the AWGN generator"](#), on page 280.

Remote command:

[:SOURce<hw>] :AWGN:POWer:MODE on page 742

Reference Mode

Selects whether the carrier or the noise power is kept constant if the C/N or E_b/N_0 ratio is changed.

In the common case, the instrument keeps the carrier power and adjusts the noise power accordingly. Some test cases however, for example the 3GPP base station tests (TS 25.141), specify explicitly the noise power. These test cases require that the noise power is permanently set as a function of the base station power class, whereas the carrier power is variable.

Remote command:

[:SOURce<hw>] :AWGN:POWer:RMODE on page 743

Bit Rate

In "Additive Noise" mode, indicates the bit rate used for converting C/N or S/N to E_b/N_0 .

Tip: For digitally modulated signals, select the bit rate before or after channel coding, as required.

See also [Chapter 6.1.2, "About the AWGN generator"](#), on page 280.

Remote command:

[:SOURce<hw>] :AWGN:BRATe on page 743

Carrier/Noise Ratio, Signal/Noise Ratio

In "Additive Noise" and "CW Interferer" mode, sets the carrier/noise, signal/noise or signal/interferer ratio.

Whether a configuration of C/N or S/N is enabled, depend on the selected output [Show Powers For Output](#).

- In "Reference Mode > Carrier": sets the noise power. It does not affect the power of the useful signal, i.e. the carrier power remains constant.
Thus the power of the carrier + noise signal or the *power of the output signal* changes.
- In "Reference Mode > Noise", sets the *power of the useful signal*, i.e. the carrier power.
The power of the output signal remains constant.
- The power of the noise signal is derived from the entered C/N or S/N value and displayed with the parameter "Noise Power" in the units of the useful signal.
- The power of the useful signal is displayed with the parameter "Carrier Power" and can also be changed there. This indication corresponds to the "Level" value in the "Status bar".
- The power of the output signal is displayed as "Carrier + Noise Power".

See also [Figure 6-3](#).

Remote command:

[:SOURce<hw>] :AWGN:CNRatio on page 743

E_b/N_0

In "Additive Noise" mode, sets the ratio of bit energy to noise power density.

- In "Reference Mode > Carrier": sets the *noise power* and hence the power of the output signal, i.e. the carrier + noise signal.
It does not affect the power of the useful signal, i.e. the carrier power is kept constant.
- In "Reference Mode > Noise": sets the *power of the useful signal*, i.e. the carrier power.
The noise power is kept constant.
- The power of the noise signal is derived from the selected E_b/N_0 and displayed with the parameter "Noise Power" in the units of the useful signal.
- The power of the useful signal is displayed with the parameter "Carrier Power".
This indication corresponds to the "Level" value in the "Status bar".
- The power of the output signal is displayed as "Carrier + Noise Power".

See also [Figure 6-3](#).

Remote command:

[:SOURce<hw>] :AWGN:ENRatio on page 743

Carrier Power, Signal Power

("Additive Noise" and "CW Interferer")

The name of this parameter depends on the selected output [Show Powers For Output](#).

- In "Reference Mode > Carrier": sets the carrier power. This indication corresponds to the "Level" value in the "Status bar".

The power of the noise signal is derived from the selected C/N or S/N value and displayed with the parameter "Noise Power" in the units of the useful signal.

- In "Reference Mode > Noise", indicates the carrier power as derived from the entered C/N or S/N value. This indication corresponds to the "Level" value in the "Status bar".

The noise power can be set with the parameter "Noise Power".

Note: The peak envelope power (PEP) displayed in the "Status bar" corresponds to the PEP value of the carrier. The parameter "Carrier+Noise (PEP)" indicates the PEP value of the overall signal.

See also [Figure 6-3](#).

Remote command:

`[:SOURce<hw>] :AWGN:POWer:CARRier` on page 744

Noise Power (System Bandwidth), Interferer Power

Displays the power of the noise signal in the system respectively the total bandwidth in "Noise Only" and "Additive Noise" mode.

- "Noise Only" mode
 - Sets the power of the noise signal. This indication corresponds to the "Level" value in the "Status bar".
- "Additive Noise" mode
 - "Reference Mode > Noise"
 - Sets the power of the noise signal. The power of the carrier is derived from the entered C/N or S/N or Eb/N0 value.
 - "Reference Mode > Carrier"
 - Displays the power of the noise signal in the system bandwidth. The power of the noise signal is derived from the entered C/N or S/N or Eb/N0 value.
 - The carrier power is selected with "Carrier Power"; respectively the signal power is displayed by "Signal Power".
- "CW Interferer" mode
 - "Reference Mode > Noise"
 - Sets the power of the interfering signal. The power of the carrier is derived from the entered C/I value.
 - "Reference Mode > Carrier"
 - Displays the power of the interfering signal. The power of the interfering signal is derived from the entered C/N or S/N value. The carrier power is entered under "Carrier Power".

Note: The noise signal is not generated arbitrarily for a particular bandwidth, but instead it is generated in steps. Noise therefore also occurs outside the set system bandwidth. The occurrence means that the total measurable noise power usually exceeds the value displayed here. For correct measurement of the noise power within the system bandwidth, we recommend that you measure the channel power with a signal analyzer.

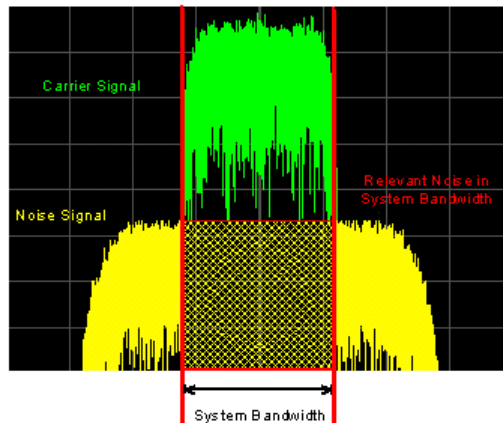

See also [Figure 6-3](#).

Remote command:

`[:SOURce<hw>] :AWGN:POWer:NOISe` on page 744

Noise Power (Total Bandwidth)

Displays the power of the noise signal in the total bandwidth in "Noise Only" and "Additive Noise" mode.

See also [Figure 6-3](#).

Remote command:

`[:SOURce<hw>] :AWGN:POWer:NOISe:TOTal?` on page 744

Carrier + Noise Power, Signal + Noise Power (System Bandwidth), Carrier + Interferer Power, Signal + Interferer Power

In "Additive Noise" and "CW Interferer" mode, displays the overall power of the noise/interferer signal plus useful signal.

The output selected with the parameter [Show Powers For Output](#) determines:

- The name of this parameter
- The units the overall power is measured in, dBm or dB (full-scale)

See also [Figure 6-3](#).

Remote command:

`[:SOURce<hw>] :AWGN:POWer:SUM?` on page 744

Carrier + Noise PEP, Signal + Noise PEP (Total Bandwidth), Carrier + Interferer PEP, Signal + Interferer PEP

In "Additive Noise" and "CW Interferer" mode, displays the peak envelope power (PEP) of the overall signal comprised of noise signal plus useful signal.

The output selected with the parameter [Show Powers For Output](#) determines:

- The name of this parameter
- The units the overall power is measured in, dBm or dB (full-scale)

Note: The peak envelope power ("PEP") displayed in the "Status bar" corresponds to the PEP value of the carrier.

Remote command:

`[:SOURce<hw>] :AWGN:POWer:SUM:PEP?` on page 745

Noise Bandwidth

For "Additive Noise" and "Noise Only" modes and with activated AWGN generator, indicates the real noise bandwidth.

See also [Figure 6-2](#).

Remote command:

`[:SOURce<hw>] :AWGN:BWIDth:NOISe?` on page 742

Resulting CW Frequency Offset

In "CW Interferer" mode, indicates the resulting frequency offset of the sine wave.

Remote command:

`[:SOURce<hw>] :AWGN:FREQuency:RESult?` on page 745

6.1.5 How to configure the noise generator for receiver tests

This section shows you how to configure the noise generator for receiver tests, for example the tests specified in the 3GPP test specification TS 36.141, chapter 7.

For the following example, we assume that the R&S SMCV100B generates an uplink EUTRA/LTE signal with following characteristics:

- "EUTRA/LTE > Duplexing = FDD", "Link Direction = Uplink"
- "EUTRA/LTE > General Uplink Setting > Channel Bandwidth = 5 MHz" and "Occupied Bandwidth = 4.5 MHz"
- "EUTRA/LTE > Frame Configuration > UE1 > FRC > FRC State = On" and "FRC = TS 36.141: A2-3"
- "EUTRA/LTE > State = On"
- "Status bar > Frequency = 1.95 GHz" and "Level = -69.9 dBm"
- "RF State > On"

To configure the AWGN for receiver sensibility tests

We assume that an AWGN interfering signal with the following characteristics is required:

The mean power of the interfering signal is -82.5 dBm/BW and C/N = 12.6 dB.

1. Select "AWGN".
2. Set AWGN general settings:
 - "Mode > Additive Noise"
 - "System Bandwidth = 4.5 MHz"

The definition of the interfering signal mean power is dBm/BW, where BW is the system bandwidth. The system bandwidth of the LTE signal is the occupied bandwidth.

See also [Figure 6-2](#).
 - "Min Noise/System Bandwidth Ratio = 1.5"
3. Select "Noise Power/Output Results".
4. Set AWGN noise power settings:

- "Set Noise Power Via = C/N"
- "Reference Mode = Carrier"
- "Carrier/Noise Ratio = 12.6 dB"

General		Noise Power / Output Results	X
Display Mode	RF		
Set Noise Power Via	C/N	Reference Mode	Carrier
Carrier/Noise Ratio	12.60 dB		
Bit Rate	100.000 000 kbps	Eb/N0	29.13 dB
Carrier Power	-69.90 dBm	Noise Power (System Bandwidth)	-82.50 dBm
Carrier+Noise Power		Noise Power (Total Bandwidth)	

The dialog confirms the required mean power of the interfering signal "Noise Power (System Bandwidth) = -82.5 dBm".

5. Select "AWGN > General > State > On".

To generate a CW interfering signal

For the following example, we assume that two interfering signals are required, a 5 MHz uplink LTE signal and a CW signal. The signals are transmitted at -52 dBm; the LTE signal at 1.96 GHz and the CW signal 10 MHz below it. Signals with equal (or similar) RF levels and at frequencies spaced within the max. RF bandwidth can be generated by the same path.

To configure the instrument:

1. Enable the required LTE signal:
 - a) Select "EUTRA/LTE > General Uplink Setting > Channel Bandwidth = 5 MHz" and "EUTRA/LTE > State = On"
 - b) Select "Status bar > Frequency = 1.96 GHz" and "Level = -52 dBm"
2. Enable the required interfering signal:
 - a) Select "AWGN > General > Mode > CW Interferer"
 - b) Select "Target CW Frequency Offset = 10 MHz"
 - c) Select "Noise Power/Output Results > Reference Mode = Noise"
 - d) Select "Interferer Power = -52 dB"
 - e) Select "AWGN > General > State > On".
3. Select "RF > State > On"

6.2 Impairing the signal

In the R&S SMCV100B, *digital linear impairments* such as I/Q imbalance and quadrature error can be added to the generated signal.

6.2.1 Required options

The base unit is sufficient. Additional options are not required.

6.2.2 About the linear I/Q impairments

Signal impairments (**I/Q Impairments**) are well-defined arithmetic modifications of the data. Every data sample is modified in the same way.

Adding linear impairments to the data stream is provided for the following purpose:

- To simulate frequent sources of distortions in a real signal-processing chain as, it is required for tests with dirty transmitter conditions (receiver tests)

The R&S SMCV100B offers functions to impair the internally generated signal.

6.2.2.1 Gain and gain imbalance

An I/Q gain is a multiplication of all I/Q amplitudes by a common factor. The effect is equivalent to two identical I and Q gain factors. The effect of an increased gain factor in the I/Q constellation diagram is shown on [Figure 6-4](#).

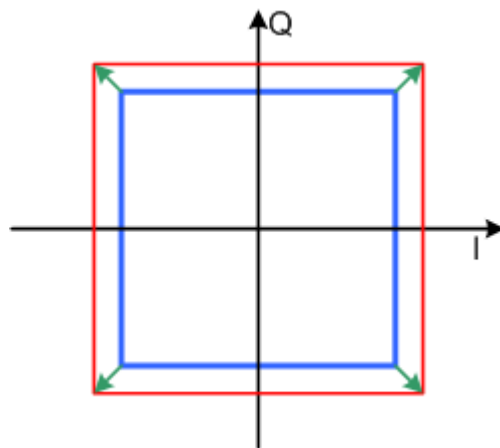

Figure 6-4: Effect of an increased amplitude in the I/Q constellation diagram

An I gain multiplies the I amplitudes by a factor, leaving the Q amplitudes unchanged. A Q gain has the opposite effect. Different I and Q gain factors result in an I/Q imbalance, which is due to different gains of the amplifiers in the I and Q channels of the I/Q modulator. The effect of a positive and negative gain imbalance is shown on [Figure 6-5](#).

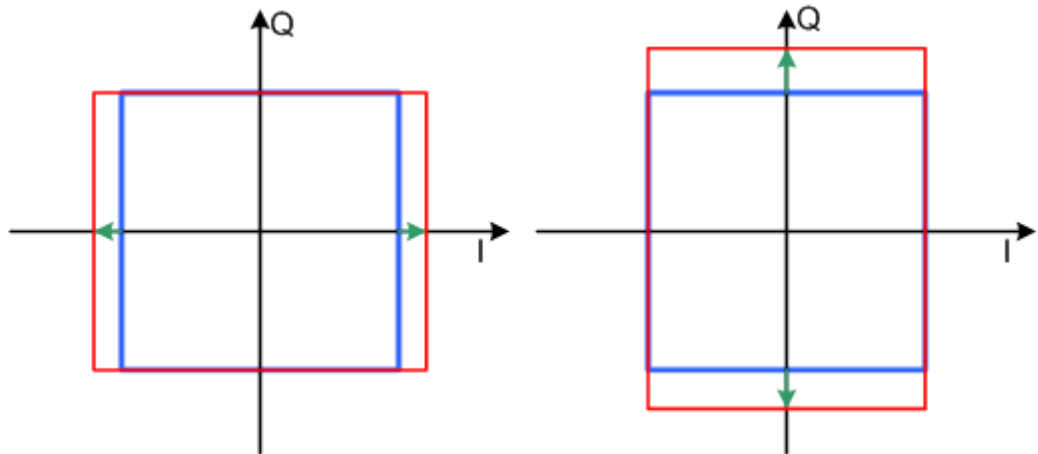

Figure 6-5: Negative gain imbalance (left) and positive gain imbalance (right) in the I/Q constellation diagram

6.2.2.2 I and Q offset

An I offset adds a constant value to all I amplitudes, leaving the Q amplitudes unchanged. A Q offset has the opposite effect. A combination of I and Q values results in an I/Q offset, which is due to carrier feedthrough in the I/Q modulator. Possible reasons are interfering signals at the RF carrier frequency, e.g. an unsuppressed RF carrier subchannel. The effect of a positive I and Q offset in the I/Q constellation diagram is shown on [Figure 6-6](#).

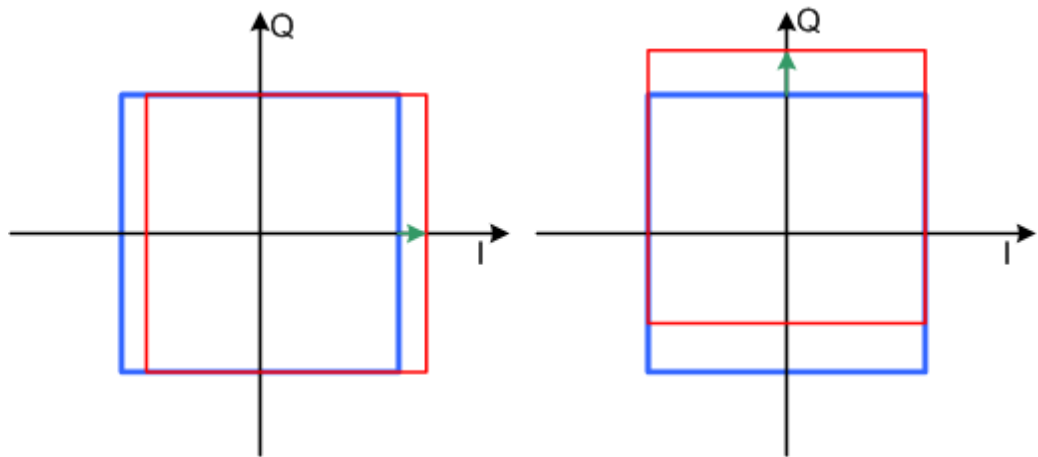

Figure 6-6: I offset (left) and Q offset (right) in the I/Q constellation diagram

6.2.2.3 Quadrature offset

Changes the phase angle between the I and the Q vectors from the ideal 90 degrees, while the amplitudes are maintained. A positive quadrature offset results in a phase angle greater than 90 degrees. The effect of a positive quadrature offset in the I/Q constellation diagram is shown on [Figure 6-7](#).

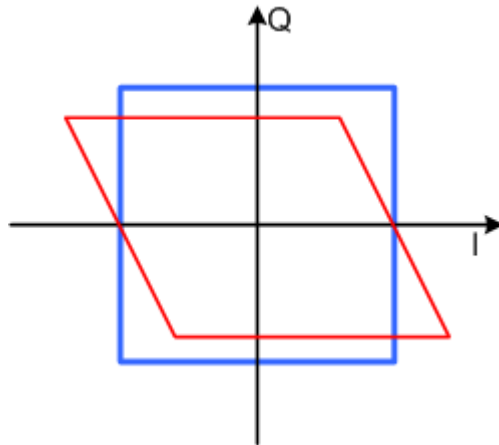

Figure 6-7: Positive quadrature offset in the I/Q constellation diagram

6.2.3 Digital impairments settings

You can add digital impairments to each internal generated I/Q stream.

See also [Chapter 6.2.2, "About the linear I/Q impairments"](#), on page 294.

Access:

- ▶ Select "I/Q Mod > Digital Impairments".

General		Digital Impairments	
State	<input type="checkbox"/>		
I Offset	0.00 %	Q Offset	0.00 %
Gain Imbalance	0.000 dB	Quadrature Offset	0.00 deg

The dialog covers the settings for I/Q impairment, like leakage, imbalance and offset.

The remote commands required to define these settings are described in [Chapter 14.16.3.6, "SOURce:BB:IMPairment subsystem"](#), on page 746.

Settings:

State	297
I/Q Offset	297
Gain Imbalance	297
Quadrature Offset	297

State

Activates the impairment of the I/Q signal.

If activated, the settings for I/Q offset, I/Q imbalance, and quadrature offset become effective.

Remote command:

`[:SOURce<hw>] :BB:IMPairment:STATE` on page 747

I/Q Offset

Sets a carrier offset (in percent) of the amplitudes (scaled to the peak envelope power (PEP)) for the I and/or Q signal component. An ideal I/Q modulator suppresses the carrier offset completely (offset = 0 percent).

For more information, see [Chapter 6.2.2.2, "I and Q offset"](#), on page 295.

Remote command:

`[:SOURce<hw>] :BB:IMPairment:LEAKage:I` on page 746

`[:SOURce<hw>] :BB:IMPairment:LEAKage:Q` on page 746

Gain Imbalance

Sets the imbalance of the I and Q vector.

The entry is made in dB (default) or %, where 1 dB offset is roughly 12% according to the following:

$$\text{Imbalance [dB]} = 20 \log (| \text{GainQ} | / | \text{GainI} |)$$

Positive values mean that the Q vector is amplified more than the I vector by the corresponding percentage. Negative values have the opposite effect.

For more information, see [Chapter 6.2.2.1, "Gain and gain imbalance"](#), on page 294.

Remote command:

`[:SOURce<hw>] :BB:IMPairment:IQRatio[:MAGNitude]` on page 746

Quadrature Offset

Sets the quadrature offset.

For more information, see [Chapter 6.2.2.3, "Quadrature offset"](#), on page 295.

Remote command:

`[:SOURce<hw>] :BB:IMPairment:QUADrature[:ANGLE]` on page 747

7 Applying I/Q vector modulation

The R&S SMCV100B offers I/Q modulation with an external digital signals or an internally generated digital signal.

For a description on the signal impairment functionality and settings for applying non-linear effects, see:

- [Chapter 6.2, "Impairing the signal"](#), on page 294

7.1 Required options

The equipment layout for I/Q modulation includes:

- Base unit
- One of the Frequency options (R&S SMCVB-B103/-KB106)
Sufficient for I/Q modulation with internal signal.

7.2 About the I/Q modulator

The R&S SMCV100B offers I/Q modulation with internally generated digital signals.

Defining the input signal of the I/Q modulator

The [Table 7-1](#) gives an overview of the possible input signals and the connectors they are supplied at. Any of the specified input signals is processed by the I/Q modulator and output at the RF output.

Table 7-1: Physical input signals of the I/Q modulator

Input signal	Input connector	GUI parameter
Internal digital baseband signal	-	"I/Q Mod. > I/Q Mod. In > Internal Baseband I/Q In" and "Baseband > On"
External digital signal	Dig. IQ HS 1	"I/Q Mod. > I/Q Modulator Input > Internal Baseband" and "BB Input > On"

7.3 I/Q modulator settings

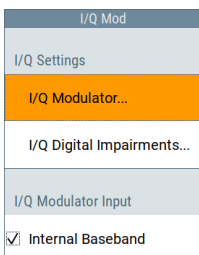

Access:

- ▶ Select "I/Q Mod > I/Q Settings > I/Q Modulator".

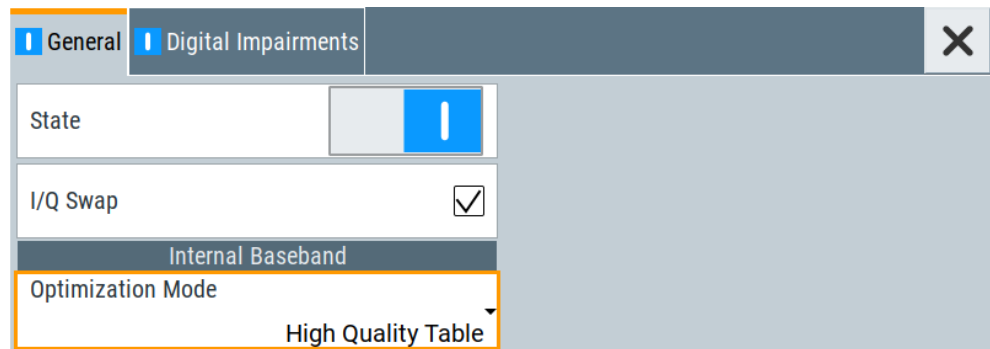

The dialog comprises the I/Q modulator settings and settings for enabling digital impairments.

The remote commands required to define these settings are described in [Chapter 14.16.7, "SOURCE:IQ subsystem"](#), on page 765.

For a description on the signal impairment functionality and settings for applying non-linear effects, see:

- [Chapter 6.2, "Impairing the signal"](#), on page 294

Settings:

State	299
I/Q Swap	299
Optimization Mode	300

State

Activates/deactivates I/Q modulation.

Remote command:

[:SOURCE<hw>] : IQ:STATe on page 766

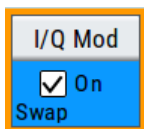

I/Q Swap

Selects normal or swapped I/Q control for the generated signal.

The I/Q modulator defined in the IS2000 standard differs from the definition in this implementation. The definition on which the implementation is based is used by virtually all digital communication standards, except IS95 and IS2000.

In the final step, the filtered IQ signal is modulated to the desired RF in a different way in the I/Q modulator:

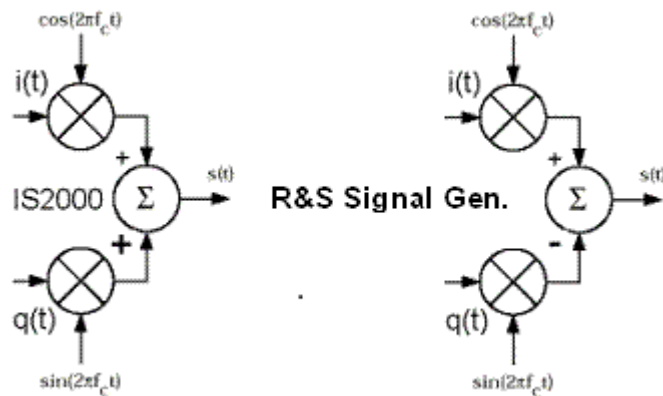

Figure 7-1: Definition of I/Q modulator in IS2000 and the R&S SMCV100B

IS2000 = The RF signal $s(t)$ is derived from the baseband I/Q signal as $s(t) = i(t)\cos(2\pi f_c t) + q(t)\sin(2\pi f_c t)$

R&S SMCVB = The RF signal $s(t)$ is based on the definition $s(t) = i(t)\cos(2\pi f_c t) - q(t)\sin(2\pi f_c t)$

"Off" I/Q control is normal.

"On" The modulation sidebands are inverted by swapping the I and Q signals (the Q-part of the signal is inverted).
The generated baseband signal is according to standards CDMA2000 and 1xEV-DO.
An I/Q modulator defined according to these standards can cope with the RF signal generated by the R&S SMCV100B.

Remote command:

`[:SOURce<hw>] :IQ:SWAP [:STATe]` on page 766

Optimization Mode

Selects the optimization mode. For information on the I/Q modulation performance in any of the modes, see the data sheet.

How to: [Chapter 7.4, "Optimizing I/Q modulation performance"](#), on page 301

"Fast" Fast optimization by compensating for I/Q skew.
This mode is suitable in time sensitive environments and for narrow-band signals.

"High Quality Table"
Requires R&S SMCVB-K547.
This mode further improves the frequency response while maintaining setting time. There is no signal interruption.
Use this mode in setups to generate phase coherent signals with an RF modulation bandwidth of up to 240 MHz.

Remote command:

`[:SOURce<hw>] :BB:IMPAirment:OPTimization:MODE` on page 747

7.4 Optimizing I/Q modulation performance

When using the default settings of the I/Q Modulator, the R&S SMCV100B provides a vector modulated signal. This signal is optimized for time sensitive measurements that require lower noise signals and narrowband signals.

Adjusting these settings helps you to improve signal quality for larger I/Q modulation bandwidth signals. As a result, the adjustment improves the flatness of the RF signal.

Predefined frequency response correction

Equipped with R&S SMCVB-K547, the R&S SMCV100B provides I/Q modulation optimization mode "High Quality Table". To improve signal quality, this mode features the following:

- Frequency response correction for larger modulation bandwidth signals
- Correction of internally generated baseband signals by predefined correction values
- Absolute level correction at center frequency
- Correction in real time, no signal interruption

To improve RF signal flatness

In the following step-by-step instruction, we assume that:

- The R&S SMCV100B generates an RF signal. The RF signal is a baseband signal that is modulated on an RF carrier.
- A spectrum analyzer is connected to the R&S SMCV100B. The analyzer is configured, and measures the required signal characteristics.

For a given baseband signal and RF frequency, perform the following:

1. In the block diagram, select "I/Q Mod > I/Q Settings > I/Q Modulator > On".

The I/Q modulator is enabled. Modulated is the internal baseband signal.

This mode generates flat signal but requires longer settling time and leads to signal interruption.

2. Select "Optimization Mode > High Quality Table"

The R&S SMCV100B uses predefined values from instrument calibration to correct the frequency response. Correction implies signal flatness over the whole I/Q modulation bandwidth.

3. On a connected signal analyzer, monitor the signal characteristics.

8 Configuring the RF signal

The vector signal generator R&S SMCV100B generates RF signals with outstanding spectral purity within the frequency range from 8 kHz up to 7.125 GHz and with adjustable signal level over a wide range.

In addition to these real-time CW signals, you can generate RF signals from predefined lists and sweep signals that vary according to the frequency or amplitude curves.

The variably adjustable output level due to the built-in attenuator, allows you to vary the RF signal level over the full level range. There are different methods to improve signal performance and to optimize the signal quality for the particular application, or to increase the accuracy and reliability of the generated RF signal.

The R&S SMCV100B supports R&S NRP power sensors, e.g. to monitor the output level of the generator and to determine the level correction values for user correction lists.

Signal modes and characteristics

The R&S SMCV100B generates unmodulated or modulated RF signals. You can output the signal in fixed mode or as a signal having periodically varying frequencies or amplitudes.

Signal modes for RF signal generation:

- Unmodulated signal
Generates an unmodulated continuous wave (CW) of constant frequency and amplitude.
For information on the signal frequency and level settings and example on how to configure a simple CW signal, see:
 - [Chapter 8.5, "RF frequency settings"](#), on page 306
 - [Chapter 8.6, "RF level settings"](#), on page 308
 - [Chapter 3.3.1, "Generating an unmodulated carrier"](#), on page 43
- Vector modulated signal
Generates an I/Q vector modulated signal
See [Chapter 7, "Applying I/Q vector modulation"](#), on page 298.

The R&S SMCV100B allows you to provide the RF signal with constant or varying frequencies and/or amplitudes at the output:

- Constant frequency and level (CW/Fixed mode)
The RF output signal has the set frequency and level.
- Varying frequency and/or level
 - Sweep mode
An RF or LF frequency and RF level sweep signal, processed continuously, step-by-step or individually and with selectable trigger modes. You can only run one sweep at a time.
 - List mode
The RF signal is based on a list of predefined frequency and level values pairs and step widths.

See [Chapter 8.9, "Varying the RF signal in list or sweep mode"](#), on page 317.

8.1 Required options

The equipment layout for generating the RF signal includes:

- Base unit
- Option frequency (R&S SMCVB-B103/-KB106)
- Optional, option extension from 60 MHz to 120 MHz RF bandwidth (R&S SMCVB-K521)
- Optional, option extension to 160 MHz RF bandwidth (R&S SMCVB-K522) (requires R&S SMCVB-K521)
- Optional, option extension to 240 MHz RF bandwidth (R&S SMCVB-K523) (requires R&S SMCVB-K522)

For more information, see data sheet.

8.2 How to access the RF settings

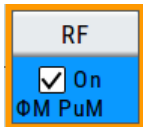

Access:

1. In the block diagram, select the block "RF > RF".
2. Select the required function from the list.

The RF block comprises all functions and settings concerning the RF signal. The settings include the RF frequency and level settings, enhanced functions for improving the signal characteristics, list and sweep mode settings and connector assignments and measurement functions of the RF signal.

8.3 How to activate the RF signal output

By default, the RF output signal is disabled. When you activate the RF output, the instrument restores the previously set signal configuration

To activate the RF output

1. Configure the RF signal as required.
Set, for example, the frequency and level values.
2. Activate the RF output in one of the following ways:
 - a) Select "Level > RF ON > On"

b) At the front panel, press the [RF on/off] key.

The blue color of the "RF On" icon and the RF block indicate that the RF signal output is enabled.

RF State/RF ON.....	304
PEP.....	304
RF output impedance.....	304

RF State/RF ON

Activates or deactivates the RF output.

Acts as the [RF on/off] key.

Remote command:

`:OUTPut<hw> [:STATe]` on page 618

PEP

Displays the PEP (Peak Envelope Power) in the status bar. This value corresponds to the level specification of a digital modulation or of a digital standard signal at the RF output.

Remote command:

`[:SOURce<hw>]:POWer:PEP?` on page 789

RF output impedance

You can query the impedance of the RF output.

Remote command:

`:OUTPut<hw>:IMPedance?` on page 619

8.4 How to set the frequency and level

The simplest form of the RF signal is a continuous wave (CW) of constant frequency and amplitude. The RF signal is defined by its frequency, level and phase.

► Use one of the following:

- "Status Bar > Frequency and Level"
- "RF > RF Frequency > Frequency > Frequency"
- "RF > RF Level > Level > Level"
- "RF > RF Frequency > Phase"

The frequency and level values are indicated on the "Status bar" so that you can see them at a glance. Values displayed in the status bar and in the "Frequency/Level" dialogs can deviate from each other.

See "RF frequency and level display with a downstream instrument" on page 305.

RF frequency and level display with a downstream instrument

If your test setup includes a downstream instrument, you can enter the parameter of the downstream instrument in the frequency or level settings dialog of the R&S SMCV100B. Examples of downstream instruments are mixers, frequency multipliers, amplifiers or attenuators and of their corresponding major parameters offset, multiplier, amplitude. The R&S SMCV100B generates the signal without the downstream parameters, but considers all additional parameters concerning the frequency and level.

Example parameters that affect the frequency and level:

- Frequency offset
- Multiplication factor
- User correction
- Digital attenuation

Any of these cases are indicated by a dedicated icon in the status bar, depending on the affected parameter.

Figure 8-1 illustrates the calculation of the "Frequency" and "Level" values, displayed in the status bar.

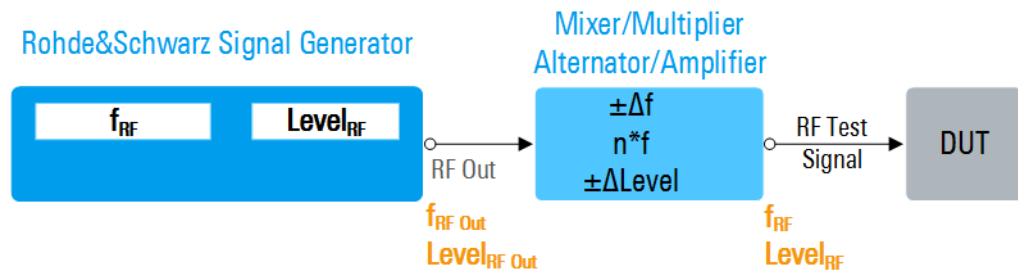

Figure 8-1: Frequency and Level display vs frequency and level at the RF output

f_{RF} , $Level_{RF}$	= Frequency and level ("Status bar > Frequency and Level") at the output of the downstream instrument, see also Calculation of f_{RF} and $Level_{RF}$)
$f_{RF\ Out}$, $Level_{RF\ Out}$	= Frequency and level at the output connector [RF 50 Ω] ("RF > RF Frequency > Frequency" and "RF > RF Level > Amplitude")
$n*f$	= Multiplication factor ("RF > RF Frequency > Multiplier")
Δf	= Frequency offset ("RF > RF Frequency > Offset")
$\Delta Level$	= Power offset ("RF > RF Level > Offset")

Calculation of f_{RF} and $Level_{RF}$

- $f_{RF} = n * f_{RF\ Out} + \Delta f$
- $Level_{RF} = Level_{RF\ Out} + \Delta Level + Level_{DigAtt}$
($Level_{DigAtt}$ for active internal I/Q modulation, "RF > RF Level > Digital Attenuation")

8.5 RF frequency settings

Access:

- ▶ Select "RF" > "RF Frequency" > "Frequency".

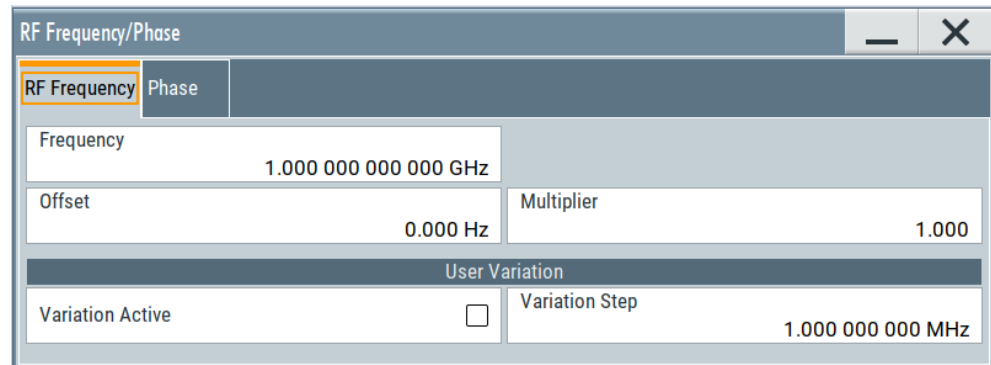

In the "RF Frequency" dialog, you can configure:

- RF frequency, incl. an offset or multiplication factor of a downstream instrument
- The step size for varying the frequency with the rotary knob.

The remote commands required to define the settings are described in [Chapter 14.16.5, "SOURce:FREQuency subsystem"](#), on page 759.

Settings

Frequency.....	306
Offset.....	307
Multiplier.....	307
User Variation.....	307
L Variation Active.....	307
L Variation Step.....	307

Frequency

Sets the RF frequency.

This frequency is output at the RF 50 Ω connector. It does not consider an [Offset](#) or multiplication factor ([Multiplier](#)).

See ["RF frequency and level display with a downstream instrument"](#) on page 305.

Note: Suppressed values in the status bar

For security concerns or certain operating modes, you can hide the frequency and level display in the status bar.

- *********

The display has been disabled for security reasons.

See:

- [Annotation Frequency](#)
- [Annotation Amplitude](#)

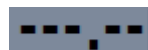

The display is disabled when:

- List mode is running, see [Chapter 8.9, "Varying the RF signal in list or sweep mode"](#), on page 317.

Remote command:

`[:SOURce<hw>] :FREQuency [:CW | FIXed]` on page 760

Offset

Sets the frequency offset.

This value represents the frequency shift of a downstream instrument, like for example a mixer.

The "Frequency" value displayed in the status bar is the resulting frequency, as it is at the output of the downstream instrument. The frequency at the R&S SMCV100B RF output is not changed.

See ["RF frequency and level display with a downstream instrument"](#) on page 305.

Remote command:

`[:SOURce<hw>] :FREQuency:OFFSet` on page 762

Multiplier

Sets the multiplication factor for the RF frequency.

This value represents the multiplication factor of a downstream instrument, as for example a multiplier. You can also assign a negative multiplication factor, for example -1.0 to support frequency converters working in the reverse frequency position.

The "Frequency" value displayed in the status bar is the resulting frequency, as it is at the output of the downstream instrument. The frequency at the R&S SMCV100B RF output is not changed.

See ["RF frequency and level display with a downstream instrument"](#) on page 305.

Remote command:

`[:SOURce<hw>] :FREQuency:MULTIplier` on page 762

User Variation

Defines and activates a user-defined step width for varying the RF frequency or RF level with the rotary knob.

If disabled, the step width varies in steps of one unit at the cursor position.

Variation Active ← User Variation

Activates the set user-defined step width.

Remote command:

`[:SOURce<hw>] :FREQuency:STEP:MODE` on page 764

`[:SOURce<hw>] :POWer:STEP:MODE` on page 793

Variation Step ← User Variation

Sets the user-defined step width.

Remote command:

`[:SOURce<hw>] :FREQuency:STEP [:INCReMENT]` on page 765

`[:SOURce<hw>] :POWer:STEP [:INCReMENT]` on page 793

8.6 RF level settings

Access:

1. Select "RF" > "RF Level" > "Level".

RF Level		Attenuator	UCOR None	Power-On/EMF	✕
RF State	<input checked="" type="checkbox"/>				Settings
Amplitude	-69.90 dBm	Limit	20.00 dBm	User Variation	
Offset	0.00 dB				
Setting Characteristics	Auto				
Level Range	-90.11 ... -52.97dBm	Readjust			

In the "RF Level" dialog, you can configure the offset-free level, the level limit, and the step width for varying the level with the rotary knob.

2. Select "User Variation" to set the step width to be used when setting the RF level using the rotary knob.

RF Level		Attenuator	UCOR None	Power-On/EMF	✕
Variation Active	<input type="checkbox"/>	Variation Step	1.00 dB	Settings	
				User Variation	

The remote commands required to define the settings are described in [Chapter 14.16.11, "SOURCE:POWER subsystem"](#), on page 785.

Settings

Amplitude.....	309
Limit.....	309
Offset.....	309
Setting Characteristics.....	310
Level Range.....	310
Readjust.....	310
User Variation.....	310
L Variation Active.....	310
L Variation Step.....	310

Amplitude

Sets the level of the RF signal.

The value is offset-free and corresponds to the level at the RF 50 Ω connector.

See ["RF frequency and level display with a downstream instrument"](#) on page 305.

Note: Suppressed values in the status bar

For security concerns or certain operating modes, you can hide the frequency and level display in the status bar.

- *********

The display has been disabled for security reasons.

See:

- [Annotation Frequency](#)
- [Annotation Amplitude](#)

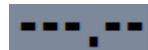

The display is disabled when:

- List mode is running, see [Chapter 8.9, "Varying the RF signal in list or sweep mode"](#), on page 317.

Remote command:

`[:SOURce<hw>] :POWER:POWER` on page 790

Note: The SCPI command `[:SOURce<hw>] :POWER [:LEVel] [:IMMediate] [:AMPLitude]` sets the level of the "Level" display.

This means, the level containing offset.

Limit

Sets an upper limit for the output power.

You can use this value to protect your DUT from damage due to high input power. If you enter an RF level above this value, the instrument limits the output power to this specified value, and generates the warning message:

"Pep value greater than the defined limit." However, the level indication in the status bar is not affected.

The setting is not affected by an instrument preset ([Preset] key or *RST) and the "Save/Recall" function. It is reset only by factory preset.

Remote command:

`[:SOURce<hw>] :POWER:LIMit [:AMPLitude]` on page 788

Offset

Sets a level offset.

This value represents the level shift of a downstream instrument, like, for example, an attenuator or an amplifier.

The "Level" value displayed in the status bar is the resulting level, as it is at the output of the downstream instrument. The level at the R&S SMCV100B RF output is not changed.

See ["RF frequency and level display with a downstream instrument"](#) on page 305.

Remote command:

[\[:SOURce<hw>\]:POWer\[:LEVel\]\[:IMMediate\]:OFFSet](#) on page 794

Setting Characteristics

Selects additional quality characteristics to optimize the behavior of the RF signal level for the specific application.

"Auto" Sets the RF output level automatically according to the selected mode.
In this mode, the instrument provides the highest dynamic range and fastest setting times, as specified in the data sheet.
The RF signal is shortly blanked when the step attenuator is switching.

"Uninterrupted" Suppresses blanking at level transitions. Frequency transitions can lead to an RF level blanking due to hardware-specific switching points.
This mode reduces the dynamic range of the instrument. The step attenuator is fixed.

Remote command:

[\[:SOURce<hw>\]:POWer:LBEHaviour](#) on page 788

Level Range

Shows the interruption-free range of the level that you can use in the currently selected mode.

Remote command:

[\[:SOURce<hw>\]:POWer:RANGe:LOWer?](#) on page 796

[\[:SOURce<hw>\]:POWer:RANGe:UPPer?](#) on page 796

Readjust

Recalculates and adjusts the internal switch positions of the RF chain according to the current level.

Remote command:

[\[:SOURce<hw>\]:POWer:ALC:SONCe](#) on page 787

User Variation

Defines and activates a user-defined step width for varying the RF frequency or RF level with the rotary knob.

If disabled, the step width varies in steps of one unit at the cursor position.

Variation Active ← User Variation

Activates the set user-defined step width.

Remote command:

[\[:SOURce<hw>\]:FREQuency:STEP:MODE](#) on page 764

[\[:SOURce<hw>\]:POWer:STEP:MODE](#) on page 793

Variation Step ← User Variation

Sets the user-defined step width.

Remote command:

[:SOURce<hw>] :FREQuency:STEP [:INCRe ment] on page 765

[:SOURce<hw>] :POWer:STEP [:INCRe ment] on page 793

8.7 RF phase settings

The phase in sinusoidal signals defines the initial angle at its origin.

Access:

- ▶ Select "RF" > "RF Frequency" > "Phase".

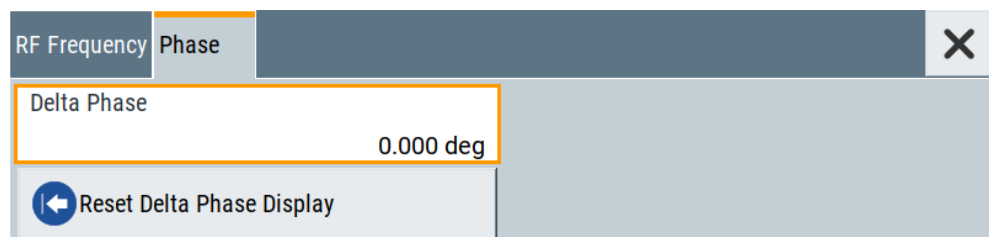

In the "RF Phase" tab, you can determine the delta phase value and reset the phase to this reference.

The remote commands required to define the settings are described in [Chapter 14.16.10](#), "SOURce:PHASe subsystem", on page 784.

Settings

Delta Phase	311
Reset Delta Phase Display	311

Delta Phase

Sets the phase of the RF signal.

The current phase of the signal is used as the reference.

Remote command:

[:SOURce<hw>] : PHASe on page 785

Reset Delta Phase Display

Adopts the selected "Delta Phase" value as the current value, and resets delta phase to 0 degrees.

Remote command:

[:SOURce<hw>] : PHASe:REFerence on page 785

8.8 Reference oscillator

The R&S SMCV100B is equipped with an internal reference oscillator that generates a reference frequency of 10 MHz. It is used as internal reference source for the synthesizer.

Alternatively, you can apply an external reference signal with reference frequency of 10 MHz or 13 MHz.



The reference oscillator settings are not affected by an instrument preset ([Preset] key or *RST) and the "Save/Recall" function. They are reset only by factory preset.

8.8.1 Required options

R&S SMCV100B base unit

For more information, see data sheet.

8.8.2 Reference frequency settings

Access:

1. Select "RF" > "RF Frequency" > "Reference Frequency".

Reference Frequency	Reference Output	Adjustment	
<div style="display: flex; justify-content: space-between; align-items: center;"> ← Set To Default ✕ </div>			
Source	External	<div style="display: flex; align-items: center;"> 🔍 Show Connector ... </div>	
Deactivate RF Output <i>(if external reference is missing)</i>	<input type="checkbox"/>		
External Reference Frequency	10 MHz		
Synchronization Bandwidth	Wide		
Nominal Synchronization Bandwidth	100 Hz	Minimum Locking Range	+/- 25 ppm

In the "Reference Frequency" tab, you can select the reference frequency signal source and the frequency and synchronization bandwidth mode of an external reference signal.

2. Observe the information in the status bar of the block diagram.

The status bar indicates the current oscillator configuration.



The remote commands required to define these settings are described in [Chapter 14.16.12, "SOURce:ROSCillator subsystem"](#), on page 796.

Settings:

Set to Default.....	313
Source.....	313
Show Connector.....	313
Deactivate RF Output (if external reference is missing).....	314
External Reference Frequency.....	314
Synchronization Bandwidth.....	314
Nominal Synchronization Bandwidth.....	315
Minimum Locking Range.....	315

Set to Default

Calls the default settings.

Remote command:

`[:SOURce] :ROSCillator :PRESet` on page 797

Source

Selects the reference frequency source.

"Internal" Uses the internal reference oscillator, either with calibrated or a user-defined [Adjustment Value](#).

Note: The internal reference frequency automatically uses [Synchronization Bandwidth > Narrow](#). Thus, if you preset this parameter, or set the reference source from "External" to "Internal" manually, the R&S SMCV100B sets the bandwidth to "Narrow".

"External" Uses an external reference signal.

Note: If the external reference is missing, the R&S SMCV100B issues a warning message and indicates the icon (external reference missing).

To set the frequency of the external reference, see ["External Reference Frequency"](#) on page 314.

Remote command:

`[:SOURce] :ROSCillator :SOURce` on page 797



Show Connector

Accesses a dialog that displays the physical location of the selected connector on the front/rear panel of the instrument.

A blinking LED on the front/rear panel indicates the selected connector, too (see [Chapter 12.2.2.3, "Status indicators"](#), on page 450).

Deactivate RF Output (if external reference is missing)

Turns off the RF output when the external reference signal is selected, but no signal is supplied.

This function prevents that no improper RF signal due to the missing external reference signal is used for measurements. A message indicates that the RF output is deactivated.

Remote command:

`[:SOURce] :ROSCillator :EXTernal :RFOFf [:STATe]` on page 798

External Reference Frequency

Selects the frequency of the external reference signal.

Set the reference output frequency with the parameters in the [Reference output settings](#) dialog.

"10 MHz" Selects 10 MHz for the external reference frequency signal.

"13 MHz" Selects 13 MHz for the external reference frequency signal.
If selected, you cannot select 10 MHz or 13 MHz as reference output frequency. See ["Reference Output"](#) on page 315.

Remote command:

`[:SOURce] :ROSCillator :EXTernal :FREQuency` on page 798

Synchronization Bandwidth

Selects the synchronization bandwidth for an external reference signal, set with [Source > External](#).

The resulting bandwidth is indicated by the parameter [Nominal Synchronization Bandwidth](#).

Note: If you preset or set the reference source from "External" to "Internal", the synchronization bandwidth is reset to "Narrow".

"Narrow" The internal reference oscillator is synchronized to the external signal with narrow bandwidth.
This setting is recommended if the phase noise of the external signal is worse than the phase noise of the internal OCXO.

"Wide" Synchronizes the internal oscillator to the external signal with the maximum possible bandwidth.
This mode is the recommended standard mode and for precise reference sources of high spectral purity.

Note: If the frequency of the external reference signal is outside the locking range of the internal reference oscillator, spurs due to the difference of the internal and external reference frequency are generated in the reference PLL.

The R&S SMCV100B issues an error message.

For more information, see data sheet.

Remote command:

`[:SOURce] :ROSCillator :EXTernal :SBANdwidth` on page 798

Nominal Synchronization Bandwidth

Indicates the nominal synchronization bandwidth for the selected [External Reference Frequency](#) and the [Synchronization Bandwidth](#).

Remote command:

`[[:SOURce]:ROSCillator:EXTernal:NSBandwidth?` on page 799

Minimum Locking Range

Indicates the minimum locking range for the selected [External Reference Frequency](#) and the [Synchronization Bandwidth](#).

Remote command:

`[[:SOURce]:ROSCillator:EXTernal:MLRange?` on page 799

8.8.3 Reference output settings

Access:

1. Select "RF" > "RF Frequency" > "Reference Frequency".
2. Select "Reference Output".

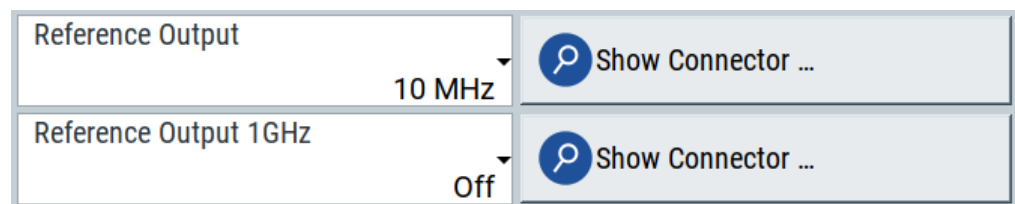

In the "Reference Output" tab, you can set the reference frequency value at the output connectors.

As a result of parameter dependencies, "Preset This Parameter" sometimes does not affect output dialogs.

The remote commands required to define these settings are described in [Chapter 14.16.12, "SOURce:ROSCillator subsystem"](#), on page 796.

Settings:

Reference Output	315
Show Connector	316

Reference Output

Selects the frequency reference output signal for downstream instruments.

"Off"	Deactivates the reference signal output.
"10 MHz"	Requires "Reference Frequency > External Reference Frequency > 10 MHz". Derives a signal with 10 MHz frequency from the internal reference oscillator and provides this signal at the output.

"Input Signal (loop through)"

Requires "Reference Frequency > Source > External".

Passes the external reference frequency to the output directly. You can pass through frequencies of 10 MHz or 13 MHz.

Remote command:

`[:SOURce] :ROSCillator :OUTPut :FREQuency :MODE` on page 799



Show Connector

Accesses a dialog that displays the physical location of the selected connector on the front/rear panel of the instrument.

A blinking LED on the front/rear panel indicates the selected connector, too (see [Chapter 12.2.2.3, "Status indicators"](#), on page 450).

8.8.4 Adjustment settings

Access:

1. Select "RF" > "RF Frequency" > "Reference Frequency".
2. Select "Adjustment".

Adjustment Active <input checked="" type="checkbox"/>	Adjustment Value 0
---	---

Settings:

Adjustment Active	316
Adjustment Value	316

Adjustment Active

Selects the adjustment mode.

- | | |
|-------|--|
| "Off" | Uses the calibrated internal reference frequency. |
| "On" | Allows you to apply a deviation to the internal reference frequency, according to your requirements.
Enter the value in the Adjustment Value field. |

Remote command:

`[:SOURce] :ROSCillator [:INTernal] :ADJust [:STATe]` on page 800

Adjustment Value

Sets a user-defined adjustment value for the internal reference frequency. This value takes effect when it is activated with [Adjustment Active](#).

- "0" represents the calibrated state.
- The setting range depends on the reference oscillator type and its factory calibration value.

Note:

The setting is not affected by an instrument preset ([Preset] key or *RST) and the "Save/Recall" function. It is reset only by factory preset.

Remote command:

`[[:SOURce]:ROSCillator[:INTernal]:ADJust:VALue` on page 800

8.9 Varying the RF signal in list or sweep mode

The operating modes "List" and "Sweep" allow you to generate an RF signal having periodically varying frequencies or amplitudes.

A signal generated with varying parameters scans a certain range of varying values of a parameter, with defined start and end points, and can be repeated cyclically.

The R&S SMCV100B supports two basic methods:

- **Sweep** mode

The instrument generates an RF signal which varies its frequency or level values in discrete steps between the start and end values. The values change according to a specific shape like sawtooth or triangle. The spacing is linear or logarithmic.

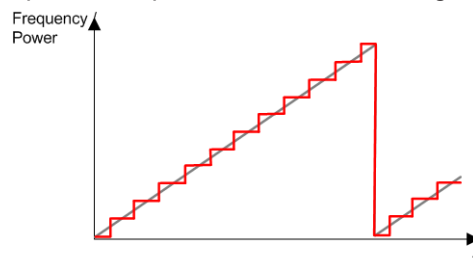

Figure 8-2: Schematic representation of a signal generated in sweep mode

The main application field of the "Sweep" mode is to determine the frequency response of a DUT.

- **List** mode

The instrument generates a varying output signal, based on a previously saved list with frequency, amplitude and step width values. While in sweep mode the frequency **or** the level values change, in list mode you can vary **both parameters simultaneously**. The frequency and level values do not need to have ascending or descending order, they can vary arbitrarily.

You can use a global dwell time, which means that the time interval is constant for all steps of the list, or different dwell times for each value pair.

[Figure 8-3](#) represents the frequency and power value pairs, in this case with the dwell time set the same for all steps (global dwell time).

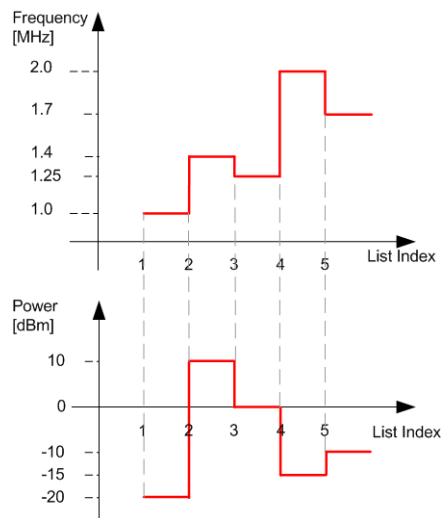

Figure 8-3: Schematic representation of a signal generated in list mode (global dwell time)

The list mode is especially useful in high-speed measurements with fast changing frequency and level settings.



Note that the shown diagrams represent the behaviour in theory. In real signal generation, the instruments usually have a blank time when the frequency or level changes.

Interactions and characteristics of list and sweep mode

- Activating the list mode automatically deactivates all RF and LF sweeps and vice versa.
- In list processing mode, the frequency and level display in the status bar is disabled.

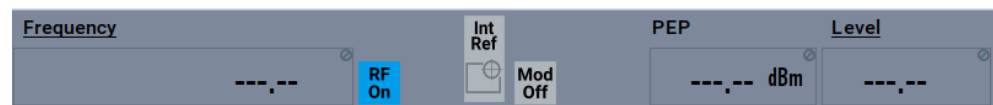

- The sweep modes only work with a *global* dwell time, that means the time intervals are constant during signal generation.
- If you want to hold a running sweep at a specific frequency or level value, enter the value in the status bar. The sweep stops immediately.
- We recommend that you switch off the display update for optimum sweep performance, especially with short dwell times
See [Chapter 12.1.2, "Display update settings"](#), on page 446.

8.9.1 Signal generation and triggering in the sweep and list modes

In both operating modes "List" and "Sweep", triggering and signal generation follow the same principle. The instrument generates the signal continuously (that means triggered automatically) or in individual steps (controlled manually by an internal or external trigger signal).



If the dwell time in sweep or list mode is too short or external trigger signals come too fast, the signal generation delays. As the delay increases, the R&S SMCV100B signals an overrun, or even stops sweep or list mode signal generation, if the delay gets too long.

The instrument displays corresponding error messages.

The figures in this section give an overview on the signal generation in the sweep and list modes and the appropriate triggering. The figures show the signal state after activating the mode and the generation of the signal when a trigger event occurs. For each mode, the relevant parameters and settings are briefly explained.

Each "Sweep" and "List" mode dialog provides also a "Reset" function that sets the signal to the initial value or the beginning of the list. Depending on the selected trigger mode, the signal generation proceeds accordingly.



The naming of the selection parameters in manual control (GUI) sometimes deviates from the naming in the remote-control commands. In addition, the value names of the selection parameters used in the signal generator partly differ from the SCPI syntax. The instrument accepts all value names.

The correlation between the manual control and the corresponding remote control commands, including the SCPI conform syntax are explained for each mode (see the cross-reference tables).

See also the following programming examples on the sweep and list modes in remote control:

- [Example "Setup an RF frequency or power sweep"](#) on page 801
- [Example "Create an RF list and activate the list mode"](#) on page 772

Auto mode (Sweep/List)

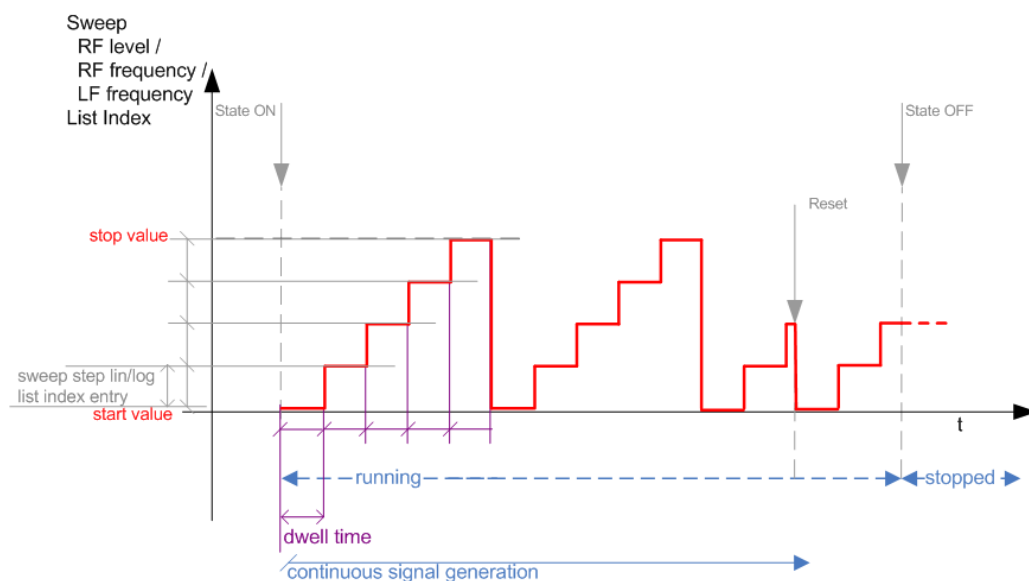

Figure 8-4: Auto mode (Sweep/List)

- The instrument generates the signal continuously.
- Trigger mode "Auto" is prerequisite (default). It causes the continuous generation of the sweep signal.
- Starts signal generation immediately with "State = On".
- Switches automatically to the next step when the **Dwell time** has elapsed.
- Stops signal generation with "State = Off".

Table 8-1: Cross-reference between manual and remote control in Auto mode (Sweep/List)

Manual control mode: "Auto"	Remote commands Rohde & Schwarz proprietary and [SCPI conform] value name
RF frequency sweep	:TRIGger<hw>:FSWEEP:SOURce AUTO [IMMEDIATE] :SOURce<hw>:SWEep:FREQUency:MODE AUTO
RF level sweep	:TRIGger<hw>:PSWEEP:SOURce AUTO [IMMEDIATE] :SOURce<hw>:SWEep:POWer:MODE AUTO
List	:SOURce<hw>:LIST:MODE AUTO :SOURce<hw>:LIST:TRIGger:SOURce AUTO

Single / Extern Single mode (Sweep/List)

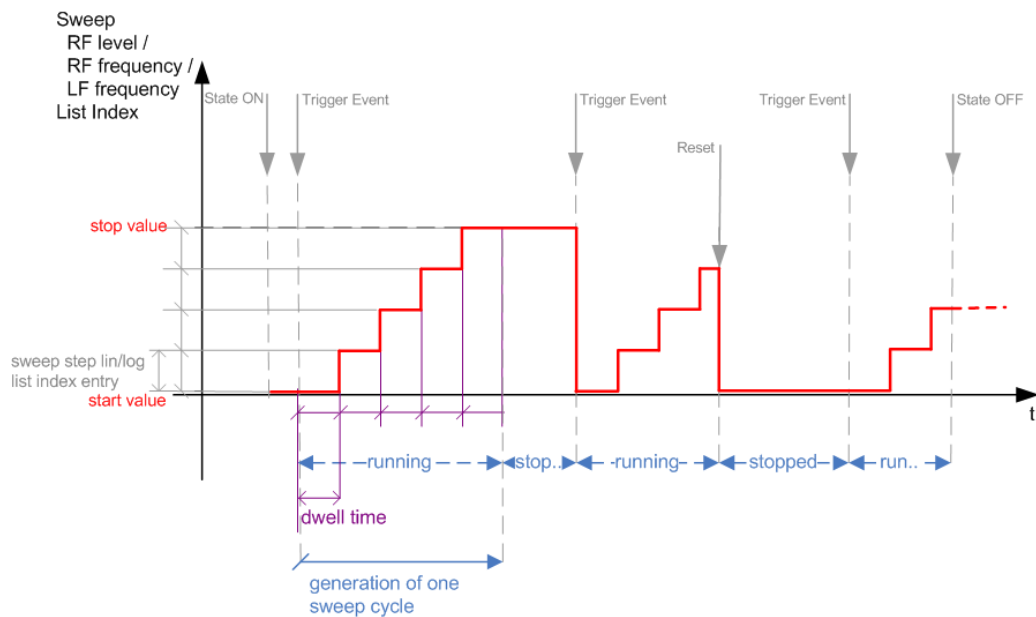

Figure 8-5: Single / Extern Single mode (sweep / list)



In single mode, you can specify, that the signal returns to the start value when a sweep cycle has been completed.

See "[The Retrace function](#)" on page 325 for details.

- The instrument generates a single sweep cycle.

- Trigger mode "Manual". A trigger event initiates one sweep from the start value to the end value.
- "State = On" sets the signal to the start value: the sweep start frequency, the sweep start power or the frequency-power value pair of the selected index in the list.
- Starts signal generation with a trigger event.
- Switches automatically to the next step when the [Dwell time](#) has elapsed.
- Stops signal generation at the set end value and waits for the subsequent trigger event.
- Trigger sources:
 - The "Execute Single Sweep" function.
 - The corresponding remote control command.
 - An externally applied trigger signal.
- "State = Off" stops the signal generation in sweep or list mode.

Table 8-2: Cross-reference between manual and remote control in Single / Extern Single modes (Sweep/List)

Manual control mode: "Single / Extern Single"	Remote commands Rohde & Schwarz proprietary and [SCPI conform] value name
RF frequency sweep	:TRIGger<hw>:FSweep:SOURce SINGLE [BUS] "Single" or :TRIGger<hw>:FSweep:SOURce EXTERNAL [EXTERNAL] "Extern Single" :SOURce<hw>:SWEep:FREQuency:MODE AUTO
RF level sweep	:TRIGger<hw>:PSweep:SOURce SINGLE [BUS] for "Single" or :TRIGger<hw>:PSweep:SOURce EXTERNAL [EXTERNAL] for "Extern Single" :SOURce<hw>:SWEep:POWer:MODE AUTO
List	:SOURce<hw>:LIST:TRIGger:SOURce SINGLE "Single" or :SOURce<hw>:LIST:TRIGger:SOURce EXTERNAL "Extern Single" :SOURce<hw>:LIST:MODE AUTO

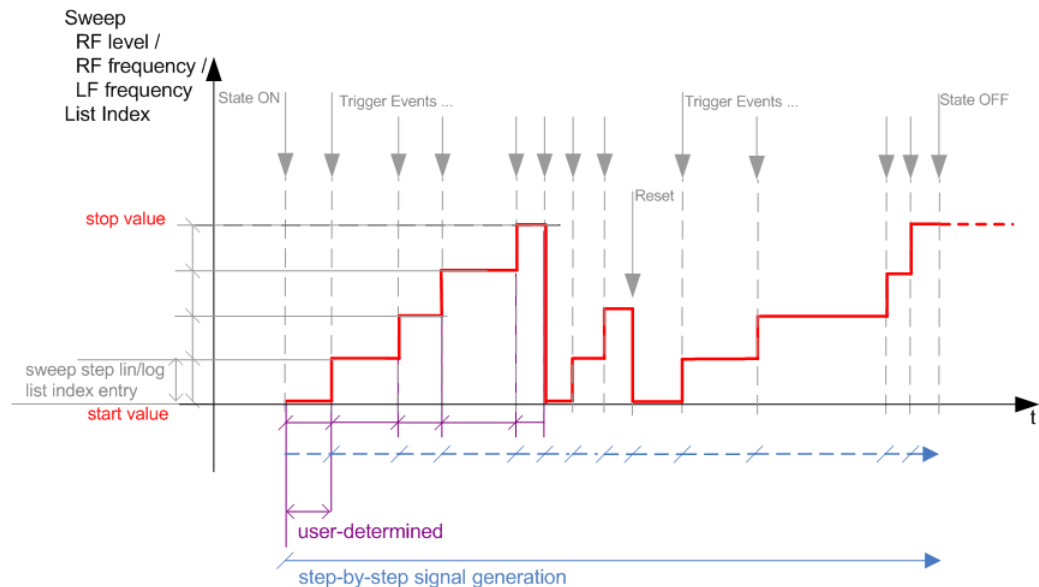
Step / Extern Step mode (Sweep/List)**Figure 8-6: Step / Extern Step mode (sweep / list)**

- The instrument generates the signal step-by-step.
- Starts signal generation with "State = On".
- Switches to the next step with a manual action.
If the end value is reached, signal generation starts again from the beginning.
- Stops signal generation with "State = Off".
- Trigger sources:
 - The rotary knob at the front panel.
 - The corresponding remote control commands.
 - An externally applied trigger signal.

To step through the sweep frequencies or levels:

- In manual mode:
 - Set the [Current Frequency](#) or [Current Level](#) values
- In remote control mode:
 - Use the commands `[:SOURce<hw>] :FREQuency:MANual` or `[:SOURce<hw>] :POWer:MANual` with the UP or DOWN parameter



Steps that would exceed the sweep range are ignored.

Table 8-3: Cross-reference between manual and remote control in Step / Extern Step modes (Sweep/List)

Manual control mode: "Step / Extern Step"	Remote commands Rohde & Schwarz proprietary and [SCPI conform] value name
RF frequency sweep	:TRIGger<hw>:FSWEEP:SOURce SINGLE [BUS] "Step" or :TRIGger<hw>:FSWEEP:SOURce EXTERNAL [EXTERNAL] for "Extern Step" :SOURce<hw>:SWEep:FREQuency:MODE STEP
RF level sweep	:TRIGger<hw>:PSWEEP:SOURce SINGLE [BUS] "Step" or :TRIGger<hw>:PSWEEP:SOURce EXTERNAL [EXTERNAL] "Extern Step" :SOURce<hw>:SWEep:POWer:MODE STEP
List	:SOURce<hw>:LIST:TRIGger:SOURce SINGLE "Step" or :SOURce<hw>:LIST:TRIGger:SOURce EXTERNAL "Extern Step" :SOURce<hw>:LIST:MODE STEP

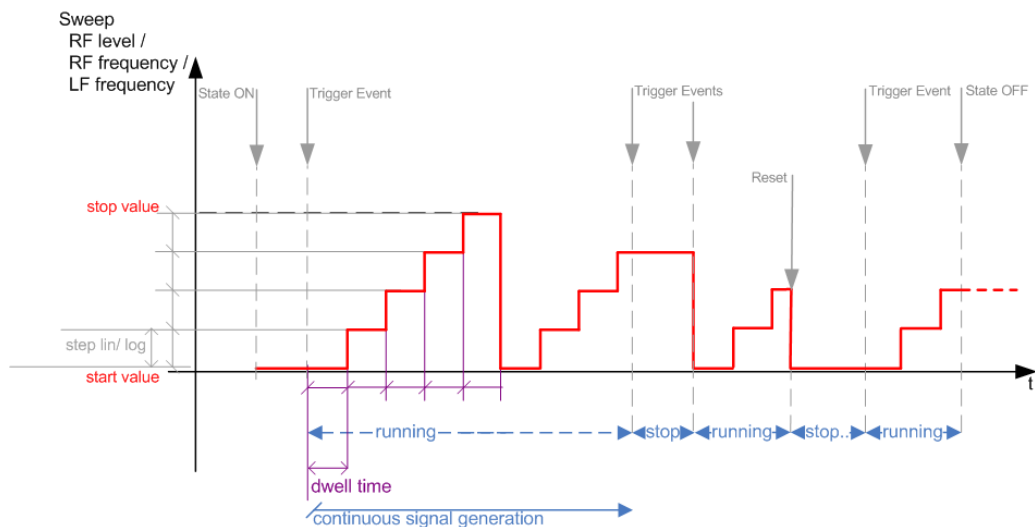
Extern Start/Stop mode (sweep)**Figure 8-7: Extern Start/Stop mode (sweep)**

- The instrument generates the signal continuously.
- Trigger mode "Auto" and "Sweep > State = On" are prerequisite.
- State "On" sets the signal to the start value, that is one of the following:
 - Sweep start frequency
 - Sweep start power
 - Frequency-power value pair of the selected index in the list
- Starts signal generation with a trigger event.
- Switches automatically to the next sweep step when the **Dwell time** has elapsed. If the end value is reached, signal generation continues with the next sweep cycle.
- Stops signal generation with the next external trigger event.

- Starts the signal generation again with the next trigger event, beginning at the start value.
- "State = Off" stops the signal generation in sweep or list mode.
- Trigger source: An externally applied trigger signal.

Table 8-4: Cross-reference between manual and remote control in Extern Start/Stop modes (sweep)

Manual control mode: "Extern Start/Stop"	Remote commands Rohde & Schwarz proprietary and [SCPI conform] value name
RF frequency sweep	:TRIGger<hw>:FSWEEP:SOURce EAUTO [-] :SOURce<hw>:SWEep:FREQuency:MODE AUTO
RF level sweep	:TRIGger<hw>:PSWEEP:SOURce EAUTO [-] :SOURce<hw>:SWEep:POWer:MODE AUTO

Manual mode (Sweep/List)



The **manual** mode only applies to remote control. It is not visible in the graphical user interface of the instrument and is described here for completeness.

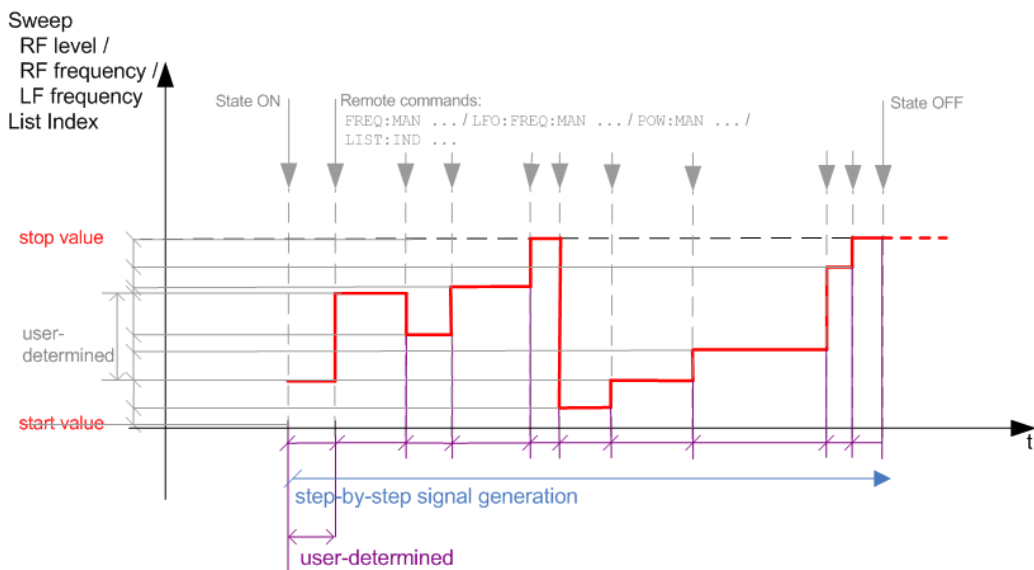

Figure 8-8: Manual mode in remote control (sweep / list)

- The instrument generates the signal in steps.
- Starts signal generation with "State = On".
- Switches to the next step with a user defined setting via remote control. You can arbitrarily select a value within the range of the start and stop values by setting the frequency, power or index using the corresponding remote control command. There is no ascending or descending order.
- Stops signal generation with "State = Off".

Table 8-5: Remote control commands in manual mode (Sweep/List)

Remote control mode:	Remote commands
Manual	Rohde & Schwarz proprietary and [SCPI conform] value name
RF frequency sweep	:SOURce<hw>:FREQuency:MANUal <Manual>
RF level sweep	:SOURce<hw>:POWer:MANUal <Manual>
List	:SOURce<hw>:LIST:INDex <Index>

The Retrace function

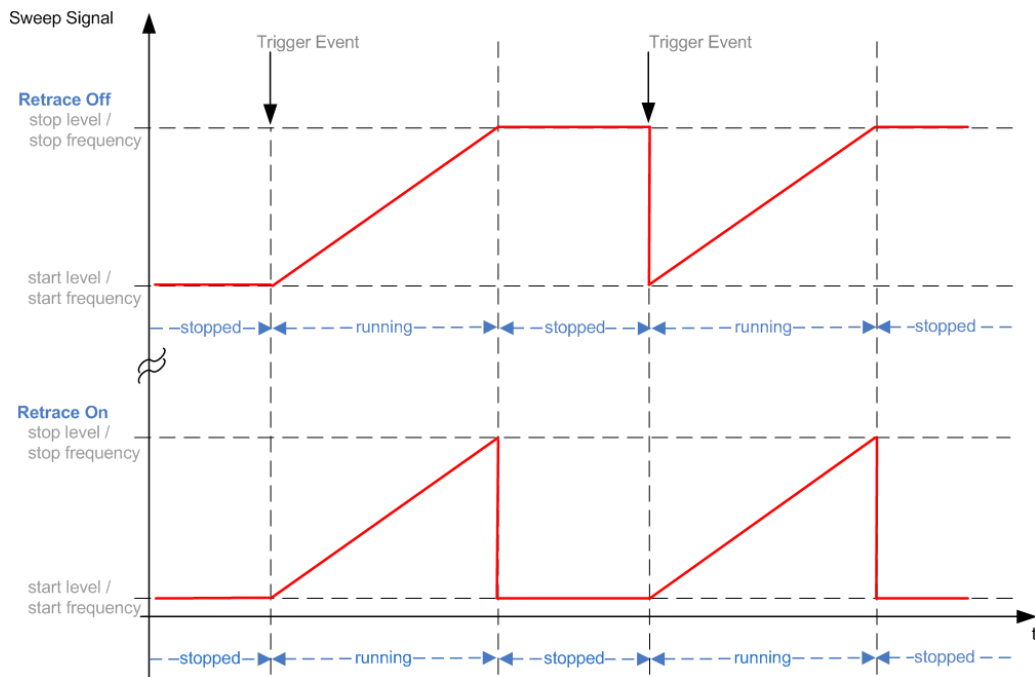

Retrace is a function especially designed for "Single" sweep modes, when the sweep signal follows a sawtooth shape. Working in this mode, the instrument performs a single sweep cycle when a trigger event occurs. The signal generation stops at the set end point (stop frequency or stop level), and waits for the next trigger event.

In this state, the upper value of the signal remains at the output until the next cycle starts. In particular, if you generate a level sweep signal, the high amplitude of the signal is output for a certain time. To protect the DUT from overload, the retrace function immediately resets the signal value to the start value at the end of a sweep cycle. It returns to the start level or start frequency until the next trigger is applied.

You can use the "Retrace" function if "Sweep > Mode = Single/External Single" and "Shape = Sawtooth", see:

- "Shape" on page 335
- "Mode" on page 334

8.9.2 About sweep mode

In sweep mode, the signal generator scans the sweep range gradually from one point to another, using a defined step size and following a triangle or sawtooth shape. This mode also enables you to change direction, that means, it is possible to step backwards.

See [Chapter 8.9.2.2, "Sweep signal shapes"](#), on page 328.

Configuration and operation of sweep mode signals

- The R&S SMCV100B generates a sweep signal by varying the following parameters: either the *RF frequency*, the *RF level* or both, the *RF frequency* and the *RF level* in combined RF sweep mode, or the *LF frequency*.
- In all sweep modes, you can perform a complete sweep cycle once, repeat the cycle continuously or step through it gradually.
- The instrument generates the sweep signal according to the sweep settings.
- The "Reset Sweep" function, provided in the sweep settings dialogs enables you to reset the sweep to its initial value and restart it.



Impact of changing the sweep mode during performance

If you change the sweep mode during the execution, the signal generator stops the sweep and starts with the next trigger event at the initial value.

Combined RF frequency / level sweep processing mode

The combined RF sweep functionality processes the signal similar to the Live list mode. The R&S SMCV100B sets the frequency and level values simultaneously in the hardware. The difference to the list mode is that the values are not taken from a previously created list, but are calculated using the selected frequency and level ranges, the dwell time and the number of steps.

8.9.2.1 Correlating parameters in sweep mode

A sweep signal is a periodic signal that changes its frequency or level, or both, from a starting value to an ending value in a defined time.

The R&S SMCV100B provides various possibilities to configure a sweep signal. For example, you can determine the sweep range by the start and end values, or based on the start value and span. In any case, related parameters are adjusted accordingly.

The formulas below show how the sweep parameters correlate and the corresponding calculation basis, by the frequency and offset settings. Apart from "Center Frequency", "Span" and "Step_lin", the values apply accordingly to the level settings.

Table 8-6: Variables that are used in the following formulas

Variable	Description
Sweep range	Defined frequency or level value range
f_{CENTer}	Defined center frequency

Variable	Description
f_{SPAN}	Defined extend of the sweep range
f_{OFFSet}	Frequency offset
f_{START}	Start frequency of the sweep range
f_{STOP}	End frequency of the sweep range
f_1	Current sweep frequency
f_2	Next, subsequent sweep frequency
step_lin	Step size in linear scaling
step_log	Step size in logarithmic scaling
POINTS	Number of steps within the sweep range

Sweep range

The sweep range is defined by a start and an end value. How the remaining parameters correlate is shown below.

Offset = 0

Sweep Range = f_{START} to f_{STOP}

$$f_{CENTer} = (f_{START} + f_{STOP})/2$$

$$f_{SPAN} = (f_{STOP} - f_{START})$$

Where:

$$f_{START} = f_{CENTer} - (f_{SPAN}/2)$$

$$f_{STOP} = f_{CENTer} + (f_{SPAN}/2)$$

Offset≠0

A defined offset also affects the sweep range and the center frequency. Therefore, the set frequencies are only absolute values, if the Offset = 0. Offset ≠ 0 shifts the frequencies with the offset value:

Sweep Range = $f_{START} + f_{OFFSet}$ to $f_{STOP} + f_{OFFSet}$

$$f_{CENTer} = f_{CENTer} + f_{OFFSet}$$

$$f_{SPAN} = f_{SPAN} + f_{OFFSet}$$

The value range of the instrument is calculated as follows:

$$RF_{min} + f_{OFFSet} \text{ to } RF_{max} + f_{OFFSet}$$



It is possible to set $f_{START} > f_{STOP}$ and $f_{START} < f_{STOP}$, so that even a negative value is permitted for the "Span".

If you change the start and/or stop frequency, the span and center frequency change accordingly, and vice versa.

Sweep steps

In the following, you see how the sweep steps are calculated depending on the defined spacing mode. The formulas show a frequency sweep, but apply to the level settings in the same way.

The step size is added to the current value, to get the subsequent sweep step.

With **linear** scaling, the next frequency is calculated according to:

$$f_2 = f_1 + \text{step_lin}$$

In the **logarithmic** scaling, the step size is determined in per cent, as a constant fraction of the current frequency.

Successive frequencies are calculated as follows:

- For $f_{\text{START}} < f_{\text{STOP}}$
 $f_2 = f_1 * (1 + \text{step_log}/100)$
 If $f_2 > f_{\text{STOP}}$, then $f_2 = f_{\text{STOP}}$
- For $f_{\text{START}} > f_{\text{STOP}}$
 $f_2 = f_1 / (1 + \text{step_log}/100)$
 If $f_2 < f_{\text{STOP}}$, then $f_2 = f_{\text{STOP}}$

With "Shape = Triangle", the frequency values on the slope from f_{STOP} to f_{START} are the same as on the slope from f_{START} to f_{STOP} .

If you specify the number of steps within the sweep range, the step size is adjusted according to the following correlation:

- For **linear** sweeps and $f_{\text{START}} < f_{\text{STOP}}$
 $\text{POINTS}_{\text{frequency}} = ((f_{\text{START}} - f_{\text{STOP}})/\text{step_lin}) + 1 = (f_{\text{SPAN}}/\text{step_lin}) + 1$
- For **logarithmic** sweeps and $f_{\text{START}} < f_{\text{STOP}}$
 $\text{POINTS}_{\text{frequency}} = ((\log f_{\text{STOP}} - \log f_{\text{START}})/\log \text{step_log}) + 1$

If step_log changes, the value of POINTs is adjusted. The f_{START} and f_{STOP} values are retained.

8.9.2.2 Sweep signal shapes

The R&S SMCV100B supports the following sweep shapes:

- Sawtooth
 The sweep sequence resembles a sawtooth. One sweep runs from start to stop frequency, or level value respectively. Each subsequent sweep starts again at the start value.

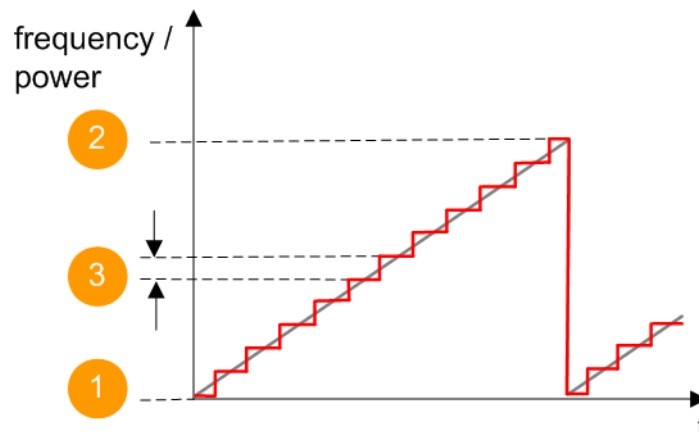

Figure 8-9: Sweep signal sawtooth shape

1 = Start value
2 = Stop value
3 = Step size

- Triangle
The sweep sequence resembles a triangle. One sweep runs from start to stop value frequency and back. Each subsequent sweep starts at the start value.

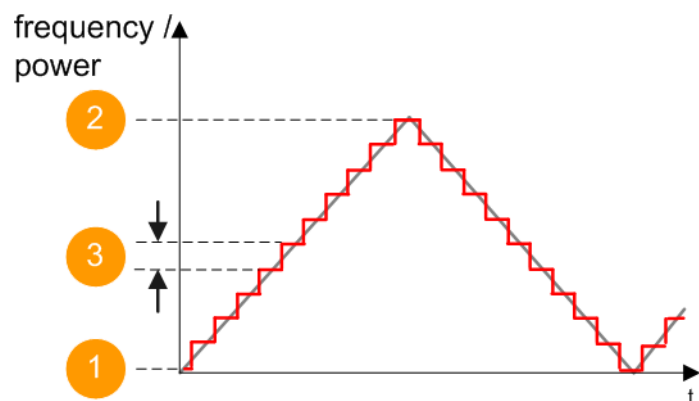

Figure 8-10: Sweep signal triangle shape

1 = Start value
2 = Stop value
3 = Step size

The current frequency or level of an RF frequency, level or LF frequency sweep is determined by the shape (e.g. sawtooth or triangle) and the spacing (linear or logarithmic), and the step size.

8.9.3 About list mode

The list mode is used to generate the RF signal based on a set of predefined frequency and amplitude value pairs, with individual step times. You can define the values arbitrarily, in any order and varying step sizes, within the entire configurable value range of the instrument.

Configuration and operation of list mode signals

The parameters configuring the RF signal are defined in a list (table) and stored in a file.

Creating and handling lists

List files can be created in the following ways:

- **Internally**
Use the build-in table editor with columns for the frequency-level values pairs and the dwell time.
Define the values manually (row by row) or automatically, based on value range and step size.
(See [Chapter 8.9.7, "List editor"](#), on page 347)
Lists are saved as files with user-definable filename and the predefined file extension *.lsw. To load a saved file, use the "File Manager".
(See [Chapter 11.8, "Using the file manager"](#), on page 428)
- Lists can be exported, too. For example, to exchange configuration between instruments or to modify the file content with an external program and reload them again.
- **Externally**
Create a list file as a CSV file with Microsoft Excel, with a Notepad or a similar tool and save it with the predefined extension. Transfer the file to and load it into the instrument.

Dwell time mode

You can choose whether you want to use different dwell times or a fixed value for all steps in the list mode:

- "From List"
This mode uses the values from the data table.
See [Edit List Mode Data](#)
- "Global"
This mode processes the list with a fixed time interval you can set with [Global Dwell Time](#).

List processing mode

8.9.4 Significant parameters and functions

This section provides some basic parameters, settings and functions that affect the operating modes CW, list and sweep, that means at all frequency and level transitions of the RF signal.

Dwell time

Dwell time is the length of time that elapses from the beginning until the end of a step in list or sweep mode.

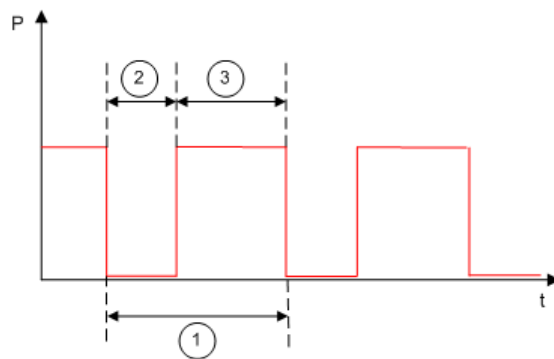

Figure 8-11: Dwell Time vs. settling time

- 1 = "Dwell Time" (as set with the parameter)
- 2 = Settling time
- 3 = Dwell time (effective)

However, the time the instrument requires for the signal to settle reduces the set dwell time:

$$t_{\text{dwell(effective)}} = t_{\text{dwell}} - t_{\text{settling}}$$



If the dwell time in sweep or list mode is too short or external trigger signals come too fast, the signal generation delays. As the delay increases, the R&S SMCV100B signals an overrun, or even stops sweep or list mode signal generation, if the delay gets too long.

The instrument displays corresponding error messages.

Hardware adjustments

The first time a list (new or modified) is processed, the instrument automatically calculates the necessary hardware settings. It can be performed during list processing, but delays the first cycle, especially with short dwell times.

With long dwell times, you can perform this calculation while the list is being processed; the entered dwell times are observed. With short dwell times, calculation of the hardware settings increases the dwell time for the initial processing cycle; the entered value is only observed from the second processing cycle onwards. In this case, a message indicates that there is a deviation between the current and set dwell times. After the first cycle, you do not need to perform additional calculations. The current dwell times do not deviate from the set dwell times.

Blanking

The instrument applies *blanking*, which temporarily turns off the RF signal when the frequency or level changes, until the signal has settled to a stable state.

Temporary blanking applies to all operating modes.

Learn List Mode Data list processing mode

Before signal generation starts, the instrument reads the values of the data list in sequence and determines the corresponding hardware settings for each value pair. Along with the current RF state and the modulation settings, the function stores the list data in the temporary memory.

Once the entire table is processed, the R&S SMCV100B starts signal generation by replaying the stored values from the list. Thus, it achieves fast switching of the RF signal with high accuracy.

This mode provides optimized switching times, and is particularly useful if dwell times of less than 2 ms are required.

However, consider that R&S SMCV100B generates the signal from the saved data, thus reflecting the state of the instrument at the time of recording. Modifications of settings during list processing are ignored. If you turn off the instrument, the list file remains saved on the internal memory, but not the learned data in the temporary memory.



When to use the "Learn List Mode Data" function

The instrument performs the learning process in the following situations:

- RF state is on (prerequisite)
- You deliberately activate this function, provided a list is loaded and RF is on.
- You switch list mode on in "Learned" run mode and no data is available in the memory
- You change the list data file

Perform the list mode learning in the following situations:

- Always when:
 - You change any value in the list.
 - Any hardware setting changes.
Especially if you have fluctuating environmental conditions, the hardware settings need to be adjusted.
- We recommend that you learn the list before activating the list mode, even if the list has been learned previously.

Live list processing mode

The R&S SMCV100B generates the signal directly from the value pairs in the database, and adjusts the hardware settings accordingly. The current instrument state and thus any change during the signal generation directly affects the RF signal. The temporary memory is not used.

You can conveniently modify parameters like modulation settings during run-time. Learning list mode data is not required. Impacts like temperature drift are also considered immediately.

This mode is optimized for **maximum signal quality**, and is useful if dwell times higher than 2 ms are sufficient.

8.9.5 Sweep mode settings

This section lists the settings of **all** available sweep modes.

Access:

1. Select "RF" > "Sweep/List" > "RF Frequency Sweep"
2. Select "RF" > "Sweep/List" > "RF Level Sweep"

The sweep modes use the similar parameters to be configured. Thus, the description comprises the settings of the three dialogs, "RF Frequency Sweep", "RF Level Sweep" and "LF Frequency Sweep". If parameters relate to only particular modes, they are pointed out.

The remote commands required to define these settings are described in:

- [Chapter 14.16.5, "SOURce:FREQuency subsystem"](#), on page 759
- [Chapter 14.16.11, "SOURce:POWEr subsystem"](#), on page 785
- [Chapter 14.16.13, "SOURce:SWEep subsystem"](#), on page 800

Settings

- [General sweep settings](#).....333
- [Global connector settings](#).....338
- [Frequency range settings](#).....338
- [Level range settings](#).....340

8.9.5.1 General sweep settings

Access:

- ▶ Select, for example, "RF" > "Sweep/List" > "RF Frequency Sweep".

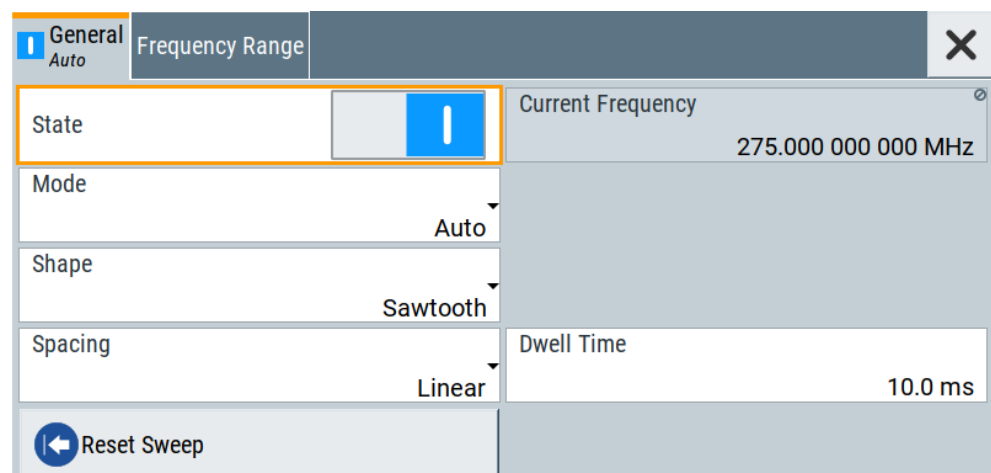

Settings

State (RF frequency sweep).....	334
State (RF level sweep).....	334
Current Frequency.....	334
Current Level.....	334
Mode.....	334
Retrace.....	335
Shape.....	335
Spacing.....	337
Dwell Time.....	337
Trigger Slope.....	337
Execute Single Sweep.....	337
Reset Sweep.....	337

State (RF frequency sweep)

Activates RF frequency sweep signal generation.

Note: Active sweep mode deactivates other sweeps or lists and vice versa.

Remote command:

[:SOURce<hw>] :FREQuency:MODE on page 760

State (RF level sweep)

Activates RF level sweep signal generation.

Note: Active sweep mode deactivates other sweeps or lists and vice versa.

Remote command:

[:SOURce<hw>] :POWer:MODE on page 789

Current Frequency

Displays the current frequency sweep value for all sweep **Modes**, except of **Mode > Step**. In this mode, you can enter the next frequency setting manually.

Remote command:

[:SOURce<hw>] :FREQuency:MANual on page 762

Current Level

Displays the current level sweep value for all sweep **Modes**, except of **Mode > Step**. In this mode, you can enter the next level setting manually.

Remote command:

[:SOURce<hw>] :POWer:MANual on page 788

Mode

Selects the sweep mode.

See [Chapter 8.9.1, "Signal generation and triggering in the sweep and list modes"](#), on page 318.

"Auto" Generates a continuously repeating sweep signal directly after activating the sweep mode.
The sweep steps are performed automatically, controlled by the dwell time.

"Single / Extern Single"

Generates a single sweep cycle after a trigger event.
The sweep steps within the cycle are performed automatically, controlled by the dwell time. If one cycle is completed, the instrument waits for the next trigger event.

"Step / Extern Step"

Generates the sweep signal step-by-step, manually triggered.

"Extern Start/Stop"

Generates a continuously repeating sweep signal that is started, stopped, and restarted by subsequent external trigger events.
The sweep steps are performed automatically, controlled by the dwell time.

Remote command:

RF frequency sweep:

[:SOURce<hw>] :SWEep [:FREQuency] :MODE on page 805
:TRIGger<hw> :FSweep :SOURce on page 837

RF level sweep:

[:SOURce<hw>] :SWEep :POWer :MODE on page 803
:TRIGger<hw> :PSweep :SOURce on page 837

Retrace

For "Shape = Sawtooth" and "Mode = Single/External Single", enables changing the signal to the start value while it is waiting for the next trigger event. It returns to the start level or start frequency until the next trigger is applied.

Remote command:

RF frequency sweep:

[:SOURce<hw>] :SWEep [:FREQuency] :RETRace on page 807

RF level sweep:

[:SOURce<hw>] :SWEep :POWer :RETRace on page 807

Shape

Selects the waveform shape of the sweep signal.

"Sawtooth"

The sweep runs from start to stop frequency. The subsequent sweep starts at the start value, i.e. the shape of the sweep sequence resembles a sawtooth.

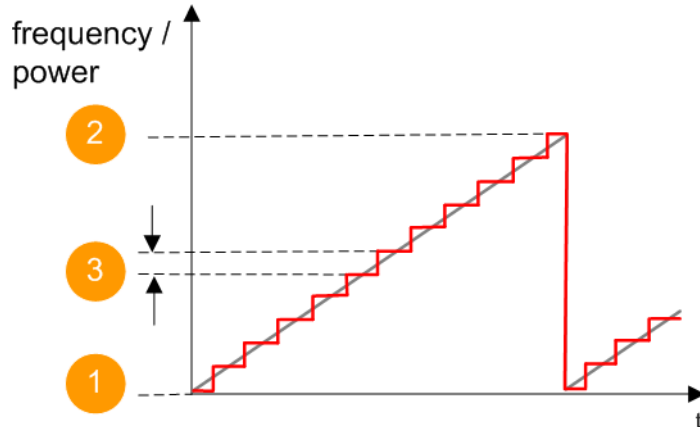

Figure 8-12: Sweep signal sawtooth shape

1 = Start value
2 = Stop value
3 = Step width

"Triangle"

The sweep runs from start to stop value and back, i.e. the shape of the sweep resembles a triangle. Each subsequent sweep starts at the start frequency.

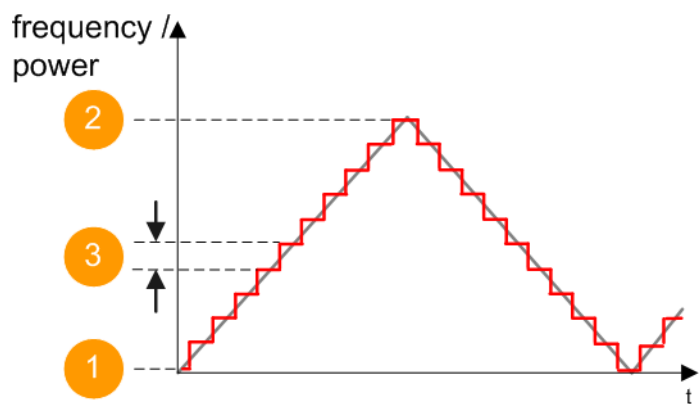

Figure 8-13: Sweep signal triangle shape

1 = Start value
2 = Stop value
3 = Step width

Remote command:

RF frequency sweep:

[\[:SOURCE<hw>\]:SWEep\[:FREQuency\]:SHApe](#) on page 806

RF level sweep:

[\[:SOURCE<hw>\]:SWEep:POWer:SHApe](#) on page 806

Spacing

Selects the mode for calculating the frequency interval, which increases or decreases the current frequency at each step.

To determine the step size, select the parameter [Step Linear/Step Logarithmic](#).

- "Linear" Takes the frequency value entered as absolute value in Hz.
- "Logarithmic" Takes the value entered as a logarithmic value, i.e. as a constant fraction of the current frequency in %.

Remote command:

RF frequency sweep:

`[:SOURce<hw>] :SWEep [:FREQuency] :SPACing` on page 805

Dwell Time

Defines the duration of the individual sweep steps.

Note: In case of considerable overrun conditions, the R&S SMCV100B turns off the sweep mode.

See also [Chapter 8.9.4, "Significant parameters and functions"](#), on page 330.

Remote command:

`[:SOURce<hw>] :SWEep [:FREQuency] :DWELl` on page 804

`[:SOURce<hw>] :SWEep :POWer :DWELl` on page 803

Trigger Slope

For "Mode = Extern Step/Single", selects the polarity of the active slope of an applied instrument trigger.

Trigger signal is expected at one of the User x connectors.

See also [Chapter 12.2, "Configuring global connectors"](#), on page 449.

- "Positive" The rising edge of the trigger signal triggers the instrument.
- "Negative" The falling edge of the trigger signal triggers the instrument.

Remote command:

`[:SOURce] :INPut :TRIGger :SLOPe` on page 765

Execute Single Sweep

In "Mode = Single", starts a sweep manually.

Remote command:

RF frequency sweep:

`[:SOURce<hw>] :SWEep [:FREQuency] :EXECute` on page 806

`:TRIGger<hw> :FSWeep [:IMMediate]` on page 838

RF level sweep:

`[:SOURce<hw>] :SWEep :POWer :EXECute` on page 806

`:TRIGger<hw> :PSWeep [:IMMediate]` on page 838

General:

`:TRIGger<hw> [:SWEep] [:IMMediate]` on page 838

Reset Sweep

Resets a sweep.

With the next trigger event, the sweep starts at the initial value.

Remote command:

[:SOURce<hw>] :SWEep:RESet [:ALL] on page 808

8.9.5.2 Global connector settings

The "Input Signal" dialog, the "Trigger/Marker/Clock" dialog and "Trigger In", "Marker" and "Clock" tabs in "Baseband > ARB/Custom Digital Mod" configuration dialogs provide quick access to the related connector settings. Click the "Global Connectors" button to access the settings.

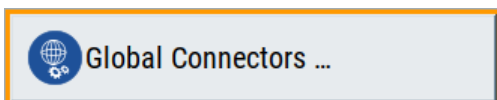

See also [Chapter 12.2, "Configuring global connectors"](#), on page 449.

8.9.5.3 Frequency range settings

Access:

1. Select for example "RF" > "Sweep/List" > "RF Frequency Sweep"
2. Select "Frequency Range".

General Step		Frequency Range		
Start Frequency	100.000 000 000 MHz	Stop Frequency	500.000 000 000 MHz	
Center Frequency	300.000 000 000 MHz	Span	400.000 000 000 MHz	
Spacing	Linear	Step Linear	1.000 000 00 MHz	

Settings

Start Frequency/Stop Frequency.....	338
Center Frequency.....	339
Span.....	339
Spacing.....	339
Step Linear/Step Logarithmic.....	339

Start Frequency/Stop Frequency

Defines the frequency sweep range by setting the start and end values.

See [Chapter 8.9.2.1, "Correlating parameters in sweep mode"](#), on page 326.

Remote command:

RF frequency sweep:

[:SOURce<hw>] :FREQuency:START on page 763

[:SOURce<hw>] :FREQuency:STOP on page 764

Center Frequency

In "RF Frequency Sweep" mode, sets the RF center frequency.

See [Chapter 8.9.2.1, "Correlating parameters in sweep mode"](#), on page 326.

Remote command:

[:SOURce<hw>] :FREQuency:CENTer on page 763

Span

In "RF Frequency Sweep" mode, sets the span of the frequency sweep range.

See [Chapter 8.9.2.1, "Correlating parameters in sweep mode"](#), on page 326.

Remote command:

[:SOURce<hw>] :FREQuency:SPAN on page 763

Spacing

Selects the mode for calculating the frequency interval, which increases or decreases the current frequency at each step.

To determine the step size, select the parameter [Step Linear/Step Logarithmic](#).

"Linear" Takes the frequency value entered as absolute value in Hz.

"Logarithmic" Takes the value entered as a logarithmic value, i.e. as a constant fraction of the current frequency in %.

Remote command:

RF frequency sweep:

[:SOURce<hw>] :SWEep [:FREQuency] :SPACing on page 805

Step Linear/Step Logarithmic

Sets the step width for individual frequency sweep steps. The value is added at each sweep step to the current frequency.

Depending on the current [Spacing](#), you can enter either an absolute or logarithmic step width.

See [Chapter 8.9.2.1, "Correlating parameters in sweep mode"](#), on page 326.

"Step Linear" The step width is a constant value in Hz.

"Step Logarithmic"

The step width is determined logarithmically in %, i.e. as a constant fraction of the current frequency.

Remote command:

[:SOURce<hw>] :SWEep [:FREQuency] :STEP [:LINear]
on page 807

[:SOURce<hw>] :SWEep [:FREQuency] :STEP:LOGarithmic
on page 807

8.9.5.4 Level range settings

Access:

1. Select "RF" > "Sweep/List" > "RF Level Sweep"
2. Select "Level Range".

General		Level Range	
Start Level	-30.00 dBm	Stop Level	-10.00 dBm
Spacing	Linear	Step	1.00 dB
Setting Characteristics	Auto	Level Range	... dBm

Settings

Start Level / Stop Level.....	340
Spacing.....	340
Step.....	340
Setting Characteristics.....	341
Level Range.....	341

Start Level / Stop Level

Defines the RF level sweep range by setting the start and end values.

See [Chapter 8.9.2.1, "Correlating parameters in sweep mode"](#), on page 326.

Remote command:

RF level sweep:

`[:SOURce<hw>] :POWer:STARt` on page 790

`[:SOURce<hw>] :POWer:STOP` on page 790

Spacing

Indicates that the instrument distributes the level steps linearly (straight proportional), i.e. the level steps have the same size.

To determine the step size, use the parameter [Step](#).

Remote command:

n.a.

Step

Sets the step width for the RF level sweep in dB.

The "RF level sweep" mode increases or decreases the level value linearly by the set value.

Remote command:

`[:SOURce<hw>] :SWEep:POWer:STEP [:LOGarithmic]` on page 804

Setting Characteristics

Selects additional quality characteristics to optimize the behavior of the RF signal level for the specific application.

"Auto" Sets the RF output level automatically according to the selected mode.
In this mode, the instrument provides the highest dynamic range and fastest setting times, as specified in the data sheet.
The RF signal is shortly blanked when the step attenuator is switching.

"Uninterrupted" Suppresses blanking at level transitions. Frequency transitions can lead to an RF level blanking due to hardware-specific switching points.
This mode reduces the dynamic range of the instrument. The step attenuator is fixed.

Remote command:

`[:SOURce<hw>] :POWer:LBEHaviour` on page 788

Level Range

Shows the interruption-free range of the level that you can use in the currently selected mode.

Remote command:

`[:SOURce<hw>] :POWer:RANGe:LOWer?` on page 796

`[:SOURce<hw>] :POWer:RANGe:UPPer?` on page 796

8.9.6 List mode settings

The "List Mode" dialog contains all the functions and settings for creating and handling lists with RF frequency/level pairs for generating the RF signal based on these values.

Access:

- ▶ Select "RF" > "Sweep/List" > "List mode".

The dialog contains parameters for configuring the list mode processing, entering list mode data and transferring data files from or to the instrument.

The remote commands required to define these settings are described in [Chapter 14.16.9, "SOURce:LIST subsystem"](#), on page 771.

- [General settings](#).....342
- [List mode data settings](#).....345
- [Import/export settings](#).....346

8.9.6.1 General settings

Access:

- ▶ Select "RF" > "Sweep/List" > "List mode > General".

General Auto	List Mode Data None	
State	I	Current Index 0
Mode	Auto	
Dwell Time Mode	Global	Global Dwell Time 10.000 ms
Run Mode	Live	Learn List Mode Data

In the "General" tab, you can configure the trigger and dwell time modes for list processing and activate signal generation.

Settings

State.....	342
Current Index.....	342
Mode.....	343
Dwell Time Mode.....	343
Global Dwell Time.....	343
Run Mode.....	343
Learn List Mode Data.....	344
Trigger Slope.....	344
Show Connector.....	344
Reset.....	344
Execute Single.....	344

State

Activates the list mode and processes the currently selected list.

Note: Active sweep mode deactivates other sweeps or lists and vice versa.

Remote command:

[:SOURce<hw>] :FREQuency:MODE on page 760

Current Index

Sets the list index for list processing in "Step" mode. In the other modes, the index indicates the current step.

Remote command:

[:SOURce<hw>] :LIST:INDEX on page 776

Mode

Selects the mode for list processing.

See [Chapter 8.9.1, "Signal generation and triggering in the sweep and list modes"](#), on page 318.

"Auto" Generates the signal by processing the frequency/level value pairs of the list from the beginning to the end.
The list steps are performed automatically, controlled by the dwell time. If you switch from any mode to "Auto", signal generation always starts at the top of the list.

"Single / Extern Single"

Generates the signal by processing the frequency/level value pairs of the list once from the beginning to the end after a trigger event.
The list steps are performed automatically, controlled by the dwell time. If one cycle is completed, the instrument waits for the next trigger event.

"Step / Extern Step"

Generates the signal by processing the frequency/level value pairs of the list step-by-step, manually triggered.

Remote command:

`[:SOURce<hw>] :LIST:TRIGger:SOURce` on page 779

`[:SOURce<hw>] :LIST:MODE` on page 778

Dwell Time Mode

Selects either variable dwell times or a fixed dwell time to perform signal generation in list mode.

"Global" Uses the same dwell time for all lists steps, set with [Global Dwell Time](#).

"From List" Uses the dwell times from the list.
You can define the dwell time for each frequency/level value pair individually, see [Chapter 8.9.7, "List editor"](#), on page 347.

Remote command:

`[:SOURce<hw>] :LIST:DWELL:MODE` on page 775

Global Dwell Time

Sets the dwell time for [Dwell Time Mode](#) > "Global".

Note: In case of considerable overrun conditions, the R&S SMCV100B turns off the list mode.

See also ["Dwell time"](#) on page 330.

Remote command:

`[:SOURce<hw>] :LIST:DWELL` on page 774

Run Mode

Selects whether the instrument generates the signal by processing the list directly, or by learning and replaying the data.

"Learned (Frozen RF Settings)"

Generates the signal with the previously learned and stored data from the temporary memory.

"Live"

Generates the signal directly from the database. The instrument reads the pairs of values from the list, calculates the hardware settings and generates the signal immediately. See ["Live list processing mode"](#) on page 332.

Remote command:

`[:SOURce<hw>] :LIST:RMODe` on page 777

Learn List Mode Data

See also ["When to use the "Learn List Mode Data" function"](#) on page 332.

Remote command:

`[:SOURce<hw>] :LIST:LEARn` on page 777

Trigger Slope

For "Mode = Extern Step/Single", selects the polarity of the active slope of an applied instrument trigger.

Trigger signal is expected at one of the User x connectors.

See also [Chapter 12.2, "Configuring global connectors"](#), on page 449.

"Positive" The rising edge of the trigger signal triggers the instrument.

"Negative" The falling edge of the trigger signal triggers the instrument.

Remote command:

`[:SOURce] :INPut:TRIGger:SLOPe` on page 765

**Show Connector**

Accesses a dialog that displays the physical location of the selected connector on the front/rear panel of the instrument.

A blinking LED on the front/rear panel indicates the selected connector, too (see [Chapter 12.2.2.3, "Status indicators"](#), on page 450).

Reset

Resets the list to the starting point.

Remote command:

`[:SOURce<hw>] :LIST:RESet` on page 782

Execute Single

Manually starts list processing in "Single" mode.

Remote command:

`[:SOURce<hw>] :LIST:TRIGger:EXECute` on page 779

8.9.6.2 List mode data settings

Access:

1. Select "RF" > "Sweep/List" > "List mode".
2. Select "List Mode Data".

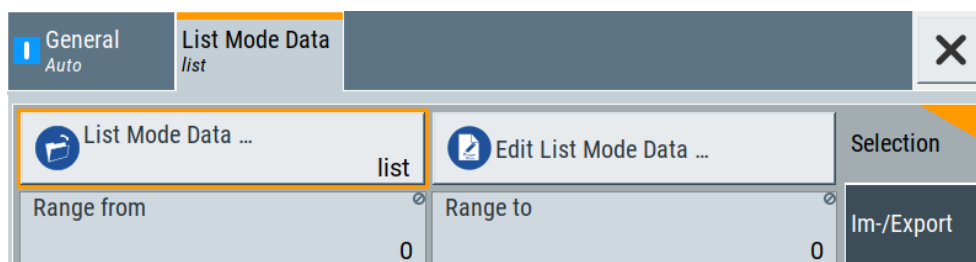

This dialog contains the parameters required for creating and editing lists, activating the learning function and selecting the list processing mode.

Settings

List Mode Data.....	345
Edit List Mode Data.....	345
List Range from/to.....	345

List Mode Data

Accesses the standard "Select List" dialog for selecting, creating and editing a list file. The currently loaded file is indicated.

You can create data lists with the internal editor or import externally created files, see ["Creating and handling lists"](#) on page 330.

Remote command:

- [:SOURce<hw>] :LIST:CATalog? on page 780
- [:SOURce<hw>] :LIST:SElect on page 782
- [:SOURce<hw>] :LIST:DElete on page 780
- [:SOURce<hw>] :LIST:DElete:ALL on page 781

Edit List Mode Data

Opens the editor to insert and save data lists with RF frequency, power and dwell time values, see [Chapter 8.9.7, "List editor"](#), on page 347.

You find this function also in standard file select dialog, accessed via [List Mode Data](#).

List Range from/to

Defines an index range in the current list by setting the start and stop index.

The instrument generates the signal with the values of the selected index range and ignores all other list entries.

Remote command:

- [:SOURce<hw>] :LIST:INDEX:START on page 777
- [:SOURce<hw>] :LIST:INDEX:STOP on page 777

8.9.6.3 Import/export settings

Access:

1. Select "RF" > "Sweep/List" > "List Mode".
2. Select "List Mode Data" > "Im-/Export".

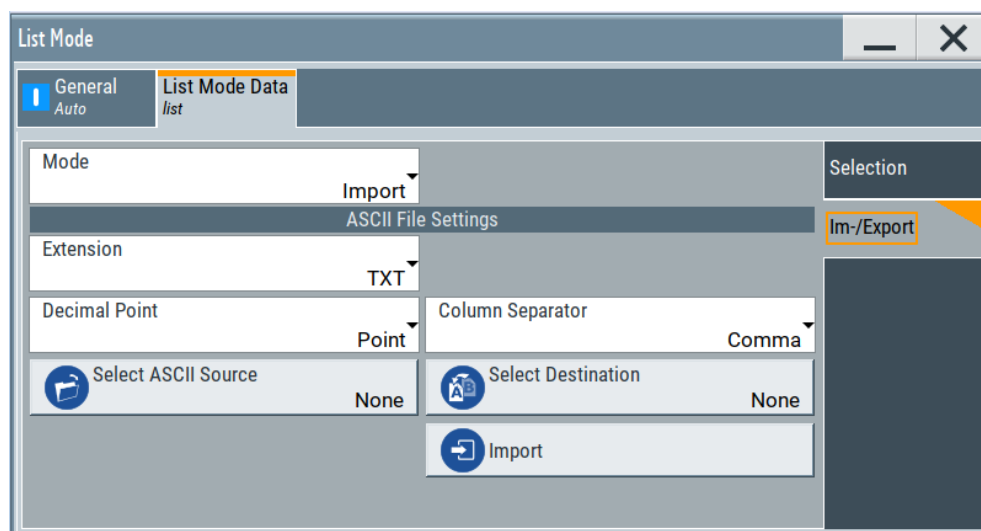

The "Im-/Export" dialog provides the parameters for importing or exporting files with user data in standard ASCII *.txt or *.csv file format.

The table separators and the decimal floating point numbers are customizable.

Settings

Mode.....	346
ASCII File Settings.....	346
Select (ASCII) Source/Select (ASCII) Destination.....	347
Select Source/Select ASCII Destination.....	347
Import / Export.....	347

Mode

Selects import or export of a data list file. The provided parameters vary according to the selected mode.

Remote command:

[:SOURCE<hw>] :LIST:DEXChange:MODE on page 784

[:SOURCE<hw>] :CORrection:DEXChange:MODE on page 759

ASCII File Settings

Defines the format and the separators of the associated data file.

"Extension"	Selects *.csv or *.txt format.
"Decimal Point"	Sets "Point" (dot) or "Comma" as the decimal separator used in the ASCII data with floating-point numerals.

"Column Separator"

Sets the separator between the columns in an ASCII table.
Available are: "Tab", "Semicolon", "Comma" or "Space".

Remote command:

[\[:SOURCE<hw>\]:LIST:DEXChange:AFILe:EXTension](#) on page 783
[\[:SOURCE<hw>\]:LIST:DEXChange:AFILe:SEParator:DECimal](#) on page 784
[\[:SOURCE<hw>\]:LIST:DEXChange:AFILe:SEParator:COLumn](#) on page 783
[\[:SOURCE<hw>\]:CORRection:DEXChange:AFILe:EXTension](#) on page 757
[\[:SOURCE<hw>\]:CORRection:DEXChange:AFILe:SEParator:DECimal](#)
 on page 758
[\[:SOURCE<hw>\]:CORRection:DEXChange:AFILe:SEParator:COLumn](#)
 on page 758

Select (ASCII) Source/Select (ASCII) Destination

In "Mode > Import", access the file select dialog that provides standard file handling functions.

Where:

- "Select ASCII Source": defines the file to be loaded (imported)
- "Select ASCII Destination": selects the filename under that the loaded file is saved

Remote command:

[\[:SOURCE<hw>\]:LIST:DEXChange:AFILe:CATalog?](#) on page 782
[\[:SOURCE<hw>\]:LIST:DEXChange:AFILe:SElect](#) on page 783
[\[:SOURCE<hw>\]:CORRection:DEXChange:AFILe:CATalog?](#) on page 757
[\[:SOURCE<hw>\]:CORRection:DEXChange:AFILe:SElect](#) on page 758

Select Source/Select ASCII Destination

In "Mode > Export", access the file select dialog that provides standard file handling functions.

Where:

- "Select Source": selects the file to be exported
- "Select ASCII Destination": defines the filename and the file path for the exported file

Remote command:

[\[:SOURCE<hw>\]:LIST:DEXChange:SElect](#) on page 784
[\[:SOURCE<hw>\]:CORRection:DEXChange:SElect](#) on page 759

Import / Export

Imports or exports the selected data list file, depending on the current mode.

Remote command:

[\[:SOURCE<hw>\]:LIST:DEXChange:EXECute](#) on page 783
[\[:SOURCE<hw>\]:CORRection:DEXChange:EXECute](#) on page 758

8.9.7 List editor

The "User Correction" and "List Mode" dialogs provide a build-in list editor for defining the corresponding value pairs.

The table and navigation functions of the UCOR and list mode editors have the same structure and are therefore summarized below. The access is specified for both modes, the fields and functions are explained using the example of the list mode.

Access to "Edit List Mode Data":

- ▶ "RF" > "Sweep/List" > "List Mode" > "List Mode Data" > "Edit List Mode Data"

The editor for list mode provides a table with RF frequency and power values, an extra column for defining variable dwell times, and standard navigation functions.

	Frequency /Hz	Power /dBm	Dwell Time /s
0	1 000 000 000.000	-20.00	0.001 000
1	540 000 000.000	-5.00	0.015 000
2	4 800 000 000.000	10.00	0.002 000
3	4 200 000 000.000	25.00	0.020 000
4	4 200 000 000.000	25.00	1.000 000
5	3 600 000 000.000	-15.00	0.500 000
6			

The remote commands required to define the list mode data are described in [Chapter 14.16.9, "SOURCE:LIST subsystem"](#), on page 771.

Access to "Edit User Correction Data":

- ▶ "RF" > "RF Level" > "User Correction" > "Edit User Cor. Data"

	Frequency /Hz	Correction Value /dB
0	1 560 000 000.00	11.51
1	1 561 000 000.00	11.03
2	1 562 000 000.00	10.55
3	1 563 000 000.00	10.07
4	1 564 000 000.00	9.59
5	1 565 000 000.00	9.11
6		

The editor for user correction data provides a table with RF frequency and power values and standard navigation functions.

The remote commands required to define the user correction data are described in [Chapter 14.16.4, "SOURce:CORRection subsystem"](#), on page 751.



All columns in a row must contain values. Cells with missing values are therefore filled automatically, using the value of the previous row.

If you use **global dwell time in list mode**, consider also that the instrument uses the value set with [Global Dwell Time](#) for all list steps and not the values from the list.

Since the table and navigation functions can be assumed to be known, the following description contains a brief overview, shown by the example of the "Edit List Mdoe Data" dialog. If a function relates to a particular dialog, it is explicitly stated.

Settings

Edit List Mode Data	349
Data handling keys	350
L Go To	350
L Edit	350
L Fill with Sensor	350
L Save As/Save	350
Fill	350

Edit List Mode Data

Table with values for list or user correction processing.

Note: Once you enter a value, the editor automatically adds preset values in the other columns. This functionality protects against data loss, otherwise incomplete rows are lost when saving. You can simply override these values.

"Frequency /Hz"

Sets the frequency values.

Remote command:

[\[:SOURce<hw>\]:LIST:FREQuency](#) on page 776

[\[:SOURce<hw>\]:CORRection:CSET:DATA:FREQuency](#)
on page 754

"Power /dBm" (list mode data table)

Sets the level values.

Remote command:

[\[:SOURce<hw>\]:LIST:POWer](#) on page 778

"Correction Value /dBm" (user correction data table)

Sets the level values.

Remote command:

[\[:SOURce<hw>\]:CORRection:CSET:DATA:POWer](#) on page 754

"Dwell /s"

In list mode, sets the dwell time values.

Remote command:

[:SOURce<hw>] :LIST:DWELL:LIST on page 775

Data handling keys

Standard functions for file and data handling.



Go To ← Data handling keys

Selects a row for editing.

Edit ← Data handling keys

Enables you to insert, or delete a row or ranges within a list, and provides access to a dialog for automatic filling, see "Fill..." on page 350.

Fill with Sensor ← Data handling keys

Opens a dialog to configure the automatic filling of user correction data with an R&S NRP power sensor. Available in UCOR mode only.

See [Chapter 8.10.2.3, "Fill with sensor"](#), on page 364

Save As/Save ← Data handling keys

Stores the list in a file with user-defined name and predefined file extension. To save a copy or create a file, use the "Save as" function.

Fill...

Provides parameters for filling a table automatically with user-defined values.

From 0	Range 4
Column To Fill Frequency /Hz	
Start Value 2.000 000 000 000 GHz	End Value 2.600 000 000 000 GHz
Increment Value 200.000 000 000 MHz	
<input checked="" type="checkbox"/> Fill	

To fill the table, select "Fill".

Note: Once you enter a value or fill a column, the editor automatically adds preset values in the other columns. This functionality protects against data loss, otherwise incomplete rows will be lost when saving. You can simply override these values.

"From / Range"	Defines the start line and number of lines to be filled.
"Column To Fill"	Selects, if the column is filled up with frequencies in Hz, levels in dBm or dwell times in s.
"Start Value / End Value"	Sets the start value for frequency, level or dwell time. The end value is read only and depends on the increment value and the range.
"Increment Value"	Determines the step size.
"Fill"	Fills the column specified in "Column To fill".

8.9.8 How to generate a signal in list or sweep mode

This section shows you how to configure a varying RF output signal for both, the list and sweep modes.

To configure the frequency sweep signal

1. In the status bar, enter "Freq = 6 GHz" and "Lev = -25 dBm".
2. Select "RF" > "Sweep/List" > "RF Frequency Sweep"
3. Select "Mode > Auto".
4. Select "Spacing > Linear".
5. Set "Dwell Time > 15.0 ms".
6. In the "Frequency Range" tab, set "Start Freq > 200 MHz" and "Stop Freq > 600 MHz".
(Alternatively you can set "Center Freq > 400 MHz" and "Span > 400 MHz".)
7. Set the step width "Step Lin > 10 MHz" and "Dwell Time > 10.0 ms".
8. In the "Advanced" tab, trigger the sweep "Auto".
9. In the "General" tab, select "State > On".

Example: Fast changing frequency and level settings in list mode

The following example shows you how to generate an amplitude modulated RF signal based on list mode data.

General workflow

Since any change of the hardware settings or list entries can affect the RF signal characteristics directly, we recommend that you proceed as follows:

1. Configure the modulation settings.
Activate the RF signal.
2. Wait until the hardware settings have settled.

3. Create a list file.
4. Configure the list mode.
5. Activate list mode.

To create list mode data

1. Select "RF" > "Sweep/List" > "List Mode".
2. In the "List Mode Data" tab, select "List Mode Data > New"
3. Enter the filename `ListMode_Test` for the data list and confirm with "Ok".
The instrument creates a file and stores it in the `/var/user/` directory.
4. Select "Edit List Mode Data".
5. Enter the first values "Frequency > 2", "Power > 0" and "Dwell > 2".
6. Enter further frequency, power and dwell time values in the same way.
7. Select "Save" and close the dialog.

To configure the list mode and start signal generation

1. In the "General" tab, select "List Mode > Auto".
2. Select "Dwell Time Mode > From List".
3. Switch state to "On".
4. Select "General > State > On".

The instrument continuously generates an amplitude-modulated RF signal whose frequency and level values change according to the dwell times, as defined in the list.

With active list mode, the generator displays no frequency and level values in the status bar, but you can check the following parameters.

- In the list mode dialog, the current index indicates the steps of the signal generation.
- In remote control mode, you can query:
 - The current state with `[:SOURCE<hw>] :LIST:RUNNING?`

8.10 Improving level performance

To adjust the RF output signal to specific needs in your application optimally, the R&S SMCV100B provides different functions:

- **Attenuator**
The R&S SMCV100B is equipped with a step attenuator that enables you to vary the amplitude of the RF signal in a wide range. It is characterized by low VSWR (voltage standing wave ratio) over the full level and frequency range, and provides highest level accuracy and noise suppression.
See [Chapter 8.10.1, "Attenuator"](#), on page 353.

- **User correction (UCOR)**

The user correction function allows you to compensate frequency responses of external setups (e.g. losses of cables) and achieve a stable input signal over frequency directly at the DUT.
See [Chapter 8.10.2, "User correction"](#), on page 355.
- **Power sensors**

The R&S NRP power sensors support RF signal level optimization by determining the attenuation characteristics of downstream devices or cables, or by monitoring the RF signal level at the output directly. The R&S SMCV100B uses the readings of a sensor for compensation of losses and thus improving the accuracy of the RF signal level.
You can configure the measurement parameters of a power sensor directly in the R&S SMCV100B and monitor its readings, including calibration.
See:

 - [Chapter 8.10.3, "Using power sensors"](#), on page 367
 - [Chapter 8.10.4, "To calibrate the power level with an R&S NRP power sensor"](#), on page 383
 - [Chapter 8.10.3.2, "NRP power viewer"](#), on page 369
 - [Chapter 8.10.3.3, "NRP power control"](#), on page 372
 - [Chapter 8.10.3.4, "NRP sensor configuration"](#), on page 375
 - [Chapter 8.10.3.5, "NRP sensor mapping"](#), on page 380

8.10.1 Attenuator

About the attenuator

According to the requirements of your application, you can select different attenuator characteristics.

The following are examples of test requirements and the corresponding configuration:

- **Automatic configuration**

Select standard operation mode ("Auto"), in which the generator adjusts the attenuation of the RF output signal automatically.
- **DUT tests under low signal to noise conditions**

Low output power is suitable to test the behavior of a DUT under low signal to noise conditions.
- **Uninterrupted level settings with constant VSWR**

A fix attenuation value is required for obtaining uninterrupted level settings with constant VSWR.
The configuration "RF Off Mode > Unchanged" ensures that constant VSWR is maintained if you turn the signal off and on again.
- **Noise sensitive applications**

The parameter "RF OFF Mode > Full Attenuation" sets maximum attenuation and thus suppresses noise when you turn off the RF signal.

8.10.1.1 Attenuator settings

Access:

- ▶ Select "RF" > "RF Level" > "Level > Attenuator".

In the "Attenuator" dialog, you can select the operating mode of the step attenuator, the instrument is equipped with.

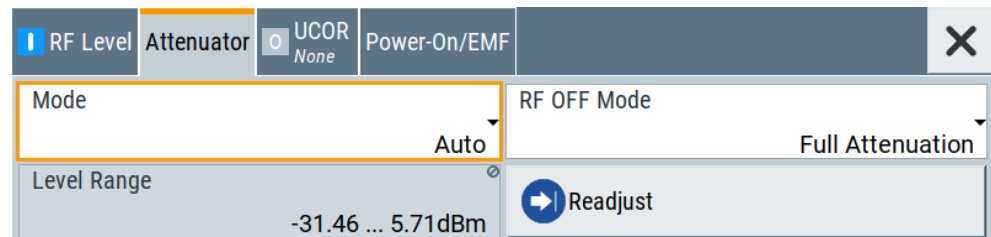

The remote commands required to define these settings are described in [Chapter 14.13, "OUTPut subsystem"](#), on page 618 and [Chapter 14.16.11, "SOURce:POWer subsystem"](#), on page 785.

Settings

Mode.....	354
Level Range.....	354
RF OFF Mode.....	354

Mode

Determines the operating mode of the step attenuator.

"Auto"	Adjusts the attenuator settings automatically.
"Fixed"	Fixes the attenuator and amplifier paths for the current RF level and provides signal output with constant output VSWR. The resulting level range is indicated under " Level Range " on page 354.

Remote command:

[:OUTPut<hw>:AMODE](#) on page 619

Level Range

Shows the interruption-free range of the level that you can use in the selected mode.

Remote command:

[:OUTPut<hw>:AFIXed:RANGe:LOWer?](#) on page 620

[:OUTPut<hw>:AFIXed:RANGe:UPPer?](#) on page 620

RF OFF Mode

Determines the state of the step attenuator, when the RF signal is switched off.

The setting is not affected by an instrument preset ([Preset] key or *RST) and the "Save/Recall" function. It is reset only by factory preset.

"Unchanged"	Freezes the setting of the step attenuator. Use this mode if a constant VSWR (Voltage Standing Wave Ratio) is required.
-------------	--

"Full Attenuation"

Switches to the maximum attenuation.

Use this mode for applications that require a high level of noise suppression.

Remote command:

`[:SOURce<hw>] :POWer:ATTenuation:RFOFF:MODE` on page 787

8.10.1.2 Reverse power protection

The R&S SMCV100B is equipped with a reverse power protection circuit.

The reverse power protection is tripped when the power of signals reflected from the load or external signals applied to the RF output get too high. A relay opens and interrupts the internal connection to the RF output. This condition is indicated in the status bar by the "Overload" status message.

Overload

If an "Overload" status message is indicated in the status bar, perform the following:

- Remove the cause for the overload
- Press the [RF on/off] key to reset the overload protection

The RF input is activated when the overload protection is reset.

Remote command:

`:OUTPut<hw>:PROTection:TRIPped?` on page 620

`:OUTPut<hw>:PROTection:CLEar` on page 620

8.10.2 User correction

The R&S SMCV100B supports a correction function to compensate external losses, caused, for example, by the RF cable, to achieve a precise target input level at the DUT.

The signal at the RF outputs of the R&S SMCV100B is flat. However, the DUT is usually not connected directly to the outputs of the instrument but rather via connecting cables. Components like cables, power combiners, switches or mixers can affect the signal flatness at the DUT input.

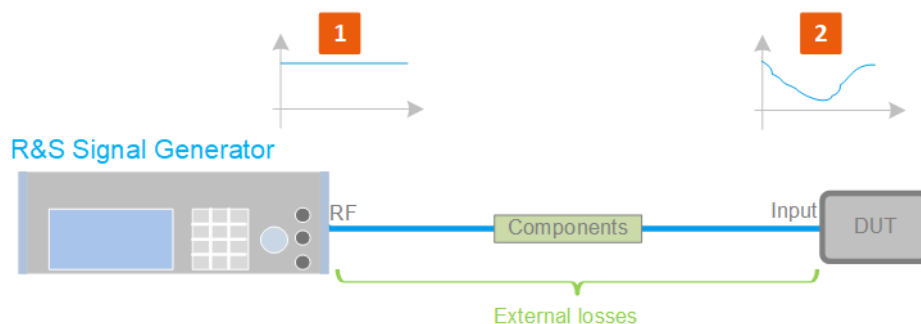

Figure 8-14: Effect of external losses on the signal flatness at the DUT input

- DUT = Device under test
 Components = Designation of all components between the measurement equipment and the DUT, e.g. cables
 1 = Flat signal at the outputs of the R&S SMCV100B
 2 = Signal received at the DUT, incl. the external losses

About UCOR

User correction (UCOR) is a method that determines the external level loss over a frequency range in advance, see [Figure 8-15](#).

The difference between the generator output level and the level at the DUT determines the correction value at the respective frequency. Alternatively, the attenuation characteristics over a certain frequency range of, for example, RF cables are also specified in the associated data sheet.

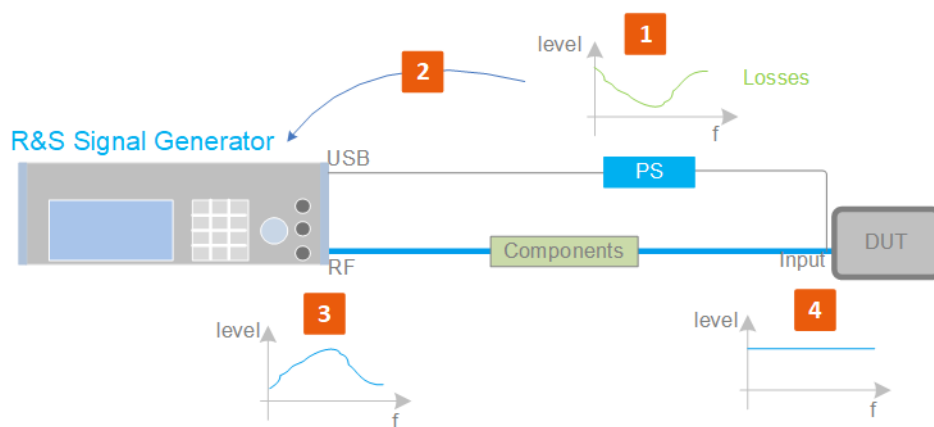

Figure 8-15: Understanding the principle of user correction

- DUT = Device under test
 Components = Designation of all components between the measurement equipment and the DUT, e.g. cables
 PS = Power sensor, e.g. R&S NRP, connected at the DUT's input and the USB connector of the R&S SMCV100B
 1 = Power sensor measures the level over a frequency range, where the collected values correspond to the losses caused by the components between the R&S SMCV100B and the DUT
 2 = Obtain the correction data by inverting the collected data; load the correction parameters in the R&S SMCV100B
 3 = In the R&S SMCV100B, the RF signal is pre-processed with the correction values so that the signal at the outputs is the inverted version of the external losses
 4 = Received at the DUT input, the pre-processed signal is flat

With active **UCOR**, the generator adds the correction value internally and thus increases the output level by exactly the amount of the loss between its output and the DUT. For frequencies which are not contained in the list, the level correction is calculated by interpolation of the closest correction values.

Possible ways for configuring the user correction values

You can configure correction values in the following ways:

- **Internally**

- Use the built-in table editor in the "UCOR > Edit User Correction Data" dialog. Once defined, user correction values can be saved in a file. Files with correction data can be exported, for example, to exchange configuration between instruments or to modify the file content with an external program and reload them again.
- Using the corresponding remote-control commands. Note that you have to create a user correction file first.
- **Externally**
Create a file with correction values as a CSV file with Microsoft Excel, with a Notepad or a similar tool and save it with the predefined extension. Transfer the file to and load it into the instrument.

UCOR file format

Files containing correction data are simple files in text or comma-separated value (CSV) file format. The filename is user-definable; the file extension is *.ucor.

The file contains a list of correction values, one row per frequency and correction value pair; a new line indicator separates the correction values.

For file handling, use the standard functions in the "File Manager", see [Chapter 11.8, "Using the file manager"](#), on page 428.

Collecting correction data

To fill the frequency and power values in the correction table, use one of the following options:

- **Manually**, row by row.
- Fill the table **automatically** with linearly interpolated values, calculated from value range and step size.
- Acquire the real frequency response characteristics of the used component with the **R&S NRP power sensor**, see [Understanding the principle of user correction](#).

Using a power sensor for frequency response measurements

Consider the following when using R&S NRP power sensors to measure the correction values:

- Measure the level directly at the input of the DUT.
- Use the internal correction functions of an R&S NRP power sensor to increase the measurement accuracy.
- Use S-parameter to consider the impact of any two-port device like an adapter between the signal generator and the sensor input.



Interactions and characteristics

Activated user correction is effective in all operating modes.

The RF output level ($Level_{RF}$) is the sum of the level value and the correction for the particular frequency:

$$Level_{RF} = \text{"Status bar > Level"} + \text{"UCOR"}$$

8.10.2.1 User correction settings

Access:

1. Select "RF" > "RF Level" > "User Correction".
2. If you already have created a file with user correction data:
 - a) Select "UCOR Data > navigate to the file *.uco > Select".
 - b) Proceed with [step 4](#).
3. If you need to create a file:
 - a) Select "UCOR Data > New".
 - b) Enter the filename `UCOR_Data` and confirm with "Ok".
 - c) Choose the file and confirm with "Select".
 - d) Select "Edit UCOR Data".
 - e) To fill the user correction data table, proceed as described in [Chapter 8.10.2, "User correction"](#), on page 355.
4. Select block diagram > RF > "On".
5. Select "State > On".

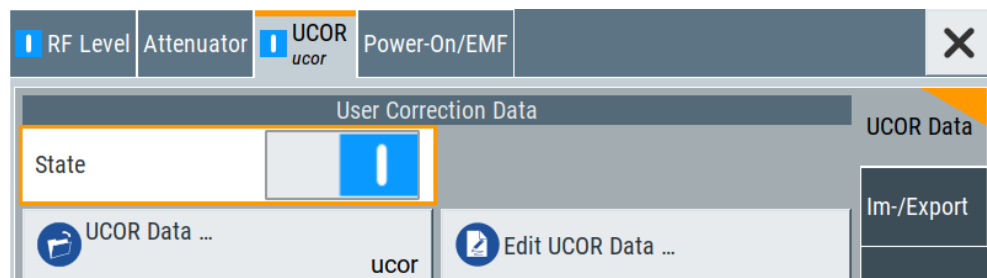

The "UCOR" dialog contains all settings for creating and handling files with user-defined level correction values.

The remote commands required to define these settings are described in [Chapter 14.16.4, "SOURCE:CORRection subsystem"](#), on page 751.

Settings

State.....	359
User Correction.....	359
UCOR Data.....	359
Edit UCOR Data.....	359
UCOR Info	359

State

Activates user correction.

Remote command:

`[:SOURce<hw>] :CORRection [:STATe]` on page 756

User Correction

Indicates the corrected level value for a specific frequency point.

Remote command:

`[:SOURce<hw>] :CORRection:VALue?` on page 755

UCOR Data

Accesses the standard "File Select" function of the instrument. The provided navigation possibilities in the dialog are self-explanatory.

Files with user correction values are files with predefined file extension `*.uco`. When a file is selected, the dialog indicates the filename.

You can create the file internally in the table editor or externally.

- To select an existing file, select "Select List > navigate to the file *.uco > Select"
- Use the general editor function to create internally new file or to edit an existing one.
- Use the standard file manager function to load externally created files to the instrument.

Remote command:

`[:SOURce] :CORRection:CSET:CATalog?` on page 756

`[:SOURce<hw>] :CORRection:CSET [:SElect]` on page 755

`[:SOURce] :CORRection:CSET:DElete` on page 757

Edit UCOR Data

Opens the build-in table editor to define a new correction table or edit an existing one.

See also:

- [Chapter 8.9.7, "List editor"](#), on page 347
- ["Fill..."](#) on page 350
- [Chapter 8.10.2.3, "Fill with sensor"](#), on page 364

UCOR Info ...

Opens a window information on the user correction file.

The window shows the metadata of the file and the output level parameters that are relevant for user correction.

Remote command:

n.a.

8.10.2.2 List editor

The "User Correction" and "List Mode" dialogs provide a build-in list editor for defining the corresponding value pairs.

The table and navigation functions of the UCOR and list mode editors have the same structure and are therefore summarized below. The access is specified for both modes, the fields and functions are explained using the example of the list mode.

Access to "Edit List Mode Data":

- ▶ "RF" > "Sweep/List" > "List Mode" > "List Mode Data" > "Edit List Mode Data"

The editor for list mode provides a table with RF frequency and power values, an extra column for defining variable dwell times, and standard navigation functions.

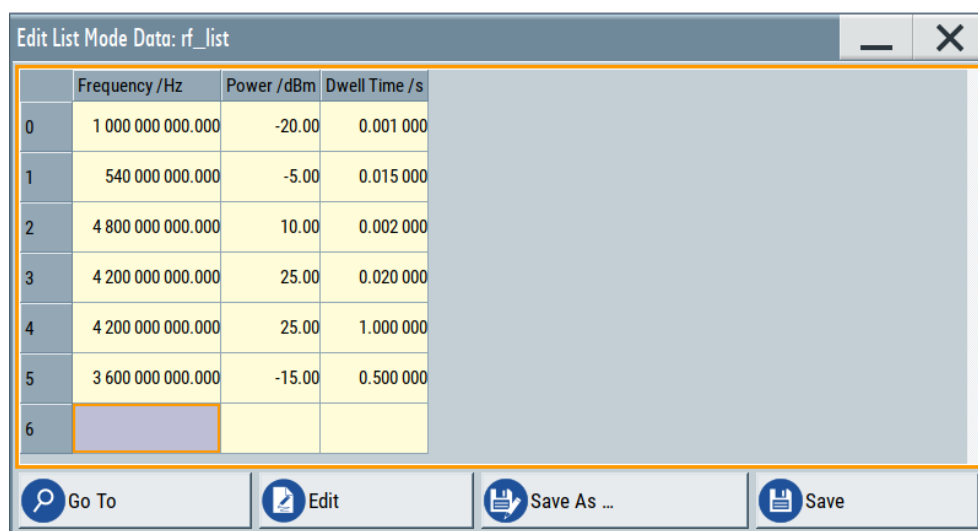

	Frequency /Hz	Power /dBm	Dwell Time /s
0	1 000 000 000.000	-20.00	0.001 000
1	540 000 000.000	-5.00	0.015 000
2	4 800 000 000.000	10.00	0.002 000
3	4 200 000 000.000	25.00	0.020 000
4	4 200 000 000.000	25.00	1.000 000
5	3 600 000 000.000	-15.00	0.500 000
6			

The remote commands required to define the list mode data are described in [Chapter 14.16.9, "SOURCE:LIST subsystem"](#), on page 771.

Access to "Edit User Correction Data":

- ▶ "RF" > "RF Level" > "User Correction" > "Edit User Cor. Data"

	Frequency /Hz	Correction Value /dB
0	1 560 000 000.00	11.51
1	1 561 000 000.00	11.03
2	1 562 000 000.00	10.55
3	1 563 000 000.00	10.07
4	1 564 000 000.00	9.59
5	1 565 000 000.00	9.11
6		

The editor for user correction data provides a table with RF frequency and power values and standard navigation functions.

The remote commands required to define the user correction data are described in [Chapter 14.16.4, "SOURCE:CORRection subsystem"](#), on page 751.



All columns in a row must contain values. Cells with missing values are therefore filled automatically, using the value of the previous row.

If you use **global dwell time in list mode**, consider also that the instrument uses the value set with [Global Dwell Time](#) for all list steps and not the values from the list.

Since the table and navigation functions can be assumed to be known, the following description contains a brief overview, shown by the example of the "Edit List Mdoe Data" dialog. If a function relates to a particular dialog, it is explicitly stated.

Settings

Edit List Mode Data	361
Data handling keys	362
L Go To	362
L Edit	362
L Fill with Sensor	362
L Save As/Save	362
Fill	362

Edit List Mode Data

Table with values for list or user correction processing.

Note: Once you enter a value, the editor automatically adds preset values in the other columns. This functionality protects against data loss, otherwise incomplete rows are lost when saving. You can simply override these values.

"Frequency /Hz"

Sets the frequency values.

Remote command:

[\[:SOURce<hw>\]:LIST:FREQuency](#) on page 776

[\[:SOURce<hw>\]:CORREction:CSET:DATA:FREQuency](#)
on page 754

"Power /dBm" (list mode data table)

Sets the level values.

Remote command:

[\[:SOURce<hw>\]:LIST:POWer](#) on page 778

"Correction Value /dBm" (user correction data table)

Sets the level values.

Remote command:

[\[:SOURce<hw>\]:CORREction:CSET:DATA:POWer](#) on page 754

"Dwell /s"

In list mode, sets the dwell time values.

Remote command:

[\[:SOURce<hw>\]:LIST:DWELL:LIST](#) on page 775

Data handling keys

Standard functions for file and data handling.

**Go To ← Data handling keys**

Selects a row for editing.

Edit ← Data handling keys

Enables you to insert, or delete a row or ranges within a list, and provides access to a dialog for automatic filling, see "[Fill...](#)" on page 350.

Fill with Sensor ← Data handling keys

Opens a dialog to configure the automatic filling of user correction data with an R&S NRP power sensor. Available in UCOR mode only.

See [Chapter 8.10.2.3, "Fill with sensor"](#), on page 364

Save As/Save ← Data handling keys

Stores the list in a file with user-defined name and predefined file extension. To save a copy or create a file, use the "Save as" function.

Fill...

Provides parameters for filling a table automatically with user-defined values.

From 0	Range 4
Column To Fill Frequency /Hz	
Start Value 2.000 000 000 000 GHz	End Value 2.600 000 000 000 GHz
Increment Value 200.000 000 000 MHz	
<input checked="" type="checkbox"/> Fill	

To fill the table, select "Fill".

Note: Once you enter a value or fill a column, the editor automatically adds preset values in the other columns. This functionality protects against data loss, otherwise incomplete rows will be lost when saving. You can simply override these values.

"From / Range"

Defines the start line and number of lines to be filled.

"Column To Fill"

Selects, if the column is filled up with frequencies in Hz, levels in dBm or dwell times in s.

"Start Value / End Value"

Sets the start value for frequency, level or dwell time. The end value is read only and depends on the increment value and the range.

"Increment Value"

Determines the step size.

"Fill"

Fills the column specified in "Column To fill".

8.10.2.3 Fill with sensor

Access:

- ▶ Select "RF" > "RF Level" > "User Correction".

Generator Settings used for Measurement	
Modulation	Off (CW)
Amplitude	-30.00 dBm
Offset	0.00 dB
UCOR Reference Level	-30.00 dBm

This dialog contains parameters for filling a table automatically with sensor readings.



To fill the table, select "Execute".

For information on power sensors and how to use them, see [Chapter 8.10.4, "To calibrate the power level with an R&S NRP power sensor"](#), on page 383.

Settings:

Fill User Correction Data with Sensor	364
Generator Settings used for Measurement	365

Fill User Correction Data with Sensor

- "Sensor"
Displays connected sensors for selection.
- "List To Fill"
Indicates the used list.
- "Config"
Leads you to the sensor configuration dialog to set the parameters for the selected power sensor.
- "Include Zeroing"

Performs a zeroing procedure before acquiring the user correction data to improve precision.

No signal is applied to the sensor during zeroing. RF output is temporarily switched off during that time.

When unchecked, the zeroing procedure is skipped. However, the RF signal level can be blanked shortly. This setting is useful if blanking of RF is undesirable or the absence of power at the sensor cannot be guaranteed.

- "Execute"

The "Execute" button is only enabled if a sensor is detected and the user correction list contains at least one frequency value.

Remote command:

`[:SOURce<hw>] :CORRection:ZERoing:STATe` on page 756

`[:SOURce<hw>] :CORRection:CSET:DATA [:SENSor<ch>] [:POWer] :SONCe`
on page 755

Generator Settings used for Measurement

Displays the settings relevant for the measurement.

"Modulation" Indicates the modulation state

"Amplitude" Displays the currently set level.

Remote command:

`[:SOURce<hw>] :POWer:POWer` on page 790

"Offset" Displays the level offset, set with "Offset" on page 309.

Remote command:

`[:SOURce<hw>] :POWer [:LEVel] [:IMMediate] :OFFSet`
on page 794

"UCOR Reference Level" Displays the reference value for user correction.
The user correction reference level is the set [Amplitude](#) plus the set [Offset](#).

Remote command:

`[:SOURce<hw>] :POWer [:LEVel] [:IMMediate] :REFLevel`
on page 795

8.10.2.4 Import/export list files

Access:

1. Select one of the following:
 - "RF" > "Sweep/List" > "List mode".
 - "RF" > "RF Level" > "User Correction".

2. Select "Import/Export".

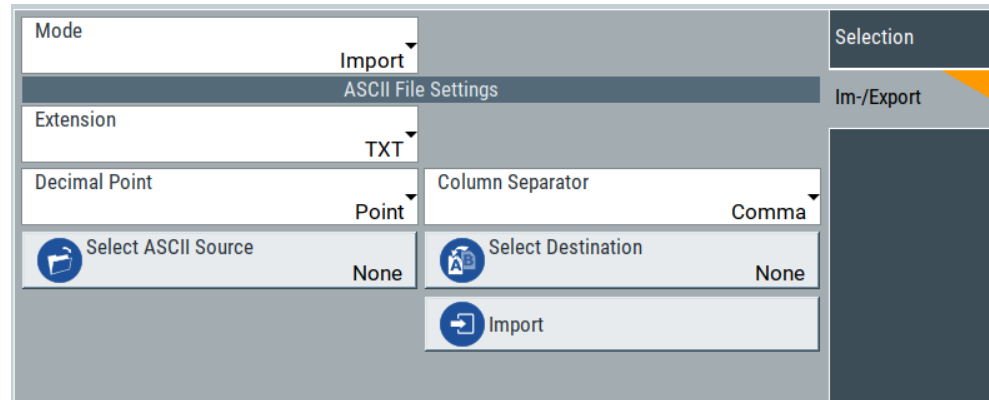

Figure 8-16: Im-/Export dialog (example with UCOR settings)

The "Import/Export" dialog contains all functions and settings to import externally created list data or to export it accordingly. You can process and store a list in the formats `*.txt` (ASCII), or `*.csv` (plain text with identical sequence of fields). The table separators and the decimal floating point numbers are customizable.

Settings

Mode.....	366
ASCII File Settings.....	366
Select (ASCII) Source/Select (ASCII) Destination.....	367
Select Source/Select ASCII Destination.....	367
Import / Export.....	367

Mode

Selects import or export of a data list file. The provided parameters vary according to the selected mode.

Remote command:

`[:SOURCE<hw>] :LIST:DEXChange:MODE` on page 784

`[:SOURCE<hw>] :CORrection:DEXChange:MODE` on page 759

ASCII File Settings

Defines the format and the separators of the associated data file.

"Extension" Selects `*.csv` or `*.txt` format.

"Decimal Point" Sets "Point" (dot) or "Comma" as the decimal separator used in the ASCII data with floating-point numerals.

"Column Separator" Sets the separator between the columns in an ASCII table. Available are: "Tab", "Semicolon", "Comma" or "Space".

Remote command:

`[:SOURCE<hw>] :LIST:DEXChange:AFILe:EXTension` on page 783

`[:SOURCE<hw>] :LIST:DEXChange:AFILe:SEParator:DECimal` on page 784

`[:SOURCE<hw>] :LIST:DEXChange:AFILe:SEParator:COLumn` on page 783

[\[:SOURCE<hw>\]:CORREction:DEXChange:AFIle:EXTension](#) on page 757

[\[:SOURCE<hw>\]:CORREction:DEXChange:AFIle:SEParator:DECimal](#)
on page 758

[\[:SOURCE<hw>\]:CORREction:DEXChange:AFIle:SEParator:COLumn](#)
on page 758

Select (ASCII) Source/Select (ASCII) Destination

In "Mode > Import", access the file select dialog that provides standard file handling functions.

Where:

- "Select ASCII Source": defines the file to be loaded (imported)
- "Select ASCII Destination": selects the filename under that the loaded file is saved

Remote command:

[\[:SOURCE<hw>\]:LIST:DEXChange:AFIle:CATalog?](#) on page 782

[\[:SOURCE<hw>\]:LIST:DEXChange:AFIle:SElect](#) on page 783

[\[:SOURCE<hw>\]:CORREction:DEXChange:AFIle:CATalog?](#) on page 757

[\[:SOURCE<hw>\]:CORREction:DEXChange:AFIle:SElect](#) on page 758

Select Source/Select ASCII Destination

In "Mode > Export", access the file select dialog that provides standard file handling functions.

Where:

- "Select Source": selects the file to be exported
- "Select ASCII Destination": defines the filename and the file path for the exported file

Remote command:

[\[:SOURCE<hw>\]:LIST:DEXChange:SElect](#) on page 784

[\[:SOURCE<hw>\]:CORREction:DEXChange:SElect](#) on page 759

Import / Export

Imports or exports the selected data list file, depending on the current mode.

Remote command:

[\[:SOURCE<hw>\]:LIST:DEXChange:EXECute](#) on page 783

[\[:SOURCE<hw>\]:CORREction:DEXChange:EXECute](#) on page 758

8.10.3 Using power sensors

The R&S SMCV100B works with any of the R&S NRP power sensors and thus supports various application tasks. Using power sensors, you can for example determine attenuation characteristics of downstream equipment or cables. You can use the measured values to compensate the losses with internal control functions or with an external control circuit in real time.

R&S NRP power sensors are highly accurate standalone measuring devices, suitable for a wide range of applications. The power sensors communicate directly with the signal generator, calculate the average or peak power internally, include S-parameter correction and return the measurement results to the generator.

The R&S SMCV100B supports up to four R&S NRP, allowing up to four power measurements simultaneously.



Check the firmware version of the R&S NRP sensors regularly. Update the firmware, if necessary.

For updates, see the Rohde & Schwarz website <http://www.rohde-schwarz.com> in section "Power Meters & Voltmeters".

For more information on working with power sensors, see the following topics:

- [Chapter 8.10.3.1, "Connecting R&S NRP power sensors to the R&S SMCV100B"](#), on page 368
Overview on the supported connectors, connection options and the required accessories.
- [Chapter 8.10.3.2, "NRP power viewer"](#), on page 369
A function for measuring and monitoring the RF output power or a user-defined signal source.
- [Chapter 8.10.3.3, "NRP power control"](#), on page 372
Controls a downstream closed loop power control circuit, to compensate frequency response characteristics.
- [Chapter 8.10.3.4, "NRP sensor configuration"](#), on page 375
Parameter settings of the specific R&S NRP power sensor.
- [Chapter 8.10.3.5, "NRP sensor mapping"](#), on page 380
Shows all R&S NRP sensors connected to the instrument, or in the LAN.

8.10.3.1 Connecting R&S NRP power sensors to the R&S SMCV100B

Connection	Sensor type (incl. USB hub)	Cables/Accessories	Characteristics
USB type A	R&S NRPxx	R&S NRP-ZKU	USB interface cable
	R&S NRP-Zxx	R&S NRP-Z3 R&S NRP-Z4	USB adapter cables
	R&S NRP-Z5 USB sensor hub (high-speed USB 2.0)	Standard USB cable (USB type A to USB type B)	This connection does not support external triggering.
	Standard USB hub with external power supply unit R&S NRPxx	R&S NRP-ZKU	USB interface cable
	Standard USB hub with external power supply unit R&S NRP-Zxx	R&S NRP-Z3 R&S NRP-Z4	USB adapter cables
LAN	R&S NRPxxxSN/xxxTN/xxxAN	<ul style="list-style-type: none"> • A PoE Ethernet switch, e.g. R&S NRP-ZAP1 and an RJ-45 Ethernet cable. • A PoE injector and an RJ-45 Ethernet cable. 	Using the Ethernet interface requires PoE (Power over Ethernet) to provide the electrical power.

For details, see the description R&S®NRP Power Sensors getting started.

Detection and mapping

The R&S SMCV100B either detects a R&S NRP power sensor automatically or you can scan for available power sensors manually. The "NRP Sensor Mapping" dialog lists all detected R&S NRP power sensors, see [Chapter 8.10.3.5, "NRP sensor mapping"](#), on page 380. The dialog enables you to add, remove and map the sensors manually.

Depending on the connection interface, the R&S SMCV100B detects and maps connected R&S NRP power sensors differently:

- USB interface
Detects a sensor automatically and maps it with index "1" to index "4" according to the sequence of connection.
- LAN interface
To detect sensors that are connected in the LAN, the instrument provides a scan function. When you start the function, scan searches in the LAN for available R&S NRP power sensors and adds all detected sensors to list. Assigning a mapping index activates the sensor for the measurement.



On connection, the R&S SMCV100B immediately starts the measurement of the R&S NRP power sensor. If you preset the instrument ([Preset] key or *RST), the R&S SMCV100B stops the measurement. The connection and the mapping of the power sensors remain.

8.10.3.2 NRP power viewer

The R&S SMCV100B features the power viewer function for measuring or monitoring signals with R&S NRP power sensors.

About

The R&S SMCV100B can perform up to four power measurements simultaneously.

Depending on the signal characteristic (CW, AM, pulsed, etc.) or the parameter to be measured (average, peak, etc.) a suitable R&S power sensor must be used.

About the measuring principle, averaging filter, filter length, and achieving stable results

A sensor measures the average or peak RF power of the source continuously. The measurement results are displayed in the "NRP Power Viewer" dialog.

The power viewer function uses **averaging filters** for getting a stable readout.

Measurement results could be interfered, for instance, by too much noise in your setup, by a bad suppression of harmonics or non-harmonics or when you reach the sensitivity level of your power sensor.

Measurements are continuously repeated in a predefined time window. The measurement result is obtained by averaging the measured values for the last 2N time windows. This approach is referred as a **two-step averaging process**.

The factor of 2 in the formula arises because the output signals from the microwave detector are chopped at the same rate as the time windows to suppress low-frequency noise. An independent measured value can only be obtained from two consecutive values.

The variable N in the formula indicates the **filter length**. The filter length then directly influences the measurement time. The filter length can be selected automatically or it can be manually set to a fixed value.

Depending on the R&S NRP power sensor type, the manual setting of the filter length varies in resolution:

- Resolution = 1 for the R&S NRPxx power sensor family
- Resolution = 2^n for R&S NRP-Zxx power sensors, with $n = 1$ to 16

Follow the following general recommendation to find out the **optimum filter length**:

- Always start a measurement in auto mode ("Filter > Auto").
Check if the measurement results are sufficient.
- If the power is not constant, select the filter length manually ("Filter > User").
Trigger the "Auto Once" function to search for the optimum filter length for the current measurement conditions.
The estimated value is indicated as filter length.
- If the target measurement accuracy value is known, select "Filter > Fixed Noise".
The averaging factor is selected automatically and so that the sensor's intrinsic noise (two standard deviations) does not exceed the specified noise content.
- Different sensor types achieve the same filtering result with different filter and time window lengths.

The time window length depends on the sensor type:

- For most sensors, it is fixed to 20 ms.
- For the R&S NRP-Z81 sensor, it is 10 μ s.
The R&S NRP-Z81 uses filter length that is 1000 times larger than the filter length for other sensors.

About zeroing

Activates the auto zero function.

Zeroing calibrates the external power sensor by adjusting its reading at zero signal power. For this purpose, the RF power source must be switched off or disconnected from the sensor. If a Rohde & Schwarz power sensor receives an input power during the zeroing process, it aborts zeroing and generates an error message. Zeroing takes a few seconds, depending on the sensor model. Refer to the documentation of your power sensor for more information.

Tips for zeroing

When to perform zeroing:

- During warm up after switching on or connecting the instrument
- After a substantial change of the ambient temperature
- After fastening the power sensor module to an RF connector at high temperature
- After several hours of operation

- When low-power signals are to be measured, e.g. less than 10 dB above the lower measurement limit.
- Switch off the RF power source for zeroing, but do not disconnect it from the power sensor. This proceeding keeps the thermal equilibrium, and the zeroing process also compensates the noise that superimposes the measured signal (e.g. from a broadband amplifier).

Related settings and functions

- Measurements-related settings, like results, filter, filter length:
[Chapter 8.10.3.4, "NRP sensor configuration"](#), on page 375
- Closed loop power control of the output level:
[Chapter 8.10.3.3, "NRP power control"](#), on page 372.
- Software version of the connected power sensor:
`:SENSe<ch>[:POWER]:TYPE?` on page 635
- Acquisition of level correction data:

Additional information

See the Rohde & Schwarz website <http://www.rohde-schwarz.com>, section "Power Meters & Voltmeters" for:

- R&S NRP power sensor manual.
- Information on the R&S NRP-Z5 sensor hub and the available accessories.
- Sensor software updates.

NRP power viewer settings

Access:

- ▶ Select "RF" > "RF Measurement" > "NRP Power Viewer".

Power Viewer	Power Control	Sensor Configuration	Sensor Mapping		
1: NRP-Z81 900008		Average		-52.42	dBm <input type="button" value="Config ..."/>
2: NRP18SN 101748		Average		-1.03	dBm <input type="button" value="Config ..."/>
3: NRP67TN 101015		Average		-38.20	dBm <input type="button" value="Config ..."/>
4: NRP33SN-V 900011		Average		-7.96	dBm <input type="button" value="Config ..."/>

The "Power Viewer" tab lists the mapped R&S NRP power sensors with the measured parameter mode and the current readings. The "Config" button leads you to the configuration dialog to set the parameters for each sensor.

[Config](#).....371

Config

Accesses the [Chapter 8.10.3.4, "NRP sensor configuration"](#), on page 375 dialog.

8.10.3.3 NRP power control

The NRP power control function enables you to apply stable and accurate RF power to the DUT. For example, you can set up a downstream closed loop power control circuit to compensate spurious effects or losses caused by power amplifiers or cables.

Example: How to set up a closed loop power control

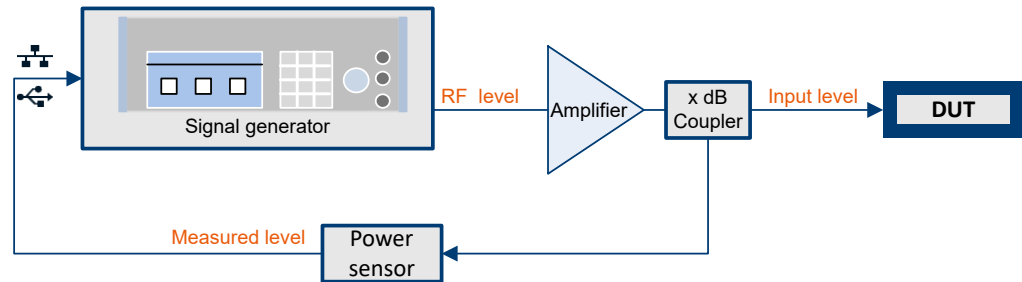

Figure 8-17: Example of a test setup with NRP power control

The signal generator applies the RF output signal to an amplifier and to the DUT. An intermediately connected coupler derives the output power from the output signal and forwards it to the power sensor. Thus, the power sensor measures a proportional power in defined time intervals, and returns the results to the signal generator. If supported, the power sensor also includes given S-parameters. The signal generator compares the measured power with the set level value and adjusts the level of the output signal accordingly.

This closed loop power control enables you to control the external signal level continuously and reliably achieve a constant input power at the DUT in real time.



Impact of NRP power control and operating modes

Since the frequency and level of the RF output signal are continuously adjusted during "NRP Power Control", this operating mode interferes signal generation modes with varying frequency and level values. In addition, the setting time increases. The reason is the interaction between the signal generator and the R&S NRP power sensor in the control loop.

The operating modes impact each other as follows:

- Enabling the RF frequency sweep, RF level sweep or the list mode disables a running "NRP Power Control".
- A running list or RF sweep mode blocks "NRP Power Control".
- Modulated signals can deviate from the CW signal in mean power and peak power, and thus affect the "NRP Power Control".

NRP power control settings

Access:

- ▶ Select "RF" > "RF Measurement" > "NRP Power Control".

Power Viewer	Power Control	Sensor Configuration	Sensor Mapping
State	<input checked="" type="checkbox"/>		
Sensor	2: NRP18SN 101748	Average	-1.52 dBm Config ...
Target Level	-10.00 dBm	Take Measurement as Target Level	
Mode	Single	Execute Single	
Catch Range +/-	30.00 dB	Delay Time	0 ms
RF Amplitude Limit	30.00 dBm	RF Setting Characteristics	Auto

In this dialog you can configure the parameters of the power control setup for the selected power sensor.

The remote commands required to define these settings are described in [Chapter 14.16.11, "SOURce:POWer subsystem"](#), on page 785.

Settings

State.....	373
Sensor.....	373
Measured Level.....	374
Target Level.....	374
Take Measurement as Target Level.....	374
Mode.....	374
Execute Single.....	374
Catch Range +/-.....	374
Delay Time.....	375
Limit.....	375
Setting Characteristics.....	375

State

Enables power control with the selected sensor.

The control loop periodically adjusts the generator output. After switching off, the running loop is completed.

Note: If you want to use another sensor, you must disable power control before. It is not possible to switch between sensors when power control is active.

Remote command:

[:SOURce<hw>] :POWer:SPC:STATe on page 792

Sensor

Indicates the R&S NRP power sensor that is selected for power control.

To configure the power sensor parameters, see [Chapter 8.10.3.4, "NRP sensor configuration"](#), on page 375.

Remote command:

[:SOURce<hw>] :POWer:SPC:SElect on page 792

Measured Level

Indicates the current reading of the selected power sensor.

Remote command:

`:READ<ch>[:POWer]?` on page 627

`:SENSe<ch>:UNIT[:POWer]` on page 628

Target Level

Specifies the nominal level expected at the input of the sensor. The signal generator adjusts the output power accordingly, to meet the target value at the sensor input, and thus the power required at the DUT.

Remote command:

`[:SOURce<hw>]:POWer:SPC:TARGet` on page 793

Take Measurement as Target Level

Uses the currently measured level as reference and applies the value as target level, see "[Target Level](#)" on page 374.

This feature simplifies setting up the control loop after manual adjustment of the measurement configuration. To assign the measured level as reference level, you must switch off "NRP Power Control". It is not possible when the control loop is running.

Remote command:

`[:SOURce<hw>]:POWer:SPC:MEASure` on page 791

Mode

Selects the measurement mode for acquiring the power values measured by the sensor.

"Auto" Immediately starts and measures the power continuously.

"Single" Starts when you manually select [Execute Single](#), and executes one power measurement.

Remote command:

`[:SOURce<hw>]:POWer:SPC:MODE` on page 791

Execute Single

In mode "Single", starts one measurement cycle manually.

Remote command:

`[:SOURce<hw>]:POWer:SPC:SINGle` on page 792

Catch Range +/-

Sets the capture range of the control system.

Within the range:

Target Level +/- Catch Range

the power control locks and tries to achieve the target level. Readings outside the range are not considered.

Remote command:

`[:SOURce<hw>]:POWer:SPC:CRANge` on page 791

Delay Time

Sets a waiting period between the level adjustment of the generator and the next measurement of the power sensor.

With this parameter, you can bypass idle times in the controlled system.

Remote command:

`[:SOURce<hw>] :POWer:SPC:DELay` on page 791

Limit

Sets an upper limit for the output power.

You can use this value to protect your DUT from damage due to high input power. If you enter an RF level above this value, the instrument limits the output power to this specified value, and generates the warning message:

"Pep value greater than the defined limit." However, the level indication in the status bar is not affected.

The setting is not affected by an instrument preset ([Preset] key or *RST) and the "Save/Recall" function. It is reset only by factory preset.

Remote command:

`[:SOURce<hw>] :POWer:LIMit [:AMPLitude]` on page 788

Setting Characteristics

Selects additional quality characteristics to optimize the behavior of the RF signal level for the specific application.

"Auto" Sets the RF output level automatically according to the selected mode. In this mode, the instrument provides the highest dynamic range and fastest setting times, as specified in the data sheet. The RF signal is shortly blanked when the step attenuator is switching.

"Uninterrupted" Suppresses blanking at level transitions. Frequency transitions can lead to an RF level blanking due to hardware-specific switching points. This mode reduces the dynamic range of the instrument. The step attenuator is fixed.

Remote command:

`[:SOURce<hw>] :POWer:LBEHaviour` on page 788

8.10.3.4 NRP sensor configuration

Access:

- ▶ Select "RF" > "RF Measurement" > "NRP Sensor Configuration".

Power Viewer	Power Control	Sensor Configuration	Sensor Mapping
Average		-1.02 dBm	
State	<input checked="" type="checkbox"/>	Zero	
Display Permanent	<input checked="" type="checkbox"/>	Display	Average
Use Frequency Of	RF		
Level Offset State	Off	Level Offset	0.000 dB
Filter	Auto	Filter Length	376
		Timeout	2.00 s
Default Aperture Time	<input checked="" type="checkbox"/>	Aperture Time	5.0 ms
S-Parameter	Unused	Enable Logging	<input type="checkbox"/>

1: NRP-Z81 900008
2: NRP18SN 101748
4: NRP33SN-V 900011

In this dialog you can configure the parameters for each mapped R&S NRP power sensor in separate tabs.

The remote commands required to define these settings are described in [Chapter 14.14, "SENSe, READ, INITiate and SLISt subsystems"](#), on page 621, including the triggering of the measurement and the retrieval of measurement results.

Settings:

Sensor type and serial number.....	376
Level (Peak) / Level (Average).....	377
State.....	377
Zero.....	377
Display.....	377
L Permanent.....	377
L Display.....	377
Use Frequency Of.....	377
Frequency.....	378
Level Offset State,Level Offset.....	378
Filter.....	378
Filter Length.....	379
Auto Once.....	379
Noise/Signal Ratio.....	379
Timeout.....	379
Default Aperture Time.....	379
Aperture Time.....	379
S-Parameter.....	380
Enable Logging.....	380

Sensor type and serial number

The side tab label indicates type and serial number of an R&S NRP power sensor and its mapping index.

The **Level (Peak) / Level (Average)** values display the current readings of the sensor.

Remote command:

`:SENSe<ch>[:POWER]:TYPE?` on page 635

`:SENSe<ch>[:POWER]:SNUMber?` on page 634

Level (Peak) / Level (Average)

Indicates the measured peak or average level value.

You can also change the unit for the results display: Watt, dBm or dBμV.

Note: Peak level measurements are provided if the power sensor supports this feature.

Remote command:

`:READ<ch>[:POWER]?` on page 627

`:SENSe<ch>:UNIT[:POWER]` on page 628

State

Enables level measurement of the R&S NRP power sensor.

Remote command:

`:INITiate<hw>[:POWER]:CONTinuous` on page 626

To query the availability of a sensor at a given connector, use the command `:SENSe<ch>[:POWER]:STATus[:DEVice]?` on page 634.

Zero

Activates the auto zeroing.

For details, see ["About zeroing"](#) on page 370.

Remote command:

`:SENSe<ch>[:POWER]:ZERO` on page 635

Display

Sets the display mode for power readings.

Permanent ← Display

Enables the display of the power sensor with the currently measured value in the task bar.

The task bar label shows the measurement result, the channel, the sensor is mapped to and its serial number.

You can activate the permanent display for several sensors.

Remote command:

`:SENSe<ch>[:POWER]:DISPlay:PERManent:STATe` on page 630

Display ← Display

Sets the display of results on mean or peak power.

Remote command:

`:SENSe<ch>[:POWER]:DISPlay:PERManent:PRIority` on page 629

Use Frequency Of

Selects the source for measurement.

- "RF" The R&S SMCV100B transfers the RF frequency and level settings to the R&S power sensor automatically. Thus you achieve power readings of high accuracy, irrespective from the connected sensor type.
- "User" Sets a user defined frequency.

Example:

If you have a frequency converting device between the generator and the DUT. If the frequency converter doubles the frequency, you can set twice the frequency in the R&S SMCV100B. The R&S power sensor considers this RF frequency setting.

Set the parameter [Frequency](#) to the measurement's frequency.

Remote command:

`:SENSe<ch>[:POWER]:SOURce` on page 634

Frequency

Defines the frequency value if "Source > User" is used.

Remote command:

`:SENSe<ch>[:POWER]:FREQuency` on page 632

Level Offset State,Level Offset

Activates and defines a level offset which is considered in the power measurement result. The level offset value is always expressed in dB, irrespective of the display of the measurement result.

This function allows you to consider, for example, an attenuator in the signal path.

Remote command:

`:SENSe<ch>[:POWER]:OFFSet` on page 633

`:SENSe<ch>[:POWER]:OFFSet:STATe` on page 633

Filter

Selects the way the length of the used filter is defined.

See also "[About the measuring principle, averaging filter, filter length, and achieving stable results](#)" on page 369.

- "Auto" Selects the filter length automatically and adjusts it to the measured value. The value is indicated with the parameter [Filter Length](#).
When high output power is applied, the filter length and therefore the measurement time can be short.
When low output power is applied, the filter length and therefore the measurement time is increased which reduces the considered noise content in your measurement.
- "User" The filter length is defined manually, with the parameter [Filter Length](#).
As the filter length works as a multiplier for the time window, constant filter length results in a constant measurement time.
Values 1 and 2N are allowed.

"Fixed Noise" The averaging factor is taken automatically in accordance to the value [Noise/Signal Ratio](#). Thus, the sensor's intrinsic noise (2 standard deviations) does not exceed the specified noise content. To avoid long measurement times when the power is too low, set a [Timeout](#).
Timeout is the maximum acceptable measurement time which limits the averaging factor and therefore leads to a more unstable readout.

Remote command:

`:SENSe<ch>[:POWER]:FILTer:TYPE` on page 632

Filter Length

Sets or indicates the filter length, depending on the selected filter mode.

- "Filter > Auto" indicates the automatically adjusted filter length.
- "Filter > User" enables you to set the filter length manually.
- "Filter > Fixed Noise" hides the setting parameter.

Remote command:

`:SENSe<ch>[:POWER]:FILTer:LENGTh:AUTO?` on page 630

`:SENSe<ch>[:POWER]:FILTer:LENGTh[:USER]` on page 630

Auto Once

Searches the optimum filter length for the current measurement conditions. The result is indicated with the parameter [Filter Length](#).

See also "[About the measuring principle, averaging filter, filter length, and achieving stable results](#)" on page 369.

Remote command:

`:SENSe<ch>[:POWER]:FILTer:SONCe` on page 631

Noise/Signal Ratio

For [Filter > Fixed Noise](#), sets the noise content.

Remote command:

`:SENSe<ch>[:POWER]:FILTer:NSRatio` on page 631

Timeout

For "Filter > Fixed Noise", sets a time limit for the averaging process.

Remote command:

`:SENSe<ch>[:POWER]:FILTer:NSRatio:MTIME` on page 631

Default Aperture Time

The sensor default setting is sufficient. Disable this parameter to specify a user-defined aperture time per sensor, if, for example, the readings vary.

To obtain stable readings, set the [Aperture Time](#) exactly to one modulation period.

Remote command:

`:SENSe<ch>[:POWER]:APERTure:DEFault:STATE` on page 628

Aperture Time

If "Use Default Aperture Time > Off", defines the acquisition time per sensor.

For example, to obtain a sufficient low average value, set the aperture time exactly to one modulation period.

Remote command:

`:SENSe<ch>[:POWer]:APERture:TIME` on page 628

S-Parameter

S-Parameter correction is used to mathematically shift the reference plane to the DUT by considering the S-parameters for any components connected upstream of the sensor.

The S-Parameter table can be changed with the S-Parameters tool, provided as part of the free R&S NRP Toolkit software. For more information, refer to the manual of the connected R&S NRP power sensor.

Remote command:

`:SENSe<ch>[:POWer]:CORRection:SPDevice:STATe` on page 629

`:SENSe<ch>[:POWer]:CORRection:SPDevice:LIST?` on page 629

`:SENSe<ch>[:POWer]:CORRection:SPDevice:SELeCt` on page 629

Enable Logging

Activates recording of R&S NRP power sensor readings in a log file.

There is 1 log file per sensor. The log files are created automatically and filled in continuously. They are text files with predefined filename `SensLog<n>.txt`, where `<n>` indicates the connected sensor. Log files are stored on the internal memory, in the directory `/var/user/SensorLogging`.

Each log file contains the measured value (2 readings when you work with peak sensors), the sensor type, and the measurement time (timestamp). Logged data is not overwritten. When a new measurement is started, the collected logging data is appended in the log file.

Check the used disc space regularly and remove log files to maintain storage capacity.

Note: The logging function is intended for measurements with long time intervals. It is suitable source for data reconstructions if the connection to the sensor was interrupted.

Remote command:

`:SENSe<ch>[:POWer]:LOGGing:STATe` on page 633

8.10.3.5 NRP sensor mapping

The "NRP Sensor Mapping" lists the sensors detected by the instrument.

Any R&S NRP sensor that supports the USB legacy protocol and is connected to one of the USB interfaces, is detected automatically and added to the list. When you disconnect a power sensor, the R&S SMCV100B removes it from the list accordingly.

R&S NRP sensors that are connected in the LAN or use the USBTMC protocol are only detected by the scan search function.

Access:

- ▶ Select "RF" > "RF Measurement" > "NRP Sensor Mapping".

NRP Sensors						
Power Viewer	Power Control	Sensor Configuration	Sensor Mapping			
	Sensor	Peak	Revision	Protocol	Connector	Mapping
1	NRP-Z11 900003	<input type="checkbox"/>	04.16	Legacy		1
2	NRP18SN 101699	<input checked="" type="checkbox"/>	02.40.22081101	Visa		3
3	NRP18SN 101748	<input checked="" type="checkbox"/>	02.40.22081101	Legacy		2
4	NRP18SN 101748	<input checked="" type="checkbox"/>	02.40.22081101	Visa		
5	NRP18TN 100952	<input type="checkbox"/>	03.00.23050801 .beta	Visa		
6	NRP67TN 101015	<input type="checkbox"/>	02.30.21062301	Visa		
7	NRP67TN 101016	<input type="checkbox"/>	02.30.21062301	Visa		
8	NRP6AN 101118	<input checked="" type="checkbox"/>	17.11.27.03	Visa		

Buttons: Scan, Start, Clear, Add Sensor ...

The dialog lists all detected R&S NRP sensors for selection and mapping. You can also browse the network for sensors.

The detected sensors are characterized by the used protocol and the corresponding connector icon. In the "Mapping" column, you can assign the sensor to one of the available sensor channels. The list can contain several entries but the R&S SMCV100B can only use up to four sensors simultaneously.

The remote commands required to define these settings are described in [Chapter 14.14, "SENSe, READ, INITiate and SLISt subsystems"](#), on page 621.

Settings

Sensor Mapping List	381
Scan	382
Clear	382
Add Sensor/Hide 'Add Sensor'	382
Add Sensor settings	382
L Add LAN Sensor settings	382
L Add USB Sensor settings	382

Sensor Mapping List

Shows the sensors that are connected to the R&S SMCV100B.

The table informs on the sensor type, specific features and the installed sensor firmware. It also shows the interface the sensor is connected to, including the communication protocol and the assigned channel.

Remote command:

:SLISt[:LIST]? on page 624

:SLISt:ELEMent<ch>:MAPPING on page 626

:SLISt:SENSor:MAP on page 626

Scan

Scans the network and the USB connections for sensors connected using the VISA communication protocol, i.e. sensors that are addressed over LAN or USBTMC.

The instrument detects sensors communicating over the USB legacy protocol automatically.

Remote command:

`:SLIST:SCAN[:STATe]` on page 624

Clear

Removes the selected sensor from the sensor mapping list.

Remote command:

`:SLIST:CLEAr:LAN` on page 625

`:SLIST:CLEAr:USB` on page 625

`:SLIST:CLEAr[:ALL]` on page 626

Add Sensor/Hide 'Add Sensor'

Shows or hides the "Add Sensor" settings.

Add Sensor settings

Configures settings to add sensors connected to the R&S SMCV100B over USB or LAN.

Add LAN Sensor settings ← Add Sensor settings

Configures settings to add sensors connected to the R&S SMCV100B via LAN.

"IP Address or Host Name"

Displays the host name or the IP address of a R&S NRP power sensor.

If the R&S SMCV100B does not detect a connected R&S NRP sensor, you can assign the address information manually.

"Add LAN Sensor"

Adds a detected R&S NRP sensor connected in the LAN to the list of sensors, including its device ID or name and its serial number.

Remote command:

`:SLIST:SCAN:LENSor` on page 624

Add USB Sensor settings ← Add Sensor settings

Configures settings to add sensors connected to the R&S SMCV100B via USB.

"Device ID or Sensor Name"

Displays the device identifier or the name of the R&S NRP power sensor.

If the R&S SMCV100B does not detect a connected R&S NRP sensor, you can assign the ID or name manually.

"Serial Number"

Displays the serial number of the R&S NRP power sensor.

If the R&S SMCV100B does not detect a connected R&S NRP sensor, you can assign the serial number manually.

"Add USBTMC Sensor"

Adds a detected R&S NRP sensor connected at the USB interface to the list of sensors, including its device ID or name and its serial number.

Remote command:

:SLIST:SCAN:USENsor on page 625

8.10.4 To calibrate the power level with an R&S NRP power sensor

Using a R&S NRP power sensor and the user correction function of the instrument, you can compensate external frequency responses. The R&S SMCV100B utilizes the readings of the power sensor and creates a correction value table for controlling the output level during operation.

To connect the R&S NRP to the R&S SMCV100B

1. Connect the power sensor.
See [Chapter 8.10.3.1, "Connecting R&S NRP power sensors to the R&S SMCV100B"](#), on page 368.
2. Select "RF" > "RF Measurement" > "NRP Sensor Mapping".
3. If the sensor is not detected automatically, select "Scan > Start".
The instrument scans the network and the USB connections for connected sensors and lists all detected R&S NRP sensors in the mapping table.
4. In the "Mapping" column, assign the sensor to a sensor channel, see [Chapter 8.10.3.5, "NRP sensor mapping"](#), on page 380.
5. Close the dialog.

To configure and calibrate the R&S NRP in the R&S SMCV100B

Provided the power sensor is connected to the R&S SMCV100B and is assigned to a sensor channel, we recommend that you calibrate and configure the power sensor.

1. In the block diagram > RF, turn off the RF output signal.
2. Select "RF" > "RF Measurement" > "NRP Power Viewer".

Power Viewer	Power Control	Sensor Configuration	Sensor Mapping	
1: NRP-Z81 900008		Average		-52.42 dBm Config ...
2: NRP18SN 101748		Average		-1.03 dBm Config ...
3: NRP67TN 101015		Average		-38.20 dBm Config ...
4: NRP33SN-V 900011		Average		-7.96 dBm Config ...

- To configure the sensor, select "Config".
- Select "Zero" to start zeroing of the sensor.
Note: Always turn the RF power off or disconnect the sensor from RF before zeroing, since the function calibrates the power sensor at zero signal power.
The zeroing process takes a few seconds, depending on the power sensor type.
- Configure additional parameters for the selected sensor as required.
- Select "State > On".
- Close the dialog.

To create user correction data with an R&S NRP and the R&S SMCV100B

We assume, that the power sensor is connected, assigned and ready for operation.

- Select "RF" > "RF Level" > "User Correction".

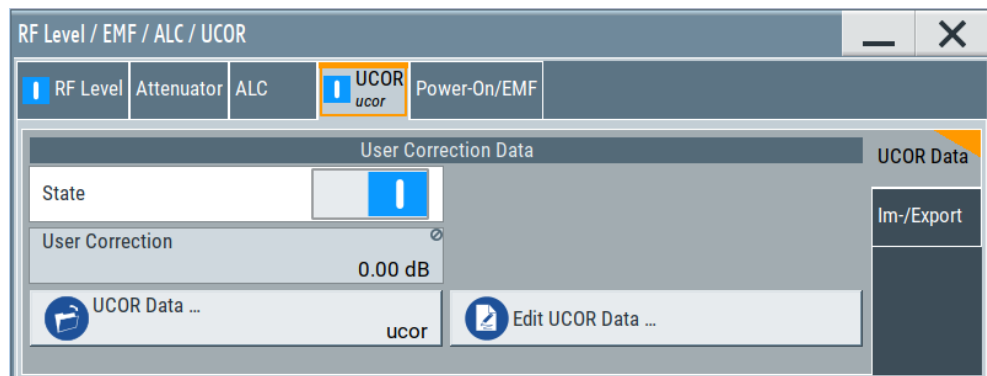

- Select "UCOR Data" > "UCOR Data...."
- Create a file: "New" > Filename and confirm with "OK".
- Select the new file with "Select".
- Select "Edit UCOR Data...".
- Select "Edit" > "Fill".
The "Fill Table" dialog enables you to fill in the values of the columns automatically.
- To fill in the frequency column:

From	0	Range	15
Column To Fill	Frequency / Hz		
Start Value	1.560 000 000 00 GHz	End Value	1.574 000 000 00 GHz
Increment Value	1.000 000 00 MHz		
<input checked="" type="checkbox"/> Fill			

- Select "Select Column To Fill > Frequency / Hz".
- Select "Range > e.g. 15" to determine the number of values.
- Select "Start Value > e.g. 1.56 GHz".
- Select "Increment Value > e.g. 1 MHz", to determine the frequency steps.
- Select "Fill", to insert the frequency values.

The "Fill" function also fills the column of the "Correction Value / dB" values with a predefined value, since empty cells lead to the data loss of the entire line. If you need different values, you can change them manually, or you can use the automatic function "Fill with Sensor" as described in the next steps.

- Select "Fill with Sensor".

The "Fill User Correction Data With Sensor" dialog provides an overview of the sensor configuration.

- Select "Execute".

The R&S SMCV100B successively sets each frequency point, reads the measured power of the sensor and fills in the value in the correction table.

- Select "Save" to save the data in the file.

- Close the dialog.

To perform power leveling calibration with user correction data

We assume that a user correction file is available in the user directory of the R&S SMCV100B or on a memory stick or in a shared directory.

If you have created and saved the file immediately before this step, the file is loaded in the "User Correction" dialog automatically. Otherwise you can load a previously saved file.

- Select "RF" > "RF Level" > "User Correction".
- Select "UCOR Data" > "UCOR Data...", if there is no file loaded already.
- Select the directory and file you want to use.
- Load the file with "Select".
- To view the file content, select "Edit UCOR Data...".

6. Select "UCOR Data" > "State" > "On" to apply the user correction values.

When you activate the RF output, the R&S SMCV100B considers the user correction data and adjusts the signal level accordingly to compensate external frequency responses.

9 Configuring a multi-instrument setup

R&S SMCV100B is rarely used as a standalone instrument. Usually, the instrument is connected to a device under test (DUT) or other measurement equipment.

Test setups have different requirements, for example:

- You can configure the R&S SMCV100B as secondary instrument in a multi-instrument setup. This configuration is useful for performance testing, e.g. nx4 MIMO configuration of 5G NR and WiFi in the frequency band above 6 GHz.
- Test setups comprising two or more instruments often require a common reference frequency.
- Some test setups also require control of the signal generation start and an exact generation start time, for example determined by a defined trigger event.
- etc.

9.1 Synchronizing instruments

For information on the possible scenarios concerning the distribution of reference frequency, test setups and the related settings:

See [Chapter 8.8, "Reference oscillator"](#), on page 312.

For information on how to generate time-aligned baseband signals:

See [Chapter 5.5, "Generating time-aligned baseband signals"](#), on page 278.

For information on how to configure a multi-instrument setup:

See [Chapter 9.3, "Configuring the setup"](#), on page 389.

9.2 Connecting to R&S SMW

Multi-instrument setup

[Figure 9-1](#) shows a multi-instrument setup for, e.g. nx4 MIMO configuration:

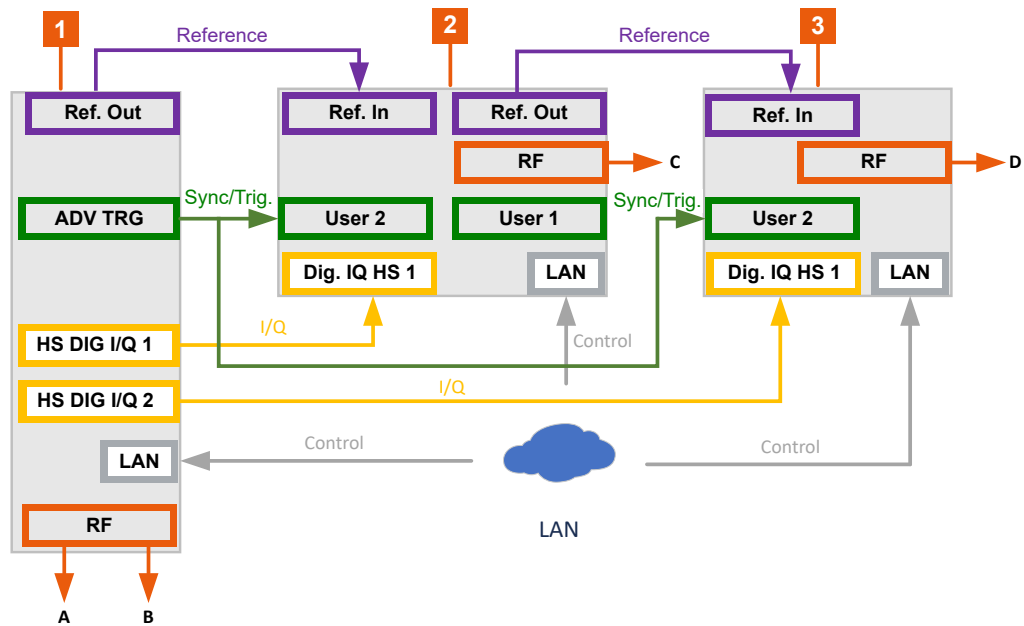

Figure 9-1: Multi-instrument setup

- 1 = R&S SMW
- 2 = R&S SMCV100B 1
- 3 = R&S SMCV100B 2

To connect the R&S SMCV100B

With the default connector settings of all instruments:

1. Connect all connections between R&S SMW and R&S SMCV100B as in Table 9-1.

Table 9-1: Signals and connections

Signal	R&S SMW	R&S SMCV100B 1	R&S SMCV100B 2
I/Q	HS DIG I/Q 1 ("BBMM 1")	Dig. IQ HS 1	
I/Q	HS DIG I/Q 2 ("BBMM 2")		Dig. IQ HS 1
Sync/Trigger	ADV TRG	User 2	
Sync/Trigger	ADV TRG		User 2
Reference	REF OUT	Ref In	
Reference		Ref Out	Ref In
Control	LAN	LAN	LAN

Note: Avoid unnecessary cable length and branching points. Use cables of the same length and type for all connections between the primary instrument and the secondary instruments and between secondary instruments.

2. Connect all instruments in the setup to the same LAN.

See

- The R&S SMW user manual

- [Chapter 13.5.1, "Network settings"](#), on page 518

9.3 Configuring the setup

We assume you have connected the R&S SMW and the two R&S SMCV100B generators as described in [Chapter 9.2, "Connecting to R&S SMW"](#), on page 387.

Setting the reference frequency

1. On the R&S SMCV100B, select "RF > Reference Frequency > Source > External".
2. On the R&S SMW, select "RF > Reference Frequency > Source > Internal".

Configuring the primary instrument (R&S SMW)

1. Select "System Configuration" > "Fading/Baseband Config":
 - a) Select "Mode > Advanced".
 - b) Select "Signal Outputs > Analog & Digital (HS)".
 - c) Click "Apply".
2. Select "System Configuration" > "I/Q Stream Mapper".
3. In the "I/Q Stream Mapper", route the I/Q streams to the output connectors:
 - "Stream A": "RF A"
 - "Stream B": "RF B"
 - "Stream C": "BBMM 1"
 - "Stream D": "BBMM 2"
4. Select "System Config > System Config > Multi Instrument".
5. Select "Common Trigger" > "Multi Instrument Trigger" > "**Primary**".
6. Select "State > On".

Configure the remote connection in the R&S SMW:

1. Select "System Config > System Config > External RF and I/Q".
 - a) Select "BBMM 1 > External Instrument > Config".
 - b) Select "External Instrument > R&S SMCV100B".
 - c) If the list does not show the R&S SMCV100B, click "Scan".
After the scanning procedure finishes, the R&S SMCV100B appears in the updated list.
 - d) Click "Apply and Connect".
Follow the same procedure for configuring the external instrument on "BBMM 2".
2. Check if the remote connections are active.

Multi Instrument | Fading/Baseband Config | I/Q Stream Mapper | **External RF and I/Q** | Overview

Display
Mapped Connectors

Connect All Remote | Disconnect All Remote | Auto Connect

Preset behavior: Keep connections to external instruments

	Dir	External Instrument	I/Q Conn	Rem Conn	Instrument Name	RF Coup	RF Frequency (Hz)	RF Level (dBm)	RF State
CODER 1	In	Config...							
BBMM 1	Out	Config...			SMCV100B (100004)	On	Δ: 0.00	Δ: 0.00	On
BBMM 2	Out	Config...							
I/Q OUT 1	Out	Config...	Single Ended						
I/Q OUT 2	Out	Config...	Single Ended						
RF	Out	Config...							

Configure the baseband signal as required for the particular test setup, for example:

1. Select "Baseband > 5G NR/Sidelink".
2. Configure the trigger signal:
 - a) Select "Baseband > 5G NR/Sidelink > Trigger In".
 - b) Select "Trigger Mode > Armed Retrigger" and "Trigger Source > Internal".
 - c) Activate "Sync. Output to Ext. Trigger".

The trigger parameters of all basebands are coupled. Once the basebands are activated, they use common trigger signal.

Activating the output:

- ▶ Activate "RF = On".

Activating the output of the primary instrument R&S SMW automatically activates the RF output of the secondary instruments R&S SMCV100B in the setup.

Checking the settings of the secondary instruments (R&S SMCV100B)

The secondary instruments are controlled by the primary instrument. The primary instrument sets the configuration of the secondary instruments remotely.

Check the settings of the secondary instruments:

1. The block diagram after finishing the configuration of the primary instrument:

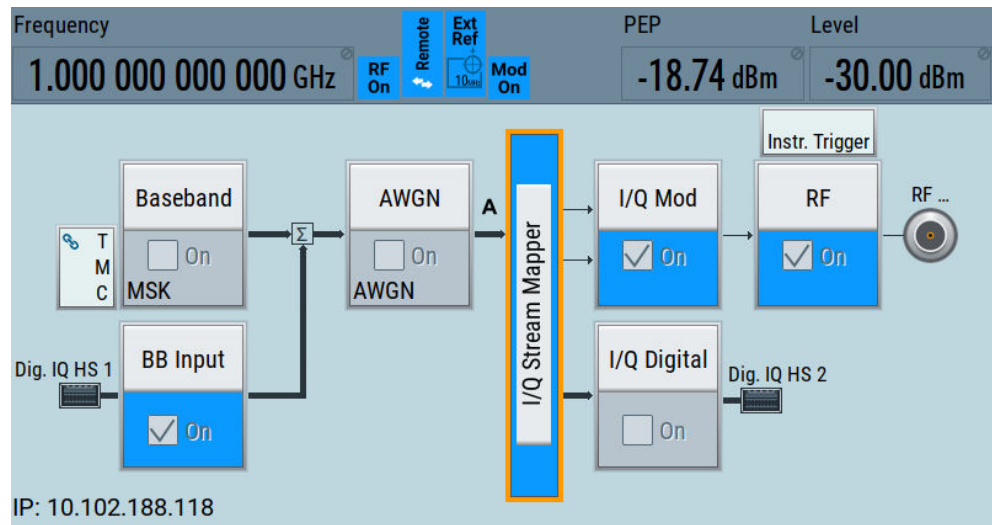

2. Select "BB Input > Baseband Input Settings".

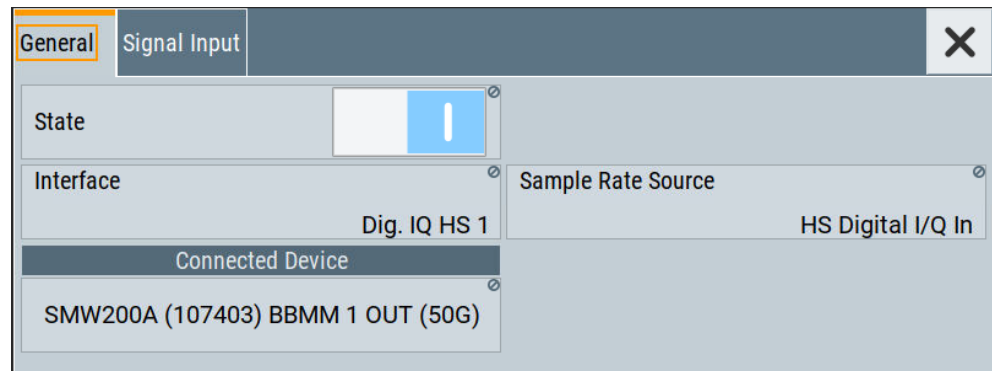

3. Select "Block Diagram > I/Q Stream Mapper > System Configuration > Multi Instrument".

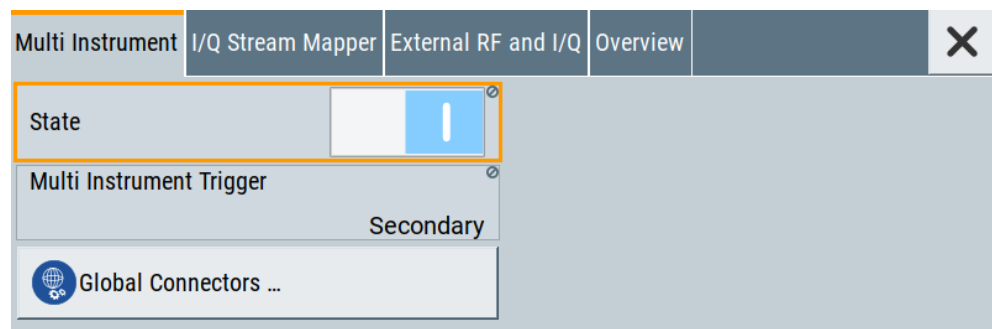

4. Select "Block Diagram > I/Q Stream Mapper > System Configuration > External RF and I/Q".

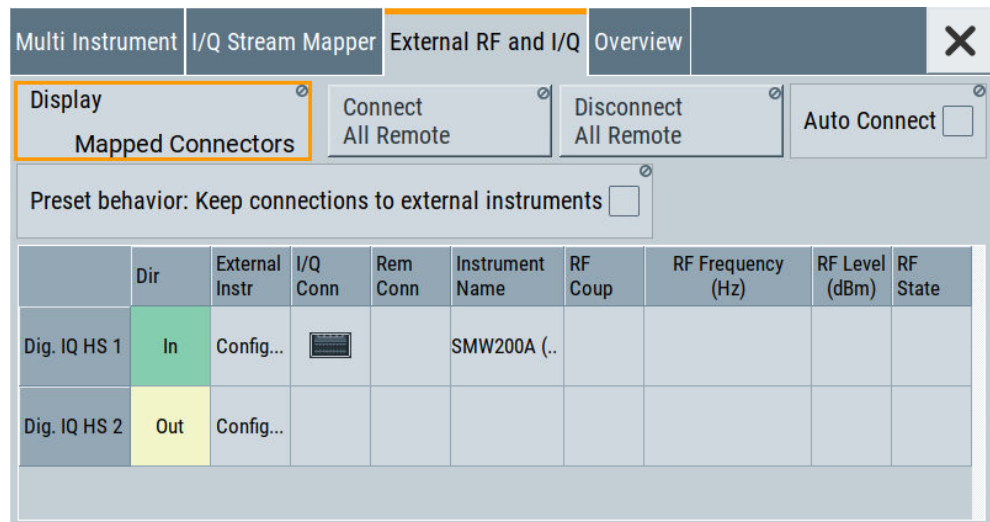

9.4 Multi-instrument settings

Access:

- ▶ Use one of the following:
 - Select "Taskbar > System Config > System Configuration > Multi Instrument"
 - Select "Block Diagram > I/Q Stream Mapper > System Configuration > Multi Instrument"

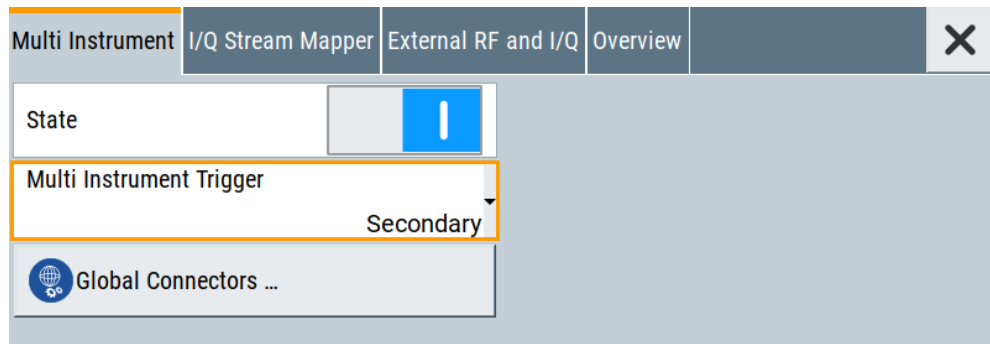

For step-by-step description, see [Chapter 9.3, "Configuring the setup"](#), on page 389.

Settings

State	392
Multi Instrument Trigger	393
Global Connector Settings	393

State

Activates the configuration.

With "State = Off", the instrument works in a standalone mode.

Remote command:

[:SCONfiguration:MULTiinstrument:STATE](#) on page 638

Multi Instrument Trigger

Requires "Multi Instrument > State = On".

Sets the mode in that the instrument works.

"Primary" Not available for R&S SMCV100B in multi-instrument mode.

"Secondary" Synchronizes to the supplied trigger signal from the primary instrument.

Remote command:

[:SCONfiguration:MULTiinstrument:MODE](#) on page 638

Global Connector Settings

Provides a quick access to the related global connector settings.

With "State = On", the synchronization signal is assigned per default as follows:

- "Multi Instrument Trigger > Secondary"
 - "Connector = User 1": "Direction = Output", "Signal = Baseband Marker"
 - "Connector = User 2": "Direction = Input", "Signal = Baseband Sync In"

See also:

- [Chapter 12.2, "Configuring global connectors"](#), on page 449

10 Monitoring signal characteristics

The R&S SMCV100B is a highly configurable signal generator with level settings distributed over several dialogs. To optimize the signal generation process and to help monitoring the variation of the signal parameters through the instrument, the R&S SMCV100B is equipped with a real time graphical signal display. This section explains the provided functions for monitoring of the signal characteristics in real time. Here you can also find out how to visualize the generated signal with measurement diagrams.

10.1 Displaying baseband signal characteristics in real-time

In test setups, you usually use signal and spectrum analyzers or an oscilloscope to display and analyze the characteristics of the generated signal. In the R&S SMCV100B, you can also use the built-in graphical signal display function and visualize a subset of signal characteristics.

10.1.1 Required options

The minimum equipment layout for using this function includes the base unit.

10.1.2 About the graphical signal display

To ease the setting and routing of baseband signals, R&S SMCV100B is able to capture these signals and display them graphically in different ways: as I/Q, vector, eye or constellation diagram, as power spectrum or as statistical evaluations.

In the digital domain, the measurements are based on recorded I/Q samples. The sources of these samples are selectable points (acquisition points) in the signal flow. You can configure and display the signal characteristics simultaneously in up to diagrams.

10.1.2.1 Available diagrams

This section focuses on graphical signal displays, their content and application. See [Table 10-1](#) for an overview of the signal characteristics you can monitor.

Table 10-1: Graphics modes overview

Graphics modes	Domain	Measurement is known from this instrument
I/Q diagram	Time	Oscilloscope (standard mode)
Vector diagram	Time	Oscilloscope (XY mode)

Displaying baseband signal characteristics in real-time

Graphics modes	Domain	Measurement is known from this instrument
Constellation diagram	Time	Oscilloscope (XY mode)
Eye diagram	Time	Oscilloscope (triggered to symbol clock and showing repetitive traces)
CCDF display	Statistical representation of peaks	Peak Power Analyzer
Power spectrum	Frequency	Spectrum Analyzer

I/Q diagram

The I/Q diagram displays the inphase component ($i[t]$) and quadrature component ($q[t]$) of the I/Q signal over time.

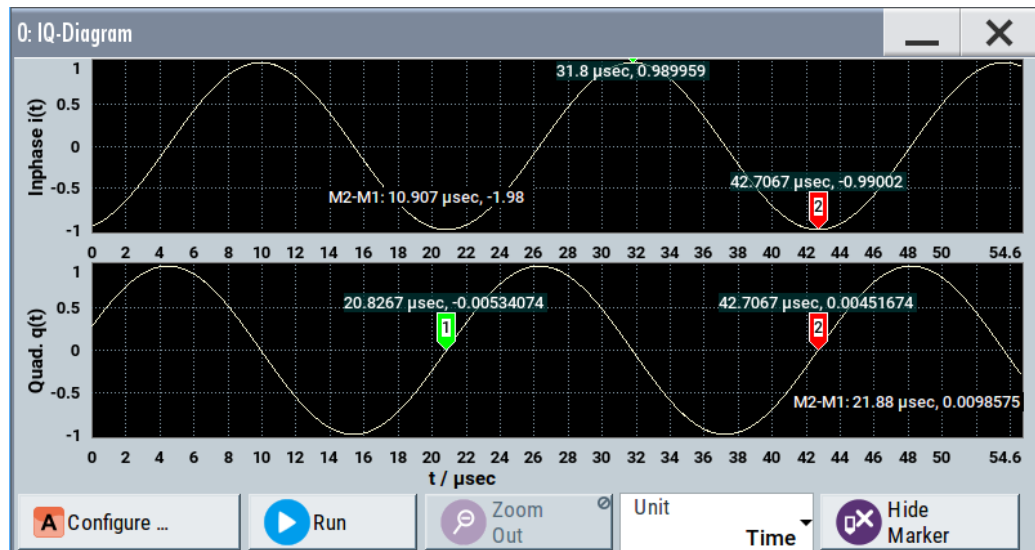

Figure 10-1: I/Q diagram with markers

= window with two separate coordinate systems with identical X and Y axes

X-axis = time represented as number of symbols, chips, or samples depending on the signal

Y-axis = amplitude, scaled to the peak envelope power; where minimum scaled amplitude = -1, maximum scaled amplitude = +1

Application: To analyze impairments, added noise and signals (e.g. from external baseband input) in the time domain. This mode shows the signal like an oscilloscope.

Signal acquisition points: See [Table 10-2](#).

Vector diagram

The vector diagram displays the Q component over the I component. All points in the complex domain are connected by lines.

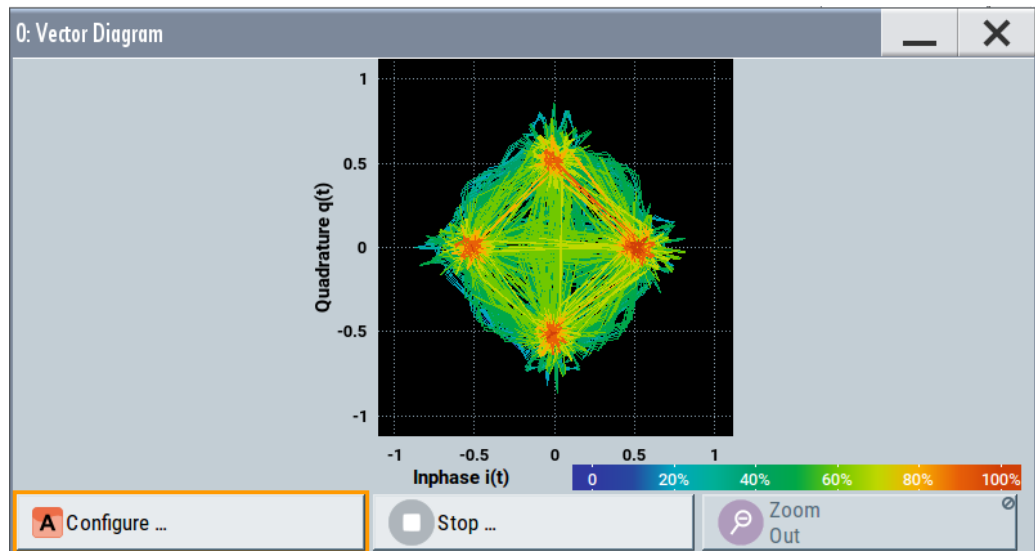

Figure 10-2: Vector diagram (64 QAM)

X-axis, Y-axis = amplitudes of the signal components, scaled to the peak envelope power; where minimum scaled amplitude = -1, maximum scaled amplitude = +1

Application: To analyze the transition between the various states of modulation mapping, especially with linear modulations like MSK, QPSK or QAM. This mode shows the signal like an oscilloscope (X/Y-mode).

Signal acquisition points: See [Table 10-2](#).

Constellation diagram

Constellation diagrams display the modulation symbols as discrete points in the I/Q plane. Unlike the vector diagram, the constellation diagram displays only one sample per symbol. This sample represents the symbol.

Constellation diagrams are helpful when generating signals using the "Custom Digital Modulation" settings. Compare the displayed constellation diagram with the diagram displayed in the "Custom Digital Modulation > Modulation" dialog.

Displaying baseband signal characteristics in real-time

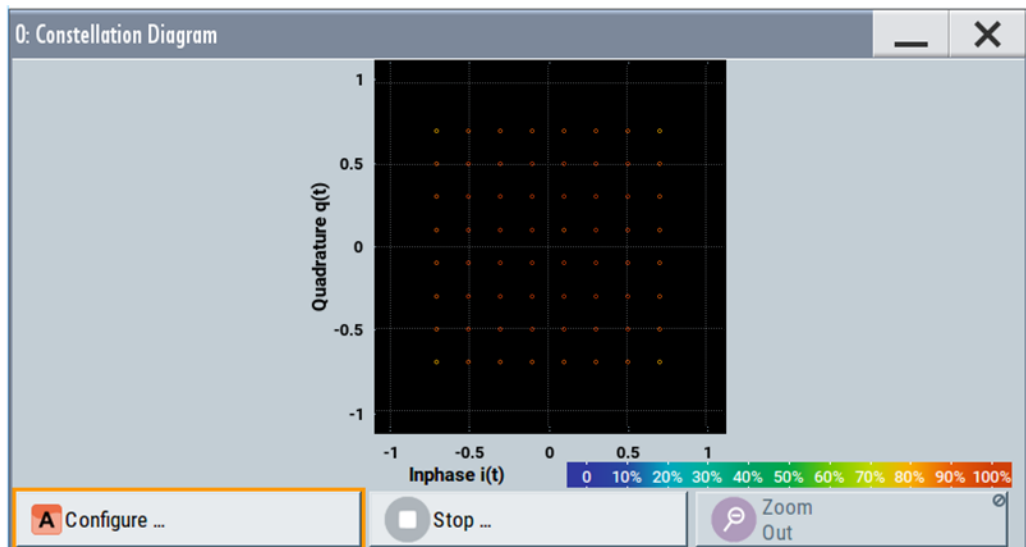

Figure 10-3: Constellation diagram (64 QAM)

X-axis, Y-axis = amplitudes of the signal components, scaled to the peak envelope power; where minimum scaled amplitude = -1, maximum scaled amplitude = +1

Application: To classify modulation.

Signal acquisition points: See [Table 10-2](#).

Eye diagram

The eye diagram displays synchronized and superimposed sections of either the in-phase or the quadrature components of the signal.

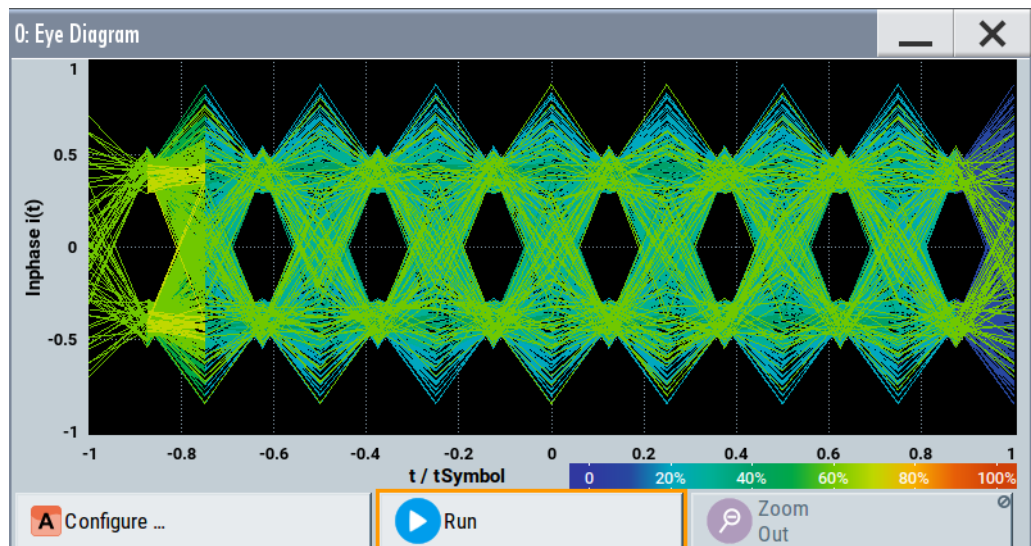

Figure 10-4: Eye diagram with partially closed eye (QPSK)

X-axis = time in the range of ± 1 symbol

Y-axis = amplitude, scaled to the peak envelope power; where minimum scaled amplitude = -1, maximum scaled amplitude = +1

The display width is normalized for 2 symbols. It uses one-symbol "eye opening" in the center of the display and 1/2-symbols to the left and right of the center eye for capturing time transitions. Several hundreds curve segments are superimposed. The beginning of the recording is synchronous to the symbol and chip clock pulse.

Application: To analyze amplitude and time distortion elements (e.g. jitter) at high-speed digital data systems. A high quality, unimpaired signal shows a clearly open eye (horizontally and vertically).

Signal acquisition points: See [Table 10-2](#).

CCDF display

The complementary cumulative distribution function (CCDF) displays the probability with which the output signal exceeds the average power.

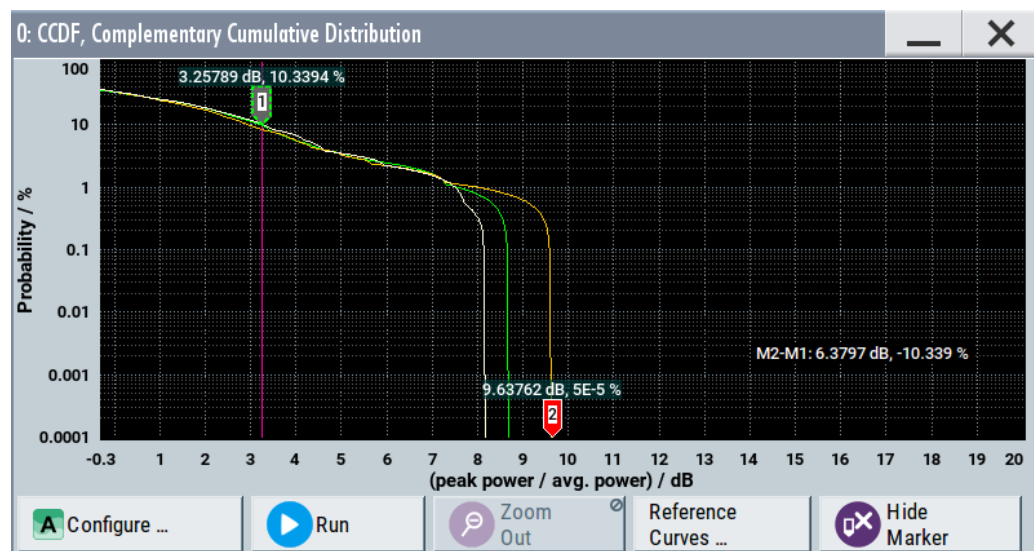

Figure 10-5: CCDF diagram of a 5 MHz LTE Signal (Level -30 dBm) and two reference curves

X-axis = Level over the average signal power, where the average power (RMS) corresponds to the origin
 Y-axis = Probability of exceeding the average power, that is the percentage of time the signal spends at or above the power level specified by the X-axis

Marker 1 = Interpolation: 10.3% of the samples exceed 3.3 dB above average; similarly 1% of the samples exceed 7.5 dB above average (not shown with a marker)

Marker 2 = The point where the trace crosses the x-axis; indicates the highest peak that is found in the sample block and is 9.6 dB higher than average.

The CCDF diagram is calculated over 8 KSamples and corresponds to a signal with the following characteristics:

- "Baseband > LTE" and "Test Model > E-TM1_1__5 MHz"
- "Status bar > Level = - 30 dBm" and "Status bar > PEP = - 18.43 dBm"
 The difference between the level and the PEP results in the peak to average ratio. If the measurement is long enough, the displayed highest peak would correspond to the calculated crest factor.
 The PEP value does not indicate how often the peak level is reached. The CCDF shows the probability for reaching a dedicated instantaneous power.

Signal acquisition points: See [Table 10-2](#).

Power spectrum

The power spectrum displays the signal spectrum which is calculated from the I/Q signal with fast Fourier transform (FFT). The power density over frequency is displayed.

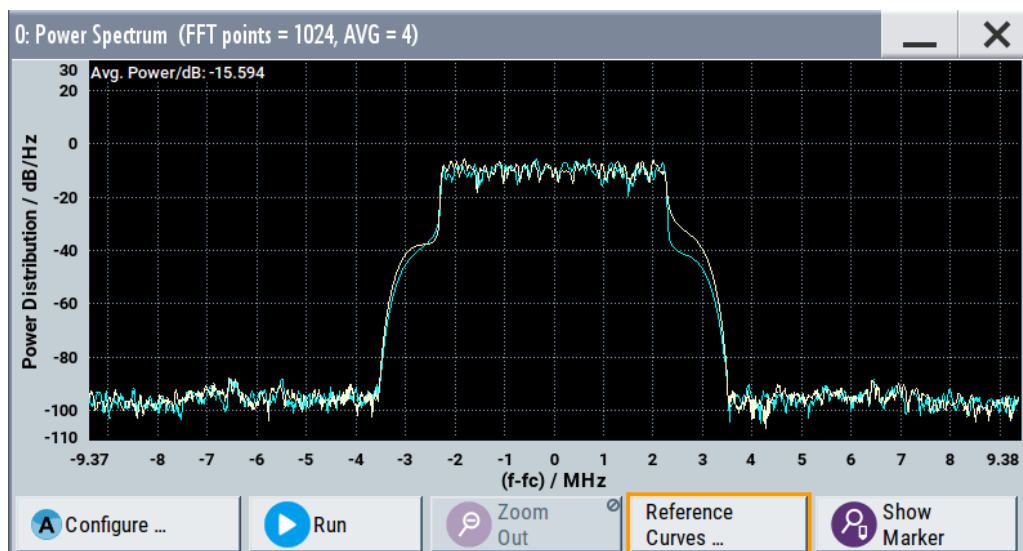

Figure 10-6: Power spectrum diagram of a 5 MHz LTE signal with enabled reference curve (blue)

"FFT points" = indicates the number of I/Q value pairs that are used for calculating a (part-)FFT
 "AVG" = indicates the number of subspectra used for averaging
 X-axis = frequency plotted symmetrically (- Sampling Rate/2 to +Sampling Rate/2)
 Y-axis = power density

Signal acquisition points: See [Table 10-2](#).

10.1.2.2 Signal acquisition points

Signal characteristics can be displayed using different methods and different acquisition points, also at the same time. [Table 10-2](#) shows which signal acquisition point is suitable for which kind of graphics mode. Also, it provides associated graphics sources and the designation of the access points in the block diagram.

Table 10-2: Signal acquisition points, modes and sources

Signal acquisition points	Graphics modes	Graphics source	Designation
Baseband signals	Constellation diagram, eye diagram	"Baseband" "BB Input"	A A
Input streams	I/Q diagram, vector diagram, CCDF diagram, power spectrum diagram	"Stream"	A
Analog outputs	I/Q diagram, vector diagram, CCDF diagram, power spectrum diagram	"RF"	A
Digital output streams	I/Q diagram, vector diagram, CCDF diagram, power spectrum diagram	"IQ Digital"	I

Figure 10-7 shows an example for locations of signal acquisition points.

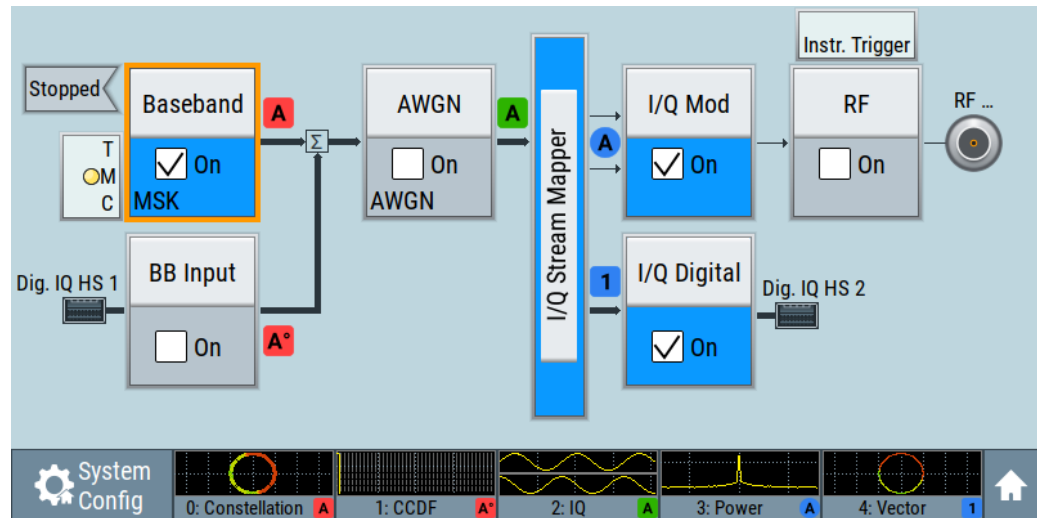

Figure 10-7: Block diagram with graphical signal display and signal acquisition points

10.1.2.3 Display functions

The graphical display provides general display functions known from other measurement instruments and offers zoom and markers.

Zooming

You can zoom into the diagram to visualize the measurement results in greater detail. Using the touchscreen or a mouse pointer you can easily define the area to be enlarged.

Zooming is merely a visual tool, it does not change the number of samples used for the calculation. You can increase the number of samples before zooming.



See also ["To zoom into a diagram"](#) on page 410.

Using markers

Markers are tools for numerical readout of measured data in diagrams. They help you analyze the displayed signal characteristics by determining particular values in the diagram.

Often you can use markers to measure the frequency distance of two peaks or to measure the power decrease of an oscillator at a given frequency offset, dBc value. Note that markers in the diagram are not related to the markers in the digital standards.

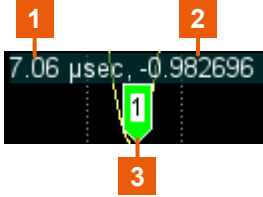
In the graphical display, the markers and their values (for example time or frequency) are displayed as usual.

Single marker indication	Delta marker indication
 <ul style="list-style-type: none"> 1 = marker position on the x-axis in the current units 2 = marker value on the y-axis 3 = marker number 	 <ul style="list-style-type: none"> 1 = delta marker 2 = result of the marker function, i.e. the delta values in the current units

See also ["To enable markers to readout exact measured data"](#) on page 411.

Persistence and color maps

In addition to the standard representation, the vector, the constellation, and the power spectrum diagrams use a color map.

The color encodes the relative amplitude (in percent) of the probability distribution of the data points in the diagram. A detailed breakdown of the colors is below diagrams the colors are relevant for. Data points in areas with high probability are marked in red, data points in areas with low probability in blue. Thus, for example, you can observe not only the "level versus frequency" trace but also a third dimension, the probability of the power level.

Reference trace

Reference traces help you analyze a displayed characteristic, as do the markers. Reference traces are used to define amplitude curves or spectral distribution boundaries in the result diagram which are not to be exceeded. They indicate, for example, the upper power limits which are allowed from a device under test (DUT).

The R&S SMCV100B supports up to five reference traces. You can load reference traces and activate them simultaneously.

10.1.3 Graphics configuration settings

This section focuses on the graphics configuration dialog, which determines the number and kind of the graphical signal displays.

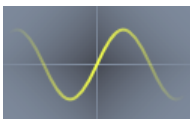

Access:

1. Select "Taskbar > System Config > Graphics" or use the wave icon.

The "Graphics Configuration" dialog opens.

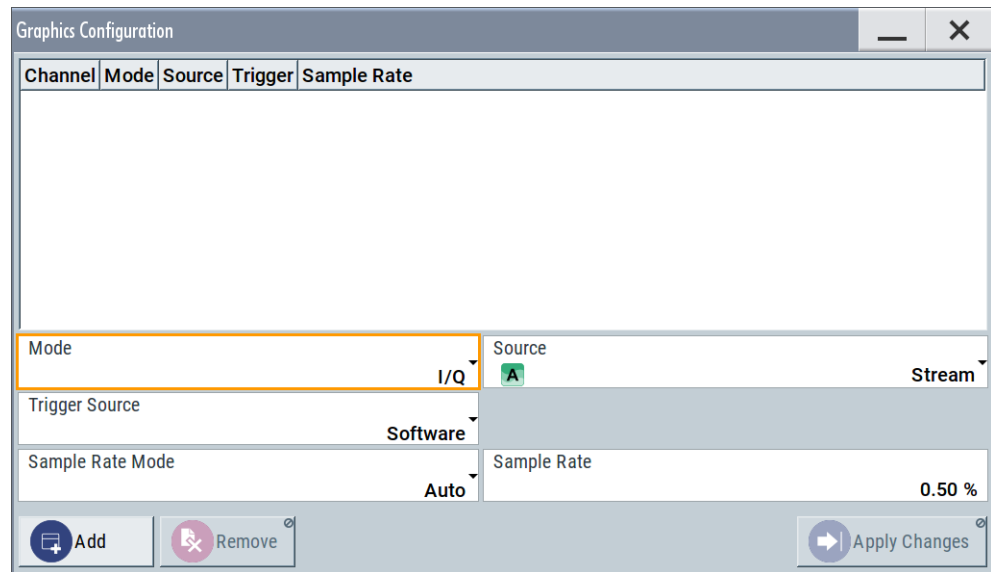

Figure 10-8: Graphics configuration dialog

2. To determine the kind of signal display, use the parameter "Mode".
3. To select suitable signal acquisition points, use the parameter "Source".
4. To enable the graphical signal display, select "Add".

A thumbnail of the graphical signal display is shown in the taskbar.

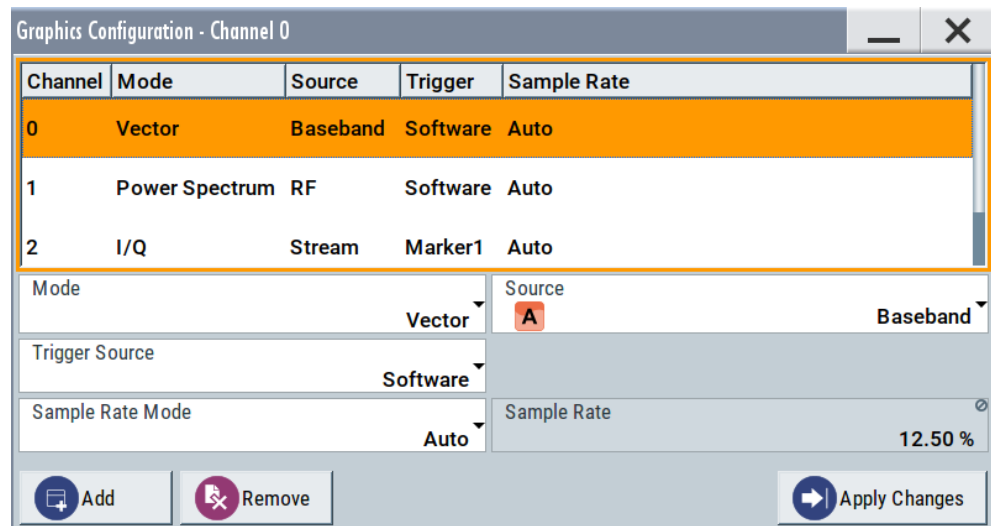

Figure 10-9: Graphics configuration dialog with active graphical signal displays

5. To enlarge the thumbnail, select it.

Settings:

Graphical Diagrams Table.....403
 Mode.....403
 Source.....403

FFT Length.....	403
Full Scale (dBFS).....	403
Trigger Source.....	403
Sample Rate Mode.....	404
Sample Rate.....	404
Add.....	404
Apply Changes.....	404
Remove.....	405

Graphical Diagrams Table

The active graphical signal displays are listed in the table at the top of the dialog.

Mode

Determines the graphics mode, see [Chapter 10.1, "Displaying baseband signal characteristics in real-time"](#), on page 394.

Remote command:

`[:SOURce<hw>] :BB:GRAPhics:MODE` on page 748

Source

Defines the signal acquisition point, see [Chapter 10.1.2.2, "Signal acquisition points"](#), on page 399.

Remote command:

`[:SOURce] :BB:GRAPhics:SOURce` on page 749

FFT Length

In "Mode > Power Sepectrum", selects the number of samples to be included in the graph of the power spectrum.

Remote command:

`[:SOURce] :BB:GRAPhics:FFTLen` on page 750

Full Scale (dBFS)

In "Mode > Power Spectrum", determines the normalization of the power values in the diagram.

Observe the change in the units on the y-axis.

"On" The maximal digital power $|I|=|Q|=max$ is mapped to 0 dB in the power spectrum diagram.

The y-axis shows the normalized power in dBFS.

"Off" The frequency average of the displayed power (frequency domain) agrees with the average power in the time domain.

The y-axis shows the power distribution in dB/Hz.

Remote command:

`[:SOURce] :BB:GRAPhics:FFTFscale` on page 750

Trigger Source

Defines the trigger for signal recording.

Displaying baseband signal characteristics in real-time

"Software"	Recording of signals starts automatically in predefined intervals. This asynchronous method is suitable if a representative display of the complete signal is required.
"Marker 1"	The starting point for recording of signals is determined by the marker 1 setting of the activated digital standard ("Trigger/Marker" dialog). This synchronous method is suitable if specific signal segments are to be shown in greater detail. With periodic signals, a static image is obtained by selecting a period length of marker 1 that is equal to the signal period. The displayed signal segment can be shifted by entering a marker delay in the "Trigger/Marker" dialog of the activated digital standard.

Remote command:

[\[:SOURce<hw>\]:BB:GRAPhics:TRIGger:SOURce](#) on page 750

Sample Rate Mode

Sets how the time resolution of the signal is determined. Maximum resolution corresponds to a display covering the entire signal bandwidth. The higher the resolution, the shorter the length of the displayed signal segment.

"Auto"	The resolution is set to an optimum value in terms of signal and display type.
"Full Bandwidth"	The resolution is set so that the display covers the entire signal bandwidth.
"User"	Activates the "Sample Rate" input field, where you can manually set the resolution.

Remote command:

[\[:SOURce<hw>\]:BB:GRAPhics:SRATe:MODE](#) on page 748

Sample Rate

- If "Sample Rate Mode = Auto/Full Bandwidth"
Displays the percentage of the entire signal bandwidth which is used for the graphical signal display.
- If "Sample Rate Mode = User"
Input for the percentage of signal bandwidth which is used for the graphical signal display.

Remote command:

[\[:SOURce<hw>\]:BB:GRAPhics:SRATe:USER](#) on page 749

Add

Adds a graphical signal display (as set in the "Graphics Configuration" dialog) to the taskbar/graphical diagrams table.

Remote command:

[\[:SOURce\]:BB:GRAPhics:ADD](#) on page 749

Apply Changes

Enables the current settings for the selected graphical signal display.

Remove

Removes the selected graphical signal display from the taskbar/graphical diagrams table.

Remote command:

[\[:SOURCE\]:BB:GRAPHics:CLOSE](#) on page 749.

Note, that this command closes all graphical signal displays.

10.1.4 Graphical signal display settings

Access:

1. Select "Taskbar > System Config > Graphics > Add".
2. Double click the thumbnail in the taskbar.

This section focuses on the functions of the enlarged graphical signal displays.

Settings:

Configure	405
Stop / Run	405
Zoom Out	405
Reference Curves	405
Display Units	405
Show / Hide marker	406
Reference Curve	406

Configure

Opens the "Graphics Configuration" dialog, see [Chapter 10.1.3, "Graphics configuration settings"](#), on page 401.

Note: This function is available for enlarged graphical signal displays and in the context menus of the thumbnails.

Stop / Run

Stops the processing of the displayed signal and freezes it.

"Run" continues a stopped displayed signal.

Zoom Out

Resets a previous zoom, see also ["To zoom into a diagram"](#) on page 410.

Reference Curves

Accesses the dialog for defining reference curves, see ["Reference Curve"](#) on page 406.

Display Units

Changes the units of the X-axis. The available values depend on the generated signal.

Show / Hide marker

Sets two markers to the displayed signal or hides them.

See also:

- ["Using markers"](#) on page 400
- ["To enable markers to readout exact measured data"](#) on page 411

Reference Curve

Enable the indication of up to five configurable reference curves (traces).

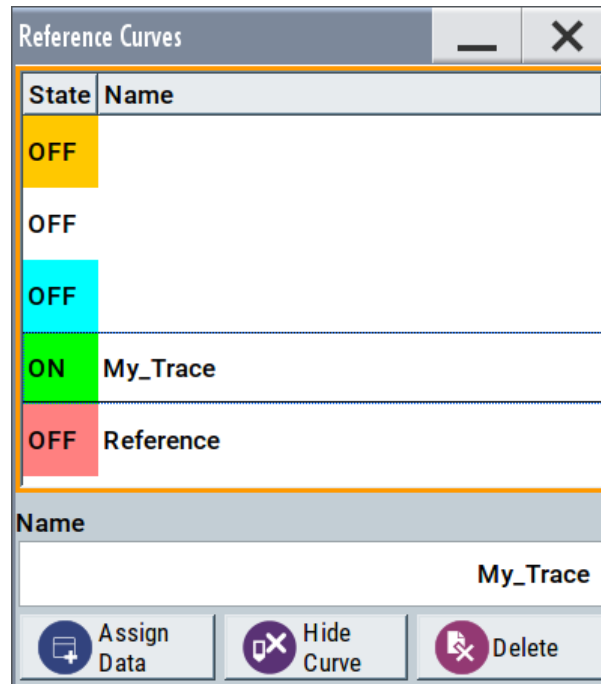

See ["Reference trace"](#) on page 401.

"Reference Curves Table"

Lists the configured reference curves and their current state.
To change a curve, select it.

"Name" Enters the name of a new reference curve

"Assign Data" Accesses the standard "File Select" function to load a file describing a reference curve

"Show Curve" Toggles the show/hide state of the selected curve

"Delete" Removes the curve

10.1.5 How to verify the generated signal with the graphics display

This section shows you how to use the different graphic modes to visualize the signal characteristics of the generated signal. It shows also how to observe the effect of standard settings, like applied filter, an enabled fading or AWGN. The examples use a simple custom digital modulated signal.

To generate a simple WCDMA-3GPP (QPSK 45° offset) signal

- ▶ Use the custom digital modulation. Enable a predefined WCDMA-3GPP signal.

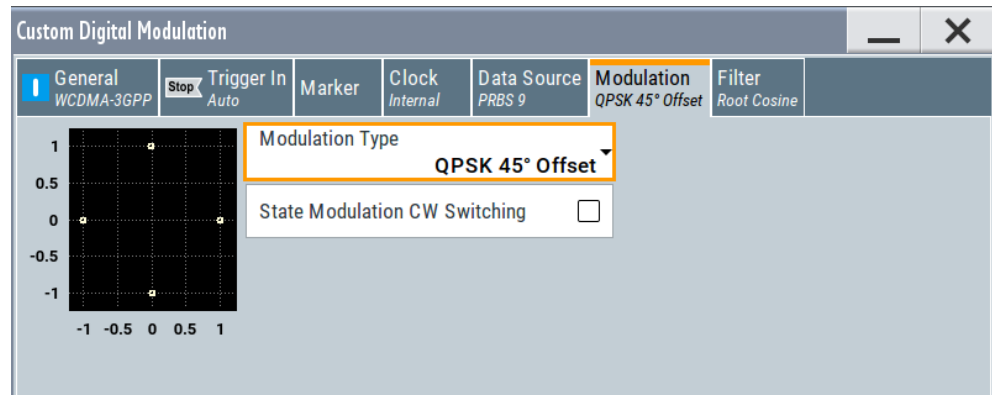
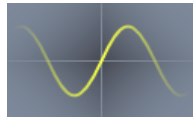

Figure 10-10: Used modulation type

Configure the graphical signal display

1. Select the wave icon:



The "Graphics Configuration" dialog opens.

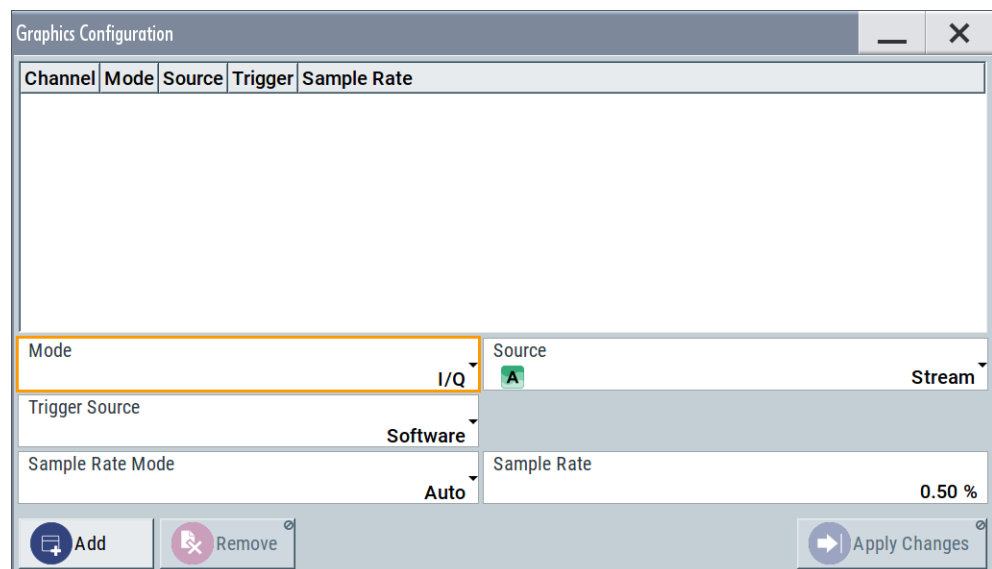

2. Select "Mode > Constellation".
3. Select "Source > Baseband".
4. To view the signal, select "Add".

Displaying baseband signal characteristics in real-time

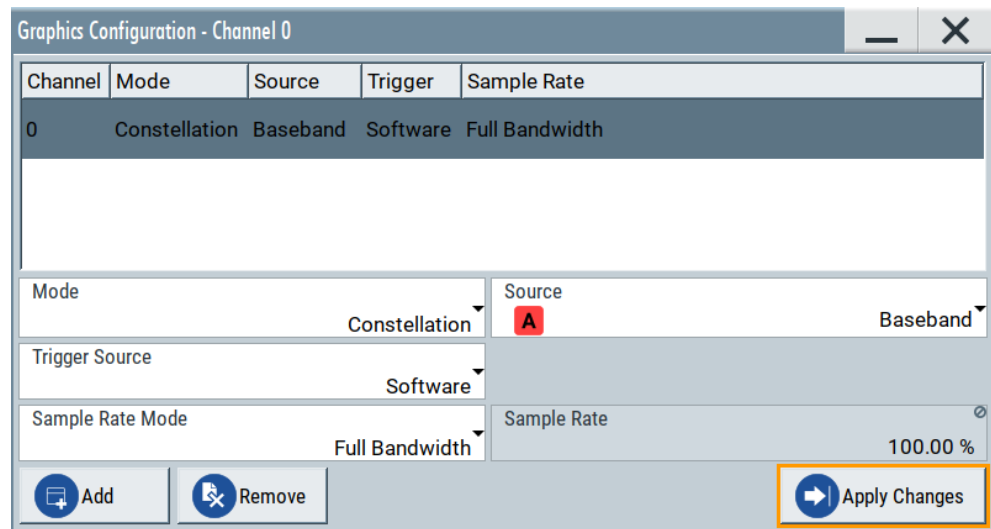

A new thumbnail (minimized view) indicating the constellation diagram appears in the "Taskbar".

- To enlarge the constellation diagram, select it.

The displayed constellation diagram confirms the used modulation type, see [Figure 10-10](#).

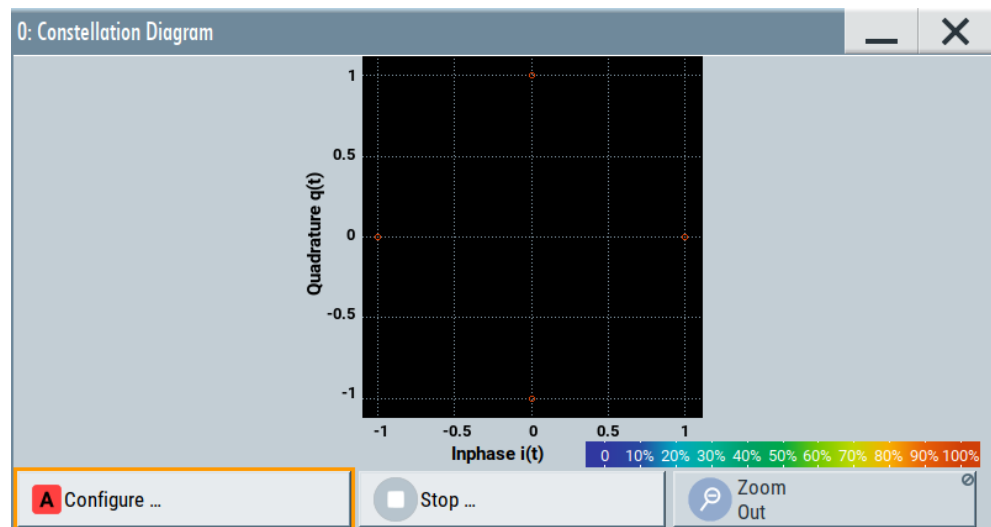

Figure 10-11: Constellation diagram of a WCDMA-3GPP (QPSK 45° offset) signal

To set and verify a baseband frequency offset

- In "Baseband > Baseband Offsets", set "Baseband > Frequency Offset = 1 Hz"

Displaying baseband signal characteristics in real-time

Baseband Offsets			
	Frequency Offset /Hz	Phase Offset /°	Gain /dB
Baseband A	1.00	0.00	0.000
BB Input A	0.00	0.00	0.000

- In the "Constellation Diagram", select "Configure".
The "Graphics Configuration" dialog opens.
- Add a vector diagram with signal acquisition point "Stream" and enlarge it.
The vector diagram rotates with 1 Hz.

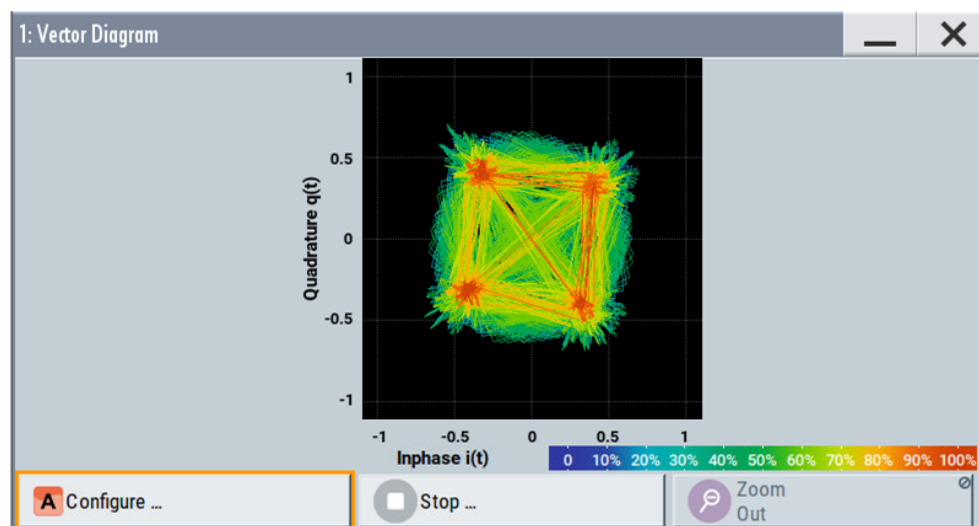

Figure 10-12: Rotating vector diagram

- Reset the baseband frequency offset to 0 Hz.
The vector diagram does not rotate any more.

To visualize the effect of the filter parameters on the generated signal

- Select "Baseband > Custom Digital Mod... > Filter > Roll Off Factor = 0.99"

Displaying baseband signal characteristics in real-time

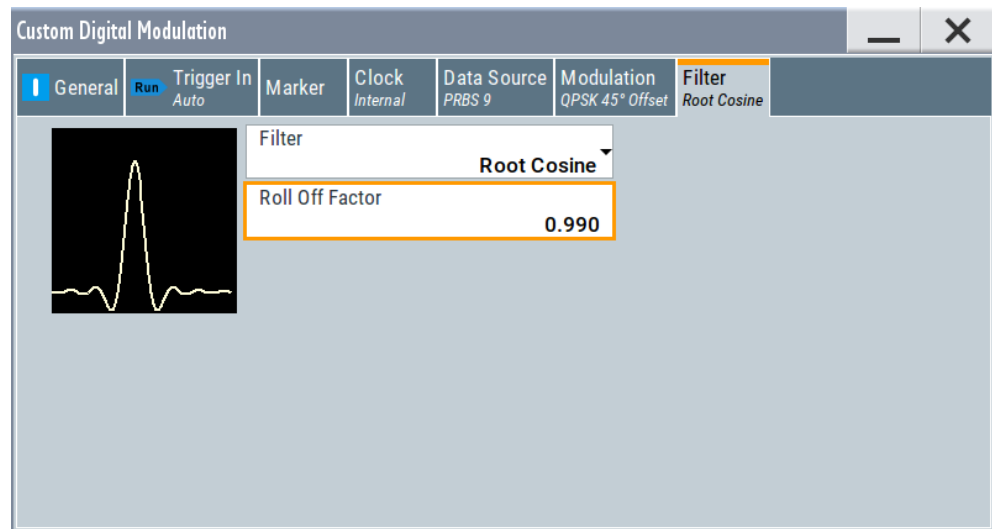

The vector diagram changes.

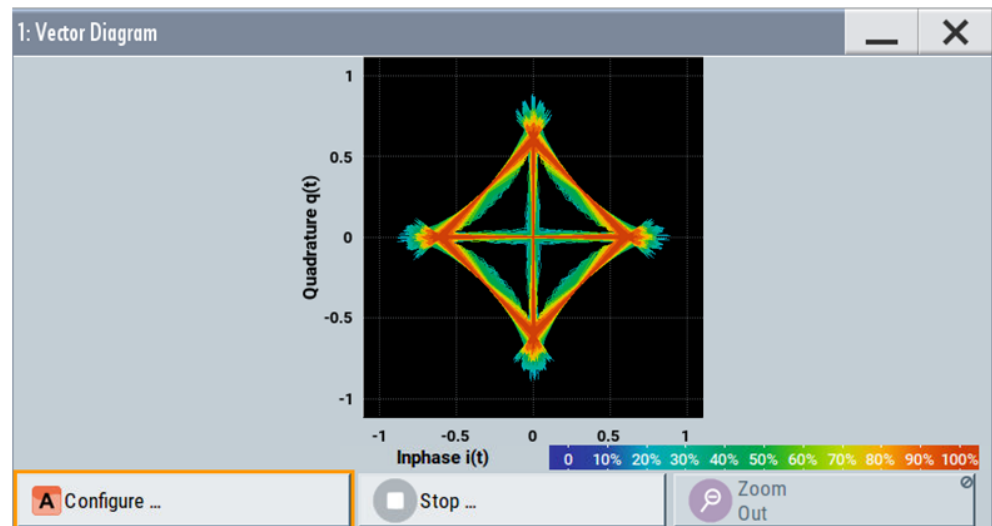

2. Select "Roll Off Factor", open the context menu, and select "Preset this parameter".

To zoom into a diagram

In an enlarged diagram:

1. Use the one-finger zoom to zoom with a fixed zoom factor.
2. Use the two-finger zoom to do a custom zoom.
This zoom works like the two-finger pinching for magnifying images on your cell phone.

If the diagram is zoomed, an overview window appears.

3. Move the visible area in the graphics or in the overview window.
4. For the reverse operation, select "Zoom out".

To enable markers to readout exact measured data

In an enlarged diagram:

1. Select "Show Marker".
Two markers appear, one over the other.
2. To position the markers, select and shift them.
"M2-M1" indicates the distance of marker 1 and marker 2 on the x-axis (left value) and on the y-axis (right value).
3. To hide the markers, select "Hide Marker".

To observe the effect of enabled additive noise (AWGN)

1. Select "AWGN > General > Mode > Additive Noise".
2. Select "AWGN > General > Min Noise/System Bandwidth Ratio = 3".
3. Select "Noise Power / Output Results > Carrier/Noise Ratio = 30 dB".

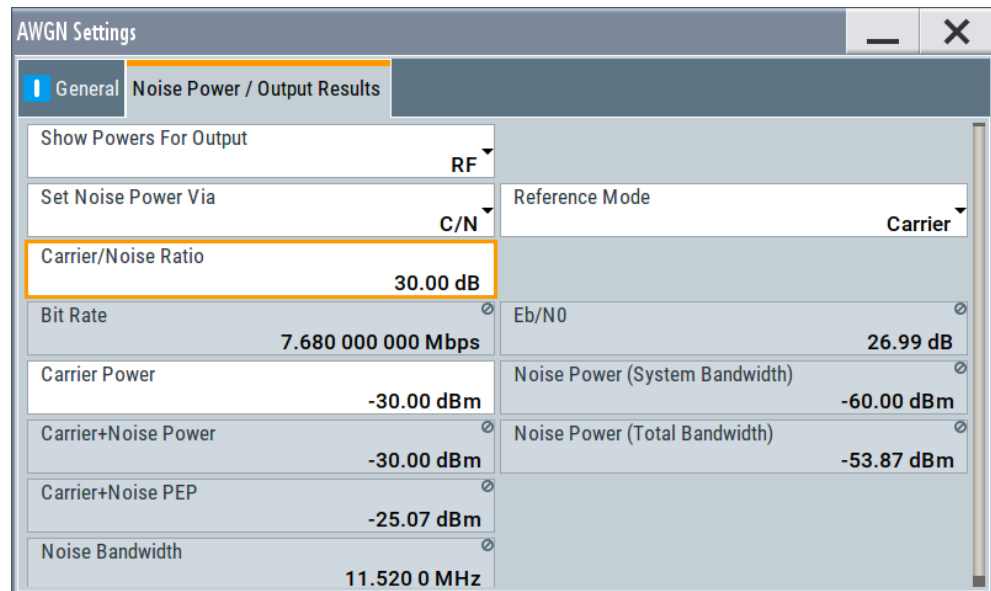

4. Select "AWGN > State > On"
5. Observe the power spectrum display.

The power spectrum shows a noise floor with constant level and the spectrum of the digitally modulated signal, in this case the WCDMA signal with a bandwidth of 3.84 MHz.

Displaying baseband signal characteristics in real-time

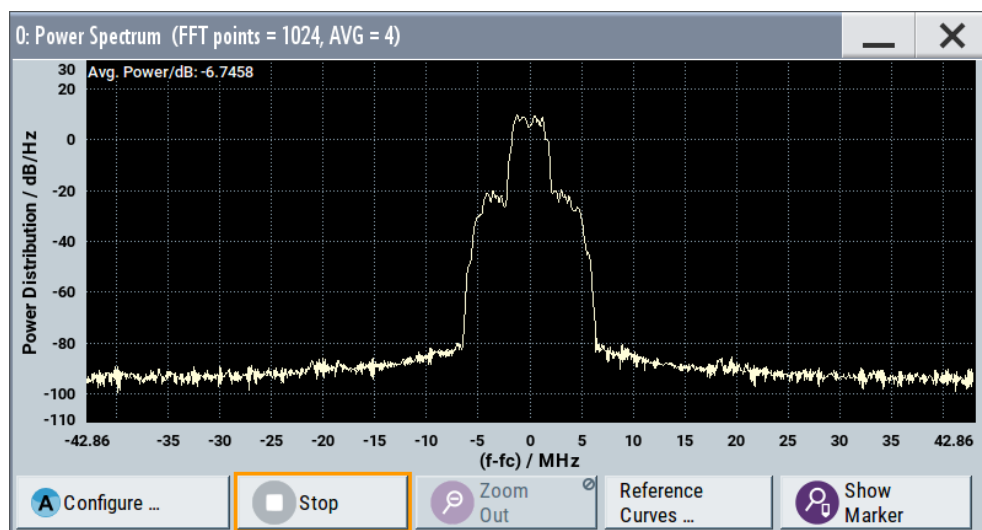

To print current power spectrum

1. Select "System Config > Setup > User Interface > Hardcopy".
2. Use the default settings and select "Save".

The instrument creates a screenshot of the current screen and stores it in a file with a predefined filename in the default user directory `/var/user/`.

See [Chapter 11.10, "Creating screenshots of current settings"](#), on page 440.

3. Use one of the standard file transfer methods to access the user directory of the instrument. Transfer the file to a PC.
See [Chapter 11.9, "How to transfer files from and to the instrument"](#), on page 434.
4. Print the file content.

11 File and data management

The R&S SMCV100B uses files to save all instrument data. The instrument allows you to save and to load instrument settings, and to import and to export user data for processing in another instrument or later. Finally, you can create a screenshot of the current settings displayed on the screen and save it as a file.

This section focuses on the functions provided for managing of user data files and covers the topics listed below.

For information on the related remote control commands, refer to [Chapter 14.5, "Memory subsystem"](#), on page 581.

For information on how to save the displayed setting in a file, refer to [Chapter 11.10, "Creating screenshots of current settings"](#), on page 440.

- [About the file system](#).....413
- [Restoring the \(default\) instrument configuration](#)..... 416
- [Protecting data](#).....420
- [Saving and recalling instrument settings](#).....421
- [Accessing files with user data](#).....426
- [Exporting and importing remote command lists](#).....428
- [Loading, importing and exporting lists](#).....428
- [Using the file manager](#).....428
- [How to transfer files from and to the instrument](#)..... 434
- [Creating screenshots of current settings](#).....440

11.1 About the file system

Depending on the contained information, two file groups can be distinguished: system and user files.



Due to security reasons, system files and the system directory are protected and therefore not accessible.

The scope of this section is only the files with user data.

This section is an overview of the R&S SMCV100B file system and covers the following topics:

- ["Types of user data"](#) on page 414
- ["File storage location"](#) on page 414
- ["File handling"](#) on page 415
- ["File naming conventions"](#) on page 415
- ["File contents"](#) on page 415

Types of user data

The **user data** includes saved instrument settings, data for the different digital standards, lists for the list mode and the user correction, and the waveforms for the arbitrary waveform generator.

You can also save the settings in the form of command sequences, e.g. in SCPI or other languages.

Depending on the **content**, the **user data** can be roughly divided into the following data types:

- *Settings*, e.g. the current instrument settings, can be saved and loaded later or used in other instrument of the same kind.
See [Chapter 11.4, "Saving and recalling instrument settings"](#), on page 421
- *SCPI scripts*, a series of commands that can be run to perform a task.
See [Chapter 11.6, "Exporting and importing remote command lists"](#), on page 428
- Externally or internally generated *lists*, e.g. user correction lists, or data lists can be loaded in the instrument.
See [Chapter 11.7, "Loading, importing and exporting lists"](#), on page 428 and [Chapter 11.5, "Accessing files with user data"](#), on page 426
- Externally generated *waveforms* can be loaded in the "Arbitrary Waveform Generation" dialog.
See [Chapter 4.6, "Using the arbitrary waveform generator \(ARB\)"](#), on page 137

Depending on the **data storage method**, user data can be:

- *Persistent*, i.e. user files that are recorded on the data storage.
Data is preserved when instrument is powered off and can be accessed and modified subsequently.
- *Temporary*, i.e. volatile data that the instrument retains while it is powered on.
Volatile data is immediately lost when the R&S SMCV100B is switched off.

File storage location

Both, the user directory `/var/user/` on the internal memory or the `/usb/` directory on the memory stick, can be used to **preserve** user-defined data. Any directory structure can be created.

The `/var/volatile` directory serves as a RAM drive and can be used to protect sensitive information. The data is available **temporarily**.

Default storage location

The R&S SMCV100B stores user data in the user directory.

In the file system, user directory is always indicated as `/var/user/`.

In manual control, you access this directory via the "File Manager", see [Chapter 11.8, "Using the file manager"](#), on page 428. In remote control, you can query it with the command `:SYSTem:MMEMory:PATH:USER?`.

To query and change the default directory used for mass storage, use the command `:MMEMory:CDIRectory`.

File handling

To *access files* and the file system of the instrument or to use the general file management functions such as copying and moving data, use the standard "File Manager" dialog.

See [Chapter 11.8, "Using the file manager"](#), on page 428.

To *transfer files* from and to the instruments or to exchange files, use one of the following alternatives:

- Connect a memory stick to one of the USB interfaces.
The instrument recognizes automatically a connected memory stick and assigns the `/usb/` drive to it.
- Connect the instrument to a LAN.
An instrument connected to a LAN supports two standard file transfer methods from a remote client:
 - FTP (file transfer protocol)
 - File sharing according to the SAMBA/SMB (server message block) protocol.Both file transfer methods access the folder `/user`, that is the `/var/user/` folder on the instrument.
For step-by-step description, see [Chapter 11.9, "How to transfer files from and to the instrument"](#), on page 434.
- Map a network folder or a computer to an instrument connected to a LAN.
A mapped network folder is indicated as `/shares/<"Local Folder">`.
For step-by-step description, see [Chapter 11.8.4, "How to map a network folder"](#), on page 432.

File naming conventions

To enable files to be used in different file systems, consider the following file naming conventions:

- The *filename* can be of any length and *is case-sensitive*, i.e it is distinguished between uppercase and lowercase letters.
- All letters and numbers are permitted (numbers are, however, not permitted at the beginning of the filename).
- Avoid using special characters.
- Do not use slashes "\" and "/". These symbols are used in file paths.
- Avoid using the following filenames: `CLOCK$, CON, COM1 to COM4, LPT1 to LPT3, NUL or PRN`
They are reserved by the operating system.

File contents



Network settings and remote settings cannot be saved and restored.

11.2 Restoring the (default) instrument configuration

The R&S SMCV100B has various options to set default settings. You can preset the R&S SMCV100B to an initial state at any time as a known starting point for configurations. It is often useful as a first step in troubleshooting when unusual results arise.

The graph on [Figure 11-1](#) shows the impact of the particular reset functions.

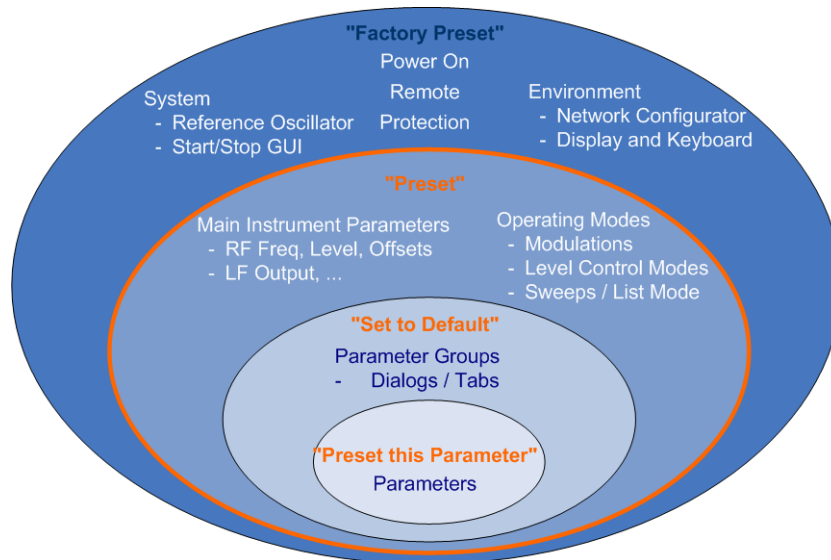

Figure 11-1: Parameter and operating modes, reset by the respective preset functions

Overview of the characteristics of the preset functions

Select the preset option that most fits to your particular application:



- [Preset]
It is the most frequently used function.
A **Preset** executes a defined instrument setup to provide an initial instrument state as a basis for a new configuration. It resets all parameters and switching states, including also the states of inactive operating modes.
Network, remote access or system settings are retained.

- ▶ To execute a preset, press the [Preset] key at the front panel.



- "Set to Default"
Set To Default relates to individual dialogs or tabs and resets the associated settings of the corresponding dialog. All other settings are retained.
- ▶ To reset the grouped settings, click "Set To Default".

Preset This Parameter

- "Preset this parameter"
Sets a single parameter to its default value.
- ▶ To reset an individual parameter: Open its context-sensitive menu and select "Preset this parameter..."

Execute Factory Preset

- "Factory Preset"
A factory preset is the most profound preset function that resets almost all instrument settings, including reference oscillator, network and remote access settings. Retained are the following settings:
 - Security, password, and settings protected by these passwords
 - User-defined data, like setups or data lists
 - Settings that relate to an integration of the instrument in a measurement setup.
- ▶ To restore the factory defaults, select [System Config > Setup > Settings > Factory Preset](#).

Note: Perform a "Factory Preset" only if it is necessary. After a "Factory Preset", the network connection to the instrument no longer exists.

Presetting the instrument to a user-defined instrument state

The reset functions set the parameters and operating modes to default values predefined by the factory. Alternatively to these default settings, you can:

- Define user-specific recall settings to be restored after a preset (see [Chapter 11.2.3, "How to recall user settings automatically after preset"](#), on page 419)
- Store and reload user-defined instrument states (see [Chapter 11.4.2, "How to save and recall instrument settings"](#), on page 425)

Mark / Do not mark parameters changed from preset

To survey the current state of the settings concerning default values, the R&S SMCV100B offers a feature that visually identifies deviations from the default values.

For more information, see [Chapter 11.2.2, "How to identify parameters which are not in a preset state"](#), on page 418.

11.2.1 Preset, set to default and factory preset settings

Preset.....	418
Set To Default.....	418
Preset this Parameter.....	418
Execute Factory Preset.....	418

Preset

Resets all parameters and switching states, and closes all opened dialogs.

Note:

In contrast to the [Preset] key, the SCPI commands `*RST` and `:SYSTem:PRESet` do not close open dialogs in the GUI.

Consider also the following possibilities:

- You can define the settings that are restored when you preset the instrument (see [Chapter 11.2.3, "How to recall user settings automatically after preset"](#), on page 419)
- You can reset the instrument to the factory state (see ["Execute Factory Preset"](#) on page 418)

See also [Table 11-1](#) that contains the key parameters that are reset by the corresponding preset functions.

Remote command:

`*RST` on page 578

Set To Default

Resets the associated settings of the corresponding dialog or tab.

Preset this Parameter

Restores the default value of a single parameter.

Execute Factory Preset

Resets the instrument to its factory settings.

Note: "Factory Preset" retains all security settings and does not delete any user files like setups or user data.

See also [Table 11-1](#) that contains the key parameters that are reset by the corresponding preset functions.

Remote command:

`:SYSTem:FPReset` on page 581

11.2.2 How to identify parameters which are not in a preset state

To recognize the current state of the settings related to their default values at the first glance, enable a function that visually identifies parameters in states different than preset.

To activate this display:

1. Open the context-sensitive menu (touch and hold the screen anywhere in the GUI of the R&S SMCV100B).
2. Select "Mark all parameters changed from preset".

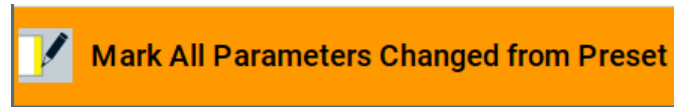

If enabled, the corresponding settings are marked.

Example:

Frequency	4.000 000 000 000 GHz	
Offset	10.000 000 kHz	Multiplier 1.000
User Variation		
Variation Active	<input checked="" type="checkbox"/>	Variation Step 1.000 000 000 MHz

Figure 11-2: Labeled parameters show that the value deviates from its default

Frequency	= changed (default = 1 GHz)
Offset	= changed (default = 0 kHz)
Multiplier	= unchanged
Variation active	= changed (default = disabled)
Variation step	= unchanged

11.2.3 How to recall user settings automatically after preset

You can define the settings that are restored when you preset the instrument.

1. Configure the settings as required. Save them as described in [Chapter 11.4.2, "How to save and recall instrument settings"](#), on page 425.
2. Save the settings as a file with the predefined filename `UserPreset.savrc1txt`. Save this file in the directory `/var/user/`.

The filename `UserPreset.savrc1txt` and the directory `/var/user/` are mandatory.

Now when you press the [Preset] key or send the `*RST` command to the instrument, the defined settings are restored.

An "Info" message appears and confirms, that a file with user-defined preset setting is loaded.

11.2.4 Reference

See [Table 11-1](#) for an overview of the main generator settings that are affected by the corresponding preset functions. While the regular [Preset] key primarily resets the signal relevant parameters of the instrument, the "Factory Preset" affects almost all instrument settings.

For information on the default values of further parameters, refer to the description of the corresponding remote commands.

Table 11-1: Key parameters affected by preset and factory preset

Parameter	Preset value	Preset	Factory Preset
RF frequency	1 GHz	x	x
RF level (RF output)	off	x	x
RF OFF mode	-	-	x
Offsets	0	x	x
Modulation state	off	x	x
Reference frequency settings (reference oscillator)	-	-	x
Network settings	-	-	x
Hostname	-	-	x
Start/Stop display update	-	-	x
Display and keyboard settings	-	-	x
Password and settings protected by passwords (e.g. disabled LAN or USB)	-	-	-
Security settings	-	-	-
User files (setups ²⁾ , data lists, etc.)	-	-	-

- ²⁾ `UserPreset.savrcltxt` is renamed as `UserPresetInactive.savrcltxt`; an existing file with the same name is overwritten.



If the default values in the "Remote Access" dialog had been changed, a factory preset via remote control (`:SYSTem:FPReset`) terminates the connection to the instrument. Security settings are never reset.

Resets all parameters and switching states, and closes all opened dialogs.

11.3 Protecting data

During operation, the R&S SMCV100B saves user data permanently in the user directory, see ["File storage location"](#) on page 414.

To protect any classified data and to avoid saving any sensitive data on the R&S SMCV100B permanently, you have the following options:

- Activate the **volatile mode**. This mode redirects user data to the volatile memory, see "[Volatile Mode](#)" on page 485.
The internal memory is write-protected.
Once you power off the instrument for at least five minutes, all volatile memory modules lose their contents.
Instead, you can redirect the user data to an **external memory device**, as, e.g., a USB stick.
See also:
 - "[Default storage location](#)" on page 414
 - "[Volatile Mode](#)" on page 485
 - [Chapter 11.9.4, "Using a USB storage device for file transfer"](#), on page 439
- Save user files **temporarily in the `/var/volatile` directory**, which remains available only until the instrument is turned off.
You can access data in the volatile memory just as data that is saved permanently in the `/var/user/`.
See also [Chapter 11.8.3, "How to display all saved files"](#), on page 432.



For detailed information on how to protect the instrument and sensitive data from unauthorized access, see the Instrument Security Document on the product website.

11.4 Saving and recalling instrument settings

Possibly you would like to restore or repeat a signal generation you performed under specific conditions on the instrument. Or, in a test setup with more than one signal generator, you want to transfer the used settings to another R&S SMCV100B. Some test setups also require similar settings in all instrument paths. In these cases, you can save and recall instrument and user settings, and possibly other related data.

In each of these cases, you can create a file with the complete instrument settings or you can choose to save only the settings belonging to a particular digital standard. The instrument uses a similar save/recall principle; both ways are scope of this section.

Save/Recall the complete instrument settings

Two different methods are available for managing *complete instrument settings*:

- Immediate (quick) Save/Recall
A defined set of instrument settings are saved or recalled quickly in just one step, without defining a filename or storage location. This function enables a fast switching between different instrument settings.
- Save/Recall in files with user-defined names
The defined set of instrument settings are saved to a definable storage location. The file extension is `*.savrc1txt`.
Settings files created in this way are visible in the file system and accessible with the supported methods for file handling.

In the general case, a recall process replaces the instruments settings with the saved values. An exception is the frequency and level settings. During recall of the instrument settings, it is possible to retain the current settings or to overwrite them with the saved values.

Save/Recall the settings belonging to a firmware option

Each of the firmware option provides a special "Save/Recall" function to manage directly the settings associated to the corresponding digital standard, e.g. all settings in the "T-DMB/DAB" dialog.

The "Save/Recall" function creates files with user-defined names, predefined file extension and on a definable storage location. The files are accessible with the supported methods for file handling.

11.4.1 Save/recall settings

To access the dialog for saving and loading the complete instrument settings

1. Press the [Save/Rcl] key.
2. Select "Operation Mode > Save or Recall" to access the corresponding settings.

The provided settings for both operations are similar and closely related.

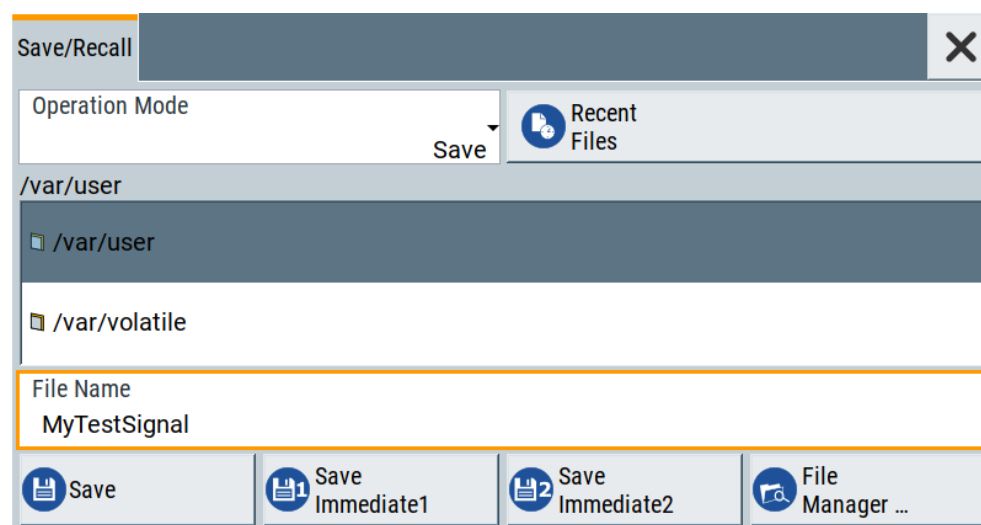

Settings:

Operation Mode.....	423
Directory, File List and Filename.....	423
Recent files.....	423
Show SCPI List.....	423
SCPI List.....	423
Save.....	423
Save Immediate x.....	424
Exclude Frequency.....	424

Exclude Level.....	424
Recall.....	424
Recall Immediate x.....	424
File Manager.....	424

Operation Mode

Accesses the settings for storing ("Save") and loading ("Recall") of the instrument settings. Also, you can import SCPI-Files ("SCPI-Import") or export SCPI files ("SCPI-Export").

See [Chapter 11.6, "Exporting and importing remote command lists"](#), on page 428.

Directory, File List and Filename

Note:

You access this generic standard function each time you perform one of the following:

- Save or load (settings) files
- Define a folder in that these files are saved
- Navigate through the file system.

The dialog name changes depending on the context. The provided functions are self-explanatory and similar.

Use the settings for example as follows:

- To navigate through the file system, use the directory tree.
- To perform standard file management functions, like create directories, move, copy, delete files and/or directories, use the standard "File Manager" function (see [Chapter 11.8, "Using the file manager"](#), on page 428).

Remote command:

To list all files in a directory:

:MMEMory:CDIRectory on page 587

:MMEMory:CATalog? on page 586

Recent files

Displays the files last used.

Show SCPI List

Opens the "SCPI List", which lists the current settings of the R&S SMCV100B as SCPI commands.

The R&S SMCV100B provides this function for [Operation Mode > SCPI-Export](#).

SCPI List

Contains a list of all SCPI commands corresponding to the current instrument settings.

See also ["How to create a SCPI list with the current instrument settings in one step"](#) on page 562

Save

Saves the current instrument settings or the settings belonging to a digital standard under the defined filename.

Remote command:

[:MMEMory:STORe:STATe](#) on page 591

Refer to the descriptions of the firmware options for the correct syntax of the corresponding SCPI commands:

[\[:SOURce<hw>\]:BB:<Digital Standard>:SETTing:STORe](#)

[\[:SOURce<hw>\]:BB:<Digital Standard>:SETTing:DELeTe](#)

Save Immediate x

Stores the current instrument setting in one of the intermediate memories.

These instrument settings are retained until a different instrument setting is stored in the intermediate memory. When the instrument is switched off, the contents of the intermediate memories are retained.

Remote command:

[*SAV](#) on page 578

Exclude Frequency

The current frequency is retained when a stored instrument setting is loaded.

Remote command:

[\[:SOURce<hw>\]:FREQuency\[:CW|FIXed\]:RCL](#) on page 761

Exclude Level

The current level is retained when a stored instrument setting is loaded.

Remote command:

[\[:SOURce<hw>\]:POWer\[:LEVel\]\[:IMMediate\]:RCL](#) on page 794

Recall

Restores the selected configuration.

During recall, the instrument considers all related settings, for example sweeps in active state or lists. An error message indicates the settings which cannot be implemented.

Remote command:

[:MMEMory:LOAD:STATe](#) on page 589

Recall Immediate x

Loads the selected configuration from one of the intermediate memories. A message appears if no instrument configuration is stored in this memory.

Remote command:

[*RCL](#) on page 578

File Manager

Accesses the "File Manager" dialog, see [Chapter 11.8, "Using the file manager"](#), on page 428.

11.4.2 How to save and recall instrument settings

Instrument settings can be saved to a file and loaded again later, so that you can repeat the tests with the same settings.

To access and recall instrument setups quickly

- ▶ Assign the appropriate action to the [★ (User)] key.
See [Chapter 12.4.4, "How to assign actions to the \[★ \(User\)\] key"](#), on page 465.

To save and recall instrument settings

1. Select Save/Rcl > "Operation Mode > Save".
2. Select "Save Immediate 1".
The instrument saves its settings in the intermediate memory 1. The filename and the storage location cannot be changed.
3. Adapt the instrument settings as required. Select "Save Immediate 2"
4. To restore the settings, select the "Operation Mode > Recall"
5. Select "Recall Immediate 1"
The instrument is restored to the previous state.
6. Select "Recall Immediate 2" to switch to the settings saved in the second file.

To save complete instrument settings

1. Select Save/Rcl > "Operation Mode > Save".
2. In the file selection dialog, select a filename and storage location for the settings file.
3. Select "Save".
A file with the defined name and path and the extension *.savrc1.txt is created.

To restore instrument's configuration

Save the configuration as described in ["To save complete instrument settings"](#) on page 425.

1. To restore settings, select Save/Rcl > "Operation Mode > Recall".
2. To retain the current frequency and level settings, enable "Save/Recall > Exclude Frequency/Level"
3. In the file selection dialog, select the filename and storage location of the settings file.

The settings are restored, but the frequency and level settings are retained; you can repeat the signal generation with the same settings.

See also [Chapter 11.2.3, "How to recall user settings automatically after preset"](#), on page 419.

11.5 Accessing files with user data

Signal generation in list mode, the generation of pulse train signals or applying user correction values use data from list files. Whenever a list file is required as a data source, the instrument provides direct access to the standard "File Select" function. This function enables you to select, create and edit the list files.

11.5.1 File select settings

The "File Select" dialog opens automatically each time you select a data list file as data source or you select a control list.

To access a loadable data list file

1. Select "RF" > "Sweep/List" > "List Mode Data" > "List Mode" = "Data".

A file select dialog for loading, creating and modifying a file opens.

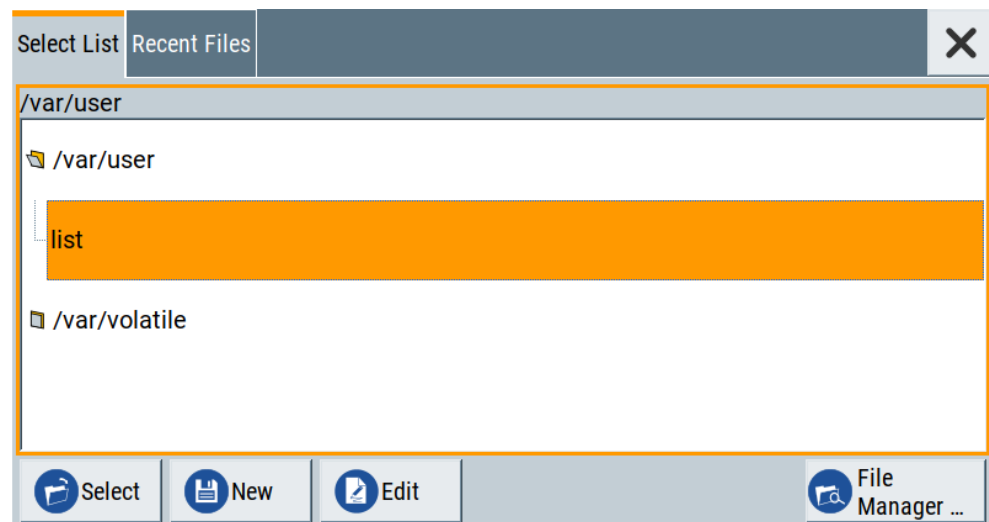

Tip: The name of the dialog is context-sensitive and differs depending on the particular function this dialog is from. However, the provided functions are similar.

2. To load an existing file:
 - Navigate through the file system.
 - Select the file and confirm with "Select".
3. To create a file, for example if there is no data list file specified:
 - Navigate through the file system.
 - Select "New" and specify the filename.
 - A new empty file is created and saved in the selected folder.
4. To edit an existing or newly created file:
 - Navigate through the file system.
 - Select the file and select "Edit".
 - The standard "Data List Editor" dialog opens

5. Edit the file content.
Confirm with "Save".

Settings:

Directory, File List and Filename.....	427
Functions for handling of data lists.....	427
Recent files.....	427
File Manager.....	427

Directory, File List and Filename**Note:**

You access this generic standard function each time you perform one of the following:

- Save or load (settings) files
- Define a folder in that these files are saved
- Navigate through the file system.

The dialog name changes depending on the context. The provided functions are self-explanatory and similar.

Use the settings for example as follows:

- To navigate through the file system, use the directory tree.
- To perform standard file management functions, like create directories, move, copy, delete files and/or directories, use the standard "File Manager" function (see [Chapter 11.8, "Using the file manager"](#), on page 428).

Remote command:

To list all files in a directory:

`:MMEMory:CDIRectory` on page 587

`:MMEMory:CATalog?` on page 586

Functions for handling of data lists

Provided are the following standard functions for file handling:

"Select"	Select and load the file. Remote command: <code>[:SOURce<hw>] :BB:DM:DLISt:SElect</code> on page 682
"New"	Creates file with the specified "Filename". To confirm, select "OK"; use "Cancel" to undo the operation. To edit the file content, select "File Select > Edit".
"Edit"	Accesses the "Data List Editor" and loads the selected file for editing

Recent files

Displays the files last used.

File Manager

Accesses the "File Manager" dialog, see [Chapter 11.8, "Using the file manager"](#), on page 428.

11.6 Exporting and importing remote command lists

To set specific instrument settings or perform tasks automatically, you can create scripts or import scripts that contain the settings in the form of remote control command sequences.

The R&S SMCV100B also offers a SCPI macro recorder with code generator that is used to record manual settings and create an executable script, see [Chapter 13.11.4, "How to record / create SCPI lists"](#), on page 560.

Completed scripts are saved in files and possibly converted to different formats, depending on the used language of the source code.

The R&S SMCV100B supports the following commonly used languages:

- Plain SCPI: *.txt
- MATLAB: *.m
- NICVI: *.c
- Python: *.py

It is also possible to convert the SCPI command list to a user-specific language, see [Chapter 13.11.5, "How to convert and save SCPI lists"](#), on page 563.

11.7 Loading, importing and exporting lists

The R&S SMCV100B provides built-in editors for creating list files, for example for the list mode or lists with user correction data. You can also create or evaluate them with an external application. The instrument provides interfaces with the following functionality:

- Import and export list files in a standard ASCII format file
- Load of internally or externally generated waveform file

Lists are saved and loaded in the corresponding dialogs. For example, the user correction data list is created and saved in the "User Correction" dialog.

11.8 Using the file manager

The "File Manager" is a tool similar to a standard Windows Explorer. It helps you manage mass storage media and files saved on the R&S SMCV100B.

You can perform the following tasks:

- Copying multiple files from disk to other media
See [Chapter 11.9, "How to transfer files from and to the instrument"](#), on page 434
- Copying files into another directory
See [Cut, Copy&Paste and Delete](#)
- Renaming and deleting files
- Creating directories

See [Create New Directory](#)

- Mapping shared network folders
See [Chapter 11.8.4, "How to map a network folder"](#), on page 432
- Displaying saved files
See [Chapter 11.8.3, "How to display all saved files"](#), on page 432

Access:

- ▶ Select Save/Rcl > "File Manager".

Tip: Each "Save/Recall" dialog and each "File Select" dialog provides a quick access to the "File Manger", i.e. whenever you select data lists or files with user data.

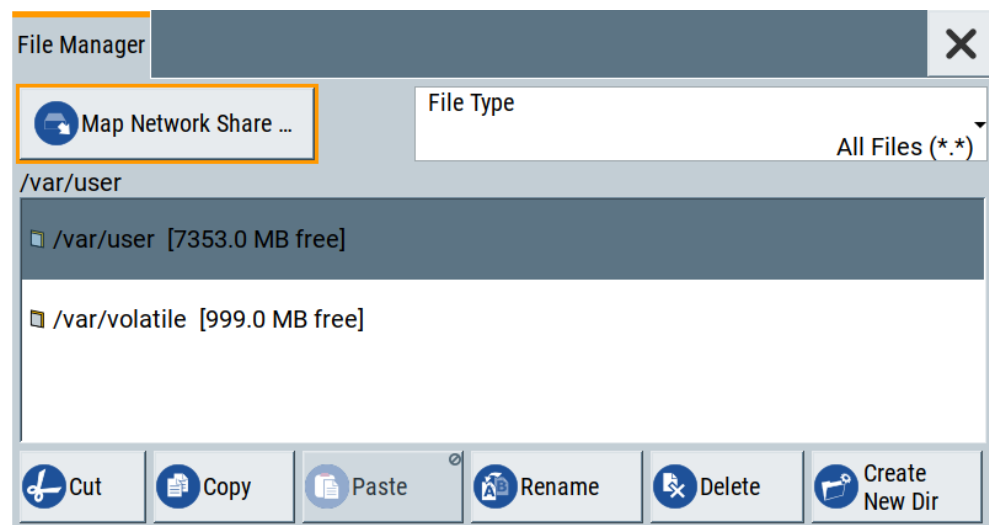

The "File Manager" dialog provides all standard functions required for file management. It displays the contents of the selected folder on the R&S SMCV100B and provides functions to rename, delete, copy, or move individual files.

11.8.1 File manager settings

Access:

- ▶ Select Save/Rcl > "File Manager".

Settings:

Map Network Share	430
File Type	430
Directory and Filename	430
Cut, Copy&Paste and Delete	430
Rename	430
Create New Directory	430

Map Network Share

Accesses the [Map network share settings](#) dialog where you can map one or more network folders.

See also [Chapter 11.8.4, "How to map a network folder"](#), on page 432.

File Type

Selects the file type to be listed. If a file type with a specific file extension is selected, only files with this extension are listed.

Directory and Filename

Selects the directory in which the file to be deleted or copied is located. The dialog lists all files in this directory. Selected files are highlighted. The path is indicated above the directory tree.

Unlike the "Save/Recall" and "File Select" dialogs, the "File Manager" displays the full filenames including extensions.

Remote command:

[:MMEMory:CDIRectory](#) on page 587

Cut, Copy&Paste and Delete

Standard file management functions.

Before a file is deleted, you have to confirm the delete operation.

Remote command:

[:MMEMory:DELeTe](#) on page 589

[:MMEMory:COpy](#) on page 587

Rename

Renames the selected file or directory.

Remote command:

[:MMEMory:MOVE](#) on page 590

Create New Directory

Creates a folder and opens an edit dialog box to enter name and path (absolute or relative to the current directory) of the new folder.

Remote command:

[:MMEMory:MDIRectory](#) on page 590

11.8.2 Map network share settings

Access:

- ▶ Select Save/Rcl > "File Manager > Map Network Share".

The "Map Network Share" dialog provides settings that are similar to the standard Windows Explorer function "Map network drive". These settings help you to create up to 10 "shortcuts" to shared folders or computers in the network.

The dialog displays a list of current mapped network folders. The directory tree of the "File Manager", "Save/Recall", and "File Select" dialogs indicate a mapped network folder as /shares/<"Local Folder">.

Network Folder	Local Folder	User Name	Reconnect at Startup
//10.124.0.166/user	setups	instrument	Off

Network Folder	Local Folder
//10.124.0.166/user	setups
User Name	Password
instrument	*****
Reconnect at Startup	<input type="checkbox"/>

See also [Chapter 11.8.4, "How to map a network folder"](#), on page 432.

Settings:

Network Folder	431
Local Folder	431
User Name	431
Password	431
Reconnect at Startup	432
Connect	432
Change	432
Disconnect	432

Network Folder

Enter the path of the folder or computer, e.g. //<IP Address>/user or //<server name>/user.

Local Folder

Enter a letter or an alias name to describe the folder.

In the directory tree, a mapped network folder is indicated as /shares/<"Local Folder">.

User Name

Enter a user name of a user that has the permission to access the selected network folder.

Password

Enter the password of the selected user.

Reconnect at Startup

Enables reconnecting every time you start up the instrument.

Connect

Triggers the instrument to prove the credential and to map (i.e. connect) the selected network folder or computer to the instrument.

You can map up to 10 network folders.

Change

Applies the changes.

Disconnect

Disconnects the network drive.

11.8.3 How to display all saved files

To display all files on the internal memory

1. Select Save/Rcl > "File Manager".
2. Navigate to `/var/user/`.

To display all files on a connected USB flash drive

1. Select Save/Rcl > "File Manager".
2. Navigate to `/usb/`.

To display all files in the volatile memory

1. Select Save/Rcl > "File Manager".
2. Navigate to `/var/volatile/`.

11.8.4 How to map a network folder

Possibly you would like to transfer instrument or user settings to another R&S SMCV100B, distribute waveform files to several instruments or you have to access frequently the same network drive. In these cases, on a R&S SMCV100B connected to a LAN you can create a shortcut to this network folder or this computer.

How to: see [Chapter 3.1.7, "Connecting to LAN"](#), on page 27.

To map a network folder, proceed as follows:

1. On the computer or the network folder you want to map, enable remote access. You can specify a list of users allowed for remote access.

The remote access settings depend on the operating system the remote computer is using. For step-by-step instructions, refer to the documentation of the particular operating system.

2. On the R&S SMCV100B, [enable file transfer via SMB \(samba\)](#).
3. Select "System Config > Setup > Remote Access > Network".
Select:
 - a) "Address Mode > Auto (DHCP)"
 - b) Check that the "DNS Suffix" and "DNS Server" are correct.
4. In the "Save/Recall" dialog, select "File Manager > Map Network Share".
5. In the "Map Network Share" dialog, select:
 - a) In the "Network Folder" field, enter `//<IP Address>/user` or `//<Server Name>/user`.
 - b) In the "Local Folder" field, enter an alias name, e.g. *setups*.
 - c) Enter the "User Name" and "Password" of a user with a remote access permission to the selected network folder.
 - d) If necessary, enable "Reconnect at Startup".
 - e) Select "Connect".

The selected network folder is mapped to your instrument. The list of mapped network folders is updated.

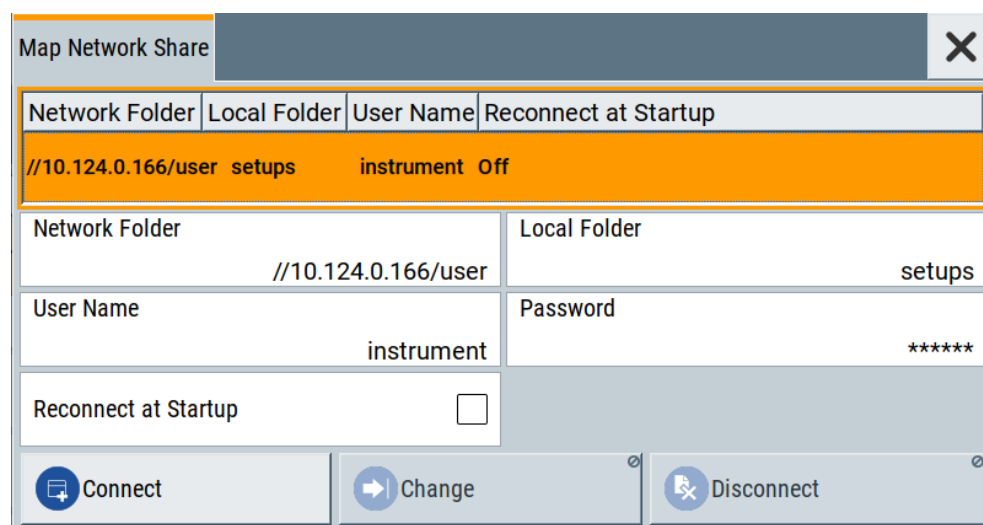

Network Folder	Local Folder	User Name	Reconnect at Startup
//10.124.0.166/user	setups	instrument	Off

Network Folder: //10.124.0.166/user

Local Folder: setups

User Name: instrument

Password: *****

Reconnect at Startup:

Buttons: Connect, Change, Disconnect

6. Close the "Map Network Share" dialog.

The navigation tree in the "File Manager" dialog displays the mapped network folder as `/shares/Setups`.

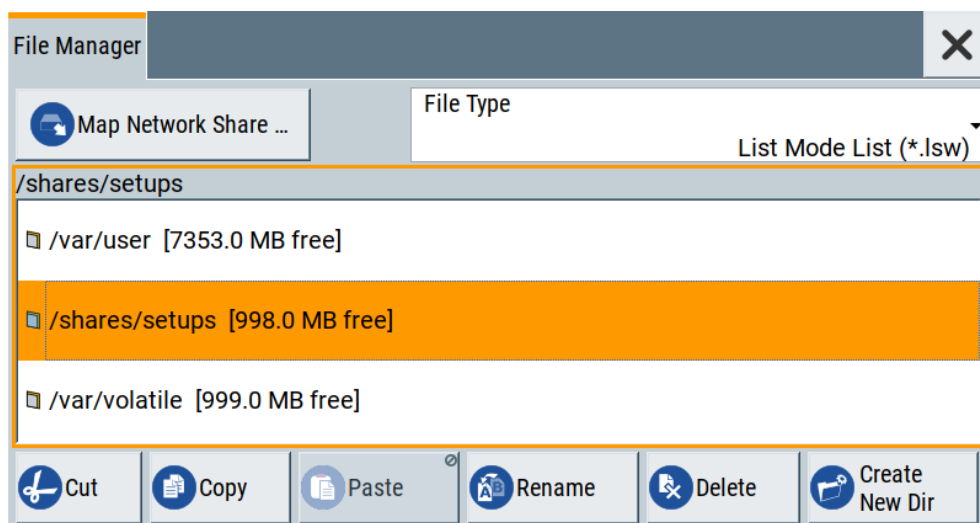

If the connection does not succeed, consider to check the following:

- Is the network folder or computer you try to map turned on?
- Is the network folder or computer enabled for remote access?
- Does the selected user name have the necessary permissions?

See also [Chapter 11.9.5, "Using a file server for test files exchange"](#), on page 439.

11.9 How to transfer files from and to the instrument

As explained in ["File handling"](#) on page 415, you access the file system of the R&S SMCV100B via one of the following ways:

- Via the built-in "File Manager"
See [Chapter 11.8, "Using the file manager"](#), on page 428.
- On an instrument connected to a LAN:
 - Via one of the standard functions FTP or SMB (samba)
See [Chapter 11.9.2, "Accessing the file system of the R&S SMCV100B over FTP"](#), on page 436 and
[Chapter 11.9.3, "Accessing the R&S SMCV100B file system using SMB \(Samba\)"](#), on page 437
 - Via mapped network drives
See [Chapter 11.8.4, "How to map a network folder"](#), on page 432.
- Via a connected USB storage device
See [Chapter 11.9.4, "Using a USB storage device for file transfer"](#), on page 439

Mainly because of security reasons, the access to the file system of your R&S SMCV100B can be denied, because one or all these access methods are deliberately disabled. Access to the file system via LAN and/or USB requires that the corresponding service is enabled and a write access to the file system is enabled. Refer to

[Chapter 11.9.1, "Removing file system protection"](#), on page 435 for description of the required steps.

This section provides an introduction to the topic. For comprehensive information, refer to the application note [1GP72: Connectivity of Rohde&Schwarz Signal Generators](#).

- [Removing file system protection](#)..... 435
- [Accessing the file system of the R&S SMCV100B over FTP](#).....436
- [Accessing the R&S SMCV100B file system using SMB \(Samba\)](#)..... 437
- [Using a USB storage device for file transfer](#)..... 439
- [Using a file server for test files exchange](#)..... 439

11.9.1 Removing file system protection

Before you try to access the file system via FTP, SMB (samba) or USB, fulfill the following:

- Disable write protection on the file system
- Enable the corresponding service or interface

To enable write permission on the file system

1. Select "System Config > Setup > Security > Security > General".
2. Select "Disk & Memory".
3. Enable "Volatile Mode".
4. Enter the "Security Password".
The default password is *123456*. For more information, see [Chapter 12.6, "Using the security settings"](#), on page 481.
The R&S SMCV100B requests a reboot.
5. Confirm the request.
The system reboots. The enabled settings are active.

To enable file transfer over FTP

1. Select "System Config > Setup > Security > Security > LAN Services".
2. In the "Common Services" tab, enable "LAN Interface"
3. Enable "FTP"
4. Enter the "Security Password".
The default password is *123456*. For more information, refer to [Chapter 12.6, "Using the security settings"](#), on page 481.
5. Select "Accept".

To enable file transfer over SMB (samba)

1. Select "System Config > Setup > Security > Security > LAN Services"

2. Enable "LAN Interface"
3. Select "Samba Services".
4. Enable the "SMB 1.0/2.0 Client".
5. Enable the "SMB 1.0/2.0 Server".
6. Enter the "Security Password".
The default password is 123456. For more information, refer to [Chapter 12.6, "Using the security settings"](#), on page 481.
7. Select "Accept".

To enable file transfer over USB

1. Select "System Config > Setup > Security > Security > General"
2. Select "Disk & Memory".
3. Enable "USB Storage"
4. Enter the "Security Password".
The default password is 123456. For more information, refer to [Chapter 12.6, "Using the security settings"](#), on page 481.
5. Select "Accept".

11.9.2 Accessing the file system of the R&S SMCV100B over FTP

If the R&S SMCV100B is connected to a LAN, you can use file transfer protocol (FTP) to access the file system and to transfer files from and to the instrument.

How to: see [Chapter 3.1.7, "Connecting to LAN"](#), on page 27.

To access the file system over FTP

We assume that the instrument and the remote PC are connected to a LAN.

1. [Enable file transfer via FTP](#)
2. [Enable write permission on the file system](#)
3. On the remote PC, start the Windows Explorer.
4. In the address field, enter `ftp://<"IP Address" of the Instrument>`, e.g. `ftp://10.124.0.166`.

Tip: The R&S SMCV100B indicates its IP address on the block diagram.

A log-on dialog opens and requests a password.

The default user name and password is *instrument*.

Tip:

Default password

The FTP and SAMBA file access use the user "instrument" with default password "instrument".

We recommend that you change this password in the "Setup > Security > Password Management > Change User Password" dialog before connecting the instrument to the network.

See [Chapter 12.6.4, "Password management"](#), on page 491.

5. Enter the password to access the `user` directory.

The `user` directory corresponds to the `/var/user/` directory of the instrument.

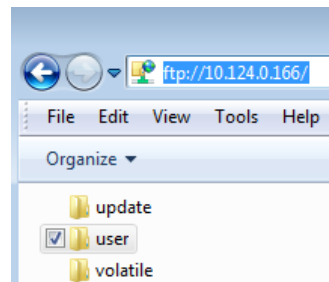

There, you can perform standard functions like creating directory, or saving files.

6. In the `user` directory, create a directory, e.g. `test ftp`.

7. Select Save/Rcl.

Open the `/var/user/` directory.

The dialog displays the `/var/user/test ftp` directory.

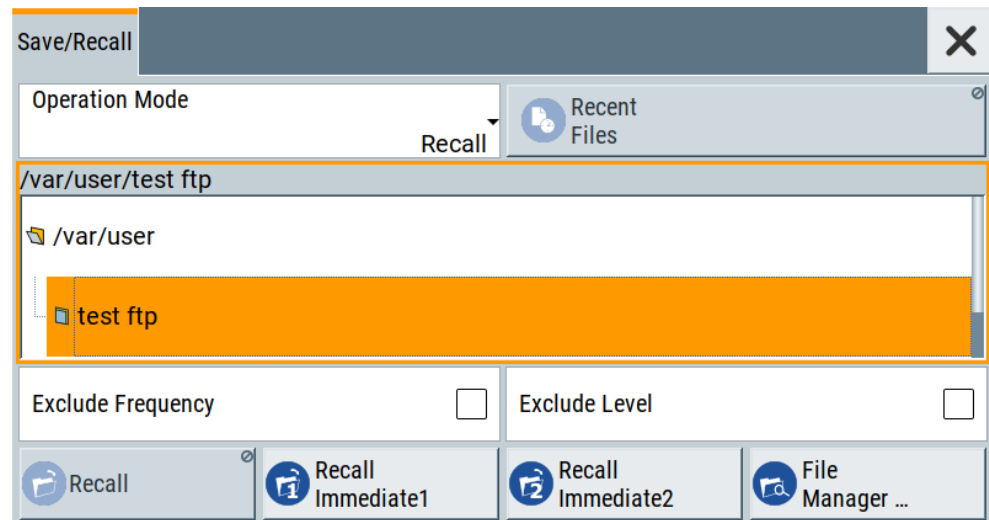

11.9.3 Accessing the R&S SMCV100B file system using SMB (Samba)

The SMB (Samba) protocol is an alternative way to access the file system of the instrument from a remote PC. This protocol works if both the instrument and the PC are connected to a LAN.

How to: see [Chapter 3.1.7, "Connecting to LAN"](#), on page 27.

To access the file system over SMB

We assume that the instrument and the remote PC are connected to a LAN.

1. [Enable file transfer via FTP](#)
2. [Enable write permission on the file system](#)
3. On the remote PC, start the Windows Explorer.
4. In the address field, enter `\\<"IP Address" of the Instrument>`, e.g. `ftp://10.124.0.166`.

Tip: The R&S SMCV100B indicates its IP address on the block diagram.

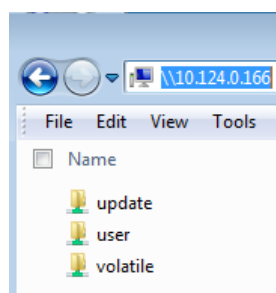

The `user` directory corresponds to the `/var/user/` directory of the instrument; the `volatile` directory - to the `/var/volatile` directory.

To map the R&S SMCV100B as a network drive to the remote PC

We assume that the instrument and the remote PC are connected to a LAN.

1. [Enable file transfer via SMB \(Samba\)](#)
2. [Enable write permission on the file system](#)
3. On the remote PC, start the Windows Explorer.
 - Open the "Map Network Drive" dialog.
 - a) Select a valid "Drive", e.g. *W*.
 - b) In the "Folder" field, enter `\\<"IP Address" of the Instrument>/user` or `\\<"Hostname" of the Instrument>/user`
 For example: `\\10.124.0.166/user` or `\\SMCV100B-102030/user`.
Tip: The R&S SMCV100B indicates its IP address on the screen.
 - c) Select "Finish".

A log-on dialog opens and requests a user name and a password.

Tip:**Default password**

The FTP and SAMBA file access use the user "instrument" with default password "instrument".

We recommend that you change this password in the "Setup > Security > Password Management > Change User Password" dialog before connecting the instrument to the network.

See [Chapter 12.6.4, "Password management"](#), on page 491.

4. Enter the user name and the password of your instrument.

The `/var/user/` directory of the instrument is mapped to and displayed as a network drive of the remote PC.

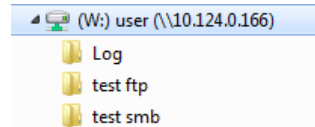

You can access the files in the `/var/user/` directory, perform standard function like creating directory, or saving files.

11.9.4 Using a USB storage device for file transfer

Alternatively to the file transfer possibility via LAN, you can use a USB storage device for direct file transfer from and to the instrument.

We recommend that you transfer files with user data (like lists or instrument setup files) to the instrument, rather than load and play them from a connected USB storage device.

To transfer a file with user data to the instrument

1. Connect a USB storage device, for example a USB memory stick to one of the USB interfaces of the instrument.

The R&S SMCV100B recognizes the connected USB storage device automatically.

2. [Enable file transfer via USB](#)
3. [Enable write permission on the file system](#)
4. Select Save/Rcl.

The dialog displays the `/var/user/` directory and the `/usb/` drive.

5. In the "Save/Recall" dialog, select "File Manager".
6. In the directory tree, navigate to the `/usb/` drive.
Select the required file with user data.
7. Select "Copy".
8. In the directory tree, navigate to the `/var/user/` directory.
Select "Paste".

The file with user data is transferred to the instrument.

11.9.5 Using a file server for test files exchange

You can use a central file storage location like a file server in your company network to save setup files, SCPI scripts, application programs, or waveform files on it. Usually,

you would like to distribute the files to several instruments. If the R&S SMCV100Bs are connected to a LAN, you can create a shortcut on the instruments to the file server.

To access the file server

1. On each R&S SMCV100B, map the required directory of the file server to the instrument.
Perform the steps described in [Chapter 11.8.4, "How to map a network folder"](#), on page 432.
2. On each R&S SMCV100B, use the same alias name for the directory of the file server, i.e. enter the same "Local Folder" (in this example *Setups*).

On any of the R&S SMCV100B, you access the file server directly from the "File Manager" and under the same name, e.g. `/shares/Setups`.

An extra advantage in remote control is that the same application program would control the instruments.

For example, use the remote control command `MMEMoRY:CDIRECTORY "/shares/Setups"` to set the default directory for mass storage.

11.10 Creating screenshots of current settings

The save/recall function enables you to save current settings in a file. To document the most important settings for a performed signal generation, you can also save a hardcopy of the current display.

- [Hardcopy settings](#)..... 440
- [How to save a hardcopy of the display](#)..... 443

11.10.1 Hardcopy settings

Access:

- ▶ Select "System Config > Setup > User Interface > Hardcopy".

The remote commands required to define these settings are described in [Chapter 14.11, "HCOPY subsystem"](#), on page 612.

Settings:

Automatic Naming	441
File	441
Format	441
Options	441
Save	441
Hardcopy Options > Common	441
L Automatic Naming	441
L Format	442

L Region.....	442
Hardcopy Options > Automatic Naming.....	442
L Path.....	442
L Clear Path.....	442
L Prefix, Year, Month, Day.....	442
L Current Auto Number.....	443

Automatic Naming

If enabled, creates the output filenames automatically according to the rules set with the [Hardcopy Options > Automatic Naming](#) settings.

Remote command:

`:HCOPY:FILE[:NAME]:AUTO:STATE` on page 616

File...

In "Automatic Naming > Off" mode, accesses the standard file select dialog for selecting the filename and folder the hardcopy is stored in.

If you have enabled "Automatic Naming", the instrument displays the automatically generated filename.

Remote command:

`:HCOPY:FILE[:NAME]` on page 614

Format

Selects the output file format, for example *.bmp, *.jpg*.xpm and *.png.

Remote command:

`:HCOPY:IMAGE:FORMAT` on page 614

`:HCOPY:DEVICE:LANGUAGE` on page 614

Options...

Accesses [Hardcopy Options](#) dialog.

Save

Saves a hardcopy of the current display as a file.

Remote command:

`:HCOPY[:EXECUTE]` on page 615

Hardcopy Options > Common

Access: select "Hardcopy > Options... > Common".

With the provided settings, you can customize the file format and the syntax of the automatically assigned filename.

Automatic Naming ← Hardcopy Options > Common

If enabled, creates the output filenames automatically according to the rules set with the [Hardcopy Options > Automatic Naming](#) settings.

Remote command:

`:HCOPY:FILE[:NAME]:AUTO:STATE` on page 616

Format ← Hardcopy Options > Common

Selects the output file format, for example *.bmp, *.jpg*.xpm and *.png.

Remote command:

[:HCOPY:IMAGe:FORMat](#) on page 614

[:HCOPY:DEVIce:LANGUage](#) on page 614

Region ← Hardcopy Options > Common

Displays the snapshot area.

Remote command:

[:HCOPY:REGIon](#) on page 614

Hardcopy Options > Automatic Naming

Access: select "Hardcopy > Options... > Automatic Naming".

Provided are the following settings:

Path... ← Hardcopy Options > Automatic Naming

Selects the directory.

Note: To select the destination path, specify also a filename. Otherwise an error message is displayed and selection is canceled.

Remote command:

[:HCOPY:FILE\[:NAME\]:AUTO:DIRectory](#) on page 615

Clear Path ← Hardcopy Options > Automatic Naming

Deletes all image files with extensions *.bmp, *.jpg, *.png and *.xmp in the directory set for automatic naming.

Before the command is executed, a warning message prompts you to confirm the deletion of the files.

Remote command:

[:HCOPY:FILE\[:NAME\]:AUTO:DIRectory:CLEar](#) on page 616

Prefix, Year, Month, Day ← Hardcopy Options > Automatic Naming

Determines the rules for "Automatic Naming".

Per default, the automatically generated filename is composed of:

<Path>/<Prefix><YYYY><MM><DD><Number>.<Format>, where Y, M and D mean year, month, Day; Number is the [Current Auto Number](#).

You can activate or deactivate each component separately.

The "Resulting filename" indicates the current filename syntax.

Remote command:

[:HCOPY:FILE\[:NAME\]:AUTO\[:FILE\]:PREFix](#) on page 617

[:HCOPY:FILE\[:NAME\]:AUTO\[:FILE\]:PREFix:STATe](#) on page 617

[:HCOPY:FILE\[:NAME\]:AUTO\[:FILE\]:YEAR:STATe](#) on page 616

[:HCOPY:FILE\[:NAME\]:AUTO\[:FILE\]:MONTH:STATe](#) on page 616

[:HCOPY:FILE\[:NAME\]:AUTO\[:FILE\]:DAY:STATe](#) on page 616

Current Auto Number ← Hardcopy Options > Automatic Naming

Indicates the number which is used in the automatically generated filename.

Note: When initially switching on the instrument, the number is reset to the lowest possible value. Starting with number 0 the output directory is scanned for existing files. As long as files with the same name are existing, the number is increased by 1. The number is automatically set so that the resulting filename is unique within the selected path. The current number is not in the save/recall file but is temporarily stored within the database. At the following save operation, the number is increased.

Remote command:

`:HCOPY:FILE[:NAME]:AUTO[:FILE]:NUMBER?` on page 617

11.10.2 How to save a hardcopy of the display

1. Select "System Config > Setup > User Interface > Hardcopy".
2. To define the output format, select "Format > JPG".
3. To enable the instrument to create output filenames, select "Automatic Naming > On".
4. Select "Options...".
5. In the "Hardcopy Options" dialog:
 - a) To change the default directory the file is saved in, select "Automatic Naming Settings > Path" and define a path and a filename. For example, select the default directory `/var/user`.
 - b) If necessary, disable or change some of the parameters in the "Automatic Naming Settings".
 - c) Close the "Hardcopy Options" dialog.
6. In the "Hardcopy" dialog, select "Save".

The instrument saves a hardcopy of the current instrument display as a *.jpg file. The filename is automatically created.
7. To print the hardcopy, connect the instrument to a LAN and:
 - a) Transfer the file to a remote computer as described in [Chapter 11.9, "How to transfer files from and to the instrument"](#), on page 434.
 - b) On the remote computer, navigate through the file system.
 - c) Print the selected file.

For more information, refer to the online help of the operating system.

12 General instrument functions

The general instrument functions include basic instrument settings, regardless of the selected operating mode and measurement. Some of these settings like screen display and peripherals are initially configured at the setup of the instrument, according to personal preferences and requirements. However, you can individually adjust the settings at any time, for example, for specific applications.

The following special functions help you in service and basic system configuration:

- [Chapter 12.1, "Customizing the user interface"](#), on page 444
Allows you to adjust the display and keyboard language settings.
- [Chapter 12.2, "Configuring global connectors"](#), on page 449
Allows you to map internal or external signals to the multipurpose connectors.
- [Chapter 12.3, "Checking parameters and dependencies"](#), on page 458
Allows you to check for interdependencies between parameters and settings.
- [Chapter 12.4, "Organizing frequently used settings as favorites"](#), on page 460
Enables you to group user-defined settings in a favorites list or to assign actions to the [★ (User)] as quick access for later retrieval.
- [Chapter 12.5, "Managing licenses and license keys"](#), on page 466
If you have purchased an additional option for the R&S SMCV100B, you can enable it using a license key.
- [Chapter 11.2, "Restoring the \(default\) instrument configuration"](#), on page 416
At any time, you can restore a default configuration to start a measurement at a defined instrument state, or set the instrument to factory preset.
- [Chapter 17.3, "Performing maintenance tasks"](#), on page 855
Special functions like calibration routines and selftests put your instrument to an initial state.
- [Chapter 12.6, "Using the security settings"](#), on page 481
Special security and protection functions protect your instrument from unauthorized use or activate specific test routines.

12.1 Customizing the user interface

The R&S SMCV100B provides basic alignments of instrument settings regarding the user interface, that means the touch panel (screen), the appearance of the displayed dialogs and graphics, and an external keyboard.

Start / stop display update

The operating system of the R&S SMCV100B refreshes the displayed settings by default in almost real-time, to keep the display updated with the internally used values. However, you can turn off this function to reduce settling times when the instrument is remote controlled.

In detail described in the following paragraphs, you can:

- Set display and keyboard language, see [Chapter 12.1.1, "Display and keyboard settings"](#), on page 445
- Set date and time for the system clock, see [Chapter 17.3.1, "Date and time"](#), on page 856
- Configure and activate a [Screen Saver](#)
- Deactivate display update to improve performance, see [Chapter 12.1.2, "Display update settings"](#), on page 446
- Determine the state of the RF signal, and the level display in the status bar when you turn on the R&S SMCV100B, see [Chapter 12.1.3, "Defining the RF signal state on power on"](#), on page 447.

12.1.1 Display and keyboard settings

Access:

1. Select "System Config > Setup > User Interface > Display/Keyboard > Display".

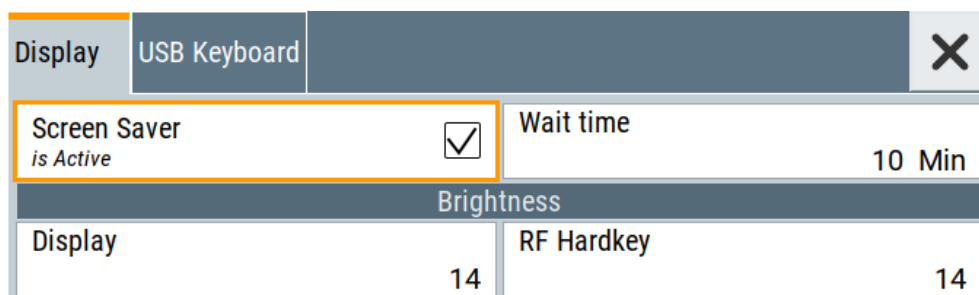

2. Select "Display/Keyboard > USB Keyboard".

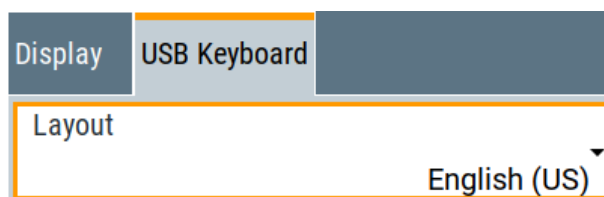

In the "Display/Keyboard" dialog, you can change regional and language options for the GUI and an external keyboard, and define the screen saver settings.

The remote commands required to configure the display and keyboard are described in [Chapter 14.9, "DISPlay subsystem"](#), on page 606 and [Chapter 14.12, "KBOard subsystem"](#), on page 617.

Screen Saver	446
Wait Time	446
Display	446
RF Hardkey	446
USB Keyboard > Layout	446

Screen Saver

Activates the screensaver.

If activated, the display including backlight is switched off after the selected **Wait Time** elapses and if no entries via touch panel, front panel, external mouse, or external keyboard are made

Remote command:

`:DISPlay:PSAVe[:STATe]` on page 607

Wait Time

Enters the idle time that must elapse before the display lamp is shut off when no entries are made.

Remote command:

`:DISPlay:PSAVe:HOLDoff` on page 607

Display

Adjusts the brightness of the display.

Increase the value to turn up the display brightness.

Remote command:

`:DISPlay:BRIGhtness` on page 608

RF Hardkey

Adjusts the brightness of the [RF on/off] key.

Increase the value to change the contrast between the key and the front panel background color.

Remote command:

`:DISPlay:BUtTon:BRIGhtness` on page 608

USB Keyboard > Layout

Selects the language of an externally connected keyboard via USB. The function assigns the corresponding keys automatically.

Remote command:

`:KBOard:LAYout` on page 617

12.1.2 Display update settings

Access:

- ▶ Select "System Config > Setup > User Interface > Start/Stop Display Update".

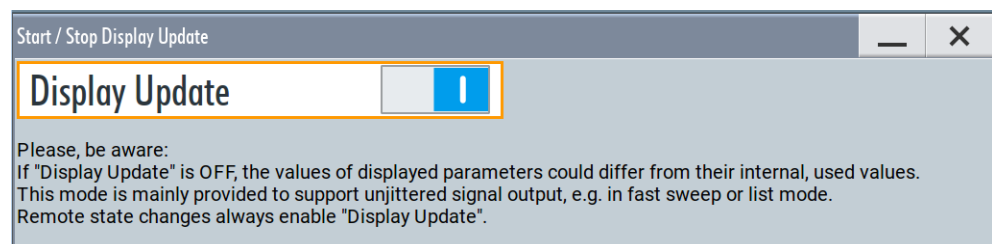

This dialog enables you, to deactivate updating the display.

The remote command to switch off the display update is described in [Chapter 14.9, "DISPlay subsystem"](#), on page 606.

Display Update is

Disables the automatic refreshing of the displayed values.

Remote command:

:DISPlay:UPDate[:STATe] on page 608

12.1.3 Defining the RF signal state on power on

As additional functions for the level settings, you can determine the state of the RF signal, and the level display in the status bar when you turn on the R&S SMCV100B.

Power-On/EMF settings

Access:

- ▶ Select "RF" > "RF Level" > "Power-On / EMF".

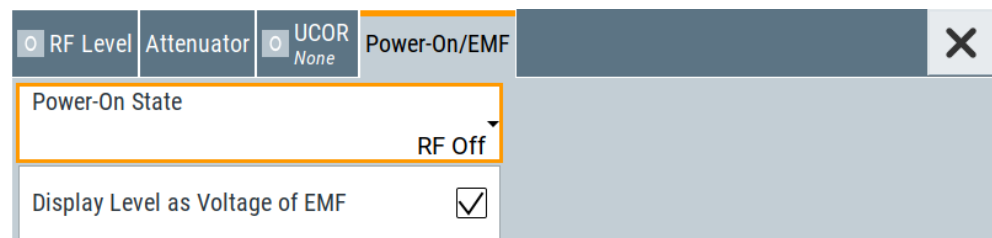

The "Power-On/EMF" dialog contains all settings for configuring the power-on behavior and the level display.

Settings:

Power-On State	447
Display Level as Voltage of EMF	447

Power-On State

Determines the RF signal output state when the instrument is switched on.

You can disable the RF output signal in general, or start it in the same state as it had been when it was switched off.

Remote command:

:OUTPut<hw>[:STATe]:PON on page 619

Display Level as Voltage of EMF

Activates display of the signal level as voltage of the EMF (no-load voltage).

If disabled, the level is displayed as a voltage over a 50 Ohm load.

Note:

The setting is not affected by an instrument preset ([Preset] key or *RST) and the "Save/Recall" function. It is reset only by factory preset.

Remote command:

[:SOURce<hw>] :POWer:EMF:STATe on page 788

12.1.4 How to set the initial instrument settings

This section describes how to set up the R&S SMCV100B initially.

12.1.4.1 Setting the keyboard language

You can select the language of the external keyboard connected to the instrument.

To adjust the keyboard settings

1. Select "System Config > Setup".
2. Select "User Interface > Keyboard".

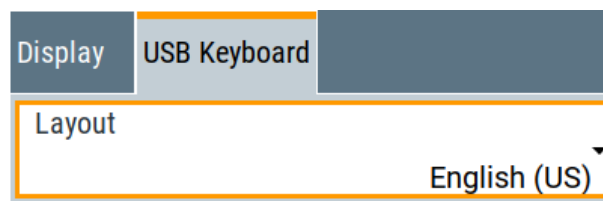

3. Select the "Layout".

The dialog closes and the changes take effect immediately.

12.1.4.2 Setting the screen saver

You can enable a screen saver that automatically turns off the display after a user-defined period of time. The screen saver is activated if no settings are made on the touch screen, or via keys or the rotary knob during the selected wait time.

To activate the screen saver

1. Select "System Config > Setup".
2. Select "User Interface > Display"
3. Activate the "Screen Saver".

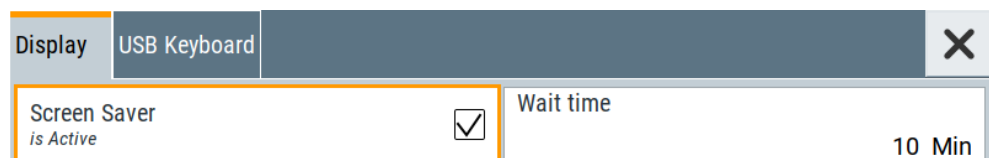

4. Define the "Wait Time" in minutes.

The instrument turns off the display after the defined period of time.

5. To reactivate the display, tap the screen or press any key on the front panel.

To deactivate the screen saver

1. Select "System Config > Setup".
2. Select "User Interface > Display"
3. Disable the "Screen Saver" state.

12.2 Configuring global connectors

The R&S SMCV100B is equipped with multipurpose bi-directional connectors.

Grouped according to their impact on the baseband or on the RF signal, the same connectors are divided into:

- [Chapter 12.2.3, "Trigger marker clock settings"](#), on page 451
- [Chapter 12.2.4, "RF connectors settings"](#), on page 453

12.2.1 Required options

The R&S SMCV100B is always equipped with two "User" connectors.

Additional options are not required.

12.2.2 About global connectors

Signal to connector mapping

As described in [Chapter 4.4.1, "Basics on signals, modulation types and filters"](#), on page 80, the R&S SMCV100B uses several internally generated and externally supplied signals.

To handle these signals, the R&S SMCV100B introduces the concept of signal to connector mapping. The available signals are not dedicated to a particular connector but can be mapped to one or two "User" connectors.

The signal mapping and the polarity, the trigger threshold, and the input impedance of the input connectors are configurable parameters. The connectors settings are grouped in the dialog: [Global connectors settings](#).



For required configuration steps, see ["General Workflow"](#) on page 457.

12.2.2.1 Global connectors

The R&S SMCV100B is equipped with "User x" connectors which can be freely assigned a selection of signals and which can be configured as both inputs and outputs.

A common threshold and input impedance is effective for all trigger and clock signal inputs provided at the "User" connectors. The settings influence the custom digital modulations, the generation of waveforms or multicarrier signals, and all digital standards.

See [Chapter 8.9, "Varying the RF signal in list or sweep mode"](#), on page 317.

[Table 12-1](#) gives an overview of the signals that can be applied to and output at the User connector.

Table 12-1: Mapping control signals to the User x connectors

Connector	Direction	Assigned signal	Remark
"User 1"/"User 2"	"Input"	"Global Trigger" "Global Next Segment" "Instrument Trigger"	Per default, the signal at "User 2" is a global trigger input signal.
	"Output"	"Baseband Marker"	Both "User x" connectors output the same "Baseband Marker" signal. Per default, the signal at "User 1" is an output signal.
	"Not Used"	"None"	No signal is input or output. The setting constitutes a switched-off User connector.
"User 1"	"Input"	"TS" "ETI" "S/PDIF"	-
"User 2"	"Input"	"1 PPS"	-

12.2.2.2 Trigger, marker, clock and RF connectors

The [Trigger marker clock settings](#) and [RF connectors settings](#) dialogs provide an overview of the current mapping of the logical signals to the corresponding connectors. The dialogs are summary representation of related settings, as configured with the [Global connectors settings](#) settings.

12.2.2.3 Status indicators

Connector status LEDs

A dedicated LED indicates the connector status:

- ● green: an input connector
- ● yellow: an output connector
- ● red: error

- ● no light / gray: the connector is not active
- 🟡 blinking LED: connection indication as a result of the "Identify Connector" function

T/M/C status LEDs



For quick overview of the source (internal/external) of the used trigger, marker and clock signals, the block diagram displays *T/M/C status LEDs* on the left side of the "Baseband" block.

If the baseband generator is active, a dedicated LED indicates the status:

- ● green: an external signal is used.
- 🟡 yellow: the signal is available at the output connector.



The "T/M/C" block is only displayed for arbitrary waveform baseband signals and custom digital modulation baseband signals ("Baseband > ARB/Custom Digital Mod"). Other baseband signals do not have the trigger, marker and clock signals.

12.2.3 Trigger marker clock settings

Access:

1. Perform one of the following:
 - In the "Block Diagram", select the [T/M/C status LEDs](#) on the left side of the "Baseband" blocks.
 - Select "Baseband > Trigger Marker Clock".

The "Trigger Marker Clock" gives an overview of the current mapping of the logical signals to the connectors, as configured in the [Global Connectors](#) dialog. Clicking the connector name directly accesses the related connector settings.

Baseband A
✕

	Logical Signal	Connector	Show	
Trigger Source	Internal		☐	
Clock Source	Internal		☐	
Marker	On/Off Ratio	User 1	🔍	

Diagram Legend

T = Trigger

M = Marker

C = Clock

🟡 = Signal is available at Output Connector

● = Signal Source is external

Global Connectors ...

- Use the built-in [Show Connector](#) function to display the physical location of the selected connector.

A blinking LED on the rear panel indicates the selected connector, too.

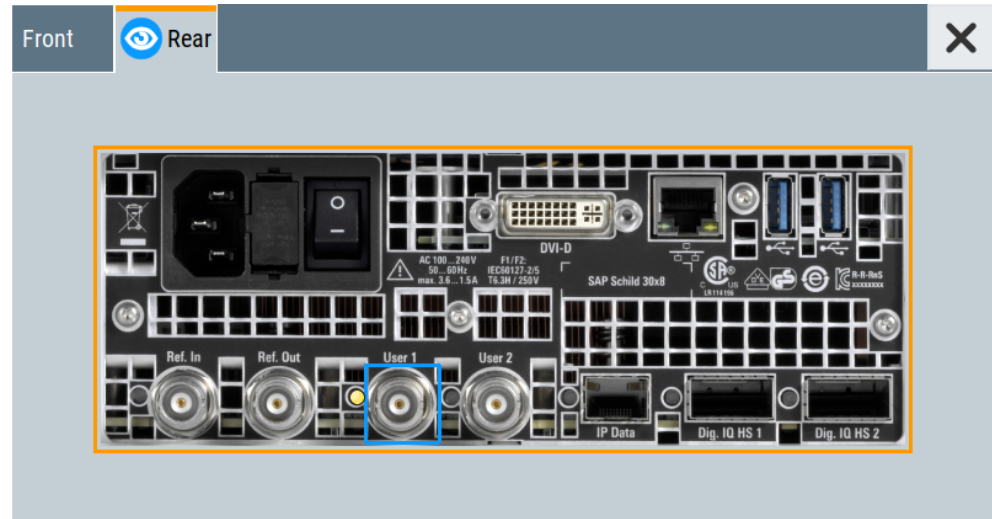

The eye icon  in the tab header indicates the location of the connector on the panel (front, rear or both).

12.2.3.1 Overview table

Logical Signal

Displays the logical signal, as configured in the "Trigger In", "Marker" or "Clock" tab of the active baseband signal. Only the signals as configured in the "Baseband > ARB/Custom Digital Mod" tabs are applied. See for example [Chapter 4.6.3, "ARB settings"](#), on page 143.

Connector

Displays the assigned connector.



Show Connector

Accesses a dialog that displays the physical location of the selected connector on the front/rear panel of the instrument.

A blinking LED on the front/rear panel indicates the selected connector, too (see [Chapter 12.2.2.3, "Status indicators"](#), on page 450).

12.2.3.2 Global connector settings

The "Input Signal" dialog, the "Trigger/Marker/Clock" dialog and "Trigger In", "Marker" and "Clock" tabs in "Baseband > ARB/Custom Digital Mod" configuration dialogs provide quick access to the related connector settings. Click the "Global Connectors" button to access the settings.

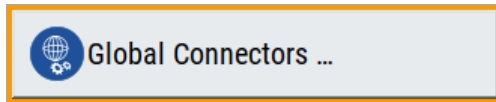

See also [Chapter 12.2, "Configuring global connectors"](#), on page 449.

12.2.4 RF connectors settings

Access:

1. Perform one of the following:
 - In the "RF" block, select "RF" > "RF Frequency" > "RF Connectors".
 - In the control signal block next to the "RF" block, select "Instr. Trigger".
 - Select "System Config" > "Setup" > "RF Connectors".

The "RF Connectors" dialog gives an overview of the mapping of the logical signals to the connectors; the displayed connectors depend on the installed options. Selecting a connector name accesses directly the related connector settings.

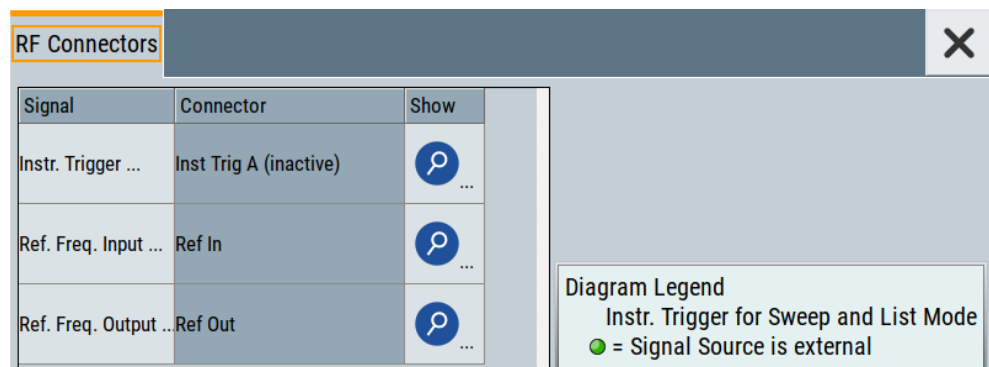

2. Select the "Signal" name to access the dialog with respective settings.
3. Use the built-in [Show Connector](#) function to display the physical location of the selected connector.

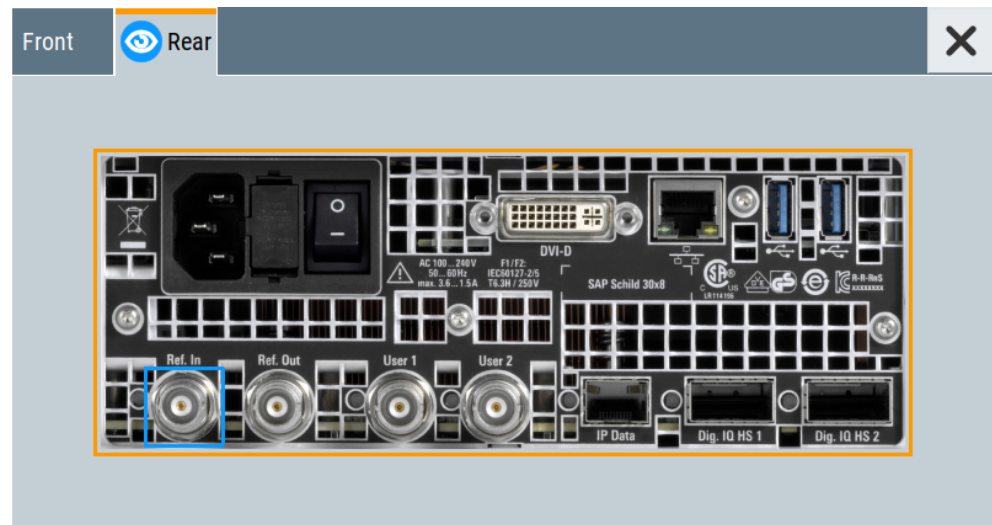

The eye icon  in the tab header indicates the panel (front, rear or both) the selected connector is located at.

Settings:

Signal.....	454
Connector.....	454
Show Connector.....	454

Signal

Opens the dialog with the corresponding settings.

Connector

Displays the assigned connector.



Show Connector

Accesses a dialog that displays the physical location of the selected connector on the front/rear panel of the instrument.

A blinking LED on the front/rear panel indicates the selected connector, too (see [Chapter 12.2.2.3, "Status indicators"](#), on page 450).

12.2.5 Global connectors settings

Access:

- To access global connector settings via the signal control blocks of the block diagram, select the [T/M/C status LEDs](#).
- In the opening dialogs, try one of the following:
 - Select "Connector" > "User x".
 - Select "Global Connectors".

3. To access global connector settings via the baseband block of the block diagram, select one of the following:
 - Select "Baseband" > "ARB"/"Custom Digital Modulation" > "Trigger In" > "Global Connectors".
 - Select the tab "Input Signal" > "Global Connectors" in some baseband standard signal generation configuration dialog.

The "Global Connectors" dialog provides settings to configure the signal to connector routing and the physical characteristics of the input connectors for trigger, clock and control signals.

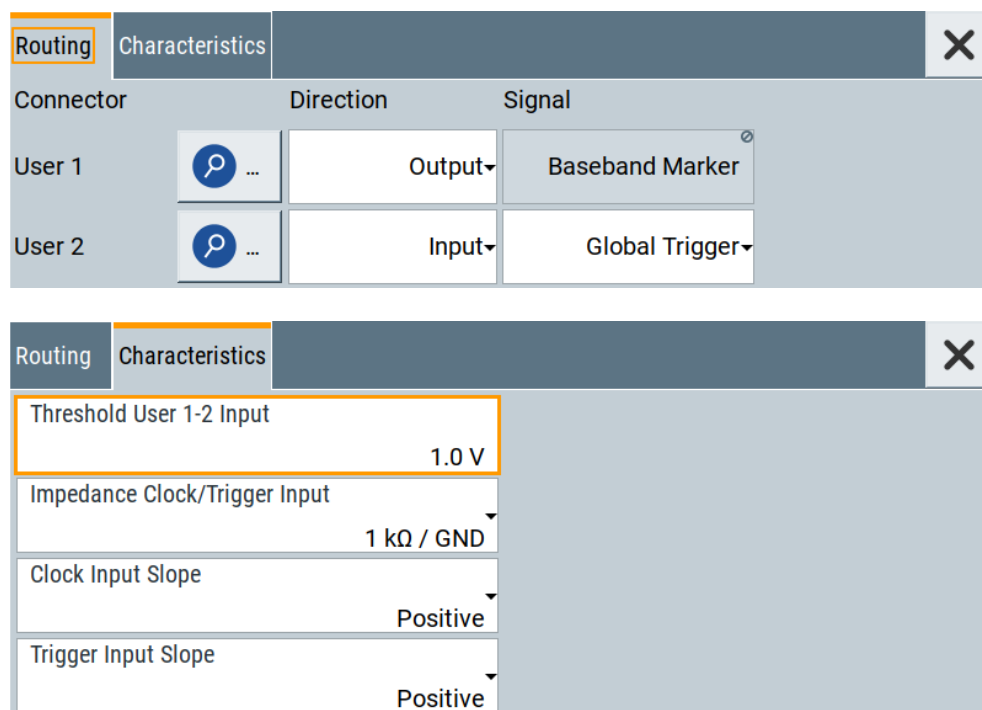

Use the built-in [Show Connector](#) function to display the physical location of the selected connector. Also, a blinking LED on the rear panel indicates the selected connector.

Settings

Show Connector	455
Direction	456
Signal	456
Threshold User1-2 Input	457
Impedance Clock/Trigger Input	457
Clock Input Slope	457
Trigger Input Slope	457



Show Connector

Accesses a dialog that displays the physical location of the selected connector on the front/rear panel of the instrument.

A blinking LED on the front/rear panel indicates the selected connector, too (see [Chapter 12.2.2.3, "Status indicators"](#), on page 450).

Direction

Sets the direction of the signal at the connector that can be input or an output.

If you do not use the connector, select "Not Used".

Remote command:

[\[:SOURce\]:INPut:USER<ch>:DIRection](#) on page 650

[:OUTPut:USER<ch>:DIRection](#) on page 650

Signal

Determines the control signal that is input or output at the selected connector. Whether the connector is used as an input or an output is selected by the parameter [Direction](#).

The [Table 12-1](#) lists the available control signals.

"Baseband Marker"

Marker signal output for triggering and control of external devices with user-definable marker signals. The output signal is available at "User 1"/"User 2" connectors.

"Global Trigger"

Input for triggering custom digital modulations, digital standards and ARB. A trigger event affects the signal generation in all basebands for which the "Global Trigger" signal is enabled.

The input signal is available at "User 1"/"User 2" connectors.

"Global Next Segment"

Input next segment for triggering of multi-segment waveform files, see [Chapter 4.8, "Generating multi-segment waveform files"](#), on page 190.

The input signal is available at "User 1"/"User 2" connectors.

"Instrument Trigger"

Input for triggering sweeps and list mode available at "User 1/2" connectors.

See [Chapter 8.9, "Varying the RF signal in list or sweep mode"](#), on page 317.

"TS"

Transport stream (TS) input signal for transport stream application available at "User 1" connector only.

"ETI"

Ensemble transport interface (ETI) input signal available at "User 1" connector only.

"S/PDIF"

Sony/Philips digital interface (S/PDIF) input signal available at "User 1" connector only.

"1 PPS"

1PPS (one pulse per second) input signal available at "User 2" connector only.

"None"

No signal is assigned to the connector.

Remote command:

[\[:SOURce\]:INPut:USER<ch>:SIGNal](#) on page 651

[:OUTPut:USER<ch>:SIGNal](#) on page 651

Threshold User1-2 Input

Sets the high/low threshold in volts for the signal at the User1-2 connectors.

The input signal is defined with the parameter [Signal](#). The same threshold applies for both connectors and any input signal.

Remote command:

[\[:SOURce\]:INPut:USER:TRIGger:LEVel](#) on page 652

[\[:SOURce\]:INPut:USER:CLOCK:LEVel](#) on page 652

Impedance Clock/Trigger Input

Selects the input impedance for the external trigger/clock inputs.

Set the value to 1 k Ω /GND for high clock rates.

Remote command:

[\[:SOURce\]:INPut:USER:TRIGger:IMPedance](#) on page 652

[\[:SOURce\]:INPut:USER:CLOCK:IMPedance](#) on page 652

Clock Input Slope

Sets the polarity of the active slope of an externally applied clock signal.

Remote command:

[\[:SOURce\]:INPut:USER:CLOCK:SLOPe](#) on page 652

Trigger Input Slope

Sets the polarity of the active slope of an applied instrument trigger.

Remote command:

[\[:SOURce\]:INPut:USER:TRIGger:SLOPe](#) on page 653

12.2.6 How to enable signals and perform signal to connector mapping

This section introduces the general principle of connector configuration.

General Workflow

The [Figure 12-1](#) shows the main configuration stages, together with the corresponding user interface dialogs.

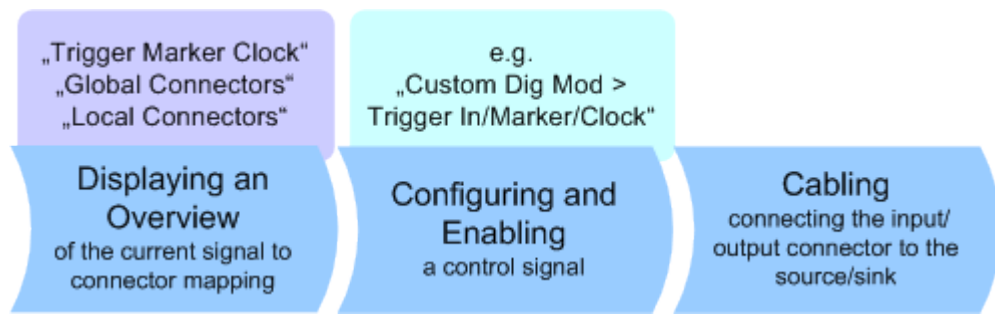

Figure 12-1: The principle of the signal to connector mapping

To perform the signal to connector mapping, perform the following:

1. Verify the current connector configuration and mapping and if necessary (re)define it.
2. Configure and enable the required signal, e.g. trigger, marker, clock signal.
3. Connect the configured connector, e.g. to the external instrument or device.

For a step-by-step description:

See [Chapter 3.3.4, "Enabling and configuring a marker signal"](#), on page 51.

To find out the physical location of the connector on the front/rear panel of the instrument

Proceed as follows:

1. Select [T/M/C status LEDs](#) or "Instr. Trigger" to open the "Trigger Marker Clock" and the "RF Connectors" dialog.
2. For the corresponding connector, select the "Find" icon.

The "Find Connector" dialog opens and displays the physical location of the selected connector on the front/rear panel of the instrument.

A blinking LED on the front/rear panel indicates the selected connector, too.

See also ["Connector status LEDs"](#) on page 450.

12.3 Checking parameters and dependencies

You can check instrument settings on a parameter-level and affecting configurations.

1. Select the parameter that you want to check.
2. Right-click the parameter, to open the context menu.
3. Select "Show Incoming Dependencies".

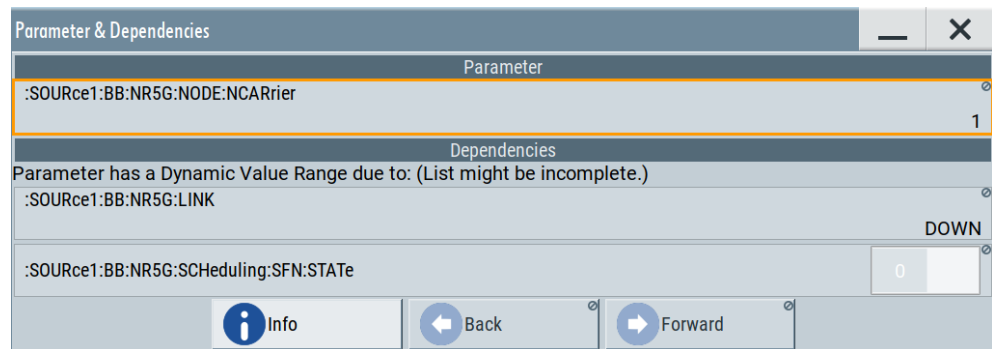

The "Parameter & Dependencies" dialog opens. The "Parameter" panel of this dialog displays the SCPI command including its setting or query parameters. The "Dependencies" panel displays dependent parameters and their settings that affect the setting of the parameter, that you want to check initially (2).

4. In the "Dependencies" panel, you can further check for dependencies within the dependent parameters.
 - a) Select the parameter that you want to check from the list in the "Dependencies" panel, e.g.:
`:SOURCE1:BB:NR5G:LINK DOWN` for the "Link Direction" > "Downlink".

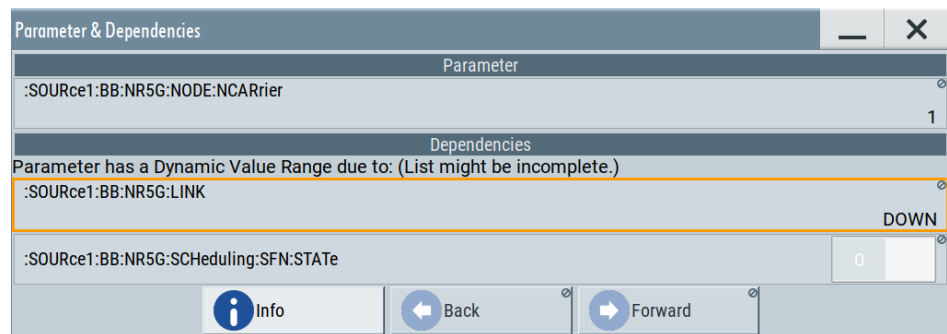

- b) Select "Show Incoming Dependencies".

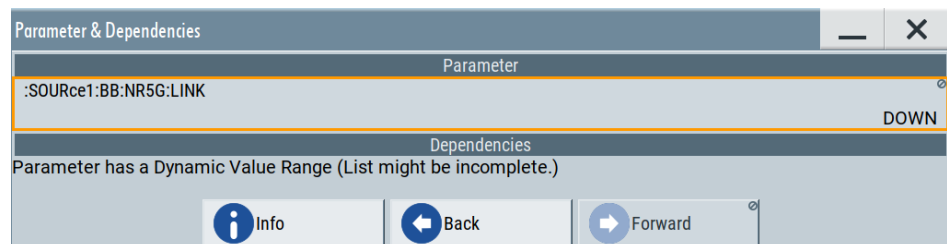

The list in the "Dependencies" panel is empty. I.e., the "Link Direction" setting does not depend on any further parameters or settings.

5. Optionally, navigate via "Back" and "Forward" to move up or down the dependency tree for parameters with dynamic value range.

Settings:**Info**

Accesses the instrument help, see [Chapter 12.3, "Checking parameters and dependencies"](#), on page 458.

Back/Foward

Toggles between parameter dependencies for dependent parameters.

If you select "Show Incoming Dependencies" for parameters or settings from the "Dependencies" panel, you can move back or move forward through the dependency tree-like structure.

12.4 Organizing frequently used settings as favorites

The R&S SMCV100B provides two possibilities to define frequently used settings and procedures for later retrieval individually.

User menu and [★ (User)] key

These two functions work similar to the favorites function of a browser or other programs. They allow you to create a list of frequently used actions or to group frequently used settings in one dialog.

You can collect the parameters of your configuration in a favorites list, i.e. in the "User Menu", or define settings and actions with the [★ (User)] key:

- "User Menu" to group settings of specific tasks.
Similar to a favorites function, you can use this menu for:
 - Grouping the settings required for a task in one dialog.
 - Saving and recalling the settings of a task.
 - Transferring the settings for use on multiple instruments.
- [★ (User)] key, with customizable function.
You can perform the following steps using this key:
 - Open the "User Menu" (default functionality).
 - Add or remove settings and functions.
 - Execute actions and access functions.

Possible applications

The ★ (User) key and the "User Menu" are useful for the following situations:

- There are functions or tasks you have to perform in a defined order but the setting parameters are distributed across several dialogs.
- There are functions or tasks you have to perform frequently but they are not accessible via the front panel keys.
- The required functions are grouped in a dialog that is not directly accessible from the block diagram.

- Your task involves the frequently loading and executing of certain SCPI scripts. Refer to [Chapter 13.11.4, "How to record / create SCPI lists"](#), on page 560 for information on how to create an SCPI script.
- A quick access to saved setups is required.
- There are functions and tasks you have to perform on several instruments.

Dialog identification

To identify each dialog, the instrument uses a dedicated dialog ID. The dialog ID contains the dialog position on the display and the current active tab. The action that triggers the instrument to open a dialog uses this identification.

Save/Recall vs. recall setup

If you need to restore a specific signal generation setup and perform further configurations based on this particular instrument state, the R&S SMCV100B provides two options:

- "Save/Recall" function
For a detailed description, refer to [Chapter 11.4, "Saving and recalling instrument settings"](#), on page 421.
- "Recall Setup" function
If the "Recall Setup" is the only user action assigned to the [★ (User)] key, pressing this key triggers the R&S SMCV100B to load the user-defined preset file immediately.

12.4.1 User menu settings

The "User Menu" dialog contains function keys to organize, save and load a favorites list. You can also modify, add or delete list entries directly in the dialog.

Clear User Menu

Removes all entries from the "User Menu" at once.

Save User Menu

Saves the current "User Menu" under the defined filename.

Recall User Menu

Loads the selected "User Menu" file.

This function enables you to use the user specific favorites file on another instrument. However, if functions or parameters are not provided due to varying configuration of the instrument, the settings of these particular parameters take no effect.

12.4.2 How to use the user menu for fast adjustments

Access:



1. Press the [★ (User)] key.

The "User Menu" dialog opens.

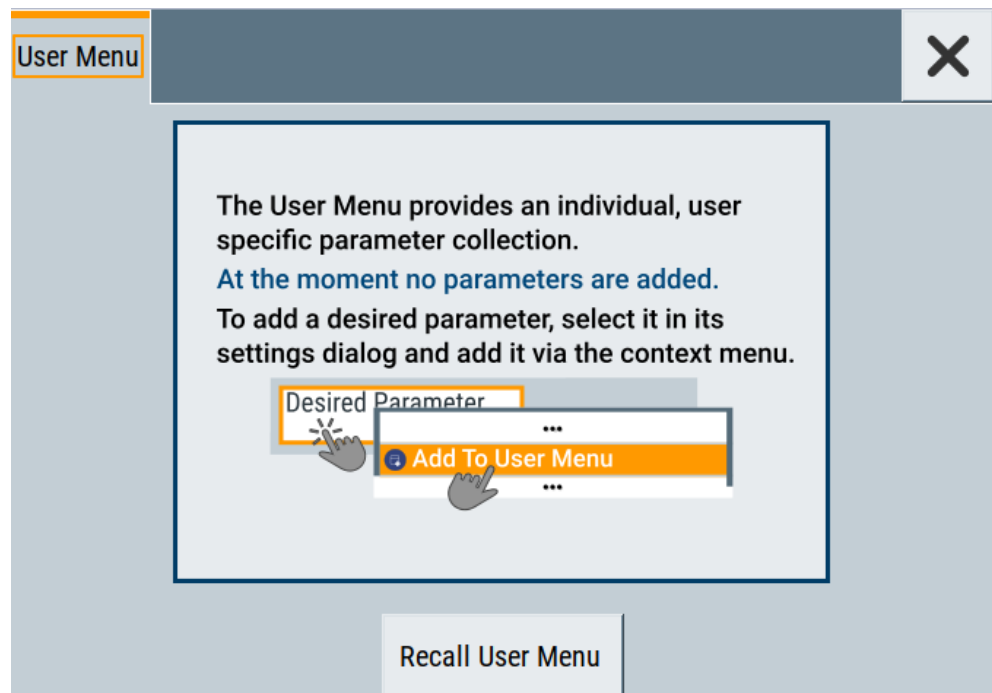

If you execute this action for the first time, the dialog displays instructions on how to use the "User Menu".

2. If you already have a saved user menu file on the instrument, you can load with "Recall User Menu".

Creating a user menu

To create your own user dialog with settings:

1. Open a dialog with settings you frequently use.
2. Select a parameter.
3. Open the context menu and select "Add to User Menu".



A favorites icon ★ indicates that the parameter is used in the "User Menu".

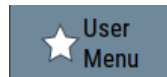

The "User Menu" button in the taskbar confirms that you have created a "User Menu" with at least one entry.

4. Press the [★ (User)] key.

The "User Menu" dialog shows all parameters that you have added to the list.

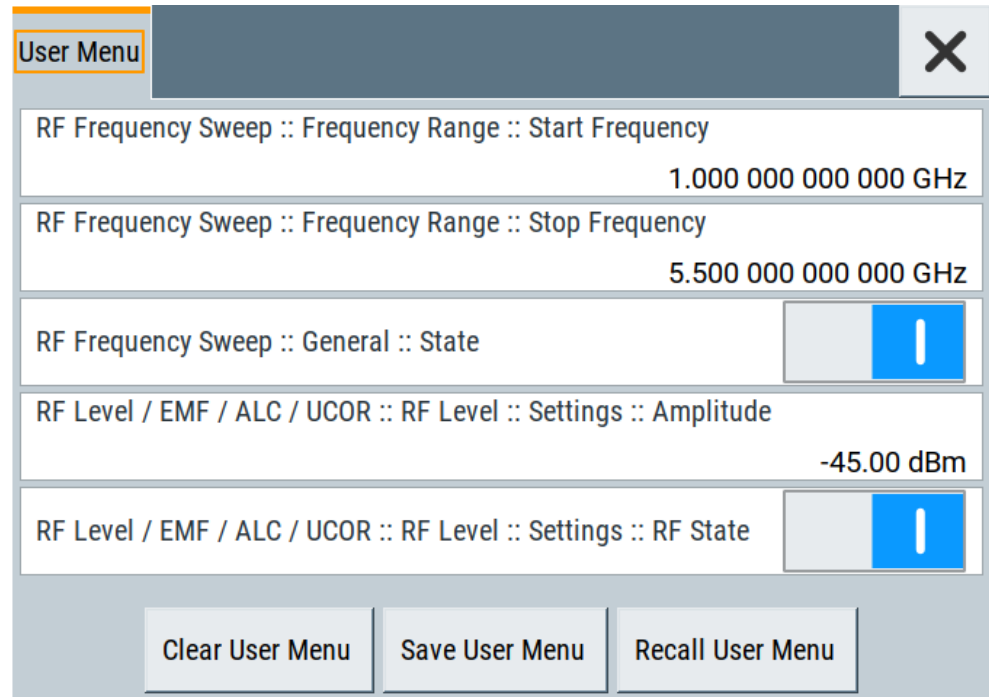

You can modify the parameter settings directly in this dialog, e.g. change a state or set values, as you do in the particular dialog the parameter originally belongs to.

5. To remove an entry, select the parameter either in the "User Menu" or in the dialog where it originally belongs to.
 - a) Open the context menu and select "Remove from User Menu".



6. To remove all entries at once, select "Clear User Menu".
7. To save your individual favorites list, select "Save User Menu", and follow the file managing instructions.
The file system automatically assigns the file extension *.user_menu.
8. To recall a previously saved user menu, select "Recall User Menu" and proceed accordingly.

Providing a user menu favorites list for several instruments

To transfer files from or to an instrument:

1. Create the favorites list, as described in ["Creating a user menu"](#) on page 462.
2. Save the favorites list.
3. To transfer a file from or to an instrument, the R&S SMCV100B provides several options, see ["File handling"](#) on page 415.

12.4.3 Define user key actions settings

Access:

- ▶ Select "System Configuration > Setup > User Interface > Define User Key".

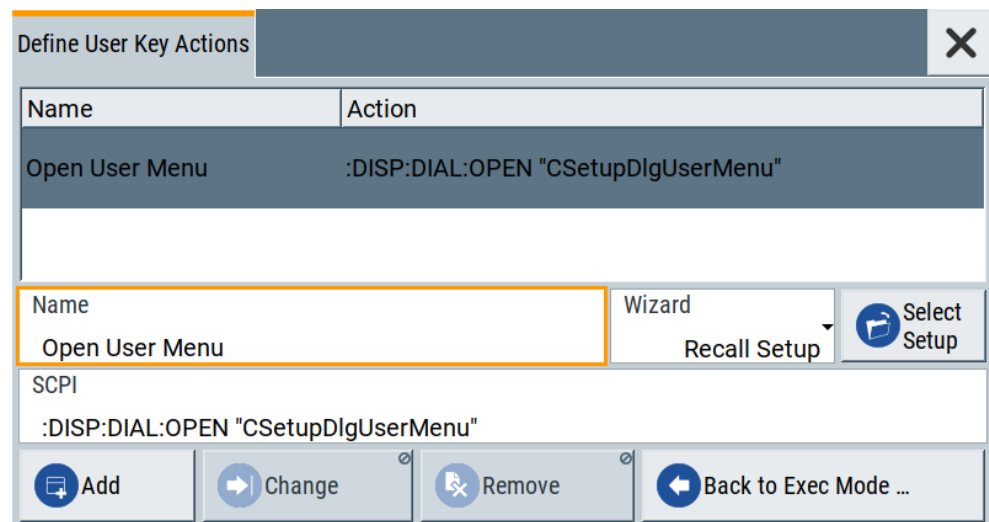

The dialog displays a list of the currently enabled actions and provides functions to define new, edit or remove existing actions. If no actions have been defined, the list is empty.

See [Chapter 12.4.4, "How to assign actions to the \[★ \(User\)\] key"](#), on page 465.

The remote commands required to define these settings are described in [Chapter 14.9, "DISPlay subsystem"](#), on page 606.

Name

Enters a user-defined name for the action.

Wizard

Defines the action to be executed.

"Load SCPI Script"

Selecting the action load and executes the SCPI script.

"Recall Setup" Load a setup for quick access to the user-defined settings.

Select

Depending on the selected "Wizard", provides access to:

- The standard "File Select" function for loading of an SCPI script or setup file
- A list of the dialog IDs of all currently opened dialogs. The dialog ID is used for dialog identification in the remote control.

See [SCPI](#).

SCPI

For the currently selected action, displays the corresponding SCPI command with the associated parameter for dialog identification (dialog ID). The automatically displayed SCPIs are enabled for subsequent modification.

Remote command:

[:DISPlay:DIALog:OPEN](#) on page 610

See also [:DISPlay:DIALog:ID?](#) on page 609

Add, Change, Remove

Standard functions for managing of the actions.

Back to Execute Mode

Opens the "Select Action to Execute" dialog. Select an Action from the list to execute it.

To return to the "Define User Key Actions" dialogs, select [Select Action to Execute > Define Actions](#).

Select Action to Execute > Define Actions

Accesses the "Define User Key Actions" dialog.

12.4.4 How to assign actions to the [★ (User)] key

The customizable [★ (User)] key has no predefined function assigned. You can individually define actions to be executed or functions to be accessed when pressing this key.

To assign a frequently used dialog to the [★ (User)] key:

1. Open the dialog you want to quickly access.
2. Select "System Configuration > Setup > User Interface > Define User Key".
3. To create an action:
 - a) Specify the "Name".
E.g. *OpenUcorImportExportList*.
 - b) Select "Wizard > Open Dialog"
 - c) Select "Select" and select the dialog ID from the list

The corresponding SCPI command is automatically displayed and can be later modified.

4. Select "Add" to store the new action in the list of user key actions.
5. To execute the created action, press ★ (User).

In the list of actions ("Select Action to Execute" dialog), navigate to the required action.

The R&S SMCV100B executes the action and opens the dialog.

12.5 Managing licenses and license keys

The R&S SMCV100B provides options for all required applications, as, e.g., for digital standards, you can purchase and activate.

Various license types enable you to manage licenses for options as follows:

- Activate an option locally on an instrument.

An option is ready to operate after it is enabled with a license keycode supplied with the option. The license key is delivered as a file or on paper. Unregistered licenses must be registered for a particular instrument before the corresponding option can be enabled for operation.



For reliable operation, a software option usually requires the latest firmware version. The required version is specified in the delivery. If your instrument works with a former firmware version, update the firmware before enabling the software option.

The firmware update is described in the release notes provided on the product page of the R&S SMCV100B.

12.5.1 Manage license keys settings

The "Manage License Keys" dialog provides all information on the available licenses. Instrument-related steps guide you through the process of registering or deactivating licenses.

Access:

1. Select "System Config > Setup > Instrument Assembly > Manage License Keys > Manage License Keys".

Manage License Keys | Installed License Keys | X

Device ID: 1432.7000K02-000000-VG

Enter License Key

Enter License Key: ** ** ** **

Import License Key From File ... | Export Deactivation Response To File ...

License Installation Info

In this tab, you can activate licenses for newly purchased or newly registered options.

2. Select "System Config > Setup > Instrument Assembly > Manage License Keys > Installed License Keys".

Export License Key To File	Option	License Count	License Type	Registrations
1 ...	<InstName>-Opt> 1	1	Permanent	
2 ...	<InstName>-Opt> 2	2	Permanent	
7 ...	<InstName>-Opt> 1	1	Timed (2160 h left)	
8 ...	<InstName>-Opt> 5	5	Floating	
9 ...	<InstName>-Opt> 50	50	Quantified (free 49)	Manage..

This tab lists all active options, with information on the available number of an option, the license type and registration. You can query inactive or disabled options also.

3. Select "Open License Server".
4. Select "Manage Waveform Packages".

Waveform	Registration Date	Used License(s)
1 drive:/path/MultiSegmentFilename_38969276.wv	2017-12-10 17:14:37	5
2 drive:/path/MultiSegmentFilename_663074699.wv	2018-09-17 05:57:18	6

This tab enables you to select and register purchased waveform packages.

The "Manage License Keys" dialog covers all required parameters for activating or deactivating newly purchased or newly registered options, and provides access to the onboard license server, see [Chapter 12.5.2, "Using the license server"](#), on page 470.

Settings

Device ID.....	468
Enter License Key.....	468
Import License Key from File.....	468
Export Deactivation Response to File.....	468
License Installation Info.....	468
Installed License Keys.....	468
L Show Inactive.....	469
L Show Deactivated.....	469
L Installed License Keys Table.....	469
Open License Server.....	469
Manage Waveform Packages.....	469
L Number of Licenses/Waveforms.....	470
L Select Waveform.....	470
L Register Selected Waveform.....	470
L License Table.....	470

Device ID

Displays the instrument-specific identification number. The device ID is a unique string with the following structure:

```
<stock number>-<serial number>-<checksum>
```

Enter License Key

Type here the license key provided with the option.

For license keys delivered as a file, use [Import License Key from File....](#)

Import License Key from File...

Opens a dialog for selecting the file with the license key.

Use this function also to import the deactivation key file generated by the R&S License Manager online tool (see [How to move a portable license](#)).

Export Deactivation Response to File...

Exports the generated deactivation response key to a file and opens a file management dialog to save the file.

This key is required during the unregistration process, e.g. when you want to deinstall an option or have a portable option, which you want to register later on another instrument (see [How to move a portable license](#)).

License Installation Info

Indicates status information on the performed actions.

Installed License Keys

Access: select "System Config > Setup > Instrument Assembly > Manage License Keys > Installed License Keys".

Comprises information on the installed options.

Show Inactive ← Installed License Keys

Enables the display of the inactive (expired) licenses in the [Installed License Keys Table](#).

Show Deactivated ← Installed License Keys

Enables the display of the deactivated licenses in the [Installed License Keys Table](#).

See [How to move a portable license](#) for information on how to activate deactivated licenses.

Installed License Keys Table ← Installed License Keys

Shows information on the currently installed options.

"Export License Key to File"

Opens a dialog to save the generated license key file. This file is required during the unregistration process.

If you have a portable unregistered option, you can register it later on another instrument (see [How to move a portable license](#)).

"Option"

Displays the option short designation.

"License Count"

Displays the number of the licenses for the selected option key.

"License Type"

Displays the type of license.

A license type determines the common qualification application duration and the portability of a license. The following license types are provided: evaluation, permanent, portable, quantified, time-controlled with a duration of 1, 3, 6 or 12 months. A license can also be deactivated or expired.

For time limited licenses, the left time of applicability is displayed too.

"Registrations" (reserved for future use)**Open License Server**

Opens the R&S License Server of the R&S SMCV100B, see [Chapter 12.5.2, "Using the license server"](#), on page 470.

Manage Waveform Packages

Access: select "System Config > Setup > Instrument Assembly > Manage License Keys > Installed License Keys > Manage Waveform Packages".

Opens the "Manages Waveform Packages" dialog that enables you to register waveform files.

With a waveform packages license, the R&S SMCV100B can play a waveform file generated with the R&S WinIQSIM2 software, even if it is not equipped with the corresponding digital standard option for using R&S WinIQSIM2 (R&S SMCVB-K2xy/K4xy).

Note: One waveform packages license per waveform is required, and for multisegment waveforms, you need a license per segment.

Once registered license cannot be moved to another instrument.

A waveform packages license does not allow R&S SMCV100B to play waveforms of options R&S SMCVB-K256/-K352/-K353/-K354.

Number of Licenses/Waveforms ← Manage Waveform Packages

Displays the number of the available and used R&S SMCVB-K200 licenses.

Select Waveform ← Manage Waveform Packages

Opens a standard dialog to select the waveform to be registered.

Register Selected Waveform ← Manage Waveform Packages

Executes the registration.

License Table ← Manage Waveform Packages

Gives an overview of the registered waveforms, the registration date and the number of used licenses.

"Waveform" Displays the directory, path and file name of the waveform file.

"Registration Date"

Displays date and time of registration.

"Used License(s)"

Shows the number of licenses the waveform file requires.

12.5.2 Using the license server

The R&S SMCV100B now supports handling of software licenses using the license server from Rohde & Schwarz.

As a browser application you can access the R&S License Server either in a browser and also directly in the R&S SMCV100B. The onboard license server integrated in the instrument firmware has connection to a *local smartcard* memory. The local smartcard holds local licenses, i.e. licenses that are intended for use on this specific instrument.

NOTICE

Direct operation requires an external keyboard

The touch screen of the R&S SMCV100B does not support the complete GUI functionality of the R&S License Server.

Use an external keyboard when configuring the settings on the R&S SMCV100B directly.

As opposed to local licenses, the application also manages licenses referred to as *floating licenses*.

For managing floating licenses, the same license server application runs on a PC at customer's site. In this context referred to as *remote license server*, with connection to the customers memory, the *remote smart card*. The remote smartcard holds floating licenses, i.e. licenses you can use on instruments everywhere without restrictions on the location.

When you need a specific application, you can obtain a license from the server. When you no longer need the license, return it to the server.



The license server releases a returned floating license for use in another instrument only after a follow-up time of 10 minutes.

At startup, the license server checks the available floating licenses. During this check, it returns the licenses immediately.



The floating license server application is part of the configuration at purchase. Included in delivery, you get an installation package that consists of a smart card dongle with the software and the corresponding user documentation.

To open the license server

Access:

1. Select "System Config > Setup > Instrument Assembly > Manage License Keys > Installed License Keys".

Export License Key To File	Option	License Count	License Type	Registrations
1 ...	<InstName>-Opt>	1	Permanent	
2 ...	<InstName>-Opt>	2	Portable	
7 ...	<InstName>-Opt>	1	Timed (2160 h left)	
8 ...	<InstName>-Opt>	5	Floating	
9 ...	<InstName>-Opt>	50	Quantified (free 49)	Manage..

2. Select "Open License Server".

The license server opens in a browser window and starts initially in the "Configuration" view for configuring floating license servers. It lists already configured floating license servers, with information on the host address, designation and state. You can add or remove a floating license server configuration and customize the information to be displayed. The control elements in the upper area enable you to access the "Analytics" or "Licenses" views.

The icons at the upper right lead you to information on the license server:

- "About": shows the software version.
- "User Manual": opens the embedded license server user manual.
- "Help": provides the functional description on a specific dialog and its settings.



For security reasons, the license server of the R&S SMCV100B enables you to restrict the access to the floating licenses from an external instrument.

For information on how to restrict the access to the connections, see ["To restrict remote connection access"](#) on page 477. To release a restriction, see ["To enable remote connection access"](#) on page 478.

For more information, see the user manual of the license server.

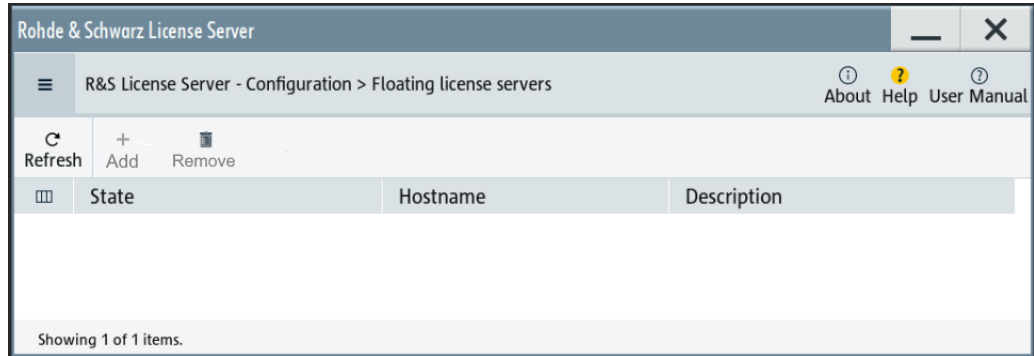

Short glance at the main views

The section provides a brief insight into the main windows of the license server. For details and handling of the application, refer to the embedded user documentation.



1. To access a view, select the menu button.
2. Select "Configuration".

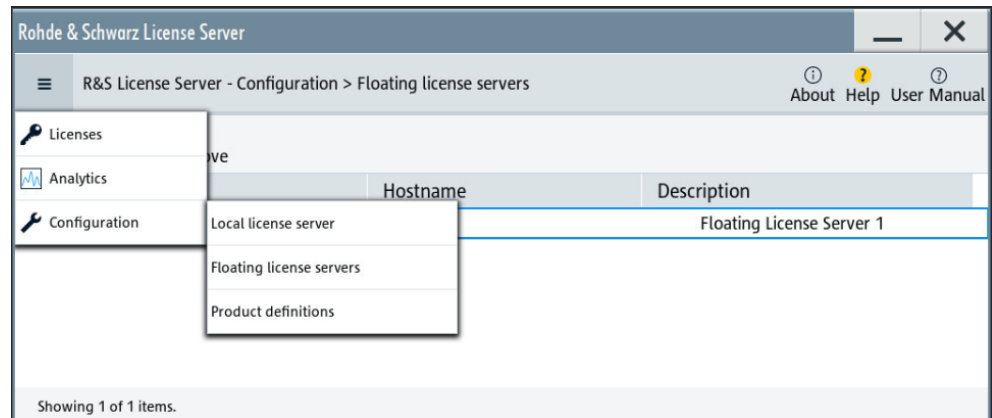

Figure 12-2: Configuration menu

Accesses the configured license servers, access lists and installed product definitions.

- a) Select "Local license server".

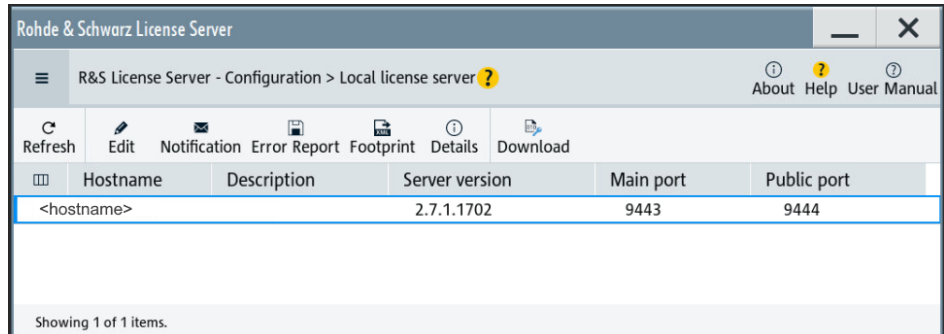

Figure 12-3: Example of a local license server view

Shows the onboard license server of the instrument. With the column selection, you can indicate or unhide characteristics of the available server. The task bar buttons provide access to the corresponding functions and access lists.

- b) Select "Floating license server".

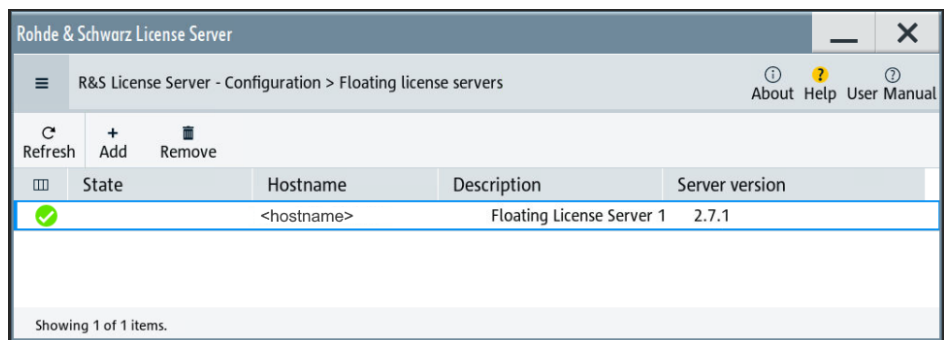

Figure 12-4: Example of a floating license server view

To add the connection to a floating license server, see ["To add a remote connection to an external license server"](#) on page 479.

- c) Select "Product definitions".

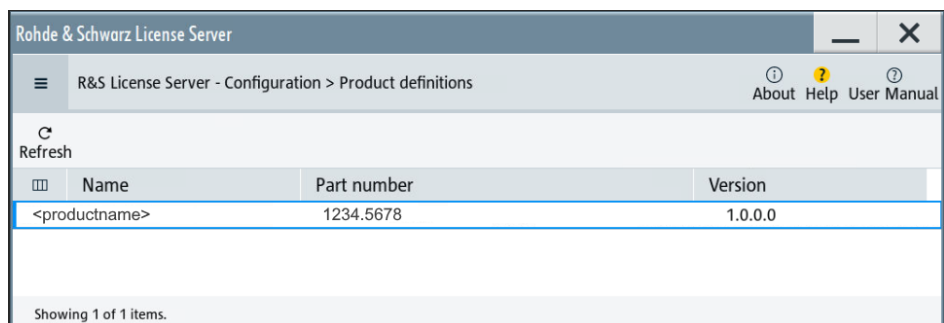

Figure 12-5: Example of a product definition view

Shows installed product definitions. To view the available characteristics, use the column selection.

3. Select "Licenses".

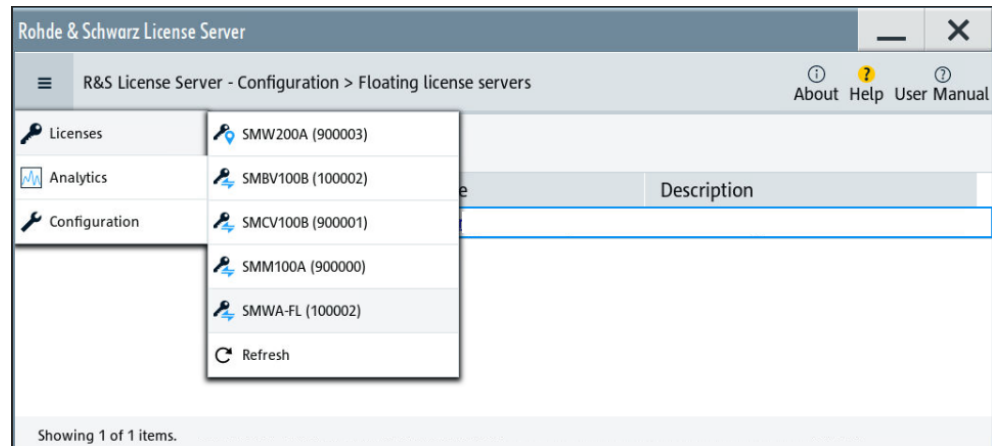

Figure 12-6: Licenses menu

Provides access to the available license servers.

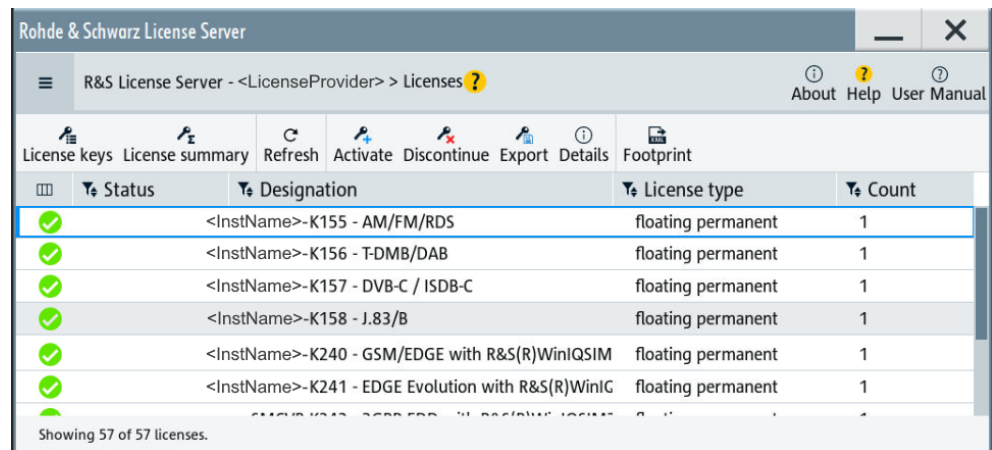

Figure 12-7: Example of a license list view

The "License keys" view lists the license key options that are available on the selected server. To show additional information, use the column selection.

The task bar functions enable you to activate or deactivate a license, to get details on an option and export license keys or information on the selected product.

4. Select "Analytics".

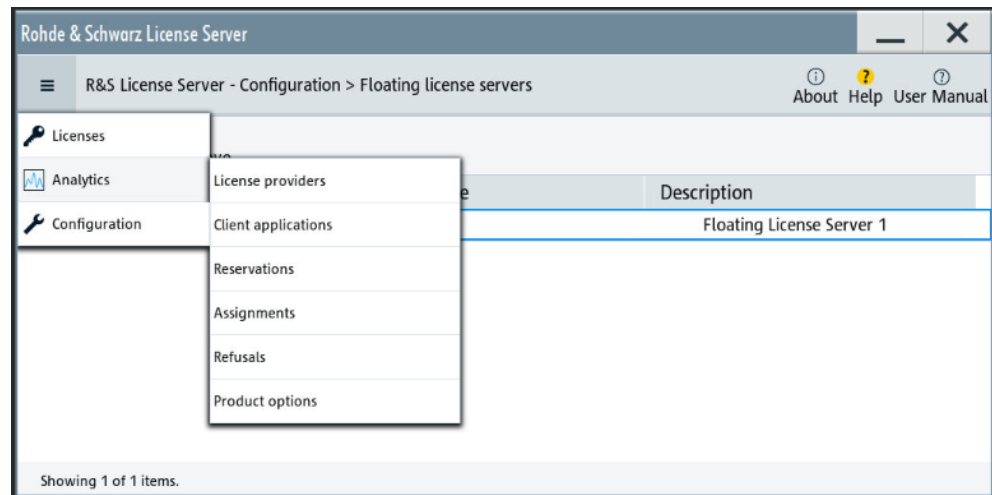

Figure 12-8: Analytics menu

Provides access to the license providers, client applications and enables you to export statistics data for evaluation in external applications.

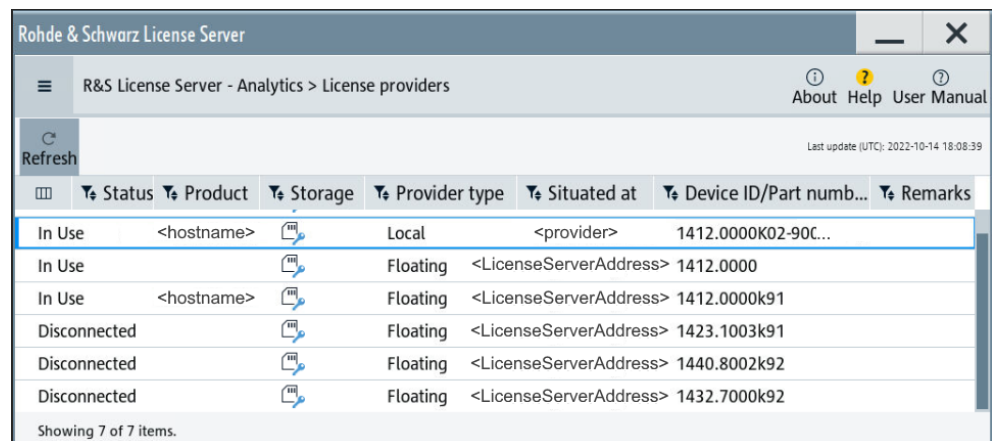

Figure 12-9: Example of the license providers view

Shows information on configured client applications, license providers and license types. To show additional information, use the column selection.

To manage licenses on the R&S SMCV100B

To request or return a license, proceed as follows:

1. Access: see ["To open the license server"](#) on page 471.
The browser application opens.
2. Select "Licenses"
3. Select a license server in the menu list, e.g. "R&S SMCV100B".
The "License keys" view lists the enabled options available on the selected server.
4. Select "Status" > "Select all" to list also options that are currently deactivated.

The "Licenses" view shows all active, inactive and time limited options.

5. To get detailed information on a specific option:
 - a) Select the option in the list.
 - b) In the task bar, select "Details".

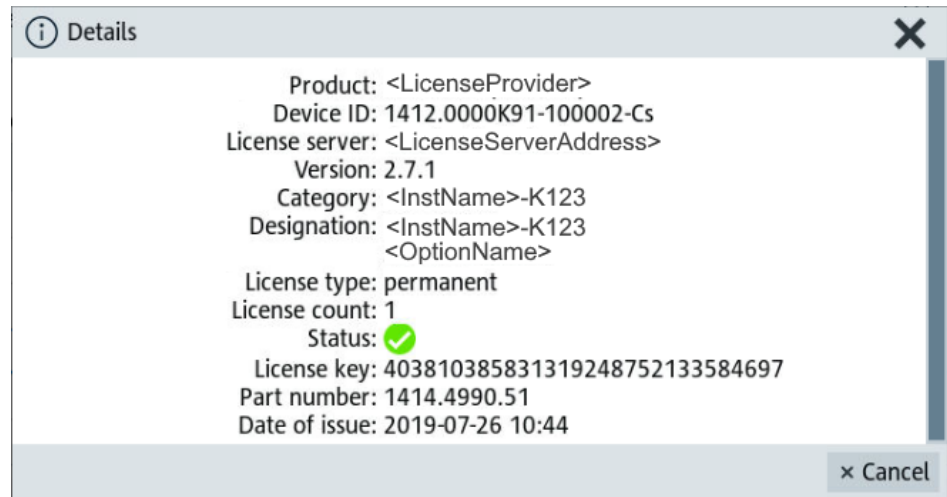
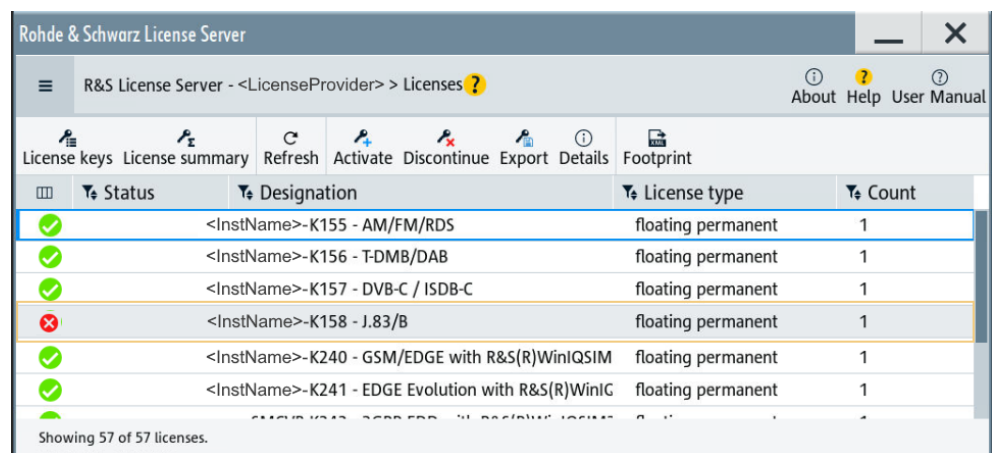

Figure 12-10: Example of the license characteristics of an option

6. To enable a discontinued license: , select in the taskbar.



- a) Select the license you want to activate.
 - b) In the task bar, select .
7. To return a license, proceed the same way:
 - a) Select the license.
 - b) Deactivate the license with .
8. Follow the instructions on the screen.

To restrict remote connection access

If you want to restrict the remote connection to the floating license server of the R&S SMCV100B, you can configure specific levels to prevent unauthorized access:

1. Open the license server as described in ["To open the license server"](#) on page 471. The onboard license server browser opens.
2. Select "Configuration" > "Local license server".
3. In the task bar, select "Edit".
4. Select the "Access options" tab.
5. Under "Remote Connection Restriction" restrict the access according to your requirements.

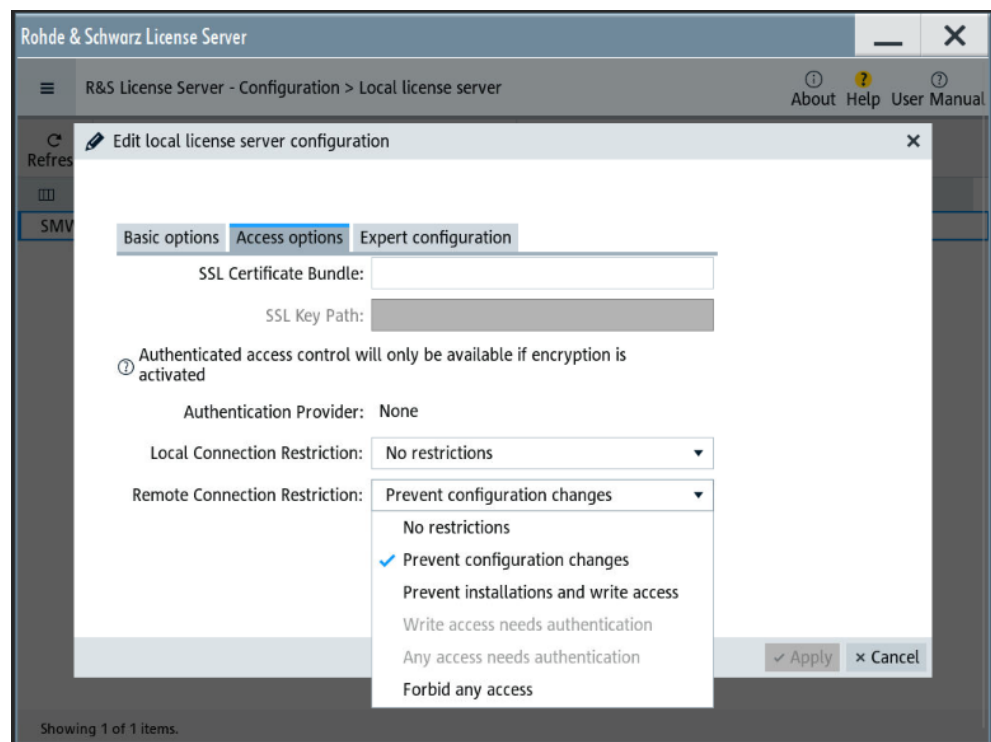

6. Confirm with "Apply" and close the dialog.

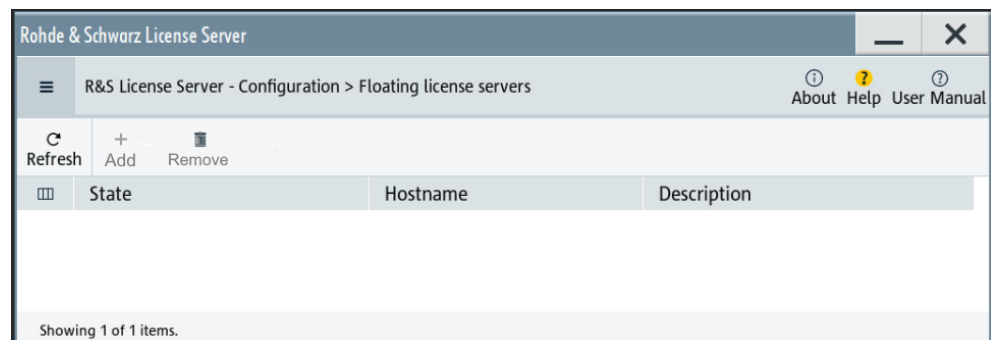

The R&S SMCV100B blocks the remote connection of an external floating license server. The "Add" and "Remove" buttons are disabled (grayed out).

The restriction also disables the remote access to the "Edit" mode of the local server. You can release the restricted access only directly on the instrument.

To enable remote connection access

If the remote connection to the floating license server is blocked, you can release the restriction or configure specific levels to prevent unauthorized access:

1. Open the license server as described in ["To open the license server"](#) on page 471.
The onboard license server browser opens.
2. Select "Configuration" > "Local license server".
3. In the task bar, select "Edit".
4. Select the "Access options" tab.
5. Under "Remote Connection Restriction" release the access according to your requirements.

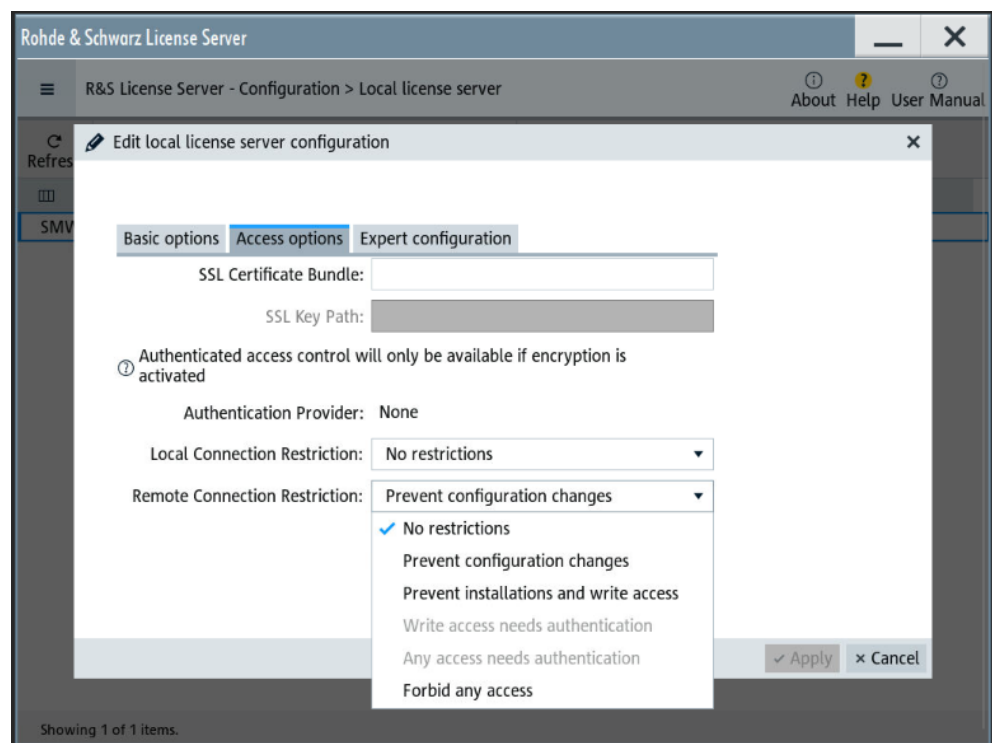

6. Confirm with "Apply" and close the dialog.
If your selection no longer restricts the access, you can assign a floating license server.
7. Select "Configuration" > "Floating license server".

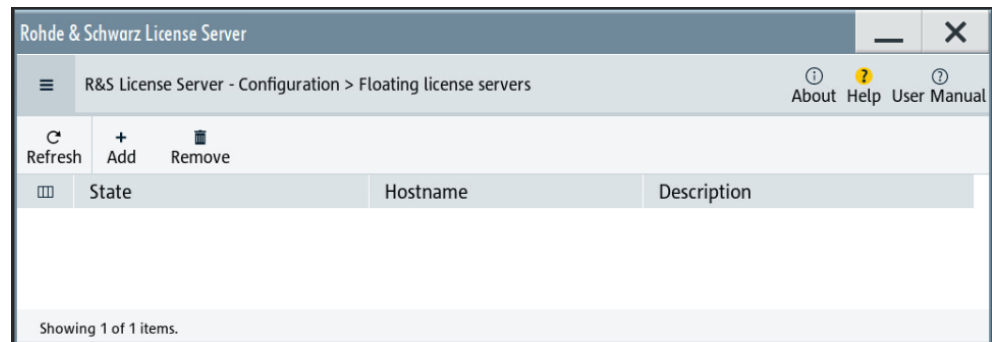

The "Add" and "Remove" buttons in the task bar are no longer blocked.

To add a remote connection to an external license server

1. Open the license server as described in "To open the license server" on page 471. The onboard license server browser opens.
2. Select "Configuration" > "Floating license server".
3. Select "Add".
4. Enter hostname and port of the license server you want to use.
5. Confirm with "Add".

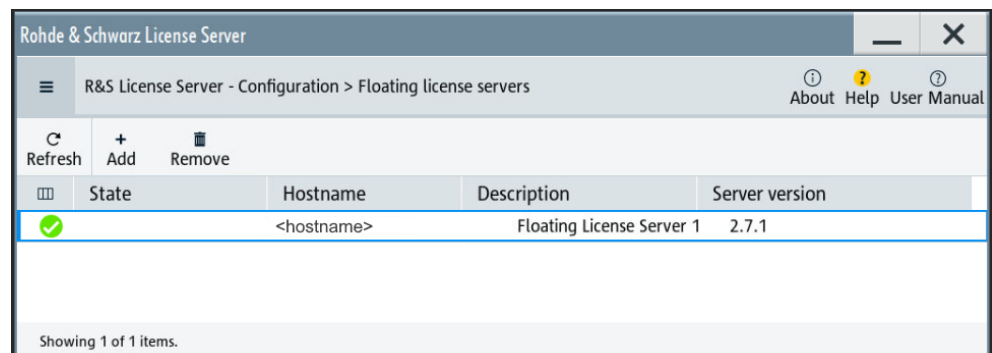

The access to the server is established.

12.5.3 How to move a portable license

This example is intended to explain how to perform the required steps at the instrument.

Use a USB flash drive to transfer the license key files between the instruments and the browser.



We assume knowledge about the handling of the R&S License Manager online tool and the description of the whole process.

1. Open your browser. Enter <https://extranet.rohde-schwarz.com/service>.

Select "Manage Licenses > Move Portable License".

The first step requires the Device IDs of the source and target instruments.

2. To find out the Device IDs, proceed as follows:
 - a) On the source instrument, select "System Config > Setup > Instrument Assembly > Manage License Keys > Manage License Keys > Device ID".

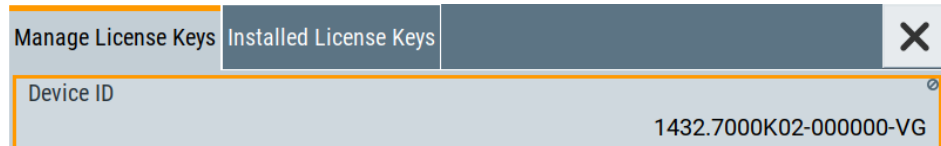

- b) On the target instrument, select "System Config > Setup > Instrument Assembly > Manage License Keys".
 - c) In the "Manage License Keys" tab, select "Device ID".
 - d) In the browser, select "Manage Licenses > Move Portable License > Select Devices".
 - e) Enter the Device IDs.
3. On the source instrument, select "System Config > Setup > Instrument Assembly > Manage License Keys > Installed License Keys > License Keys Table".
 - a) Navigate to the portable license that you want to move.
 - b) Select the "Export License to File" column.

A standard file manager dialog opens.

4. Enter a filename.
5. Save the exported license key, e.g. k123_portable_key_to_move.xml.
6. In the browser, select "Manage Licenses > Move Portable License > Select License (from file)":
 - a) Select the exported license key.
 - b) Check the selection.
 - c) Create the deactivation key.
 - d) Save it to file.
7. On the source instrument, select "System Config > Setup > Instrument Assembly > Manage License Keys > Manage License Keys > Import License Keys from File". Select the transferred deactivation key.
8. On the source instrument, select "System Config > Setup > Instrument Assembly > Manage License Keys > Manage License Keys > Export Deactivation Response to File".
9. In the browser, go to "Manage Licenses > Move Portable License > Install Deactivation Key (from file)".
10. Enter the deactivation response of the instrument.

The license is deactivated for the source instrument.

11. In the "Manage Licenses > Move Portable License", go to step "Create License" to generate a license key for this portable option and the selected target instrument.
 - a) Download the license key as a file.
 - b) Transfer it to the target instrument.
12. In the target instrument, select "System Config > Setup > Instrument Assembly > Manage License Keys > New License > Import License Keys from File".
13. Select the created license key file.

The portable option is installed on the target instrument.

12.6 Using the security settings

The protection function of the R&S SMCV100B offers several levels to activate particular functions like self-test or tests for service purposes specifically.

Protection

The five protection levels are automatically active on startup, the protection levels, that means all protected functions are locked.

To unlock a protection level:

- ▶ In the "System Config > Setup > Security > Protection", enter the correct password.

To lock a protection level:

- ▶ Clear the corresponding checkbox.

Protection levels

The following functions are protected in the respective levels:

- Protection level 1
Protects against accidental changes, like, for example, the clock and date, several internal adjustments functions and the self-test, as well as network settings or the instrument hostname.
You can access this level with the password 123456.
- Protection level 2
Unlocks protected service functions. It is accessible to authorized personnel of Rohde & Schwarz service department only.
- Protection level 3 to 5
Are reserved for internal use.

Security

The security concept of the R&S SMCV100B helps you to protect your instrument against uncontrolled access and changes. All provided security services require that you enter the security password.

Provided security services are:

- **General** security parameters, such as:
 - **USB storage** that secures controlled access to the mass memory of the instrument
 - **Volatile mode** that prevents information to be written to the internal memory permanently.
 - **Sanitizing** that prevents the instrument from leaving a secure environment with stored user information.
 - **Annotation** frequency and amplitude prevent reading the display.
 - **Secure Update Policy** check that verifies the integrity and origin of the firmware package to be installed.
To access the settings of these topics, see [Setting security parameters > "Secure Update Policy"](#) on page 484.
- **Password** management secures controlled user access to the instrument
With the two-step password concept, you can assign a user-defined password for the operating system, and a security password for accessing the mass storage of the instrument.
See also [Chapter 12.6.4, "Password management"](#), on page 491.
- **LAN services** secure controlled network access
You can individually lock and unlock supported LAN interface services. Also you can activate and deactivate SMB client and SMB server, that use versions 1.0 and 2.0 of the SMB protocol. See [Chapter 12.6.3, "Configuring LAN services"](#), on page 488.
Remote control via the LAN interface requires that the interface is activated. Once the interface is activated, enable or disable LAN services as needed.
- **User interface** prevents front panel operation and/or reading the display.

For more information, see the document R&S SMCV100B Instrument Security Procedures.

12.6.1 Protection level settings

Access:

- ▶ Select "System Config > Setup > Security > Protection".

Protection Level 1	<input checked="" type="checkbox"/>	Password	*****
Protection Level 2	<input checked="" type="checkbox"/>	Password	*****
Protection Level 3	<input checked="" type="checkbox"/>	Password	*****
Protection Level 4	<input checked="" type="checkbox"/>	Password	*****
Protection Level 5	<input checked="" type="checkbox"/>	Password	*****

The "Protection" dialog provides access to the unlocking of different protection levels.

Several functions in the instrument are password-protected to prevent for example accidental changes, "Protection" on page 481.

The remote commands required to unlock a protected stage are described in [Chapter 14.17, "SYSTem subsystem"](#), on page 808.

Protection Level/Password

Unlocks the selected level of protection, if you enter the correct password.

The default protection level 1 password is 123456.

To lock the protection level again, clear the checkbox.

Remote command:

`:SYSTem:PROTECT<ch>[:STATe]` on page 817

12.6.2 Setting security parameters

Access:

- ▶ Select "System Config > Setup > Security > Security > General".

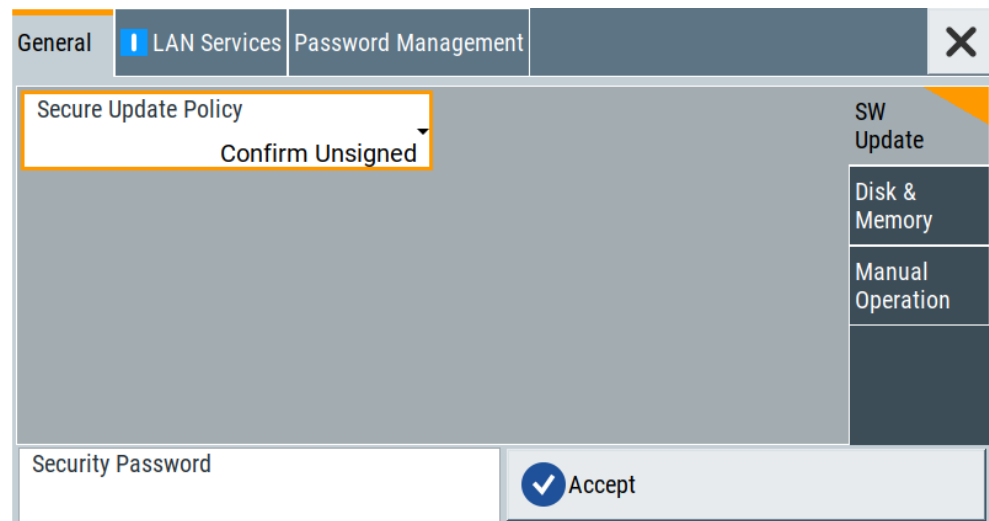

In the "General" tab, you can determine the security level for firmware updates, and configure the security settings for the mass memory and manual operation.



All modified settings in this dialog are not applied until you enter the [Security Password](#) and confirm with [Accept](#).

12.6.2.1 Update policy security settings

Access:

- ▶ Select "System Config > Setup > Security > Security > General > SW Update".

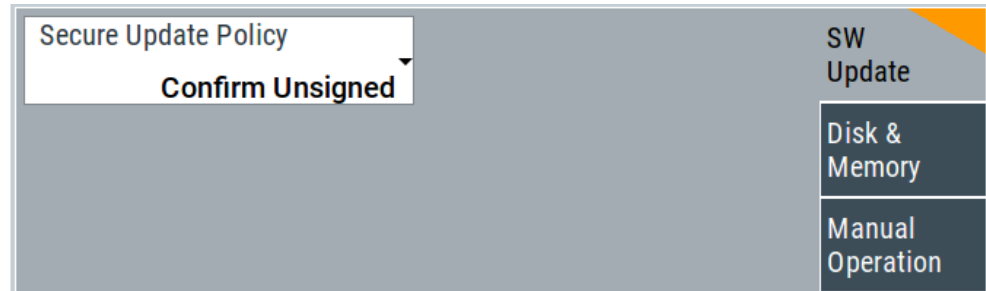

The SW Update tab enables you to select the security mode for firmware updates.

The remote commands available to control security settings are described in [Chapter 14.17, "SYSTEM subsystem"](#), on page 808.

Secure Update Policy

Allows you to configure the automatic signature verification for firmware installation.

To apply the change: enter the security password and confirm with "Accept". Otherwise the change has no effect.

See also:

- [Chapter 12.6, "Using the security settings"](#), on page 481 for more information on the security concept.
- The release notes for details on signature verification when installing new or former firmware versions, available at www.rohde-schwarz.com/firmware/smcv100b.

"Confirm Unsigned"

Performs the signature verification.

If the check detects any discrepancies, the instrument issues a warning message. You can still update the firmware or reject updating.

This setting also enables you to downgrade the firmware version.

"All Packages" Accepts all packages without signature verification.

"R&S Signed Packages"

Performs the signature check.

If the check detects any discrepancies, the instrument issues a warning message and locks the update to this firmware.

Remote command:

`:SYSTEM:SECURITY:SUPolicy` on page 824

12.6.2.2 Disk & memory security settings

Access:

- ▶ Select "System Config > Setup > Security > Security > General > Disk & Memory".

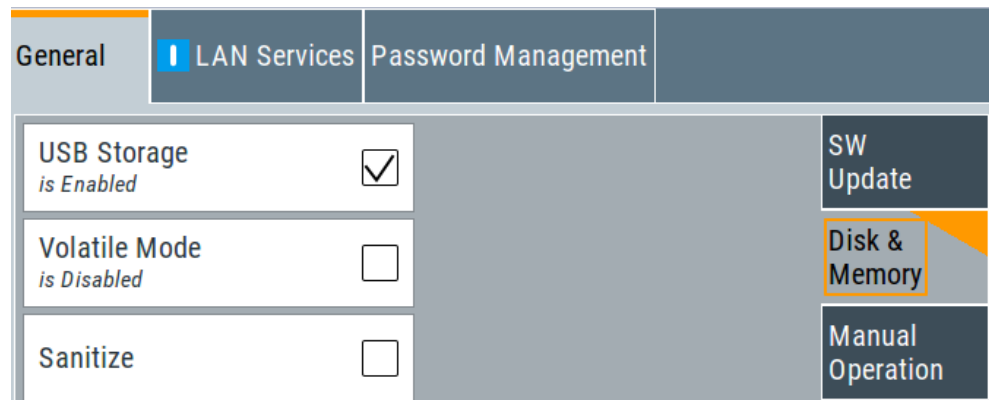

The "Disk & Memory" tab secures controlled access to the mass memory and prevents information from leaving a secure environment.

The remote commands available to control security settings are described in [Chapter 14.17, "SYSTem subsystem"](#), on page 808.

USB Storage

Activates the access to external USB storage media.

To apply the change: enter the security password and confirm with "Accept". Otherwise the change has no effect.

See also [Chapter 11.9.4, "Using a USB storage device for file transfer"](#), on page 439.

Note: Remove all USB memory devices before disabling the USB storage. If any USB memory device remains connected, disabling is blocked, and the instrument returns a warning message.

Volatile Mode

Activates volatile mode, so that no user data can be written on the internal memory permanently.

In volatile mode:

- Data that the instrument normally stores on the internal memory is redirected to volatile memory.
- The user directory is mapped to the volatile memory. You access the temporary data just as data stored in the `/var/user/`, see [Chapter 11.3, "Protecting data"](#), on page 420.
- Data on the internal memory cannot be changed. It is protected against modification or erasure.
- You can only save data:
 - Temporarily in the volatile memory
 - On a connected external storage device, such as a memory stick

To activate volatile mode: enter the security password, confirm with "Accept" and reboot the instrument. Otherwise the change has no effect.

Activated volatile mode is indicated by the icon .

Remote command:

`:SYSTem:SECurity:VOLMode[:STATe]` on page 818

Sanitize

Executes the erase procedure that sanitizes the internal memory.

The sanitizing function makes sure that no user information is stored on the instrument when it leaves the secure environment.

To apply the change: enter the security password and confirm with "Accept". Otherwise the change has no effect.

Note: If the instrument is subject to high security, and you have disabled volatile mode, the internal memory holds user-data, and thus poses a security risk.

See also [Chapter 12.6, "Using the security settings"](#), on page 481 for more information on the security concept.

Remote command:

`:SYSTem:SECurity:SANitize[:STATe]` on page 824

12.6.2.3 Manual operation security settings

Access:

- ▶ Select "System Config > Setup > Security > Security > General > Manual Operation".

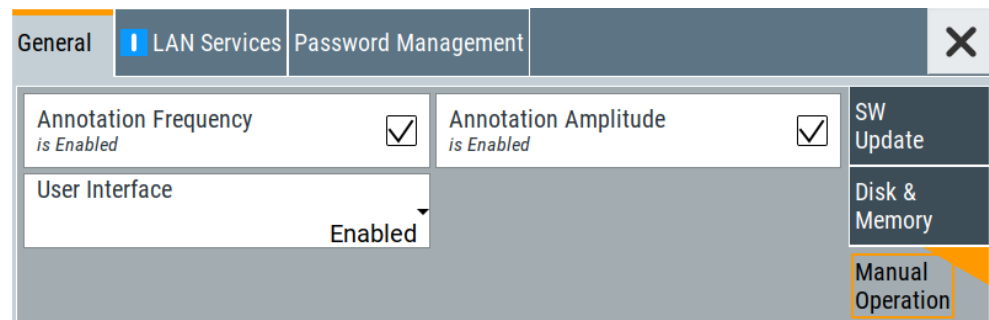

The "SW Update" tab enables you to lock front panel operation and/or reading the display.

The remote commands available to control security settings are described in:

- [Chapter 14.9, "DISPlay subsystem"](#), on page 606
- [Chapter 14.17, "SYSTem subsystem"](#), on page 808.

Annotation Frequency

Enables the display of the currently used frequency in the status bar.

How to: see ["Disabling the frequency and level indication in the status bar"](#) on page 495.

Remote command:

`:DISPlay:ANNotation:FREQuency` on page 609

Annotation Amplitude

Enables the display of the currently selected level in the status bar.

How to: see ["Disabling the frequency and level indication in the status bar"](#) on page 495.

Remote command:

:DISPlay:ANNotation:AMPLitude on page 608

User Interface

Allows you to lock the controls for manual operation and the display individually.

How to: see ["Deactivating the user interface"](#) on page 495.

See also [Chapter 12.6, "Using the security settings"](#), on page 481.

"Enabled" Enables the display and all controls for the manual operation of the instrument.

"Touchscreen Off"

Locks the touch sensitivity of the screen.

This security feature protects the instrument against unintentional change of settings by accidentally touching of the screen.

Still available controls for manual operation are:

- The keys at the front panel, including the rotary knob
- The external mouse and keyboard
- Remote operation over VNC

The instrument indicates the locked touchscreen by an icon .

Unlocking is possible via VNC, external controls or remote control.

"VNC Only"

Locks the keys at the front panel, the touchscreen and externally connected keyboard and mouse.

The display on the screen remains and shows the current settings and changes.

The instrument indicates the activated "VNC only" feature by the icon .

Unlocking is possible via VNC or turning off and on again.

"Display Only"

Locks the manual operation of the instrument. The display on the screen remains and shows the current settings and changes.

This security feature protects the instrument against unauthorized access, but still shows the current settings and processes, for example when you operate the instrument via remote control.

The function disables:

- The touchscreen functionality of the display
- The keys at the front panel of the instrument
- The external mouse and keyboard

The instrument indicates the locked controls by a padlock  softkey.

How to unlock: see ["Unlocking \(reactivating\) the user interface for manual operation"](#) on page 496.

"Disabled" Locks the display and all controls for the manual operation of the instrument.
This security feature protects the instrument against unauthorized reading and access, for example when you operate the instrument via remote control.
The function disables:

- The display
- The touchscreen
- The keys at the front panel of the instrument
- The external mouse and keyboard

The screen shuts off and displays a padlock symbol  instead.
How to unlock: see ["Unlocking \(reactivating\) the user interface for manual operation"](#) on page 496.

Remote command:

:SYSTem:ULOCK on page 816

:SYSTem:DLOCK on page 815

:SYSTem:KLOCK on page 815

Enabling a locked user interface for manual operation

Follow the instructions listed in ["Unlocking \(reactivating\) the user interface for manual operation"](#) on page 496.

Remote command:

:SYSTem:ULOCK on page 816

:SYSTem:DLOCK on page 815

:SYSTem:KLOCK on page 815

12.6.3 Configuring LAN services

Access:

1. Select "System Config > Setup > Security > Security > LAN Services > Main Services".

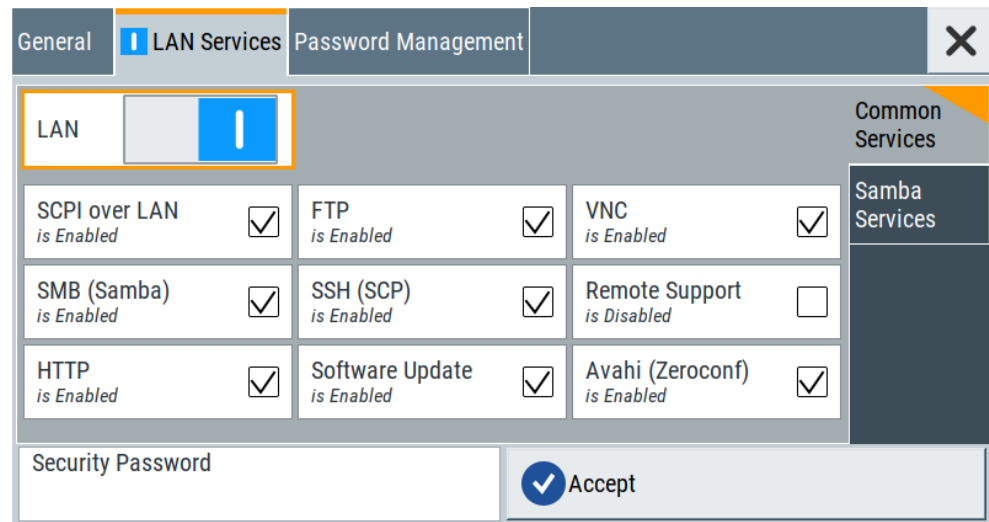

In the "Main Services" side tab, you can individually enable or disable the supported LAN interface services.

2. Select "System Config > Setup > Security > Security > LAN Services > Samba Services".

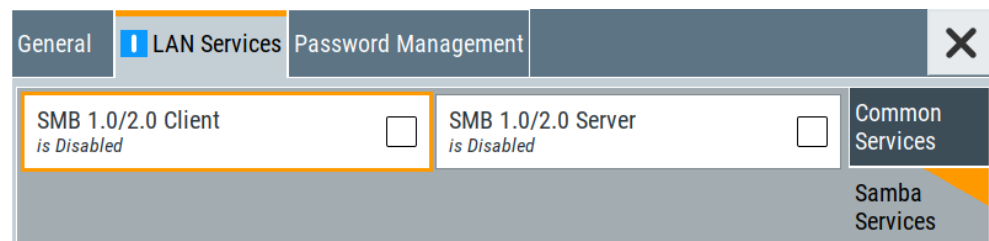

In the "Samba Services" side tab, you can activate older versions of the SMB client and SMB server.

How to:

- ["Disabling the LAN interface"](#) on page 494
- ["Disabling LAN services"](#) on page 495
- ["Activating SMB version 1.0/2.0 client and server"](#) on page 495

Common Services

Enable or disable the LAN interface and supported LAN interface services.

LAN ← Common Services

Enables the LAN interface in general, and thus provides remote access via all unlocked services.

Enable LAN Services individually ← Common Services

Enables or disables the following interface services individually.

"SCPI over LAN"	Activates access over LAN to control the instrument remotely, by using SCPI (Standard Commands for Programmable Instruments) commands. See also "To start remote control with R&S VISA" on page 551.
"VNC"	Activates access over VNC (Virtual Network Computing) interface, a graphical desktop sharing system that uses RFB protocol to control the instrument remotely. See also Chapter 13.12, "To operate the instrument using VNC" , on page 565.
"SSH (SCP)"	Activates access over SSH (Secure Shell), a network protocol for secure data communication.
"Remote Support"	Activates remote support over SSH. Per default, this service is disabled. It provides communication for service support purposes only.
"HTTP"	Activates access via HTTP (Hyper Text Transfer Protocol), the application protocol for hypermedia information systems.
"FTP"	Activates access over FTP (File Transfer Protocol), used to transfer files from a host to the instrument and vice versa. See also Chapter 11.9.2, "Accessing the file system of the R&S SMCV100B over FTP" , on page 436.
"SMB (Samba)"	Activates access to SMB (Server Message Block), used for providing shared access to files, printers and serial ports of a network. See also Chapter 11.9.3, "Accessing the R&S SMCV100B file system using SMB (Samba)" , on page 437.
"Avahi (Zeroconf)"	Activates Avahi, a service for automatic configuration of the instrument in a network environment.
"Software Update"	Allows updating the software.

Samba Services

Activate or deactivate support of SMB client and SMB server version 1.0 and 2.0 of the SMB protocol.

Support of version 1.0 and 2.0 is additional to the current SMB protocol version supported in the firmware. This firmware supports SMB protocol up to version 3.1.1.

SMB 1.0/2.0 Client ← Samba Services

Activates support of the SMB client compatible with SMB protocol versions 1.0 and 2.0.

SMB 1.0/2.0 Server ← Samba Services

Activates support of the SMB server compatible with SMB protocol versions 1.0 and 2.0.

Security Password

Enters the password that is required to enable or to disable the settings protected by a security password. Default is 123456.

How to:

- "Disabling the LAN interface" on page 494
- "Disabling LAN services" on page 495
- "Changing the default security password" on page 494.

Accept

Applies the modified settings, provided the security password is entered and correct.

12.6.4 Password management

Access:

1. Select "System Config > Setup > Security > Security > Password Management > User Password".

General	LAN Services	Password Management
Valid for VNC, FTP and SMB (Samba) access		
User Name		User Password
instrument		Security Password
Old Password		
New Password		
Confirm Password		
		Change Password

In this tab, you can assign the security and a user-defined password.

2. Select "System Config > Setup > Security > Security > Password Management > Security Password".

General	LAN Services	Password Management	
Old Password		User Password	
New Password		Security Password	
Confirm Password			
		 Change Password	

How to:

- ["Changing the default user password of the instrument"](#) on page 494.
- ["Changing the default security password"](#) on page 494.

User Name

Indicates the user name used for access to the Linux operating system and valid for VNC, FTP and SMB (Samba) access.

User Password

Access: select "System Config > Setup > Security > Security > Password Management > User Password".

Allows you to change and confirm the user password.

Old Password ← User Password

Enters the current user password. The default password is "instrument".

Note: We recommend that you change the default password before connecting the instrument to a network.

How to:

- ["Changing the default user password of the instrument"](#) on page 494.
- ["Changing the default security password"](#) on page 494.

Note: Note that you cannot reset the password to factory state.

If you encounter problems with the password, contact the Rohde & Schwarz customer support, see [Chapter 15.10, "Contacting customer support"](#), on page 852.

New Password ← User Password

Enters the new user password.

The security password can contain decimal characters only.

Confirm Password ← User Password

Confirms the new user password by repeating.

How to:

- ["Changing the default user password of the instrument"](#) on page 494.

- ["Changing the default security password"](#) on page 494.

Change Password ← User Password

Changes the user password accordingly.

Security Password

Access: select "System Config > Setup > Security > Security > Password Management > Security Password".

Enables you to change and confirm the security password.

Old Password ← Security Password

Enters the currently used security password. The default password is '123456'.

Note: We recommend that you change the default password before connecting the instrument to a network.

How to:

- ["Changing the default user password of the instrument"](#) on page 494.
- ["Changing the default security password"](#) on page 494.

The security password is required when changing the status of the USB and LAN interface or other security settings.

Note: Note that you cannot reset the password to factory state.

If you encounter problems with the password, contact the Rohde & Schwarz customer support, see [Chapter 15.10, "Contacting customer support"](#), on page 852.

New Password ← Security Password

Enters the new security password.

The security password can contain decimal characters only.

Confirm Password ← Security Password

Confirms the new security password by repeating.

How to:

- ["Changing the default user password of the instrument"](#) on page 494.
- ["Changing the default security password"](#) on page 494.

Change Password ← Security Password

Changes the password accordingly.

12.6.5 How to prevent unauthorized access

The default computer name and user password are *instrument*. The user password is the password required for VNC, FTP and SMB (samba) connections. If, for example, the VNC service or FTP are enabled, anyone in the network who knows the computer name and user password of the instrument can access it.

The default security password is 123456. The security password is required when changing the status of the USB and LAN interface.

To prevent unauthorized access, use the following configurations exclusively or complementary:

- ["Changing the default user password of the instrument"](#) on page 494
- ["Changing the default security password"](#) on page 494
- ["Disabling the LAN interface"](#) on page 494
- ["Disabling LAN services"](#) on page 495
- ["Activating SMB version 1.0/2.0 client and server"](#) on page 495
- ["Disabling the frequency and level indication in the status bar"](#) on page 495
- ["Deactivating the user interface"](#) on page 495

If security is a concern, see the document instrument security procedures for comprehensive description.

Changing the default user password of the instrument

- ▶ **Note:** We recommend that you change the default password before connecting the instrument to a network.

How to:

- ["Changing the default user password of the instrument"](#) on page 494.
 - ["Changing the default security password"](#) on page 494.
- a) Select "System Config > Setup > Security > Security > Password Management > User Password".
 - b) Enter the current password in the "Old Password" field.
 - c) Enter the new password in the "New Password" and "Confirm Password" fields.
 - d) Select "Change Password".

The user password is changed; the user name is displayed ("Security > Password Management > User Password > User Name").

Changing the default security password

- ▶ **Note:** We recommend that you change the default password before connecting the instrument to a network.

How to:

- ["Changing the default user password of the instrument"](#) on page 494.
 - ["Changing the default security password"](#) on page 494.
- a) Select "System Config > Setup > Security > Security > Password Management > Security Password".
 - b) Enter the current password in the "Old Password" field.
The default password is *123456*.
 - c) Enter the new password in the "New Password" and "Confirm Password" fields.
 - d) Select "Change Password".

Disabling the LAN interface

1. Select "System Config > Setup > Security > Security > LAN Services > Main Services".

2. Select "LAN > Off".

All LAN connections and hence all LAN services are disabled.

Disabling LAN services

1. Select "System Config > Setup > Security > Security > LAN Services > Main Services".
2. Select, for example, "FTP > Off" or "VNC > Off".
3. Enter the [Security Password](#).
4. Select "Accept".

Activating SMB version 1.0/2.0 client and server

By default, support of SMB client and SMB server of the SMB protocol versions 1.0 and 2.0 is deactivated.

Activate support only, if needed:

1. Select "System Config > Setup > Security > Security > LAN Services > Samba Services".
2. Select "SMB 1.0/2.0 Client > On" and "SMB 1.0/2.0 Server > On".
3. Enter the [Security Password](#).
4. Select "Accept".

Disabling the frequency and level indication in the status bar

These settings are useful to prevent unauthorized personnel from reading the display, when you remotely control the instrument from a different location.

1. Select "System Config > Setup > Security > General > Manual Operation".
2. Select "Annotation Frequency > Off" or "Annotation Amplitude > Off".
3. Enter the [Security Password](#).
4. Select "Accept".

Deactivating the user interface

1. Select "System Config > Setup > Security > General > Manual Operation".
2. Select "User Interface > Disabled".
3. Enter the [Security Password](#).
4. Select "Accept".

The screen shuts off and displays a padlock symbol  instead.

There are further possible configurations. For details, see "[User Interface](#)" on page 487.

Unlocking (reactivating) the user interface for manual operation

1. In manual operation:
 - a) On the instrument's keypad or external keyboard, press any key.
The instrument prompts you to enter the security password for unlocking.

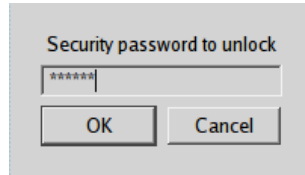

If you press the character of the first key, the input field accepts the character immediately.

- b) Delete the entry before inserting the password.
Enter the security password `123456`.
2. In remote control mode:
 - a) Send the command `SYST:ULOC ENABled` to release all locks at once.
 - b) Send the command `SYST:KLOC OFF` to unlock the keyboard and touchscreen.
 - c) Send the command `SYST:DLOC OFF` to release all locks.

Via remote control, there is no password required.

12.7 Undoing or restoring actions

"Undo" is a function that removes the effect of the last action on the instrument and reverts it to an older state. Conversely, "Redo" restores a previously undone action.

You can "Undo/Redo" actions according to two criteria:

- Step by step
Gradually undo/redo the actions in reverse order as previously performed.
Depending on the available memory the "Undo/Redo" steps may restore all actions.
- Multiple steps at once
Select any specific action in the history list to "Undo/Redo" multiple actions in a single step.
Note: This mode requires a system restoration file on the instrument.

Access:

- ▶ Select "Setup > Settings > Undo/Redo".

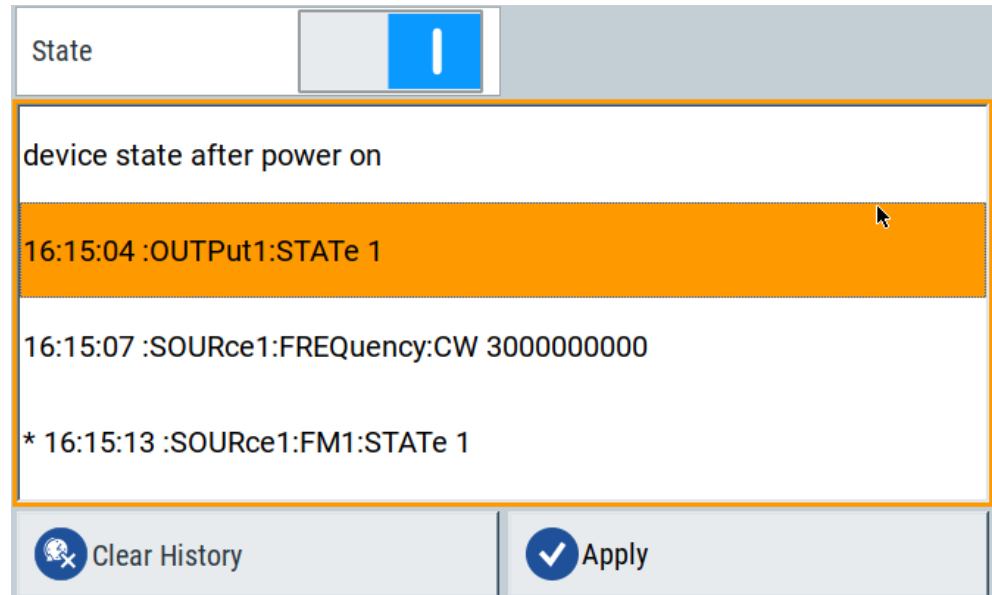

The dialog contains all functions for enabling the "Undo/Redo" functionality.

Settings:

State.....	497
History List.....	497
Clear History.....	497
Apply.....	497

State

Enables the recording of the performed actions.

History List

Lists the performed actions, provided "Undo/Redo" state is "On".

Clear History

Deletes the recorded list of the performed steps.

Apply

Performs the "Undo/Redo".

If you select a previously performed action of the list, all subsequent actions are undone. The list entries remain.

If you select a subsequently executed action, you can restore all the actions undone up to this state.

12.8 Shutting down and rebooting the instrument

On the front panel, the [On/Standby] key switches the instrument from the standby to the ready state or vice versa. In remote operation from a remote computer or in manual control, there is another possibility to shut down the instrument or to reboot the system.

Access:

- ▶ Select "System Config > Setup > Maintenance > Shut down".



Remote control commands:

- `:SYSTEM:REBoot` on page 831
- `:SYSTEM:SHUTdown` on page 831

13 Network operation and remote control

As an alternative to the interactive operation directly at the instrument, you can operate the R&S SMCV100B also from a remote location.

The various interfaces provide flexible access to the instrument, such as *remote control*, *remote operation* or *remote file access*. These remote access modes are fundamentally different, although they are often considered interchangeable, as described in [Overview of remote access modes](#).

[Figure 13-1](#) shows the possibilities of the physical connection (interfaces) for remote access.



The following descriptions provide information required for operating the R&S SMCV100B remotely. The information applies to all applications and operating modes supported by the instrument. Definitions specified in the SCPI standard are not provided.

For basic knowledge on remote control operation and additional information, see the following documents, available on the Rohde & Schwarz website:

- [Remote control via SCPI](#)
- [1GP72: Connectivity of Rohde&Schwarz Signal Generators](#)
- [1MA208: Fast Remote Instrument Control with HiSLIP](#)

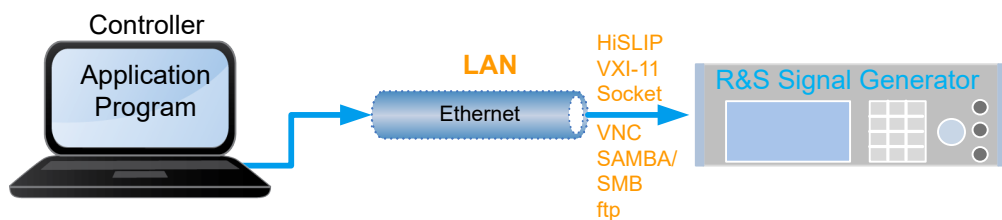

Figure 13-1: Supported remote connections

• Overview of remote access modes	500
• Remote control interfaces and protocols	501
• Remote control programs and libraries	504
• Status reporting system	507
• Remote access settings	516
• LXI settings	536
• To configure the instrument for remote access	543
• To establish a remote control session over LAN	547
• To trace messages with the LXI web browser interface	554
• To return to manual operation	555
• To automate tasks with remote command scripts	555
• To operate the instrument using VNC	565
• References	571

13.1 Overview of remote access modes

This section outlines the possible access modes and their major characteristics.

Remote control (SCPI)

- A remote PC controls the instrument, usually via VISA (Virtual Instrument Software Architecture) interfaces.
- Remote control disables the manual operation of the instrument; you can set different lock states.
- The GUI is not visible.
- Remote control commands (SCPI) perform the settings, either individually or in sequences (SCPI programs).
- Using SCPI programs is faster than the manual operation, since they automate repeating applications.

Remote operation (VNC)

- A remote device accesses the instrument via the common platform technology VNC (Virtual Network Computing).
- The protocol allows simultaneous operation from several remote devices and the instrument nevertheless remains locally operable.
- The GUI is visible.
- To perform the settings, you can operate the instrument as with the manual control.
- During remote operation via VNC, the direct control of the instrument is not disabled.
You can control the instrument from the front panel and via the remote computer alternately.
- Clients supporting remote operation depend on the used remote device, see [Table 13-1](#).
- How to: see [Chapter 13.12, "To operate the instrument using VNC"](#), on page 565.

Table 13-1: Supported VNC operation modes

Remote device	VNC client	Requirements	Characteristics
Desktop (Windows, Linux, Mac™OS)	<ul style="list-style-type: none"> • Ultr@VNC • Other dedicated client software 	<i>Ultr@VNC or Client Software</i> must be installed.	Fast, supports several options like full screen mode or auto-login.
	<ul style="list-style-type: none"> • Any web browser 	<i>Java Runtime</i> must be installed and activated in the browser settings.	Fast and convenient - only the instrument address required. Java runtime is sometimes considered as security concern.
	<ul style="list-style-type: none"> • Web browser with HTML5 	<i>Web sockets</i> must be supported.	Slower than the other modes. No additional installation or activation required. No security concern.

Remote device	VNC client	Requirements	Characteristics
Smart device (Tablet/ smartphone)	<ul style="list-style-type: none"> Dedicated client App 	App must be installed.	Fast, supports several options like full screen mode or auto-login.
	<ul style="list-style-type: none"> Web browser with HTML5 	Web sockets must be supported.	Support of QR code scanning Slower than a dedicated App.

Remote file access (FTP, SAMBA/SMB)

- A remote client accesses the instrument's file system, using the protocols FTP (file transfer protocol) and SAMBA/SMB (server message block).
- The protocols enable you to transfer files from or to the instrument and to get direct access to its file sharing directory *share*.

How to:

[Chapter 11.9, "How to transfer files from and to the instrument"](#), on page 434.

["Activating SMB version 1.0/2.0 client and server"](#) on page 495

13.2 Remote control interfaces and protocols

The instrument supports various interfaces for remote control. [Table 13-2](#) gives an overview on the connectivity:

Table 13-2: Remote control interfaces and protocols

Interface	Protocols, VISA ^{*)} address string and library	Remarks
Local area network (LAN)	<ul style="list-style-type: none"> HiSLIP High-Speed LAN Instrument Protocol (IVI-6.1) TCPIP::host address::hislip0[::INSTR] VISA VXI-11 TCPIP::host address[:: LAN device name][::INSTR] VISA Socket communication (Raw Ethernet, simple Telnet) TCPIP::host address[:: LAN device name]::<port>::SOCKET VISA or socket controller 	<p>The LAN connector is at the rear panel of the instrument.</p> <p>The interface is based on TCP/IP, see Chapter 13.2.1, "LAN interface", on page 502 for details on the address information.</p>

^{*)} VISA (Virtual Instrument Software Architecture) is a standardized software interface library providing input and output functions to communicate with instruments. A VISA installation on the controller is prerequisite for remote control over LAN (when using VXI-11 or HiSLIP protocol). With socket communication, VISA installation is optional. For basic information, see [Remote control via SCPI](#).



<http://www.rohde-schwarz.com/rsvisa> provides the standardized I/O software library R&S VISA for download at the Rohde & Schwarz website <http://www.rohde-schwarz.com/rsvisa>.

How to: [Chapter 13.8, "To establish a remote control session over LAN"](#), on page 547 describes how to configure the remote control interfaces.

- [LAN interface](#)..... 502
- [LXI browser interface](#)..... 503

13.2.1 LAN interface

To be integrated in a LAN, the instrument is equipped with a LAN interface, consisting of a connector, a network interface card and protocols.

For remote control, the PC and the instrument must be connected over the LAN interfaces to a common network with TCP/IP network protocol. The instruments are connected using a commercial RJ45 cable (shielded or unshielded twisted-pair category 5). The TCP/IP network protocol and the associated network services are preconfigured on the instrument. Software for instrument control and, if necessary, the VISA program library must be installed on the controller.



Identifying instruments in a network

If several instruments are connected to the network, each instrument has its own IP address and associated resource string. The controller identifies these instruments by the resource string.

13.2.1.1 VISA resource strings

The VISA resource string is required to establish a communication session between the controller and the instrument in the LAN. The resource string is a unique identifier, composed of the specific IP address of the instrument and some network and VISA-specific keywords.

`TCPIP::::<LAN device name>[:INSTR]`

TCPIP	= designates the network protocol
host address	= designates the IP address or hostname of the instrument
[:LAN device name]	= defines the protocol and the instance number of a subinstrument
[:INSTR]	= indicates the instrument resource class (optional)

The **IP address** (host address/computer name) is used by the programs to identify and control the instrument. It is automatically assigned by the DHCP server the first time the device is registered in the network. Optionally, you can also assign its **LAN device name**.

If assigned, the IP address is displayed in the block diagram. You can adjust it manually with the parameter the "System Config > Remote Access > Network" > [IP Address Enabling a locked user interface for manual operation](#).

The following section lists the characteristics of the VISA resource strings for the corresponding interface protocols. The emphasized characters determine the protocol.



For description of the interface protocols, control commands and messages, refer to [Remote control via SCPI](#).

HiSLIP

TCPIP::[<host address>::hislip0\[:INSTR\]](#)

hislip0 = HiSLIP device name, designates that the interface protocol HiSLIP is used (mandatory)

hislip0 is composed of `[::HiSLIP device name[,HiSLIP port]]` and must be assigned.

Example:

```
TCPIP::192.1.2.3::hislip0
```

VXI-11

TCPIP::[<host address>\[:inst0\]\[:INSTR\]](#)

[:inst0] = LAN device name, indicates that the VXI-11 protocol is used (optional)

inst0 currently selects the VXI-11 protocol by default and can be omitted.

Example:

```
TCPIP::192.1.2.3::INSTR
```

Socket communication

TCPIP::[<host address>::<port>::SOCKET](#)

port = determines the used port number
SOCKET = indicates the raw network socket resource class

Socket communication requires the specification of the port (commonly referred to as port number) and of "SOCKET" to complete the resource string.

Basically, instruments from Rohde & Schwarz use port number 5025 for socket communication.

Example:

```
TCPIP::192.1.2.3::5025::SOCKET
```

13.2.2 LXI browser interface

The LXI browser interface allows easy configuration of the LAN and remote control of the R&S SMCV100B without additional installation requirements. The instrument's LXI browser interface works correctly with all W3C compliant browsers.

See [Chapter 13.13.1, "LXI functionality"](#), on page 571 for more about LXI.

The LAN settings are configured using the instrument's LXI browser interface described in [Chapter 13.6.2.1, "LAN configuration"](#), on page 538.

13.3 Remote control programs and libraries

This section shows how the remote-control programs access the instrument, and the libraries they require for the corresponding interface protocols.

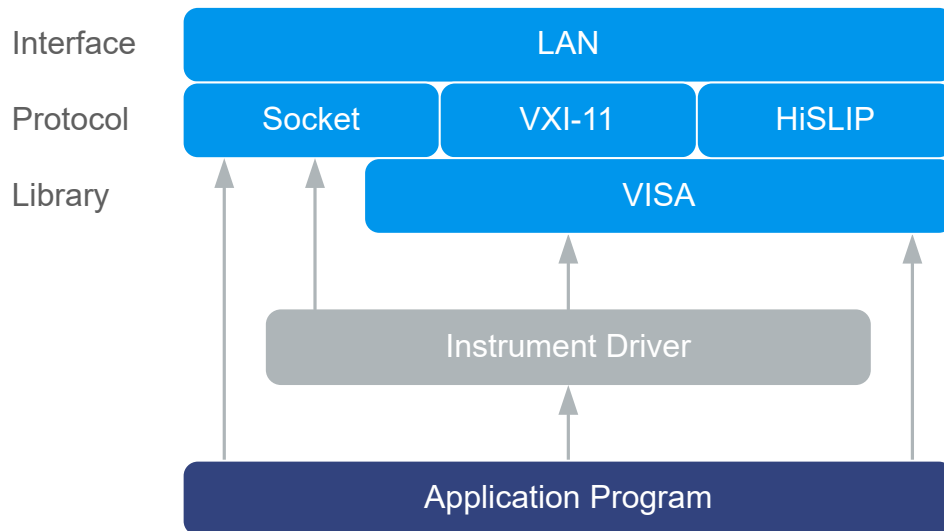
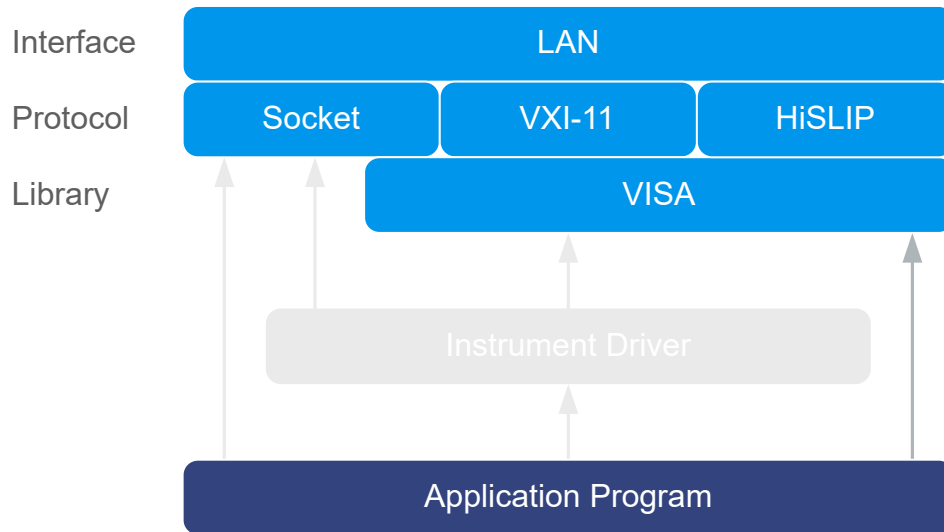

Figure 13-2: Overview of remote control interfaces, protocols and libraries

Possible setups and access functions

The following examples give an overview of dependencies between the available libraries, the possible interfaces and protocols, and whether an instrument driver is provided. For detailed information, see the application note [1GP72: Connectivity of Rohde&Schwarz Signal Generators](#).

Example: Remote control (application) program using VISA**Figure 13-3: Application program using VISA**

Protocol	Remote control program
Socket	<code>viOpen (... , "TCPIP:SMCV100B-102030::5025::SOCKET", ...)</code> <code>viPrintf (... , "SOUR:FREQ 2GHz\n")</code>
VXI-11	<code>viOpen (... , "TCPIP:SMCV100B-102030::inst0::INSTR", ...)</code> <code>viPrintf (... , "SOUR:FREQ 2GHz\n")</code>
HISLIP	<code>viOpen (... , "TCPIP:SMCV100B-102030::hislip0::INSTR", ...)</code> <code>viPrintf (... , "SOUR:FREQ 2GHz\n")</code>

Example: Remote control program using instrument driver (VISA available)

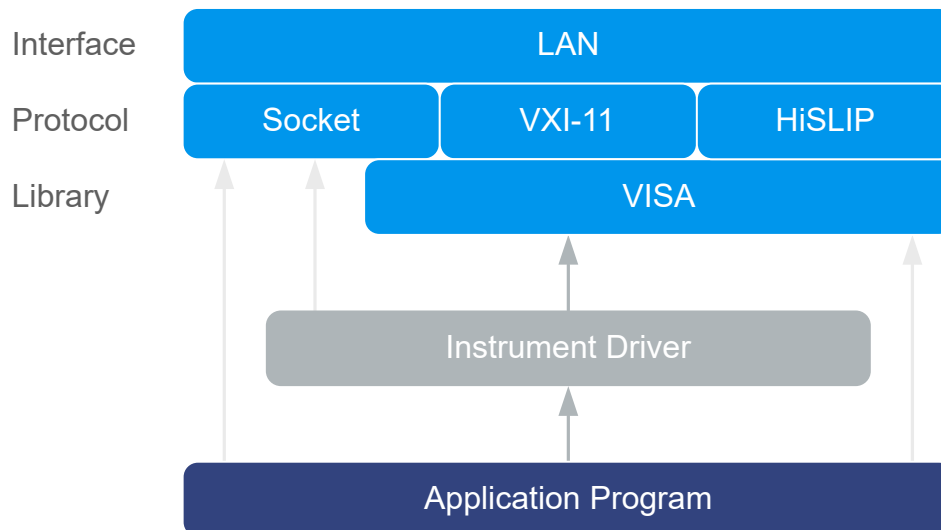

Figure 13-4: Application using instrument driver (VISA available)

Protocol	Remote control program
Socket	<code>rssmcv_init ("TCPIP:SMCV100B-102030::5025::SOCKET", ...)</code> <code>rssmcv_SetFrequency (... , 2e9)</code>
VXI-11	<code>rssmcv_init ("TCPIP:SMCV100B-102030::inst0::INSTR", ...)</code> <code>rssmcv_SetFrequency (... , 2e9)</code>
HISLIP	<code>rssmcv_init ("TCPIP:SMCV100B-102030::hislip0::INSTR", ...)</code> <code>rssmcv_SetFrequency (... , 2e9)</code>

Example: Remote control program using instrument driver (VISA not available)

Figure 13-5: Remote control program using instrument driver (VISA not available)

Protocol	Remote control program
Socket	<pre>rssmcv_init ("TCPIP:SMCV100B-102030::5025::SOCKET", ...) rssmcv_SetFrequency (... , 2e9)</pre>

13.4 Status reporting system

The status reporting system stores all information on the current operating state of the instrument, and on errors which have occurred. This information is stored in the status registers and in the error queue.

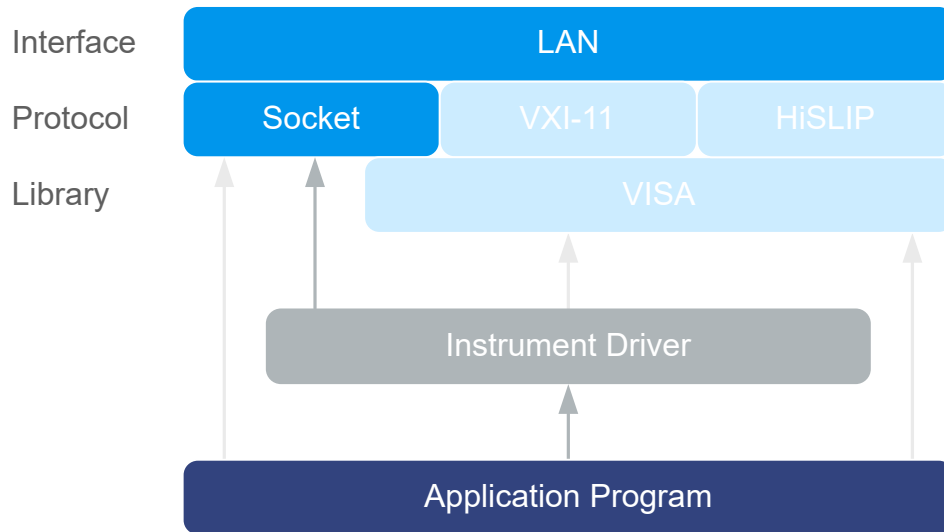
You can query both with the commands of the [STATus subsystem](#).

13.4.1 Hierarchy of the status registers

The [Figure 13-6](#) shows the hierarchical structure of information in the status registers (ascending from left to right).

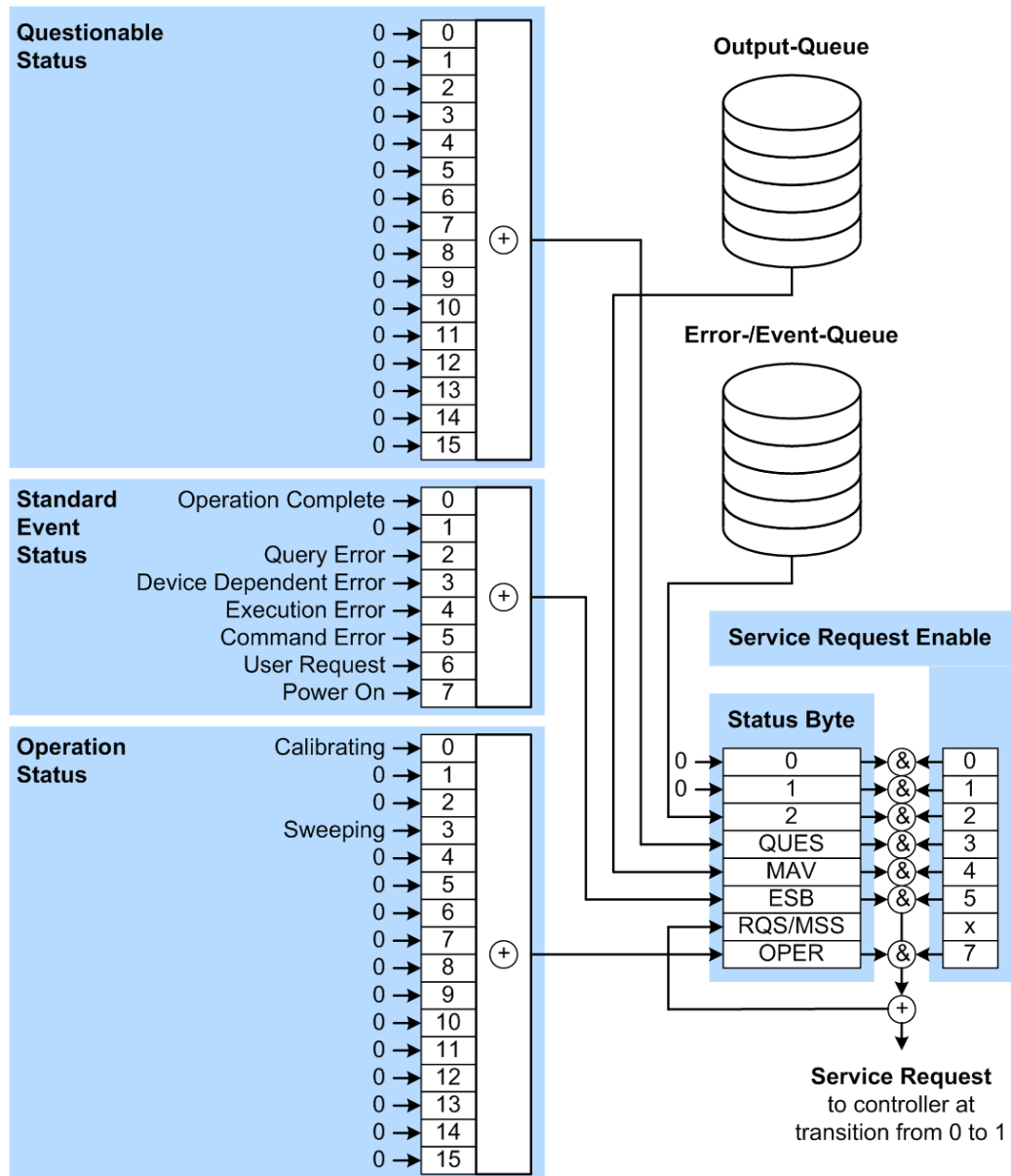

Figure 13-6: Graphical overview of the status registers hierarchy

- OPER = Operation Status Summary Bit
- RQS/MSS = Service Request Generation
- ESB = Standard Event Status Summary Bit
- MAV = Message Available in Output Queue
- QUES = Questionable Status Summary Bit
- 2 = Error- /Event-Queue
- 1, 0 = not used

Note: This legend explains the abbreviations to the Status Byte Register.

The R&S SMCV100B uses the following status registers:

- **Status Byte (STB)** and **Service Request Enable (SRE)**, see [Chapter 13.4.3, "Status byte \(STB\) and service request enable register \(SRE\)"](#), on page 511.

- **Standard Event Status**, i.e. the Event status Register (ESR) and the Event Status Enable (ESE), see [Chapter 13.4.4, "Event status register \(ESR\) and event status enable register \(ESE\)"](#), on page 512.
- **Questionable Status and Operation Status**, the (SCPI status registers, see [Chapter 13.4.2, "Structure of a SCPI status register"](#), on page 509, [Chapter 13.4.5, "Questionable status register \(STATus:QUESTionable\)"](#), on page 513 and [Chapter 13.4.6, "Operation status register \(STATus:OPERation\)"](#), on page 513.
- **Output-Queue**
The output queue contains the messages the instrument returns to the controller. It is not part of the status reporting system but determines the value of the `MAV` bit in the `STB` and thus is represented in the overview.
- **Error- /Event-Queue**
The error-/event-queue contains all errors and events that have occurred in the past. When reading the queue, the instrument starts with the first occurred error/event.

All status registers have the same internal structure.



SRE, ESE

The service request enable register `SRE` can be used as `ENABLE` part of the `STB` if the `STB` is structured according to SCPI. By analogy, the `ESE` can be used as the `ENABLE` part of the `ESR`.

13.4.2 Structure of a SCPI status register

Each SCPI status register consists of five parts. Each part has a width of 16 bits and has different functions. The individual bits are independent of each other, i.e. each hardware status is assigned a bit number, which is valid for all five parts. Bit 15 (the most significant bit) is set to zero for all parts. Thus, the contents of the register parts can be processed by the controller as positive integers.

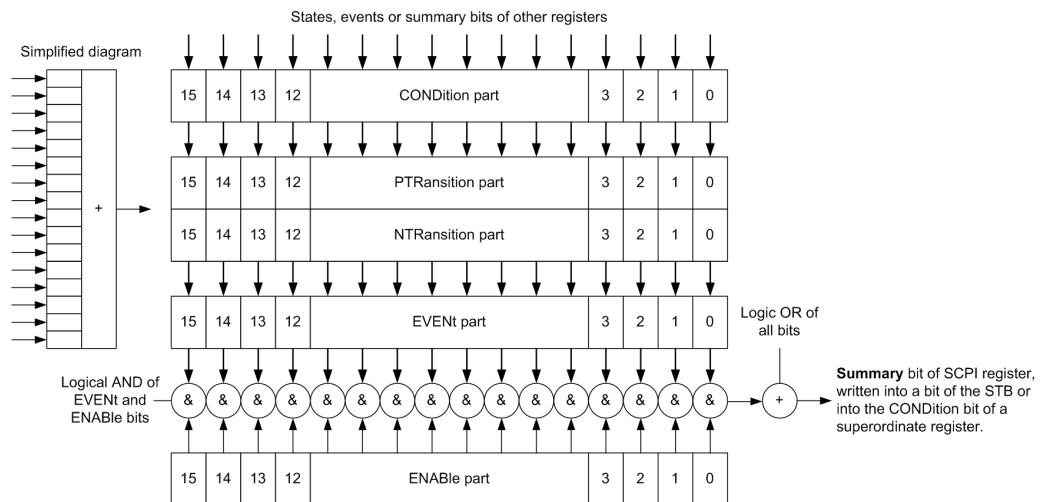

Figure 13-7: The status-register model

Description of the five status register parts

The five parts of a SCPI status register have different properties and functions:

- **CONDition**

The **CONDition** part is written directly by the hardware or it mirrors the sum bit of the next lower register. Its contents reflect the current instrument status. This register part can only be read, but not written into or cleared. Its contents are not affected by reading.

- **PTRansition / NTRansition**

The two transition register parts define which state transition of the **CONDition** part (none, 0 to 1, 1 to 0 or both) is stored in the **EVENT** part.

The **Positive-TRansition** part acts as a transition filter. When a bit of the **CONDition** part is changed from 0 to 1, the associated **PTR** bit decides whether the **EVENT** bit is set to 1.

- **PTR** bit =1: the **EVENT** bit is set.
- **PTR** bit =0: the **EVENT** bit is not set.

This part can be written into and read as required. Its contents are not affected by reading.

The **Negative-TRansition** part also acts as a transition filter. When a bit of the **CONDition** part is changed from 1 to 0, the associated **NTR** bit decides whether the **EVENT** bit is set to 1.

- **NTR** bit =1: the **EVENT** bit is set.
- **NTR** bit =0: the **EVENT** bit is not set.

This part can be written into and read as required. Its contents are not affected by reading.

- **EVENT**

The **EVENT** part indicates whether an event has occurred since the last reading, it is the "memory" of the condition part. It only indicates events passed on by the transition filters. It is permanently updated by the instrument. This part can only be

read by the user. Reading the register clears it. This part is often equated with the entire register.

- **ENABLE**

The `ENABLE` part determines whether the associated `EVENT` bit contributes to the sum bit (see below). Each bit of the `EVENT` part is "ANDed" with the associated `ENABLE` bit (symbol '&'). The results of all logical operations of this part are passed on to the sum bit via an "OR" function (symbol '+').

`ENABLE` bit = 0: the associated `EVENT` bit does not contribute to the sum bit

`ENABLE` bit = 1: if the associated `EVENT` bit is "1", the sum bit is set to "1" as well.

This part can be written into and read by the user as required. Its contents are not affected by reading.

Sum bit

The sum bit is obtained from the `EVENT` and `ENABLE` part for each register. The result is then entered into a bit of the `CONDition` part of the higher-order register.

The instrument automatically generates the sum bit for each register. Thus an event can lead to a service request throughout all levels of the hierarchy.

13.4.3 Status byte (STB) and service request enable register (SRE)

The `Status Byte` (STB) is already defined in IEEE 488.2. It provides a rough overview of the instrument status by collecting the pieces of information of the lower registers. A special feature is that bit 6 acts as the sum bit of the remaining bits of the status byte.

The STB is read using the command `*STB?` or a serial poll.

The `Status Byte` (STB) is linked to the `Service Request Enable` (SRE) register. Each bit of the STB is assigned a bit in the SRE. Bit 6 of the SRE is ignored. If a bit is set in the SRE and the associated bit in the STB changes from 0 to 1, a service request (SRQ) is generated. The SRE can be set using the command `*SRE` and read using the command `*SRE?`.

Table 13-3: Meaning of the bits used in the status byte

Bit No.	Meaning
0...1	Not used
2	Error Queue not empty The bit is set when an entry is made in the error queue. If this bit is enabled by the SRE, each entry of the error queue generates a service request. Thus an error can be recognized and specified in greater detail by polling the error queue. The poll provides an informative error message. This procedure is to be recommended since it considerably reduces the problems involved with remote control.
3	QUESTIONable status register summary bit The bit is set if an <code>EVENT</code> bit is set in the <code>QUESTIONable</code> status register and the associated <code>ENABLE</code> bit is set to 1. A set bit indicates a questionable instrument status, which can be specified in greater detail by querying the <code>STATUS:QUESTIONable</code> status register.

Bit No.	Meaning
4	MAV bit (message available) The bit is set if a message is available in the output queue which can be read. This bit can be used to enable data to be automatically read from the instrument to the controller.
5	ESB bit Sum bit of the event status register. It is set if one of the bits in the event status register is set and enabled in the event status enable register. Setting of this bit indicates a serious error which can be specified in greater detail by polling the event status register.
6	MSS bit (main status summary bit) The bit is set if the instrument triggers a service request. This is the case if one of the other bits of this registers is set together with its mask bit in the service request enable register SRE.
7	STATUS:OPERation status register summary bit The bit is set if an EVENT bit is set in the OPERATION status register and the associated ENABLE bit is set to 1. A set bit indicates that the instrument is just performing an action. The type of action can be determined by querying the STATUS:OPERation status register.

13.4.4 Event status register (ESR) and event status enable register (ESE)

The ESR is defined in IEEE 488.2. It can be compared with the EVENT part of a SCPI register. The event status register can be read out using command *ESR?.

The ESE corresponds to the ENABLE part of a SCPI register. If a bit is set in the ESE and the associated bit in the ESR changes from 0 to 1, the ESB bit in the STB is set. The ESE register can be set using the command *ESE and read using the command *ESE?.

Table 13-4: Meaning of the bits used in the event status register

Bit No.	Meaning
0	Operation Complete This bit is set on receipt of the command *OPC exactly when all previous commands have been executed.
1	Not used
2	Query Error This bit is set if either the controller wants to read data from the instrument without having sent a query, or if it does not fetch requested data and sends new instructions to the instrument instead. The cause is often a query which is faulty and hence cannot be executed.
3	Device-dependent Error This bit is set if a device-dependent error occurs. An error message with a number between -300 and -399 or a positive error number, which denotes the error in greater detail, is entered into the error queue.
4	Execution Error This bit is set if a received command is syntactically correct but cannot be performed for other reasons. An error message with a number between -200 and -300, which denotes the error in greater detail, is entered into the error queue.

Bit No.	Meaning
5	Command Error This bit is set if a command is received, which is undefined or syntactically incorrect. An error message with a number between -100 and -200, which denotes the error in greater detail, is entered into the error queue.
6	User Request This bit is set when the instrument is switched over to manual control.
7	Power On (supply voltage on) This bit is set on switching on the instrument.

13.4.5 Questionable status register (STATus:QUESTIONable)

This register contains information on questionable instrument states. Such states may occur when the instrument is not operated in compliance with its specifications.

To read the register, use the query commands `STAT:QUEST:COND?` or `STAT:QUEST[:EVEN]?`.

Table 13-5: Meaning of the bits used in the questionable status register

Bit No.	Meaning
0–15	Not used

13.4.6 Operation status register (STATus:OPERation)

This condition part contains information on the actions currently being performed by the instrument, while the event part contains information on the actions performed by the instrument since the last readout of the register.

To read the register, use the query commands `STAT:OPER:COND?` or `STAT:OPER[:EVEN]?`.

Table 13-6: Meaning of the bits used in the operation status register

Bit No.	Meaning
0	Calibrating The bit is set during the calibration phase.
1–2	Not used
3	
4–15	Not used

13.4.7 Application of the status reporting system

The purpose of the status reporting system is to monitor the status of one or several devices in a measuring system. To do this and react appropriately, the controller must

receive and evaluate the information of all devices. The following standard methods are used:

- **Service request** (SRQ) initiated by the instrument
- **Serial poll** of all devices in the bus system, initiated by the controller to find out who sent an SRQ and why
- Query of a **specific instrument status** by commands
- Query of the **error queue**

13.4.7.1 Service request

Under certain circumstances, the instrument can send a service request (SRQ) to the controller. Usually this service request initiates an interrupt at the controller, to which the control program can react appropriately. An SRQ is always initiated if one or several of bits 2, 4 or 5 of the status byte are set and enabled in the SRE. Each of these bits combines the information of the error queue or the output buffer. To use the possibilities of the service request effectively, all bits should be set to "1" in the enable registers SRE and ESE.

Example:

Use command `*OPC` to generate an SRQ .

`*ESE 1` - set bit 0 of ESE (Operation Complete)

`*SRE 32` - set bit 5 of SRE (ESB).

After its settings have been completed, the instrument generates an SRQ.

The SRQ is the only possibility for the instrument to become active on its own. Each controller program should set the instrument such that a service request is initiated in the case of malfunction. The program should react appropriately to the service request.

13.4.7.2 Serial poll

In a serial poll, just as with command `*STB`, the status byte of an instrument is queried. However, the query is realized via interface messages and is thus clearly faster.

The serial poll method is defined in IEEE 488.1 and used to be the only standard possibility for different instruments to poll the status byte. The method also works for instruments which do not adhere to SCPI or IEEE 488.2.

The serial poll is mainly used to obtain a fast overview of the state of several instruments connected to the controller.

13.4.7.3 Query of an instrument status

Each part of any status register can be read using queries. There are two types of commands:

- The common commands `*ESR?`, `*IDN?`, `*IST?`, `*STB?` query the higher-level registers.

- The commands of the `STATus` system query the SCPI registers (`STATus:QUEStionable...`)

The returned value is always a decimal number that represents the bit pattern of the queried register. This number is evaluated by the controller program.

Queries are usually used after an SRQ in order to obtain more detailed information on the cause of the SRQ.

13.4.7.4 Error queue

Each error state in the instrument leads to an entry in the error queue. The entries of the error queue are detailed plain text error messages that can be looked up in the Error Log or queried via remote control using `SYSTem:ERRor[:NEXT]?`. Each call of `SYSTem:ERRor[:NEXT]?` provides one entry from the error queue. If no error messages are stored there any more, the instrument responds with 0, "No error".

The error queue should be queried after every SRQ in the controller program as the entries describe the cause of an error more precisely than the status registers. Especially in the test phase of a controller program the error queue should be queried regularly since faulty commands from the controller to the instrument are recorded there as well.

13.4.8 Reset values of the status reporting system

The following table contains the different commands and events causing the status reporting system to be reset. None of the commands, except of `*RST` and `SYSTem:PRESet` affect the functional instrument settings. In particular, `DCL` does not change the instrument settings.

Table 13-7: Resetting the status reporting system

Event	Switching on supply voltage Power-On-Status-Clear		DCL, SDC (Device Clear, Selected Device Clear)	*RST or SYSTem: PRESet	STATus: PRESet	*CLS
	0	1				
Clear STB, ESR	-	Yes	-	-	-	Yes
Clear SRE, ESE	-	Yes	-	-	-	-
Clear PPE	-	Yes	-	-	-	-
Clear error queue	Yes	Yes	-	-	-	Yes
Clear output buffer	Yes	Yes	Yes	1)	1)	1)
Clear command processing and input buffer	Yes	Yes	Yes	-	-	-

1) The first command in a command line that immediately follows a <PROGRAM MESSAGE TERMINATOR> clears the output buffer.

13.5 Remote access settings

This section outlines the settings required for accessing and configuring the provided remote control interfaces. It includes network settings, access addresses, emulation settings for using the command sets of other generators, and the access with smart devices.

About instrument emulations

You can remotely control the R&S SMCV100B using the command set of another signal generator. With this function you can, for example, replace a signal generator with an R&S SMCV100B in an automated test setup, without adjusting the command scripts used.



The R&S SMCV100B also covers command sets of Rohde & Schwarz signal generators, such as the R&S SFE and R&S SFE100. To achieve optimal compatibility when replacing an instrument, we recommend that you select the emulation command set for the corresponding signal generator.

You find the remote control command sets supported by the R&S SMCV100B in a selection list.

The selected instrument also defines the identification string that is retrieved with query `*IDN?`. If necessary, use the parameter `Mode` and `IDN String` to change this string.

As any other parameter, the remote control command set can also be changed remotely by the command `:SYSTem:LANGuage`.

While working in an emulation mode, the R&S SMCV100B specific command set is disabled and the SCPI command `:SYSTem:LANGuage` is discarded.

To return to the SCPI command set of the R&S SMCV100B, use the appropriate command of the selected command set.

If for example the R&S SFE/R&S SFE100 is emulated, the R&S SFE/R&S SFE100 command returns the corresponding R&S SMCV100B-specific command.

About health and utilization monitoring system (HUMS)

The R&S SMCV100B comes with a health and utilization monitoring system (HUMS) providing information about the R&S SMCV100B. Aim is to increase the overall utilization, to avoid downtime and to increase the overall security level of a fleet of instruments.

HUMS provides, for example, information about:

- Instrument identification, hardware components, software packages, licenses
- Usage of remote control, usage via keyboard / mouse, usage of test applications
- Hardware utilization and status, including S.M.A.R.T. data of the system drive
- User-defined static information, for example, an inventory code

Interfaces and protocols

The HUMS installation on the R&S SMCV100B includes an SNMP agent and a REST service with HTTP endpoints. So you can access the health and usage information via LAN, using the SNMP protocol or the REST protocol. Accessing the data does not interfere with remote control via SCPI commands or with measurement execution.

Reference information for both protocols is available on the R&S SMCV100B at the address `http://<instrument>/api/hums/v1/documents?name=<interface>`.

For `<instrument>`, enter the hostname (e.g. `SMCV100B-102030`) or the IP address (e.g. `10.121.0.34`) of your instrument, as for access to the GUI.

For `<interface> = snmp`, you get a `.zip` file containing the MIB files for SNMP. For `<interface> = rest`, you get a web page with the OpenAPI specification of the REST API.

Address example: `http://SMCV100B-102030/api/hums/v1/documents?name=snmp`.

The following table lists the REST endpoints and the SNMP MIB file names.

REST endpoint <code>/api/hums/v1/...</code>	SNMP MIB	Description	Typical data
documents	---	developer information	SNMP MIB files, swagger specification of HUMS REST endpoints
greetings	RS-GREETINGS-MIB	identity information	manufacturer, model, serial number, version
equipment/bios	RS-BIOS-INFO-MIB	BIOS information	BIOS manufacturer, version and release date
date-time	RS-TIME-DATE-MIB	time and date information	UTC and local time, timezone, dst (daylight savings time)
device-history	RS-DEVICE-HISTORY-MIB	history events	instrument-specific event information and notifications
device-tags	RS-DEVICE-TAGS-MIB	customer information	user-definable key information, associated with the instrument, e.g. asset number, owner, location
equipment	RS-EQUIPMENT-MIB	footprint information	hardware and software configuration, licenses
hums-info	RS-HUMS-INFO-MIB	basic information on the HUMS service	HUMS version, counter of SNMP and REST requests, amount of collected data, HUMS database size
storage	RS-STORAGE-MIB	S.M.A.R.T. data of drive	system drive temperature, drive health
system-info	RS-SYSTEM-INFO-MIB	a system overview	OS and BIOS version, IP address, locale
system-status	RS-SYSTEM-STATUS-MIB	system status information	global system status, static notifications
utilization	RS-UTILIZATION-MIB	utilization information	instrument activity, e.g., power on time, RF on time, option utilization, remote interface traffic

For detailed information about HUMS and its applications, refer to:

- The R&S®HUMS Health and Utilization Monitoring Service user manual, available on the Rohde & Schwarz website.
- The application note [GFM336: Instrument Health and Utilization Monitoring](#)

13.5.1 Network settings

Access:

- ▶ Select "System Config" > "Remote Access" > "Network".

Network		
Network Status	● Connected	
Hostname	Workgroup	
smcvb-vm-a8a79d	INSTRUMENT	
Instrument Address		
Address Mode	Show Connector ...	
Auto (DHCP)		
IP Address	Subnet Mask	Default Gateway
10.102.52.35	255.255.252.0	10.102.52.1
DNS Suffix	DNS Server	MAC Address
rsint.net	10.0.2.166	08 00 27 a8 a7 9d

In the "Network" dialog, you can configure the settings of the general network environment and specific identification parameters of the instrument in the network.

The remote commands required to configure the network remotely are described in [Chapter 14.17, "SYSTem subsystem"](#), on page 808.

How to: see [Chapter 3.1.7, "Connecting to LAN"](#), on page 27.

Settings:

Network Status	518
Restart Network	519
Hostname	519
Workgroup	519
Address Mode	519
IP Address	519
Subnet Mask	520
Default Gateway	520
DNS Suffix	520
DNS Server	521
MAC Address	521

Network Status

Indicates that the instrument is connected to the network.

Remote command:

:SYSTem:COMMunicate:NETWork:STATus? on page 820

Restart Network

Terminates the network connection of the instrument and sets it up again. You can use this function to fix network problems.

Note: This function restarts only the connection of the instrument to the network. It does not impact the network itself.

Remote command:

`:SYSTem:COMMunicate:NETWork:REStart` on page 820

Hostname

Displays the hostname.

Each instrument is delivered with an assigned hostname, a logical name which can be used instead of the IP address. With the default network settings, the IP address is allocated by the DHCP server. This address can change each time the instrument is reconnected. Unlike the IP address, the hostname name does not change.

Note:

This function is password-protected. Unlock the protection level 1 to access it.

- We recommend that you do not change the default network settings or the hostname to avoid problems with the network connection.
If you change the hostname, be sure to use a unique name.

Remote command:

`:SYSTem:COMMunicate:NETWork[:COMMON]:HOSTName` on page 820

Workgroup

Sets the individual windows workgroup name of the R&S SMCV100B. This parameter is required in case the instrument is integrated in a windows network.

This function is password-protected. Unlock the protection level 1 to access it.

Remote command:

`:SYSTem:COMMunicate:NETWork[:COMMON]:WORKgroup` on page 821

Address Mode

Selects the mode for assigning the IP address.

How to: [Chapter 13.7.2.1, "How to assign the IP address"](#), on page 544

"Auto (DHCP)"

Assigns the IP address automatically, provided the network supports DHCP (Dynamic Host Configuration Protocol).

"Static"

Enables you to assign the IP address manually.

Remote command:

`:SYSTem:COMMunicate:NETWork:IPAddress:MODE` on page 819

IP Address

Displays the IP address of the instrument in the network.

By default, the R&S SMCV100B is configured to use dynamic TCP/IP configuration and to obtain the address information automatically. Setting [Address Mode](#) > "AUTO (DHCP)" denotes that the DHCP server is available. The instrument displays the assigned IP address read-only.

If the network does not support DHCP or there is no DHCP server available, the instrument tries to obtain the IP address using *Zeroconf (Avahi)* protocol. This feature enables the instrument to self-configure an IP address and subnet mask. Zeroconf (Avahi) IP addresses start with the number blocks 169.254.*.*, with the subnet mask of 255.255.

Note: An IP address that is assigned with the Zeroconf protocol although the network requires an IP address assigned from the DHCP server can cause network connection failures.

If both services fail to connect, you can configure the address manually.

How to: "[To assign the IP address manually on the instrument](#)" on page 544

Remote command:

`:SYSTEM:COMMunicate:NETWork:IPADdress` on page 819

Subnet Mask

Displays the bit group of the subnet in the host identifier.

The TCP/IP protocol is preinstalled with the subnet mask 255.255.255.0. If the DHCP server is available [Address Mode A AUTO \(DHCP\)](#), the setting is read-only. The subnet mask consists of four number blocks separated by dots. Each block contains 3 numbers in maximum (e.g. 100.100.100.100), but also one or two numbers are allowed in a block (as an example see the preinstalled address).

To assign the subnet mask manually, select [Address Mode > Static](#).

Note: When assigning the subnet mask manually, make sure that the address matches with the subnet mask of the controlling host interface.

How to: "[To assign the IP address manually on the instrument](#)" on page 544.

Remote command:

`:SYSTEM:COMMunicate:NETWork[:IPADdress]:SUBNet:MASK` on page 821

Default Gateway

Displays the gateway address.

This address identifies the router on the same network as the instrument that is used to forward traffic to destinations beyond the local network.

To assign the gateway address manually, select [Address Mode > "Static"](#).

Remote command:

`:SYSTEM:COMMunicate:NETWork[:IPADdress]:GATeway` on page 821

DNS Suffix

Displays the primary DNS (Domain Name System) suffix, that means the DNS name without the hostname part.

The DNS system uses the suffix for registration and name resolution for unique identification of the instrument in the entire network.

To assign the DNS suffix manually, select [Address Mode > "Static"](#).

Remote command:

`:SYSTEM:COMMunicate:NETWork[:COMMON]:DOMain` on page 820

DNS Server

Determines the preferred server for name resolution. The DNS server contains the underlying numerical values that are required for name resolution of the hostname as part of the IP address.

To select the DNS server manually, select [Address Mode](#) > "Static".

Remote command:

`:SYSTem:COMMunicate:NETWork[:IPAddress]:DNS` on page 821

MAC Address

Indicates the MAC (Media Access Control) address, a unique identifier of the network adapter in the R&S SMCV100B.

Remote command:

`:SYSTem:COMMunicate:NETWork:MACaddress` on page 819

13.5.2 VISA resource strings

Access:

- ▶ Select "System Config > Remote Access > Visa Resource Strings".

Network	Visa Resource Strings	Instrument Emulations	Remote Connections	HUMS	QR-Code	
	HISLIP					TCPIP::10.111.1.35::hislip0::INSTR
	VXI11					TCPIP::10.111.1.35::inst0::INSTR
	Socket					TCPIP::10.111.1.35::5025::SOCKET
	USB					USB::0x0AAD::0x0248::000000::INSTR

The "Visa Resource String" dialog displays the VISA resource strings provided for remote control over the different interfaces.

The remote commands required to query the address information remotely are described in [Chapter 14.17, "SYSTem subsystem"](#), on page 808.

Settings:

HISLIP	521
VXI11	522
Socket	522

HISLIP

Displays the visa resource string for remote control with HiSLIP protocol.

See also [Chapter 13.2.1, "LAN interface"](#), on page 502

Remote command:

`:SYSTem:COMMunicate:HISLip:RESource?` on page 818

VXI11

Displays the visa resource string for remote control over LAN.

See also [Chapter 13.2.1, "LAN interface"](#), on page 502

Remote command:

`:SYSTem:COMMunicate:NETWork:RESource?` on page 819

Socket

Displays the visa resource string for remote control over LAN, using the socket communication protocol.

See also [Chapter 13.2.1, "LAN interface"](#), on page 502

Remote command:

`:SYSTem:COMMunicate:SOCKet:RESource?` on page 822

13.5.3 Instrument emulations settings

Access:

- ▶ Select "System Config > Remote Access > Instrument Emulations".

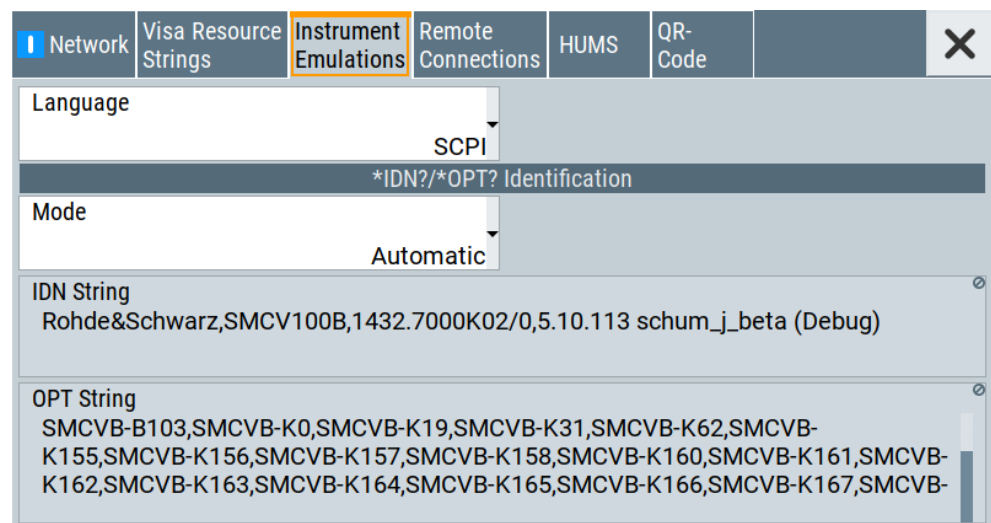

The "Instrument Emulations" dialog enables you to emulate a remote control command set of another signal generator.

The remote commands required to configure the emulation settings remotely are described in [Chapter 14.17, "SYSTem subsystem"](#), on page 808.

Settings

Language

Selects the instrument whose remote command set is emulated by the R&S SMCV100B.

Remote command:

[:SYSTem:LANGuage](#) on page 824

Mode

Selects the way the instrument identification is performed.

"Automatic" Sets the "IDN String" and the "OPT String" automatically for the instrument selected with the parameter [Language](#).

"User Defined" Enables you to define the "IDN String" and the "OPT String".

Remote command:

[:SYSTem:IDENTification](#) on page 822

Set to Default

In "Mode > User Defined", resets the *IDN and *OPT strings.

Remote command:

[:SYSTem:IDENTification:PRESet](#) on page 823

IDN String

Indicates the identification string of the instrument when queried with the common command *IDN?.

In addition to the preset values, you can define your own identification string so that each generator uses an individual identification, like `My_SigGen` for instance, see [Mode](#) .

Remote command:

[*IDN?](#) on page 576

[:SYSTem:IREsponse](#) on page 823

OPT String

Indicates the option string of the instrument as queried with common command *OPT?.

In [Mode](#) > "User Defined", you can define your own option string. A query responds with this option string instead of the automatically created option string.

Remote command:

[*OPT?](#) on page 577

[:SYSTem:OREsponse](#) on page 823

13.5.4 Remote connections settings

The "Remote Connections" dialog covers the active SCPI and TCP/IP connections, and a history list of the connections that have accessed the instrument before.

13.5.4.1 Active connections

Access:

- ▶ Select "System Config > Remote Access > Remote Connections > Active".

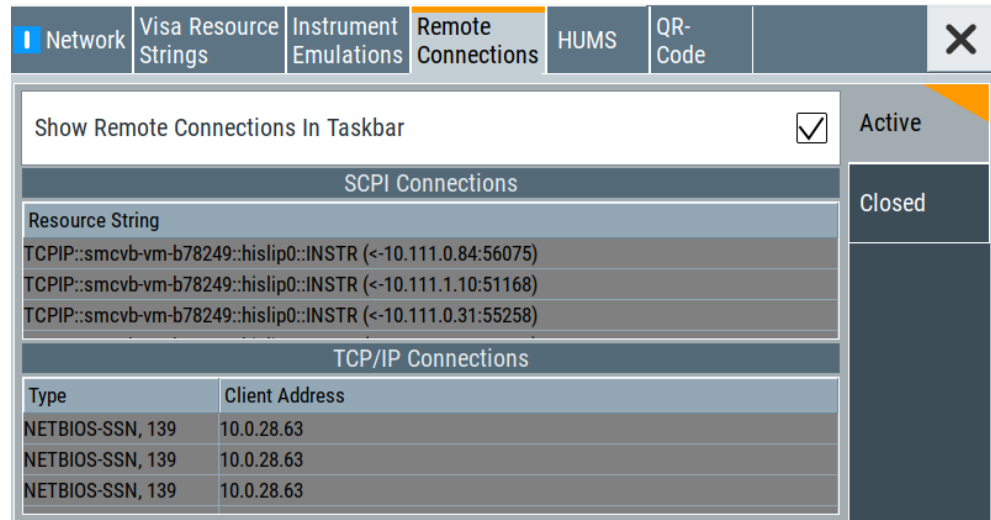

The "Active" tab shows the currently active remote connections, and you can enable the display of the active connections in the task bar.

Settings

Show Remote Connections in Taskbar.....	524
SCPI Connections.....	524
TCP/IP Connections.....	524

Show Remote Connections in Taskbar

Displays the currently active connections in the taskbar.

SCPI Connections

Displays the VISA resources strings of the remote connections currently controlling the instrument via the LAN interface.

Remote command:

n.a.

TCP/IP Connections

Displays the types and client addresses of the remote connections currently controlling the instrument via the LAN interface.

Remote command:

n.a.

13.5.4.2 Closed connections

Access:

- ▶ Select "System Config > Remote Access > Remote Connections > Closed".

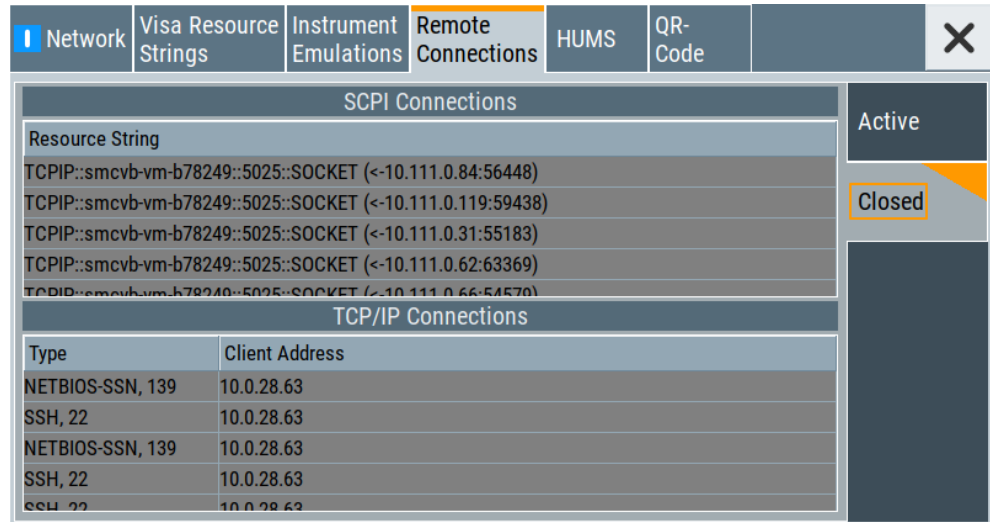

The "Closed" tab shows the currently active remote connections, and you can enable the display of the active connections in the task bar.

Settings

SCPI Connections.....525
 TCP/IP Connections.....525

SCPI Connections

Lists the VISA resource strings of the last remote connections that have accessed the instrument via the LAN interface before.

Remote command:
 n.a.

TCP/IP Connections

Lists the types and client addresses of the last remote connections that had accessed the instrument via the LAN interface before.

Remote command:
 n.a.

13.5.5 HUMS settings

Requires R&S SMCVB-K980.

Access:

- ▶ Select "System Config > Remote Access > HUMS".

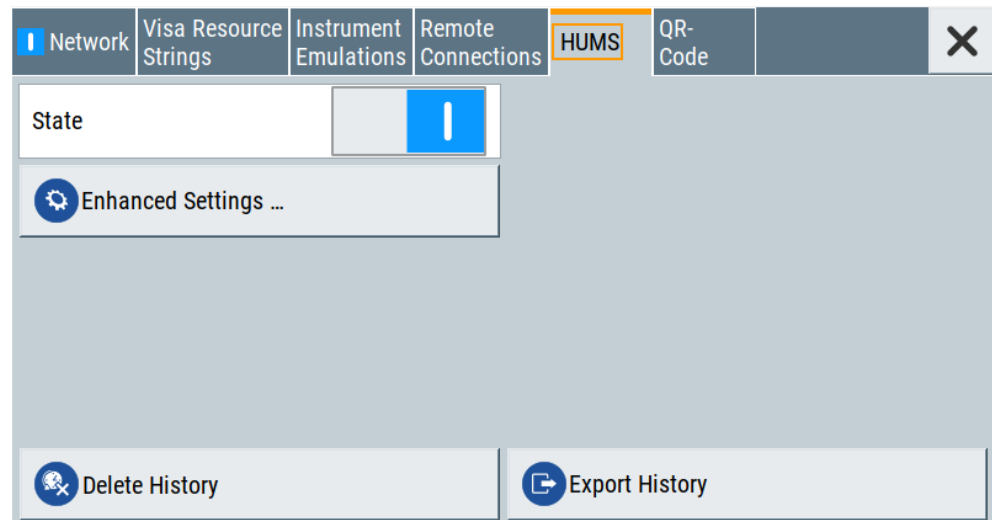

The dialog provides settings to configure the health and utilization monitoring system (HUMS) of the R&S SMCV100B.

The remote commands required to define these settings are described in [Chapter 14.8, "HUMS remote control commands"](#), on page 599.

Settings

State	526
Enhanced Settings	526
Delete History	526
Export History	527

State

Activates HUMS.

Data is only recorded, if HUMS is enabled. If disabled, already recorded data can still be retrieved.

The setting is reset by a factory preset to "off".

Remote command:

[DIAGnostic:HUMS:STATe](#) on page 601

Enhanced Settings

Opens a dialog for configuring enhanced protocol settings, see [Chapter 13.5.6, "HUMS enhanced settings"](#), on page 527.

Access is only available, when HUMS is enabled, see [State](#).

Delete History

Deletes all information from the HUMS service including the device history.

Note: Regarding the instrument security, the sanitization procedure also deletes the history of the HUMS service, see [Chapter 12.6.2.2, "Disk & memory security settings"](#), on page 484.

Remote command:

[DIAGnostic:HUMS:DEvIce:HISTory:DELeTe:ALL](#) on page 600

Export History

Triggers an export of the logged data of the HUMS service into a *.zip file.

A standard file dialog opens, to save the log file. By default, the file is saved to the directory /var/user/.

Remote command:

[DIAGnostic:HUMS:DEvIce:HISTory?](#) on page 599

[DIAGnostic:HUMS:SAVE](#) on page 601

13.5.6 HUMS enhanced settings

Access:

1. Select "System Config > Remote Access > HUMS".
2. Select "State > ON".
3. Select "Enhanced Settings".

The dialog provides enhanced settings for configuring protocol settings and device tags.

The remote commands required to define these settings are described in [Chapter 14.8, "HUMS remote control commands"](#), on page 599.

- [Protocol settings](#).....528
- [SNMP user settings](#)..... 529
- [Device tag settings](#).....533

13.5.6.1 Protocol settings

The "Protocol" tab of the "Enhanced HUMS Settings" dialog provides protocol settings for SNMP or REST protocol.

Access:

1. Select "System Config > Remote Access > HUMS".
2. Select "State > ON".
3. Select "Enhanced Settings".
4. Select "Protocol".

The dialog provides enhanced settings for configuring protocol settings and device tags.

Settings

SNMP.....	528
REST.....	528
SNMP Configuration.....	528
L Location.....	529
L Contact.....	529
L Access.....	529
L Community.....	529
User Settings.....	529

SNMP

Enables the SNMP agent and selects the supported SNMP version to communicate with the service.

The setting is reset by a factory preset to "v1/v2c".

"Off"	The SNMP agent is disabled.
"v1/v2c"	Selects SNMP version 2, which also enables version v1.
"v1/v2c/v3"	Selects all SNMP version v1, v2c and v3.
"v3"	Selects SNMP version v3.

Remote command:

[SYSTEM:COMMunicate:SNMP:VERSion](#) on page 605

REST

Enables the REST API protocol.

The setting is reset by a factory preset to "On".

Remote command:

[SYSTEM:COMMunicate:REST:ENABLE](#) on page 603

SNMP Configuration

For SNMPv1 and SNMPv2c authentication, you can define "Access" and "Community". For SNMPv3 authentication, you can define "User" profiles.

Location ← SNMP Configuration

Defines the SNMP location information. This information complies with the server's physical location and is used for identification of the SNMP server. By default, this input field is empty.

Remote command:

[SYSTem:COMMunicate:SNMP:LOCation](#) on page 604

Contact ← SNMP Configuration

Sets the SNMP contact information. This information complies with the person who manages the SNMP server and is used for identification of the SNMP server. By default, this input field is empty.

Remote command:

[SYSTem:COMMunicate:SNMP:CONtact](#) on page 604

Access ← SNMP Configuration

Defines the access type for SNMP community string.

For read access, you can use "Read" or "Read & Write". For write access, use "Read & Write".

The setting is reset by a factory preset to "Read & Write".

Remote command:

[SYSTem:COMMunicate:SNMP:COMMunity:RO](#) on page 603

[SYSTem:COMMunicate:SNMP:COMMunity:RW](#) on page 603

Community ← SNMP Configuration

Defines the SNMP community string that can be a group of instruments with SNMP version v2 support.

The setting is reset by a factory preset to the "<serial number>" of the instrument.

User Settings

Accesses the "Configure SNMP Users for HUMS" dialog.

13.5.6.2 SNMP user settings

For SNMPv3 authentication, you can define user profiles.

Access:

1. Select "System Config > Remote Access > HUMS".
2. Select "State > ON".
3. Select "Enhanced Settings".
4. In the protocol tab, select SNMP communication with SNMPv3, e.g. "SNMP > v1/v2c/v3".

5. Select "User Settings".

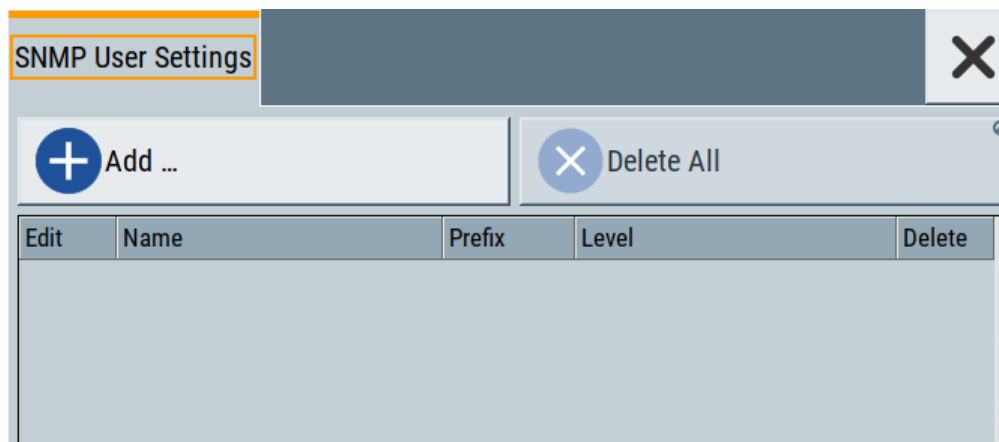

The "Configure SNMP User for HUMS" dialog provides an overview of all defined SNMP users and their profiles. With the "Add" and "Delete All" controls, you can add or remove users.

Settings

Add.....	530
Delete All.....	530
User table.....	530
L Edit.....	531
L Name.....	531
L Prefix.....	532
L Level.....	532
L Delete.....	532
Add SNMP User for HUMS.....	532
L SNMP User Name.....	532
L SNMP User Prefix.....	532
L SNMP User Level.....	533
L SNMP User Public Passphrase.....	533
L SNMP User Encrypted Passphrase.....	533
L Add / Update.....	533

Add

Accesses the "Add SNMP User for HUMS" dialog.

In this dialog, you can define a user and its profile, see ["Add SNMP User for HUMS"](#) on page 532.

Delete All

Removes all users from the list.

Remote command:

[SYSTEM:COMMunicate:SNMP:USM:USER:DElete:ALL](#) on page 605

User table

Lists all defined SNMP users.

SNMP User Settings				
Edit	Name	Prefix	Level	Delete
	user1	Read Only	No Authentication & No Privacy	
	user2	Read & Write	Authentication & No Privacy	
	user3	Read & Write	Authentication & Privacy	

The table informs on the user name and its specified user profile.

Remote command:

[SYSTem:COMMunicate:SNMP:USM:USER:ALL?](#) on page 605

Edit ← User table

Accesses the "Edit SNMP Users for HUMS" dialog, where you can modify an already defined user profile.

Edit SNMP User	
Name	user1
Prefix	Read Only
Level	No Authentication & No Privacy
Public Passphrase	Encrypthed Passphrase
Update	

For description on the entry fields, see [Add SNMP User for HUMS](#).

Name ← User table

Shows the user name of the user who should have specific user rights.

Prefix ← User table

Shows the access right of the selected user.

Level ← User table

Shows the security level of the selected user.

Delete ← User table

Removes the selected user from the list.

Remote command:

[SYSTem:COMMunicate:SNMP:USM:USER:DELeTe](#) on page 605

Add SNMP User for HUMS

Configuration dialog for defining SNMP users and their profiles.

Remote command:

[SYSTem:COMMunicate:SNMP:USM:USER](#) on page 604

SNMP User Name ← Add SNMP User for HUMS

Defines the name of the user for assigning specific user rights. Entering a user name is mandatory.

SNMP User Prefix ← Add SNMP User for HUMS

Defines the access right for a user.

"Read Only" Allows the user to only read information.

"Read & Write" Allows the user to read and modify information.

SNMP User Level ← Add SNMP User for HUMS

Defines the security level of the SNMP user. Depending on the security level, the service requests user name and passphrases for authentication and encryption.

"No Authentication & No Privacy"

Low security level. Using this level, the service queries the user name only. Password authentication and password for encrypted data transfer is not requested.

See ["SNMP User Public Passphrase"](#) on page 533 and ["SNMP User Encrypted Passphrase"](#) on page 533 for data transfer is not requested.

"Authentication & No Privacy"

Medium security level: Requests the user name and password authentication, but no data transfer encryption.

"Authentication & Privacy"

High security level: Requests the user name, and both, the password authentication and the password for data transfer encryption.

SNMP User Public Passphrase ← Add SNMP User for HUMS

Defines the password for authentication. The password must have of 8 to 12 characters with any combination of ASCII characters.

SNMP User Encrypted Passphrase ← Add SNMP User for HUMS

Defines the password for encryption. This password must have at least 8 characters with any combination of ASCII characters. When encryption is defined, the R&S SMCV100B supports the DES (directed enhanced services) protocol.

Add / Update ← Add SNMP User for HUMS

Assigns the defined user with its profile to the list.

If you change an already defined user profile, the instrument provides the "Update" button to apply the modifications.

13.5.6.3 Device tag settings

The "Device Tags" tab of the "Enhanced HUMS Settings" dialogs displays the defined device tags. You can also add or delete device tags here.

A device tag is a label to assign to your instrument. You can create any device tag for your instrument and define it by a specific key and value.

Access:

1. Select "System Config > Remote Access > HUMS".
2. Select "State > ON".
3. Select "Enhanced Settings".

Protocol		Device Tags		✕	
ID	Key	Value	Delete		
0			✕		
1			✕		
2			✕		
+			Add		
✕			Delete All		

Configures device tags for tagging user-defined information of the instrument in a table. You can define up to 32 device tags, e.g., for HUMS history evaluation. To add a device tag, define "Key" and "Value" of the device tag in the table. Click "Add" to add all device tags of the table to the HUMS history.

Settings

ID.....	534
Key.....	534
Value.....	534
Delete.....	535
Add.....	535
Delete All.....	535

ID

Identification count of a device tag entry.

Key

Sets the identification key of a device tag.

Remote command:

`DIAGnostic:HUMS:TAGS[:VALue]` on page 602

Value

Sets the value of the identification key of a device tag.

Remote command:

`DIAGnostic:HUMS:TAGS[:VALue]` on page 602

Delete

Deletes the selected device tag from the HUMS history.

Remote command:

[DIAGnostic:HUMS:TAGS:DELeTe](#) on page 602

Add

Adds a new device tag to the HUMS service.

Remote command:

[DIAGnostic:HUMS:TAGS\[:VALue\]](#) on page 602

[DIAGnostic:HUMS:TAGS:ALL?](#) on page 601

Delete All

Removes all device tags from the HUMS history.

Remote command:

[DIAGnostic:HUMS:TAGS:DELeTe:ALL](#) on page 602

13.5.7 QR code

Access:

- ▶ Select "System Config > Remote Access > QR Code".



The "QR Code" dialog shows the current instrument address (IP address) in quick response (QR) format.

This functionality provides fast access to the instrument via VNC with, for example, a smartphone or a tablet.

See [Chapter 13.12.3, "How to set up remote operation from a smart device"](#), on page 568.

13.6 LXI settings

On the R&S SMCV100B, an LXI functionality is already installed and enabled, see [LXI status settings](#). Thus, you can access the instrument using any web browser to perform the following tasks:

- Modifying network configurations, see [Chapter 13.6.2.1, "LAN configuration"](#), on page 538.
- Accessing the instrument remotely
- Analyzing SCPI remote diagnostics

13.6.1 LXI status settings

Access:

- ▶ Select "System Config > Setup > Remote Access > LXI Status".

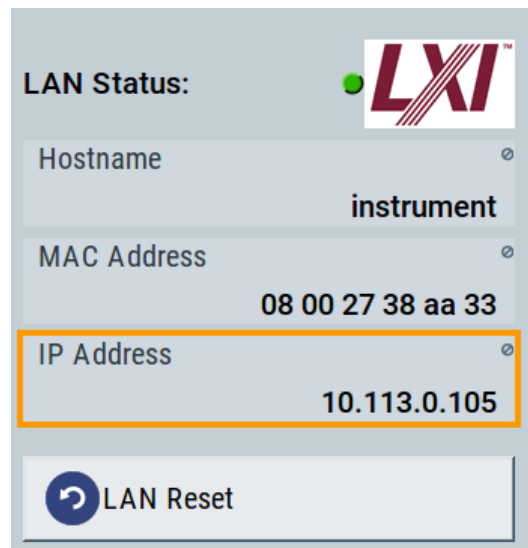

The LXI "LAN Status" dialog shows the parameters of the LAN connection.

Alternatively, you can change the LAN settings using the LXI web browser interface, see [Chapter 13.6.2.1, "LAN configuration"](#), on page 538.

LAN Status

The LED indicates the LXI status.

"green"	Normal operation
"green (flashing)"	Device identification
"red"	LAN fault

Hostname / MAC Address / IP Address

See ["Hostname"](#) on page 519.

LAN Reset

Initiates the network configuration reset mechanism for the instrument and resets the hostname, MAC address, and IP address.

According to the LXI standard, a LAN reset must set the following network parameters to a default state:

Parameter	Value
TCP/IP mode	DHCP + Auto IP address
Dynamic DNS	Enabled
ICMP ping	Enabled
Password for LAN configuration	LxiWebIfc

The LAN reset also resets the following parameters for the vector signal generator:

Parameter	
Hostname	Instrument-specific hostname
Description	
Negotiation	Auto detect
VXI-11 discovery	Enabled

13.6.2 LXI browser settings

The LXI browser functionality enables you to control the instrument remotely over a web browser.

Access:

- ▶ In the address field of the browser, enter the URL address, composed of the instrument's IP address or host name, for example *http://10.113.1.151*.

Note: Do not add the missing zeros in the IP address, while opening the instrument homepage.

The instrument homepage (welcome page) opens.

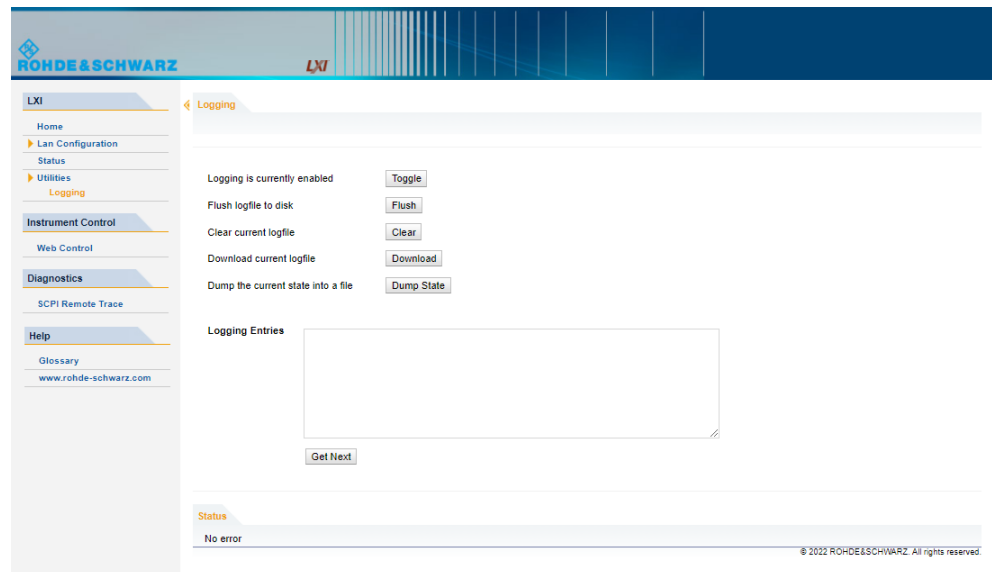

The navigation pane of the browser interface contains the following elements:

- "LXI"
 - "Home" opens the instrument homepage. The homepage displays the device information required by the LXI standard, including the VISA resource string in read-only format.
 - "Device Indicator" activates or deactivates the LXI status indication. When activated, the LXI LED flashes. A green LXI status symbol indicates that a LAN connection has been established; a red symbol indicates that no LAN cable is connected.
 - "Lan Configuration" allows you to configure LAN parameters and to initiate a ping, see ["Ping client"](#) on page 540.
 - "Status" displays information about the LXI status of the instrument.
 - "Utilities" provides access to the LXI event logging functionality required by the LXI standard.
- "Instrument Control"
 - "Web Control" provides remote access to the instrument, see ["To start remote control with the LXI web browser"](#) on page 548.
- "Diagnostics"
 - "SCPI Remote Trace" records messages exchanged via the remote control interface, see [Chapter 13.6.2.2, "SCPI remote trace"](#), on page 541.
- "Help"
 - "Glossary" explains terms related to the LXI standard.
 - www.rohde-schwarz.com opens the Rohde & Schwarz homepage.

13.6.2.1 LAN configuration

The "LAN Configuration" web page displays all mandatory LAN parameters and allows their modification.

It comprises the following navigation entries.

- [IP configuration](#)..... 539
- [Advanced config](#).....539
- [Ping client](#).....540

IP configuration

The "IP configuration" web page displays all mandatory LAN parameters and allows their modification.

The screenshot shows the LXI web interface for LAN Parameters configuration. The left sidebar contains navigation options like Home, Lan Configuration, Instrument Control, Diagnostics, and Help. The main content area is titled 'LAN Parameters' and contains the following fields:

- Hostname: <host name>
- DNS Hostname(s): <host name.xxx.net>
- Domain: rsint.net
- Description: <instrument>
- IP Address Mode: DHCP + Auto IP Address (dropdown)
- IP Address: 10.102.189.51
- Subnet Mask: 255.255.252.0
- Default Gateway: 10.102.188.1
- Obtain DNS Server Address automatically:
- DNS Server(s): 10.0.2.166 (with a secondary field containing 10.0.23.159)
- Register Device at DNS Server dynamically:
- HiSLIP Port: 4880

A 'Submit' button is located below the fields. A note on the right states: 'Attention! Changing the hostname reboots the device!'. A status bar at the bottom indicates 'No error'.

The "IP Address Mode" selects a configuration mode for the IP address of the instrument. With static configuration, the entered IP address, subnet mask, and default gateway are used. With dynamic configuration, DHCP or dynamic link local addressing (automatic IP) is used to obtain the instrument IP address.



Changing the LAN configuration

This function is password-protected. Unlock the protection level 1 to access it.

Note: We recommend that you change the default password before connecting the instrument to a network.

How to:

- ["Changing the default user password of the instrument"](#) on page 494.
- ["Changing the default security password"](#) on page 494.

See [Chapter 12.6.4, "Password management"](#), on page 491.

Advanced config

The "Advanced Config" web page provides LAN settings that are not declared mandatory by the LXI standard.

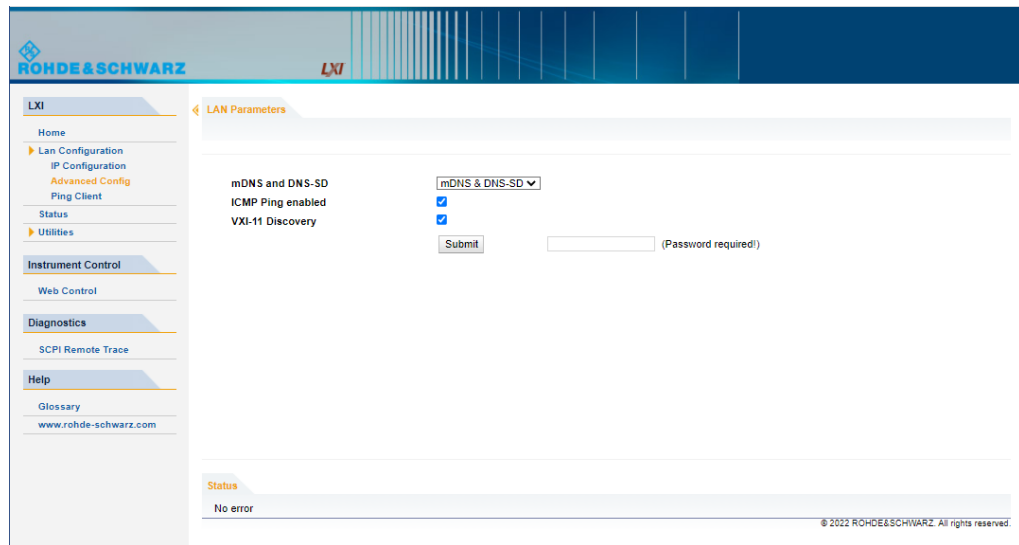

The following advanced parameters are available:

- "mDNS and DNS-SD": The additional protocols "multicast DNS" and "DNS service discovery" are used for device communication in zero configuration networks, working without DNS and DHCP.
- "ICMP Ping": Must be enabled to use the ping utility.
If you disable this setting, the instrument does not answer ping requests. The setting does not affect the LXI ping client. You can ping other hosts from the instrument, even if the setting is disabled.
- "VXI-11 Discovery": Must be enabled to detect the instrument in the LAN.
If you disable this setting, the instrument cannot be detected by the VXI-11 discovery protocol mechanism. The setting does not affect other detection mechanisms. Setting up a VXI-11 connection via the IP address or the host name is independent of this setting.



Changing the LAN configuration

This function is password-protected. Unlock the protection level 1 to access it.

Note: We recommend that you change the default password before connecting the instrument to a network.

How to:

- ["Changing the default user password of the instrument"](#) on page 494.
- ["Changing the default security password"](#) on page 494.

See [Chapter 12.6.4, "Password management"](#), on page 491.

Ping client

The "Ping Client" page provides the ping utility to verify the connection between the LXI-compliant instrument and another device.

The ping is initiated from the instrument. Using the `ICMP` echo request and echo reply packets, this function checks whether the communication with a device via LAN is working. Ping is useful for the diagnosis of IP network or router failures.

To initiate a ping at the instrument:

1. On the "Ping Client" page, enter the IP address of the host in the "Destination Address" field (for example 10.113.1.151).
2. Select "Submit".



13.6.2.2 SCPI remote trace

The remote trace functionality allows you to trace input and output strings at the remote control interface of the R&S SMCV100B, see [Chapter 13.9, "To trace messages with the LXI web browser interface"](#), on page 554.

A recorded trace (message log) can be evaluated directly in the dialog. Use the highlighting and navigation functions provided by the lower toolbar to locate error messages and messages containing arbitrary search strings. You can also export the message log to a *.csv file and evaluate the file using a suitable program.

To trace and display messages, switch on "logging" and "live mode" in the toolbar.

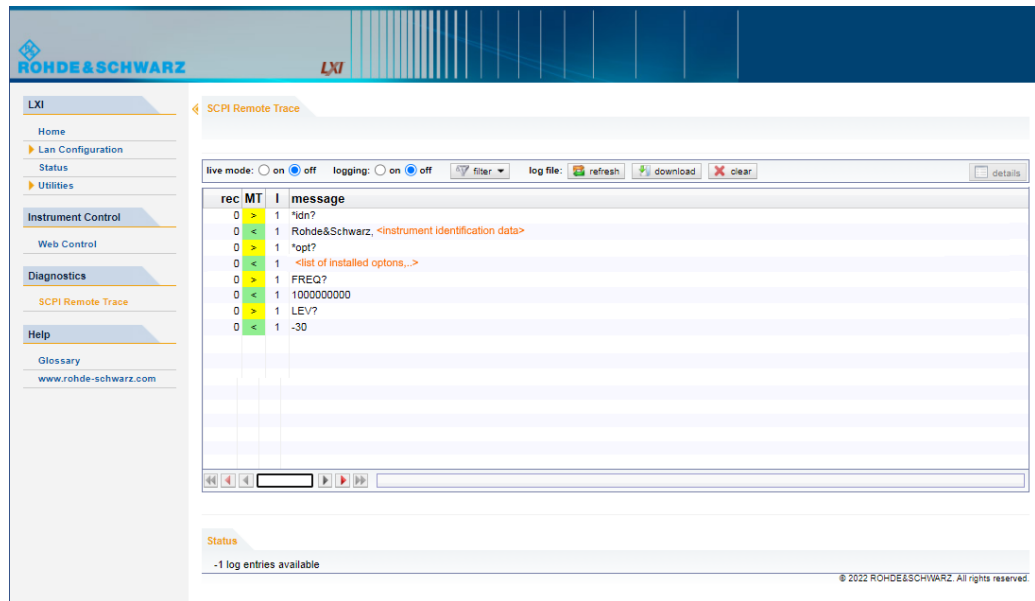

Toolbars

The toolbar at the top of the dialog provides basic settings and functions.

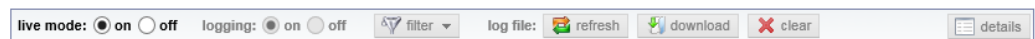

- "Live mode" / "logging": If logging is switched on, messages are traced. They are stored in an internal database and can be displayed upon request, using the refresh button (live mode off) or they can be displayed automatically (live mode on).
- "Filter": applies a filter to columns and/or rows when working (live mode off)
- "Refresh": reads the message log from the internal database and displays it
- "Download": stores the SCPI trace log to a * .CSV file
- "Clear": deletes all message log entries in the database and at the screen
- "Details": displays details of the selected message, for example an SCPI command in hex format (also possible by double-clicking a message)

Columns

The following columns are available if no column filter is applied:

- "Rec": record number of the message within the message log
- I: number of the subinstrument
- "MT": indicates the type of the message. Possible values and related message contents are:
 - > = incoming command
 - < = outgoing response to a query
 - E = error message, highlighted by red color
 - T = execution time, i.e. time required by the instrument to process the command internally.

To configure the instrument for remote access

- "message": indicates the type of the message. Possible values and related message contents are:
 - > = incoming command
 - < = outgoing response to a query
 - E = error message, denoted in red
 - T = execution time, i.e. time required by the instrument to process the command internally

13.7 To configure the instrument for remote access

The R&S SMCV100B is equipped with a network interface and can be connected to an Ethernet LAN (local area network).

There are two methods to establish a LAN connection to the instrument:

- A non-dedicated network (Ethernet) connection from the instrument to an existing network.
- A dedicated network connection (Point-to-point connection) between the instrument and a single computer.

How to: see [Chapter 3.1.7, "Connecting to LAN"](#), on page 27.

For identification in the network, all devices require an IP address.

How to:

- [To find the VISA resource string](#).....543
- [To configure the acces over LAN](#)..... 544

13.7.1 To find the VISA resource string

- ▶ Select "System Config > Remote Access > VISA Resource Strings".

Network	Visa Resource Strings	Instrument Emulations	Remote Connections	HUMS	QR-Code		✕
HISLIP						TCPIP::10.111.1.35::hislip0::INSTR	⊗
VXI11						TCPIP::10.111.1.35::inst0::INSTR	⊗
Socket						TCPIP::10.111.1.35::5025::SOCKET	⊗
USB						USB::0x0AAD::0x0248::000000::INSTR	⊗

The dialog shows all specified resource strings of the supported remote control interfaces.

13.7.2 To configure the access over LAN

Depending on the network capacities, the TCP/IP address information for the instrument can be obtained in different ways.

- If the network supports dynamic TCP/IP configuration using the **DHCP** protocol, this service assigns all address information automatically.
- If the network does not support DHCP, the instrument tries to obtain the IP address by using the Zeroconf (Avahi) protocol.

The automatic address configuration assigns the address information automatically. Thus it is safe to establish a physical connection to the LAN without any previous instrument configuration.



If the dynamic TCP/IP configuration does not succeed, or if the instrument is expected to use alternate TCP/IP configuration, you must set the address information manually.

13.7.2.1 How to assign the IP address

If necessary, you can assign the IP address manually. It is assumed that you have connected controller PC and the instrument.

To assign the IP address manually on the instrument

1. Obtain the IP address and subnet mask for the R&S SMCV100B and the IP address for the local default gateway from your network administrator. If necessary, also obtain the name of your DNS domain and the IP addresses of the DNS server on your network.
2. On the instrument, select "System Config > Remote Access > Network".
3. Select "Address Mode > Static".
4. Select the "IP Address".
5. Enter the IP address, for example *192.168.0.1*.

The IP address consists of four number blocks separated by dots. Each block contains 3 numbers in maximum.

6. Select the "Subnet Mask" and enter the subnet mask, for example *255.255.255.0*.
The subnet mask consists of four number blocks separated by dots. Each block contains 3 numbers in maximum.

Note: The subnet mask must be the same for both, the R&S SMCV100B and the host interface, the instrument is connected to.

To assign the IP address manually on the computer

- ▶ Obtain the necessary information from your network administrator. If you use more than one LAN connector, you need separate address information for each connector.

For information on how to configure the address information, see the documentation of the operating system the computer uses.

13.7.2.2 How to use the hostname

In a LAN that uses a **DNS** server, each computer or instrument connected in the LAN can be addressed with an unambiguous **Hostname** (also referred to as computer name) instead of the IP address. The DNS server translates the hostname to the IP address.



Using the hostname is useful in networks with dynamic TCP/IP and DHCP protocol services, that assign the address information automatically. Thus, it can be that the services assign a new IP address each time the instruments restarts, but they do not change the hostname.

Each instrument is delivered with an assigned hostname, that remains constant as long as it is not explicitly changed.

This function is password-protected. Unlock the protection level 1 to access it.

The default *hostname* name follows the syntax <INST>-<Serial Number>, where:

- <INST> is the short name of your instrument, as stated on the front panel.
- <Serial Number> is the individual serial number of the instrument.

You can find the serial number at the rear panel of instrument. It is the third part of the device ID printed on the barcode sticker.



Example:

The default hostname of an R&S SMCV100B with a serial number 102030 is SMCV100B-102030.

To query and change the hostname

1. Select "System Config > Remote Access > Network".

Section "Instrument Name" displays the assigned "Hostname".

Note: This function is password-protected. Unlock the protection level 1 to access it.

2. Select "System Config > Setup > Security > Protection".
3. Enable the "Protection Level 1".

The default protection level 1 password is *123456*.

The parameter "Hostname" in the "Network" tab is now enabled for configuration.

To configure the instrument for remote access

4. Change the "Hostname".

13.7.2.3 How to configure LAN interface access and services

By default, the LAN interface and the supported LAN interface services are enabled.

For security reasons, for example to protect the instrument against unauthorized access, you can block either the LAN services individually, or the access over LAN in general.

To disable LAN access in general

1. Select "System Config > Setup > Security".
2. Select "Security".
3. Select "LAN Services".
4. Disable "LAN" state.
5. Enter the [Security Password](#).
6. Select "Accept".

When disabled, communication over the LAN connection is not possible.

To disable LAN services individually

1. Select "System Config > Setup > Security".
2. Select "Security".
3. Select "LAN Services".
4. Enable "LAN" state.
5. In the "Common Services" side tab, uncheck all services you want to block.

General	LAN Services	Password Management	
LAN	<input checked="" type="checkbox"/>		
SCPI over LAN <i>is Enabled</i>	<input checked="" type="checkbox"/>	FTP <i>is Disabled</i>	<input type="checkbox"/>
SMB (Samba) <i>is Enabled</i>	<input checked="" type="checkbox"/>	SSH (SCP) <i>is Disabled</i>	<input type="checkbox"/>
HTTP <i>is Disabled</i>	<input type="checkbox"/>	Software Update <i>is Enabled</i>	<input checked="" type="checkbox"/>
		VNC <i>is Disabled</i>	<input type="checkbox"/>
		Remote Support <i>is Disabled</i>	<input type="checkbox"/>
		Avahi (Zeroconf) <i>is Enabled</i>	<input checked="" type="checkbox"/>
Security Password		<input checked="" type="checkbox"/> Accept	

6. Select the "Samba Services" sidetab.

To establish a remote control session over LAN

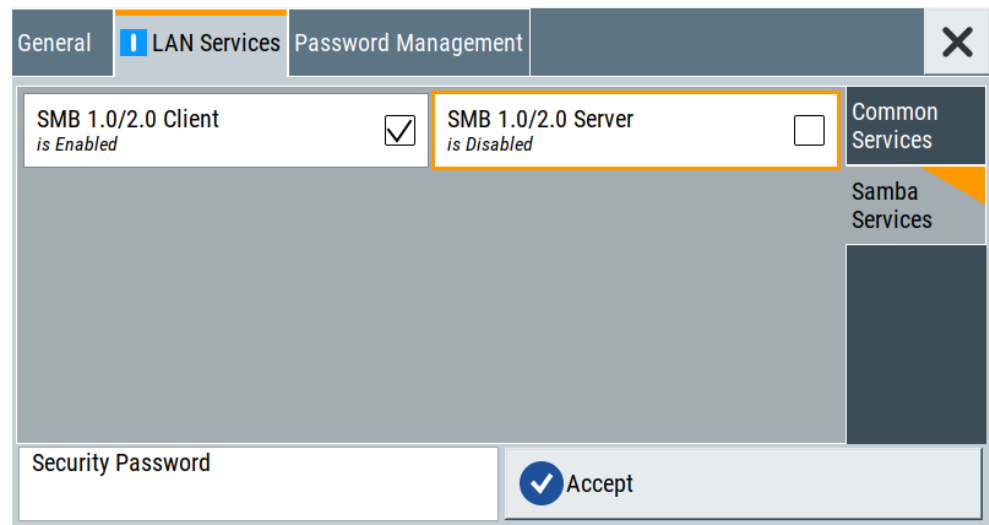

7. For example, uncheck "SMB 1.0/2.0 Server" to block the access for the SMB Samba server.
8. Enter the [Security Password](#).
9. Select "Accept".

13.8 To establish a remote control session over LAN

This section shows you how to establish remote control connections over the available interfaces.

The following general prerequisites must be fulfilled:

- The instrument and the controller have to be connected over the corresponding interface with the suitable cable.
- The instrument and the controller must be switched on.
- To operate the instrument remotely, it must be addressed using the defined interface address.

See:

– [Chapter 13.2.1, "LAN interface"](#), on page 502

- A remote control program must open a connection to the instrument, before it can send commands to and receive device responses from the instrument.



If security is a concern, see:

- [Document Instrument Security Procedures](#).
- [Chapter 12.6.5, "How to prevent unauthorized access"](#), on page 493.

- [To establish the connection with the LXI web browser](#)..... 548
- [To establish the connection using VXI-11 protocol](#).....548
- [To establish the connection using socket communication](#)..... 553

13.8.1 To establish the connection with the LXI web browser

Using the LXI browser interface you can access and control the R&S SMCV100B instrument remotely from another PC without additional installation. File upload and download between the instrument and the remote PC is also available.

To start remote control with the LXI web browser

1. On the instrument, make sure the LAN interface is enabled. Enable the LAN interface on the instrument, if necessary.
See [Chapter 12.6.3, "Configuring LAN services"](#), on page 488.
2. Connect the remote PC and the instrument in the same network.
See [Chapter 3.1.7, "Connecting to LAN"](#), on page 27 .
3. On the remote PC, start a web browser that supports HTML5 (W3C compliant).
4. Enter the IP address of the R&S SMCV100B in the browser's address bar.
The R&S SMCV100B's welcome page is displayed.
5. In the navigation pane, select "Instrument Control" > "Web Control".
Remote access to the instrument requires the password. The default password is *instrument*.
6. Enter the password and confirm with the [Enter] key.
After the connection is established, the current screen of the R&S SMCV100B is displayed in the browser window.
7. Use the mouse cursor and keyboard to access the functionality of the instrument as you would directly perform on the instruments touchscreen and front panel.

13.8.2 To establish the connection using VXI-11 protocol

In this example, the I/O software library R&S VISA from Rohde & Schwarz is used to set up a LAN remote control link and remotely control the R&S SMCV100B. R&S VISA is running on a controller PC with Windows operating system. When the connection is set up, you can send commands to the instrument and receive the responses.

The remote control connection requires a VISA installation but no additional hardware on the controller PC. The LAN I/O channel is selected at initialization time using the VISA resource string (also referred to as "address string"). A VISA alias (short name) is used to replace the complete resource string. The host address is the R&S SMCV100B's hostname or its IP address.

See also [Chapter 13.2.1, "LAN interface"](#), on page 502.

To set up the controller with R&S VISA

To remote control the R&S SMCV100B, we use the R&S VISA Tester application. The application communicates via TCP/IP protocol.

To establish a remote control session over LAN



The instrument is preconfigured for networks using DHCP (dynamic host configuration protocol). If this configuration is used, enter the computer name in the position of the IP address.

1. On the instrument, make sure, that the LAN interface and "SCPI over LAN" are enabled.
See [Chapter 12.6.3, "Configuring LAN services"](#), on page 488.
2. On the controller (remote PC), install the R&S VISA program.
See <http://www.rohde-schwarz.com/rsvisa> > "RS VISA Release Notes".
3. Connect the controller and the instrument in the same network (network cable).
Switch them on.
See also [Chapter 3.1.7, "Connecting to LAN"](#), on page 27.
4. On the controller, start "R&S VISA > Tester 32bit" or "R&S VISA > Tester 64bit".

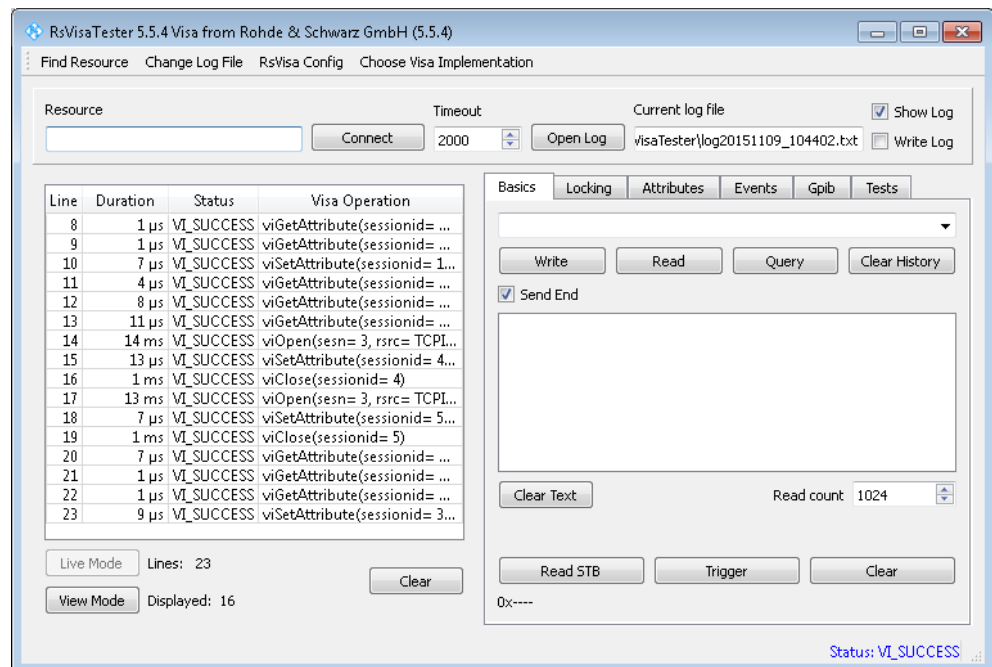

5. In the menu bar, select "Choose VISA Implementation > Rohde & Schwarz Visa" and confirm with "OK".

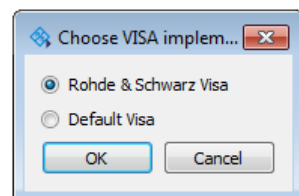

6. In the menu bar, select "Find Resource" to search for the instrument in the LAN.

To establish a remote control session over LAN

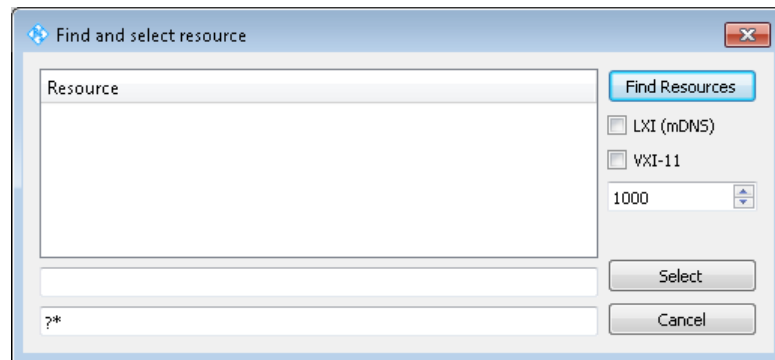

7. Select "VXI-11" and "Find Resources".

R&S VISA scans the network for connected instruments and lists all detected instruments in the "Resource" list.

Note: The search may take some time, particularly in large networks.

8. Select the required instrument and confirm with "Select".

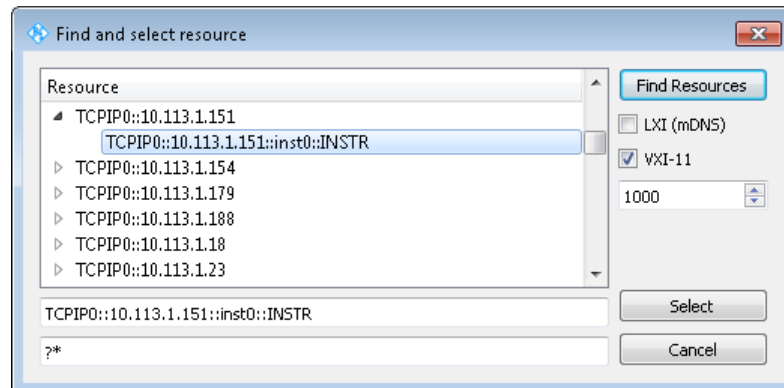

The "Find and select resource" dialog closes and R&S VISA indicates the IP address in the "Resource" field of the main application window.

9. As an alternative to the IP address, you can assign an alias name to the R&S SMCV100B:

- a) In the menu bar, select "RsVisaConfig".

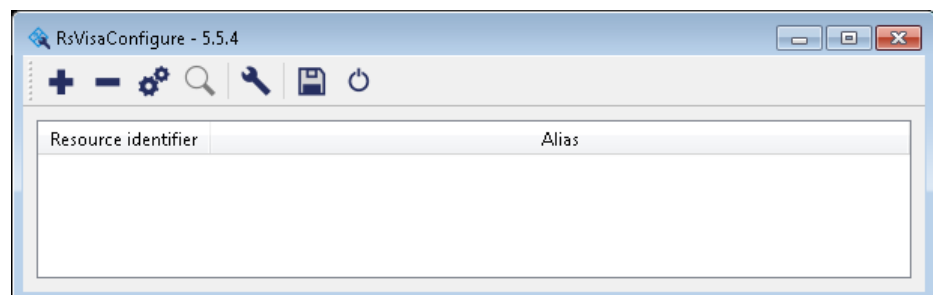

- b) In the toolbar, select "+" to access the "VISA Resource String Composer".

To establish a remote control session over LAN

- c) Fill in the "Alias" name, the "VISA Resource String" and the "Device IP Address or hostname" as shown in the figure, and confirm with "OK".

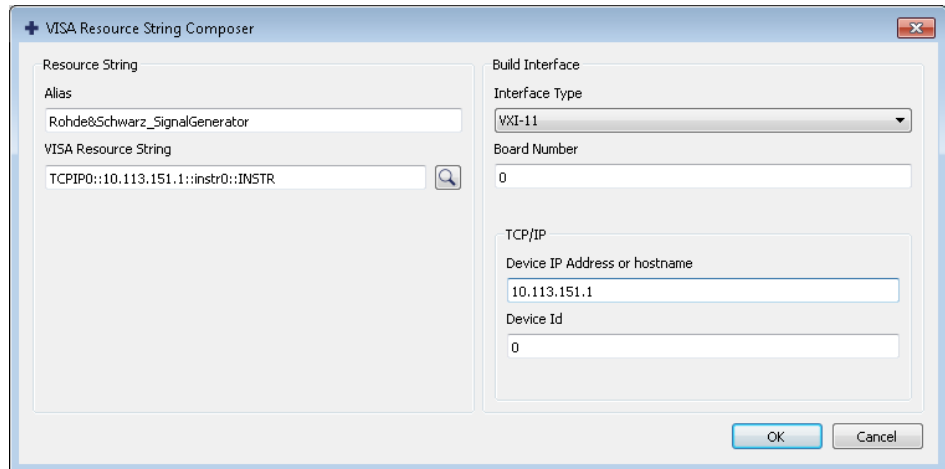

The "Alias" name is assigned.

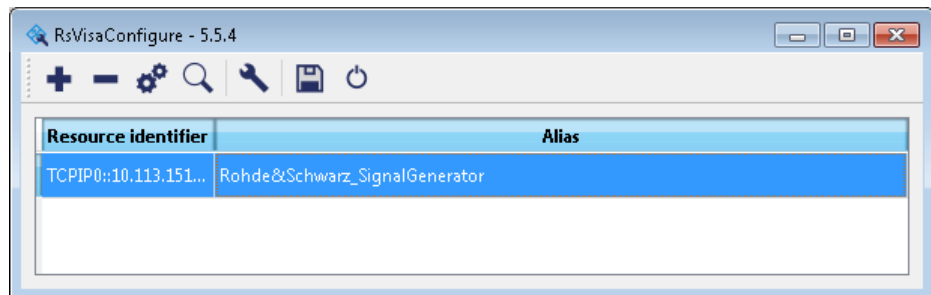

- d) Close the dialog.
The R&S SMCV100B is registered in the program. It can be addressed via the resource string or alias name.

10. In the main window, select "Connect".

R&S VISA establishes the connection to the R&S SMCV100B.

You can send settings to configure the instrument and receive its responses.

Note: If the connection cannot be set up, R&S VISA displays an error in the log view.

See also [Chapter 15.5, "Resolving network connection failures"](#), on page 845.

For further information on the functions to read and write to an open session, and the utility applications the software provides, see the R&S VISA user manual.

To start remote control with R&S VISA

To set the instrument to remote control, you can use the addressed command `>R` or send any command from the controller.

1. Start the R&S VISA Tester.
Establish the connection to the R&S SMCV100B.
See ["To set up the controller with R&S VISA"](#) on page 548.

To establish a remote control session over LAN

- In the R&S VISA "Basics" tab, enter a SCPI command, e.g. "*IDN?". Confirm with "Query".

The instrument is switched to remote control when it receives a command from the controller.

- Select "Read" to obtain the instrument response.

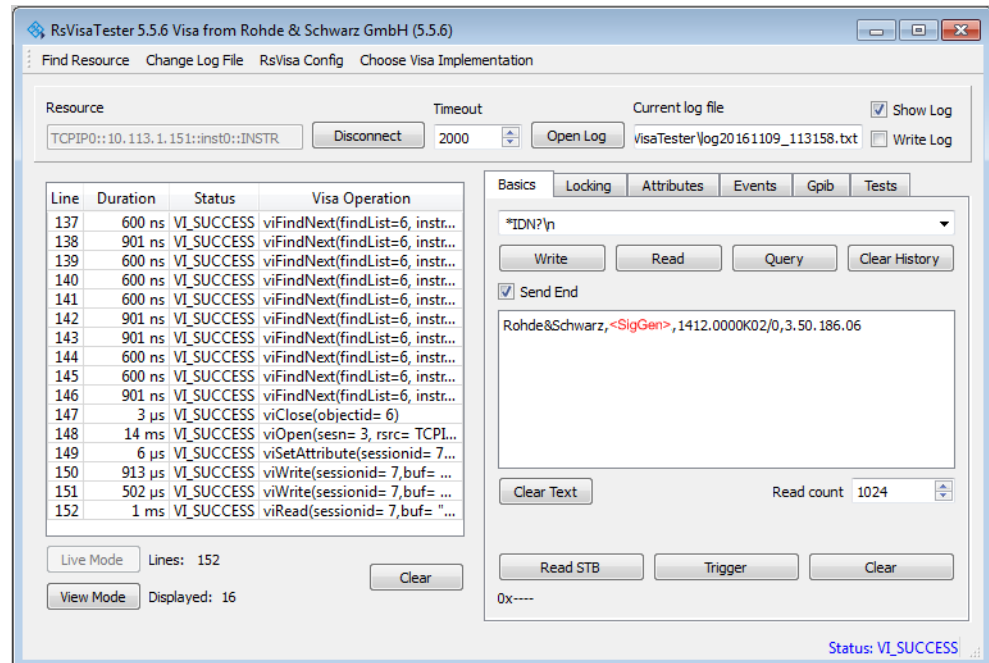

Tip: If the "Show Log" checkbox is checked, R&S VISA displays each VISA function call in the log-view on the left. If you check the "Write Log" checkbox, the log-view entry is written to the log file as well. You can operate the log-view in two modes: the "Live Mode" shows only the most recent messages whereas the "View Mode" allows you to scroll the history.

- To check the performed setting, `SOUR1:FREQ?` and select "Query".

While remote control is active, the "Remote" icon in the status bar indicates that the instrument is in remote control mode. Currently ongoing communication (data transfer) is indicated by green colored arrows in the icon.

Operating via the front and touch panel or via mouse and keyboard are locked, allowing a remote control program to be performed without interruption. On the display, keys and entry fields are grayed out and cannot be activated or modified, but you can still open dialogs, for example to verify settings.

- To disable the access to the dialogs, use the command `SYST:KLOC ON`.
- To prevent unintentional return to manual operation, use the command `&LLO`.
The instrument switches to "Remote LLO" state.
- To return to manual operation, see [Chapter 13.10, "To return to manual operation"](#), on page 555.

To establish a remote control session over LAN

Tip: Switching from manual operation to remote control and vice versa does not affect the other instrument settings.

13.8.3 To establish the connection using socket communication

This section provides an example on how to establish a remote control connection over Telnet client and a simple sockets-based program example that can be further developed.



The telnet client transmits information unencrypted. Therefore, for sensitive information we recommend that you use a client which supports secure protocols, like SSH.

In the following example, we assume basic knowledge of programming and operation of the controller. You can find information on the interface commands in the corresponding manuals.

To set up a Telnet connection

To control the software, only a Telnet program is required. The Telnet program is part of every operating system.

1. On the instrument, make sure, that the LAN interface and "SCPI over LAN" are enabled.
See [Chapter 12.6.3, "Configuring LAN services"](#), on page 488.
2. Connect the remote PC and the instrument in the same network.
See [Chapter 3.1.7, "Connecting to LAN"](#), on page 27.
3. On the remote PC, start the Telnet program.
Enter the socket address.
The socket address is a combination of the IP address or the hostname of the R&S SMCV100B and the number of the port configured for remote-control via Telnet.
Tip: The R&S SMCV100B uses the port number 5025 for remote connection via Telnet.

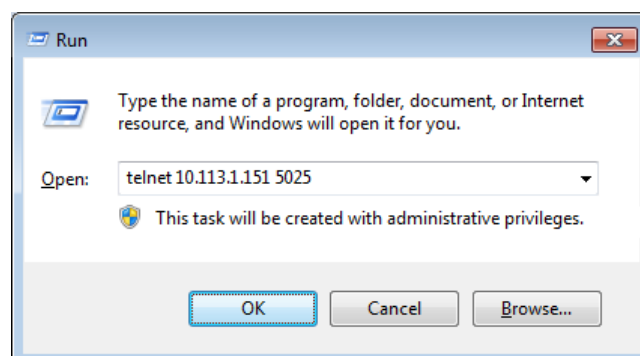

The connection to the instrument is set up and you can send remote-control commands.

To trace messages with the LXI web browser interface

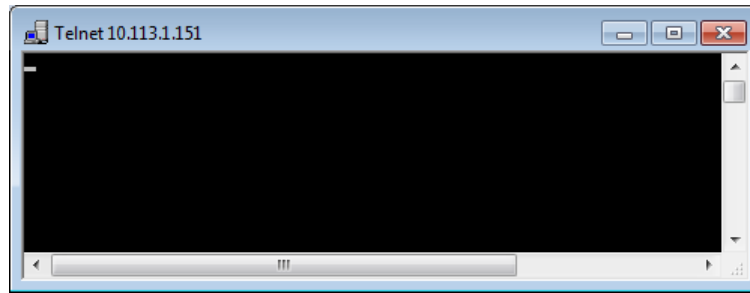

4. Telnet does not reflect your first entry.
Insert a command, e.g. *IDN and confirm with "Enter".
5. Observe the screen.
A response on the query confirms that the connection is working. The client displays all subsequent inputs and responses.
6. Even if the cursor is not visible on the screen, blindly enter a remote-control command. Confirm with Enter.

13.9 To trace messages with the LXI web browser interface

The remote trace functionality allows you to trace commands and messages exchanged via a remote control interface of the R&S SMCV100B.

To activate SCPI remote trace

1. On the instrument, make sure, that the LAN interface and "SCPI over LAN" are enabled.
See [Chapter 12.6.3, "Configuring LAN services"](#), on page 488.
2. Connect the remote PC and the instrument in the same network.
See also [Chapter 3.1.7, "Connecting to LAN"](#), on page 27.
3. Start a web browser that supports HTML5 (W3C compliant).
4. Enter the IP address of the R&S SMCV100B in the browser's address bar.
The welcome page is displayed.
5. In the navigation pane, select "Diagnostics > SCPI Remote Trace".
6. In the toolbar bar of the "SCPI Remote Trace" page, select "live mode > on" and "logging > on".
"live mode > on" displays all commands and responses, and "logging > on" also traces messages.

If you now control the R&S SMCV100B with SCPI commands, using an appropriate tool, the LXI function records the information sent and received.

The function records all sent commands, received responses and messages, and saves them in an internal database. If "live mode" is disabled, you can display the recent traces upon request, using the "refresh" button. You can also save the log in a file.

Note: The diagnostics functionality is extended in later releases, e.g. to download or upload SCPI command files from / to the instrument.

13.10 To return to manual operation



Before returning to manual control, command processing must be completed. Otherwise, the instrument switches back to remote control immediately.

1. To return from "Remote" state to manual state, perform one of the following:
 - On the controller, use the command `>L`

Note: If `&NREN` has been set before `>L` is locked. Use `>R` instead.
 - In the status bar, select the "Remote" icon.
 - In the block diagram, select "Context sensitive menu > Key Emulation > Local"
2. **Note:** In the local lockout state, the command `>L` is locked. You can unlock this state only over remote control.

To return from "Remote LLO" state to manual or to "Remote" state, perform one of the following:

To return from "Remote LLO" state to manual or to "Remote" state, perform one of the following:

 - On the controller, use the command `&LOCS`.
This command switches directly to manual operation.
 - Send the command `&REMS`.
This command changes the remote control state from "Remote LLO" to "Remote".
 - Use the Visual Basic command `CALL IBLOC (generator%)`.
The command switches directly to manual operation.
 - VISA function `viGpibControlREN()`
This function switches directly to manual operation.

13.11 To automate tasks with remote command scripts

To achieve fast configuration, make complex test setups or repeating measurements reproducible, you can automate the required settings with scripts. A script contains a series of SCPI commands corresponding to the settings. When completed, it is converted to an executable format, saved in a file and can be run whenever needed.

To automate tasks with remote command scripts



If you frequently need to load and run a script, assign the script to the [★ (User)], and you can quickly and easily perform the task.

See [Chapter 12.4.4, "How to assign actions to the \[★ \(User\)\] key"](#), on page 465.

In contrast to "Recall Setup" via the [★ (User)] key, an assigned script execution does not close active dialogs and windows. On the contrary, even active window control (open / close) is possible.

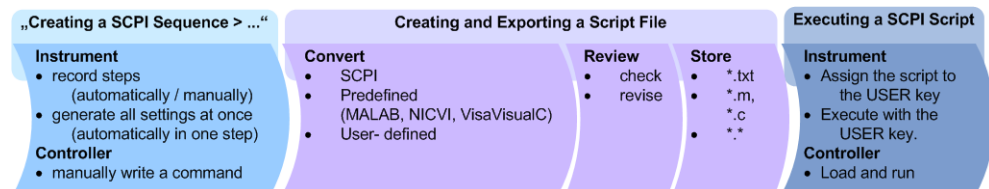

Figure 13-8: Steps for performing SCPI Scripts

In the graph, you can see the main steps required to work with a SCPI script.

Creating a SCPI list

With the SCPI record functions, you can create a SCPI command list directly in the instrument and then export the list to the controller. If you want to edit or write a script manually, use a suitable editor on the controller. Even for manually creating, the instrument supports you by showing the corresponding command syntax and the current settings value.

Directly in the instrument, you can create a SCPI list at any time of operation, in the following ways:

- Recording steps

Both, automatic and manual SCPI recording of settings is possible. You can start, stop and resume automatic recording, and also record individual commands manually.

 - Manually record the steps selectively

In manual recording mode, you can deliberately record a SCPI command with the "Add CPI Command to Recording List" function, see [How to record SCPI lists manually](#).
 - Automatically record all performed steps

The instrument records the SCPI command and settings value of each step you perform, and then writes the commands to the file system, see [How to record SCPI lists automatically](#).

You can also add a SCPI command manually to the recording list during automatic SCPI recording.

Note: The vector signal generator clears the SCPI list after booting automatically.
- Generating all settings at once

Generates the SCPI commands of the current instrument settings in one step, and writes the command list in a temporary list, see [How to create a SCPI list with the current instrument settings in one step](#).

Note: This function lists all commands in alphabetical order, in contrast to the recording or manual creation, which consider the order the settings are configured.

To automate tasks with remote command scripts

Using this function can slow down the runtime or cause errors during execution. Therefore, always check and revise a script if necessary, see ["How to check a SCPI list"](#) on page 563.

- Manually create a command script with "Copy" and paste
Enables you to copy the SCPI command and the current setting, see [Chapter 13.11.1, "Show SCPI command"](#), on page 558.



Some parameters cannot be set by a SCPI command.

If so, *no SCPI command found* is entered instead of a command when you record or generate all settings at once.

The difference between Show SCPI Command and the provided cross-reference

If you want to enter your settings in a script, or use a remote control program, you must know the corresponding SCPI command and the exact syntax.

If you need to look up the SCPI command, the instrument offers two ways to figure it out quickly.

- "Show SCPI command" (context-sensitive menu)
Displays the SCPI command syntax of a selected parameter including the current setting value, see ["Finding out the SCPI command with the "Show SCPI Command" function"](#) on page 564.
The "Copy" function enables you to write a SCPI script conveniently by hand.
- Instrument help ([Help] key)
Opens a help topic that describes the selected parameter or instrument function, including a cross-reference to the corresponding SCPI command. The reference leads you to the description of the SCPI command comprising the complete SCPI syntax, all available setting values, value ranges, etc.
See ["Finding out the SCPI command using the online help"](#) on page 564.

Creating and exporting a script file

When the script list is completed, a code generator translates the SCPI commands into the source code of a proprietary programming language, using a code template. Therefore, each language requires an appropriate code template. When converted, you can save the script in a file with an extension corresponding to the programming language.

The R&S SMCV100B provides the following predefined code templates by default:

- Plain SCPI
Represents SCPI base format, that is ASCII format, saved as text file (*.txt).
- MATLAB
A programming environment, frequently used in signal processing and test and measurement applications (*.m).
You can directly use this format with MATLAB(c) Toolkit. For comprehensive information on this topic, refer to the application note [1GP60: MATLAB Toolkit for R&S Signal Generators](#).
- NICVI
An ANSI C programming environment designed for measurements and tests (*.c).
You can directly use this format with National Instruments LabWindows CVI.

- Python3
A general-purpose and high-level programming language (*.py).

You can also convert a script to a user-specific format. In this case, you need a code template with the extension *.expcodetmpl.

For information on how to select the code template and save the script in a file, see [Chapter 13.11.3, "SCPI recording export settings"](#), on page 559.

Executing a SCPI script

A SCPI script primarily runs on the controller PC. In addition, you can execute a script directly on the instrument, by assigning the script to the [★ (User)] key.

See [Chapter 12.4.4, "How to assign actions to the \[★ \(User\)\] key"](#), on page 465.

13.11.1 Show SCPI command

Access:

1. Select the parameter.
2. Open the context-sensitive menu (tap and hold).
3. Select "Show SCPI Command".

This function provides the syntax of the remote command with the current setting.

Copy

Copies the command and the current setting.

Close

Exits the "SCPI Command" dialog.

13.11.2 Displaying an SCPI list

The instrument displays a recorded SCPI list and thus provides viewing the recorded results before exporting.

- ▶ Depending on the starting point, you can access the "SCPI Recording List" dialog as follows:
 - During recording
Select "Show SCPI Recording List" in the context-sensitive menu.
 - At any time outside recording
Select "Show SCPI Recording List" in the context-sensitive menu.
This function assumes that at least one recording has been executed after power-on.
 - At the end of the recording
Select "Stop automatic SCPI recording". The dialog opens automatically.

To automate tasks with remote command scripts

- After you have exported the script to a file.
Select "SCPI Recording Export > Show file content"
See [Chapter 13.11.3, "SCPI recording export settings"](#), on page 559.

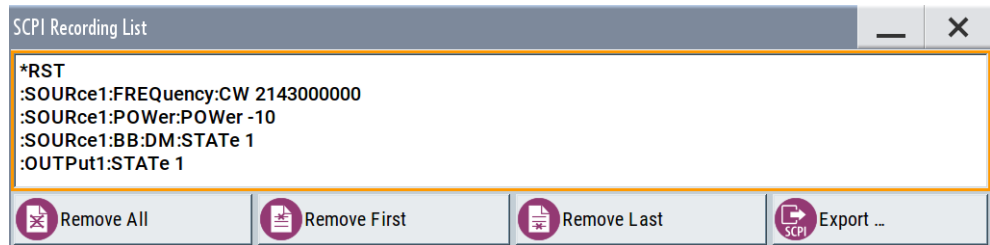

The "SCPI Recording List" shows the last recorded and exported commands.

SCPI Recording List

Lists the automatically or manually recorded recorded SCPI commands.

Export

Opens the [SCPI Recording Export](#) dialog for configuring the file parameters for export.

Remove All, Remove First, Remove Last

Deletes either the first, the last or all recorded SCPI commands.

To remove several recorded commands, repeat the removing.

For post processing, export the SCPI command list in a file, see [Chapter 13.11.5, "How to convert and save SCPI lists"](#), on page 563.

13.11.3 SCPI recording export settings

Scripts are configured and saved in the "SCPI Recording Export" dialog. This dialog opens automatically, when you stop recording.

Access:

1. Select "Show SCPI Recording List" in the context-sensitive menu.
The "SCPI Recording List" dialog opens.
2. Select "Export".

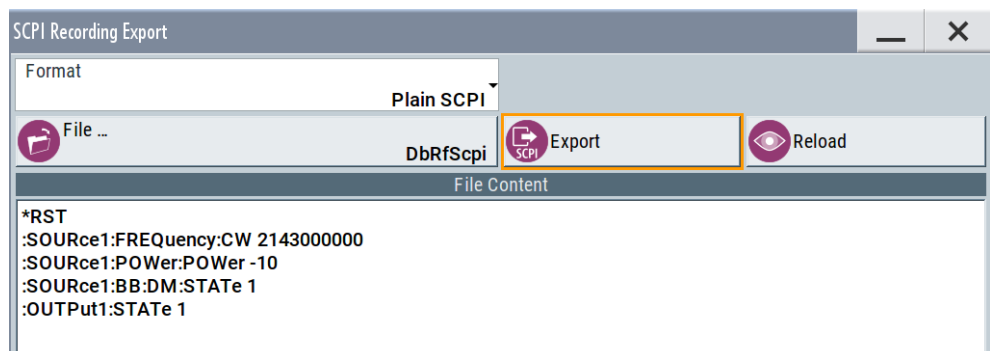

The "SCPI Recording Export" dialog contains all functions required for export of command lists to a file. It enables you to select the source code format, assign an individual filename and display the file content.

Format

Selects the source code format for the command list.

"Plain SCPI" Uses SCPI syntax.

"Predefined Code Generator"

Accesses the predefined templates for common source code generators that convert the recorded settings in the programming languages MATLAB or NICVI or Python.

"User Code Generator"

Use this setting to convert a script by a user-specific code generator.

Select Code Template

Opens the standard "File Select" dialog and lists the predefined or user-defined code templates.

File

Opens the standard file select dialog "Select Output File".

Export

Executes data export.

The SCPI list is saved in as file with the selected filename and in the selected directory, see [File](#).

Reload

Reloads a SCPI list from a file.

You can export recorded SCPI lists to files (see [File](#) and [Export](#)), that can be modified.

File content

Displays the content of the script in the selected format and code template.

13.11.4 How to record / create SCPI lists

How to record SCPI lists automatically

The following example briefly explains how to proceed when you want to record SCPI lists.

For comprehensive description, see [1GP98: SCPI Recorder Test Automation on a Fingertip](#).

1. On the screen, open the context-sensitive menu (touch and hold, or right mouse click) and select "Start SCPI recording".



Start SCPI Recording

Starting from now, all steps you perform are recorded.

2. To stop SCPI recording, select "context-sensitive menu > Stop SCPI recording".



Stop SCPI Recording

The "SCPI Recording List" dialog opens automatically.

3. Proceed with [How to check a SCPI list](#).

How to record SCPI lists manually

1. To retrace your settings, open the context-sensitive menu and select "Mark all Parameters Changed from Preset".



Mark All Parameters Changed from Preset

This function identifies and highlights all settings you have changed, both in the block diagram, and in the dialogs.

2. For selectively recording your steps:
 - a) Set the parameter.
 - b) Open the context-sensitive menu.
 - c) Select "Add SCPI Command to Recording List"



Add SCPI Command to Recording List

Tip: You cannot see "Add SCPI ..." in the menu?

A possible reason is opening the menu outside of a dialog or input field, for example in a block diagram. Open the context-sensitive menu within the corresponding dialog or input field, and the feature is available.

- d) Continue with the next setting, and repeat steps *a to b* whenever needed.

Each time you select "Add SCPI ...", the SCPI command is appended to a temporary list.

3. To check the progress of the recording, select "Context-Sensitive > Show SCPI Recording List".



Show SCPI Recording List (4)

The "SCPI Recording List" dialog opens, displaying all recorded settings so far.

4. Proceed with [How to check a SCPI list](#).

How to create a SCPI list with the current instrument settings in one step

You can also generate a SCPI list from a manually created instrument state at any time, in only one step.

To generate a SCPI list with commands for all settings performed:

1. Select "Save/Recall > SCPI Export".

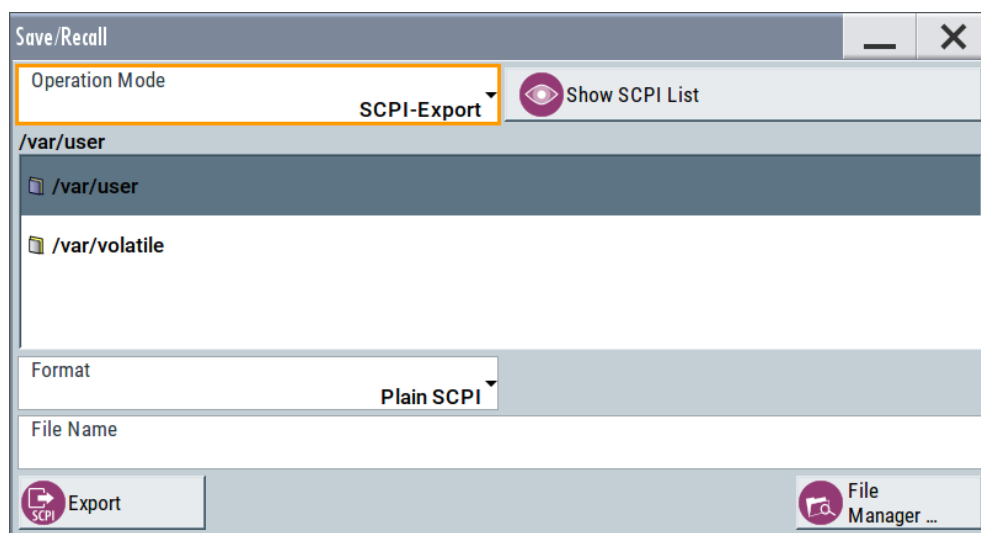

The instrument opens the standard file select dialog, see [Chapter 11.4.1, "Save/recall settings"](#), on page 422.

2. In the "Format" entry field, select the source code.
3. Depending on the selected format, convert the script as described in [Chapter 13.11.5, "How to convert and save SCPI lists"](#), on page 563
4. Enter a filename.
5. Select "Export".
The instrument writes all SCPI commands of the key parameters and the modified settings in the file. Also assigns the file extension automatically according to the source code format.
6. To preview the content of the SCPI list:
 - a) Select Save/Rcl.
 - b) Select "Operation Mode > SCPI-Export".
 - c) In the `/var/user/` directory, select a previously saved file.
 - d) Select "Show SCPI List".

The list of all SCPI commands is displayed, for example, for a final check.



Exporting the SCPI list of the instrument state in one step is a fast and convenient method. Nevertheless, it usually requires postprocessing on an external PC.

How to check a SCPI list

The easiest way to check a list, is to execute it. The generator returns a warning if a setting could not be performed.

However, we recommend that you check the list and possibly rework. It can be that ...

- A parameter has not assigned a SCPI command or an element of the user interface has not an assigned parameter. In these cases, `:SYST:INF:SCPI 'SCPI command not available'` is entered in the list instead. Such entries are also detected during execution. The instrument recognizes these incomplete commands and displays an error message.
- A preset has been executed, but several standards then perform some internal settings that are also assigned to the list with "SCPI Export".
- After a preset still some settings are defined, which are then written to the list generated with "SCPI Export."

Some suggestions on how you can check and revise a list:

1. Search and remove missing command entries.
2. Remove unnecessary content written after a preset.
3. Rearrange the commands to a reasonable order. If you, for example, set a `STATE` command to the last position of a list, you can avoid intermediate calculations of the signal.
4. Preview the list for completeness by comparing it with the modified settings in the manual mode.
 - a) To retrace your settings in manual operation, open the context-sensitive menu and select "Mark all parameters changed from preset". The function identifies all settings you have changed, both in the block diagram, and in the dialogs. They appear orange.
 - b) Check whether there is a command in the list for all modified settings.
5. To perform modifications, export the list to a PC, using for example a USB flash drive.

13.11.5 How to convert and save SCPI lists

After completing the recording, the "SCPI Recording Export" dialog opens.

1. Select the "Format" for the command syntax in which you want to save the list.
2. "Select Code Template"

Depending on the selected format, proceed accordingly:

Note: Select the code template **before** exporting.

 - a) Plain SCPI

Continue with the next step.

To automate tasks with remote command scripts

- b) Predefined code generator
The "SCPI Recording Export - Select Predefined Code Template" dialog opens. Select one of the predefined code templates.
 - c) User code generator
A file system ("SCPI Recording Export - Select User Code Template") dialog opens.
Select your user-defined code template. The code template must have file extension *.expcodetmpl.
3. Select "File..."
The "SCPI Recording Export - Select Output File" dialog opens.
 4. Select "New" and assign a filename for saving the recorded list.
 5. In the "SCPI Recording Export" dialog, select "Export".
Saves the recorded data either in ASCII format (plain SCPI), or in the corresponding format of the used code template, and shows the SCPI list in the "File Content" section.

13.11.6 How to find out the SCPI commands for GUI functions

Finding out the SCPI command with the "Show SCPI Command" function

1. To find out the SCPI command of a parameter in manual operation, select the parameter.
2. Open the context-sensitive menu and select "Show SCPI command"

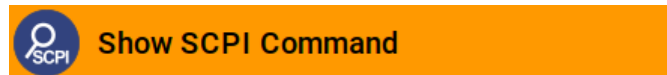

You get the detailed command syntax, including the currently set value.

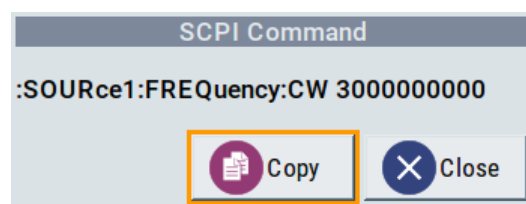

With the "Copy" function, you can conveniently paste the command including the current setting, e.g., in a command script.

Finding out the SCPI command using the online help

If you are looking for the remote command to a function in manual operation, you find it in the description of the online help.

1. To find out the SCPI command of a parameter in manual operation, select the respective parameter.

2. To open the corresponding help topic, select one of the following:
- In the display, select "context-sensitive menu > Help".



- On the front panel, press the [Help] key.

The help topic opens. Apart from the function description, it contains the SCPI command in detailed syntax.



How to find the corresponding GUI function to a command

Conversely, if you are looking for a function in the GUI, which belongs to a SCPI, you find it via a cross-reference in the online help and in the user manual.

13.12 To operate the instrument using VNC

This section shows you some examples of the various possibilities to set up remote operation.

- Using a desktop system
 - [Chapter 13.12.2.1, "Using a web browser"](#), on page 566
 - [Chapter 13.12.2.2, "Using a VNC client software"](#), on page 566
- Using a smart device
 - [Chapter 13.12.3.1, "Using a VNC app"](#), on page 569
 - [Chapter 13.12.3.2, "Using a web browser with HTML5"](#), on page 569
 - [Chapter 13.12.3.3, "Special mode QR code"](#), on page 570

13.12.1 How to enable the VNC service

1. **NOTICE!** Enabled VNC service can lead to unauthorized access.
Change the computer name and password of the instrument.
See [Chapter 12.6.5, "How to prevent unauthorized access"](#), on page 493.
2. Select "System Config > Setup > Security > Security > LAN Services".
3. Select "VNC > On".
4. Enter the [Security Password](#).
5. Select "Accept".

13.12.2 How to set up remote operation from a desktop system

13.12.2.1 Using a web browser

The R&S SMCV100B supports remote operation via VNC with any web browser, like Windows Internet Explorer or Mozilla Firefox for instance, or alternatively, an HTML5 web browser.

To operate the instrument via a web browser remotely:

1. Install the *JRE (Java Runtime Environment)* on the remote computer.
Note: Skip this step if you are working with an HTML5 web browser.
2. Type the instruments' IP address in the address field of the web browser on your PC, e.g. `http://10.113.1.151`

The VNC authentication screen appears.

3. Enter the password and confirm with "OK".
The default password is *instrument*.

After the connection is established, the current screen of the signal generator is displayed and the instrument can be remotely operated from the remote computer.

13.12.2.2 Using a VNC client software

A VNC client software is an application which can be used to access and control the instrument from a remote computer through a LAN connection.

The VNC client software for setting up the connection is included in the operating system Linux/Unix per default. For Windows operating systems, a VNC client software must be installed manually.

Various free-of charge programs such as Ultr@VNC or similar VNC client programs are available for download on the Internet.

Setting up the VNC connection on a Linux/Unix desktop client

1. Start a web browser on the remote computer. Enter the IP address of the instrument.
2. Enter the following address:
`vnc://<IP-address of the instrument>`, for example `vnc://10.113.1.151`.

A dialog opens requesting the password for the remote VNC connection.

3. Enter the password and confirm with "OK".
The default password is *instrument*.

After the connection is established, the current screen of the signal generator is displayed and the instrument can be remotely operated from the remote computer.

To operate the instrument using VNC

Setting up the VNC connection on a Windows desktop client

1. Install the VNC viewer program component on the remote computer.
 - a) On the Internet, select a VNC client program and download it onto your PC.
For example the free of charge software Ultr@VNC (`vncviewer.exe` is available, see <http://www.uvnc.com/download/index.html>.
 - b) Execute the VNC client installation.
 - c) Select the VNC viewer program component and follow the installation instructions.
2. Start VNC viewer program component on the PC.

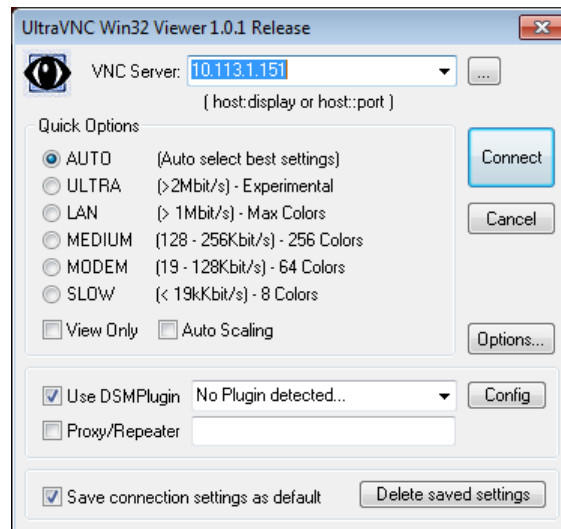

3. Select "VNC Server" and enter the IP address of the instrument.
4. To initialize the connection, select "Connect".

A dialog opens requesting the password.

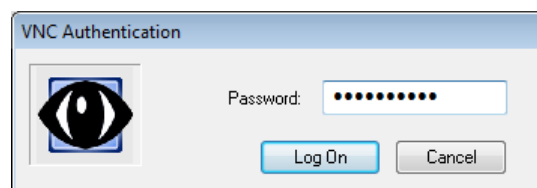

5. Enter the password and confirm with "OK".
The default password is *instrument*.

After the connection is established, the current screen of the signal generator is displayed and the instrument can be remotely operated from the remote computer.

Terminating VNC connection

- ▶ Perform one of the following:
 - a) On an external Unix/Linux PC, close the Internet browser or the signal generator window.

b) On an external Windows PC, close the VNC viewer program.

The connection is terminated but not disabled. It can be established again anytime. In the "Active Connections" tab, the displayed TCP/IP connection disappears. See [Chapter 12.6.5, "How to prevent unauthorized access"](#), on page 493.

13.12.3 How to set up remote operation from a smart device

The R&S SMCV100B supports remote operation via VNC from a smart device (remote client), like a tablet (tablet computer) or a smartphone. The smart device accesses the instrument via WLAN, either by a suitable App, or an HTML5 web browser, that means with embedded *javascript*.

There are several possibilities to establish a WLAN connection between the smart device and the R&S SMCV100B. This section gives an example of how a network environment can be built up, and some essential configuration steps.

For more information, see:

- [1MA216: Remote Operation of Windows Based Instruments with Apple iPad](#)
- [7BM82: Apple iPad Remote Control of Broadcasting T&M Instruments](#)

Example:

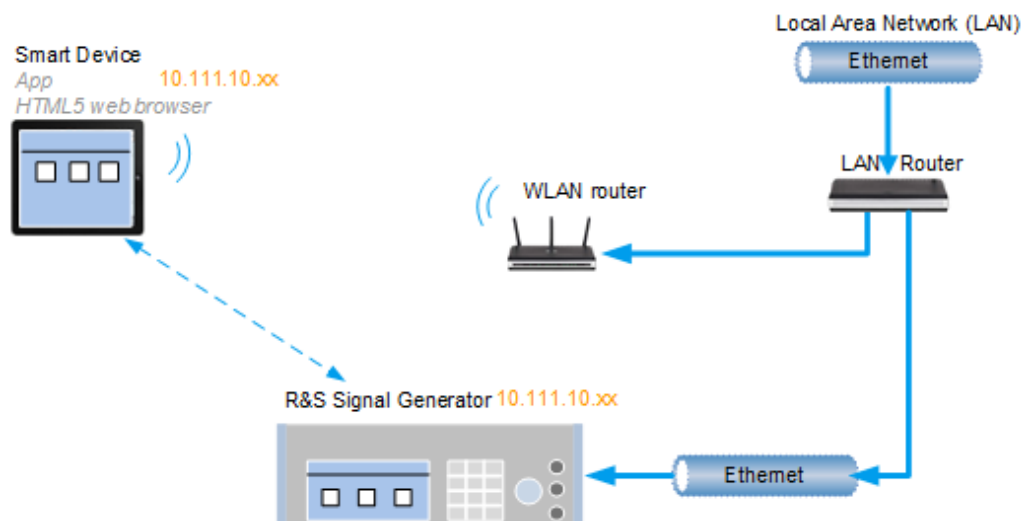

Figure 13-9: Example of a network configuration for remote operation with a smart device

As shown in the figure, the R&S SMCV100B and the WLAN router are connected to the LAN router. The smart device accesses the Rohde & Schwarz instrument via the WLAN router.

Prerequisites

For this network configuration, the following prerequisites must be met:

- The required equipment is:
 - A LAN router

- A WLAN router (hot spot)
Required for accessing the R&S SMCV100B
- The smart device must be known and accepted in the network of the R&S SMCV100B.
- The *App* or web browser implements the VNC functionality on the smart device for remote operation.

It is recommended that all components in the network use DHCP, which automatically assigns the relevant address information.



With the configuration in the example, you can reach the instrument from a great distance, since the WLAN router acts as an additional access point.

13.12.3.1 Using a VNC app

Using a *VNC App* enables the smart device to access the R&S SMCV100B via WLAN.

The VNC Apps are available from various manufacturers of the smart devices.

The list of supported devices is different according to the smart device.

1. Refer to the manufacturer's website to find out whether a VNC App is available for your device, and how it is installed.
2. In the network, establish the connection of the WLAN router to the LAN router.
We assume the connection of the LAN router and the R&S SMCV100B and their configuration in the LAN.
3. Configure the WLAN router according to the manufacturer's instructions.
4. Install the required *VNC App* on your smart device.
5. On the smart device, start the *VNC App*.
6. In the address field, enter the IP address of the instrument.

A log-on dialog opens and requests the password for the VNC connection.

7. Enter the password to establish the remote access.
The default user name and password is *instrument*.
See [Chapter 12.6.5, "How to prevent unauthorized access"](#), on page 493.

After the connection is established, the current screen of the signal generator is displayed and the instrument can be remotely operated.

13.12.3.2 Using a web browser with HTML5

The R&S SMCV100B supports remote operation from a smart device via VNC with any HTML5 compliant web browser, like Internet Explorer, Firefox, Google Chrome, or Safari for instance.

To operate the instrument remotely via a web browser, proceed as follows:

1. In the web browser enter the IP address of the instrument, e.g. *http://10.113.1.151*.
2. Type the instrument IP address in the address field of the web browser on your PC, e.g. *http://10.113.1.151*

The VNC authentication screen appears.

3. Enter the password and confirm with "OK".

The default password is *instrument*.

See [Chapter 12.6.5, "How to prevent unauthorized access"](#), on page 493.

After the connection is established, the current screen of the signal generator is displayed and the instrument can be remotely operated.

13.12.3.3 Special mode QR code

If your smart device is equipped with a camera and a QR code reader, you can scan the instrument's IP address or access the instrument with the Safari web browser.

QR code readers are available from various manufacturers of the smart devices.

The list of supported devices is different according to the smart device.

1. Refer to the manufacturer's website of your smart device to find out whether a reader is available for your device, and how it is installed.
2. Install the required QR code reader software on your device.
3. Start the reader.
4. On the R&S SMCV100B, select "System Config > Remote Access".
5. In the "Remote Access" dialog, select the "QR-Code" tab.
6. Scan the QR code of the instrument with your smart device.
7. On the device, decode the scanned QR code and pass it to the web browser.
A dialog opens requesting the password for the VNC connection.
8. Enter the password and confirm with "OK".
The default password is *instrument*.

After the connection is established, the current screen of the signal generator is displayed and the instrument can be remotely operated.

13.13 References

13.13.1 LXI functionality

LAN Extensions for Instrumentation (LXI) is an instrumentation platform for measuring instruments and test systems that is based on standard Ethernet technology.

The LXI implementation in the R&S SMCV100B allows you to change certain LAN settings, to reset the LAN connection, and to identify the instrument.



For information about the LXI standard, refer to the LXI website at <http://www.lxistandard.org>.

See also "News from Rohde & Schwarz, article 2006/II - 190".

The LXI functionality in the R&S SMCV100B is characterized by a common LAN implementation, including an ICMP ping responder for diagnostics. Using a web browser, you can configure the instrument. A LAN Configuration Initialize (LCI) mechanism resets the LAN configuration. The instrument also supports automatic detection in a LAN via the VXI-11 discovery protocol and programming by IVI drivers.

In addition, the R&S SMCV100B provides the following LXI-related functionality:

- Integrated "LXI Status" dialog for LXI status indication and reset of the LAN configuration, see [Chapter 13.6.1, "LXI status settings"](#), on page 536.
- "LXI Browser Interface", as described in [Chapter 13.6.2.1, "LAN configuration"](#), on page 538.
- "SCPI Remote Trace" utility, see [Chapter 13.6.2.2, "SCPI remote trace"](#), on page 541.



Firmware update

To enable the full LXI functionality after a firmware update, shut down and restart the instrument.

13.13.2 Code generator templates

This section describes the main structure of the code generator templates, and shows the method with the NICVI template.

The code generation is controlled by templates with the following blocks:

Command	Function
#EXTENSION_START #EXTENSION_END	Defines the output file extension.
#INIT_CODE_START #INIT_CODE_END	Contains initial entries, such as included files and libraries, buffer size, commands for synchronization, or creating a VISA session. All entries between start and end are written once at the beginning of the output file.
#COMMAND_CODE_START #COMMAND_CODE_END	Frame for a SCPI command. A command is accessed with %COMMAND.
#NO_COMMAND_CODE_START #NO_COMMAND_CODE_END	Frame for a parameter with no SCPI command available. A parameter is accessed with %PARAMETER.
#EXIT_CODE_START #EXIT_CODE_END	Closes the visa session. All entries between start and end are written once at the end of the output file.

Templates are created in ASCII format with file extension *.expcodetempl.

Example:

Example to the code generator template NICVI.expcodetmpl:

```
#EXTENSION_START
.c
#EXTENSION_END

#INIT_CODE_START
#include <ansi_c.h>
#include <visa.h>
#include <cvirte.h>

#define MAX_BUFFER_SIZE 200
static ViStatus status;
static ViSession defaultRM, handle;

static void write_command(char *command)
{
    char writeBuffer[MAX_BUFFER_SIZE];
    char readBuffer[MAX_BUFFER_SIZE];
    int length;
    int readCount;

    strcpy(writeBuffer, command);
    //append "*OPC?" to sync
    strcat(writeBuffer, "*OPC?");
    length = strlen (writeBuffer);
    writeBuffer[length]='\n';
```

```

        length = length+1;
        viWrite (handle, writeBuffer, length, VI_NULL);
        //read result
        viRead(handle, readBuffer, 100, &readCount);
    }
int main (int argc, char *argv[])
{
    if (InitCVIRTE (0, argv, 0) == 0)
        return -1;    /* out of memory */
        //create a VISA session and return a handle to it
        viOpenDefaultRM (&defaultRM);
        //create a VISA session to the serial port and return a handle to it
        viOpen (defaultRM, (ViRsrc)"TCPIP::localhost::INSTR", VI_NULL, VI_NULL,
&handle);
#INIT_CODE_END

#COMMAND_CODE_START
    write_command("%COMMAND");
#COMMAND_CODE_END

#NO_COMMAND_CODE_START
    //no SCPI command available for parameter %PARAMETER !
#NO_COMMAND_CODE_END

#EXIT_CODE_START
    viClose (handle);
        viClose (defaultRM);
        return 0;
}
#EXIT_CODE_END

```

13.13.3 Remote control states

How to recognize if there is an active remote connection to the instrument

- ▶ Observe the indication on the taskbar.

A softkey in the taskbar indicates if and what kind of remote connections are currently set up.

See also [Chapter 13.5.4, "Remote connections settings"](#), on page 523.

The following table shows the different remote control states and the associated commands or actions to return to manual control.

14 Remote control commands

In the following, all remote-control commands are presented in detail with their parameters and the ranges of numerical values.

For an introduction to remote control and the status registers, see [Chapter 13, "Network operation and remote control"](#), on page 499.

14.1 Conventions used in SCPI command descriptions

The following conventions are used in the remote command descriptions:

- **Command usage**
If not specified otherwise, commands can be used both for setting and for querying parameters.
If a command can be used for setting or querying only, or if it initiates an event, the usage is stated explicitly.
- **Parameter usage**
If not specified otherwise, a parameter can be used to set a value and it is the result of a query.
Parameters required only for setting are indicated as **Setting parameters**.
Parameters required only to refine a query are indicated as **Query parameters**.
Parameters that are only returned as the result of a query are indicated as **Return values**.
- **Conformity**
Commands that are taken from the SCPI standard are indicated as **SCPI confirmed**. All commands used by the R&S SMCV100B follow the SCPI syntax rules.
- **Asynchronous commands**
A command which does not automatically finish executing before the next command starts executing (overlapping command) is indicated as an **Asynchronous command**.
- **Reset values (*RST)**
Default parameter values that are used directly after resetting the instrument (*RST command) are indicated as ***RST** values, if available.
- **Factory preset values**
Default parameter values that are reset only by factory preset.
- **Default unit**
The default unit is used for numeric values if no other unit is provided with the parameter.
- **Manual operation**
If the result of a remote command can also be achieved in manual operation, a link to the description is inserted.

14.2 Programming examples

The corresponding sections of the same title provide simple programming examples for the R&S SMCV100B. The purpose of the examples is to present **all** commands for a given task. In real applications, one would rather reduce the examples to an appropriate subset of commands.

The programming examples have been tested with a software tool which provides an environment for the development and execution of remote tests. To keep the examples as simple as possible, only the "clean" SCPI syntax elements are reported. Non-executable command lines (for example comments) start with two // characters.

At the beginning of the most remote control program, an instrument (p)reset is recommended to set the R&S SMCV100B to a definite state. The commands `*RST` and `SYSTem:PRESet` are equivalent for this purpose. `*CLS` also resets the status registers and clears the output buffer.

In all the examples we assume that:

- A remote PC is connected to the instrument
- The remote PC and the instrument are switched on
- A connection between them is established
- The security setting "System Config > Setup > Security > SCPI over LAN" is enabled.

14.3 Common commands

Common commands are described in the IEEE 488.2 (IEC 625-2) standard. These commands have the same effect and are employed in the same way on different devices. The headers of these commands consist of "*" followed by three letters. Many common commands are related to the Status Reporting System.

Available common commands:

<code>*CLS</code>	576
<code>*ESE</code>	576
<code>*ESR?</code>	576
<code>*IDN?</code>	576
<code>*IST?</code>	577
<code>*OPC</code>	577
<code>*OPT?</code>	577
<code>*PRE</code>	577
<code>*PSC</code>	577
<code>*RCL</code>	578
<code>*RST</code>	578
<code>*SAV</code>	578
<code>*SRE</code>	579
<code>*STB?</code>	579

*TRG.....	579
*TST?.....	579
*WAI.....	579

*CLS

Clear status

Sets the status byte (STB), the standard event register (ESR) and the `EVENT` part of the `QUESTIONABLE` and the `OPERATION` registers to zero. The command does not alter the mask and transition parts of the registers. It clears the output buffer.

Usage: Setting only

*ESE <Value>

Event status enable

Sets the event status enable register to the specified value. The query returns the contents of the event status enable register in decimal form.

Parameters:

<Value> Range: 0 to 255

*ESR?

Event status read

Returns the contents of the event status register in decimal form and then sets the register to zero.

Return values:

<Contents> Range: 0 to 255

Usage: Query only

*IDN?

Identification

Returns the instrument identification.

Return values:

<ID> "Rohde&Schwarz,<device type>,<part number>/<serial number>,<firmware version>"

Usage: Query only

Manual operation: See "[IDN String](#)" on page 523
 See "[Hardware Options/Software Options](#)" on page 849

***IST?**

Individual status query

Returns the contents of the IST flag in decimal form. The IST flag is the status bit which is sent during a parallel poll.

Return values:

<ISTflag> 0 | 1

Usage: Query only

***OPC**

Operation complete

Sets bit 0 in the event status register when all preceding commands have been executed. This bit can be used to initiate a service request. The query writes a "1" into the output buffer when all preceding commands have been executed, which is useful for command synchronization.

***OPT?**

Option identification query

Queries the options included in the instrument. For a list of all available options and their description, refer to the data sheet.

Return values:

<Options> The query returns a list of options. The options are returned at fixed positions in a comma-separated string. A zero is returned for options that are not installed.

Usage: Query only

Manual operation: See "[OPT String](#)" on page 523
 See "[Hardware Options/Software Options](#)" on page 849

***PRE <Value>**

Parallel poll register enable

Sets parallel poll enable register to the indicated value. The query returns the contents of the parallel poll enable register in decimal form.

Parameters:

<Value> Range: 0 to 255

***PSC <Action>**

Power on status clear

Determines whether the contents of the `ENABLe` registers are preserved or reset when the instrument is switched on. Thus a service request can be triggered when the instrument is switched on, if the status registers ESE and SRE are suitably configured. The query reads out the contents of the "power-on-status-clear" flag.

Parameters:

<Action> 0 | 1

0

The contents of the status registers are preserved.

1

Resets the status registers.

***RCL** <Number>

Recall

Loads the instrument settings from an intermediate memory identified by the specified number. The instrument settings can be stored to this memory using the command `*SAV` with the associated number.

It also activates the instrument settings which are stored in a file and loaded using the `MMEMory:LOAD <number>, <file_name.extension>` command.

Manual operation: See "[Recall Immediate x](#)" on page 424

***RST**

Reset

Sets the instrument to a defined default status. The default settings are indicated in the description of commands.

The command is equivalent to `SYSTem:PRESet`.

Usage: Setting only

Manual operation: See "[Preset](#)" on page 418

***SAV** <Number>

Save

Stores the current instrument settings under the specified number in an intermediate memory. The settings can be recalled using the command `*RCL` with the associated number.

To transfer the stored instrument settings in a file, use the command `:MMEMory:STORe:STATe`.

Manual operation: See "[Save Immediate x](#)" on page 424

***SRE** <Contents>

Service request enable

Sets the service request enable register to the indicated value. This command determines under which conditions a service request is triggered.

Parameters:

<Contents> Contents of the service request enable register in decimal form.
Bit 6 (MSS mask bit) is always 0.

Range: 0 to 255

***STB?**

Status byte query

Reads the contents of the status byte in decimal form.

Usage: Query only

***TRG**

Trigger

Triggers all actions waiting for a trigger event. In particular, *TRG generates a manual trigger signal. This common command complements the commands of the TRIGger subsystem.

*TRG corresponds to the INITiate:IMMediate command.

Usage: Event

***TST?**

Self-test query

Initiates self-tests of the instrument and returns an error code.

Return values:

<ErrorCode> **integer > 0 (in decimal format)**
An error occurred.
(For details, see the Service Manual supplied with the instrument).

0
No errors occurred.

Usage: Query only

***WAI**

Wait to continue

Prevents servicing of the subsequent commands until all preceding commands have been executed and all signals have settled (see also command synchronization and *OPC).

Usage: Event

14.4 Preset commands

The preset commands are not bundled in one subsystem. Therefore, they are listed separately in this section.

In addition, a specific preset command is provided for each digital standard. These specific commands are described in the associated subsystems.

Four presetting actions are available:

- Activating the default state of all internal instrument functions (*RST on page 578). Functions that concern the integration of the instrument into a measurement setup are not changed, e.g. reference oscillator source settings.
- Activating the preset state of the parameters related to the selected signal path (:SOURce<hw>:PRESet on page 581)
- Activating the preset state of all parameters that are not related to the signal path (:DEVice:PRESet on page 580)
- Activating the original state of delivery (factory reset, :SYSTem:FPRreset on page 581). Only functions that are protected by a password remain unchanged as well as the passwords themselves.



When resetting, the following deviation between remote and manual control exists:

In contrast to the [Preset] key, the SCPI commands *RST and :SYSTem:PRESet do not close open dialogs in the GUI.

:DEVice:PRESet.....	580
:SOURce<hw>:PRESet.....	581
:SYSTem:PRESet.....	581
:SYSTem:FPRreset.....	581

:DEVice:PRESet

Presets all parameters which are not related to the signal path, including the LF generator.

Example: DEV:PRES
Presets all instruments settings that are not related to the signal path.

Usage: Event

:SOURce<hw>:PRESet

Presets all parameters which are related to the selected signal path.

Example: `SOUR:PRES`
Presets all settings that are related to signal path

Usage: Event

:SYSTem:PRESet

Triggers an instrument reset. It has the same effect as:

- The [Preset] key.
However, the command does not close open GUI dialogs like the key does.
- The *RST command

For an overview of the settings affected by the preset function, see [Table 11-1](#)

Example: `SYST:PRES`
All instrument settings (also the settings that are not currently active) are reset to their default values.

Usage: Setting only

:SYSTem:FPReset

Triggers an instrument reset to the original state of delivery.

Example: `SYST:FPR`
All instrument settings (also the settings that are not currently active) are reset to the factory values.

Usage: Event

Manual operation: See "[Execute Factory Preset](#)" on page 418

14.5 MMEMory subsystem

The MMEMory subsystem (Mass MEMory) contains the commands for managing files and directories as well as for loading and saving complete instrument settings in files.

Mass storage location

Both, the user directory `/var/user/` on the internal memory or the `/usb/` directory on the memory stick, can be used to **preserve** user-defined data. Any directory structure can be created.

The `/var/volatile` directory serves as a RAM drive and can be used to protect sensitive information. The data is available **temporarily**.

Default storage location

The R&S SMCV100B stores user data in the user directory.

In the file system, user directory is always indicated as `/var/user/`.

In manual control, you access this directory via the "File Manager", see [Chapter 11.8, "Using the file manager"](#), on page 428. In remote control, you can query it with the command `:SYSTEM:MMEMory:PATH:USER?`.

To query and change the default directory used for mass storage, use the command `:MMEMory:CDIRectory`.

14.5.1 File naming conventions

To enable files to be used in different file systems, consider the following file naming conventions:

- The *filename* can be of any length and *is case-sensitive*, i.e. it is distinguished between uppercase and lowercase letters.
- All letters and numbers are permitted (numbers are, however, not permitted at the beginning of the filename).
- Avoid using special characters.
- Do not use slashes "\" and "/". These symbols are used in file paths.
- Avoid using the following filenames: CLOCK\$, CON, COM1 to COM4, LPT1 to LPT3, NUL or PRN
They are reserved by the operating system.

File extension

The file and the optional file *extension* are separated by a period sign. The R&S SMCV100B distinguishes the files according to their extensions; each type of file is assigned a specific file content and hence a specific file extension. Refer to [Chapter A.1, "Extensions for user files"](#), on page 871 for an overview of the supported file extensions.

Wildcards

The two characters "*" and "?" function as "wildcards", i.e. they are used for selecting several files. The "?" character represents exactly one character, while the "*" character represents all characters up to the end of the filename. "*.*" therefore represents all files in a directory.

Filename and file path

When used in remote control commands, the parameter `<filename>` is specified as a string parameter with quotation marks. It can contain either the complete path including the root user directory `/var/user` and filename, or only the filename. The filename must include the file extension. The same applies for the directory `/var/volatile` and for the parameters `<directory_name>` and `<path>`.

Depending on how much information is provided, the values specified in the parameter or with the command `MMEM:CDIR` are used for the path and drive setting in the commands.

14.5.2 Accessing files in the default or in a specified directory

For better overview and easy file handling, you may not save all user files in the user directory `/var/user` but rather organize them into subdirectories.

The command syntax defines two general ways to access files with user data in a *specific* directory:

- **Change the current default directory** for mass memory storage and then directly access the files in this default directory, like saved list files, files with user data or save/recall files.
(See [Example"Save the user settings in a file in a specific directory"](#) on page 583).
The subsequent commands for file handling (select, delete, read out files in the directory, etc.) require only specification of the filename. File extension can be omitted; after syntax evaluation of the used command, the R&S SMCV100B filters out the relevant files.
- Define the **complete file path**, including the user directory `/var/user`, created subdirectories and filename (see [Example"Load file with user data from a specific directory"](#) on page 584).
As a rule, whenever an complete file path is determined, it overwrites a previously specified default directory.

The following example explains this rule as a principle. Exceptions of this general rule are stated in the description of the corresponding command. The [Chapter 14.5.3, "Programming examples"](#), on page 584 explains the general working principle with the commands for mass memory storage.

The same rule applies to the `/var/volatile` directory, see [Example"Working with files in the volatile memory"](#) on page 586.

Example: Save the user settings in a file in a specific directory

This example uses the commands for saving and loading files with custom digital modulation settings. We assume that the directory `/var/user/DigMod` is existing and contains the files `SaveRecallTest.dm` and `dmSavRcl.dm`.

```
// Set the default directory first
MMEMory:CDIRectory "/var/user/DigMod"
SOURCEl:BB:DM:SETTing:CATalog?
// "SaveRecallTest","dmSavRcl"

// Specify only the file name; the extension *.dm is assigned automatically
SOURCEl:BB:DM:SETTing:STORe "dmSettings"
SOURCEl:BB:DM:SETTing:DELeTe "dmSavRcl"
SOURCEl:BB:DM:SETTing:LOAD "SaveRecallTest"
SOURCEl:BB:DM:SETTing:CATalog?
// "SaveRecallTest","dmSettings"
```

Example: Load file with user data from a specific directory

This example shows how to use the custom digital modulation commands to set the data source and select a data list. We assume that the directory `/var/user/lists` is existing and contains the files `dlist1.dm_iqd` and `myDList.dm_iqd`.

```
// Select a data list file as data source
SOURCE1:BB:DM:SOURCE DLIST

// Query the data list files (*.dm_iqd) in the default directory
MMEMemory:CDIRECTORY "/var/user/lists"
SOURCE1:BB:DM:DLIST:CATALOG?
// "dlist1","myDList"

// Specify the complete path to select a data list file (*.dm_iqd)
// in the specific directory
MMEMemory:CDIRECTORY
SOURCE1:BB:DM:DLIST:SELECT "/var/user/lists/myDList"
SOURCE1:BB:DM:DLIST:DELETE "/var/user/lists/dlist1"
```

14.5.3 Programming examples

Example: Saving and loading current settings

This example shows two ways of how to save the current instrument setting in the file `settings.savrcl.txt` in the directory `/var/user/savrcl`.



Before the instrument settings can be saved in a file, they have to be saved in an intermediate memory using common command `*SAV <number>`. The specified number is then used in the `:MMEMemory:STORE:STATE` command.

Also, after loading a file with instrument settings with command `:MMEMemory:LOAD:STATE`, these settings have to be activated with the common command `*RCL <number>`.

```
// Save the current settings in an intermediate memory with number 4
*SAV 4

// save the settings in a file in a specific directory;
// the complete path has to be specified
MMEMemory:STORE:STATE 4, "/var/user/savrcl/settings.savrcl.txt"

// save the settings in a file in the default directory;
// set the default directory; specify only the file name
MMEMemory:CDIRECTORY "/var/user/savrcl"
*SAV 4
MMEMemory:STORE:STATE 4, "settings.savrcl.txt"

// Load the saved settings in the intermediate memory 4 and activate them
```



```
MMEMory:LOAD:STATe 4,"/var/user/settings.savrc1txt"
*RCL 4
```

Example: Working with files and directories

This example shows how to list files in a directory, list the subdirectories, query the number of files in a directory, create directory, rename and delete files.

```
// Query the current default directory for mass storage,
// change the directory to the default user directory "/var/user"
// and read out the files in it
MMEMory:CDIRectory?
// "/var/user/temp"
MMEMory:CDIRectory
MMEMory:CDIRectory?
// "/var/user/"
MMEMory:CATalog?
// 1282630,8102817792,".,DIR,4096","..,DIR,4096","Log,DIR,4096",
// "settings.savrc1txt,BIN,16949","temp,DIR,4096","test,DIR,4096",
// "list.lsw,BIN,1245201"
// the directory "/var/user" contains the predefined directory "Log",
// the subdirectories "test" and "temp"
// as well as the files "settings.savrc1txt" and "list.lsw"

// query only the subdirectories of the current or specified directory
MMEMory:DCATalog? "/var/user"
// ".,","..","Log","temp","test"

// query only number of subdirectories in the current or specified directory
MMEMory:DCATalog:LENGth? "/var/user"
// 5

// query number of files in the current or specified directory
MMEMory:CATalog:LENGth? "/var/user"
// 7

// Create a new directory for mass memory storage in the specified directory
MMEMory:MDIRectory "/var/user/new"

// Copy the file "settings.savrc1txt" into the new directory
MMEMory:COPY "/var/user/settings.savrc1txt","/var/user/new/settings.savrc1txt"

// Rename the file "settings.savrc1txt" into the new directory
// and read out the files in this specific directory
MMEMory:CDIRectory "/var/user/new"
MMEMory:MOVE "settings.savrc1txt","settings_new.savrc1txt"
MMEMory:CATalog? "/var/user/new"
// 25141,8102789120,".,DIR,4096","..,DIR,4096","settings_new.savrc1txt,BIN,16949"

// Delete the "test" directory
MMEMory:RDIRectory "/var/user/test"
```

Example: Working with files in the volatile memory

This example shows how to work with files in the `/var/volatile` directory.

```
// Change the default directory for mass storage,
// read out the files, load and play a file with the ARB
MMEMory:CDIRectory "/var/volatile"
MMEMory:CDIRectory?
// "/var/volatile"
MMEMory:CATalog?
//13928,525352960,".,DIR,60",".,DIR,4096","list.lst,BIN,9772"

SOURCEl:LIST:SElect "/var/volatile/list"
SOURCEl:FREQuency:MODE LIST
OUTPut1:STATe 1
```

14.5.4 Remote control commands

<code>:MMEMory:CATalog?</code>	586
<code>:MMEMory:CATalog:LENGth?</code>	587
<code>:MMEMory:CDIRectory</code>	587
<code>:MMEMory:COpy</code>	587
<code>:MMEMory:DATA</code>	588
<code>:MMEMory:DCATalog?</code>	589
<code>:MMEMory:DCATalog:LENGth?</code>	589
<code>:MMEMory:DELeTe</code>	589
<code>:MMEMory:LOAD:STATe</code>	589
<code>:MMEMory:MDIRectory</code>	590
<code>:MMEMory:MOVE</code>	590
<code>:MMEMory:MSIS</code>	590
<code>:MMEMory:RDIRectory</code>	591
<code>:MMEMory:STORe:STATe</code>	591
<code>:MEMory:HFRee?</code>	591

`:MMEMory:CATalog?` <path>

Returns the content of a particular directory.

Query parameters:

<path>	string
--------	--------

String parameter to specify the directory.
If you leave out the path, the command returns the contents of the directory selected with `:MMEMory:CDIRectory`.
The path may be relative or absolute.

Return values:

<UsedDiskSpace>	Byte size of all files in the directory.
<FreeDiskSpace>	Remaining disk space in bytes.
<FileInfo>	<NameFileN>,<SuffixFileN>,<SizeFileN>

List of files, separated by commas

<NameFileN>

Name of the file.

<SuffixFileN>

Type of the file. Possible suffixes are: ASCii, BINary, DIRectory

<SizeFileN>

Size of the file in bytes.

Usage: Query only

Manual operation: See "[Directory, File List and Filename](#)" on page 423

:MMEMory:CATalog:LENGth? <Path>

Returns the number of files in the current or in the specified directory.

Query parameters:

<Path> string

String parameter to specify the directory. If the directory is omitted, the command queries the content of the current directory, queried with `:MMEMory:CDIRectory` command.

Return values:

<FileCount> integer
Number of files.

Usage: Query only

:MMEMory:CDIRectory <Directory>

Changes the default directory for mass memory storage. The directory is used for all subsequent `MMEM` commands if no path is specified with them.

Parameters:

<Directory> <directory_name>

String containing the path to another directory. The path can be relative or absolute.

To change to a higher directory, use two dots '..'.

Usage: SCPI confirmed

Manual operation: See "[Directory, File List and Filename](#)" on page 423
See "[Directory and Filename](#)" on page 430

:MMEMory:COpy <SourceFile>[,<DestinationFile>]

Copies an existing file to a new file. Instead of just a file, this command can also be used to copy a complete directory together with all its files.

Setting parameters:

<SourceFile>	string String containing the path and file name of the source file
<DestinationFile>	string String containing the path and name of the target file. The path can be relative or absolute. If <DestinationFile> is not specified, the <SourceFile> is copied to the current directory, queried with the <code>:MMEMory:CDIRectory</code> command. Note: Existing files with the same name in the destination directory are overwritten without an error message.

Usage: Setting only
SCPI confirmed

Manual operation: See "[Cut, Copy&Paste and Delete](#)" on page 430

:MMEMory:DATA <Filename>, <BinaryBlock>

:MMEMory:DATA? <Filename>

The setting command writes the block data <BinaryBlock> to the file identified by <Filename>.

Tip: Use this command to read/transfer stored instrument settings or waveforms directly from/to the instrument.

Parameters:

<BinaryBlock>	#<number><length_entry><data> #: Hash sign; always comes first in the binary block <number>: the first digit indicates how many digits the subsequent length entry has <length_entry>: indicates the number of subsequent bytes <data>: binary block data for the specified length. For files with a size with more than nine digits (gigabytes), the instrument allows the syntax # (<Length>), where <Length> is the file size in decimal format.
---------------	--

Parameters for setting and query:

<Filename>	string String parameter to specify the name of the file.
------------	---

Example: `MMEMory:DATA '/var/user/test.txt', #15hallo`
Writes the block data to the file `test.txt`.
The digit 1 indicates a length entry of one digit; the digit 5 indicate a length of the binary data (`hallo`) in bytes.
`MMEMory:DATA? '/var/user/test.txt'`
Sends the data of the file `test.txt` from the instrument to the controller in the form of a binary block.
Response: `#15hallo`

Usage: SCPI confirmed

:MMEMory:DCATalog? <path>

Returns the subdirectories of a particular directory.

Query parameters:

<path> String parameter to specify the directory. If the directory is omitted, the command queries the content of the current directory, queried with `:MMEMory:CDIRectory` command.

Return values:

<Catalog> <file_entry>
Names of the subdirectories separated by colons. The first two strings are related to the parent directory.

Usage: Query only

:MMEMory:DCATalog:LENGth? [<Path>]

Returns the number of subdirectories in the current or specified directory.

Query parameters:

<Path> String parameter to specify the directory. If the directory is omitted, the command queries the contents of the current directory, to be queried with `:MMEMory:CDIRectory` command.

Return values:

<DirectoryCount> integer
Number of parent and subdirectories.

Usage: Query only

:MMEMory:DELeTe <Filename>

Removes a file from the specified directory.

Setting parameters:

<Filename> string
String parameter to specify the name and directory of the file to be removed.

Usage: Event
SCPI confirmed

Manual operation: See "[Cut, Copy&Paste and Delete](#)" on page 430

:MMEMory:LOAD:STATe <SavRclStateNumb>, <file_name>

Loads the specified file stored under the specified name in an internal memory.

After the file has been loaded, the instrument setting must be activated using an `*RCL` command.

Setting parameters:

<SavRclStateNumb> Determines to the specific <number> to be used with the *RCL command, e.g. *RCL 4.

<file_name> String parameter to specify the file name with extension *.savrc1txt.

Usage: Setting only

Manual operation: See "[Recall](#)" on page 424

:MMEMory:MDIRECTory <Directory>

Creates a subdirectory for mass memory storage in the specified directory. If no directory is specified, a subdirectory is created in the default directory. This command can also be used to create a directory tree.

Setting parameters:

<Directory> string
String parameter to specify the new directory.

Usage: Event

Manual operation: See "[Create New Directory](#)" on page 430

:MMEMory:MOVE <SourceFile>, <DestinationFile>

Moves an existing file to a new location or, if no path is specified, renames an existing file.

Setting parameters:

<SourceFile> string
String parameter to specify the name of the file to be moved.

<DestinationFile> string
String parameters to specify the name of the new file.

Usage: Event
SCPI confirmed

Manual operation: See "[Rename](#)" on page 430

:MMEMory:MSIS <Msis>

Defines the drive or network resource (in the case of networks) for instruments with windows operating system, using `msis` (MSIS = Mass Storage Identification String).

Note: Instruments with Linux operating system ignore this command, since Linux does not use drive letter assignment.

Usage: SCPI confirmed

:MMEMory:RDIRECTory <Directory>

Removes an existing directory from the mass memory storage system. If no directory is specified, the subdirectory with the specified name is deleted in the default directory.

Setting parameters:

<Directory> string
String parameter to specify the directory to be deleted.

Example: See [Example "Working with files and directories"](#) on page 585.

Usage: Event

:MMEMory:STORe:STATe <savrcl_state_nr>, <file_name>

Stores the current instrument setting in the specified file.

The instrument setting must first be stored in an internal memory with the same number using the common command *SAV.

Setting parameters:

<savrcl_state_nr> Corresponds to the specific <number> defined with the *SAV command, e.g. *SAV 4.

<file_name> String parameter to specify the file name with extension *.savrcl.txt.

Usage: Event

Manual operation: See ["Save"](#) on page 423

:MEMory:HFRee?

Returns the used and available memory in Kb.

Return values:

<TotalPhysMemKb> integer
Total physical memory.

<ApplicMemKb> integer
Application memory.

<HeapUsedKb> integer
Used heap memory.

<HeapAvailableKb> integer
Available heap memory.

Usage: Query only

14.6 CALibration subsystem

The CALibration subsystem contains the commands needed for performing internal adjustments. This procedure is triggered by the query commands.

Common suffixes

The following common suffixes are used in the remote commands:

Suffix	Value range	Description
CALibration<hw>	[1]	Optional suffix

Understanding the query response

- 1: error-free execution of the adjustments
- 0: indicates that an error occurred; the process has been canceled

:CALibration:ALL[:MEASure]?	592
:CALibration<hw>:ALL:DATE?	592
:CALibration<hw>:ALL:INFormation?	593
:CALibration<hw>:ALL:TEMP?	593
:CALibration<hw>:ALL:TIME?	593
:CALibration<hw>:CONTinueonerror	594
:CALibration:DATA:FACTory:DATE?	594
:CALibration:ROSCillator[:DATA]	594
:CALibration:DELAy:MINutes	595
:CALibration:DELAy:SHUTdown[:STATe]	595
:CALibration:DELAy[:MEASure]?	595

:CALibration:ALL[:MEASure]? [<Force>]

Starts all internal adjustments that do not need external measuring equipment.

Query parameters:

<Force> string

Return values:

<Measure> 1 | ON | 0 | OFF

Example:

```
CAL:ALL:MEAS?
// Response: "1"
// Executes the adjustments of all instrument functions.
// When completed, it indicates that the adjustment has
// been performed successfully.
```

Usage: Query only

Manual operation: See "Adjust All" on page 861

:CALibration<hw>:ALL:DATE?

Queries the date of the most recently executed full adjustment.

Suffix:	
<hw>	[1] Optional suffix
Return values:	
<Date>	string
Example:	CAL:ALL:DATE? // "2016-01-01"
Usage:	Query only
Manual operation:	See " Last Full Adjustment " on page 861

:CALibration<hw>:ALL:INFormation?

Queries the current state of the internal adjustment.

Return values:	
<CallInfoText>	string
Example:	CAL:ALL:INF? "Instrument is calibrated, no adjustment required." "UNCAL, instrument is warming up." "UNCAL, Please perform full adjustment after warming up." "UNCAL, Please perform full adjustment."
Usage:	Query only
Manual operation:	See " Information " on page 862

:CALibration<hw>:ALL:TEMP?

Queries the temperature deviation compared to the calibration temperature.

Suffix:	
<hw>	[1] Optional suffix
Return values:	
<Temperature>	string
Example:	CALibration:ALL:TEMP? // "+12.00 K"
Usage:	Query only
Manual operation:	See " Temperature Offset " on page 862

:CALibration<hw>:ALL:TIME?

Queries the time elapsed since the last full adjustment.

Return values:	
<Time>	string

Example: `CAL:ALL:TIME?`
 `// "22 days"`

Usage: Query only

Manual operation: See ["Time"](#) on page 861

:CALibration<hw>:CONTInueonerror <State>

Continues the calibration even though an error was detected. By default adjustments are aborted on error.

Suffix:
 <hw> [1]
 Optional suffix

Parameters:
 <State> 1 | ON | 0 | OFF
 *RST: n.a. (factory preset: 0)

Example: `CAL:CONT ON`
 `// Continues calibration after an error`

Manual operation: See ["Continue Adjustment on Error"](#) on page 862

:CALibration:DATA:FACTory:DATE?

Queries the date of the last factory calibration.

Return values:
 <Date> string

Example: `CAL:DATA:FACT:DATE?`
 `// "2016-01-01"`

Usage: Query only

Manual operation: See ["Last Factory Calibration"](#) on page 848

:CALibration:ROSCillator[:DATA] <Data>

Sets a user-defined calibration value for the internal reference frequency.

Parameters:
 <Data> integer
 0 = the factory value is used (i.e. user-defined calibration is disabled)
 Value > 0: positive calibration values are used
 Value < 0: negative calibration values are used
 Range: depends on other values
 *RST: 0

Example: See [\[:SOURce\]:ROSCillator\[:INTernal\]:ADJust\[:STATE\]](#) on page 800.

:CALibration:DELAy:MINutes <Minutes>

Sets the warm-up time to wait before internal adjustment starts automatically.

Automatic execution starts only, if you have enabled the calibration with command :
:CALibration:DELAy[:MEASure]? ON.

Parameters:

<Minutes> integer
Range: 30 to 120
*RST: n.a. (no preset. default: 60)

Example: :CALibration:DELAy:MINutes 30
// sets the time delay for warm-up of the instrument.

Manual operation: See "Warm Up Time" on page 863

:CALibration:DELAy:SHUTdown[:STATe] <Shutdown>

Enables the instrument to shut down automatically after calibration.

Parameters:

<Shutdown> 1 | ON | 0 | OFF
*RST: 0

Example: :CALibration:DELAy:SHUTdown[:STATe] ON|1
// initiates that the instrument shuts down when the adjustments are completed.

Manual operation: See "Shutdown After Adjustment" on page 863

:CALibration:DELAy[:MEASure]?

Starts the delayed adjustment process. When the warm-up time has elapsed (see :
:CALibration:DELAy:MINutes, it executes the internal adjustments.

If you have enabled automatic shutdown, :CALibration:DELAy:SHUTdown[:
STATe] ON, the instrument shuts down when the adjustments are completed.

Return values:

<Error> 1 | ON | 0 | OFF
*RST: n.a. (no preset. default: 0)

Example: :CALibration:DELAy[:MEASure] ON|1
// enables the adjustment process to start after the warm-up time automatically.

Usage: Query only

Manual operation: See "Adjust All Delayed" on page 863

14.7 DIAGnostic subsystem

The `DIAGnostic` subsystem contains the commands used for instrument diagnosis and servicing. SCPI does not define any `DIAGnostic` commands; the commands listed here are all device-specific. All `DIAGnostic` commands are query commands which are not affected by `*RST`.



The test functions are intended for services purposes.

They are thus password-protected functions. Unlock the corresponding protection level to access them, see `:SYSTEM:PROTECT<ch>[:STATE]`.

For more information, see R&S SMCV100B Service Manual.

Common suffixes

The following common suffixes are used in remote commands:

Suffix	Value range	Description
<code>DIAGnostic<hw></code>	[1]	Optional suffix

Example: Programming example

The example lists the commands required to query assemblies and test points for diagnosis purposes.

```
// Query the modules available in the instrument
// and variant and revision state of a certain assembly
DIAGnostic1:BGInfo:CATalog?
// IPS3,BIOS,RFCV,BBCV, ...
DIAGnostic1:BGInfo? "RFCV"
// RFCV 1432.8207.02 01.00 100000

// Query the test points available in the instrument
// and trigger the measurement in a selected test point
DIAGnostic1:POINT:CATalog?
// ASATT6HP_M5V7,ASATT6HP_OFFSET,...
DIAGnostic1:MEASure:POINT? "BBB_CODER_BBB_US"
// -1.000000V/°C

// Query the operating hours and number of power-on so far.
DIAGnostic:INFO:OTIME?
// 112 h
DIAGnostic:INFO:POCount?
// 14
```

Commands

<code>:DIAGnostic<hw>:BGInfo:CATalog?</code>	597
<code>:DIAGnostic<hw>:BGInfo?</code>	597
<code>:DIAGnostic:INFO:OTIME?</code>	597

:DIAGnostic:INFO:POCount?.....	598
:DIAGnostic<hw>:POINT:CATalog?.....	598
:DIAGnostic<hw>[:MEASure]:POINT?.....	598

:DIAGnostic<hw>:BGINfo:CATalog?

Queries the names of the assemblies available in the instrument.

Return values:

<Catalog> string
 List of all assemblies; the values are separated by commas
 The length of the list is variable and depends on the instrument
 equipment configuration.

Example: See [Example"Programming example"](#) on page 596.

Usage: Query only

:DIAGnostic<hw>:BGINfo? [<Board>]

Queries information on the modules available in the instrument, using the variant and revision state.

Query parameters:

<Board> string
 Module name, as queried with the command :
[DIAGnostic<hw>:BGINfo:CATalog?](#).
 To retrieve a complete list of all modules, omit the parameter.
 The length of the list is variable and depends on the instrument
 equipment configuration.

Return values:

<BgInfo> <Module name> <Module stock number incl. variant> <Module
 revision> <Module serial number>
 List of comma-separated entries, one entry per module.
 Each entry for one module consists of four parts that are separated
 by space characters.

Example: See [Example"Programming example"](#) on page 596.

Usage: Query only

Manual operation: See ["Assembly"](#) on page 847

:DIAGnostic:INFO:OTIMe?

Queries the operating hours of the instrument so far.

Return values:

<OperationTime> integer
 Range: 0 to INT_MAX
 *RST: 0

Example: See [Example"Programming example"](#) on page 596.

Usage: Query only

Manual operation: See ["Operation Time / h"](#) on page 848

:DIAGnostic:INFO:POCount?

Queries how often the instrument has been turned on so far.

Return values:

<PowerOnCount> integer
 Range: 0 to INT_MAX
 *RST: 0

Example: See [Example"Programming example"](#) on page 596.

Usage: Query only

Manual operation: See ["Power On Count"](#) on page 848

:DIAGnostic<hw>:POINT:CATalog?

Queries the test points available in the instrument.

For more information, see R&S SMCV100B Service Manual.

Return values:

<Catalog> string
 List of comma-separated values, each representing a test point

Example: See [Example"Programming example"](#) on page 596.

Usage: Query only

:DIAGnostic<hw>[:MEASure]:POINT? <Name>

Triggers the voltage measurement at the specified test point and returns the measured voltage.

For more information, see R&S SMCV100B Service Manual.

Query parameters:

<Name> <test point identifier>
 Test point name, as queried with the command :
[DIAGnostic<hw>:POINT:CATalog?](#)

Return values:

<Value> <value><unit>

Example: See [Example"Programming example"](#) on page 596.

Usage: Query only

14.8 HUMS remote control commands

The remote control commands for the health and utilizations monitoring system (HUMS) comprise commands of the `DIAGnostic` subsystem and the commands of the `SYSTEM:COMMunicate:REST` and `SYSTEM:COMMunicate:REST` subsystems.

For all HUMS-related remote control commands, see refer to the "R&S®HUMS Health and Utilization Monitoring Service" User Manual on the Internet.

Commands

<code>DIAGnostic:HUMS:DELeTe:ALL</code>	599
<code>DIAGnostic:HUMS:DEVice:HISTory?</code>	599
<code>DIAGnostic:HUMS:DEVice:HISTory:DELeTe:ALL</code>	600
<code>DIAGnostic:HUMS:FORMat</code>	600
<code>DIAGnostic:HUMS:SAVE</code>	601
<code>DIAGnostic:HUMS:STATe</code>	601
<code>DIAGnostic:HUMS:TAgS:ALL?</code>	601
<code>DIAGnostic:HUMS:TAgS:DELeTe</code>	602
<code>DIAGnostic:HUMS:TAgS:DELeTe:ALL</code>	602
<code>DIAGnostic:HUMS:TAgS[:VALue]</code>	602
<code>SYSTEM:COMMunicate:REST:ENABle</code>	603
<code>SYSTEM:COMMunicate:SNMP:COMMunity:RO</code>	603
<code>SYSTEM:COMMunicate:SNMP:COMMunity:RW</code>	603
<code>SYSTEM:COMMunicate:SNMP:CONtAct</code>	604
<code>SYSTEM:COMMunicate:SNMP:LOCation</code>	604
<code>SYSTEM:COMMunicate:SNMP:USM:USER</code>	604
<code>SYSTEM:COMMunicate:SNMP:USM:USER:ALL?</code>	605
<code>SYSTEM:COMMunicate:SNMP:USM:USER:DELeTe</code>	605
<code>SYSTEM:COMMunicate:SNMP:USM:USER:DELeTe:ALL</code>	605
<code>SYSTEM:COMMunicate:SNMP:VERSion</code>	605

`DIAGnostic:HUMS:DELeTe:ALL`

Deletes the complete HUMS data. This includes device history, device tags, SCPI connections, utilization history and utilizations.

Example: `//Delete HUMS data`
 `DIAG:HUMS:DEL:ALL`

Usage: Event

`DIAGnostic:HUMS:DEVice:HISTory?`

Queries the device history information of the connected instrument. Depending on the set data format, the queried data is either displayed in `XML` or `JSON` format. For more information about setting the data format, see `DIAGnostic:HUMS:FORMat` on page 600.

Return values:
 <HistoryInfo> <block_data>

Device history information of the connected instrument as block data in a comma-separated list:

```
#blockdata[{event1},{event2},{event3}...]
```

With the following parameters:

```
<eventID>,<eventTimestamp>,<eventMessage>,<eventDetails>,<eventSeverity>
```

Binary block data with the following syntax:

```
#<Digits><Length><Binarydata>
```

#

Indicates the start of the binary block

<Digits>

Decimal value

Gives the number of decimal digits used for the <Length> value

<Length>

Decimal value

Number of bytes the follow in the <Binary data> part

<Binary data>

Binary data in ASCII format

Example:

```
//Return device history
```

```
DIAG:HUMS:DEV:HIST?
```

Returns for example:

```
#44715[{"eventId":32,"eventTimestamp":
"2021-02-02T17:25:39Z","eventMessage":
"Deviation from Self Alignment Temperature",
"eventDetails":
"Deviations resolved","eventSeverity":0}
```

Usage:

Query only

Manual operation:

See ["Export History"](#) on page 527

DIAGnostic:HUMS:DEvice:HISTory:DElete:ALL

Deletes the complete device history information of the connected instrument.

Example:

```
//Delete complete device history
```

```
DIAG:HUMS:DEV:HIST:DEL:ALL
```

Usage:

Event

Manual operation:

See ["Delete History"](#) on page 526

DIAGnostic:HUMS:FORMat <DataFormat>

Selects the format for the queried HUMS data. You can query the HUMS data either in JSON format or XML format.

The defined format affects all other commands that return block data.

Parameters:

```
<DataFormat>      JSON | XML
```

JSON

Returns the HUMS data in `JSON` format.

XML

Returns the HUMS data in `XML` format.

*RST: JSON

Example: //Return data in `JSON` format
 DIAG:HUMS:FORM JSON

DIAGnostic:HUMS:SAVE <path>

Saves the HUMS history as a `ZIP` file to your preferred path.

Setting parameters:

<path>

Example: //Save HUMS history data
 DIAG:HUMS:SAVE 'C:\HUMS\hums_2021.zip'

Usage: Setting only

Manual operation: See "[Export History](#)" on page 527

DIAGnostic:HUMS:STATe <State>

Turns the HUMS service and data collection on and off.

Parameters:

<State> ON | OFF | 1 | 0
 *RST: ON

Example: //Turn on HUMS service
 DIAG:HUMS:STAT ON

Manual operation: See "[State](#)" on page 526

DIAGnostic:HUMS:TAgS:ALL?

Queries all key-value tags that you have assigned to the instrument. Depending on the set data format, the queried data is either displayed in `XML` or `JSON` format. For more information about setting the data format, see [DIAGnostic:HUMS:FORMat](#) on page 600.

Return values:

<ID> ID number of the defined tag.
 <Key> String containing key name of the defined tag.
 <Value> String containing value of the defined tag.

Example: //Return all tags
 DIAG:HUMS:TAgS:ALL?
 1,"location","building_11",2,"time zone","CET"

Usage: Query only
Manual operation: See "Add" on page 535

DIAGnostic:HUMS:TAGS:DELeTe <ID>

Deletes a certain tag you assigned to your instrument, including its key and value.

Setting parameters:

<ID> ID number of the tag you want to delete.
 To identify the ID number, query all device tags from the system first. For more information, see [DIAGnostic:HUMS:TAGS:ALL?](#) on page 601.

Example: //Delete tag
 DIAG:HUMS:TAGS:DEL 0

Usage: Setting only

Manual operation: See "Delete" on page 535

DIAGnostic:HUMS:TAGS:DELeTe:ALL

Deletes all key-value tags you have assigned to the instrument.

Example: //Delete all tags
 DIAG:HUMS:TAGS:DEL:ALL

Usage: Event

Manual operation: See "Delete All" on page 535

DIAGnostic:HUMS:TAGS[:VALue] <ID>, <Key>, <Value>

DIAGnostic:HUMS:TAGS[:VALue]? <ID>

Adds or modifies a key-value pair (device tag).

The query returns the key-value pair for a given ID or an empty string if the ID is unknown.

Parameters:

<Key> String containing key name of the queried tag.

<Value> String containing value of the queried tag.

Parameters for setting and query:

<ID> 0 - 31
 ID number of the tag you want to modify or query.
 To identify the ID number, query all device tags from the system first. For more information, read here [DIAGnostic:HUMS:TAGS:ALL?](#) on page 601.

Example: //Add or modify a tag (tag 1)
 DIAG:HUMS:TAGS 1,'location','building_11'

Manual operation: See ["Key"](#) on page 534
 See ["Value"](#) on page 534
 See ["Add"](#) on page 535

SYSTem:COMMunicate:REST:ENABLE <RestState>

Turns communication via the REST API on and off.

Parameters:

<RestState> ON | OFF | 0 | 1

Example:

```
//Return REST state
SYST:COMM:REST:ENAB?
```

Manual operation: See ["REST"](#) on page 528

SYSTem:COMMunicate:SNMP:COMMunity:RO <CommunityString>

Defines the SNMP community string for read-only access.

Prerequisites for this command:

- Select an SNMP version that supports communities ([SYSTem:COMMunicate:SNMP:VERSion](#) on page 605).

Setting parameters:

<CommunityString> String containing the community name.

Example:

```
//Set community name
SYST:COMM:SNMP:VERS V12
SYST:COMM:SNMP:COMM:RO 'ABC'
```

Usage:

Setting only

Manual operation: See ["Access"](#) on page 529

SYSTem:COMMunicate:SNMP:COMMunity:RW <CommunityString>

Defines the SNMP community string for read-write access.

Prerequisites for this command:

- Select an SNMP version that supports communities ([SYSTem:COMMunicate:SNMP:VERSion](#) on page 605).

Setting parameters:

<CommunityString> String containing the community name.

Example:

```
//Set read-write access
SYST:COMM:SNMP:VERS V12
SYST:COMM:SNMP:COMM:RW 'ABC'
```

Usage:

Setting only

Manual operation: See ["Access"](#) on page 529

SYSTem:COMMunicate:SNMP:CONtact <SnmContact>

Defines the SNMP contact information for the administrator.

You can also set the contact information via SNMP if you do not set it via SCPI.

Parameters for setting and query:

<SnmContact> String containing SNMP contact.
*RST: "" (empty string)

Example: //Set SNMP contact
SYST:COMM:SNMP:CONT 'ABC'

Manual operation: See "[Contact](#)" on page 529

SYSTem:COMMunicate:SNMP:LOCation <SnmLocation>

Defines the SNMP location information for the administrator.

You can also set the location information via SNMP if you do not set it via SCPI.

Parameters for setting and query:

<SnmLocation> String containing SNMP location.
*RST: "" (empty string)

Example: //Return SNMP location
SYST:COMM:SNMP:LOC?

Manual operation: See "[Location](#)" on page 529

SYSTem:COMMunicate:SNMP:USM:USER <Name>, <Access>, <Level>[, <Auth_pwd>[, <Priv_pwd>]]

Defines an SNMP user profile.

Prerequisites for this command:

- Select SNMPv3 ([SYSTem:COMMunicate:SNMP:VERSion](#) on page 605).

Setting parameters:

<Name> String containing name of the user.
<Access> RO | RW
Defines the access right a user can have.
<Level> NOAuth | AUTH | PRIVacy
Defines the security level.
<Auth_pwd> String containing the authentication password.
<Priv_pwd> String containing the privacy password.

Example: //Create user profile
SYST:COMM:SNMP:VERS V123
SYST:COMM:SNMP:USM:USER 'Peter', 'RO', 'PRIV',
'1234', 'XYZ'

Usage: Setting only

Manual operation: See ["Add SNMP User for HUMS"](#) on page 532

SYSTem:COMMunicate:SNMP:USM:USER:ALL?

Queries the number of users and a list of all SNMP users for SNMPv3.

Prerequisites for this command:

- Select SNMPv3 ([SYSTem:COMMunicate:SNMP:VERSion](#) on page 605).

Return values:

<Count> Total number of registered SNMP users.

<Name> List of all user names as a comma-separated list.

Example: //Return all SNMP users
SYST:COMM:SNMP:USM:USER:ALL?

Usage: Query only

Manual operation: See ["User table"](#) on page 530

SYSTem:COMMunicate:SNMP:USM:USER:DELeTe <UserName>

Deletes a specific SNMP user profile.

Setting parameters:

<UserName> String containing name of SNMP user profile to be deleted.

Example: //Delete SNMP user profile
SYST:COMM:SNMP:USM:USER:DEL "Peter"

Usage: Setting only

Manual operation: See ["Delete"](#) on page 532

SYSTem:COMMunicate:SNMP:USM:USER:DELeTe:ALL

Deletes all SNMP user profiles.

Example: //Delete all SNMP user profiles
SYST:COMM:SNMP:USM:USER:DEL:ALL

Usage: Event

Manual operation: See ["Delete All"](#) on page 530

SYSTem:COMMunicate:SNMP:VERSion <SnmVersion>

Selects the SNMP version.

Parameters for setting and query:

<SnmVersion> OFF | V12 | V123 | V3 | DEFault

OFF

SNMP communication is off.

V12

SNMP communication with SNMPv2 or lower.

V123

SNMP communication with SNMPv2 and SNMPv3.

V3

SNMP communication with SNMPv3.

*RST: V123

Example:

```
//Select the SNMP version
SYST:COMM:SNMP:VERS V12
```

Manual operation: See ["SNMP"](#) on page 528

14.9 DISPlay subsystem

The DISPlay system contains the commands to set the power-save mode of the instrument.

Programming Examples

Example: Activating screen saver mode and display update

Use the following commands to switch on the screen saver of your instrument or to automatic display. These settings are particularly useful when you control the instrument remotely.

```
// Set the wait time interval and activate the screen saver
DISPlay:PSAVE:HOLDoff 10
DISPlay:PSAVE:STATE ON

// Disable the display of the current frequency and level values in remote control
DISPlay:ANNotation:ALL ON
// DISPlay:ANNotation:FREQuency ON
// DISPlay:ANNotation:AMPLitude ON

// Enable automatic update of the display at defined time intervals
DISPlay:UPDate[:STATE] ON
```

Example: Querying the dialog IDs, opening and closing dialogs

Use the following commands to query the dialog IDs of all currently open dialogs. The dialog ID is a prerequisite for opening and closing dialogs via the remote control.



The dialog ID is also required to define user key actions.

See [Chapter 12.4.4, "How to assign actions to the \[★ \(User\)\] key"](#), on page 465.

```

// Query the dialog IDs of all open dialogs
DISPlay:DIALog:ID?
// CEUtraDLGenSetDlg,_, $A DlgKeyRf_Rosc

// Open and close dialogs via remote control
DISPlay:DIALog:OPEN "CEUtraDLGenSetDlg,_, $A"
DISPlay:DIALog:OPEN "DlgKeyRf_Rosc"
DISPlay:DIALog:CLOSe "DlgKeyRf_Rosc"
DISPlay:DIALog:CLOSe:ALL

:DISPlay:PSAVe:HOLDoff..... 607
:DISPlay:PSAVe[:STATe]..... 607
:DISPlay:BRIGhtness..... 608
:DISPlay:BUTTon:BRIGhtness..... 608
:DISPlay:UPDate[:STATe]..... 608
:DISPlay:ANNotation:AMPLitude..... 608
:DISPlay:ANNotation:FREQuency..... 609
:DISPlay:ANNotation[:ALL]..... 609
:DISPlay:DIALog:ID?..... 609
:DISPlay:DIALog:OPEN..... 610
:DISPlay:DIALog:CLOSe..... 610
:DISPlay:DIALog:CLOSe:ALL..... 611

```

:DISPlay:PSAVe:HOLDoff <HoldoffTimeMin>

Sets the wait time for the screen saver mode of the display.

Parameters:

<HoldoffTimeMin> integer
 Range: 1 to 60
 *RST: n.a. (factory preset: 10)
 Default unit: minute

Example: see [Example "Activating screen saver mode and display update"](#) on page 606

Manual operation: See ["Wait Time"](#) on page 446

:DISPlay:PSAVe[:STATe] <State>

Activates the screen saver mode of the display.

We recommend that you use this mode to protect the display, if you operate the instrument in remote control.

To define the wait time, use the command `:DISPlay:PSAVe:HOLDoff`.

Parameters:

<State> 1 | ON | 0 | OFF
 *RST: n.a. (factory preset: 0)

Example: See [Example "Activating screen saver mode and display update"](#) on page 606

Manual operation: See ["Screen Saver"](#) on page 446

:DISPlay:BRIGhtness <BRIGhtness>

Sets the brightness of the display.

Parameters:

<BRIGhtness> float
 Range: 1.0 to 20.0
 Increment: 1.0
 *RST: 14.0

Example: DISPlay:BRIGhtness 14

Manual operation: See ["Display"](#) on page 446

:DISPlay:BUtTon:BRIGhtness <ButtonBrightnes>

Sets the brightness of the [RF on/off] key.

Parameters:

<ButtonBrightnes> integer
 Range: 1 to 20
 *RST: n.a. (no preset. default: 14)

Example: DISPlay:BUtTon:BRIGhtness 15

Manual operation: See ["RF Hardkey"](#) on page 446

:DISPlay:UPDate[:STATe] <Update>

Activates the refresh mode of the display.

Parameters:

<Update> 1 | ON | 0 | OFF
 *RST: n.a. (factory preset: 1)

Example: See [Example "Activating screen saver mode and display update"](#) on page 606

Manual operation: See ["Display Update is"](#) on page 447

:DISPlay:ANNotation:AMPLitude <State>

Indicates asterisks instead of the level values in the status bar.

Parameters:

<State> 1 | ON | 0 | OFF
 *RST: n.a. (factory preset: 1)

Example: See [Example "Activating screen saver mode and display update"](#) on page 606

Manual operation: See ["Annotation Amplitude"](#) on page 486

:DISPlay:ANNotation:FREQuency <State>

Indicates asterisks instead of the frequency values in the status bar.

Parameters:

<State> 1 | ON | 0 | OFF
 *RST: n.a. (factory preset: 1)

Example: See [Example"Activating screen saver mode and display update"](#) on page 606

Manual operation: See ["Annotation Frequency"](#) on page 486

:DISPlay:ANNotation[:ALL] <State>

Displays asterisks instead of the level and frequency values in the status bar of the instrument.

We recommend that you use this mode if you operate the instrument in remote control.

Parameters:

<State> 1 | ON | 0 | OFF
 *RST: 1

Example: See [Example"Activating screen saver mode and display update"](#) on page 606

:DISPlay:DIALog:ID?

Returns the dialog identifiers of the open dialogs in a string separated by blanks.

Return values:

<DialogIdList> <DialogID#1>< ><DialogID#2>< > ... < ><DialogID#n>
 Dialog identifiers are string without blanks. Blanks are represented as \$\$.
 Dialog identifiers <DialogID> are composed of two main parts:
 <DialogName>[<OptionalParts>]
<DialogName>
 Meaningful information, mandatory input parameter for the commands:
 :DISPlay:DIALog:OPEN on page 610
 :DISPlay:DIALog:CLOSe on page 610

<Optional parts>

String of $\$<X>$ values, where $<X>$ is a character, interpreted as follows:

$\$q<DialogQualifier>$: optional dialog qualifier, usually the letter A or B, as displayed in the dialog title.

$\$i<Instances>$: comma-separated list of instance indexes, given in the order h, c, s, d, g, u, 0. Default is zero; the terminating ", 0" can be omitted.

$\$t<TabIds>$: comma-separated indexes or tab names; required, if a dialog is composed of several tabs.

$\$x<Left>\$y<Top>\$h<Left>\$w<Top>$: position and size; superfluous information.

Example: See [Example "Querying the dialog IDs, opening and closing dialogs"](#) on page 606

Usage: Query only

Manual operation: See ["SCPI"](#) on page 465

:DISPlay:DIALog:OPEN <DialogId>

Opens the specified dialog.

Setting parameters:

<DialogId> string

To find out the dialog identifier, use the query [:DISPlay:DIALog:ID?](#).

The <DialogName> part of the query result is mandatory.

Example: See [Example "Querying the dialog IDs, opening and closing dialogs"](#) on page 606

Usage: Setting only

Manual operation: See ["SCPI"](#) on page 465

:DISPlay:DIALog:CLOSe <DialogId>

Closes the specified dialog.

Setting parameters:

<DialogId> string

To find out the dialog identifier, use the query [:DISPlay:DIALog:ID?](#).

The <DialogName> part of the query result is sufficient.

Example: See [Example "Querying the dialog IDs, opening and closing dialogs"](#) on page 606

Usage: Setting only

:DISPlay:DIALog:CLOSE:ALL

Closes all open dialogs.

Example: See [Example "Querying the dialog IDs, opening and closing dialogs"](#) on page 606

Usage: Event

14.10 FORMat subsystem

The commands in the FORMat subsystem determine the format of data returned by the R&S SMCV100B to the controller. This affects all query commands that return a list of numerical data or block data, noted in the descriptions of the commands. The set data format applies to both paths.

:FORMat:BORDER	611
:FORMat:SREGister	611
:FORMat[:DATA]	612

:FORMat:BORDER <Border>

Determines the sequence of bytes within a binary block. This only affects blocks which use the IEEE754 format internally.

Parameters:

<Border> NORMAL | SWAPped

NORMAL

Expects/sends the *least* significant byte of each IEEE754 floating-point number first and the *most* significant byte last.

SWAPped

Expects/sends the *most* significant byte of each IEEE754 floating-point number first and the *least* significant byte last.

*RST: NORMAL

Example: :FORM:BORD SWAP
transfers the data with the most significant bit first.

:FORMat:SREGister <Format>

Determines the numeric format for responses of the status register.

Parameters:

<Format> ASCii | BINary | HEXadecimal | OCTal

ASCii

Returns the register content as a decimal number.

BINary|HEXadecimal|OCTal

Returns the register content either as a binary, hexadecimal or octal number. According to the selected format, the number starts with #B (binary), #H (hexadecimal) or #O (octal).

*RST: ASCII

Example:

```
:FORM:SREG HEX
```

returns the register content as a hexadecimal number.

:FORMat[:DATA] <Data>

Determines the data format the instrument uses to return data via the IEC/IEEE bus.

The instrument automatically detects the data format used by the controller, and assigns it accordingly. Data format determined by this SCPI command is in this case irrelevant.

Parameters:

<Data>

ASCII | PACKed

ASCII

Transfers numerical data as plain text separated by commas.

PACKed

Transfers numerical data as binary block data.

The format within the binary data depends on the command.

The various binary data formats are explained in the description of the parameter types.

*RST: ASCII

Example:

```
:FORM ASC
```

transfers the data as ASCII data.

14.11 HCOPY subsystem

The **HCOPY** subsystem contains the commands to generate and save a hard copy of the display.



To access a stored hard copy file, use the commands of the **MEMM** subsystem.

Example: Store a hard copy of the display

The following example lists commands to configure and execute a hard copy to an automatic named file.

```
:HCOPY:DEVice:LANGUage PNG
:HCOPY:FILE:NAME:AUTO:STATe 1
// defines the output format
// sets the instrument to automatically create output file names
```

```

// *****
// Configure hard copy options, set automatic naming rules
// An automatically generated file name consists of:
// <Prefix><YYYY><MM><DD><Number>.<Format>
// *****
:HCOPY:DEVIce:LANGUage BMP
// defines output format *.bmp
:HCOPY:REGIon DIALog
// selects the region to be copied
:HCOPY:FILE:AUTO:DIR "/usb/HCopy"
// sets destination directory of automatic named file
:HCOPY:FILE:NAME:AUTO:FILE:PREFIx:STATe 1
:HCOPY:FILE:NAME:AUTO:FILE:PREFIx:"hardcopy"
:HCOPY:FILE:NAME:AUTO:FILE:YEAR:STATe 1
:HCOPY:FILE:NAME:AUTO:FILE:MONTH:STATe 1
// uses automatic naming prefix
// sets automatic naming prefix to "hardcopy"
// uses automatic naming date parameters year and month

// *****
// Execute and transfer the hard copy
// *****
:HCOPY:EXECute
:HCOPY:DATA
// generates a hard copy
// transfers the hard copy to the remote client
:HCOPY:FILE:AUTO:FILE?
// queries the automatic file name
// "hardcopy1607001.bmp"
:HCOPY:FILE:AUTO:NUMBer?
// queries the number in the automatic file name
// "001"
:HCOPY:FILE:AUTO?
// queries the path and file name of the automatically generated file
// "/usb/HCopy/hardcopy1607001.bmp"

```

14.11.1 Hard copy settings

With the following commands, you can configure the settings of a hard copy.

:HCOPY:DATA?	614
:HCOPY:IMAGe:FORMat	614
:HCOPY:DEVIce:LANGUage	614
:HCOPY:REGIon	614
:HCOPY:FILE[:NAME]	614
:HCOPY[:EXECute]	615

:HCOPY:DATA?

Transfers the hard copy data directly as a NByte stream to the remote client.

Return values:

<Data> block data

Example: See [Example "Store a hard copy of the display"](#) on page 612

Usage: Query only

:HCOPY:IMAGe:FORMat <Format>**:HCOPY:DEVIce:LANGUage <Language>**

Selects the graphic format for the hard copy. You can use both commands alternatively.

Parameters:

<Language> BMP | JPG | XPM | PNG
*RST: PNG

Example: See [Example "Store a hard copy of the display"](#) on page 612

Manual operation: See ["Format"](#) on page 441

:HCOPY:REGion <Region>

Selects the area to be copied.

You can create a snapshot of the screen or an active dialog.

Parameters:

<Region> ALL | DIALog
*RST: ALL

Example: See [Example "Store a hard copy of the display"](#) on page 612

Manual operation: See ["Region"](#) on page 442

:HCOPY:FILE[:NAME] <Name>

Determines the file name and path to save the hard copy, provided automatic naming is disabled.

Note: If you have enabled automatic naming, the instrument automatically generates the file name and directory, see [Chapter 14.11.2, "Automatic naming"](#), on page 615.

Parameters:

<Name> string

Example: See [Example "Store a hard copy of the display"](#) on page 612

Manual operation: See ["File..."](#) on page 441

:HCOPY[:EXECute]

Generates a hard copy of the current display. The output destination is a file.

Example: See [Example "Store a hard copy of the display"](#) on page 612

Usage: Event

Manual operation: See ["Save"](#) on page 441

14.11.2 Automatic naming

Use the following commands to automatically assign a file name.

:HCOPY:FILE[:NAME]:AUTO?	615
:HCOPY:FILE[:NAME]:AUTO:DIRectory	615
:HCOPY:FILE[:NAME]:AUTO:DIRectory:CLear	616
:HCOPY:FILE[:NAME]:AUTO:FILE?	616
:HCOPY:FILE[:NAME]:AUTO:STATe	616
:HCOPY:FILE[:NAME]:AUTO[:FILE]:DAY:STATe	616
:HCOPY:FILE[:NAME]:AUTO[:FILE]:MONTH:STATe	616
:HCOPY:FILE[:NAME]:AUTO[:FILE]:YEAR:STATe	616
:HCOPY:FILE[:NAME]:AUTO[:FILE]:NUMBer?	617
:HCOPY:FILE[:NAME]:AUTO[:FILE]:PREFix	617
:HCOPY:FILE[:NAME]:AUTO[:FILE]:PREFix:STATe	617

:HCOPY:FILE[:NAME]:AUTO?

Queries path and file name of the hardcopy file, if you have enabled *Automatic Naming*.

Return values:

<Auto> string

Example: See [Example "Store a hard copy of the display"](#) on page 612

Usage: Query only

:HCOPY:FILE[:NAME]:AUTO:DIRectory <Directory>

Determines the path to save the hard copy, if you have enabled *Automatic Naming*.

If the directory does not yet exist, the instrument automatically creates a new directory, using the instrument name and `/var/user/` by default.

Parameters:

<Directory> string
*RST: `/var/user/`

Example: See [Example "Store a hard copy of the display"](#) on page 612

Manual operation: See ["Path..."](#) on page 442

:HCOPY:FILE[:NAME]:AUTO:DIRectory:CLEar

Deletes all files with extensions *.bmp, *.jpg, *.png and *.xpm in the directory set for automatic naming.

Example: See [Example "Store a hard copy of the display"](#) on page 612

Usage: Event

Manual operation: See ["Clear Path"](#) on page 442

:HCOPY:FILE[:NAME]:AUTO:FILE?

Queries the name of the automatically named hard copy file.

An automatically generated file name consists of:

<Prefix><YYYY><MM><DD><Number>.<Format>.

You can activate each component separately, to individually design the file name.

Return values:

<File> string

Example: See [Example "Store a hard copy of the display"](#) on page 612.

Usage: Query only

:HCOPY:FILE[:NAME]:AUTO:STATe <State>

Activates automatic naming of the hard copy files.

Parameters:

<State> 1 | ON | 0 | OFF
*RST: 1

Example: See [Example "Store a hard copy of the display"](#) on page 612

Manual operation: See ["Automatic Naming"](#) on page 441

:HCOPY:FILE[:NAME]:AUTO[:FILE]:DAY:STATe <State>**:HCOPY:FILE[:NAME]:AUTO[:FILE]:MONTH:STATe <State>****:HCOPY:FILE[:NAME]:AUTO[:FILE]:YEAR:STATe <State>**

Uses the date parameters (year, month or day) for the automatic naming. You can activate each of the date parameters separately.

Parameters:

<State> 1 | ON | 0 | OFF
*RST: 1

Example: See [Example "Store a hard copy of the display"](#) on page 612

Manual operation: See ["Prefix, Year, Month, Day"](#) on page 442

:HCOPY:FILE[:NAME]:AUTO[:FILE]:NUMBER?

Queries the number that is used as part of the file name for the next hard copy in automatic mode.

At the beginning, the count starts at 0. The R&S SMCV100B searches the specified output directory for the highest number in the stored files. It increases this number by one to achieve a unique name for the new file.

The resulting auto number is appended to the resulting file name with at least three digits.

Return values:

<Number> integer
 Range: 0 to 999999
 *RST: 0

Example: See [Example "Store a hard copy of the display"](#) on page 612

Usage: Query only

Manual operation: See ["Current Auto Number"](#) on page 443

:HCOPY:FILE[:NAME]:AUTO[:FILE]:PREFIX <Prefix>**:HCOPY:FILE[:NAME]:AUTO[:FILE]:PREFIX:STATe <State>**

Uses the prefix for the automatic generation of the file name, provided `PREF:STAT` is activated.

Parameters:

<State> 1 | ON | 0 | OFF
 *RST: 1

Example: See [Example "Store a hard copy of the display"](#) on page 612

Manual operation: See ["Prefix, Year, Month, Day"](#) on page 442

14.12 KBOard subsystem

The KBOard subsystem contains the commands to set a connected keyboard.

[:KBOard:LAYout](#).....617

:KBOard:LAYout <Layout>

Selects the language for an external keyboard and assigns the keys accordingly.

Parameters:

<Layout> CHINese | DANish | DUTCh | DUTBe | ENGLish | ENGUk |
 FINNish | FRENch | FREBe | FRECa | GERMan | ITALian |
 JAPANese | KORean | NORWegian | PORTuguese | RUSSian |
 SPANish | SWEDish | ENGUS
 *RST: n.a. (factory preset: ENGLISH)

Example:

```
:KBOard:LAYout US
// activates American keyboard
```

Manual operation: See "[USB Keyboard > Layout](#)" on page 446

14.13 OUTPut subsystem

In the OUTPut subsystem, you can configure the output signals.

Common suffixes

The following common suffixes are used in remote commands:

Suffix	Value range	Description
OUTPut<hw>	[1]	Optional suffix

:OUTPut:ALL[:STATe].....	618
:OUTPut<hw>[:STATe].....	618
:OUTPut<hw>[:STATe]:PON.....	619
:OUTPut<hw>:AMODE.....	619
:OUTPut<hw>:IMPedance?.....	619
:OUTPut<hw>:AFIXed:RANGe:LOWer?.....	620
:OUTPut<hw>:AFIXed:RANGe:UPPer?.....	620
:OUTPut<hw>:PROTection:CLEar.....	620
:OUTPut<hw>:PROTection:TRIPped?.....	620

:OUTPut:ALL[:STATe] <State>

Activates the RF output signal of the instrument.

Parameters:

<State> 1 | ON | 0 | OFF
 *RST: n.a. (factory preset: 0)

Example:

```
:OUTPut:ALL:STATe 0
```

:OUTPut<hw>[:STATe] <State>

Activates the RF output signal.

Parameters:

<State> 1 | ON | 0 | OFF
 *RST: 0

Example:

:OUTPut1 ON
 Activates the RF output.

Manual operation: See "[RF State/RF ON](#)" on page 304

:OUTPut<hw>[:STATe]:PON <Pon>

Defines the state of the RF output signal when the instrument is switched on.

Parameters:

<Pon> OFF | UNCHanged
 *RST: n.a. (factory preset: UNCHanged)

Example:

:OUTPut1:PON OFF
 The RF output is deactivated when the instrument is switched on.

Manual operation: See "[Power-On State](#)" on page 447

:OUTPut<hw>:AMODE <AMode>

Sets the step attenuator mode at the RF output.

Parameters:

<AMode> AUTO | FIXed

AUTO
 The step attenuator adjusts the level settings automatically, within the full variation range.

FIXed
 The step attenuator and amplifier stages are fixed at the current position, providing level settings with constant output VSWR. The resulting variation range is calculated according to the position.

*RST: AUTO

Example:

:SOURce1:POWer:ALC:STATe 1
 :OUTPut1:AMODE FIXed

Manual operation: See "[Mode](#)" on page 354

:OUTPut<hw>:IMPedance?

Queries the impedance of the RF outputs.

Return values:

<Impedance> G1K | G50 | G10K
 *RST: G50

Example: :OUTPut1:IMP?
queries the impedance of RF output.
Response: 50
the impedance is 50 ohms

Usage: Query only

Manual operation: See "[RF output impedance](#)" on page 304

:OUTPut<hw>:AFIXed:RANGe:LOWer?

:OUTPut<hw>:AFIXed:RANGe:UPPer?

Queries the settable minimum/maximum value in mode :OUTPut:AMode FIXed, i.e. when the attenuator is not being adjusted.

Return values:

<Upper> float
Increment: 0.01
Default unit: dBm

Example: :OUTPut1:AMode FIXed
 :OUTPut1:AFIXed:RANGe:UPPer?
 // -27
 :OUTPut1:AFIXed:RANGe:LOW?
 // -50

Usage: Query only

Manual operation: See "[Level Range](#)" on page 354

:OUTPut<hw>:PROTection:CLEar

Resets the protective circuit after it has been tripped.

To define the output state, use the command :OUTPut<hw>[:STATe].

Example: :OUTPut1:PROT:CLE
Resets the protective circuit of the RF output.

Usage: Event

Manual operation: See "[Overload](#)" on page 355

:OUTPut<hw>:PROTection:TRIPped?

Queries the state of the protective circuit.

Return values:

<Tripped> 1 | ON | 0 | OFF
*RST: 0

- Example:** :OUTPut1:PROT:TRIP
queries the state of the protective circuit of the RF output.
Response: 0
the protective circuit has not tripped.
- Usage:** Query only
- Manual operation:** See "Overload" on page 355

14.14 SENSe, READ, INITiate and SLISt subsystems

These subsystems contain the commands for configuring the power measurements with R&S NRP power sensor connected to the R&S SMCV100B.



The local state is set with the `INIT` command. Switching off the local state enhances the measurement performance. Measurements results can be retrieved in local state on or off.

Sensor parameters are set with the `SENSe` commands.

To start the measurement and retrieve the result, use the `:READ<ch>[:POWer]?` command.

Suffix	Value range	Description
SENSe<ch>	[1] to 4	Indicates the sensor Use the <code>:SLISt</code> commands to change the sensor mapping
READ<ch>	[1] to 4	Sensor assignment
INIate<hw>	[1] to 4	Sensor assignment
ELEMent<ch>	[1] to 25	Sensor-mapping list

Programming examples

Example: Detecting and assigning a power sensor

```

SLISt:LIST?
// Response: "NRP33SN-V-900007-USB Legacy","NRP-Z211-900001-USB Legacy"
// Lists all automatically detected sensors.

SLISt:SCAN:STATe 1
// Searches for sensors connected in the LAN or via the USBTMC protocol.

SLISt:SCAN:LSEnsor 'NRQ6',101624 // sensor name, serial number
SLISt:SCAN:LSEnsor 11.123.1.123, 101624 // IP address, serial number
// Adds sensors to the list, that are connected to LAN.

SLISt:SCAN:USEnsor 'NRQ6',101624 //sensor name, serial number
SLISt:SCAN:USEnsor #H15b,101624 //device ID (hexadecimal), serial number
SLISt:SCAN:USEnsor 347,101624 //device ID (decimal), serial number
// Adds a sensor to the list, that is connected to the USB interface.

SLISt:LIST?
// Response: "NRP33SN-V-900007-USB Legacy","NRP-Z211-900001-USB Legacy",
// "NRP33SN-V-900005-USBTMC","NRP33SN-V-900011-LAN"
// Lists all automatically detected sensors.

SLISt:ELEMent3:MAPPING SENS1
// Maps the third sensor from the list to the first sensor channel.

SLISt:SENSor:MAP "NRPS18S-100654-USB Legacy", SENS3
// Maps the sensor to channel 3.

SLISt:CLEar[ALL]
// Remove all sensors from the list.
SLISt:CLEar:LAN
// Remove all sensors from the list, that are connected over LAN.
SLISt:CLEar:USB
// Remove all sensors from the list, that are connected over USB.

```

Example: Performing a simple power measurement

Prerequisite: The sensor is connected to the instrument and mapped to the first sensor channel.

```

INITiate1:CONTinuous ON
// Switches the continuous power measurement on.

READ1?
// Triggers the measurement and displays the results.

```

Example: Performing a power measurement with a fixed filter

Prerequisite: The sensor is connected to the instrument and mapped to the first sensor channel.

```

SENSe1:SOURce RF
// Sensor measures the power of the RF signal.

SENSe1:FILTer:TYPE NSRatio
// Selects fixed noise filter mode.

SENSe1:FILTer:NSRatio 0.02 DB
// Sets the maximum noise component in the result to 0.02 DB.

SENSe1:FILTer:NSRatio:MTIME 10
//Limits the settling time to 10 seconds.

SENSe1:APERture:DEFault:STATe 0
// Deactivates the default aperture time of the sensor.

SENSe1:APERture:TIME 10e-6
// Sets the aperture time to 10 us.

SENSe1:UNIT DBM
// Selects unit dBm for the measured value.

INITiate:CONTinuous ON
// Switches the continuous power measurement on.

READ?
// Triggers the measurement and displays the results.

```

:SLISt[:LIST]?.....	624
:SLISt:SCAN[:STATe].....	624
:SLISt:SCAN:LENSor.....	624
:SLISt:SCAN:USENSor.....	625
:SLISt:CLEar:LAN.....	625
:SLISt:CLEar:USB.....	625
:SLISt:CLEar[:ALL].....	626
:SLISt:ELEMent<ch>:MAPPing.....	626
:SLISt:SENSor:MAP.....	626
:INITiate<hw>[:POWer]:CONTinuous.....	626
:READ<ch>[:POWer]?.....	627
:SENSe<ch>:UNIT[:POWer].....	628
:SENSe<ch>[:POWer]:APERture:DEFault:STATe.....	628
:SENSe<ch>[:POWer]:APERture:TIME.....	628
:SENSe<ch>[:POWer]:CORRection:SPDevice:SELEct.....	629
:SENSe<ch>[:POWer]:CORRection:SPDevice:STATe.....	629
:SENSe<ch>[:POWer]:CORRection:SPDevice:LIST?.....	629
:SENSe<ch>[:POWer]:DISPlay:PERManent:PRiority.....	629
:SENSe<ch>[:POWer]:DISPlay:PERManent:STATe.....	630
:SENSe<ch>[:POWer]:FILTer:LENGth:AUTO?.....	630

:SENSe<ch>[:POWer]:FILTer:LENGth[:USER]	630
:SENSe<ch>[:POWer]:FILTer:NSRatio	631
:SENSe<ch>[:POWer]:FILTer:NSRatio:MTIME	631
:SENSe<ch>[:POWer]:FILTer:SONCe	631
:SENSe<ch>[:POWer]:FILTer:TYPE	632
:SENSe<ch>[:POWer]:FREQUency	632
:SENSe<ch>[:POWer]:LOGGing:STATe	633
:SENSe<ch>[:POWer]:OFFSet	633
:SENSe<ch>[:POWer]:OFFSet:STATe	633
:SENSe<ch>[:POWer]:SNUMber?	634
:SENSe<ch>[:POWer]:SOURce	634
:SENSe<ch>[:POWer]:STATus[:DEVice]?	634
:SENSe<ch>[:POWer]:TYPE?	635
:SENSe<ch>[:POWer]:ZERO	635

:SLISt[:LIST]?

Returns a list of all detected sensors in a comma-separated string.

Return values:

<SensorList> String of comma-separated entries
 Each entry contains information on the sensor type, serial number and interface.
 The order of the entries does not correspond to the order the sensors are displayed in the "NRP Sensor Mapping" dialog.

Example: See [Example "Detecting and assigning a power sensor"](#) on page 622.

Usage: Query only

Manual operation: See ["Sensor Mapping List"](#) on page 381

:SLISt:SCAN[:STATe] <State>

Starts the search for R&S NRP power sensors, connected in the LAN or via the USBTMC protocol.

Parameters:

<State> 1 | ON | 0 | OFF
 *RST: 0

Example: See [Example "Detecting and assigning a power sensor"](#) on page 622.

Manual operation: See ["Scan"](#) on page 382

:SLISt:SCAN:LSENSor <IP>

Scans for R&S NRP power sensors connected in the LAN.

Setting parameters:

<IP> string
 *RST: 0

Example: See [Example"Detecting and assigning a power sensor"](#) on page 622.

Usage: Setting only

Manual operation: See ["Add LAN Sensor settings"](#) on page 382

:SLISt:SCAN:USENSor <DeviceID>, <Serial>

Scans for R&S NRP power sensors connected over a USB interface.

Parameters:

<Serial> integer
 Range: 0 to 999999

Setting parameters:

<DeviceID> String or Integer
 Range: 0 to 999999
 *RST: 0

Example: See [Example"Detecting and assigning a power sensor"](#) on page 622.

Usage: Setting only

Manual operation: See ["Add USB Sensor settings"](#) on page 382

:SLISt:CLEAr:LAN

Removes all R&S NRP power sensors connected in the LAN from the list.

Example: See [Example"Detecting and assigning a power sensor"](#) on page 622.

Usage: Event

Manual operation: See ["Clear"](#) on page 382

:SLISt:CLEAr:USB

Removes all R&S NRP power sensors connected over USB from the list.

Example: See [Example"Detecting and assigning a power sensor"](#) on page 622.

Usage: Event

Manual operation: See ["Clear"](#) on page 382

:SLISt:CLEAr[:ALL]

Removes all R&S NRP power sensors from the list.

Example: See [Example "Detecting and assigning a power sensor"](#) on page 622.

Usage: Event

Manual operation: See ["Clear"](#) on page 382

:SLISt:ELEMent<ch>:MAPPING <Mapping>

Assigns an entry from the `:SLISt[:LIST]?` to one of the four sensor channels.

Parameters:

<Mapping> SENS1 | SENSor1 | SENS2 | SENSor2 | SENS3 | SENSor3 |
SENS4 | SENSor4 | UNMapped

Sensor channel.

*RST: UNMapped

Example: See [Example "Detecting and assigning a power sensor"](#) on page 622.

Manual operation: See ["Sensor Mapping List"](#) on page 381

:SLISt:SENSor:MAP <SensorId>, <Mapping>

Assigns a sensor directly to one of the sensor channels, using the sensor name and serial number.

To find out the the sensor name and ID, you can get it from the label of the R&S NRP, or using the command `:SLISt:SCAN[:STATe]`. This command detects all R&S NRP power sensors connected in the LAN or via 'USBTMC protocol.

Setting parameters:

<SensorId> string

<Mapping> enum

Example: See [Example "Detecting and assigning a power sensor"](#) on page 622.

Usage: Setting only

Manual operation: See ["Sensor Mapping List"](#) on page 381

:INITiate<hw>[:POWER]:CONTInuous <Continuous>

Switches the local state of the continuous power measurement by R&S NRP power sensors on and off. Switching off local state enhances the measurement performance during remote control.

The remote measurement is triggered with `:READ<ch>[:POWER]?`. This command also returns the measurement results. The local state is not affected, measurement results can be retrieved with local state on or off.

Parameters:

<Continuous> 1 | ON | 0 | OFF
*RST: 0

Example:

```
INIT1:CONT ON
```

Switches on the local state of continuous power measurement.

Manual operation: See ["State"](#) on page 377

:READ<ch>[:POWER]?

Triggers power measurement and displays the results.

Note: This command does not affect the local state, i.e. you can get results with local state on or off. For long measurement times, we recommend that you use an SRQ for command synchronization (MAV bit).

Suffix:

<ch> 1 to 3

Return values:

<Power> float or float,float

The sensor returns the result in the unit set with command `:SENSe<ch>:UNIT[:POWER]`

Certain power sensors, such as the R&S NRP-Z81, return two values, first the value of the average level and - separated by a comma - the peak value.

Example:

```
:SENS1:UNIT DBM
```

Selects unit dBm for presentation of measurement result.

```
:READ1?
```

Queries the measurement result of the sensor.

```
-45.6246576745440230
```

-45.6 dBm were measured at the given frequency.

Example:

```
R&S NRP-Z81
```

```
:READ1?
```

```
-55.62403263352178, -22.419472478812476
```

-55.6 dBm is the measured average level, -22.4 dBm is the measured peak level at the given frequency.

Usage:

Query only

Manual operation: See ["Measured Level"](#) on page 374

See ["Level \(Peak\) / Level \(Average\)"](#) on page 377

:SENSe<ch>:UNIT[:POWer] <Power>

Selects the unit (Watt, dBm or dB μ V) of measurement result display, queried with `:READ<ch>[:POWer]?`.

Parameters:

<Power> DBM | DBUV | WATT
*RST: DBM

Example:

```
:SENS2:UNIT DBM
Selects dBm as unit for the measured value returned by command READ.
:READ2?
Response: 7.34
7.34 dBm are measured by sensor 2.
```

Manual operation: See ["Measured Level"](#) on page 374
See ["Level \(Peak\) / Level \(Average\)"](#) on page 377

:SENSe<ch>[:POWer]:APERTure:DEFault:STATe <UseDefAp>

Deactivates the default aperture time of the respective sensor.

To specify a user-defined value, use the command `:SENSe<ch>[:POWer]:APERTure:TIME` on page 628.

Parameters:

<UseDefAp> 1 | ON | 0 | OFF
*RST: 1

Example: See [Example"Performing a power measurement with a fixed filter"](#) on page 623.

Manual operation: See ["Default Aperture Time"](#) on page 379

:SENSe<ch>[:POWer]:APERTure:TIME <ApTime>

Defines the aperture time (size of the acquisition interval) for the corresponding sensor.

Parameters:

<ApTime> float
Range: depends on connected power sensor
Increment: 1E-9
*RST: depends on connected power sensor

Example: See [Example"Performing a power measurement with a fixed filter"](#) on page 623.

Manual operation: See ["Aperture Time"](#) on page 379

:SENSe<ch>[:POWer]:CORRection:SPDevice:SElect <Select>

Several S-parameter tables can be stored in a sensor. The command selects a loaded data set for S-parameter correction for the corresponding sensor.

Parameters:

<Select> float
*RST: 0

Manual operation: See "[S-Parameter](#)" on page 380

:SENSe<ch>[:POWer]:CORRection:SPDevice:STATe <State>

Activates the use of the S-parameter correction data.

Note: If you use power sensors with attenuator, the instrument automatically activates the use of S-parameter data.

Parameters:

<State> 1 | ON | 0 | OFF
*RST: 0

Example: :SENSe1:POWer:CORRection:SPDevice:STATe 1
Activates the use of the S-parameters correction data.

Manual operation: See "[S-Parameter](#)" on page 380

:SENSe<ch>[:POWer]:CORRection:SPDevice:LIST?

Queries the list of the S-parameter data sets that have been loaded to the power sensor.

Return values:

<List> string list
*RST: 0

Usage: Query only

Manual operation: See "[S-Parameter](#)" on page 380

:SENSe<ch>[:POWer]:DISPlay:PERMANent:PRiority <Priority>

Selects average or peak power for permanent display.

Parameters:

<Priority> AVERAge | PEAK
*RST: AVERAge

Example: :SENSe1:DISP:PERM:STAT ON
Turns on the permanent view.
:SENSe1:DISP:PERM:PRI AVER
Sets the average power for display.

Manual operation: See "[Display](#)" on page 377

:SENSe<ch>[:POWer]:DISPlay:PERMANent:STATe <State>

Activates the permanent display of the measured power level results. The instrument also indicates the sensor type, the connection, the measurement source and the offset if set.

Parameters:

<State> 1 | ON | 0 | OFF
*RST: 0

Example: :SENS1:POW:DISP:PERM:STAT ON
Turns on the permanent view.

Manual operation: See "[Permanent](#)" on page 377

:SENSe<ch>[:POWer]:FILTer:LENGth:AUTO?

Queries the current filter length in filter mode AUTO ([:SENSe<ch>\[:POWer\]:FILTer:TYPE](#))

Return values:

<Auto> float
Range: 1 to 65536

Example: :SENS1:FILT:TYPE AUTO
Selects auto filter.
:SENS1:FILT:LENG:AUTO?
Queries the automatically set filter length.
Response: 1024

Usage: Query only

Manual operation: See "[Filter Length](#)" on page 379

:SENSe<ch>[:POWer]:FILTer:LENGth[:USER] <User>

Selects the filter length for [SENS:POW:FILT:TYPE USER](#). As the filter length works as a multiplier for the time window, a constant filter length results in a constant measurement time (see also "[About the measuring principle, averaging filter, filter length, and achieving stable results](#)" on page 369).

The R&S NRP power sensors provide different resolutions for setting the filter length, depending on the used sensor type:

- Resolution = 1 for R&S NRPxx power sensors
- Resolution = 2^n for sensors of the R&S NRP-Zxx family, with $n = 1$ to 16

Parameters:

<User> float
Range: 1 to 65536
*RST: 1

Example: :SENS1:FILT:TYPE USER
 Selects user filter mode.
 :SENS1:FILT:LENG 16
 Sets a filter length of 16. E.g. using a sensor with 20 ms time window, the resulting measurement time is 640 ms (2x16x20 ms)

Manual operation: See ["Filter Length"](#) on page 379

:SENSe<ch>[:POWer]:FILTer:NSRatio <NSRatio>

Sets an upper limit for the relative noise content in fixed noise filter mode (:SENSe<ch>[:POWer]:FILTer:TYPE). This value determines the proportion of intrinsic noise in the measurement results.

Parameters:

<NSRatio> float
 Range: 0.001 to 1
 Increment: 0.001
 *RST: 0.01

Example: See [Example"Performing a power measurement with a fixed filter"](#) on page 623.

Manual operation: See ["Noise/Signal Ratio"](#) on page 379

:SENSe<ch>[:POWer]:FILTer:NSRatio:MTIME <MTime>

Sets an upper limit for the settling time of the auto-averaging filter in the NSRatio mode and thus limits the length of the filter. The filter type is set with command :SENSe<ch>[:POWer]:FILTer:TYPE.

Parameters:

<MTime> float
 Range: 1 to 999.99
 Increment: 0.01
 *RST: 4

Example: See [Example"Performing a power measurement with a fixed filter"](#) on page 623.

Manual operation: See ["Timeout"](#) on page 379

:SENSe<ch>[:POWer]:FILTer:SONCe

Starts searching the optimum filter length for the current measurement conditions. You can check the result with command :SENS1:POW:FILT:LENG:USER? in filter mode USER (:SENSe<ch>[:POWer]:FILTer:TYPE).

Example: SENS1:FILT:TYPE USER
 Selects user filter mode.
 :SENS1:FILT:SONC
 Activates the search for the optimum filter length.
 :SENS1:FILT:LENG?
 Returns the found optimum filter length.
 Response: 128

Usage: Event

Manual operation: See "Auto Once" on page 379

:SENSe<ch>[:POWER]:FILTer:TYPE <Type>

Selects the filter mode. The filter length is the multiplier for the time window and thus directly affects the measurement time.

Parameters:

<Type>

AUTO | USER | NSRatio

AUTO

Automatically selects the filter length, depending on the measured value. The higher the power, the shorter the filter length, and vice versa.

USER

Allows you to set the filter length manually. As the filter-length takes effect as a multiplier of the measurement time, you can achieve constant measurement times.

NSRatio

Selects the filter length (averaging factor) according to the criterion that the intrinsic noise of the sensor (2 standard deviations) does not exceed the specified noise content. You can define the noise content with command :SENSe<ch>[:POWER]:FILTer:NSRatio.

Note: To avoid long settling times when the power is low, you can limit the averaging factor limited with the "timeout" parameter (:SENSe<ch>[:POWER]:FILTer:NSRatio:MTIME).

*RST: AUTO

Example: See [Example "Performing a power measurement with a fixed filter"](#) on page 623.

Manual operation: See "Filter" on page 378

:SENSe<ch>[:POWER]:FREQUency <Frequency>

Sets the RF frequency of the signal, if signal source :SENSe<ch>[:POWER]:SOURce USER is selected.

Parameters:

<Frequency> float
 *RST: 1 GHz

Example:

```
:SENS1:SOUR USER
Selects user-defined source.
:SENS1:FREQ 2.44GHz
Sets the RF frequency of the source which is 2.44 GHz.
```

Manual operation: See "[Frequency](#)" on page 378

:SENSe<ch>[:POWer]:LOGGing:STATe <State>

Activates the recording of the power values, measured by a connected R&S NRP power sensor.

Parameters:

<State> 1 | ON | 0 | OFF
 *RST: 0

Example:

```
:SENS:LOGG:STAT ON
Activates recording of the power measurement of the first sensor.
```

Manual operation: See "[Enable Logging](#)" on page 380

:SENSe<ch>[:POWer]:OFFSet <Offset>

Sets a level offset which is added to the measured level value after activation with command `:SENSe<ch>[:POWer]:OFFSet:STATe`. The level offset allows, e.g. to consider an attenuator in the signal path.

Parameters:

<Offset> float
 Range: -100.0 to 100.0
 *RST: 0
 Default unit: dB

Example:

```
:SENS1:POW:OFFS 10.0
Sets a level offset of 10 dB
```

Manual operation: See "[Level Offset State,Level Offset](#)" on page 378

:SENSe<ch>[:POWer]:OFFSet:STATe <State>

Activates the addition of the level offset to the measured value. The level offset value is set with command `:SENSe<ch>[:POWer]:OFFSet`.

Parameters:

<State> 1 | ON | 0 | OFF
 *RST: 0

Example: :SENS1:POW:OFFS 0.4dB
Sets a level offset of 0.4 dB
 :SENS1:POW:OFFS:STAT ON
A level offset of 0.4 dB is added to the measured value.

Manual operation: See "[Level Offset State,Level Offset](#)" on page 378

:SENSe<ch>[:POWer]:SNUMber?

Queries the serial number of the sensor.

Return values:

<SNumber> string

Example: :SENS1:SNUM?
Queries the serial number.

Usage: Query only

Manual operation: See "[Sensor type and serial number](#)" on page 376

:SENSe<ch>[:POWer]:SOURce <Source>

Determines the signal to be measured.

Note: When measuring the RF signal, the sensor considers the corresponding correction factor at that frequency, and uses the level setting of the instrument as reference level.

Parameters:

<Source> A | USER | RF
*RST: A

Example: See [Example"Performing a power measurement with a fixed filter"](#) on page 623.

Manual operation: See "[Use Frequency Of](#)" on page 377

:SENSe<ch>[:POWer]:STATus[:DEVice]?

Queries if a sensor is connected to the instrument.

Return values:

<Status> 1 | ON | 0 | OFF
*RST: 0

Example: :SENS1:STAT?
Response: 1
A sensor is connected.

Usage: Query only

Manual operation: See "[State](#)" on page 377

:SENSe<ch>[:POWer]:TYPE?

Queries the sensor type. The type is automatically detected.

Return values:

<Type> string

Example:

:SENS1:TYPE?

Queries the type of sensor.

Response: NRP-Z21

The R&S NRP-Z21 sensor is used.

Usage: Query only

Manual operation: See "[Sensor type and serial number](#)" on page 376

:SENSe<ch>[:POWer]:ZERO

Performs zeroing of the sensor.

Zeroing is required after warm-up, i.e. after connecting the sensor.

Note: Switch off or disconnect the RF power source from the sensor before zeroing.

We recommend that you zero in regular intervals (at least once a day), if:

- The temperature has varied more than about 5 °C.
- The sensor has been replaced.
- You want to measure very low power.

Example:

:SENS1:ZERO

Executes zeroing.

Usage: Event

Manual operation: See "[Zero](#)" on page 377

14.15 SCONfiguration subsystem

The SCONfiguration subsystem contains the commands for defining the system configuration setting, like stream mapping and used baseband configuration.

Required options

See "[Required options](#)" on page 254.

Suffix	Value range	Description
HSDigital<ch>	1 to 2	Dig. IQ HS x connectors

Example: Distributing the I/Q streams to the output connectors

The following example lists the commands necessary to fulfill this task.

```
// *****
// Map the I/Q streams to the output connectors.
// *****
SCONfiguration:OUTPut:MAPPING:RF1:STReam1:STATe ON
SCONfiguration:OUTPut:MAPPING:HSDigital1:CHANnel0:STReam1:STATe ON
```

Example: Connecting and configuring external instruments

The following example lists the commands necessary to fulfill this task.

```
// *****
// Scan interfaces and your network for connected instruments.
// *****
SCONfiguration:EXTErnal:DISPlay ALL
SCONfiguration:EXTErnal:REMOte:CLEan
SCONfiguration:EXTErnal:REMOte:SCAN
SCONfiguration:EXTErnal:REMOte:SCAN:STATe?
// Response: "0"
// The scanning procedure is finished.

// *****
// Query characteristics at the input and output interfaces.
// *****
SCONfiguration:EXTErnal::HSDigital1:DIRection?
// Response: "IN"
SCONfiguration:EXTErnal::HSDigital2:DIRection?
// Response: "OUT"
SCONfiguration:EXTErnal::HSDigital1:IQConnection:STATe?
// Response: "0"
SCONfiguration:EXTErnal::HSDigital2:IQConnection:STATe?
// Response: "1"

// *****
// Manage external instruments.
// *****
SCONfiguration:EXTErnal:REMOte:LIST?
// Response: "SMBV100B,SGS_2,SGT100A,SMBV_1"
// Add instruments to selection.
SCONfiguration:EXTErnal:REMOte:ADD "SGS_1","USB","100007"
SCONfiguration:EXTErnal:REMOte:ADD "SGT100A","LAN","10.112.11.125","1"
SCONfiguration:EXTErnal:REMOte:LIST?
SCONfiguration:EXTErnal:REMOte:REName "SGS_2","SGS (102030)"
SCONfiguration:EXTErnal:REMOte:LIST?
// Response: "SMBV100B,SGS (102030),SGT100A,SMBV_1"

// *****
// Detect external instruments and connect them to the R&S SMCV100B.
// *****
SCONfiguration:EXTErnal:DIGital:REMOte:DETEct?
// Response: "SMBV100B"
```

```

SCONfiguration:EXTErnal:HSDigital2:REMOte:ISElect?
// Response: "SGT100A","A"
SCONfiguration:EXTErnal:HSDigital2:REMOte:CONNect
// Alternatively, combine instrument select and connect.
SCONfiguration:EXTErnal:IQOutput:REMOte:ICONNect "SGS100A","A"
// Define an external instrument manually.
SCONfiguration:EXTErnal:HSDigital2:REMOte:ISElect "SGS_1","A"
SCONfiguration:EXTErnal:HSDigital2:REMOte:CONNect
SCONfiguration:EXTErnal:HSDigital2:RCONNECTION:STATe?
// Response: 1
SCONfiguration:EXTErnal:HSDigital2:INAME?
// Response: "SGS_1 [A]"

// *****
// Specify characteristics of the IQ output signal.
// *****
SCONfiguration:EXTErnal:HSDigital2:RF:COUPling OFF
SCONfiguration:EXTErnal:HSDigital2:RF:FREQuency 2143000000
SCONfiguration:EXTErnal:HSDigital2:RF:POWer \-20
SCONfiguration:EXTErnal:HSDigital2:RF:STATe ON

// *****
// Specify the initialization sequence with a user-defined initialization file.
// *****
MMEMOry:CDIREctory "/var/user/RcExtInstr"
SCONfiguration:EXTErnal:REMOte:INITialization:CATalog?
// Response: "init_seq_sgs"
SCONfiguration:EXTErnal:HSDigital2:REMOte:INITialization:FILE "init_seq_sgs.iec"
SCONfiguration:EXTErnal:ACONNect 1

*RST

SCONfiguration:EXTErnal:REMOte:PURGe
// Disabling remote control of the external instruments
SCONfiguration:EXTErnal:REMOte:DISConnect[:ALL]

```

Example: Configuring primary-secondary mode

```

// For the primary instrument:
SOURCE1:ROSCillator:SOURce INT
SCONfiguration:MULTIinstrument:MODE PRIMary
SCONfiguration:MULTIinstrument:STATe 1
SCONfiguration:APPLY

// For the secondary instrument:
SOURCE1:ROSCillator:SOURce EXT
SOURCE1:ROSCillator:EXTErnal:FREQuency 10MHZ
SCONfiguration:MULTIinstrument:MODE SECONdary
SCONfiguration:MULTIinstrument:STATe 1

```

- [Multi instrument configuration](#)..... 638
- [I/Q stream mapping](#).....639
- [External RF and I/Q instruments](#).....640

14.15.1 Multi instrument configuration

The following commands configure multi-instrument settings.

Commands:

:SCONfiguration:MULTIinstrument:MODE	638
:SCONfiguration:MULTIinstrument:STATE	638
:SCONfiguration:MULTIinstrument:TRIGger:SYNChronization?	638

:SCONfiguration:MULTIinstrument:MODE <MSMode>

Sets if the instrument works as a primary or as a secondary instrument.

Parameters:

<MSMode> PRIMARY | SECondary
 *RST: PRIMary

Example: See [Example"Configuring primary-secondary mode"](#)
 on page 637.

Manual operation: See ["Multi Instrument Trigger"](#) on page 393

:SCONfiguration:MULTIinstrument:STATE <TriggerState>

Activates the selected mode.

Parameters:

<TriggerState> 1 | ON | 0 | OFF
 *RST: 0

Example: See [Example"Configuring primary-secondary mode"](#)
 on page 637.

Manual operation: See ["State"](#) on page 392

:SCONfiguration:MULTIinstrument:TRIGger:SYNChronization?

Queries if synchronization is achieved.

Return values:

<SyncState> SYNC | NOSYnc
 *RST: NOSYnc

Example: See [Example"Configuring primary-secondary mode"](#)
 on page 637.

Usage: Query only

14.15.2 I/Q stream mapping

The following commands configure the I/Q stream mapper.

:SCONfiguration:OUTPut:MAPPING:RF:STReam<st>:STATe.....	639
:SCONfiguration:OUTPut:MAPPING:HSDigital:CHANnel<di>:STReam<st>:STATe.....	639
:SCONfiguration:OUTPut:MAPPING:STReam<st>:FOFFset.....	639
:SCONfiguration:OUTPut:MAPPING:STReam<st>:POFFset.....	639

```
:SCONfiguration:OUTPut:MAPPING:RF:STReam<st>:STATe <State>
:SCONfiguration:OUTPut:MAPPING:HSDigital:CHANnel<di>:STReam<st>:STATe
<State>
```

Maps the I/Q output streams to the output connectors.

Parameters:

```
<State>          1 | ON | 0 | OFF
*RST:           0
```

Manual operation: See ["Map Stream X to Connector"](#) on page 255

```
:SCONfiguration:OUTPut:MAPPING:STReam<st>:FOFFset <SmFreqOffset>
```

Sets an absolute frequency offset.

Parameters:

```
<SmFreqOffset>  float
Range:          depends on the installed options, e.g. -60E6 to
                +60E6 (base unit)
Increment:     0.01
*RST:          0
```

Example: See [Example "Distributing the I/Q streams to the output connectors"](#) on page 635.

```
:SCONfiguration:OUTPut:MAPPING:STReam<st>:POFFset <SmPhasOffset>
```

Sets the phase offset of the corresponding stream.

Parameters:

```
<SmPhasOffset>  float
Range:          -999.99 to 999.99
Increment:     0.01
*RST:          0
```

Example: See [Example "Distributing the I/Q streams to the output connectors"](#) on page 635.

14.15.3 External RF and I/Q instruments

:SCONfiguration:EXternal:DISPlay.....	640
:SCONfiguration:EXternal:ACONnect.....	640
:SCONfiguration:EXternal:REMOte:CONNect[:ALL].....	641
:SCONfiguration:EXternal:REMOte:DISConnect[:ALL].....	641
:SCONfiguration:EXternal:PBEHaviour.....	641
:SCONfiguration:EXternal:HSDigital:DIRection?.....	641
:SCONfiguration:EXternal:HSDigital<ch>:IQConnection:STATe?.....	641
:SCONfiguration:EXternal:HSDigital:RCONnection:STATe?.....	642
:SCONfiguration:EXternal:HSDigital<ch>:INAMe?.....	642
:SCONfiguration:EXternal:HSDigital:RF:COUPling.....	642
:SCONfiguration:EXternal:HSDigital:RF:FREQUency.....	643
:SCONfiguration:EXternal:HSDigital:RF:FREQUency:OFFSet.....	643
:SCONfiguration:EXternal:HSDigital:RF:POWer.....	643
:SCONfiguration:EXternal:HSDigital:RF:POWer:OFFSet.....	643
:SCONfiguration:EXternal:HSDigital:RF:STATe.....	644
:SCONfiguration:EXternal:REMOte:SCAN.....	644
:SCONfiguration:EXternal:REMOte:SCAN:STATe?.....	644
:SCONfiguration:EXternal:REMOte:LIST?.....	645
:SCONfiguration:EXternal:REMOte:ADD.....	645
:SCONfiguration:EXternal:REMOte:REName.....	646
:SCONfiguration:EXternal:HSDigital<ch>:REMOte:DETEct?.....	646
:SCONfiguration:EXternal:HSDigital:REMOte:ISELect.....	646
:SCONfiguration:EXternal:HSDigital:REMOte:CONNect.....	646
:SCONfiguration:EXternal:HSDigital<ch>:REMOte:ICONnect.....	647
:SCONfiguration:EXternal:HSDigital:REMOte:INFO?.....	647
:SCONfiguration:EXternal:HSDigital:REMOte:DISConnect.....	647
:SCONfiguration:EXternal:REMOte:INIInitialization:CATalog?.....	647
:SCONfiguration:EXternal:HSDigital:REMOte:INIInitialization:FILE.....	648
:SCONfiguration:EXternal:REMOte:PURGe.....	648
:SCONfiguration:EXternal:REMOte:CLEan.....	648
:SCONfiguration:EXternal:HSDigital<ch>:REMOte:SEND.....	648

:SCONfiguration:EXternal:DISPlay <DisplayMode>

Filters the displayed connectors upon the selected criteria.

Parameters:

<DisplayMode> ALL | MAPPed | INPut | OUTPut
 *RST: MAPPed

Example: See [Example "Connecting and configuring external instruments"](#) on page 636.

Manual operation: See ["Display"](#) on page 257

:SCONfiguration:EXternal:ACONnect <State>

Enables automatic detection and connection setup of connected external instruments.

Parameters:

<State> 1 | ON | 0 | OFF
 *RST: 0

Example: See [Example "Distributing the I/Q streams to the output connectors"](#) on page 635.

Manual operation: See ["Auto Connect"](#) on page 257

:SCONfiguration:EXTernal:REMote:CONNect[:ALL]

:SCONfiguration:EXTernal:REMote:DISConnect[:ALL]

Triggers the instrument to establish the connections to all configured external RF and I/Q instruments or to disconnect all existing connections.

Example: See [Example "Connecting and configuring external instruments"](#) on page 636.

Usage: Event

Manual operation: See ["Connect/Disconnect All Remote"](#) on page 257

:SCONfiguration:EXTernal:PBEHaviour <State>

If enabled, the connection to the external instruments is retained after preset (*RST) of the instrument.

Parameters:

<State> 1 | ON | 0 | OFF
 *RST: n.a. (factory preset: 0)

Manual operation: See ["Preset behavior: Keep connections to external instruments"](#) on page 258

:SCONfiguration:EXTernal:HSDigital:DIRection?

Queries the connector direction.

Return values:

<Direction> NONE | IN | OUT
 *RST: IN

Example: See [Example "Connecting and configuring external instruments"](#) on page 636.

Usage: Query only

Manual operation: See ["Direction"](#) on page 258

:SCONfiguration:EXTernal:HSDigital<ch>:IQConnection:STATe?

Queries the status of the I/Q connection of the digital interfaces.

Return values:

<IQConnState> 1 | ON | 0 | OFF

Example:

See [Example "Connecting and configuring external instruments"](#) on page 636.

Usage:

Query only

Manual operation:

See ["I/Q Connection"](#) on page 259

:SCONfiguration:EXTernal:HSDigital:RCONnection:STATe?**Return values:**

<State> 1 | ON | 0 | OFF

Usage:

Query only

:SCONfiguration:EXTernal:HSDigital<ch>:INAMe?

Queries the name of the connected external instrument.

Return values:

<InstrName> string

Returns the name of the connected external instrument.

<InstrumentName> (SerialNumber) <Path>

the instrument name, as retrieved via the DIG I/Q interface

<InstrumentName>[, <RfPath>] or <InstrumentName> (Serial-Number)

the instrument name, as defined in with the "Remote Config" settings or as defined by the command `:SCONfiguration:`

`EXTernal:REMOte:ADD`

Example:

See [Example "Connecting and configuring external instruments"](#) on page 636.

Usage:

Query only

Manual operation:

See ["Instrument Name"](#) on page 259

:SCONfiguration:EXTernal:HSDigital:RF:COUPling <RfCouplingState>

Enables/disables coupling all major RF setting (like the frequency, level and RF state) of the external instrument to the R&S SMCV100B.

Parameters:

<RfCouplingState> 1 | ON | 0 | OFF

*RST: 1

Example:

See [Example "Connecting and configuring external instruments"](#) on page 636.

Manual operation:

See ["RF Couple"](#) on page 260

:SCONfiguration:EXTernal:HSDigital:RF:FREQUENCY <Frequency>

In uncoupled mode, sets the RF frequency of the external instrument.

Parameters:

<Frequency> float
Range: 100E3 to 3E9
Increment: 0.01
*RST: 1E9

Example: See [Example"Connecting and configuring external instruments"](#) on page 636.

Manual operation: See "[\(Delta\) RF Frequency/ RF Level](#)" on page 260

:SCONfiguration:EXTernal:HSDigital:RF:FREQUENCY:OFFSet <FreqOffset>

In coupled mode, offsets the RF frequency of the external instrument with the selected delta value.

Parameters:

<FreqOffset> float
Range: -3E9 to 3E9
Increment: 0.01
*RST: 0

Example: See [Example"Connecting and configuring external instruments"](#) on page 636.

Manual operation: See "[\(Delta\) RF Frequency/ RF Level](#)" on page 260

:SCONfiguration:EXTernal:HSDigital:RF:POWER <Power>

In uncoupled mode, sets the RF level of the external instrument.

Parameters:

<Power> float
Range: -130 to 20
Increment: 0.01
*RST: -30

Example: See [Example"Connecting and configuring external instruments"](#) on page 636.

Manual operation: See "[\(Delta\) RF Frequency/ RF Level](#)" on page 260

:SCONfiguration:EXTernal:HSDigital:RF:POWER:OFFSet <PowerOffset>

In coupled mode, offsets the RF level of the external instrument with the selected delta value.

Parameters:

<PowerOffset> float
 Range: -100 to 100
 Increment: 0.01
 *RST: 0

Example: See [Example"Connecting and configuring external instruments"](#) on page 636.

Manual operation: See "[\(Delta\) RF Frequency/ RF Level](#)" on page 260

:SCONfiguration:EXTernal:HSDigital:RF:STATe <RemConnState>

Queries/sets the RF output state of the connected external instrument.

Parameters:

<RemConnState> 1 | ON | 0 | OFF

Example: See [Example"Connecting and configuring external instruments"](#) on page 636.

Manual operation: See "[RF State](#)" on page 260

:SCONfiguration:EXTernal:REMote:SCAN

Scans the network for connected instruments.

Example: See [Example"Connecting and configuring external instruments"](#) on page 636.

Usage: Event

Manual operation: See "[Detect/Scan](#)" on page 262

:SCONfiguration:EXTernal:REMote:SCAN:STATe?

Queries if scanning is performed or not.

To start the scanning process, use the command `:SCONfiguration:EXTernal:REMote:SCAN` on page 644.

Return values:

<ScanState> 1 | ON | 0 | OFF
1
 Scanning process running
0
 Not scanning

Example: See [Example"Connecting and configuring external instruments"](#) on page 636.

Usage: Query only

Manual operation: See "[Detect/Scan](#)" on page 262

:SCONfiguration:EXTernal:REMOte:LIST?

Lists all available instruments, found by the `:SCONfiguration:EXTernal:REMOte:SCAN` command.

Return values:

<InstrNames> String
String with symbolic names and/or alias names

Example: See [Example "Connecting and configuring external instruments"](#) on page 636.

Usage: Query only

Manual operation: See ["External Instrument"](#) on page 262

:SCONfiguration:EXTernal:REMOte:ADD <InstrName>, <HwChan>, <TcpIporUsbAddr>[, <RfPathNumber>]

Adds manually an external instrument to the list of available instruments.

Parameters:

<HwChan> String
Hardware channel (USB or LAN) used by the remote channel to the external instrument
Range: "LAN" to "USB"
*RST: "LAN"

<TcpIporUsbAddr> String
IP address or hostname of the connected external instrument

<RfPathNumber> String
Determines the number of RF paths the external instrument is equipped with
Range: "1" to "2"
*RST: "1"

Setting parameters:

<InstrName> String
Alias name of the instrument

Example: See [Example "Connecting and configuring external instruments"](#) on page 636.

Usage: Setting only

Manual operation: See ["External Instrument"](#) on page 262
See ["Set Symbolic Name"](#) on page 263
See ["Remote Channel"](#) on page 263
See ["Hostname or IP Address"](#) on page 263
See ["Device ID"](#) on page 263
See ["RF Path"](#) on page 263

:SCONfiguration:EXTernal:REMote:REName

Changes the symbolic name of the instrument.

Example: See [Example "Connecting and configuring external instruments"](#) on page 636.

Usage: Setting only

:SCONfiguration:EXTernal:HSDigital<ch>:REMote:DETECT?

Searches for external instruments connected to the particular digital interfaces.

Return values:

<DetectedInstr> string

If the detection fails, the query returns "None".

Example: See [Example "Connecting and configuring external instruments"](#) on page 636.

Usage: Query only

Manual operation: See ["Detect/Scan"](#) on page 262

:SCONfiguration:EXTernal:HSDigital:REMote:ISElect <InstrName>[, <RfPath>]

Select an external instrument for the selected connector.

Parameters:

<InstrName> String

Instrument alias name, as retrieved with the command `:SCONfiguration:EXTernal:REMote:LIST?` or defined with the command `:SCONfiguration:EXTernal:REMote:ADD`.

<RfPath> String

Determines the used RF output of the external instrument.

Example: See [Example "Connecting and configuring external instruments"](#) on page 636.

Manual operation: See ["External Instrument"](#) on page 262
See ["Apply"](#) on page 264
See ["Apply and Connect"](#) on page 264

:SCONfiguration:EXTernal:HSDigital:REMote:CONNECT

Usage: Event

Manual operation: See ["Apply and Connect"](#) on page 264

:SCONfiguration:EXTernal:HSDigital<ch>:REMote:ICONnect <InstrName>, <RfPath>

Selects an external instrument for the selected connector and triggers connection.

Parameters:

<InstrName> string
Instrument alias name, as retrieved with the command `:SCONfiguration:EXTernal:REMote:LIST?` or defined with the command `:SCONfiguration:EXTernal:REMote:ADD`.

<RfPath> string
Determines the used RF output of the external instrument. For a one-path instrument, the output path is fixed.

Example: See [Example "Connecting and configuring external instruments"](#) on page 636.

Usage: Setting only

:SCONfiguration:EXTernal:HSDigital:REMote:INFO?

Queries information on the external instrument.

Example: See [Example "Connecting and configuring external instruments"](#) on page 636.

Usage: Query only

Manual operation: See ["Remote Connection Status"](#) on page 259
See ["Instrument Name"](#) on page 259
See ["Set Symbolic Name"](#) on page 263
See ["Remote Channel"](#) on page 263
See ["Hostname or IP Address"](#) on page 263
See ["RF Path"](#) on page 263

:SCONfiguration:EXTernal:HSDigital:REMote:DISConnect

Disconnects the selected remote connection. To disconnect all remote connections at once, use the command `:SCONfiguration:EXTernal:REMote:DISConnect[:ALL]`.

Example: See [Example "Connecting and configuring external instruments"](#) on page 636.

Usage: Event

Manual operation: See ["Remote Connection Status"](#) on page 259

:SCONfiguration:EXTernal:REMote:INITialization:CATalog?

Queries the names of the existing initialization files in the default directory.

Per default, the instrument saves user-defined files in the `/var/user/` directory. Use the command `:MME:CDIRectory` to change the default directory to the currently used one.

Only files with extension `*.iec` are listed.

Example: See [Example"Connecting and configuring external instruments"](#) on page 636.

Usage: Query only

Manual operation: See ["Initialization Sequence"](#) on page 263

:SCONfiguration:EXTernal:HSDigital:REMOte:INITialization:FILE <Filename>

Queries the currently selected initialization file.

Parameters:

<Filename> string
filename with file extension (`*.iec`)

Example: See [Example"Connecting and configuring external instruments"](#) on page 636.

Manual operation: See ["Initialization Sequence"](#) on page 263

:SCONfiguration:EXTernal:REMOte:PURGe

Removes unused instruments from the pool of external instruments.

Example: See [Example"Connecting and configuring external instruments"](#) on page 636.

Usage: Event

Manual operation: See ["Clean Unused/Clean All"](#) on page 262

:SCONfiguration:EXTernal:REMOte:CLEan

Removes all instruments from the pool of external instruments.

Example: See [Example"Connecting and configuring external instruments"](#) on page 636.

Usage: Event

Manual operation: See ["Clean Unused/Clean All"](#) on page 262

:SCONfiguration:EXTernal:HSDigital<ch>:REMOte:SEND <SendScpiCommand>

Allows you to send SCPI commands to the RF instruments connected to the R&S SMCV100B.

Setting parameters:

<SendScpiCommand>"<SCPI syntax>"

String containing a SCPI command (query or setting)

Example:

See [Example "Connecting and configuring external instruments"](#) on page 636.

Usage:

Setting only

Manual operation:

See ["Command, Send Command"](#) on page 265

14.16 SOURce subsystem

The SOURce subsystem contains the commands for configuring signals.

Common suffixes

The following common suffixes are used in remote commands:

Suffix	Value range	Description
SOURce<hw>	[1]	SOURce[1] = RF output (optional keyword)

• Connector settings	649
• SOURce:BBIN subsystem	653
• SOURce:BB subsystem	660
• SOURce:CORRection subsystem	751
• SOURce:FREQUency subsystem	759
• SOURce:INPut subsystem	765
• SOURce:IQ subsystem	765
• SOURce:IQ:OUTPut subsystem	766
• SOURce:LIST subsystem	771
• SOURce:PHASe subsystem	784
• SOURce:POWEr subsystem	785
• SOURce:ROSCillator subsystem	796
• SOURce:SWEep subsystem	800

14.16.1 Connector settings

This section summarizes the commands of the OUTPut and INPut subsystems, necessary to configure the connectors settings. Listed are the commands for configuring the output signals and the inputs for trigger, data, and control signals.

The . . . :USER<ch>: . . . commands determine the global trigger threshold and input impedance values, that affect all trigger and control signal inputs. The connector settings concern to all digital modulations, the generation of waveforms or multi carrier signals, and all digital standards.

Refer to [Chapter 14.16.6, "SOURce:INPut subsystem"](#), on page 765 for description of the commands for configuring the inputs for external modulation signals.

Required options

See also [Chapter 12.2, "Configuring global connectors"](#), on page 449.

Example: Global connectors settings configuration

```
SOURce1:INPut:USER1:DIRection?
// Response: "UNUS"
SOURce1:INPut:USER1:SIGnal?
// Response: "NONE"
// No direction is specified, no input signal is expected.

SOURce1:INPut:USER1:DIRection INP
SOURce1:INPut:USER1:SIGnal TRIG1
SOURce1:INPut:USER:TRIGger:LEVel 1.5
SOURce1:INPut:USER:TRIGger:IMPedance G1K

// The signal threshold at USER 1-2 is 1.5 V.
// This applies to all input signal, i.e. TRIG1, TS, ETI, SDIF and PPS.

SOURce1:INPut:USER2:DIRection OUTP
OUTPut:USER2:SIGnal?
// Response: "MARKA1"
// The ouput signal is the baseband marker 1 signal.
:OUTPut:USER2:DIRection
```

[:SOURce]:INPut:USER<ch>:DIRection	650
:OUTPut:USER<ch>:DIRection	650
[:SOURce]:INPut:USER<ch>:SIGnal	651
:OUTPut:USER<ch>:SIGnal	651
[:SOURce]:INPut:USER:CLOCK:LEVel	652
[:SOURce]:INPut:USER:TRIGger:LEVel	652
[:SOURce]:INPut:USER:CLOCK:IMPedance	652
[:SOURce]:INPut:USER:TRIGger:IMPedance	652
[:SOURce]:INPut:USER:CLOCK:SLOPe	652
[:SOURce]:INPut:USER:TRIGger:SLOPe	653

[\[:SOURce\]:INPut:USER<ch>:DIRection](#) <Direction>

[:OUTPut:USER<ch>:DIRection](#) <Direction>

Sets the direction of the signal at the connector that can be input or an output.

Suffix:

USER<ch> 1 to 2

Parameters:

<Direction> INPut | OUTPut | UNUSed
INPut|OUTPut
 Input signal or output signal

UNUSed

No signal present at the connector.

Example: See [Example "Global connectors settings configuration"](#) on page 650.

Manual operation: See ["Direction"](#) on page 456

[:SOURce] : INPut : USER <ch> : SIGNal <Signal>

Determines the control signal that is input at the selected connector.

To define the connector direction, use the command `[:SOURce] : INPut : USER <ch> : DIRection`.

Suffix:

USER<ch> 1 to 2

Parameters:

<Signal> TRIG1 | NSEGM1 | INST | TS | ETI | SDIF | PPS

TRIG1

Global trigger input signal available at "User 1/2" connector

NSEGM1

Input global next segment for triggering of multi-segment waveform files. The signal is available at "User 1/2" connector.

INST

Internal instrument trigger signal available at "User 1/2" connector.

TS

Transport stream (TS) input signal available at "User 1" connector only

ETI

Ensemble transport interface input signal compatible with DAB/T-DMB ETSI standard. The signal is available at "User 1" connector only.

SDIF

S/PDIF input signal available at "User 1" connector only

PPS

1PPS (one pulse per second) input signal available at "User 2" connector only

Example: See [Example "Global connectors settings configuration"](#) on page 650.

Manual operation: See ["Signal"](#) on page 456

:OUTPut : USER <ch> : SIGNal <Signal>

Sets the control signal that is output at the selected connector.

To define the connector direction, use the command `:OUTPut:USER<ch>:DIRection`.

Parameters:

<Signal> MARKA1 | NONE
*RST: MARKA1

Example: See [Example "Global connectors settings configuration"](#) on page 650.

Manual operation: See ["Signal"](#) on page 456

`[:SOURce]:INPut:USER:CLOCK:LEVel <Level>`

`[:SOURce]:INPut:USER:TRIGger:LEVel <Level>`

Sets the threshold for any input signal at the User1-2 connectors.

Parameters:

<Level> float
Range: 0.1 to 2
Increment: 0.1
*RST: 1

Example: See [Example "Global connectors settings configuration"](#) on page 650.

Manual operation: See ["Threshold User1-2 Input"](#) on page 457

`[:SOURce]:INPut:USER:CLOCK:IMPedance <Impedance>`

`[:SOURce]:INPut:USER:TRIGger:IMPedance <Impedance>`

Selects the input impedance for the external trigger inputs.

Parameters:

<Impedance> G50 | G1K
*RST: G1K

Example: See [Example "Global connectors settings configuration"](#) on page 650.

Manual operation: See ["Impedance Clock/Trigger Input"](#) on page 457

`[:SOURce]:INPut:USER:CLOCK:SLOPe <Slope>`

Sets the polarity of the active slope of an externally applied clock signal.

Parameters:

<Slope> NEGative | POSitive
*RST: POSitive

Example: See [Example "Global connectors settings configuration"](#) on page 650.

Manual operation: See ["Clock Input Slope"](#) on page 457

[:SOURce]:INPut:USER:TRIGger:SLOPe <Slope>

Sets the polarity of the active slope of an applied instrument trigger.

Parameters:

<Slope> NEGative | POSitive
*RST: POSitive

Example: See [Example "Global connectors settings configuration"](#) on page 650.

Manual operation: See ["Trigger Input Slope"](#) on page 457

14.16.2 SOURce:BBIN subsystem

The SOURce:BBIN subsystem contains the commands for setting the external digital baseband signal.

Suffix	Value range	Description
CHANnel<ch0>	0 to 7	Channel number Up to 8 channels per Dig. IQ HS x interface and max. 8 channels for both interfaces.

Required options

See ["Required options"](#) on page 267.

See also [Chapter 5.1, "Overview of the input and output signals and interfaces"](#), on page 249.

Example: Applying an external digital baseband signal (Dig. IQ HS x)

An external digital signal must be applied at the Dig. IQ HS x connectors.

```
SOURce1:BBIN:STATe 1

SOURce1:BBIN:DIGital:INTerface HSD
SOURce1:BBIN:SRATe:SOURce? HSD
SOURce1:BBIN:CHANnel0:NAME?
SOURce1:BBIN:CHANnel0:SRATe?
// 100000000
SOURce1:BBIN:CHANnel0:POWer:CFACTOR 0.5
SOURce1:BBIN:CHANnel0:POWer:PEAK 3
SOURce1:BBIN:CHANnel0:POWer:RMS?
// 2.5
SOURce1:BBIN:CHANnel0:BB:STATe 1
SOURce1:BBIN:SRATe:SUM?
// 100000000
SOURce1:BBIN:SRATe:MAX?
// 1250000000
```

```
// Set the sample rate per channel.
SOURce1:BBIN:SRate:SOURce USER
SOURce1:BBIN:CHANnel10:SRate 500000000
SOURce1:BBIN:SRate:SUM?
// 500000000
```

```
SOURce1:BBIN:MPERiod 2
SOURce1:BBIN:ALEVel:EXECute
```

[SOURce<hw>]:BBIN:STATe.....	654
[SOURce<hw>]:BBIN:DIGital:INTErface.....	654
[SOURce<hw>]:BBIN:CDEVIce?.....	655
[SOURce<hw>]:BBIN:CHANnel<ch0>:BB:STATe.....	655
[SOURce<hw>]:BBIN:CHANnel<ch0>:NAME.....	655
[SOURce<hw>]:BBIN:CHANnel<ch0>:POWEr:CFACtor.....	656
[SOURce<hw>]:BBIN:CHANnel<ch0>:POWEr:PEAK.....	656
[SOURce<hw>]:BBIN:CHANnel<ch0>:POWEr:RMS.....	656
[SOURce<hw>]:BBIN:CHANnel<ch0>:SRATE.....	656
[SOURce<hw>]:BBIN:MODE.....	657
[SOURce<hw>]:BBIN:SRATE:SOURce.....	657
[SOURce<hw>]:BBIN:SRATE:SUM?.....	657
[SOURce<hw>]:BBIN:SRATE:MAX?.....	658
[SOURce<hw>]:BBIN:SRATE[:ACTual]?.....	658
[SOURce<hw>]:BBIN:DIGital:ASETting:STATe.....	658
[SOURce<hw>]:BBIN:MPERiod.....	658
[SOURce<hw>]:BBIN:ALEVel:EXECute.....	659
[SOURce<hw>]:BBIN:POWEr:CFACtor.....	659
[SOURce<hw>]:BBIN:POWEr:PEAK.....	659
[SOURce<hw>]:BBIN:POWEr:RMS?.....	660

[SOURce<hw>]:BBIN:STATe <State>

Enables feeding of an external digital signal into the signal path.

Parameters:

<State> 1 | ON | 0 | OFF
 *RST: 0

Example: See [Example "Applying an external digital baseband signal \(Dig. IQ HS x\)"](#) on page 653.

Manual operation: See ["State"](#) on page 269

[SOURce<hw>]:BBIN:DIGital:INTErface <BBinDigInterfac>

Selects the input connector at that the signal is fed.

Parameters:

<BBinDigInterfac> DIGital | HSDin | HSDin

HSDin

Dig. IQ HS 1

*RST: HSDin

Example:

See [Example "Applying an external digital baseband signal \(Dig. IQ HS x\)"](#) on page 653.

Manual operation: See ["Interface"](#) on page 269

[[:SOURce<hw>]:BBIN:CDEvice?

Indicates the ID of an externally connected Rohde & Schwarz Instrument or Rohde & Schwarz device.

Return values:

<CDevice> string
 "None" - no device is connected.

Example:

SOURce:BBIN:CDEvice?
 Queries the connected device ID.

Usage:

Query only

Manual operation: See ["Connected Device"](#) on page 270

[[:SOURce<hw>]:BBIN:CHANnel<ch0>:BB:STATE <BbinIqHsChanSta>

Activates the channel.

Parameters:

<BbinIqHsChanSta> 1 | ON | 0 | OFF

*RST: 0

Example:

See [Example "Applying an external digital baseband signal \(Dig. IQ HS x\)"](#) on page 653.

Manual operation: See ["BB"](#) on page 271

[[:SOURce<hw>]:BBIN:CHANnel<ch0>:NAME <BbinIqHsChanNam>

Queries the channel name.

Parameters:

<BbinIqHsChanNam> string

Example:

See [Example "Applying an external digital baseband signal \(Dig. IQ HS x\)"](#) on page 653.

Manual operation: See ["Name"](#) on page 271

```
[ :SOURce<hw>]:BBIN:CHANnel<ch0>:POWER:CFACTor <BbinIqHsChCrFac>
```

Sets the crest factor of the individual channels.

Parameters:

```
<BbinIqHsChCrFac> float
                    Range:    0 to 30
                    Increment: 0.01
                    *RST:     0
```

Example: See [Example "Applying an external digital baseband signal \(Dig. IQ HS x\)"](#) on page 653.

Manual operation: See ["Crest Factor"](#) on page 271

```
[ :SOURce<hw>]:BBIN:CHANnel<ch0>:POWER:PEAK <BbinHsChPoPeak>
```

Sets the peak level per channel.

Parameters:

```
<BbinHsChPoPeak> float
                    Range:    -60 to 3.02
                    Increment: 0.01
                    *RST:     0
```

Example: See [Example "Applying an external digital baseband signal \(Dig. IQ HS x\)"](#) on page 653.

Manual operation: See ["Peak Level"](#) on page 271

```
[ :SOURce<hw>]:BBIN:CHANnel<ch0>:POWER:RMS <BbinIqHsChPoRms>
```

Queries the estimated RMS level.

Parameters:

```
<BbinIqHsChPoRms> float
                    Range:    -100 to 10
                    Increment: 0.01
                    *RST:     0
```

Example: See [Example "Applying an external digital baseband signal \(Dig. IQ HS x\)"](#) on page 653.

Manual operation: See ["Level"](#) on page 271

```
[ :SOURce<hw>]:BBIN:CHANnel<ch0>:SRATe <BbinIqHsChSaRat>
```

Sets the sample rate per channel.

Parameters:

<BbinIqHsChSaRat> float
 Range: 400 to 250E6 ("System Config > Mode = Advanced")/1250E6 ("System Config > Mode = Standard")
 Increment: 0.001
 *RST: 100E6

Example: See [Example"Applying an external digital baseband signal \(Dig. IQ HS x\)"](#) on page 653.

Manual operation: See ["Sample Rate"](#) on page 271

[:SOURce<hw>]:BBIN:MODE <Mode>

Defines that a digital external signal is applied.

Parameters:

<Mode> DIGital
 *RST: DIGital

Example: See [Example"Applying an external digital baseband signal \(Dig. IQ HS x\)"](#) on page 653.

[:SOURce<hw>]:BBIN:SRATe:SOURce <Source>

Queries the digital interface used to estimate the sample rate.

Parameters:

<Source> HSDin
HSDin
 Queried for [:SOURce<hw>]:BBIN:DIGital:INTerface HSDin.
 *RST: HSDin

Example: See [Example"Applying an external digital baseband signal \(Dig. IQ HS x\)"](#) on page 653.

Manual operation: See ["Sample Rate Source"](#) on page 269

[:SOURce<hw>]:BBIN:SRATe:SUM?

Queries the sum of the sample rates of all active channels.

Return values:

<DigIqHsOutSRSum> integer
 Range: 0 to depends on settings
 *RST: 0

Example: See [Example"Applying an external digital baseband signal \(Dig. IQ HS x\)"](#) on page 653.

Usage: Query only
Options: R&S SMCVB-K521/-K522/-K523
Manual operation: See ["Aggregated Link Sample Rate"](#) on page 272

[:SOURce<hw>]:BBIN:SRATe:MAX?

Queries the maximum sample rate.

Return values:

<DigIqHsOutSRMax> integer

Range: 400 to 600E6
 *RST: 600E6

Example: See [Example"Applying an external digital baseband signal \(Dig. IQ HS x\)"](#) on page 653.

Usage: Query only
Manual operation: See ["Aggregated Link Sample Rate"](#) on page 272

[:SOURce<hw>]:BBIN:SRATe[:ACTual]?

Queries the sample rate of the external digital baseband signal.

Return values:

<Actual> float
 Range: 400 to 100E6
 Increment: 0.001
 *RST: 100E6

Usage: Query only

[:SOURce<hw>]:BBIN:DIGital:ASETting:STATe <State>

Activates automatic adjustment of the baseband input signal.

Parameters:

<State> 1 | ON | 0 | OFF
 *RST: 1

Example: See [Example"Applying an external digital baseband signal \(Dig. IQ HS x\)"](#) on page 653.

Manual operation: See ["DIG IQ Auto Setting"](#) on page 272

[:SOURce<hw>]:BBIN:MPERiod <MPeriod>

Sets the recording duration for measuring the baseband input signal by executed [\[:SOURce<hw>\]:BBIN:ALEVel:EXECute](#).

Parameters:

<MPeriod> integer
 Range: 1 to 32
 *RST: 2
 Default unit: s

Example: See [Example"Applying an external digital baseband signal \(Dig. IQ HS x\)"](#) on page 653.

Manual operation: See ["Measurement Period"](#) on page 272

[:SOURce<hw>]:BBIN:ALEVel:EXECute

Starts measuring the input signal. The measurement estimates the crest factor, peak and RMS level.

Example: See [Example"Applying an external digital baseband signal \(Dig. IQ HS x\)"](#) on page 653.

Usage: Event

Manual operation: See ["Auto Level Set"](#) on page 272

[:SOURce<hw>]:BBIN:POWER:CFACTOR <CFactor>

Sets the crest factor of the external baseband signal.

Parameters:

<CFactor> float
 Range: 0 to 30
 Increment: 0.01
 *RST: 0
 Default unit: dB

Example: See [Example"Applying an external digital baseband signal \(Dig. IQ HS x\)"](#) on page 653.

[:SOURce<hw>]:BBIN:POWER:PEAK <Peak>

Peak level of the external baseband signal relative to full scale of 0.5 V (in terms of dB full scale).

Parameters:

<Peak> float
 Range: -60 to 3.02
 Increment: 0.01
 *RST: 0
 Default unit: dBfs

Example: See [Example"Applying an external digital baseband signal \(Dig. IQ HS x\)"](#) on page 653.

[[:SOURce<hw>]:BBIN:POWer:RMS?

Queries the RMS level of the external digital baseband signal.

Return values:

<Rms> float
 Range: -100 to 10
 Increment: 0.01
 *RST: 0

Example: See [Example "Applying an external digital baseband signal \(Dig. IQ HS x\)"](#) on page 653.

Usage: Query only

14.16.3 SOURce:BB subsystem

This subsystem contains all commands for digital signal generation. It is divided into several subsystems which are described separately.

- [SOURce:BB subsystem general commands](#)..... 660
- [SOURce:BB:DM subsystem](#)..... 663
- [SOURce:BB:ARbitrary subsystem](#)..... 687
- [SOURce:BB:General subsystem](#)..... 730
- [SOURce:AWGN subsystem](#)..... 738
- [SOURce:BB:IMPairment subsystem](#)..... 746
- [SOURce:BB:GRAPhics subsystem](#)..... 748
- [SOURce:BB:PROGress subsystem general commands](#)..... 751

14.16.3.1 SOURce:BB subsystem general commands

The following section describes the commands for setting the frequency shift and the phase offset for the signal at the output of the "Baseband" and "BB Input" blocks.

The following commands are available:

[:SOURce<hw>]:BBIN:FOFFset	660
[:SOURce<hw>]:BB:FOFFset	660
[:SOURce<hw>]:BBIN:POFFset	661
[:SOURce<hw>]:BB:POFFset	661
[:SOURce<hw>]:BB:ROUte	661
[:SOURce<hw>]:BBIN:ROUte	661
[:SOURce<hw>]:BB:POWer:PEAK?	662
[:SOURce<hw>]:BB:CFACTOR?	662
[:SOURce<hw>]:BB:POWer:RMS?	662

[[:SOURce<hw>]:BBIN:FOFFset <FOffset>**[[:SOURce<hw>]:BB:FOFFset <FOffset>**

Sets a frequency offset for the internal/external baseband signal. The offset affects the generated baseband signal.

Parameters:

<FOffset> float
 Range: depends on the installed options
 Increment: 0.01
 *RST: 0
 Default unit: Hz

Example:

SOURce1:BB:FOFFset 2MHZ

Manual operation: See "[Frequency Offset](#)" on page 247

[:SOURce<hw>]:BBIN:POFFset <POffset>

Sets the relative phase offset for the external baseband signal.

Parameters:

<POffset> float
 Range: -999.99 to 999.99
 Increment: 0.01
 *RST: 0
 Default unit: DEG

Example:

SOURce1:BBIN:POFFset 0.5

Manual operation: See "[Phase Offset](#)" on page 248

[:SOURce<hw>]:BB:POFFset <POffset>

Sets the relative phase offset for the selected baseband signal.

Parameters:

<POffset> float
 Range: 0 to 359.9
 Increment: 0.01
 *RST: 0
 Default unit: DEG

Example:

SOURce1:BB:POFFset 0.5DEG

Manual operation: See "[Phase Offset](#)" on page 248

[:SOURce<hw>]:BB:ROUte <Route>

[:SOURce<hw>]:BBIN:ROUte <Route>

Selects the signal route for the internal/external baseband signal.

Parameters:

<Route> A

Example:

SOURce1:BBIN:ROUte A

[[:SOURce<hw>]:BB:POWer:PEAK?

Queries the peak level of the baseband signal relative to full scale of 0.5 V (in terms of dB full scale).

Return values:

<Peak> float
Range: -145 to 30
Increment: 0.01
*RST: 0
Default unit: dBfs

Example:

BB:POW:PEAK
Queries the peak level of the baseband signal.

Usage: Query only

[[:SOURce<hw>]:BB:CFACTOR?

Queries the crest factor of the baseband signal.

Return values:

<CFactor> float
Range: 0 to 100
Increment: 0.01
*RST: 0
Default unit: dB

Example:

SOURce1:BB:CFACTOR?
Queries the crest factor of the baseband signal.

Usage: Query only

[[:SOURce<hw>]:BB:POWer:RMS?

Queries the RMS level of the baseband signal relative to full scale of 0.5V (in terms of dB full scale).

Return values:

<Rms> float
Range: -145 to 30
Increment: 0.01
*RST: 0
Default unit: dBfs

Example:

BB:POW:RMS?
Queries the rms level of the baseband signal.

Usage: Query only

14.16.3.2 SOURce:BB:DM subsystem

This section lists the commands of the SOURce:BB:DM subsystem. The commands are divided into sections, where the last one describes how to use lists for digital modulation in remote control, and all other sections describe the configuration of the digital modulation.

Required options

See [Chapter 4.5.1, "Required options"](#), on page 106

The commands are grouped in the following sections:

• Programming examples	663
• General commands	665
• Save/recall settings	667
• Filter settings	669
• Modulation and coding settings	671
• Power ramping	674
• Trigger settings	676
• Marker settings	679
• Clock settings	681
• Handling list files	682

Programming examples

Example: Performing general tasks

This example shows how to enable custom digital modulation with predefined settings as basis for further customization (e.g. adjusting the data source); intermediate results and configuration are stored with the save/recall function.

```
// *****
// Reset instrument first
// *****
*RST; *CLS

SOURce:BB:DM:PRESet
SOURce:BB:DM:STANDARD W3GPP
SOURce:BB:DM:SRATE?
// 3840000
SOURce:BB:DM:CODING?
// WCDMA
SOURce:BB:DM:FORMat?
// QPSK45
SOURce:BB:DM:STATE ON
SOURce:BB:DM:SETTing:STORe "/var/user/ digMod/CustDM3GPP"

// *****
// Recall settings
// *****
MME:CDIR "/var/user/digMod"
```

```

SOURce:BB:DM:SETTING:CATalog?
// CusDigMod, cdm3gpp, CustDM3GPP
SOURce:BB:DM:SETTING:DELeTe "cdm3gpp"
SOURce:BB:DM:SETTING:LOAD "CusDigMod"

// *****
// Change the data source
// *****
SOURce:BB:DM:SOURce?
// PRBS
SOURce:BB:DM:PRBS:LENGth?
// 9
SOURce:BB:DM:SOURce DLIST
// Set the default directory and query the existing data lists
MME:CDIR "/var/user/DLists"
SOURce:BB:DM:DLISt:CATalog?
// "DList1","DList2"
// delete a list and create a new data list
SOURce:BB:DM:DLISt:DELeTe "DList1"
SOURce:BB:DM:DLISt:SELeCt "DList2"
// copy the content of an existing data list to the new data list
SOURce:BB:DM:DLISt:COpy "DList3"
// query the content of the new data list and modify it (append data to it)
FORM ASCI
SOURce:BB:DM:DLISt:DATA? 2048,1024
// 1,1,0,0,0, ...
SOURce:BB:DM:DLISt:DATA:APPend 1,1,1,0,0,0,1,1,0,1...
SOURce:BB:DM:DLISt:SELeCt "DList3"
// query the free memory and number of bits to be utilized
SOURce:BB:DM:DLISt:FREE?
SOURce:BB:DM:DLISt:POINts?

```

Example: Adjusting clock, marker and trigger settings

The following example lists the provided commands

```

// *****
// Clock settings
// *****
SOURce:BB:DM:CLOCK:SOURce INTernal

// *****
// Configure and enable standard marker signals
// *****
SOURce:BB:DM:TRIGger:OUTPut2:MODE PULSe
SOURce:BB:DM:TRIGger:OUTPut2:PULSe:DIVider 5
SOURce:BB:DM:TRIGger:OUTPut2:PULSe:FREQuency?
SOURce:BB:DM:TRIGger:OUTPut3:MODE PATtern
SOURce:BB:DM:TRIGger:OUTPut3:PATtern #HE0F52,20
SOURce:BB:DM:TRIGger:OUTPut1:MODE RATIo
SOURce:BB:DM:TRIGger:OUTPut1:ONTime 40

```



```

SOURce:BB:DM:TRIGger:OUTPut1:OFFTime 20

SOURce:BB:DM:TRIGger:OUTPut2:DELay 16

// *****
// Configure and enable signal generation
// *****
SOURce:BB:DM:TRIGger:SEQuence SINGLE
SOURce:BB:DM:TRIGger:SLENgth 200
// the first 200 samples will be output after the next trigger event
SOURce:BB:DM:TRIGger:SEQuence ARETrigger
SOURce:BB:DM:TRIGger:SOURce EGT1
// external trigger signal must be provided at the connector
// configured for the external global trigger 1 signal
SOURce:BB:DM:TRIGger:EXTernal:SYNChronize:OUTPut ON
SOURce:BB:DM:TRIGger:EXTernal:DELay 200
SOURce:BB:DM:TRIGger:EXTernal:INHibit 100

// with internal trigger source
SOURce:BB:DM:TRIGger:SEQuence AAUTO
SOURce:BB:DM:TRIGger:SOURce INTernal
SOURce:BB:DM:STAT ON
SOURce:BB:DM:TRIGger:EXEC

```

Example: Enable power ramping

The following example lists the provided commands

```

SOURce:BB:DM:PRAMP:SOURce INTernal
SOURce:BB:DM:PRAMP:SHAP COS
SOURce:BB:DM:PRAMP:TIME 5
SOURce:BB:DM:PRAMP:RDELay 0
SOURce:BB:DM:PRAMP:FDELay -1
SOURce:BB:DM:PRAMP:ATTenuation 10
SOURce:BB:DM:PRAMP:BBONLY:STATe ON
SOURce:BB:DM:PRAMP:STATe ON

```

General commands

[SOURce<hw>]:BB:DM:STATe <State>

Enables/disables digital modulation. Switching on digital modulation turns off all the other digital standards in the same signal path.

Parameters:

<State> 1 | ON | 0 | OFF
 *RST: 0

Example: See [Example "Performing general tasks"](#) on page 663

Manual operation: See ["State"](#) on page 108

[[:SOURce<hw>]:BB:DM:PRESet

Sets the default settings for digital modulation (*RST values specified for the commands).

Not affected is the state set with the command `SOURce<hw>:BB:DM:STATe`

Example: See [Example "Performing general tasks"](#) on page 663

Usage: Event

Manual operation: See ["Set To Default"](#) on page 108

[[:SOURce<hw>]:BB:DM:SRATe <SRate>

Sets the symbol rate in Hz/kHz/MHz or sym/s, ksym/s and Msym/s.

Parameters:

<SRate> float
 Range: 400 to depends on the installed options
 Increment: 0.001
 *RST: 270833.333
 Default unit: Hz or sym/s

Example: See [Example "Performing general tasks"](#) on page 663.

Manual operation: See ["Symbol Rate"](#) on page 109

[[:SOURce<hw>]:BB:DM:STANdard <Standard>

Selects predefined set of settings according to the selected standard, see [Table 4-5](#).

Parameters:

<Standard> USER | BLUetooth | DECT | ETC | GSM | GSMEdge | NADC | PDC | PHS | TETRa | W3GPp | TDSCdma | CFORward | CREVerse | WORLdspace | TFTS | APCOPH1C4fm | APCOPH1CQpsk | APCOPH2HCpm | APCOPH2HDQpsk | APCOPH2HD8PSKW | APCOPH2HD8PSKN | APCOPH1Lsm | APCOPH1Wcqpsk | CWBPsK | SOQPSKTG
 A query returns the value `USER` if settings deviate from standard-compliant settings.
 *RST: GSM

Example: See [Example "Performing general tasks"](#) on page 663.

Manual operation: See ["Set according to Standard"](#) on page 109

[[:SOURce<hw>]:BB:DM:SOURce <Source>

Selects the data source.

Parameters:

<Source> ZERO | ONE | PRBS | PATtern | DLISt
 *RST: PRBS

Example: See [Example"Performing general tasks"](#) on page 663

Manual operation: See ["Data Source"](#) on page 110

[:SOURce<hw>]:BB:DM:PATtern <Pattern>, <BitCount>

Selects the data pattern for the internal data source.

Parameters:

<Pattern> numeric
 *RST: #H0
 <BitCount> integer
 Range: 1 to 64
 *RST: 1

Example: SOURce:BB:DM:SOURce PATT
 SOURce:BB:DM:PATtern #B01110111010101010,17
 Generates the user-defined sequence of 0/1 data.

Manual operation: See ["Data Source"](#) on page 110

[:SOURce<hw>]:BB:DM:PRBS[:LENGth] <Length>

Defines the length of the pseudo-random sequence in accordance with the following equation:

$$\text{Length} = (2^{\text{Length}}) - 1$$

Parameters:

<Length> 9 | 11 | 15 | 16 | 20 | 21 | 23 | PN9 | PN11 | PN15 | PN16 | PN20 |
 PN21 | PN23
 *RST: 9

Example: See [Example"Performing general tasks"](#) on page 663

Manual operation: See ["Data Source"](#) on page 110

Save/recall settings

[:SOURce<hw>]:BB:DM:STANdard:ULISt:CATalog?

[:SOURce<hw>]:BB:DM:SETTing:CATalog?

Queries the files with digital modulation respectively user standard settings in the default directory. Listed are files with the file extension *.dm and *.dm_stu.

Refer to [Chapter 14.5.2, "Accessing files in the default or in a specified directory"](#), on page 583 for general information on file handling in the default and a specific directory.

Return values:

<Catalog> "<filename1>,<filename2>,..."
Returns a string of file names separated by commas.

Example: See [Example "Performing general tasks"](#) on page 663

Usage: Query only

Manual operation: See ["Save/Recall"](#) on page 108

[:SOURce<hw>]:BB:DM:STANdard:ULIST:STORE <Filename>

[:SOURce<hw>]:BB:DM:SETTING:STORE <Filename>

Stores the current settings into the selected file; the file extension (* .dm respectively * .dm_stu) is assigned automatically.

Refer to [Chapter 14.5.2, "Accessing files in the default or in a specified directory"](#), on page 583 for general information on file handling in the default and a specific directory.

Setting parameters:

<Filename> string

Example: See [Example "Performing general tasks"](#) on page 663

Usage: Setting only

Manual operation: See ["Save/Recall"](#) on page 108

[:SOURce<hw>]:BB:DM:STANdard:ULIST:LOAD <Filename>

[:SOURce<hw>]:BB:DM:SETTING:LOAD <Filename>

Loads the selected file from the default or the specified directory. Loaded are files with extension * .dm respectively * .dm_stu.

Refer to [Chapter 14.5.2, "Accessing files in the default or in a specified directory"](#), on page 583 for general information on file handling in the default and a specific directory.

Setting parameters:

<Filename> string

Example: See [Example "Performing general tasks"](#) on page 663

Usage: Setting only

Manual operation: See ["Save/Recall"](#) on page 108

[:SOURce<hw>]:BB:DM:STANdard:ULIST:DELeTe <Filename>

[:SOURce<hw>]:BB:DM:SETTING:DELeTe <Filename>

Deletes the selected file from the default or specified directory. Deleted are files with the file extension * .dm respectively * .dm_stu.

Refer to [Chapter 14.5.2, "Accessing files in the default or in a specified directory"](#), on page 583 for general information on file handling in the default and a specific directory.

Setting parameters:

<Filename> string

Example: See [Example "Performing general tasks"](#) on page 663

Usage: Setting only

Manual operation: See ["Save/Recall"](#) on page 108

Filter settings

[:SOURce<hw>]:BB:DM:FILTER:TYPE <Type>

Selects the filter type.

If you select a standard (:BB:DM:STAN), the firmware automatically sets the standard-compliant filter type and filter parameter.

Parameters:

<Type> RCOSine | COSine | GAUSSs | LGAuss | CONE | COF705 |
 COEQUALizer | COFEQUALizer | C2K3x | APCO25 | SPHase |
 RECTangle | USER | PGAuss | LPASs | DIRac | ENPShape |
 EWPSHape | LTEFilter | LPASSEVM | APCO25Hcpm |
 APCO25Lsm | HRP | SOQPSK
 *RST: GAUSSs

Example: See [\[:SOURce<hw>\]:BB:DM:FILTER:PARAMeter:SPHase](#) on page 669.

Manual operation: See ["Filter"](#) on page 115

[:SOURce<hw>]:BB:DM:FILTER:PARAMeter:APCO25 <Apco25>
[:SOURce<hw>]:BB:DM:FILTER:PARAMeter:APCO25Lsm:GAUSSs <Gauss>
[:SOURce<hw>]:BB:DM:FILTER:PARAMeter:APCO25Lsm:LOWPass <FiltParm>
[:SOURce<hw>]:BB:DM:FILTER:PARAMeter:COSine:BANDwidth <Bandwidth>
[:SOURce<hw>]:BB:DM:FILTER:PARAMeter:COSine[::ROLLoff] <Cosine>
[:SOURce<hw>]:BB:DM:FILTER:PARAMeter:GAUSSs <Gauss>
[:SOURce<hw>]:BB:DM:FILTER:PARAMeter:LPASs <LPass>
[:SOURce<hw>]:BB:DM:FILTER:PARAMeter:LPASSEVM <LPassEvm>
[:SOURce<hw>]:BB:DM:FILTER:PARAMeter:PGAuss <PGauss>
[:SOURce<hw>]:BB:DM:FILTER:PARAMeter:RCOSine <RCosine>
[:SOURce<hw>]:BB:DM:FILTER:PARAMeter:SPHase <SPHase>

Sets the filter parameter.

Filter Type	Parameter	Parameter Name	Min	Max	Increment	Default
APCO25	Roll-off factor	<Apco25>	0.05	0.99	0.01	0.2
APCO25Lsm	Cut off frequency for the lowpass/gauss filter (:LOWPass/:GAUSSs)	<Cosine>	400	25E6	1E-3	270833.333
COSine	Bandwidth	<FiltParm>	400	depends on the installed options ^{*)}	1E-3	270833.333
COSine	Roll-off factor	<Cosine>	0.05	1	0.01	0.35
GAUSSs	Roll-off factor	<Gauss>	0.15	100000	0.01	0.3
LPASSs	Cut-off frequency	<LPass>	0.05	2	0.01	0.5
LPASSEVM	Cut-off frequency	<LPassEvm>	0.05	2	0.01	0.5
PGAUSSs	Roll-off factor	<PGauss>	0.15	2.5	0.01	0.3
RCOSine	Roll-off factor	<RCosine>	0.05	1	0.001	0.35
SPHase	B x T	<SPHase>	0.15	2.5	0.01	2

^{*)}120E6 (R&S SMCVB-K521) / 160E6 (R&S SMCVB-K522) / 240E6 (R&S SMCVB-K522)

Parameters:

<SPHase> float
 Range: 0.15 to 2.5
 Increment: 0.01
 *RST: 2

Example: SOURce:BB:DM:FILTer:TYPE SPHase
 SOURce:BB:DM:FILTer:PARAMeter:SPHase 0.5

Manual operation: See "Filter Parameter" on page 115

[[:SOURce<hw>]:DM:FILTer:PARAMeter <Parameter>

Sets the filter parameter of the currently selected filter type.

To set the filter type, use command [:SOURce<hw>] :BB:DM:FILTer:TYPE on page 669.

Parameters:

<Parameter> float
 Range: 0.05 to 2.5
 Increment: 0.01
 *RST: 0.35

Example: See [:SOURce<hw>] :BB:DM:FILTer:PARAMeter:SPHase on page 669

Modulation and coding settings

[:SOURce<hw>]:BB:DM:CODing <Coding>

Selects the modulation coding.

Parameters:

<Coding> OFF | DIFF | DPHS | DGRay | GRAY | GSM | NADC | PDC | PHS | TETRa | APCO25 | PWT | TFTS | INMarsat | VDL | EDGE | APCO25FSK | ICO | CDMA2000 | WCDMA | APCO258PSK

OFF

The coding is automatically disabled if the selected modulation type is not possible with the coding that has been set

DPHS

Phase Difference

DGRay

Difference + Gray

*RST: GSM

Example: See [Example"Performing general tasks"](#) on page 663

Manual operation: See ["Coding"](#) on page 109

[:SOURce<hw>]:BB:DM:FORMat <Format>

Sets the modulation type.

When a standard is selected (`[:SOURce<hw>] :BB:DM:STANdard`), the modulation type is set to the default value.

Parameters:

<Format> ASK | BPSK | P2DBpsk | QPSK | QPSK45 | OQPSk | P4QPsk | P4DQpsk | PSK8 | P8D8psk | P8EDge | QAM16 | QAM32 | QAM64 | QAM256 | QAM1024 | MSK | FSK2 | FSK4 | USER | FSKVar | QAM128 | QEDGe | QAM16EDge | QAM32EDge | AQPSk | QAM4096 | APSK16 | APSK32 | FSK32 | FSK64 | FSK8 | FSK16 | QAM512 | QAM2048

*RST: MSK

Example: See [Example"Performing general tasks"](#) on page 663

Manual operation: See ["Modulation Type"](#) on page 113

[:SOURce<hw>]:BB:DM:AQPSk:ANGLE <Angle>

For AQPSK modulation, sets the angle alpha between the point (0,0) and the I axis.

Parameters:

<Angle> float
 Range: 0 to 180
 Increment: 0.01
 *RST: 0
 Default unit: Deg

Example:

BB:DM:FORM AQPS
 BB:DM:AQPS:ANGL 45

Manual operation: See ["Angle Alpha"](#) on page 113

[:SOURce<hw>]:BB:DM:ASK:DEPTH <Depth>

Sets the ASK modulation depth for modulation type ASK.

Parameters:

<Depth> float
 Range: 0 to 100
 Increment: 0.1
 *RST: 100
 Default unit: PCT

Example:

BB:DM:FORM ASK
 BB:DM:ASK:DEPT 50 PCT

Manual operation: See ["ASK Depth"](#) on page 113

[:SOURce<hw>]:BB:DM:FSK:DEVIation <Deviation>

Sets the frequency deviation when FSK modulation is selected.

Parameters:

<Deviation> float
 The value range depends on the symbol rate.
 Range: 1 to 40E6
 Increment: 0.5
 *RST: 135416.5

Example:

SOURce:BB:DM:FORMat FSK4
 SOURce:BB:DM:FSK:DEVIation 1MHZ

Manual operation: See ["FSK Deviation"](#) on page 113

[:SOURce<hw>]:BB:DM:FSK:VARiable:SYMBOL<ch0>:DEVIation <Deviation>

Sets the deviation of the selected symbol for variable FSK modulation mode.

Parameters:

<Deviation> float

The value range depends on the selected symbol rate (see data sheet).

Range: -40E6 to 40E6

Increment: 0.5

Default unit: Hz

Example:

```
SOURce:BB:DM:FORMat FSKVar
SOURce:BB:DM:FSK:VARiable:TYPE FSK4
SOURce:BB:DM:FSK:VARiable:SYMBOL0:DEVIation 135000
```

Manual operation: See "[Deviation xxxx](#)" on page 114**[[:SOURce<hw>]:BB:DM:FSK:VARiable:TYPE <Type>**

The command selects the modulation type for Variable FSK.

Parameters:

<Type> FSK4 | FSK8 | FSK16

*RST: FSK4

Example:

See [\[:SOURce<hw>\]:BB:DM:FSK:VARiable:SYMBOL<ch0>:DEVIation](#) on page 672

Manual operation: See "[FSK Type](#)" on page 114**[[:SOURce<hw>]:BB:DM:APSK16:GAMMa <Gamma>**

Sets the gamma function γ for the 16APSK modulation.

Parameters:

<Gamma> G2D3 | G3D4 | G4D5 | G5D6 | G8D9 | G9D10

GxDy: G = Gamma function, x_y = code rate

*RST: G2D3

Example:

```
SOURce1:BB:DM:FORMat APSK16
SOURce1:BB:DM:APSK16:GAMMa G9D10
```

Manual operation: See "[Gamma/Gamma 1](#)" on page 114**[[:SOURce<hw>]:BB:DM:APSK32:GAMMa <Gamma>**

Sets the gamma function γ for the 32APSK modulation.

Parameters:

<Gamma> G3D4 | G4D5 | G5D6 | G8D9 | G9D10

GxDy: G = Gamma function, x_y = code rate

*RST: G3D4

Example: SOURce1:BB:DM:FORMat APSK32
 SOURce1:BB:DM:APSK32:GAMMa G9D10

Manual operation: See ["Gamma/Gamma 1"](#) on page 114

[:SOURce<hw>]:BB:DM:SWITChing:STATE <State>

Enables switching between a modulated and an unmodulated signal.

Parameters:
 <State> 1 | ON | 0 | OFF
 *RST: 0

Manual operation: See ["State Modulation CW Switching"](#) on page 114

Power ramping

[:SOURce<hw>]:BB:DM:PRAMp:SOURce <Source>

Sets the source for the power ramp control signals.

Parameters:
 <Source> INTernal
 *RST: INTernal

Example: See [Example"Enable power ramping"](#) on page 665

Manual operation: See ["Source"](#) on page 117

[:SOURce<hw>]:BB:DM:PRAMp:SHAPe <Shape>

Sets the edge shape of the ramp envelope.

Parameters:
 <Shape> LINear | COSine
 *RST: COSine

Example: See [Example"Enable power ramping"](#) on page 665

Manual operation: See ["Ramp Function"](#) on page 117

[:SOURce<hw>]:BB:DM:PRAMp:TIME <Time>

Sets the power ramping rise time and fall time for a burst.

Parameters:
 <Time> float
 Range: 0.25 to 16
 Increment: 0.01
 *RST: 1
 Default unit: symbol

Example: See [Example"Enable power ramping"](#) on page 665

Manual operation: See ["Ramp Time"](#) on page 117

[:SOURce<hw>]:BB:DM:PRAMp:FDElay <FDelay>
[:SOURce<hw>]:BB:DM:PRAMp:RDElay <RDelay>

Sets the delay in the rising edge.

Parameters:

<RDelay> float
 Range: 0 to 4
 Increment: 0.01
 *RST: 0
 Default unit: symbol

Example: See [Example"Enable power ramping"](#) on page 665

Manual operation: See ["Rise Delay"](#) on page 117

[:SOURce<hw>]:BB:DM:PRAMp:ATTenuation <Attenuation>

Sets the level attenuation for signal ranges that are flagged with level attribute *attenuated* by the control signal.

Parameters:

<Attenuation> float
 Range: 0 to 50
 Increment: 0.1
 *RST: 15
 Default unit: dB

Example: See [Example"Enable power ramping"](#) on page 665

Manual operation: See ["Attenuation"](#) on page 118

[:SOURce<hw>]:BB:DM:PRAMp:BBONly[:STATe] <State>

Enables power ramping in the baseband only or mixed power ramping in the baseband and the RF section.

The ON setting is mandatory if, with power ramping active, only the baseband signal is output (I/Q outputs).

Only then can a signal with a defined, predictable level be output.

Parameters:

<State> 1 | ON | 0 | OFF
 *RST: 0

Example: See [Example"Enable power ramping"](#) on page 665.

Manual operation: See ["In Baseband Only"](#) on page 118

[:SOURce<hw>]:BB:DM:PRAMP[:STATe] <State>

Enables or disables power ramping.

Parameters:

<State> 1 | ON | 0 | OFF
 *RST: 0

Example: See [Example"Enable power ramping"](#) on page 665

Manual operation: See ["State"](#) on page 117

Trigger settings

[:SOURce<hw>]:BB:DM:TRIGger]:SEQuence <Sequence>

Selects the trigger mode. For detailed description of the trigger modes, refer to ["Impact of the trigger modes on the signal generation"](#) on page 87.

Parameters:

<Sequence> AUTO | RETRigger | AAUTo | ARETrigger | SINGle
 *RST: AUTO

Example: See [Example"Adjusting clock, marker and trigger settings"](#) on page 664

Manual operation: See ["Mode"](#) on page 101

[:SOURce<hw>]:BB:DM:TRIGger:SOURce <Source>

Selects the trigger signal source and determines the way the triggering is executed. Provided are:

- Internal triggering by a command (INTernal)

Parameters:

<Source> INTernal|EXTernal
 *RST: INTernal

Example: See [Example"Adjusting clock, marker and trigger settings"](#) on page 664

Manual operation: See ["Source"](#) on page 102

[:SOURce<hw>]:BB:DM:TRIGger:SLENgth <SLength>

Defines the length of the signal sequence to be output in the SINGle trigger mode.

Parameters:

<SLength> integer
 Range: 1 to 4294967295
 *RST: 1000
 Default unit: symbol

Example: See [Example"Adjusting clock, marker and trigger settings"](#) on page 664

Manual operation: See ["Signal Duration"](#) on page 102

[:SOURce<hw>]:BB:DM:TRIGger:RMODE?

Queries the status of signal generation.

Return values:

<RMode> STOP | RUN

Example: SOURce1:BB:DM:TRIGger:SOURce ELTRigger
SOURce1:BB:DM:TRIGger:SEQuence ARETrigger
SOURce1:BB:DM:TRIGger:RMODE?
Response: RUN

Usage: Query only

Manual operation: See ["Running/Stopped"](#) on page 102

[:SOURce<hw>]:BB:DM:TRIGger:EXTernal:SYNChronize:OUTPut <Output>

Enables signal output synchronous to the trigger event.

Parameters:

<Output> 1 | ON | 0 | OFF
*RST: 1

Example: See [Example"Adjusting clock, marker and trigger settings"](#) on page 664

Manual operation: See ["Sync. Output to External Trigger/Sync. Output to Trigger"](#) on page 103

[:SOURce<hw>]:BB:DM:TRIGger:ARM:EXECute

Stops signal generation; a subsequent internal or external trigger event restart signal generation.

Example: See also [Example"Adjusting clock, marker and trigger settings"](#) on page 664

Usage: Event

Manual operation: See ["Arm"](#) on page 102

[:SOURce<hw>]:BB:DM:TRIGger:EXECute

Executes a trigger.

Example: See [Example"Adjusting clock, marker and trigger settings"](#) on page 664

Usage: Event

Manual operation: See ["Execute Trigger"](#) on page 102

[:SOURce<hw>]:BB:DM:TRIGger:DELay:UNIT <TrigDelUnit>

Determines the units the trigger delay is expressed in.

Parameters:

<TrigDelUnit> SAMPLE | TIME
*RST: SAMPLE

Example: See [Example"Specifying delay and inhibit values in time units"](#) on page 690

Manual operation: See ["\(External\) Delay Unit"](#) on page 103

[:SOURce<hw>]:BB:DM:TRIGger[:EXTErnal]:DELay <Delay>

Specifies the trigger delay in symbols.

Maximum trigger delay and trigger inhibit values depend on the installed options. See ["Specifying delay and inhibit values"](#) on page 93.

Parameters:

<Delay> float
Range: 0 to depends on the symbol rate
Increment: 0.01
*RST: 0
Default unit: symbol

Example: See [Example"Adjusting clock, marker and trigger settings"](#) on page 664.

Manual operation: See ["\(Specified\) External Delay/\(Specified\) Trigger Delay"](#) on page 103

[:SOURce<hw>]:BB:DM:TRIGger[:EXTErnal]:TDELay <ExtTimeDelay>

Specifies the trigger delay for external triggering. The value affects all external trigger signals.

Maximum trigger delay and trigger inhibit values depend on the installed options. See ["Specifying delay and inhibit values"](#) on page 93.

Parameters:

<ExtTimeDelay> float
Range: 0 to 7929.170398682
Increment: 0.25E-9
*RST: 0
Default unit: s

Example: See [Example "Specifying delay and inhibit values in time units"](#) on page 690.

Manual operation: See ["\(Specified\) External Delay/\(Specified\) Trigger Delay"](#) on page 103

[:SOURce<hw>]:BB:DM:TRIGger[:EXTErnal]:RDELay?

Queries the time (in seconds) an external trigger event is delayed for.

Return values:

<ResTimeDelaySec> float
 Range: 0 to 688
 Increment: 0.25E-9
 *RST: 0

Example: See [Example "Specifying delay and inhibit values in time units"](#) on page 690

Usage: Query only

Manual operation: See ["Actual Trigger Delay/Actual External Delay"](#) on page 104

[:SOURce<hw>]:BB:DM:TRIGger[:EXTErnal]:INHibit <Inhibit>

Specifies the number of symbols, by which a restart is inhibited.

Maximum trigger delay and trigger inhibit values depend on the installed options. See ["Specifying delay and inhibit values"](#) on page 93.

Parameters:

<Inhibit> integer
 Range: 0 to 21.47 * (symbol rate)
 *RST: 0
 Default unit: symbol

Example: See [Example "Adjusting clock, marker and trigger settings"](#) on page 664.

Manual operation: See ["External / Trigger Inhibit"](#) on page 103

Marker settings

[:SOURce<hw>]:BB:DM:TRIGger:OUTPut<ch>:MODE <Mode>

Defines the signal for the selected marker output.

For detailed description of the regular marker modes, refer to ["Marker modes"](#) on page 85.

Parameters:

<Mode> CLISt | PULSe | PATTeRn | RATIo

CLISt

A marker signal that is defined in the selected control list is generated.

*RST: RATIo

Example:

See [Example "Adjusting clock, marker and trigger settings"](#) on page 664

Manual operation: See ["Marker Mode"](#) on page 104

[:SOURce<hw>]:BB:DM:TRIGger:OUTPut<ch>:ONTime <OnTime>

[:SOURce<hw>]:BB:DM:TRIGger:OUTPut<ch>:OFFTime <OffTime>

Sets the number of symbols in a period (ON time + OFF time) for marker RATIo.

Parameters:

<OffTime> integer

Range: 1 to 16777215

*RST: 1

Default unit: symbol

Example:

See [Example "Adjusting clock, marker and trigger settings"](#) on page 664

Manual operation: See ["Marker Mode"](#) on page 104

[:SOURce<hw>]:BB:DM:TRIGger:OUTPut<ch>:PATTeRn <Pattern>, <BitCount>

Defines the bit pattern used to generate the marker signal.

Parameters:

<Pattern> numeric

*RST: #H2

<BitCount> integer

0 = marker off, 1 = marker on

Range: 1 to 64

*RST: 2

Example:

See [Example "Adjusting clock, marker and trigger settings"](#) on page 664.

Manual operation: See ["Marker Mode"](#) on page 104

[:SOURce<hw>]:BB:DM:TRIGger:OUTPut<ch>:PULSe:DIVider <Divider>

Sets the divider for pulse marker mode (PULSe).

Parameters:

<Divider> integer
 Range: 2 to 1024
 *RST: 2

Example: See [Example"Adjusting clock, marker and trigger settings"](#) on page 664

Manual operation: See ["Marker Mode"](#) on page 104

[:SOURce<hw>]:BB:DM:TRIGger:OUTPut<ch>:PULSe:FREQuency?

Queries the pulse frequency of the pulsed marker signal PULSe.

Return values:

<Frequency> float

Example: See [Example"Adjusting clock, marker and trigger settings"](#) on page 664

Usage: Query only

Manual operation: See ["Marker Mode"](#) on page 104

[:SOURce<hw>]:BB:DM:TRIGger:OUTPut<ch>:DELay <Delay>

Defines the delay between the signal on the marker outputs and the start of the signal, expressed in terms of symbols.

Parameters:

<Delay> float
 Range: 0 to 16777215
 Increment: 0.001
 *RST: 0

Example: See [Example"Adjusting clock, marker and trigger settings"](#) on page 664.

Manual operation: See ["Marker x Delay"](#) on page 105

Clock settings**[:SOURce<hw>]:BB:DM:CLOCK:SOURce <Source>**

Selects the clock source:

- INTernal: Internal clock reference

Parameters:

<Source> INTernal
 *RST: INTernal

Example: See [Example"Adjusting clock, marker and trigger settings"](#) on page 664.

Manual operation: See ["Clock Source"](#) on page 105

Handling list files

```
[ :SOURce<hw>]:BB:DM:CLIST:CATalog?
[:SOURce<hw>]:BB:DM:FLIST:CATalog?
[:SOURce<hw>]:BB:DM:MLIST:CATalog?
[:SOURce<hw>]:BB:DM:DLIST:CATalog?
```

Reads out the list files present in the default directory (see [:MMEMory:CDIRectory](#)).

List type	Command	File extension
Data list	...:DLIST...	*.dm_iqd
Control list	...:CLIST...	*.dm_iqc
User filter files	...:FLIST...	*.vaf
User mapping lists	...:MLIST...	*.vam

Refer to [Chapter 14.5.2, "Accessing files in the default or in a specified directory"](#), on page 583 for general information on file handling in the default and a specific directory.

Return values:

<Catalog> "<filename1>,<filename2>,..."
Returns a string of file names separated by commas.

Example: See [Example "Performing general tasks"](#) on page 663.

Usage: Query only

Manual operation: See ["Data Source"](#) on page 110
See ["Select Data List"](#) on page 111

```
[ :SOURce<hw>]:BB:DM:CLIST:SElect <Filename>
[:SOURce<hw>]:BB:DM:FLIST:SElect <Filename>
[:SOURce<hw>]:BB:DM:MLIST:SElect <Filename>
[:SOURce<hw>]:BB:DM:DLIST:SElect <Select>
```

Selects the specified list file from the default directory (see [:MMEMory:CDIRectory](#)) or in the directory specified with the complete file path.

If a list with the specified name does not yet exist, it is created. The file extension can be omitted.

Refer to [Chapter 14.5.2, "Accessing files in the default or in a specified directory"](#), on page 583 for general information on file handling in the default and a specific directory.

List type	Command	File extension
Data list	...:DLISt...	*.dm_iqd
Control list	...:CLISt...	*.dm_iqc
User standard	...:ULISt...	*.dm_stu
User filter files	...:FLISt...	*.vaf
User mapping lists	...:MLISt...	*.vam

Parameters:

<Select> <list name>

Example: See [Example"Performing general tasks"](#) on page 663

Manual operation: See ["Data Source"](#) on page 110
 See ["Select Data List"](#) on page 111
 See ["Functions for handling of data lists"](#) on page 427

[:SOURce<hw>]:BB:DM:CLISt:DELeTe <Filename>

[:SOURce<hw>]:BB:DM:FLISt:DELeTe <Filename>

[:SOURce<hw>]:BB:DM:MLISt:DELeTe <Filename>

[:SOURce<hw>]:BB:DM:DLISt:DELeTe <Filename>

Deletes the specified list from the default directory (see [:MMEMory:CDIRectory](#)) or from the directory specified with the complete file path.

Refer to [Chapter 14.5.2, "Accessing files in the default or in a specified directory"](#), on page 583 for general information on file handling in the default and a specific directory.

List type	Command	File extension
Data list	...:DLISt...	*.dm_iqd
Control list	...:CLISt...	*.dm_iqc
User standard	...:ULISt...	*.dm_stu
User filter files	...:FLISt...	*.vaf
User mapping lists	...:MLISt...	*.vam

Setting parameters:

<Filename> string

Example: See [Example"Performing general tasks"](#) on page 663

Usage: Setting only

Manual operation: See ["Select Data List"](#) on page 111

[:SOURce<hw>]:BB:DM:CLISt:FREE?

[:SOURce<hw>]:BB:DM:FLISt:FREE?

[[:SOURce<hw>]:BB:DM:MLIST:FREE?

[[:SOURce<hw>]:BB:DM:DLIST:FREE?

Queries the list free memory.

List type	Command	File extension
Data list	...:DLIST...	*.dm_iqd
Control list	...:CLIST...	*.dm_iqc
User filter files	...:FLIST...	*.vaf
User mapping lists	...:MLIST...	*.vam

Return values:

<Free> integer
 Range: 0 to INT_MAX
 *RST: 0

Example: See [Example"Performing general tasks"](#) on page 663

Usage: Query only

[[:SOURce<hw>]:BB:DM:CLIST:POINTs?

Queries the number of lines (2 bytes) in the currently selected list.

Return values:

<Points> integer
 Range: 0 to INT_MAX
 *RST: 0

Example:

```
SOURce:BB:DM:CLIST:SElect "c_list"
SOURce:BB:DM:CLIST:POINTs?
// 20
// the control list consists of 20 lines
```

Usage: Query only

[[:SOURce<hw>]:BB:DM:DLIST:POINTs <Points>

Defines the number of bits in the selected data list to be utilized. When a list is being filled with block data, this data is only ever sent in multiples of 8 bits. However the exact number of bits to be exploited can be set to a different figure. The superfluous bits in the list are then ignored.

Parameters:

<Points> integer
 Range: 0 to INT_MAX
 *RST: 0

Example: `SOURce:BB:DM:DLIST:POINTS 234`
 Defines the number of bits in the data list to be utilized as 234 bits. If the list was filled with block data, at least the last 6 bits are ignored.

[:SOURce<hw>]:BB:DM:FLIST:POINTS?

[:SOURce<hw>]:BB:DM:MLIST:POINTS?

Queries the user modulation mapping/user filter list length.

Return values:

<Points> integer
 Range: max
 *RST: 0

Example: `BB:DM:FORM USER`
`BB:DM:MLIS:POIN?`

Usage: Query only

[:SOURce<hw>]:BB:DM:CLIST:COPY <Filename>

[:SOURce<hw>]:BB:DM:DLIST:COPY <Filename>

Copies the selected data list (* .dm_iqd)/ control list (* .dm_iqc) as a new list with name specified by <Filename>. If a list with the specified name exists, it is overwritten. If it does not yet exist, it is created.

The source file has to be available in the default directory (see [:MMEMory:CDIRectory](#)).

Refer to [Chapter 14.5.2, "Accessing files in the default or in a specified directory"](#), on page 583 for general information on file handling in the default and a specific directory.

Setting parameters:

<Filename> string

Example: See [Example "Performing general tasks"](#) on page 663

Usage: Setting only

Manual operation: See ["Select Data List"](#) on page 111

[:SOURce<hw>]:BB:DM:CLIST:DATA <Data>

Sends the data to the currently selected control list. If the list already contains data, it is *overwritten*. This command only writes data into the data section of the file.

The values for the control signals are sent, arranged in an 8-bit value as defined in [Table 14-1](#).

Table 14-1: Contents of a control lists

Signal	Order	Decimal value of bits
Marker 1	LSB	1
Marker 2		2
Marker 3		4
Burst	LSB	16
LevAtt1	LSB	32
CWMod	LSB	64
Hop	MSB	128

The data can also be sent as a binary block, each binary block being a 2-byte value in which the 16 bits represent the binary values (16-bit unsigned integer, 2 bytes, LSB first).

Tip: Control lists are created in binary format. You may however need the control list in an ASCII format, e.g for creating a waveform file with R&S WinIQSIM2. Refer to the examples in [Chapter 4.6.4.6, "How to create a control list using tag file format"](#), on page 164 for description on how to create a control list file in ASCII format manually.

*RST has no effect on data lists.

Setting parameters:

<Data> string

Example:

```
:MMEory:CDirectory "/var/user/clists"
:SOURce1:BB:DM:CLIST:SElect "clist_marker3"
:SOURce1:BB:DM:CLIST:DATA 0,0,0,0,4,4,4,0,0,0,0...
// Enters the control values in the selected list.
// In the example, only ramps for Marker 3 are set.
```

Usage: Setting only

Manual operation: See "[Select Ramp to Edit](#)" on page 122

[:SOURce<hw>]:BB:DM:DLIST:DATA <Data>

[:SOURce<hw>]:BB:DM:DLIST:DATA? [<Start>[, <Count>]]

The **Setting** command sends the bit data to the selected data list. Any existing content in the list is *overwritten*. This command only writes data into the data section of the file.

Data can be sent as block data in binary or packet format (:FORMat ASCii | PACKed), each byte being interpreted as 8 data bits.

The **query** reads out the data part of the list file. If the query is expanded by using the two parameters <Start> and <Count>, the list is read out in smaller sections. Without the parameters the total length is always read out starting from address 1.

*RST has no effect on data lists.

Parameters:

<Data> integer
bit data

Query parameters:

<Start> integer
Range: 1 to 2147483647

<Count> integer
Range: 1 to 2147483647

Example: See [Example"Performing general tasks"](#) on page 663

[:SOURce<hw>]:BB:DM:DLIST:DATA:APPend <Bits>

Appends the bit data onto the end of the existing data in the selected data list. Existing content in the data list is not overwritten. Hence, you can create long data lists piece-meal.

The command cannot be used with an empty data list, like for example data lists that has just been created. Use the command `[:SOURce<hw>]:BB:DM:DLIST:DATA` first and enter modulation data in the list.

*RST has no effect on data lists.

Setting parameters:

<Bits> 0 | 1 {0 | 1} | block data

Example: See [Example"Performing general tasks"](#) on page 663

Usage: Setting only

[:SOURce<hw>]:BB:DM:CLIST:TAG?**[:SOURce<hw>]:BB:DM:DLIST:TAG?**

Queries the content of the specified tag in the selected file.

Return values:

<Tag> <control list>,<tag name>
Refer to [Chapter 4.6.7, "Tags for waveforms, data and control lists"](#), on page 173 for description of the available tag formats.

Example: `SOURce1:BB:DM:DLIST:TAG? "D_list","date"`
Queries the Date tag in list D_list.

Usage: Query only

14.16.3.3 SOURce:BB:ARbitrary subsystem

This section list the commands of the `SOURce:BB:ARbitrary` subsystem.

Required options

See [Chapter 4.6.1, "Required options"](#), on page 137.

The commands are grouped in the following sections:

• Programming examples	688
• General commands	696
• Test signal commands	697
• Waveform commands	700
• Multi-segment commands	704
• Multi-segment sequencing commands	709
• Multi-carrier commands	712
• Trigger commands	723
• Marker commands	728
• Clock commands	730

Programming examples

Example: Creating test signals

The following example lists commands necessary to configure the different test signals.

```
// *****
// Reset instrument first
// *****
*RST; *CLS
SOURce:BB:ARbitrary:PRESet

// *****
// Create test signals
// *****
SOURce:BB:ARbitrary:SIGNAL:TYPE CIQ
SOURce:BB:ARbitrary:TSIGNAL:CIQ:I -0.5
SOURce:BB:ARbitrary:TSIGNAL:CIQ:Q -0.33
SOURce:BB:ARbitrary:TSIGNAL:CIQ:CREate

SOURce:BB:ARbitrary:TSIGNAL:SINE:FREQuency 1MHz
SOURce:BB:ARbitrary:TSIGNAL:SINE:SAMPles 100
SOURce:BB:ARbitrary:TSIGNAL:SINE:PHASe -90
SOURce:BB:ARbitrary:TSIGNAL:SINE:CREate:NAMed "/var/user/ARBtestSignals/sineTest"

SOURce:BB:ARbitrary:TSIGNAL:RECTangle:FREQuency 100KHz
SOURce:BB:ARbitrary:TSIGNAL:RECTangle:SAMPles 1000
SOURce:BB:ARbitrary:TSIGNAL:RECTangle:AMPLitude 0.5
SOURce:BB:ARbitrary:TSIGNAL:RECTangle:OFFSet -0.3
SOURce:BB:ARbitrary:TSIGNAL:RECTangle:CREate:NAMed "/var/user/ARBtestSignals/rectTest"

SOURce:ARbitrary:STATe ON
```

Example: Managing waveform files

The following example lists the commands provided for handling of waveform files.

```
// *****
// Reset instrument first
// *****
*RST; *CLS
SOURce:BB:ARbitrary:PRESet

// *****
// Set the default directory and list the available waveform files
// *****
MMEM:CDIR "/var/user/ARBtestSigs"
SOURce:BB:ARbitrary:WAVEform:CATalog?
// sineTest,rectTest,ciqTestSignal,waveformTest,test2
SOURce:BB:ARbitrary:WAVEform:CATalog:LENGth?
// 5
// SOURce:BB:ARbitrary:WAVEform:FREE?

// *****
// Select a waveform and query information
// *****
// SOURce:BB:ARbitrary:WAVEform:DElete "/var/user/ARBtestSigs/test2"
SOURce:BB:ARbitrary:WAVEform:SElect "/var/user/ARBtestSigs/wvTest"
SOURce:BB:ARbitrary:WAVEform:POINts?
// 100
SOURce:BB:ARbitrary:WAVEform:TAG? "TYPE"
// "SMU-WV"
SOURce:BB:ARbitrary:WAVEform:TAG? "COMMENT"
// "Waveform for test purposes"
// alternatively: query the comment tag of the current waveform file
// SOURce:BB:ARbitrary:WAVEform:DATA? "comment"
// "Waveform for test purposes"

// to query the date tag of a specific waveform file
// SOURce:BB:ARbitrary:WAVEform:DATA? "/var/user/ARBtestSigs/waveformTest","date"
// #2192014-04-15;16:19:30

// *****
// Clock settings
// *****
SOURce:BB:ARbitrary:CLOCK:SOURce INTernal
SOURce:BB:ARbitrary:CLOCK?
// 100000000
// or alternatively use SOURce:BB:ARbitrary:WAVEform:TAG? "CLOCK"

// *****
// Configure and enable standard marker signals
// *****
SOURce:BB:ARbitrary:TRIGger:OUTPut1:MODE REStart
```

```

SOURCE:BB:ARbitrary:TRIGger:OUTPut2:MODE PULSe
SOURCE:BB:ARbitrary:TRIGger:OUTPut2:PULSe:DIVider 5
SOURCE:BB:ARbitrary:TRIGger:OUTPut2:PULSe:FREQuency?
// 2000000
SOURCE:BB:ARbitrary:TRIGger:OUTPut3:MODE PATtern
SOURCE:BB:ARbitrary:TRIGger:OUTPut3:PATtern #HE0F52,20
SOURCE:BB:ARbitrary:TRIGger:OUTPut1:MODE RATio
SOURCE:BB:ARbitrary:TRIGger:OUTPut1:ONTime 40
SOURCE:BB:ARbitrary:TRIGger:OUTPut1:OFFTime 20

SOURCE:BB:ARbitrary:TRIGger:OUTPut2:DELay 16

// *****
// Configure and enable signal triggering; start ARB generator
// *****
SOURCE:BB:ARbitrary:TRIGger:SEQuence SINGle
SOURCE:BB:ARbitrary:TRIGger:SLENgth 200
// the first 200 samples of the current waveform will be output after
// the next trigger event
// SOURCE:BB:ARbitrary:TRIGger:SEQuence ARETrigger
// SOURCE:BB:ARbitrary:TRIGger:SOURce EGT1
// external trigger signal must be provided at the USER connector
SOURCE:BB:ARbitrary:TRIGger:EXTernal:SYNChronize:OUTPut ON
SOURCE:BB:ARbitrary:TRIGger:EXTernal:DELay 200
SOURCE:BB:ARbitrary:TRIGger:EXTernal:INHibit 100

// with internal trigger source
SOURCE:BB:ARbitrary:TRIGger:SEQuence AAUTO
SOURCE:BB:ARbitrary:TRIGger:SOURce INTernal
SOURCE:BB:ARbitrary:STAT ON
SOURCE:BB:ARbitrary:TRIGger:EXEC

// *****
// Enable streaming for large waveforms
// *****
SOURCE:BB:ARbitrary:WAVEform:HDDStreaming:STATe ON
SOURCE:BB:ARbitrary:WAVEform:HDDStreaming:BLEVel?
// 94%

```

Example: Specifying delay and inhibit values in time units

The following example lists the commands necessary to configure the instrument as described in ["Specifying delay and inhibit values"](#) on page 93.

```

SOURCE1:BB:ARbitrary:CLOCK 1000000
SOURCE1:BB:ARbitrary:TRIGger:SEQuence AAUT
SOURCE1:BB:ARbitrary:TRIGger:SOURce EGT1
SOURCE1:BB:ARbitrary:TRIGger:DELay:UNIT SAMP
SOURCE1:BB:ARbitrary:TRIGger:EXTernal:DELay 100
SOURCE1:BB:ARbitrary:TRIGger:EXTernal:RDELay?
// Response: 100

```

```

SOURcel:BB:ARbitrary:TRIGger:DElay:UNIT TIME
SOURcel:BB:ARbitrary:TRIGger:EXTernal:TDElay 0.00001
SOURcel:BB:ARbitrary:TRIGger:EXTernal:RDElay?
// Response: 0.00001

```

```

SOURcel:BB:ARbitrary:TRIGger:DElay:UNIT SAMP
SOURcel:BB:ARbitrary:TRIGger:EXTernal:DElay 10

```

Example: Creating a multi-segment waveform

The following example lists the commands necessary to create a multi-segment waveform.

```

// *****
// Reset instrument first
// *****
*RST; *CLS
// SOURce:BB:ARbitrary:PRESet

// *****
// Set the default directory and list the available waveform files
// *****
MMEM:CDIR "/var/user/ARB/multi_segment"
SOURce:BB:ARbitrary:WAVEform:CATalog:LENGth?
// 4
SOURce:BB:ARbitrary:WAVEform:CATalog?
// Seg_0, Seg_1, Seg_2, Seg_3
// *****
// List the available configuration files and select/create file
// *****
SOURce:BB:ARbitrary:WSEgment:CONFigure:CATalog?
// multi_segment,ms_waveform
// the directory contains the configuration files multi_segment.inf_mswv
// and ms_waveform.inf_mswv
SOURce:BB:ARbitrary:WSEgment:CONFigure:DElete "ms_waveform.inf_mswv"
SOURce:BB:ARbitrary:WSEgment:CONFigure:SElect
"/var/user/ARB/multi_segment/config.inf_mswv"
// creates new empty configuration file config.inf_mswv

// *****
// Append waveforms to the multi segment sequence
// *****
SOURce:BB:ARbitrary:WSEgment:CONFigure:SEGment:APPend "Seg_0"
// Waveform Seg_0.wv will be the first segment of a
// multi segment waveform created with configuration file config.inf_mswv
SOURce:BB:ARbitrary:WSEgment:CONFigure:SEGment:APPend "Seg_1"
SOURce:BB:ARbitrary:WSEgment:CONFigure:SEGment:APPend "Seg_2"
SOURce:BB:ARbitrary:WSEgment:CONFigure:SEGment:APPend "Seg_3"

SOURce:BB:ARbitrary:WSEgment:CONFigure:BLAnk:APPend 1000,100000000

```

```
// adds a blank segment with 1000 samples and 100 MHz clock rate

SOURce:BB:ARBitrary:WSEGment:CONFigure:LEVel:MODE ERMS
SOURce:BB:ARBitrary:WSEGment:CONFigure:CLOCK:MODE HIGHEst
// SOURce:BB:ARBitrary:WSEGment:CONFigure:CLOCK:MODE USER
// SOURce:BB:ARBitrary:WSEGment:CONFigure:CLOCK 30000000
SOURce:BB:ARBitrary:WSEGment:CONFigure:MARKer:MODE TAKE

SOURce:BB:ARBitrary:WSEGment:CONFigure:SElect
"/var/user/ARB/multi_segment/config.inf_mswv"
SOURce:BB:ARBitrary:WSEGment:CONFigure:COMment "Multi Segment File"
SOURce:BB:ARBitrary:WSEGment:CONFigure:OFIle "ms_0to3"
SOURce:BB:ARBitrary:WSEGment:CONFigure:SEGment:CATalog?
// /var/user/ARB/multi_segment/Seg_0.wv, /var/user/ARB/multi_segment/Seg_1.wv,
// /var/user/ARB/multi_segment/Seg_2.wv, /var/user/ARB/multi_segment/Seg_3.wv

// *****
// Create and load the waveforms into the ARB generator; the ARB is activated
// the first segment is output depending on the trigger settings
// *****
// SOURce:BB:ARBitrary:WSEGment:CREate "/var/user/ARB/multi_segment/config.inf_mswv"
SOURce:BB:ARBitrary:WSEGment:CLOad "/var/user/ARB/multi_segment/config.inf_mswv"

SOURce:BB:ARBitrary:TRIGger:SEquence AAUTO
SOURce:BB:ARBitrary:TRIGger:SOURce INTernal
SOURce:BB:ARBitrary:STAT ON
SOURce:BB:ARBitrary:TRIGger:EXEC
```

Example: Configuring the output order of the segments

The following example lists the commands necessary to trigger the output of the segments in desired playback order. The example lists only the relevant commands.

We assume, that the multi-segment sequence `ms_0to3` composed of four segments, `Seg_0`, `Seg_1`, `Seg_2` and `Seg_3` is created and loaded in the ARB (see [Example "Creating a multi-segment waveform"](#) on page 691). The required output order of the segments is `Seg_0`, `Seg_3 [2]`, `Seg_2`.

```
// *****
// Select a multi segment waveform
// *****
MMEM:CDIR "/var/user/ARB/multi_segment"
SOURce:BB:ARBitrary:WSEGment:CONFigure:CATalog?
// config
SOURce:BB:ARBitrary:WSEGment:CONFigure:SElect "config"
SOURce:BB:ARBitrary:WSEGment:CONFigure:OFIle?
// "/var/user/ARB/multi_segment/ms_0to3"
SOURce:BB:ARBitrary:WSEGment:CLOad "/var/user/ARB/multi_segment/config.inf_mswv"

// *****
// Adjust trigger settings and enable the ARB
```

```

// *****
SOURCE:BB:ARbitrary:TRIGger:SEQuence AAUTO
SOURCE:BB:ARbitrary:TRIGger:SOURce INTERNAL
SOURCE:BB:ARbitrary:STATe ON

// *****
// Select the next segment trigger mode and source
// *****
SOURCE:BB:ARbitrary:TRIGger:SMODE NEXT
// SOURCE:BB:ARbitrary:TRIGger:SMODE NSEam
SOURCE:BB:ARbitrary:WSEgment:NEXT:SOURce INTERNAL

SOURCE:BB:ARbitrary:WSEgment?
// 0
SOURCE:BB:ARbitrary:WSEgment:NAME?
// "/var/user/ARB/multi_segment/Seg_0.wv"
// Seg_0 is output continuously

// *****
// Trigger a switch over to the next segment
// *****
SOURCE:BB:ARbitrary:WSEgment:NEXT 3
// stops Seg_0 and starts immediatly Seg_3; Seg_3 is output continuously
SOURCE:BB:ARbitrary:TRIGger:EXECute
//restarts Seg_3
SOURCE:BB:ARbitrary:WSEgment:NEXT 2
SOURCE:BB:ARbitrary:WSEgment:NEXT 0

// *****
// Scrolling trough the segments, i.e. shwitch over in incremental order
// *****
SOURCE:BB:ARbitrary:WSEgment:NEXT:EXECute
SOURCE:BB:ARbitrary:WSEgment?
// 1
SOURCE:BB:ARbitrary:WSEgment:NEXT:EXECute
SOURCE:BB:ARbitrary:WSEgment?
// 2

```



Refer to ["To apply a manual segment switch to the output segments in the required order"](#) on page 213 for description of the steps necessary to achieve a similar task via manual operation of the instrument.

Example: Using the ARB sequencer

The following example lists the commands necessary to configure a play list. The example lists only the relevant commands.

We assume, that the multi-segment sequence `ms_0to3` composed of four segments, `Seg_0`, `Seg_1`, `Seg_2` and `Seg_3` is created and loaded in the ARB (see [Example "Creating a multi-segment waveform"](#) on page 691). The required output order of the segments is `Seg_0`, `Seg_3 [2]`, `Seg_2`.



The ARB Sequencer mode requires waveform files with equal clock rate.

```
// *****
// Select a multi segment waveform composed from waveforms with equal clock rates
// *****
MME:CDIR "/var/user/ARB/multi_segment"
SOURce:BB:ARBitrary:WSEgment:CONFigure:CATalog?
// config
SOURce:BB:ARBitrary:WSEgment:CONFigure:SElect "config"
SOURce:BB:ARBitrary:WSEgment:CLOad "/var/user/ARB/multi_segment/config.inf_mswv"
SOURce:BB:ARBitrary:WSEgment:CONFigure:OFILe?
// "/var/user/ARB/multi_segment/ms_0to3.wv"

// *****
// Select a sequencing list (*.wvs)
// *****
SOURce:BB:ARBitrary:WSEgment:SEquence:SElect "play_list"
SOURce:BB:ARBitrary:WSEgment:SEquence:APPend ON,0,1,NEXT
// adds the segment number 0 as a new (first) segment in the sequencing list
// this segment is activ and will be repeated once followed by the next segment
SOURce:BB:ARBitrary:WSEgment:SEquence:APPend ON,3,2,NEXT
SOURce:BB:ARBitrary:WSEgment:SEquence:APPend ON,2,1,SEG0

SOURce:BB:ARBitrary:TRIGger:SMODE SEQuencer
SOURce:BB:ARBitrary:TRIGger:SEquence AAUTO
SOURce:BB:ARBitrary:TRIGger:SOURce INTernal
SOURce:BB:ARBitrary:STAT ON
SOURce:BB:ARBitrary:TRIGger:EXEC
```



Refer to ["To apply a manual segment switch to the output segments in the required order"](#) on page 213 for description of the steps necessary to achieve a similar task via manual operation of the instrument.

Example: Adding extra marker signals

The following example lists the commands necessary to add two marker signals, a sequence restart marker and a segment restart marker, to the multi-segment sequence. The example lists only the relevant commands.

```
// *****
// Select the multi segment file and the corresponding configuration list
// *****
MME:CDIR "/var/lists/ARB/multi_segment"
SOURce:BB:ARBitrary:WSEgment:CONFigure:CATalog?
// Response: "config"
SOURce:BB:ARBitrary:WSEgment:CONFigure:SElect "config"
SOURce:BB:ARBitrary:WSEgment:CLOad "/var/user/ARB/multi_segment/config.inf_mswv"
```

```

SOURce:BB:ARbitrary:WSEgment:CONFigure:OFILe?
// "/var/user/ARB/multi_segment/ms_0to3.wv"

// *****
// Enable restart markers on marker trace 1 and 2
// *****
SOURce:BB:ARbitrary:WSEgment:CONFigure:MARKer:MODE IGNore
SOURce:BB:ARbitrary:WSEgment:CONFigure:MARKer:FSEgment MRK1
SOURce:BB:ARbitrary:WSEgment:CONFigure:MARKer:ESEgment MRK2

SOURce:BB:ARbitrary:TRIGger:OUTPut1:MODE UNCHanged
SOURce:BB:ARbitrary:TRIGger:OUTPut2:MODE UNCHanged

```

Example: Generating a multi carrier signal

The following example lists the commands necessary to generate a multi carrier signal.

```

// *****
// Generating a multi carrier signal
// *****
// Load a standardized 3GPP downlink test model, e.g. "Test Model 1 16 Channels"
SOURcel:BB:W3Gpp:SETTing:TMOdel:BSTation "Test_Model_1_16channels"
// Confirm that the standardized 3GPP downlink test model is currently selected
SOURcel:BB:W3Gpp:SETTing:TMOdel:BSTation?
// "Test_Model_1_16channels"
// Enable the generation of 3GPP FDD signal
SOURcel:BB:W3Gpp:STATe ON
// Generate a 3GPP FDD ARB waveform file with name "3gpp_arb"
// store the waveform in the default directory ("/var/user")
SOURcel:BB:W3Gpp:WAVEform:CREate "3gpp_arb"

// *****
// Configure a multi carrier scenario with 4 carriers
// and carrier spacing of 5 MHz
// Activate the carriers
// *****
SOURcel:BB:ARbitrary:MCARrier:CARRier:COUNT 4
SOURcel:BB:ARbitrary:MCARrier:CARRier:SPACing 5 MHz
SOURcel:BB:ARbitrary:MCARrier:CARRier1:STATe ON
SOURcel:BB:ARbitrary:MCARrier:CARRier2:STATe ON
SOURcel:BB:ARbitrary:MCARrier:CARRier3:STATe ON
SOURcel:BB:ARbitrary:MCARrier:CARRier4:STATe ON

// *****
// Select and load the waveform file "3gpp_arb" to all 4 carriers
// (the file "3gpp_arb" is in default directory)
// *****
SOURcel:BB:ARbitrary:MCARrier:CARRier1:FILE "3gpp_arb"
SOURcel:BB:ARbitrary:MCARrier:CARRier2:FILE "3gpp_arb"
SOURcel:BB:ARbitrary:MCARrier:CARRier3:FILE "3gpp_arb"
SOURcel:BB:ARbitrary:MCARrier:CARRier4:FILE "3gpp_arb"

```

```
// *****
// Trigger the signal caulation and load the waveform in the ARB generator
// *****
// Define the file name of the multi carrier output file, e.g. "3gpp_mc"
SOURcel:BB:ARBitrary:MCARrier:OFILe "3gpp_mc"
// Create and load the multi carrier waveform file in the ARB generator
SOURcel:BB:ARBitrary:MCARrier:CLoad
// Alternatively: create the multi carrier waveform and
// load it subsequently in the ARB generator
// SOURcel:BB:ARBitrary:MCARrier:CREate
// SOURcel:BB:ARBitrary:WAVEform:SELEct"3gpp_mc"

// Activate the ARB generator
SOURcel:BB:ARBitrary:STATe ON

// *****
// Use the save/recall function.
// *****
// Query available settings files in a specified directory
MMEM:CDIR "/var/user/waveform"
SOURcel:BB:ARBitrary:MCARrier:SETTing:CATalog?
// mcar1, mcar2
// the directory contains the settings files mcar1.arb_multcarr and mcar2.arb_multcarr
SOURcel:BB:ARBitrary:MCARrier:SETTing:STORe "3gpp_mc"
```

General commands

[[:SOURce<hw>]:BB:ARBitrary:PRESet

Sets all ARB generator parameters to their default values.

Example: See ["Programming examples"](#) on page 688

Usage: Event

Manual operation: See ["Set To Default"](#) on page 145

[[:SOURce<hw>]:BB:ARBitrary:STATe <State>

Enables the ARB generator.

A waveform must be selected before the ARB generator is activated.

Parameters:

<State> 1 | ON | 0 | OFF
 *RST: 0

Example: See ["Programming examples"](#) on page 688

Manual operation: See ["State"](#) on page 144

Test signal commands

<code>[:SOURce<hw>]:BB:ARbitrary:SIGnal:TYPE</code>	697
<code>[:SOURce<hw>]:BB:ARbitrary:TSIGnal:CIQ:I</code>	697
<code>[:SOURce<hw>]:BB:ARbitrary:TSIGnal:CIQ:Q</code>	697
<code>[:SOURce<hw>]:BB:ARbitrary:TSIGnal:RECTangle:AMPLitude</code>	697
<code>[:SOURce<hw>]:BB:ARbitrary:TSIGnal:RECTangle:FREQuency</code>	698
<code>[:SOURce<hw>]:BB:ARbitrary:TSIGnal:RECTangle:OFFSet</code>	698
<code>[:SOURce<hw>]:BB:ARbitrary:TSIGnal:RECTangle:SAMPles</code>	698
<code>[:SOURce<hw>]:BB:ARbitrary:TSIGnal:SINE:FREQuency</code>	699
<code>[:SOURce<hw>]:BB:ARbitrary:TSIGnal:SINE:PHASe</code>	699
<code>[:SOURce<hw>]:BB:ARbitrary:TSIGnal:SINE:SAMPles</code>	699
<code>[:SOURce<hw>]:BB:ARbitrary:TSIGnal:CIQ:CREate:NAMed</code>	700
<code>[:SOURce<hw>]:BB:ARbitrary:TSIGnal:RECTangle:CREate:NAMed</code>	700
<code>[:SOURce<hw>]:BB:ARbitrary:TSIGnal:SINE:CREate:NAMed</code>	700
<code>[:SOURce<hw>]:BB:ARbitrary:TSIGnal:CIQ:CREate</code>	700
<code>[:SOURce<hw>]:BB:ARbitrary:TSIGnal:RECTangle:CREate</code>	700
<code>[:SOURce<hw>]:BB:ARbitrary:TSIGnal:SINE:CREate</code>	700

`[:SOURce<hw>]:BB:ARbitrary:SIGnal:TYPE` <ArbSignalType>

Selects the type of test signal.

Parameters:

<ArbSignalType> SINE | RECT | CIQ
*RST: SINE

Example: See [Example "Creating test signals"](#) on page 688.

Manual operation: See ["Test Signal Form"](#) on page 147

`[:SOURce<hw>]:BB:ARbitrary:TSIGnal:CIQ:I` <I>

`[:SOURce<hw>]:BB:ARbitrary:TSIGnal:CIQ:Q` <TSig>

Sets the value for the I and Q component of the test signal

Parameters:

<TSig> float
Range: -1 to 1
Increment: 0.001
*RST: 0
Default unit: FS

Example: See [Example "Creating test signals"](#) on page 688

Manual operation: See ["I Value, Q Value"](#) on page 150

`[:SOURce<hw>]:BB:ARbitrary:TSIGnal:RECTangle:AMPLitude` <Amplitude>

Sets the digital amplitude of the rectangular wave.

Parameters:

<Amplitude> float
 Range: 0 to 1
 Increment: 0.001
 *RST: 0.800
 Default unit: FS

Example: see [Example"Creating test signals"](#) on page 688

Manual operation: See ["Amplitude"](#) on page 149

[:SOURce<hw>]:BB:ARbitrary:TSIGnal:RECTangle:FREQuency <Frequency>

Sets the frequency of the test signal.

Parameters:

<Frequency> float
 Range: 100 to depends on the installed options
 Increment: 0.01
 *RST: 1000
 Default unit: Hz

Example: See [Example"Creating test signals"](#) on page 688.

Manual operation: See ["Frequency"](#) on page 149

[:SOURce<hw>]:BB:ARbitrary:TSIGnal:RECTangle:OFFSet <Offset>

Sets the DC component.

Parameters:

<Offset> float
 Range: -1 to 1
 Increment: 0.001
 *RST: 0
 Default unit: FS

Example: see [Example"Creating test signals"](#) on page 688

Manual operation: See ["Offset DC"](#) on page 150

[:SOURce<hw>]:BB:ARbitrary:TSIGnal:RECTangle:SAMPles <Samples>

Sets the number of sample values required for the rectangular signal per period.

Parameters:

<Samples> integer
 Range: 4 to 1000
 *RST: 100

Example: See [Example"Creating test signals"](#) on page 688

Manual operation: See ["Samples per Period"](#) on page 149

[[:SOURce<hw>]:BB:ARbitrary:TSIGnal:SINE:FREQuency <Frequency>

Sets the frequency of the simple sinusoidal test signal.

Parameters:

<Frequency> float
 Range: 100 to depends on the installed options
 Increment: 0.01
 *RST: 1000
 Default unit: Hz

Example: See [Example"Creating test signals"](#) on page 688.

Manual operation: See ["Frequency"](#) on page 148

[[:SOURce<hw>]:BB:ARbitrary:TSIGnal:SINE:PHASe <Phase>

Sets the phase offset of the sine wave on the Q channel relative to the sine wave on the I channel.

Parameters:

<Phase> float
 Range: -180 to 180
 Increment: 0.01
 *RST: 90
 Default unit: DEG

Example: see [Example"Creating test signals"](#) on page 688

Manual operation: See ["Phase Offset Q"](#) on page 148

[[:SOURce<hw>]:BB:ARbitrary:TSIGnal:SINE:SAMPles <Samples>

Sets the sample rate for the sine signal in samples per period.

The resulting clock rate must not exceed the maximum ARB clock rate (see data sheet).

The maximum value is automatically restricted by reference to the set frequency and has to fulfill the rule $Frequency * Samples \leq ARB \text{ clock rate}$.

Parameters:

<Samples> integer
 Range: 4 to 1000
 *RST: 100

Example: see [Example"Creating test signals"](#) on page 688

Manual operation: See ["Samples per Period"](#) on page 148

```
[:SOURce<hw>]:BB:ARBitrary:TSIGnal:CIQ:CREate:NAMed <Filename>
[:SOURce<hw>]:BB:ARBitrary:TSIGnal:RECTangle:CREate:NAMed <Filename>
[:SOURce<hw>]:BB:ARBitrary:TSIGnal:SINE:CREate:NAMed <Filename>
```

Generates a signal and saves it to a waveform file.

Setting parameters:

<Filename> string

Example: See [Example "Creating test signals"](#) on page 688

Usage: Setting only

Manual operation: See ["Generate Signal File"](#) on page 148

```
[:SOURce<hw>]:BB:ARBitrary:TSIGnal:CIQ:CREate
[:SOURce<hw>]:BB:ARBitrary:TSIGnal:RECTangle:CREate
[:SOURce<hw>]:BB:ARBitrary:TSIGnal:SINE:CREate
```

Generates a signal and uses it as output straight away.

Example: see [Example "Creating test signals"](#) on page 688

Usage: Event

Manual operation: See ["Generate Signal RAM"](#) on page 148
See ["Generate Signal RAM"](#) on page 150

Waveform commands



The following rule applies for all commands described in this section.

By default, the waveform files are saved in the default directory of the instrument, that is the `/var/user/` directory or the directory specified with the command `:MMEMory:CDIRectory`. To access the waveform files in this default directory, only the file name is required, without the path and the file extension (`*.wv`).

However, to access waveform files located in a directory different to the default one, the complete file path and file name are required.

<code>[:SOURce<hw>]:BB:ARBitrary:WAVeform:CATalog?</code>	701
<code>[:SOURce<hw>]:BB:ARBitrary:WAVeform:CATalog:LENGth?</code>	701
<code>[:SOURce<hw>]:BB:ARBitrary:WAVeform:SELEct</code>	701
<code>[:SOURce<hw>]:BB:ARBitrary:WAVeform:DELEte</code>	701
<code>[:SOURce<hw>]:BB:ARBitrary:WAVeform:FREE?</code>	702
<code>[:SOURce<hw>]:BB:ARBitrary:WAVeform:POINts?</code>	702
<code>[:SOURce<hw>]:BB:ARBitrary:WAVeform:DATA</code>	702
<code>[:SOURce<hw>]:BB:ARBitrary:WAVeform:TAG?</code>	703
<code>[:SOURce<hw>]:BB:ARBitrary:CLOCK</code>	703
<code>[:SOURce<hw>]:BB:ARBitrary:WAVeform:HDDStreaming:STATe</code>	704
<code>[:SOURce<hw>]:BB:ARBitrary:WAVeform:CLOCK</code>	704

[:SOURce<hw>]:BB:ARBitrary:WAVeform:CATalog?

Reads out the files extension * .wv in the default directory.

Return values:

<Catalog> string
Returns a list of the file names separated by commas

Example: see [Example"Managing waveform files"](#) on page 689

Usage: Query only

[:SOURce<hw>]:BB:ARBitrary:WAVeform:CATalog:LENGth?

Reads out the files with extension * .wv in the default directory and returns the number of waveform files in this directory. The default directory is set using command `MMEM:CDIRectory`.

Return values:

<Length> integer
Number of waveform files in default directory
Range: 0 to INT_MAX
*RST: 0

Example: see [Example"Managing waveform files"](#) on page 689

Usage: Query only

[:SOURce<hw>]:BB:ARBitrary:WAVeform:SELEct <Filename>

Selects an existing waveform file, i.e. file with extension * .wv.

Parameters:

<Filename> string

Example: See [Example"Managing waveform files"](#) on page 689

Manual operation: See ["Load Waveform/File"](#) on page 145

[:SOURce<hw>]:BB:ARBitrary:WAVeform:DELEte <Filename>

Deletes the specified waveform file. If the file is not on the default path, the path must be specified at the same time. The file extension may be omitted. Only files with the file extension * .wv are deleted.

Setting parameters:

<Filename> string

Example: See [Example"Managing waveform files"](#) on page 689

Usage: Setting only

[[:SOURce<hw>]:BB:ARbitrary:WAVEform:FREE?

Queries the free disk space on the default path of the instrument's hard disk.

Return values:

<Free> integer
Range: 0 to INT_MAX
*RST: 1

Example: See [Example "Managing waveform files"](#) on page 689

Usage: Query only

[[:SOURce<hw>]:BB:ARbitrary:WAVEform:POINTS?

Queries the number of samples (the number of I/Q values pairs) in the selected waveform file.

Return values:

<Points> <waveform filename>
Range: 0 to 1000
*RST: 1

Example: see [Example "Managing waveform files"](#) on page 689

Usage: Query only

[[:SOURce<hw>]:BB:ARbitrary:WAVEform:DATA <Filename>, <Data>**[[:SOURce<hw>]:BB:ARbitrary:WAVEform:DATA? <Tag>**

The **setting** command writes the binary block data <data> to the file identified by <filename>. The *complete content* of the waveform file (i.e. including all tags) must be specified; the complete content is transmitted as binary data block.

Tip: To ensure trouble-free data transmission, set the GPIB delimiter to EOI.

The **query** command retrieves the content of the specified tag of the currently selected waveform file or the waveform file specified with the <filename>.

See also [Chapter 4.6.7, "Tags for waveforms, data and control lists"](#), on page 173.

Parameters:

<Filename> string
Specifies the name of the waveform file in that the binary data is copied

Setting parameters:

<Data> block data
Binary block data with the following syntax:
#<Digits><Length><Binary data>

Indicates the start of the binary block

<Digits>

Decimal value

Gives the number of decimal digits used for the <Length> value

<Length>

Decimal value

Number of bytes the follow in the <Binary data> part

<Binary data>

Binary data in ASCII format

Query parameters:

<Tag> 'comment' | 'copyright' | 'date' | 'lacfiter' | 'marker name' | 'poweroffset'

Example:**Query**See [Example "Managing waveform files"](#) on page 689**Example:****Setting**

```
SOURce:BB:ARB:WAVEform:DATA "/var/user/test1.wv",#220<binary data>
// Writes the binary block data <binary data> to file test1.wv
// <binary data> contains 20 bytes
// <binary data> is a placeholder;
// the actual ASCII values are not printable
```

[[:SOURce<hw>]:BB:ARbitrary:WAVEform:TAG?

Queries the content of the specified tag of the selected waveform file (see also [Chapter 4.6.7, "Tags for waveforms, data and control lists"](#), on page 173).

Return values:

<Tag> 'comment' | 'copyright' | 'date' | 'lacfiter' | 'marker name' | 'poweroffset' | 'samples'

Example:see [Example "Managing waveform files"](#) on page 689**Usage:**

Query only

[[:SOURce<hw>]:BB:ARbitrary:CLOCK <Clock>

Sets the clock frequency.

If you load a waveform, the clock rate is determined as defined with the waveform tag {**CLOCK: frequency**}. This command subsequently changes the clock rate; see data sheet for value range.

Parameters:

<Clock> float
 Range: depends on the installed options
 Increment: 0.001
 *RST: 1E6
 Default unit: Hz
 E.g. 400 Hz to 300 MHz

Example: See [Example "Managing waveform files"](#) on page 689.

Manual operation: See ["Clock Frequency"](#) on page 146

[:SOURce<hw>]:BB:ARbitrary:WAVEform:HDDStreaming:STATe <State>

By processing large files, enables the streaming of modulation data directly from the hard drive (HDD).

Parameters:

<State> 1 | ON | 0 | OFF
*RST: 0

Example: See [Example "Managing waveform files"](#) on page 689.

Manual operation: See ["HDD Streaming"](#) on page 146

[:SOURce<hw>]:BB:ARbitrary:WAVEform:CLOCK <Filename>, <Clock>

Appends information on the ARB clock rate to specified waveform file. The file must contain I/Q and/or marker data and have been created.

Parameters:

<Filename> string
Complete file path and file name with file extension (* .wv).
If the file is in the default directory, the file path can be omitted.

Setting parameters:

<Clock> float
Range: 400 to 100E6
Increment: 1E-3
*RST: 1E6

Multi-segment commands

Required options

See [Chapter 4.8.1, "Required options"](#), on page 191.

[:SOURce<hw>]:BB:ARbitrary:WSEGment?	705
[:SOURce<hw>]:BB:ARbitrary:WSEGment:NAME?	705
[:SOURce<hw>]:BB:ARbitrary:WSEGment:NEXT	705
[:SOURce<hw>]:BB:ARbitrary:WSEGment:NEXT:EXECute	705
[:SOURce<hw>]:BB:ARbitrary:WSEGment:NEXT:SOURce	706
[:SOURce<hw>]:BB:ARbitrary:WSEGment:LMODe	706
[:SOURce<hw>]:BB:ARbitrary:WSEGment:CONFigure:SEGMENT:CATalog?	706
[:SOURce<hw>]:BB:ARbitrary:WSEGment:SEQuence:SElect	706
[:SOURce<hw>]:BB:ARbitrary:WSEGment:SEQuence:APPend	707
[:SOURce<hw>]:BB:ARbitrary:WSEGment:CREate	707
[:SOURce<hw>]:BB:ARbitrary:WSEGment:CLOad	708
[:SOURce<hw>]:BB:ARbitrary:WSEGment:CONFigure:MARKer:MODE	708

[:SOURce<hw>]:BB:ARbitrary:WSEgment:CONFigure:MARKer:ESEgment.....	708
[:SOURce<hw>]:BB:ARbitrary:WSEgment:CONFigure:MARKer:FSEgment.....	708
[:SOURce<hw>]:BB:ARbitrary:TRIGger:SMODE.....	708

[:SOURce<hw>]:BB:ARbitrary:WSEgment?

Queries the index of the currently processed segment.

Return values:

<WSegment> integer
 Range: 0 to 1023
 *RST: 0

Example: see [Example"Configuring the output order of the segments"](#)
 on page 692

Usage: Query only

Manual operation: See ["Current Segment/Current Segment Index"](#) on page 209

[:SOURce<hw>]:BB:ARbitrary:WSEgment:NAME?

Queries the name of the waveform of the currently output segment of the multi-segment waveform.

Return values:

<Name> string

Example: See [Example"Configuring the output order of the segments"](#)
 on page 692

Usage: Query only

Manual operation: See ["Current Segment/Current Segment Index"](#) on page 209

[:SOURce<hw>]:BB:ARbitrary:WSEgment:NEXT <Next>

Selects the segment to be output.

Parameters:

<Next> integer
 Range: 0 to 1023
 *RST: 0

Example: see [Example"Configuring the output order of the segments"](#)
 on page 692

Manual operation: See ["Segment"](#) on page 209

[:SOURce<hw>]:BB:ARbitrary:WSEgment:NEXT:EXECute

Triggers manually switchover to the subsequent segment in the multi-segment file.

This command is disabled, if a sequencing play list is enabled.

Example: See [Example "Configuring the output order of the segments"](#) on page 692

Usage: Event

Manual operation: See ["Execute Next Segment"](#) on page 211

[:SOURce<hw>]:BB:ARBitrary:WSEgment:NEXT:SOURce <Source>

Selects the next segment source.

Parameters:

<Source> INTERNAL | NSEGM1 | INTERNAL | NSEGM1
*RST: INTERNAL

Example: See [Example "Configuring the output order of the segments"](#) on page 692.

Manual operation: See ["Next Segment Source"](#) on page 211

[:SOURce<hw>]:BB:ARBitrary:WSEgment:LMODe <LevelMode>

Sets how the segments are leveled.

Parameters:

<LevelMode> HIGHEst | UNCHanged
*RST: HIGHEst

Example: :SOURce1:BB:ARBitrary:WSEgment:LMODe HIGHEst

Manual operation: See ["Level Mode"](#) on page 211

[:SOURce<hw>]:BB:ARBitrary:WSEgment:CONFigure:SEGMent:CATalog?

Queries the segments of the currently selected configuration file.

Return values:

<Catalog> string

Example: See [Example "Creating a multi-segment waveform"](#) on page 691.

Usage: Query only

Manual operation: See ["Segment Table"](#) on page 200

[:SOURce<hw>]:BB:ARBitrary:WSEgment:SEQuence:SElect <Filename>

Selects the sequencing list (files with extension *.wvs)

Parameters:

<Filename> string

Example: see [Example "Using the ARB sequencer"](#) on page 693

Manual operation: See ["New/Load Sequencing List"](#) on page 206
 See ["Append"](#) on page 208
 See ["Sequencing List"](#) on page 211

[:SOURce<hw>]:BB:ARbitrary:WSEgment:SEquence:APPend <State>, <Segment>, <Count>, <Next>

Appends a new segment to the selected sequencing play list.

Setting parameters:

<State> ON | OFF
 Activates/deactivates the appended segment
 *RST: ON

<Segment> integer
 Indicates the number of the segment as in the multi-segment waveform file
 Range: 0 to SegmentCount - 1

<Count> integer
 Defines how many times this segment is repeated
 Range: 1 to 1048575

<Next> NEXT | BLANK | ENDLess | SEG0 | SEG1 | ... | SEG31 | 0...maxSegment
 Determines the action after completing the current segment, like for instance which segment is processed after the processing of the current one is finished.

Example: See [Example"Using the ARB sequencer"](#) on page 693

Usage: Setting only

Manual operation: See ["Append"](#) on page 208

[:SOURce<hw>]:BB:ARbitrary:WSEgment:CREate <FilenameInput>

Creates a multi-segment waveform (*.wv) using the current settings of the specified *configuration file* (*.inf_mswv).

Setting parameters:

<FilenameInput> Complete file path, file name of the configuration file and file extension (*.inf_mswv)

Example: See [Example"Creating a multi-segment waveform"](#) on page 691

Usage: Setting only

Manual operation: See ["Create/Create and Load"](#) on page 199

[:SOURce<hw>] :BB:ARbitrary:WSEgment:CLOad <FilenameInput>

Creates a multi-segment waveform using the current entries of the specified *configuration file* (*.inf_mswv).

The ARB generator is activated, the new multi-segment waveform (*.wv) is loaded and the first segment is output in accordance to the trigger settings.

Setting parameters:

<FilenameInput> string
 Complete file path, file name of the configuration file and file extension (*.inf_mswv)

Example: See [Example"Creating a multi-segment waveform"](#) on page 691

Usage: Setting only

Manual operation: See ["Create/Create and Load"](#) on page 199

[:SOURce<hw>] :BB:ARbitrary:WSEgment:CONFigure:MARKer:MODE <Mode>

Defines the way the marker information within the separate segments is processed.

Parameters:

<Mode> IGNore | TAKE
 *RST: TAKE

Example: see [Example"Adding extra marker signals"](#) on page 694

Manual operation: See ["Segment Marker"](#) on page 203

[:SOURce<hw>] :BB:ARbitrary:WSEgment:CONFigure:MARKer:ESEgment <Mode>

[:SOURce<hw>] :BB:ARbitrary:WSEgment:CONFigure:MARKer:FSEgment <Mode>

Enables/disables the generation of an additional marker restart signal at the beginning of the first segment (FSEgment) or at the beginning of each segment (ESEgment).

If additional marker generation is enabled, the existing marker signals in the individual segment waveform files are not considered.

Parameters:

<Mode> OFF | MRK1 | MRK2 | MRK3 | MRK4
 *RST: OFF

Example: see [Example"Adding extra marker signals"](#) on page 694

Manual operation: See ["Sequence Restart"](#) on page 204

[:SOURce<hw>] :BB:ARbitrary:TRIGger:SMODE <SMODE>

Selects the extended trigger mode for multi segment waveforms.

Parameters:

<SMode> SAME | NEXT | SEQuencer | NSEam
 NSEam = Next Segment Seamless
 *RST: NEXT

Example: See [Example "Configuring the output order of the segments"](#) on page 692.

Manual operation: See ["Next Segment Mode"](#) on page 210

Multi-segment sequencing commands**Required options**

See [Chapter 4.8.1, "Required options"](#), on page 191.

[:SOURce<hw>]:BB:ARbitrary:WSEgment:CONFigure:BLANK:APPend	709
[:SOURce<hw>]:BB:ARbitrary:WSEgment:CONFigure:CATalog?	710
[:SOURce<hw>]:BB:ARbitrary:WSEgment:CONFigure:CLOCK	710
[:SOURce<hw>]:BB:ARbitrary:WSEgment:CONFigure:CLOCK:MODE	710
[:SOURce<hw>]:BB:ARbitrary:WSEgment:CONFigure:LEVel[:MODE]	710
[:SOURce<hw>]:BB:ARbitrary:WSEgment:CONFigure:COMMeNt	711
[:SOURce<hw>]:BB:ARbitrary:WSEgment:CONFigure:DELeTe	711
[:SOURce<hw>]:BB:ARbitrary:WSEgment:CONFigure:OFILe	711
[:SOURce<hw>]:BB:ARbitrary:WSEgment:CONFigure:SEGMeNt:APPend	711
[:SOURce<hw>]:BB:ARbitrary:WSEgment:CONFigure:SELeCt	711

[\[:SOURce<hw>\]:BB:ARbitrary:WSEgment:CONFigure:BLANK:APPend](#)
 <SampCount>, <Frequency>

Adds a blank segment to the multi-segment file.

Setting parameters:

<SampCount> float
 Specifies the number of samples.
 Range: 512 to 1E7
 Increment: 1
 *RST: 1000

<Frequency> float
 Determines the clock rate.
 Range: 400 Hz to depends on the installed options
 Increment: 0.001
 *RST: 1E8

Example: See [Example "Creating a multi-segment waveform"](#) on page 691

Usage: Setting only

Manual operation: See ["Blank Segment"](#) on page 201

[:SOURce<hw>]:BB:ARbitrary:WSEgment:CONFigure:CATalog?

Queries the available configuration files in the default directory. See also [Chapter 4.8.2.3, "File concept"](#), on page 192.

Return values:

<Catalog> string

Example: see [Example "Creating a multi-segment waveform"](#) on page 691

Usage: Query only

Manual operation: See ["Load List"](#) on page 198

[:SOURce<hw>]:BB:ARbitrary:WSEgment:CONFigure:CLOCK <Clock>

Defines the clock rate used for multi-segment waveform output if the clock mode is USER.

Parameters:

<Clock> float
 Increment: 1E-3
 *RST: max SampleRate

Example: See [Example "Creating a multi-segment waveform"](#) on page 691

Manual operation: See ["User Clock Rate"](#) on page 203

[:SOURce<hw>]:BB:ARbitrary:WSEgment:CONFigure:CLOCK:MODE <Mode>

Selects the clock rate mode for the multi segment waveform. Use the command [\[:SOURce<hw>\]:BB:ARbitrary:WSEgment:CONFigure:CLOCK](#) to define the clock in clock mode user.

Parameters:

<Mode> UNCHanged | HIGHest | USER
 *RST: UNCHanged

Example: See [Example "Creating a multi-segment waveform"](#) on page 691.

Manual operation: See ["Clock"](#) on page 203

[:SOURce<hw>]:BB:ARbitrary:WSEgment:CONFigure:LEVel[:MODE] <Mode>

Selects the level mode, unchanged or equal RMS, for the multi-segment waveform.

Parameters:

<Mode> UNCHanged | ERMS
 *RST: UNCHanged

Example: See [Example "Creating a multi-segment waveform"](#) on page 691.

Manual operation: See ["Level"](#) on page 202

[:SOURce<hw>]:BB:ARbitrary:WSEgment:CONFigure:COMment <Comment>

Enters a comment for the selected configuration file.

Parameters:

<Comment> string

Example: See [Example"Creating a multi-segment waveform"](#) on page 691

Manual operation: See ["Comment"](#) on page 199

[:SOURce<hw>]:BB:ARbitrary:WSEgment:CONFigure:DELeTe <Filename>

Deletes the selected configuration file.

Setting parameters:

<Filename> string

Example: See [Example"Creating a multi-segment waveform"](#) on page 691.

Usage: Setting only

Manual operation: See ["Append/Delete/Shift Seg. Up/Down"](#) on page 201

[:SOURce<hw>]:BB:ARbitrary:WSEgment:CONFigure:OFILe <OFile>

Defines the file name of the output multi-segment waveform.

Parameters:

<OFile> string

Example: See [Example"Creating a multi-segment waveform"](#) on page 691

Manual operation: See ["Output file"](#) on page 199
See ["Create/Create and Load"](#) on page 199

**[:SOURce<hw>]:BB:ARbitrary:WSEgment:CONFigure:SEGment:APPend
<Waveform>**

Appends the specified waveform to the configuration file.

Setting parameters:

<Waveform> string

Example: see [Example"Creating a multi-segment waveform"](#) on page 691

Usage: Setting only

Manual operation: See ["Append/Delete/Shift Seg. Up/Down"](#) on page 201

[:SOURce<hw>]:BB:ARbitrary:WSEgment:CONFigure:SELEct <Filename>

Selects a configuration file from the default directory. If a configuration file with the specified name does not yet exist, it is created. The file extension `*.inf_mswv` may be omitted.

Parameters:

<Filename> string

Example: see [Example "Creating a multi-segment waveform"](#) on page 691**Manual operation:** See ["New List"](#) on page 198
See ["Load List"](#) on page 198**Multi-carrier commands****Required options**See [Chapter 4.9.1, "Required options"](#), on page 221.**Suffixes**

Suffix	Value range
CARRier<ch>	1 to 512

[:SOURce<hw>]:BB:ARBitrary:MCARrier:PRESet.....	713
[:SOURce<hw>]:BB:ARBitrary:MCARrier:SETTing:CATalog?.....	713
[:SOURce<hw>]:BB:ARBitrary:MCARrier:SETTing:LOAD.....	713
[:SOURce<hw>]:BB:ARBitrary:MCARrier:SETTing:STORE.....	713
[:SOURce<hw>]:BB:ARBitrary:MCARrier:CARRier:COUNT.....	714
[:SOURce<hw>]:BB:ARBitrary:MCARrier:CARRier:MODE.....	714
[:SOURce<hw>]:BB:ARBitrary:MCARrier:CARRier:SPACing.....	714
[:SOURce<hw>]:BB:ARBitrary:MCARrier:SAMPles?.....	715
[:SOURce<hw>]:BB:ARBitrary:MCARrier:TIME.....	715
[:SOURce<hw>]:BB:ARBitrary:MCARrier:CFACTOR:MODE.....	715
[:SOURce<hw>]:BB:ARBitrary:MCARrier:CLIPping:CFACTOR.....	715
[:SOURce<hw>]:BB:ARBitrary:MCARrier:CLIPping:CUToff.....	716
[:SOURce<hw>]:BB:ARBitrary:MCARrier:CLIPping[STATE].....	716
[:SOURce<hw>]:BB:ARBitrary:MCARrier:TIME:MODE.....	716
[:SOURce<hw>]:BB:ARBitrary:MCARrier:POWER:REFerence.....	717
[:SOURce<hw>]:BB:ARBitrary:MCARrier:OFILe.....	717
[:SOURce<hw>]:BB:ARBitrary:MCARrier:CLOad.....	717
[:SOURce<hw>]:BB:ARBitrary:MCARrier:CLOCK?.....	718
[:SOURce<hw>]:BB:ARBitrary:MCARrier:CREate.....	718
[:SOURce<hw>]:BB:ARBitrary:MCARrier:CARRier<ch>:STATe.....	718
[:SOURce<hw>]:BB:ARBitrary:MCARrier:CARRier<ch>:FREQuency.....	718
[:SOURce<hw>]:BB:ARBitrary:MCARrier:CARRier<ch>:PHASe.....	719
[:SOURce<hw>]:BB:ARBitrary:MCARrier:CARRier<ch>:POWER.....	719
[:SOURce<hw>]:BB:ARBitrary:MCARrier:CARRier<ch>:DELay.....	719
[:SOURce<hw>]:BB:ARBitrary:MCARrier:CARRier<ch>:FILE.....	720
[:SOURce<hw>]:BB:ARBitrary:MCARrier:CARRier<ch>:CONFLict?.....	720
[:SOURce<hw>]:BB:ARBitrary:MCARrier:EDIT:CARRier:STATe.....	720
[:SOURce<hw>]:BB:ARBitrary:MCARrier:EDIT:CARRier:START.....	720
[:SOURce<hw>]:BB:ARBitrary:MCARrier:EDIT:CARRier:STOP.....	720
[:SOURce<hw>]:BB:ARBitrary:MCARrier:EDIT:CARRier:POWER:STEP.....	721
[:SOURce<hw>]:BB:ARBitrary:MCARrier:EDIT:CARRier:POWER[START].....	721

<code>[:SOURce<hw>]:BB:ARbitrary:MCARrier:EDIT:CARRier:PHASe:STEP</code>	721
<code>[:SOURce<hw>]:BB:ARbitrary:MCARrier:EDIT:CARRier:PHASe[:START]</code>	722
<code>[:SOURce<hw>]:BB:ARbitrary:MCARrier:EDIT:CARRier:DELay:STEP</code>	722
<code>[:SOURce<hw>]:BB:ARbitrary:MCARrier:EDIT:CARRier:DELay[:START]</code>	723
<code>[:SOURce<hw>]:BB:ARbitrary:MCARrier:EDIT:CARRier:FILE</code>	723
<code>[:SOURce<hw>]:BB:ARbitrary:MCARrier:EDIT:CARRier:EXECute</code>	723

`[:SOURce<hw>]:BB:ARbitrary:MCARrier:PRESet`

Sets all the multi-carrier parameters to their default values.

Example: `SOURce1:BB:ARbitrary:MCARrier:PRESet`

Usage: Event

Manual operation: See ["Set to Default"](#) on page 224

`[:SOURce<hw>]:BB:ARbitrary:MCARrier:SETTING:CATalog?`

Queries the available settings files in the specified default directory. Only files with the file extension `*.arb_multcarr` are listed.

Return values:

<Catalog> string

Example: See [Example "Generating a multi carrier signal"](#) on page 695

Usage: Query only

Manual operation: See ["Save/Recall Frame"](#) on page 225

`[:SOURce<hw>]:BB:ARbitrary:MCARrier:SETTING:LOAD <Filename>`

Loads the selected file from the default or the specified directory. Loaded are files with extension `*.arb_multcarr`.

Setting parameters:

<Filename> "<filename>"

Filename or complete file path; file extension can be omitted

Example: See [Example "Generating a multi carrier signal"](#) on page 695.

Usage: Setting only

Manual operation: See ["Save/Recall Frame"](#) on page 225

`[:SOURce<hw>]:BB:ARbitrary:MCARrier:SETTING:STORe <Filename>`

Stores the current settings into the selected file; the file extension (`*.arb_multcarr`) is assigned automatically.

Setting parameters:

<Filename> string

Filename or complete file path

Example: See [Example "Generating a multi carrier signal"](#) on page 695

Usage: Setting only

Manual operation: See ["Save/Recall Frame"](#) on page 225

[:SOURce<hw>] :BB:ARBitrary:MCARrier:CARRier:COUNT <Count>

Sets the number of carriers in the ARB multi-carrier waveform.

Parameters:

<Count> integer
 Range: 1 to 512
 *RST: 1

Example: See [Example "Generating a multi carrier signal"](#) on page 695

Manual operation: See ["Number of Carriers"](#) on page 225
 See ["Number of Carriers"](#) on page 231

[:SOURce<hw>] :BB:ARBitrary:MCARrier:CARRier:MODE <Mode>

The command sets the carrier frequency mode.

Parameters:

<Mode> EQUidistant | ARBitrary
 *RST: EQUidistant

Example: BB:ARB:MCAR:CARR:MODE EQU
 Sets an equidistant carrier spacing. The carrier frequency cannot be set.

Manual operation: See ["Mode"](#) on page 225

[:SOURce<hw>] :BB:ARBitrary:MCARrier:CARRier:SPACing <Spacing>

Sets the frequency spacing between adjacent carriers of the multi-carrier waveform (see [Chapter 4.9.2.1, "Defining the carrier frequency"](#), on page 222).

Parameters:

<Spacing> float
 Range: 0.0 to depends on the installed options, e.g. 120E6
 Increment: 0.01
 *RST: 0
 Default unit: Hz

Example: See [Example "Generating a multi carrier signal"](#) on page 695

Manual operation: See ["Carrier Spacing"](#) on page 226

[[:SOURce<hw>]:BB:ARbitrary:MCARrier:SAMPles?

Queries the resulting file size.

Return values:

<Samples> integer
Range: 0 to INT_MAX
*RST: 0
Default unit: samples

Example: SOURce1:BB:ARbitrary:MCARrier:SAMPles?
Queries the file size of the currently calculated multi-carrier waveform.

Usage: Query only

Manual operation: See "[File Size](#)" on page 229

[[:SOURce<hw>]:BB:ARbitrary:MCARrier:TIME <Time>

Sets the user-defined signal period.

Parameters:

<Time> float
Range: 0 to 1E9
Increment: 1E-9
*RST: 0
Default unit: s

Example: SOURce1:BB:ARbitrary:MCARrier:MODE USER
Selects signal period mode user.
SOURce1:BB:ARbitrary:MCARrier:TIME 10
Sets a signal period of 10 seconds

Manual operation: See "[Signal Period](#)" on page 227

[[:SOURce<hw>]:BB:ARbitrary:MCARrier:CFACTOR:MODE <Mode>

Sets the mode for optimizing the crest factor by calculating the carrier phases.

Parameters:

<Mode> OFF | MIN | MAX
*RST: OFF

Example: SOURce1:BB:ARbitrary:MCARrier:CFACTOR:MODE OFF
Switches off automatic crest factor optimization.

Manual operation: See "[Crest Factor Mode](#)" on page 226

[[:SOURce<hw>]:BB:ARbitrary:MCARrier:CLIPping:CFACTOR <CFactor>

Sets the value of the desired crest factor, if baseband clipping is enabled.

A target crest factor above the crest factor of the unclipped multicarrier signal has no effect.

Parameters:

<CFactor> float
 Range: -50 to 50
 Increment: 0.01
 *RST: 50
 Default unit: dB

Example: See `[:SOURce<hw>] :BB:ARbitrary:MCARrier:CLIPping[:STATe]` on page 716.

Manual operation: See "Target Crest Factor" on page 226

[:SOURce<hw>] :BB:ARbitrary:MCARrier:CLIPping:CUToff <Cutoff>

Sets the cutoff frequency of the final low pass filter, if baseband clipping is enabled.

Parameters:

<Cutoff> float
 Range: 0 to 250E6
 Increment: 0.01
 *RST: 75E6

Example: See `[:SOURce<hw>] :BB:ARbitrary:MCARrier:CLIPping[:STATe]` on page 716.

Manual operation: See "Filter Cutoff Frequency" on page 226

[:SOURce<hw>] :BB:ARbitrary:MCARrier:CLIPping[:STATe] <State>

Switches baseband clipping on and off.

Parameters:

<State> 1 | ON | 0 | OFF
 *RST: 0

Example:
`SOURce1:BB:ARbitrary:MCARrier:CLIPping:STATe ON`
`SOURce1:BB:ARbitrary:MCARrier:CLIPping:CFACtor 37`
`SOURce1:BB:ARbitrary:MCARrier:CLIPping:CUToff 50`

Manual operation: See "Clipping" on page 226

[:SOURce<hw>] :BB:ARbitrary:MCARrier:TIME:MODE <Mode>

Selects the mode for calculating the resulting signal period of the multi-carrier waveform. The resulting period is always calculated for all carriers in the carrier table irrespective of their state (ON/OFF).

Parameters:

<Mode> USER | LONG | SHORT | LCM
 *RST: LONG

Example:

BB:ARB:MCAR:TIME:MODE LONG

The resulting signal period is defined by the longest I/Q file in the carrier table. Shorter I/Q files are periodically repeated.

Manual operation: See ["Signal Period Mode"](#) on page 227

[:SOURce<hw>]:BB:ARbitrary:MCARrier:POWer:REFEreNce <Reference>

Defines the way the individual carriers in a composed multi carrier signal are leveled.

Parameters:

<Reference> RMS | PEAK
 *RST: RMS

Manual operation: See ["Power Reference"](#) on page 227

[:SOURce<hw>]:BB:ARbitrary:MCARrier:OFILe <OFile>

Defines the output file name for the multi-carrier waveform (file extension *.wv).

This file name is required to calculate the waveform with the commands [\[:SOURce<hw>\]:BB:ARbitrary:MCARrier:CLoad](#) or [\[:SOURce<hw>\]:BB:ARbitrary:MCARrier:CREate](#).

Parameters:

<OFile> string

Example: See [Example "Generating a multi carrier signal"](#) on page 695

Manual operation: See ["Output File"](#) on page 229

[:SOURce<hw>]:BB:ARbitrary:MCARrier:CLoad

Creates a multi-carrier waveform using the current entries of the carrier table and activates the ARB generator.

Use the command [\[:SOURce<hw>\]:BB:ARbitrary:MCARrier:OFILe](#) to define the multi-carrier waveform file name. The file extension is *.wv.

Example: See [Example "Generating a multi carrier signal"](#) on page 695

Usage: Event

Manual operation: See ["Create/Create and Load"](#) on page 229

[:SOURce<hw>]:BB:ARbitrary:MCARrier:CLOCK?

Queries the resulting sample rate at which the multi-carrier waveform is output by the arbitrary waveform generator. The output clock rate depends on the number of carriers, carrier spacing, and input sample rate of the leftmost or rightmost carriers.

Return values:

<Clock> float
 Range: 400 to Max
 Increment: 1E-3

Example: BB:ARB:MCAR:CLOC?
 Queries the ARB multi-carrier output clock rate.

Usage: Query only

Manual operation: See ["Clock Rate"](#) on page 229

[:SOURce<hw>]:BB:ARbitrary:MCARrier:CREate

Creates a multi-carrier waveform using the current settings of the carrier table.

Use the command `[:SOURce<hw>]:BB:ARbitrary:MCARrier:OFILe` to define the multi-carrier waveform file name. The file extension is *.wv.

Example: See [Example "Generating a multi carrier signal"](#) on page 695

Usage: Event

Manual operation: See ["Create/Create and Load"](#) on page 229

[:SOURce<hw>]:BB:ARbitrary:MCARrier:CARRier<ch>:STATe <State>

Enables/diasbled the selected carrier.

Parameters:

<State> 1 | ON | 0 | OFF
 *RST: 0

Example: See [Example "Generating a multi carrier signal"](#) on page 695

Manual operation: See ["State"](#) on page 231

[:SOURce<hw>]:BB:ARbitrary:MCARrier:CARRier<ch>:FREQUency <Frequency>

Sets or indicates the carrier frequency, depending on the selected carrier frequency mode.

Parameters:

<Frequency> integer
 Range: depends on the installed options
 *RST: 0

Example: SOURce1:BB:ARbitrary:MCARrier:CARRier:MODE ARB
 SOURce1:BB:ARbitrary:MCARrier:CARRier1:
 FREQuency 5.0
 Sets 5.0 MHz carrier frequency.

Manual operation: See "[Carrier Freq \[MHz\]](#)" on page 231

[:SOURce<hw>]:BB:ARbitrary:MCARrier:CARRier<ch>:PHASe <Phase>

Sets the start phase of the selected carrier.

Parameters:

<Phase> float
 Range: 0 to 359.99
 Increment: 0.01
 *RST: 0
 Default unit: DEG

Example: SOURce1:BB:ARbitrary:MCARrier:CARRier19:PHASe
 90
 Sets a start phase.

Manual operation: See "[Phase](#)" on page 231

[:SOURce<hw>]:BB:ARbitrary:MCARrier:CARRier<ch>:POWER <Power>

Sets the gain of the selected carrier.

Parameters:

<Power> float
 Range: -80 to 0
 Increment: 0.01
 *RST: 0
 Default unit: dB

Example: SOURce1:BB:ARbitrary:MCARrier:CARRier15:POWER
 -50
 Sets the power of carrier 15 to -50 dB.

Manual operation: See "[Gain](#)" on page 231

[:SOURce<hw>]:BB:ARbitrary:MCARrier:CARRier<ch>:DELay <Delay>

Sets the start delay of the selected carrier.

Parameters:

<Delay> float
 Range: 0 to 1
 Increment: 1E-9
 *RST: 0
 Default unit: s

Example: `BB:ARB:MCAR:CARR15:DEL 5us`
sets a start delay of 50 us for carrier 15.

Manual operation: See ["Delay"](#) on page 231

[:SOURCE<hw>]:BB:ARbitrary:MCARrier:CARRier<ch>:FILE <File>

Selects the file with I/Q data to be modulated onto the selected carrier.

Parameters:

<File> <file name>

Example: See [Example "Generating a multi carrier signal"](#) on page 695

Manual operation: See ["File"](#) on page 232

[:SOURCE<hw>]:BB:ARbitrary:MCARrier:CARRier<ch>:CONFLICT?

Queries carrier conflicts. A conflict arises when the carriers overlap.

Return values:

<Conflict> 1 | ON | 0 | OFF

0

No conflict

*RST: 0

Example: `BB:ARB:MCAR:CARR:CONF?`

Usage: Query only

Manual operation: See ["!!!"](#) on page 232

[:SOURCE<hw>]:BB:ARbitrary:MCARrier:EDIT:CARRier:STATE <State>

Switches all the carriers in the selected carrier range on or off.

Parameters:

<State> 1 | ON | 0 | OFF

*RST: 1

Example: `BB:ARB:MCAR:EDIT:CARR:STAT ON`
Sets all the carriers in the carrier range to ON.

Manual operation: See ["Carrier State"](#) on page 233

[:SOURCE<hw>]:BB:ARbitrary:MCARrier:EDIT:CARRier:START <Start>

[:SOURCE<hw>]:BB:ARbitrary:MCARrier:EDIT:CARRier:STOP <Stop>

Selects the last carrier in the carrier range to which the settings shall apply.

Parameters:

<Stop> integer
 Range: 0 to 511
 *RST: 0

Example: BB:ARB:MCAR:EDIT:CARR:STOP 4
 The carrier range stops at carrier 4.

Manual operation: See "[Carrier Start/Start](#)" on page 233

[:SOURce<hw>]:BB:ARBitrary:MCARrier:EDIT:CARRier:POWer:STEP <Step>

Sets the step width by which the starting power of the carriers in the defined carrier range is incremented.

Parameters:

<Step> float
 Range: -80 to 80
 Increment: 0.01
 *RST: 0
 Default unit: dB

Example: BB:ARB:MCAR:EDIT:CARR:POW -80dB
 Sets a power of -80 dB for the carriers in the carrier range.
 BB:ARB:MCAR:EDIT:CARR:POW:STEP 1 dB
 The power is incremented by 1dB for each carrier.
 That is, the first carrier has -80 dB, the second -79 dB, and so on.

Manual operation: See "[Gain Step](#)" on page 233
 See "[Phase Step](#)" on page 234

[:SOURce<hw>]:BB:ARBitrary:MCARrier:EDIT:CARRier:POWer[:START] <Start>

Sets the power for the individual carriers in the defined carrier range.

Parameters:

<Start> float
 Range: -80 to 0
 Increment: 0.01
 *RST: 0
 Default unit: dB

Example: BB:ARB:MCAR:EDIT:CARR:POW -50 dB
 sets the power of the carriers in the carrier range to -50 dB.

Manual operation: See "[Gain Start](#)" on page 233

[:SOURce<hw>]:BB:ARBitrary:MCARrier:EDIT:CARRier:PHASe:STEP <Step>

Sets the step width by which the start phases of the carriers in the defined carrier range is incremented.

Parameters:

<Step> float
 Range: -359.99 to 359.99
 Increment: 0.01
 *RST: 0
 Default unit: DEG

Example:

```
BB:ARB:MCAR:EDIT:CARR:PHAS 90 DEG
```

Sets a start phase of 90° for the carriers in the carrier range.

```
BB:ARB:MCAR:EDIT:CARR:PHAS:STEP 1 DEG
```

The start phase is incremented by 1° for each carrier. That is, the first carrier has a start phase of 90°, the second a start phase of 91°, and so on.

```
[[:SOURCE<hw>]:BB:ARbitrary:MCARrier:EDIT:CARRier:PHASe[:START] <Start>
```

Sets the start phase for the individual carriers in the defined carrier range.

Parameters:

<Start> float
 Range: 0 to 359.99
 Increment: 0.01
 *RST: 0
 Default unit: DEG

Example:

```
BB:ARB:MCAR:EDIT:CARR:PHAS 90 DEG
```

sets a start phase of 90° for the carriers in the carrier range.

Manual operation: See "[Phase Start](#)" on page 233

```
[[:SOURCE<hw>]:BB:ARbitrary:MCARrier:EDIT:CARRier:DELay:STEP <Step>
```

Sets the step width by which the start delays of the carriers in the defined carrier range is incremented.

Parameters:

<Step> float
 Range: -1 to 1
 Increment: 1E-9
 *RST: 0
 Default unit: s

Example:

```
BB:ARB:MCAR:EDIT:CARR:DEL 5 us
```

Sets a start delay of 5 us for the carriers in the carrier range.

```
BB:ARB:MCAR:EDIT:CARR:DEL:STEP 1 us
```

The start delay is incremented by 1us for each carrier. That is, the first carrier has a start delay of 5 us, the second a start delay of 6 us, and so on.

Manual operation: See "[Delay Step](#)" on page 234

[[:SOURce<hw>]:BB:ARbitrary:MCARrier:EDIT:CARRier:DELay[:START] <Start>

Sets the start delay for the individual carriers in the defined carrier range.

Parameters:

<Start> float
 Range: 0 to 1
 Increment: 1E-9
 *RST: 0
 Default unit: s

Example: BB:ARB:MCAR:EDIT:CARR:DEL 5us
 Sets a start delay of 5 us for the carriers in the carrier range.

Manual operation: See "[Delay Start](#)" on page 234

[[:SOURce<hw>]:BB:ARbitrary:MCARrier:EDIT:CARRier:FILE <File>

Selects the input file. The data of the file are modulated onto the carriers in the defined carrier range.

Parameters:

<File> string

Example: BB:ARB:MCAR:EDIT:CARR:FILE
 "/var/user/temp/IQ_wcdma"
 selects input file IQ_wcdma.

Manual operation: See "[Input Waveform File](#)" on page 234

[[:SOURce<hw>]:BB:ARbitrary:MCARrier:EDIT:CARRier:EXECute

Adopts the settings for the selected carrier range.

Example: BB:ARB:MCAR:EDIT:CARR:STAR 4
 BB:ARB:MCAR:EDIT:CARR:STOP 20
 BB:ARB:MCAR:EDIT:CARR:STAT ON
 BB:ARB:MCAR:EDIT:CARR:EXEC

Usage: Event

Manual operation: See "[Apply Assistant Settings](#)" on page 234

Trigger commands

[:SOURce<hw>]:BB:ARbitrary[:TRIGger]:SEQuence.....	724
[:SOURce<hw>]:BB:ARbitrary:TRIGger:SOURce.....	724
[:SOURce<hw>]:BB:ARbitrary:TRIGger:RMODE?.....	724
[:SOURce<hw>]:BB:ARbitrary:TRIGger:SLENgth.....	724
[:SOURce<hw>]:BB:ARbitrary:TRIGger:SLUNit.....	725
[:SOURce<hw>]:BB:ARbitrary:TRIGger:ARM:EXECute.....	725
[:SOURce<hw>]:BB:ARbitrary:TRIGger:EXECute.....	725
[:SOURce<hw>]:BB:ARbitrary:TRIGger[:EXTernal]:SYNChronize:OUTPut.....	725

<code>[:SOURce<hw>]:BB:ARbitrary:TRIGger:PTIME?</code>	726
<code>[:SOURce<hw>]:BB:ARbitrary:TRIGger:DELAy:UNIT</code>	726
<code>[:SOURce<hw>]:BB:ARbitrary:TRIGger[:EXternal]:DELAy</code>	726
<code>[:SOURce<hw>]:BB:ARbitrary:TRIGger[:EXternal]:TDELAy</code>	727
<code>[:SOURce<hw>]:BB:ARbitrary:TRIGger[:EXternal]:RDELAy?</code>	727
<code>[:SOURce<hw>]:BB:ARbitrary:TRIGger[:EXternal]:INHibit</code>	727

`[:SOURce<hw>]:BB:ARbitrary[:TRIGger]:SEQUence <Sequence>`

The command selects the trigger mode.

Parameters:

<Sequence> AUTO | RETRigger | AAUTo | ARETrigger | SINGLE
 *RST: AUTO

Example: See [Example"Managing waveform files"](#) on page 689

Manual operation: See ["Mode"](#) on page 101

`[:SOURce<hw>]:BB:ARbitrary:TRIGger:SOURce <Source>`

Selects the trigger signal source and determines the way the triggering is executed. Provided are:

- Internal triggering by a command (INTernal)

Parameters:

<Source> INTernal|EXTernal
 *RST: INTernal

Example: See [Example"Managing waveform files"](#) on page 689

Manual operation: See ["Source"](#) on page 102

`[:SOURce<hw>]:BB:ARbitrary:TRIGger:RMODE?`

Queries the status of waveform output.

Return values:

<RMode> STOP | RUN

Example: see [Example"Managing waveform files"](#) on page 689

Usage: Query only

Manual operation: See ["Running/Stopped"](#) on page 102

`[:SOURce<hw>]:BB:ARbitrary:TRIGger:SLENgth <SLength>`

Defines the length of the signal sequence that is output in the SINGLE trigger mode.

Parameters:

<SLength> integer
 Maximum value depends on the selected units [:
[SOURce<hw>\]:BB:ARbitrary:TRIGger:SLUNit](#) as follows:
 SAMPLE: Max = $2^{32}-1$
 SEQUENCE: Max = 1000
 Range: 1 to dynamic
 *RST: 1

Example: See [Example "Managing waveform files"](#) on page 689

[:SOURce<hw>]:BB:ARbitrary:TRIGger:SLUNit <SLUnit>

Defines the unit for the entry of the length of the signal sequence to be output in the Single trigger mode.

Parameters:

<SLUnit> SEQUENCE | SAMPLE
 *RST: SEQUENCE

Example: See [Example "Managing waveform files"](#) on page 689

Manual operation: See ["Signal Duration"](#) on page 102

[:SOURce<hw>]:BB:ARbitrary:TRIGger:ARM:EXECute

Stops (arms) waveform output.

Example: See [Example "Managing waveform files"](#) on page 689

Usage: Event

Manual operation: See ["Arm"](#) on page 102

[:SOURce<hw>]:BB:ARbitrary:TRIGger:EXECute

Executes an internal trigger event.

Example: See [Example "Managing waveform files"](#) on page 689

Usage: Event

Manual operation: See ["Execute Trigger"](#) on page 102

**[:SOURce<hw>]:BB:ARbitrary:TRIGger[:EXTERNAL]:SYNChronize:OUTPut
<Output>**

Enables signal output synchronous to the trigger event.

Parameters:

<Output> 1 | ON | 0 | OFF
 *RST: 1

Example: See [Example"Managing waveform files"](#) on page 689

Manual operation: See "[Sync. Output to External Trigger/Sync. Output to Trigger](#)" on page 103

[:SOURce<hw>]:BB:ARbitrary:TRIGger:PTIME?

Queries the internal processing time.

The processing time is the elapsed time between the input of the external trigger event and the output of the baseband signal.

Return values:

<ArbTrigProcTime> string

Example: SOURce1:BB:ARbitrary:TRIGger:PTIME?
// Response: "210 µs"
The processing time is 210 µs.

Usage: Query only

Manual operation: See "[Processing Time](#)" on page 151

[:SOURce<hw>]:BB:ARbitrary:TRIGger:DElay:UNIT <TrigDelUnit>

Sets the units the trigger delay is expressed in.

Parameters:

<TrigDelUnit> SAMPLE | TIME
*RST: SAMPLE

Example: See [Example"Specifying delay and inhibit values in time units"](#) on page 690

Manual operation: See "[\(External\) Delay Unit](#)" on page 103

[:SOURce<hw>]:BB:ARbitrary:TRIGger[:EXtErnal]:DElay <Delay>

Specifies the trigger delay in samples.

Maximum trigger delay and trigger inhibit values depend on the installed options. See "[Specifying delay and inhibit values](#)" on page 93.

Parameters:

<Delay> float
Range: 0 to depends on the sample rate
Increment: 0.01
*RST: 0
Default unit: sample

Example: see [Example"Managing waveform files"](#) on page 689

Manual operation: See "[\(Specified\) External Delay/\(Specified\) Trigger Delay](#)" on page 103

[[:SOURce<hw>]:BB:ARbitrary:TRIGger[:EXternal]:TDElay <ExtTimeDelay>

Specifies the trigger delay for external triggering. The value affects all external trigger signals.

Maximum trigger delay and trigger inhibit values depend on the installed options. See ["Specifying delay and inhibit values"](#) on page 93.

Parameters:

<ExtTimeDelay> float
 Range: 0 to 2147483647 / (clock frequency)
 Increment: 1E-9
 *RST: 0
 Default unit: s

Example: See [Example"Specifying delay and inhibit values in time units"](#) on page 690.

Manual operation: See ["\(Specified\) External Delay/\(Specified\) Trigger Delay"](#) on page 103

[[:SOURce<hw>]:BB:ARbitrary:TRIGger[:EXternal]:RDElay?

Queries the time (in seconds) an external trigger event is delayed for.

Return values:

<ResTimeDelaySec> float
 Range: 0 to 688
 Increment: 0.25E-9
 *RST: 0

Example: See [Example"Specifying delay and inhibit values in time units"](#) on page 690

Usage: Query only

Manual operation: See ["Actual Trigger Delay/Actual External Delay"](#) on page 104

[[:SOURce<hw>]:BB:ARbitrary:TRIGger[:EXternal]:INHibit <Inhibit>

Specifies the number of samples, by which a restart is inhibited.

Maximum trigger delay and trigger inhibit values depend on the installed options. See ["Specifying delay and inhibit values"](#) on page 93.

Parameters:

<Inhibit> integer
 Range: 0 to 21.47 * (clock frequency)
 *RST: 0
 Default unit: samples

Example: See [Example"Managing waveform files"](#) on page 689.

Manual operation: See ["External / Trigger Inhibit"](#) on page 103

Marker commands

<code>[:SOURce<hw>]:BB:ARbitrary:TRIGger:OUTPut<ch>:MODE</code>	728
<code>[:SOURce<hw>]:BB:ARbitrary:TRIGger:OUTPut<ch>:ONTime</code>	728
<code>[:SOURce<hw>]:BB:ARbitrary:TRIGger:OUTPut<ch>:OFFTime</code>	728
<code>[:SOURce<hw>]:BB:ARbitrary:TRIGger:OUTPut<ch>:PATtern</code>	728
<code>[:SOURce<hw>]:BB:ARbitrary:TRIGger:OUTPut<ch>:PULSe:DIVider</code>	729
<code>[:SOURce<hw>]:BB:ARbitrary:TRIGger:OUTPut<ch>:PULSe:FREQuency?</code>	729
<code>[:SOURce<hw>]:BB:ARbitrary:TRIGger:OUTPut<ch>:DELay</code>	729
<code>[:SOURce<hw>]:BB:ARbitrary:TRIGger:OUTPut<ch>:DINSec?</code>	730

`[:SOURce<hw>]:BB:ARbitrary:TRIGger:OUTPut<ch>:MODE <Mode>`

Defines the signal for the selected marker output.

For detailed description of the regular marker modes, refer to "[Marker modes](#)" on page 85.

Parameters:

<Mode> UNCHanged | REStart | PULSe | PATtern | RATio

UNCHanged

A marker signal as defined in the waveform file (tag 'marker mode x') is generated.

*RST: UNCHanged

Example: See [Example "Managing waveform files"](#) on page 689.

Manual operation: See "[Marker Mode](#)" on page 151

`[:SOURce<hw>]:BB:ARbitrary:TRIGger:OUTPut<ch>:ONTime <OnTime>`**`[:SOURce<hw>]:BB:ARbitrary:TRIGger:OUTPut<ch>:OFFTime <OffTime>`**

Sets the number of samples in the ON and OFF periods.

Parameters:

<OffTime> integer

Range: 1 to 14913079

*RST: 1

Example: see [Example "Managing waveform files"](#) on page 689

Manual operation: See "[Marker Mode](#)" on page 151

`[:SOURce<hw>]:BB:ARbitrary:TRIGger:OUTPut<ch>:PATtern <Pattern>, <BitCount>`

Defines the bit pattern used to generate the marker signal.

Parameters:

<Pattern> numeric

*RST: #H2

<BitCount> integer
 0 = marker off, 1 = marker on
 Range: 1 to 64
 *RST: 2

Example: See [Example"Managing waveform files"](#) on page 689.

Manual operation: See ["Marker Mode"](#) on page 151

[:SOURce<hw>]:BB:ARbitrary:TRIGger:OUTPut<ch>:PULSe:DIVider <Divider>

Sets the divider for the pulsed marker signal.

Parameters:

<Divider> integer
 Range: 2 to 1024
 *RST: 2

Example: See [Example"Managing waveform files"](#) on page 689

Manual operation: See ["Marker Mode"](#) on page 151

[:SOURce<hw>]:BB:ARbitrary:TRIGger:OUTPut<ch>:PULSe:FREQuency?

Queries the pulse frequency of the pulsed marker signal. The pulse frequency is derived by dividing the symbol rate by the divider.

Return values:

<Frequency> float
 Increment: 0.001

Example: see [Example"Managing waveform files"](#) on page 689

Usage: Query only

Manual operation: See ["Marker Mode"](#) on page 151

[:SOURce<hw>]:BB:ARbitrary:TRIGger:OUTPut<ch>:DELay <Delay>

Defines the delay between the signal on the marker outputs and the start of the signals.

Parameters:

<Delay> integer
 Range: 0 to depends on other values
 Increment: 0.001
 *RST: 0
 Default unit: Symbol

Example: See [Example"Managing waveform files"](#) on page 689.

Manual operation: See ["Marker x Delay"](#) on page 105

[:SOURce<hw>]:BB:ARbitrary:TRIGger:OUTPut<ch>:DINSec?

Queries the marker delay in microseconds.

You can define a marker delay in samples with `[:SOURce<hw>]:BB:ARbitrary:TRIGger:OUTPut<ch>:DELay`.

Return values:

<DelayInS> float
 Range: 0 to 16777215
 Increment: 1E-3
 *RST: 0

Usage: Query only

Manual operation: See "[Delay \(Time\)](#)" on page 152

Clock commands**[:SOURce<hw>]:BB:ARbitrary:CLOCK:SOURce <Source>**

Selects the clock source:

- `INTernal`: Internal clock reference

Parameters:

<Source> INTernal
 *RST: INTernal

Example: See [Example "Managing waveform files"](#) on page 689.

Manual operation: See "[Clock Source](#)" on page 105

14.16.3.4 SOURce:BB:General subsystem

The `SOURce:BB:GENeral` subsystem contains the commands for configuring basic frequency (FM), phase (PhiM), amplitude (AM) and pulse modulation (PULM) digital baseband signals.

Required options

See "[Required options](#)" on page 238.

Modulation states

You can modulate frequency and phase in parallel. But activating another baseband signal, e.g. for amplitude or pulse generation, deactivates the previous baseband modulation signal:

```
SOURce1:BB:GENeral:FM:STATe 1
SOURce1:BB:GENeral:PM:STATe 1
SOURce1:BB:GENeral:FM:STATe? 1
SOURce1:BB:GENeral:AM:STATe? 0
```

Programming examples

Example: Activate basic FM

```
SOURce1:BB:GENeral:FM:FREQuency 2000
SOURce1:BB:GENeral:FM:DEVIation 1250
SOURce1:BB:GENeral:FM:PERiod? 0.0005
SOURce1:BB:GENeral:FM:SHAPE? SINE
SOURce1:BB:GENeral:FM:STATe 1
```

Example: Activate basic PM

```
SOURce1:BB:GENeral:PM:FREQuency 100000
SOURce1:BB:GENeral:PM:DEVIation 286.4789 // degrees
SOURce1:BB:GENeral:PM:PERiod? 0.00001
SOURce1:BB:GENeral:PM:SHAPE? SINE
SOURce1:BB:GENeral:PM:STATe 1
```

Example: Activate basic AM

```
SOURce1:BB:GENeral:AM:DEPTh 100
SOURce1:BB:GENeral:AM:FREQuency 20000
SOURce1:BB:GENeral:AM:PERiod? 0.0005
SOURce1:BB:GENeral:AM:SHAPE? SINE
SOURce1:BB:GENeral:AM:STATe 1
```

Example: Activate PULM

```
SOURce1:BB:GENeral:PULM:MODE DOUB
SOURce1:BB:GENeral:PULM:PERiod 0.00005
SOURce1:BB:GENeral:PULM:WIDTh 0.000001
SOURce1:BB:GENeral:PULM:DOUBle:WIDTh 0.000006
SOURce1:BB:GENeral:PULM:TRANSition:TYPE SMO
SOURce1:BB:GENeral:PULM:POLarity INV
SOURce1:BB:GENeral:PULM:STATe 1
```

FM commands

[:SOURce<hw>]:BB:GENeral:FM:DEVIation	731
[:SOURce<hw>]:BB:GENeral:FM:FREQuency	732
[:SOURce<hw>]:BB:GENeral:FM:PERiod	732
[:SOURce<hw>]:BB:GENeral:FM:SHAPE	732
[:SOURce<hw>]:BB:GENeral:FM[:STATe]	732

[\[:SOURce<hw>\]:BB:GENeral:FM:DEVIation <FmDeviation>](#)

Sets the frequency modulation deviation in Hz.

Parameters:

<FmDeviation>	float
	Range: 0 to 4E6
	Increment: 0.01
	*RST: 1E3

Example: See [Example"Activate basic FM"](#) on page 731.

Manual operation: See ["FM Deviation"](#) on page 240

[:SOURce<hw>]:BB:GENeral:FM:FREQUency <FreqModFreq>

Sets the frequency of the modulation signal.

Parameters:

<FreqModFreq> float
 Range: 0.1 to 100E3
 Increment: 0.1
 *RST: 1E3

Example: See [Example"Activate basic FM"](#) on page 731.

Manual operation: See ["Modulation Frequency"](#) on page 239

[:SOURce<hw>]:BB:GENeral:FM:PERiod <FmPer>

Queries the period of the modulation signal.

Parameters:

<FmPer> float
 Range: 100E-9 to 100
 Increment: 5E-9
 *RST: 10E-6

Example: See [Example"Activate basic FM"](#) on page 731.

Manual operation: See ["Modulation Period"](#) on page 239

[:SOURce<hw>]:BB:GENeral:FM:SHAPe <FmShape>

Queries the shape of the modulation signal.

Parameters:

<FmShape> SINE
 *RST: SINE

Example: See [Example"Activate basic FM"](#) on page 731.

Manual operation: See ["Modulation Shape"](#) on page 239

[:SOURce<hw>]:BB:GENeral:FM[::STATe] <FmModState>

Activates the standard and deactivates all the other digital standards and digital modulation modes in the same path.

Parameters:

<FmModState> 1 | ON | 0 | OFF
 *RST: 0

Example: See [Example"Activate basic FM"](#) on page 731.

Manual operation: See ["State"](#) on page 239

AM commands

[:SOURce<hw>]:BB:GENeral:AM:DEPTH	733
[:SOURce<hw>]:BB:GENeral:AM:FREQUency	733
[:SOURce<hw>]:BB:GENeral:AM:PERiod	733
[:SOURce<hw>]:BB:GENeral:AM:SHAPE	734
[:SOURce<hw>]:BB:GENeral:AM[:STATE]	734

[:SOURce<hw>]:BB:GENeral:AM:DEPTH <AmDepth>

Sets the depth of the modulation signal in percent.

The depth is limited by the maximum peak envelope power (PEP).

Parameters:

<AmDepth> float
 Range: 0 to 100
 Increment: 0.1
 *RST: 30

Example: See [Example"Activate basic AM"](#) on page 731.

Manual operation: See ["AM Depth"](#) on page 242

[:SOURce<hw>]:BB:GENeral:AM:FREQUency <AmFreq>

Sets the frequency of the modulation signal.

Parameters:

<AmFreq> float
 Range: 0.1 to 100E3
 Increment: 0.1
 *RST: 1E3

Example: See [Example"Activate basic AM"](#) on page 731.

Manual operation: See ["Modulation Frequency"](#) on page 242

[:SOURce<hw>]:BB:GENeral:AM:PERiod <AmPer>

Queries the period of the modulation signal.

Parameters:

<AmPer> float
 Range: 100E-9 to 100
 Increment: 5E-9
 *RST: 10E-6

Example: See [Example"Activate basic AM"](#) on page 731.

Manual operation: See ["Modulation Period"](#) on page 242

[[:SOURce<hw>]:BB:GENeral:AM:SHAPe <AmShape>

Queries the shape of the modulation signal.

Parameters:

<AmShape> SINE
*RST: SINE

Example: See [Example"Activate basic AM"](#) on page 731.

Manual operation: See ["Modulation Shape"](#) on page 242

[[:SOURce<hw>]:BB:GENeral:AM[:STATe] <AmModState>

Activates the standard and deactivates all the other digital standards and digital modulation modes in the same path.

Parameters:

<AmModState> 1 | ON | 0 | OFF
*RST: 0

Example: See [Example"Activate basic AM"](#) on page 731 .

Manual operation: See ["State"](#) on page 242

PM commands

[:SOURce<hw>]:BB:GENeral:PM:DEVIation	734
[:SOURce<hw>]:BB:GENeral:PM:FREQuency	735
[:SOURce<hw>]:BB:GENeral:PM:PERiod	735
[:SOURce<hw>]:BB:GENeral:PM:SHAPe	735
[:SOURce<hw>]:BB:GENeral:PM[:STATe]	735

[[:SOURce<hw>]:BB:GENeral:PM:DEVIation <PmDeviation>

Sets the phase modulation deviation in radians or degrees.

Parameters:

<PmDeviation> float
Range: 0 to 6
Increment: 0.000001
*RST: 1
Default unit: rad

Example: See [Example"Activate basic PM"](#) on page 731.

Manual operation: See ["PhiM Deviation"](#) on page 241

[[:SOURce<hw>]:BB:GENeral:PM:FREQUency <PhaseFreq>

Sets the frequency of the modulation signal.

Parameters:

<PhaseFreq> float
 Range: 0.1 to 100E3
 Increment: 0.1
 *RST: 1E3

Example: See [Example "Activate basic PM"](#) on page 731.

Manual operation: See ["Modulation Frequency"](#) on page 240

[[:SOURce<hw>]:BB:GENeral:PM:PERiod <PhasePer>

Queries the period of the modulation signal.

Parameters:

<PhasePer> float
 Range: 100E-9 to 100
 Increment: 5E-9
 *RST: 10E-6

Manual operation: See ["Modulation Period"](#) on page 241

[[:SOURce<hw>]:BB:GENeral:PM:SHAPe <PmShape>

Queries the shape of the modulation signal.

Parameters:

<PmShape> SINE
 *RST: SINE

Example: See

Manual operation: See ["Modulation Shape"](#) on page 241

[[:SOURce<hw>]:BB:GENeral:PM[:STATe] <PhimModState>

Activates the standard and deactivates all the other digital standards and digital modulation modes in the same path.

Parameters:

<PhimModState> 1 | ON | 0 | OFF
 *RST: 0

Manual operation: See ["State"](#) on page 240

PULM commands

[:SOURce<hw>]:BB:GENeral:PULM:DOUBle:DELay	736
[:SOURce<hw>]:BB:GENeral:PULM:DOUBle:WIDTh	736
[:SOURce<hw>]:BB:GENeral:PULM:MODE	736
[:SOURce<hw>]:BB:GENeral:PULM:PERiod	737
[:SOURce<hw>]:BB:GENeral:PULM:TRANsition:TYPE	737
[:SOURce<hw>]:BB:GENeral:PULM:VIDeo:POLarity	737
[:SOURce<hw>]:BB:GENeral:PULM:WIDTh	737
[:SOURce<hw>]:BB:GENeral:PULM[:STATe]	738

[\[:SOURce<hw>\]:BB:GENeral:PULM:DOUBle:DELay <PulmDbIDel>](#)

Sets the double pulse delay in microseconds.

Parameters:

<PulmDbIDel>	float
	Range: 50E-9 to 100
	Increment: 5E-9
	*RST: 3E-6

Example: See [Example"Activate PULM"](#) on page 731.

Manual operation: See ["Double Pulse Delay"](#) on page 244

[\[:SOURce<hw>\]:BB:GENeral:PULM:DOUBle:WIDTh <PulmDbIWidth>](#)

Defines the double pulse width in microseconds.

Parameters:

<PulmDbIWidth>	float
	Range: 50E-9 to 100
	Increment: 5E-9
	*RST: 3E-6

Example: See [Example"Activate PULM"](#) on page 731.

Manual operation: See ["Double Pulse Width"](#) on page 244

[\[:SOURce<hw>\]:BB:GENeral:PULM:MODE <PulmMode>](#)

Sets the pulse mode.

You can set for single or double pulse signals.

Parameters:

<PulmMode>	SINGle DOUBle
	*RST: SINGle

Example: See [Example"Activate PULM"](#) on page 731.

Manual operation: See ["Pulse Mode"](#) on page 243

[[:SOURce<hw>]:BB:GENeral:PULM:PERiod <PulsModPer>

Defines the pulse period in microseconds.

Parameters:

<PulsModPer> float
 Range: 100E-9 to 100
 Increment: 5E-9
 *RST: 10E-6

Example: See [Example"Activate PULM"](#) on page 731.

Manual operation: See ["Pulse Period"](#) on page 243

[[:SOURce<hw>]:BB:GENeral:PULM:TRANSition:TYPE <PulmTransType>

Sets the transition type of the pulse modulation signal.

Parameters:

<PulmTransType> FAST | SMOothed
 *RST: FAST

Example: See [Example"Activate PULM"](#) on page 731.

Manual operation: See ["Transition Type"](#) on page 244

[[:SOURce<hw>]:BB:GENeral:PULM:VIDeo:POLarity <PulsVideoPol>

Sets the video polarity.

Parameters:

<PulsVideoPol> INVerted | NORMal
 *RST: NORMal

Example: See [Example"Activate PULM"](#) on page 731.

Manual operation: See ["Video Polarity"](#) on page 244

[[:SOURce<hw>]:BB:GENeral:PULM:WIDTh <PulmWidth>

Sets the pulse width in microseconds.

Parameters:

<PulmWidth> float
 Range: 50E-9 to 100
 Increment: 5E-9
 *RST: 2E-6

Example: See [Example"Activate PULM"](#) on page 731.

Manual operation: See ["Pulse Width"](#) on page 244

[:SOURce<hw>]:BB:GENeral:PULM[:STATe] <PulmState>

Activates the standard and deactivates all the other digital standards and digital modulation modes in the same path.

Parameters:

<PulmState> 1 | ON | 0 | OFF
 *RST: 0

Example: See [Example "Activate PULM"](#) on page 731.

Manual operation: See ["State"](#) on page 243

14.16.3.5 SOURce:AWGN subsystem

The SOURce:AWGN subsystem contains the commands for setting the noise generator.

Required options

See [Chapter 6.1.1, "Required options"](#), on page 280.

Programming Examples

Example: Generating a pure noise signal

The following example generates a pure noise signal with specified bandwidth and noise level.

```
SOURce1:AWGN:MODE ONLY
SOURce1:AWGN:BWIDth 3840000
SOURce1:AWGN:BWIDth:RATio 2
SOURce1:AWGN:STATe ON
SOURce1:AWGN:BWIDth:NOISe?
// Response: 7680000
SOURce1:AWGN:FREQuency:CENTer:OFFSet 1000000
// Shifts the noise signal by 1 MHz relative to the carrier frequency.
SOURce1:AWGN:DISP:MODE RFA
SOURce1:AWGN:POWer:NOISe -80
// SOURce1:POWer:LEVel:IMMediate:AMPlitude?
// Response: -80
SOURce1:AWGN:POWer:NOISe:TOTal?
```

Example: Generating a CW interferer signal

The following example generates a CW interferer signal with specified target frequency and level.

```
SOURce1:AWGN:MODE CW
SOURce1:AWGN:FREQuency:TARGet 20000000
SOURce1:AWGN:STATe ON
```

```

SOURCE1:AWGN:FREQUENCY:RESULT?

SOURCE1:AWGN:POWER:RMODE CARRIER
SOURCE1:AWGN:CNRATIO 10
SOURCE1:AWGN:POWER:CARRIER -80
// the Level display indicates the PEP of the carrier
// SOURCE1:POWER:LEVEL:IMMEDIATE:AMPLITUDE?
// Response: -80
// Query the power of the interfering signal
SOURCE1:AWGN:POWER:NOISE?
// Response: -90
SOURCE1:AWGN:POWER:SUM?
// Response: -79.5860731484178
SOURCE1:AWGN:POWER:SUM:PEP?
// Response: -80

```

Example: Generating an additive noise signal

The following example shows how to adjust the AWGN settings to generate a signal with the following characteristics:

- The carrier signal is an uplink EUTRA/LTE signal with:
 - "Channel Bandwidth = 1.4 GHz", i.e. "Occupied Bandwidth = 1.080 MHz"
 - "RF Frequency = 1.950 GHz"
 - "RF Level = -76 dBm"
- Required is an SNR of 12.7 dB

```

SOURCE1:FREQUENCY:CW 1950000000
SOURCE1:POWER:LEVEL:IMMEDIATE:AMPLITUDE -76

SOURCE1:AWGN:MODE ADD
// set the system bandwidth to the occupied bandwidth
SOURCE1:AWGN:BWIDTh 1080000
SOURCE1:AWGN:BWIDTh:RATIo 1.5
SOURCE1:AWGN:STATe ON
SOURCE1:AWGN:BWIDTh:NOISe?
// Response: 1620000

SOURCE1:AWGN:DISP:MODE RFA
SOURCE1:AWGN:POWER:MODE CN
SOURCE1:AWGN:POWER:RMODE CARRIER
SOURCE1:AWGN:BRATe?
// Response: 100000
SOURCE1:AWGN:CNRATIO 12.7
SOURCE1:AWGN:ENRATIO?
// Response: 23.0342375548695
SOURCE1:AWGN:POWER:CARRIER?
// Response: -76
// the Level display indicates the PEP of the carrier

```

```
// Query the resulting noise power, in the system and total bandwidth
SOURce1:AWGN:POWer:NOISe?
// Response: -88.7
SOURce1:AWGN:POWer:NOISe:TOTal?
// Response: -88.7
// Query the carrier+noise power and PEP
SOURce1:AWGN:POWer:SUM?
// Response: -75.7728170942726
SOURce1:AWGN:POWer:SUM:PEP?
// Response: -76
```

General commands

[:SOURce<hw>]:AWGN:STATe	740
[:SOURce<hw>]:AWGN:MODE	740
[:SOURce<hw>]:AWGN:BWIDth	741
[:SOURce<hw>]:AWGN:BWIDth:COUPling[:STATe]	741
[:SOURce<hw>]:AWGN:BWIDth:RATio	741
[:SOURce<hw>]:AWGN:BWIDth:NOISe?	742
[:SOURce<hw>]:AWGN:DISP:MODE	742
[:SOURce<hw>]:AWGN:POWer:MODE	742
[:SOURce<hw>]:AWGN:POWer:RMODE	743
[:SOURce<hw>]:AWGN:BRATe	743
[:SOURce<hw>]:AWGN:CNRatio	743
[:SOURce<hw>]:AWGN:ENRatio	743
[:SOURce<hw>]:AWGN:POWer:CARRier	744
[:SOURce<hw>]:AWGN:POWer:NOISe	744
[:SOURce<hw>]:AWGN:POWer:NOISe:TOTal?	744
[:SOURce<hw>]:AWGN:POWer:SUM?	744
[:SOURce<hw>]:AWGN:POWer:SUM:PEP?	745
[:SOURce<hw>]:AWGN:FREQuency:TARGet	745
[:SOURce<hw>]:AWGN:FREQuency:RESult?	745

[:SOURce<hw>]:AWGN:STATe <State>

Activates or deactivates the AWGN generator.

Parameters:

<State> 1 | ON | 0 | OFF
 *RST: 0

Example: See [Example "Generating a pure noise signal"](#) on page 738.

Manual operation: See ["State"](#) on page 285

[:SOURce<hw>]:AWGN:MODE <Mode>

Determines how the interfering signal is generated.

Parameters:

<Mode> ONLY | ADD | CW

ADD

The AWGN noise signal is added to the baseband signal.

ONLY

The pure AWGN noise signal is modulated to the carrier. The connection to the baseband is interrupted

CW

The sine interfering signal is added to the baseband signal.

*RST: ADD

Example: See [Example "Generating an additive noise signal"](#) on page 739

Manual operation: See ["Mode"](#) on page 286

[[:SOURce<hw>]:AWGN:BWIDth <BWidth>

Sets the system bandwidth.

Parameters:

<BWidth> float
 Range: 1000 to 80E6
 Increment: 100
 *RST: 3.84E6

Example: See [Example "Generating an additive noise signal"](#) on page 739.

Manual operation: See ["System Bandwidth"](#) on page 286

[[:SOURce<hw>]:AWGN:BWIDth:COUPling[:STATe] <AwgnBwCoupState>

Activates bandwidth coupling. If activated, the digital broadcast baseband signal bandwidth couples to the AWGN system bandwidth.

Parameters:

<AwgnBwCoupState> 1 | ON | 0 | OFF
 *RST: 0

Example:

```
:SOURce1:AWGN:BWIDth?
// Response in Hz: 3840000
// Activate a digital broadcast standard, e.g.
DVB-T.
:SOURce1:BB:DVBT:STATe 1
:SOURce1:AWGN:BWIDth:COUPling:STATe 1
:SOURce1:AWGN:BWIDth?
// Response in Hz: 76071143
```

Manual operation: See ["Bandwidth Coupling"](#) on page 286

[[:SOURce<hw>]:AWGN:BWIDth:RATio <Ratio>

Sets the ratio of minimum real noise bandwidth to system bandwidth, see also ["Signal and noise parameters"](#) on page 281.

Parameters:

<Ratio> float
 Range: 1 to Max
 Increment: 0.1
 *RST: 1

Example: see [Example"Generating an additive noise signal"](#) on page 739.

Manual operation: See ["Minimum Noise/System Bandwidth Ratio"](#) on page 286

[:SOURce<hw>]:AWGN:BWIDth:NOISe?

Queries the real noise bandwidth.

Return values:

<Noise> float
 Range: 0 to 200E6
 Increment: 100
 *RST: 0

Example: See [Example"Generating an additive noise signal"](#) on page 739.

Usage: Query only

Manual operation: See ["Noise Bandwidth"](#) on page 292

[:SOURce<hw>]:AWGN:DISP:MODE <Mode>

Sets the output to that the AWGN settings are related.

Parameters:

<Mode> RFA | IQOUT1
 *RST: RF

Example: See [Example"Generating an additive noise signal"](#) on page 739.

Manual operation: See ["Show Powers For Output"](#) on page 288

[:SOURce<hw>]:AWGN:POWer:MODE <Mode>

Selects the mode for setting the noise level.

Parameters:

<Mode> CN | SN | EN
 *RST: SN

Example: see [Example"Generating an additive noise signal"](#) on page 739

Manual operation: See ["Set Noise Power Via"](#) on page 288

[[:SOURce<hw>]:AWGN:POWer:RMODE <RMode>

Determines whether the carrier or the noise level is kept constant when the C/N value or Eb/N0 value is changed.

Parameters:

<RMode> CARRier | NOISe
*RST: CARRier

Example: See [Example "Generating an additive noise signal"](#) on page 739

Manual operation: See ["Reference Mode"](#) on page 288

[[:SOURce<hw>]:AWGN:BRATe <BRate>

Sets the bit rate used for calculation of bit energy to noise power ratio.

Valid units are bps, kbps and mabps as well as b/s, kb/s and mab/s.

Parameters:

<BRate> float
Range: 400 to depends on the installed options
Increment: 0.001
*RST: 100000

Example: see [Example "Generating an additive noise signal"](#) on page 739

Manual operation: See ["Bit Rate"](#) on page 288

[[:SOURce<hw>]:AWGN:CNRatio <CnRatio>

Sets the carrier/interferer ratio.

Parameters:

<CnRatio> float
Range: -50 to 45
Increment: 0.01
*RST: 0

Example: See [Example "Generating an additive noise signal"](#) on page 739

Manual operation: See ["Carrier/Noise Ratio, Signal/Noise Ratio"](#) on page 289

[[:SOURce<hw>]:AWGN:ENRatio <EnRatio>

Sets the ratio of bit energy to noise power density.

Parameters:

<EnRatio> float
Range: -50 to depends on the installed options
Increment: 0.01
*RST: 15.84
Default unit: dB

Example: See [Example"Generating an additive noise signal"](#) on page 739

Manual operation: See "[E_b/N₀](#)" on page 289

[:SOURce<hw>]:AWGN:POWer:CARRier <Carrier>

Sets the carrier power.

Parameters:

<Carrier> float
 Increment: 0.01
 *RST: 0

Example: see [Example"Generating an additive noise signal"](#) on page 739

Manual operation: See "[Carrier Power, Signal Power](#)" on page 289

[:SOURce<hw>]:AWGN:POWer:NOISe <Noise>

Sets the power of the noise signal in the system respectively total bandwidth.

Parameters:

<Noise> float
 Increment: 0.01

Example: see [Example"Generating an additive noise signal"](#) on page 739

Manual operation: See "[Noise Power \(System Bandwidth\), Interferer Power](#)" on page 290

[:SOURce<hw>]:AWGN:POWer:NOISe:TOTal?

Queries the noise level in the total bandwidth.

Return values:

<Total> float
 Range: -145 to 20
 Increment: 0.01
 *RST: -30

Example: see [Example"Generating an additive noise signal"](#) on page 739

Usage: Query only

Manual operation: See "[Noise Power \(Total Bandwidth\)](#)" on page 291

[:SOURce<hw>]:AWGN:POWer:SUM?

Queries the overall power of the noise/interferer signal plus useful signal

Return values:

<Sum> float
 Range: -145 to 20
 Increment: 0.01
 *RST: 0

Example: see [Example"Generating an additive noise signal"](#) on page 739

Usage: Query only

Manual operation: See "[Carrier + Noise Power, Signal + Noise Power \(System Bandwidth\), Carrier + Interferer Power, Signal + Interferer Power](#)" on page 291

[:SOURce<hw>]:AWGN:POWer:SUM:PEP?

Queries the peak envelope power of the overall signal comprised of noise signal plus useful signal.

Return values:

<Pep> float
 Range: -145 to 20
 Increment: 0.01
 *RST: 0

Example: see [Example"Generating an additive noise signal"](#) on page 739

Usage: Query only

Manual operation: See "[Carrier + Noise PEP, Signal + Noise PEP \(Total Bandwidth\), Carrier + Interferer PEP, Signal + Interferer PEP](#)" on page 291

[:SOURce<hw>]:AWGN:FREQuency:TARGet <Target>

Sets the desired frequency of the sine wave.

Parameters:

<Target> float
 Range: -40E6 to 40E6
 Increment: 0.01
 *RST: 0

Example: see [Example"Generating a CW interferer signal"](#) on page 738

Manual operation: See "[Target CW Frequency Offset](#)" on page 287

[:SOURce<hw>]:AWGN:FREQuency:RESult?

Queries the actual frequency of the sine wave.

Return values:

<Result> float
 Range: -40E6 to 40E6
 Increment: 0.01
 *RST: 0

Example: see [Example "Generating a CW interferer signal"](#) on page 738

Usage: Query only

Manual operation: See ["Resulting CW Frequency Offset"](#) on page 292

14.16.3.6 SOURce:BB:IMPairment subsystem

This subsystem contains the commands for digital I/Q impairments.

Required options

See [Chapter 6.2.1, "Required options"](#), on page 294.

[:SOURce<hw>]:BB:IMPairment:IQRatio[:MAGNitude]	746
[:SOURce<hw>]:BB:IMPairment:LEAKage:I	746
[:SOURce<hw>]:BB:IMPairment:LEAKage:Q	746
[:SOURce<hw>]:BB:IMPairment:QUADrature[:ANGLE]	747
[:SOURce<hw>]:BB:IMPairment:STATe	747
[:SOURce<hw>]:BB:IMPairment:OPTimization:MODE	747

[\[:SOURce<hw>\]:BB:IMPairment:IQRatio\[:MAGNitude\]](#) <lqRatio>

Parameters:

<lqRatio> float
 Range: -1 to 1
 Increment: 1E-4
 *RST: 0

Manual operation: See ["Gain Imbalance"](#) on page 297

[\[:SOURce<hw>\]:BB:IMPairment:LEAKage:I](#) <I>
[\[:SOURce<hw>\]:BB:IMPairment:LEAKage:Q](#) <Q>

Determines the leakage amplitude of the I or Q signal component of the corresponding stream

Parameters:

<Q> float
 Range: -10 to 10
 Increment: 0.01
 *RST: 0

Example: SOURce:BB:IMPAirment:LEAKage:I 0.04
 SOURce:BB:IMPAirment:LEAKage:Q 4 PCT
 Sets the leakage for the I component and Q component to 4 per cent.

Manual operation: See "[I/Q Offset](#)" on page 297

[:SOURce<hw>]:BB:IMPAirment:QUADrature[:ANGLE] <Angle>

Sets a quadrature offset (phase angle) between the I and Q vectors deviating from the ideal 90 degrees.

A positive quadrature offset results in a phase angle greater than 90 degrees.

Parameters:

<Angle> float
 Range: -10 to 10
 Increment: 0.01
 *RST: 0
 Default unit: DEG

Example: SOURce:BB:IMPAirment:QUADrature:ANGLE -5
 Sets the quadrature offset to -5 degrees.

Manual operation: See "[Quadrature Offset](#)" on page 297

[:SOURce<hw>]:BB:IMPAirment:STATe <State>

Activates the impairment or correction values LEAKage, QUADrature and IQRatio.

Parameters:

<State> 1 | ON | 0 | OFF
 *RST: 0

Example: SOURce1:BB:IMPAirment:STATe ON
 Activates digital impairment.

Manual operation: See "[State](#)" on page 297

[:SOURce<hw>]:BB:IMPAirment:OPTimization:MODE <Mode>

Sets the optimization mode.

Parameters:

<Mode> FAST | | QHTable
 FAST
 Optimization by compensation for I/Q skew.
 QHTable
 Improved optimization by maintained speed.
 *RST: FAST

Example: :SOURCE1:IQ:SOURce? BASEband
 :SOURCE1:BB:IMPairment:OPTimization:MODE FAST

Manual operation: See "Optimization Mode" on page 300

14.16.3.7 SOURce:BB:GRAPhics subsystem

This subsystem contains the commands used to setup the graphical display.

Required options

See Chapter 10.1.1, "Required options", on page 394.

[:SOURce<hw>]:BB:GRAPhics:MODE.....	748
[:SOURce<hw>]:BB:GRAPhics:SRATe:MODE.....	748
[:SOURce<hw>]:BB:GRAPhics:SRATe:USER.....	749
[:SOURce]:BB:GRAPhics:CLoSe.....	749
[:SOURce]:BB:GRAPhics:ADD.....	749
[:SOURce]:BB:GRAPhics:SOURce.....	749
[:SOURce]:BB:GRAPhics:FFTLen.....	750
[:SOURce]:BB:GRAPhics:FFTFscale.....	750
[:SOURce<hw>]:BB:GRAPhics:TRIGger:SOURce.....	750

[:SOURce<hw>]:BB:GRAPhics:MODE <Mode>

Selects the graphics mode of the graphical signal display.

Parameters:

<Mode> IQ | VECTor | CCDF | PSPectrum | CONStellation | EYEI | EYEQ
 *RST: IQ

Example: BB:GRAP:MODE VECT
 Selects the vector diagram graphics mode.

Manual operation: See "Mode" on page 403

[:SOURce<hw>]:BB:GRAPhics:SRATe:MODE <Mode>

Sets how the time resolution of the signal is determined. Maximum resolution corresponds to a diagram covering the entire signal bandwidth. The higher the resolution is, the shorter the length of the displayed signal segment will be for the specified recording depth.

Parameters:

<Mode> AUTO | FULL | USER
 *RST: AUTO

Example: BB:GRAP:SRAT:MODE FULL
 Sets the sample rate mode.

Manual operation: See "Sample Rate Mode" on page 404

[[:SOURce<hw>]:BB:GRAPhics:SRATe:USER <User>

(Enabled for BB:GRAPH:SRAT:MODE USER)

Selects the signal bandwidth for the diagram. The setting range moves between the minimum and maximum bandwidth which is possible for the selected graphical signal display. The selection is made graphically by moving the pointer.

Parameters:

<User> float
Range: 0.01 to 100
Increment: 0.01
*RST: 10
Default unit: PCT

Example: BB:GRAP:SRAT:USER 20
sets the sample rate factor.

Example: BB:GRAP:SRAT:MODE USER
sets the sample rate mode.

Manual operation: See ["Sample Rate"](#) on page 404

[[:SOURce]:BB:GRAPhics:CLOSe

Closes all graphical signal displays.

Usage: Event

Manual operation: See ["Remove"](#) on page 405

[[:SOURce]:BB:GRAPhics:ADD <Size>

Adds a graphical signal display (according to the current MODE, SOURce, SRATe:* and TRIGger:* settings).

Setting parameters:

<Size> MAXimized | MINimized

Usage: Setting only

Manual operation: See ["Add"](#) on page 404

[[:SOURce]:BB:GRAPhics:SOURce <Source>

Defines the signal acquisition point, that is the location in the signal flow where the displayed signal is tapped from.

See [Chapter 10.1.2.2, "Signal acquisition points"](#), on page 399.

Parameters:

<Source> STRA | BBA | RFA | BBIA | DO1 | IQO1 | STRA | BBA | RFA |
BBIA | DO1

STRA

Stream A; input stream of the "IQ Stream Mapper"

BBA

Baseband signal

BBIA

Digital baseband input signals

RFA

RF signal

DO1

Digital I/Q output signals; outputs of the "IQ Stream Mapper"

*RST: STRA

Options: DO1 requires R&S SMCVB-K19**Manual operation:** See "[Source](#)" on page 403**[:SOURce]:BB:GRAPhics:FFTLen <Mode>**

Sets the FFT size.

Parameters:

<Mode> LEN256 | LEN512 | LEN1024 | LEN2048 | LEN4096

*RST: LEN2048

Example: SOURce:BB:GRAPhics:FFTLen LEN2048**Manual operation:** See "[FFT Length](#)" on page 403**[:SOURce]:BB:GRAPhics:FFTFscale <State>**

Defines the normalization of the power values in the power spectrum diagram.

Parameters:

<State> 1 | ON | 0 | OFF

1

Normalized power in dBFS

0

Shows power distribution in dB/Hz

*RST: 0

Example:

SOURce:BB:GRAPhics:FFTFscale PSpectrum

SOURce:BB:GRAPhics:FFTFscale 1

// the power spectrum shows the normalized power in dBFS

Manual operation: See "[Full Scale \(dBFS\)](#)" on page 403**[:SOURce<hw>]:BB:GRAPhics:TRIGger:SOURce <Source>**

Defines the trigger for the starting time of the graphic recording.

Parameters:

<Source> SOFTware | MARKer
 *RST: SOFTware

Example:

SOURce1:BB:GRAPhics:TRIGger:SOURce MARKer
 Sets the trigger source.

Manual operation: See ["Trigger Source"](#) on page 403

14.16.3.8 SOURce:BB:PROGress subsystem general commands

In the R&S SMCV100B, some calculation processes take longer time. While operating the instrument manually, you can observe the status of an initiated process by the busy indicator. The following commands fulfill the same task in the remote control operation.

Example: Querying the status of the Create Waveform file process

The following is an example on how to use these commands to retrieve information about how many percent of the initiated process are completed.

```
[ :SOURce<hw> ]:BB:PROGress:MCODer?.....751
[ :SOURce<hw> ]:BB:PROGress:MCODer:ARBitrary:MCARrier?.....751
[ :SOURce<hw> ]:BB:PROGress:MCODer:ARBitrary:WSEGment?.....751
```

```
[ :SOURce<hw> ]:BB:PROGress:MCODer?
[ :SOURce<hw> ]:BB:PROGress:MCODer:ARBitrary:MCARrier?
[ :SOURce<hw> ]:BB:PROGress:MCODer:ARBitrary:WSEGment?
```

Queries the status of an initiated process, like for example the calculation of a signal in accordance to a digital standard, or the calculation of a multi-carrier or multi-segment waveform file.

Return values:

<WSegment> integer
 Indicates the task progress in percent
 Range: 0 to 100
 *RST: 100

Example: See [Example"Querying the status of the Create Waveform file process"](#) on page 751

Usage: Query only

14.16.4 SOURce:CORRection subsystem

The SOURce:CORRection subsystem contains the commands for defining correction values for external test assemblies.

You can acquire the correction values anytime, regardless of the modulation settings of the generator. The correction is performed by adding the correction values to the output level of the respective RF frequency.

Determine the correction values in one of the following ways:

- Measure the RF output level at several frequency points and enter the value pairs manually in a table
- Connect an R&S NRP to the generator output signal and send the command [:SOURce<hw>] :CORRection:CSET:DATA [:SENSor<ch>] [:POWer] :SONCe to fill the table automatically.

Correction values can be stored in files with the predefined file extension *.uco.

Refer to [Chapter 14.5.2, "Accessing files in the default or in a specified directory"](#), on page 583 for general information on file handling in the default and in a specific directory.

Programming example

The examples in this section assume that:

- The files are stored in the default directory.
- *RST does not affect data lists.

Example: Create a table with user-defined correction values for the RF level

The following example shows a command sequence to create and activate a list for assigning level correction values to arbitrary RF frequencies. Further hardware settings are not considered.

```
// Reset the instrument to start from an initial state
// Query the available user correction list files in the default directory
// Select a file or create a new one
// *****
*RST; *CLS
SOURcel:CORRection:CSET:CATalog?
// Response: shows the name of available user correction files (if applicable)
// Select a file
SOURcel:CORRection:CSET:SElect "/var/user/ucor1"
// Create a new file (if not existing)
SOURcel:CORRection:CSET:SElect "/var/user/ucor2"

// Enter the frequency/level value pairs in the table;
// existing data is overwritten
// Query the number of frequency/power entries in the selected list
SOURcel:CORRection:CSET:DATA:FREQuency 100MHz,110MHz,120MHz,130MHz,140MHz,150MHz
SOURcel:CORRection:CSET:DATA:POWer -10,-7.5,-5.0,-2.5,0,2.5
SOURcel:CORRection:CSET:DATA:FREQuency:POINTs?
// 6
SOURcel:CORRection:CSET:DATA:POWer:POINTs?
// 6

// Enable user correction mode and RF output
SOURcel:CORRection:STATe 1
OUTPut1:STATe ON
```



```
// Query the currently used correction value
SOURce1:CORRection:VALue?
// -2.5

// Delete a user correction file
SOURce1:CORRection:CSET:DELEte "/var/user/ucor1.uco"
```

Example: Fill user correction data with sensor

The following example shows a command sequence to fill a user correction list automatically supported by a connected R&S NRP.

```
// Fill a user correction list with the level values
// measured by an R&S NRP,
// store the data in a file and enable user correction.

*RST; *CLS

SOURce1:CORRection:CSET:SElect "/var/user/Ucor1_AutoFill.uco"
SOURce1:CORRection:CSET:DATA:FREQuency 100MHz,110MHz,120MHz,130MHz,140MHz,150MHz
SOURce1:CORRection:ZERoing:STATe 1
SOURce1:CORRection:CSET:DATA:SENSor1:POWer:SONce
// Query the number of automatically filled correction level values
SOURce1:CORRection:CSET:DATA:POWer:POINTs?
// 6
SOURce1:CORRection:STATe 1

// Query the correction value at a certain frequency
FREQ 120000000
SOURce1:CORRection:VALue?
// -52.13
```

Example: User correction data exchange

The following example shows a command sequence to export a user correction list (here the list created with the example before) into an ASCII file. Further hardware settings are not considered.

```
// Select a user correction file for exporting to file in ASCII format
// Set ASCII data parameters
// Set the ASCII file extension, the decimal separator
// and the column separator for the ASCII data
SOURce1:CORRection:DEXChange:AFILe:CATalog?
// my_ucor
SOURce1:CORRection:CSET:CATalog?
// ucor1,Ucor1_AutoFill
SOURce1:CORRection:CSET:SElect "/var/user/Ucor1_AutoFill.uco"
SOURce1:CORRection:DEXChange:AFILe:EXTension CSV
SOURce1:CORRection:DEXChange:AFILe:SEParator:DECimal DOT
SOURce1:CORRection:DEXChange:AFILe:SEParator:COLumn COMMa
```

```
// Select source and destination
SOURce1:CORRection:DEXChange:AFILe:SElect "/var/user/ucor2ASCII"

// Export the user correction data into the ASCII file
SOURce1:CORRection:DEXChange:MODE EXPort
SOURce1:CORRection:DEXChange:EXECute

// Query the available ASCII files with extension .csv
SOURce1:CORRection:DEXChange:AFILe:CATalog?
// ucor2ASCII,my_ucor

// Import a user correction ASCII file
SOURce1:CORRection:DEXChange:MODE IMPort
SOURce1:CORRection:DEXChange:AFILe:SElect "/var/user/my_ucor"
SOURce1:CORRection:DEXChange:EXECute
```

- [Correction settings](#)..... 754
- [Correction data exchange](#)..... 757

14.16.4.1 Correction settings

[:SOURce<hw>]:CORRection:CSET:DATA:FREQuency <Frequency>

Enters the frequency value in the table selected with [\[:SOURce<hw>\]:CORRection:CSET\[:SElect\]](#).

Parameters:

<Frequency> Frequency#1[, Frequency#2, ...]
String of values with default unit Hz.

Example: See [Example"Create a table with user-defined correction values for the RF level"](#) on page 752 .

Manual operation: See ["Edit List Mode Data"](#) on page 349

[:SOURce<hw>]:CORRection:CSET:DATA:POWer <Power>

Enters the level values to the table selected with [\[:SOURce<hw>\]:CORRection:CSET\[:SElect\]](#).

Parameters:

<Power> Power#1[, Power#2, ...]
String of values with default unit dB.
*RST: 0

Example: See [Example"Create a table with user-defined correction values for the RF level"](#) on page 752 .

Manual operation: See ["Edit List Mode Data"](#) on page 349

[[:SOURce<hw>]:CORRection:CSET:DATA:FREQUency:POINts?

[[:SOURce<hw>]:CORRection:CSET:DATA:POWer:POINts?

Queries the number of frequency/level values in the selected table.

Return values:

<Points> integer
 Range: 0 to 10000
 *RST: 0

Example: See [Example"Create a table with user-defined correction values for the RF level"](#) on page 752 .

Usage: Query only

[[:SOURce<hw>]:CORRection:CSET:DATA[:SENSor<ch>][:POWer]:SONCe

Fills the selected user correction table with the level values measured by the power sensor for the given frequencies.

To select the used power sensor set the suffix in key word `SENSe`.

Example: See [Example"Fill user correction data with sensor"](#) on page 753.

Usage: Event

Manual operation: See ["Fill User Correction Data with Sensor"](#) on page 364

[[:SOURce<hw>]:CORRection:CSET[:SELEct] <Filename>

Selects or creates a file for the user correction data.

If the file with the selected name does not exist, a new file is created.

Parameters:

<Filename> string
 Filename or complete file path; file extension can be omitted.

Example: See [Example"Create a table with user-defined correction values for the RF level"](#) on page 752 .

Manual operation: See ["UCOR Data"](#) on page 359

[[:SOURce<hw>]:CORRection:VALue?

Queries the current value for user correction.

Return values:

<Value> float
 Range: -100 to 100
 Increment: 0.01
 *RST: 0

Example: See [Example "Create a table with user-defined correction values for the RF level"](#) on page 752 .

Usage: Query only

Manual operation: See ["User Correction"](#) on page 359

[:SOURce<hw>]:CORRection:ZERoing:STATe <State>

Activates the zeroing procedure before filling the user correction data acquired by a sensor.

Parameters:

<State> 1 | ON | 0 | OFF
*RST: 1

Example: See [Example "Fill user correction data with sensor"](#) on page 753.

Manual operation: See ["Fill User Correction Data with Sensor"](#) on page 364

[:SOURce<hw>]:CORRection:CSET:DATA[:SENSor<ch>][:POWER]:SONCe

Fills the selected user correction list with the level values measured by the power sensor for the given frequencies.

Suffix:

SENSor<ch> Defines the used power sensor, i.e. the sensor whose values are used.

Example: See [Example "Fill user correction data with sensor"](#) on page 753.

Usage: Event

[:SOURce<hw>]:CORRection[:STATe] <State>

Activates user correction with the currently selected table.

Parameters:

<State> 1 | ON | 0 | OFF
*RST: 0

Example: See [Example "Create a table with user-defined correction values for the RF level"](#) on page 752 .

Manual operation: See ["State"](#) on page 359

[:SOURce]:CORRection:CSET:CATalog?

Queries a list of available user correction tables.

Return values:

<Catalog> string
List of list filenames, separated by commas

Example: See [Example"Create a table with user-defined correction values for the RF level"](#) on page 752 .

Usage: Query only

Manual operation: See ["UCOR Data"](#) on page 359

[:SOURce]:CORRection:CSET:DELeTe <Filename>

Deletes the specified user correction list file.

Setting parameters:

<Filename> string
Filename or complete file path; file extension is optional.

Example: See [Example"Create a table with user-defined correction values for the RF level"](#) on page 752 .

Usage: Setting only

Manual operation: See ["UCOR Data"](#) on page 359

14.16.4.2 Correction data exchange

With the following commands, you can configure user correction lists and export or import them accordingly.

[:SOURce<hw>]:CORRection:DEXChange:AFILe:CATalog?

Queries the available ASCII files for export or import of user correction data in the current or specified directory.

Return values:

<Catalog> string
List of ASCII files *.txt or *.csv, separated by commas.

Example: See [Example"Create a table with user-defined correction values for the RF level"](#) on page 752 .

Usage: Query only

Manual operation: See ["Select \(ASCII\) Source/Select \(ASCII\) Destination"](#) on page 347

[:SOURce<hw>]:CORRection:DEXChange:AFILe:EXTension <Extension>

Determines the extension of the ASCII files for file import or export, or to query existing files.

Parameters:

<Extension> TXT | CSV
*RST: TXT

Example: See [Example"User correction data exchange"](#) on page 753 .

Manual operation: See ["ASCII File Settings"](#) on page 346

[:SOURCE<hw>]:CORRection:DEXChange:AFILe:SElect <Filename>

Selects the ASCII file to be imported or exported.

Parameters:

<Filename> string
 Filename or complete file path; file extension can be omitted.

Example: See [Example"User correction data exchange"](#) on page 753 .

Manual operation: See ["Select \(ASCII\) Source/Select \(ASCII\) Destination"](#) on page 347

[:SOURCE<hw>]:CORRection:DEXChange:AFILe:SEParator:COLumn <Column>

Selects the separator between the frequency and level column of the ASCII table.

Parameters:

<Column> TABulator | SEMicolon | COMMa | SPACe
 *RST: COMMa

Example: See [Example"User correction data exchange"](#) on page 753 .

Manual operation: See ["ASCII File Settings"](#) on page 346

[:SOURCE<hw>]:CORRection:DEXChange:AFILe:SEParator:DECimal <Decimal>

Sets the decimal separator used in the ASCII data between '.' (decimal point) and ',' (comma) with floating-point numerals.

Parameters:

<Decimal> DOT | COMMa
 *RST: DOT

Example: See [Example"User correction data exchange"](#) on page 753 .

Manual operation: See ["ASCII File Settings"](#) on page 346

[:SOURCE<hw>]:CORRection:DEXChange:EXECute

Executes the import or export of the selected correction list, according to the previously set transfer direction with command `[:SOURCE<hw>]:CORRection:DEXChange:MODE`.

Example: See [Example"User correction data exchange"](#) on page 753 .

Usage: Event

Manual operation: See ["Import / Export"](#) on page 347

[:SOURce<hw>]:CORRection:DEXChange:MODE <Mode>

Determines import or export of a user correction list.

Specify the source or destination file with the command `[:SOURce<hw>] : CORRection:DEXChange:SELEct`.

Parameters:

<Mode> IMPort | EXPort
*RST: IMPort

Example: See [Example "User correction data exchange"](#) on page 753 .

Manual operation: See ["Mode"](#) on page 346

[:SOURce<hw>]:CORRection:DEXChange:SELEct <Filename>

Selects the ASCII file for import or export, containing a user correction list.

Parameters:

<Filename> string
 Filename or complete file path; file extension can be omitted.

Example: See [Example "User correction data exchange"](#) on page 753 .

Manual operation: See ["Select Source/Select ASCII Destination"](#) on page 347

14.16.5 SOURce:FREQuency subsystem

The SOURce:FREQuency subsystem contains the commands used to define the frequency settings for the RF sources and sweeps.

Example: Frequency configuration

```
SOURce1:FREQuency:MODE CW
SOURce1:FREQuency:CW 6000000000
SOURce1:FREQuency:OFFSet 2000000000
SOURce1:FREQuency:MULTIplier 1.5
SOURce1:FREQuency:CW?
// 11000000000

// SOURce1:FREQuency:STEP:MODE USER
// SOURce1:FREQuency:STEP:INCRement 1000000
// SOURce1:FREQuency:CW UP

SOURce1:PHASe 2
SOURce1:PHASe:REFerence
```

<code>[:SOURce<hw>]:FREQuency:MODE</code>	760
<code>[:SOURce<hw>]:FREQuency[:CW FIXed]</code>	760
<code>[:SOURce<hw>]:FREQuency[:CW FIXed]:RCL</code>	761
<code>[:SOURce<hw>]:FREQuency:MANual</code>	762

[:SOURce<hw>]:FREQUENCY:MULTIPLIER.....	762
[:SOURce<hw>]:FREQUENCY:OFFSET.....	762
[:SOURce<hw>]:FREQUENCY:CENTER.....	763
[:SOURce<hw>]:FREQUENCY:SPAN.....	763
[:SOURce<hw>]:FREQUENCY:START.....	763
[:SOURce<hw>]:FREQUENCY:STOP.....	764
[:SOURce<hw>]:FREQUENCY:STEP:MODE.....	764
[:SOURce<hw>]:FREQUENCY:STEP[:INCREMENT].....	765

[:SOURce<hw>]:FREQUENCY:MODE <Mode>

Sets the frequency mode for generating the RF output signal. The selected mode determines the parameters to be used for further frequency settings.

Parameters:

<Mode>

CW | FIXed | SWEep | LIST

CW|FIXed

Sets the fixed frequency mode. CW and FIXed are synonyms. The instrument operates at a defined frequency, set with command [\[:SOURce<hw>\]:FREQUENCY\[:CW|FIXed\]](#).

SWEep

Sets sweep mode.

The instrument processes frequency (and level) settings in defined sweep steps.

Set the range and current frequency with the commands:

[\[:SOURce<hw>\]:FREQUENCY:START](#) on page 763 and [\[:SOURce<hw>\]:FREQUENCY:STOP](#) on page 764,

[\[:SOURce<hw>\]:FREQUENCY:CENTER](#) on page 763,

[\[:SOURce<hw>\]:FREQUENCY:SPAN](#) on page 763,

[\[:SOURce<hw>\]:FREQUENCY:MANual](#) on page 762

LIST

Sets list mode.

The instrument processes frequency and level settings by means of values loaded from a list.

To configure list mode settings, use the commands of the [Chapter 14.16.9, "SOURce:LIST subsystem"](#), on page 771.

*RST: CW

Example:

See [Example "Frequency configuration"](#) on page 759, and [Example "Setup an RF frequency or power sweep"](#) on page 801

Manual operation:

See ["State \(RF frequency sweep\)"](#) on page 334

See ["State"](#) on page 342

[:SOURce<hw>]:FREQUENCY[:CW|FIXed] <Fixed>

Sets the frequency of the RF output signal in the selected path.

The effect depends on the selected mode:

- In CW mode (`FREQ:MODE CW | FIXed`), the instrument operates at a fixed frequency.
- In sweep mode (`FREQ:MODE SWE`), the value applies to the sweep frequency. The instrument processes the frequency settings in defined sweep steps.
- In user mode (`FREQ:STEP:MODE USER`), you can vary the current frequency step by step.

Parameters:

<Fixed> float

The following settings influence the value range:

An offset set with the command `[:SOURce<hw>] :FREQuency:OFFSet`

Numerical value

Sets the frequency in CW and sweep mode

UP|DOWN

Varies the frequency step by step in user mode.

The frequency is increased or decreased by the value set with the command `[:SOURce<hw>] :FREQuency:STEP [:INCRement]`.

Range: (RFmin + OFFSet) to (RFmax + OFFSet)

*RST: 100 MHz

Example: See [Example"Frequency configuration"](#) on page 759

Example: See [Example"Setup an RF frequency or power sweep"](#) on page 801

Options: RFmax depends on the installed options, for example 3 GHz with R&S SMCVB-B103

Manual operation: See ["Frequency"](#) on page 306

`[:SOURce<hw>] :FREQuency [:CW|FIXed] :RCL <Rcl>`

Set whether the RF frequency value is retained or taken from a loaded instrument configuration, when you recall instrument settings with command `*RCL`.

Parameters:

<Rcl> INCLude | EXCLude

INCLude

Takes the frequency value of the loaded settings.

EXCLude

Retains the current frequency when an instrument configuration is loaded.

*RST: INCLude

Example: `SOURce1 :FREQuency: CW:RCL INCLude`

Manual operation: See ["Exclude Frequency"](#) on page 424

[:SOURce<hw>]:FREQUENCY:MANual <Manual>

Sets the frequency and triggers a sweep step manually if `SWEep:MODE MAN`.

Parameters:

<Manual> float

You can select any frequency within the setting range, where:

START is set with `[:SOURce<hw>]:FREQUENCY:START`

STOP is set with `[:SOURce<hw>]:FREQUENCY:STOP`

OFFSet is set with `[:SOURce<hw>]:FREQUENCY:OFFSet`

Range: (START + OFFSet) to (STOP + OFFSet)

Increment: 0.01Hz

*RST: 100 MHz

Default unit: Hz

Example: See [Example"Setup an RF frequency or power sweep"](#) on page 801

Manual operation: See ["Current Frequency"](#) on page 334

[:SOURce<hw>]:FREQUENCY:MULTIplier <Multiplier>

Sets the multiplication factor $N_{\text{FREQ:MULT}}$ of a subsequent downstream instrument.

The parameters offset $f_{\text{FREQ:OFFSer}}$ and multiplier $N_{\text{FREQ:MULT}}$ affect the frequency value set with the command `FREQ`.

The query `FREQ?` returns the value corresponding to the formula:

$$f_{\text{FREQ}} = f_{\text{RFout}} * N_{\text{FREQ:MULT}} + f_{\text{FREQ:OFFSer}}$$

See ["RF frequency and level display with a downstream instrument"](#) on page 305.

Parameters:

<Multiplier> float

Range: -10000 to 10000

Increment: 0.001

*RST: 1

Example: See [Example"Frequency configuration"](#) on page 759

Manual operation: See ["Multiplier"](#) on page 307

[:SOURce<hw>]:FREQUENCY:OFFSet <Offset>

Sets the frequency offset $f_{\text{FREQ:OFFSet}}$ of a downstream instrument.

The parameters offset $f_{\text{FREQ:OFFSer}}$ and multiplier $N_{\text{FREQ:MULT}}$ affect the frequency value set with the command `FREQ`.

The query `FREQ?` returns the value corresponding to the formula:

$$f_{\text{FREQ}} = f_{\text{RFout}} * N_{\text{FREQ:MULT}} + f_{\text{FREQ:OFFSet}}$$

See ["RF frequency and level display with a downstream instrument"](#) on page 305.

Note: The offset also affects RF frequency sweep.

Parameters:

<Offset> float
 Increment: 0.01
 *RST: 0

Example: See [Example"Frequency configuration"](#) on page 759

Manual operation: See ["Offset"](#) on page 307

[:SOURce<hw>]:FREQUENCY:CENTer <Center>

Sets the center frequency of the sweep.

See [Chapter 8.9.2.1, "Correlating parameters in sweep mode"](#), on page 326.

Parameters:

<Center> float
 Range: 300 kHz to RFmax
 Increment: 0.01 Hz
 *RST: 300E6
 Default unit: Hz

Example: See [Example"Setup an RF frequency or power sweep"](#) on page 801

Manual operation: See ["Center Frequency"](#) on page 339

**[:SOURce<hw>]:FREQUENCY:SPAN **

Sets the span of the frequency sweep range.

See [Chapter 8.9.2.1, "Correlating parameters in sweep mode"](#), on page 326.

Parameters:

 float
 Full frequency range
 Increment: 0.01
 *RST: 400E6

Example: See [Example"Setup an RF frequency or power sweep"](#) on page 801

Manual operation: See ["Span"](#) on page 339

[:SOURce<hw>]:FREQUENCY:STARt <Start>

Sets the start frequency for the RF sweep.

See [Chapter 8.9.2.1, "Correlating parameters in sweep mode"](#), on page 326.

Parameters:

<Start> float
 Range: 300kHz to RFmax
 Increment: 0.01Hz
 *RST: 100 MHz

Example: See [Example "Setup an RF frequency or power sweep"](#) on page 801

Manual operation: See ["Start Frequency/Stop Frequency"](#) on page 338

[[:SOURce<hw>]:FREQUENCY:STOP <Stop>

Sets the stop frequency range for the RF sweep.

See [Chapter 8.9.2.1, "Correlating parameters in sweep mode"](#), on page 326.

Parameters:

<Stop> float
 Range: 300kHz to RFmax
 Increment: 0.01Hz
 *RST: 500 MHz
 Default unit: Hz

Example: See [Example "Setup an RF frequency or power sweep"](#) on page 801

Manual operation: See ["Start Frequency/Stop Frequency"](#) on page 338

[[:SOURce<hw>]:FREQUENCY:STEP:MODE <Mode>

Defines the type of step size to vary the RF frequency at discrete steps with the commands [FREQ UP](#) or [FREQ DOWN](#).

Parameters:

<Mode> DECimal | USER

DECimal

Increases or decreases the level in steps of ten.

USER

Increases or decreases the level in increments, set with the command [FREQ:STEP\[:INCR\]](#).

*RST: DECimal

Example:

```
// increasing the RF frequency with a step size of 50 KHz
SOURce1:FREQUENCY:STEP 50E3
SOURce1:FREQUENCY:STEP:MODE USER
SOURce1:FREQUENCY:CW UP
```

Manual operation: See ["Variation Active"](#) on page 307

[[:SOURce<hw>]:FREQuency:STEP[:INCRement] <Increment>

Sets the step width.

You can use this value to vary the RF frequency with command [FREQ UP](#) or [FREQ DOWN](#), if you have activated [FREQ:STEP:MODE USER](#).

Note: This value also applies to the step width of the rotary knob on the instrument and, in user-defined step mode, increases or decreases the frequency.

Parameters:

<Increment> float
 Range: 0 Hz to RFmax - 100 kHz
 Increment: 0.01 Hz
 *RST: 1E6

Example: See [Example "Frequency configuration"](#) on page 759

Manual operation: See ["Variation Step"](#) on page 307

14.16.6 SOURce:INPut subsystem

The `SOURce:INPut` subsystem contains the commands for configuring the inputs for external modulation signals. The instrument trigger setting influences all sweeps and is effective in the List mode (Instrument Trigger).

[\[:SOURce\]:INPut:TRIGger:SLOPe.....](#) 765

[[:SOURce]:INPut:TRIGger:SLOPe <Slope>

Sets the polarity of the active slope of an applied instrument trigger.

Parameters:

<Slope> NEGative | POSitive
 *RST: POSitive

Example: `INP:TRIG:SLOP NEG`
 Activates the falling slope of the external trigger signal at the trigger input.

Manual operation: See ["Trigger Slope"](#) on page 337

14.16.7 SOURce:IQ subsystem

The `SOURce:IQ` subsystem contains the commands for configuring the I/Q modulation.

Required options

See [Chapter 7.1, "Required options"](#), on page 298.

[\[:SOURce<hw>\]:IQ:STATe.....](#) 766
[\[:SOURce<hw>\]:IQ:SWAP\[:STATe\].....](#) 766

[:SOURce<hw>] :IQ:STATe <State>

Enables/disables the I/Q modulation.

Parameters:

<State> 1 | ON | 0 | OFF
 *RST: 0

Example: IQ:STAT ON
 Activates I/Q modulation.

Manual operation: See "[State](#)" on page 299

[:SOURce<hw>] :IQ:SWAP[:STATe] <State>

Swaps the I and Q channel.

Parameters:

<State> 1 | ON | 0 | OFF
 *RST: 0

Example: IQ:SWAP ON
 swaps the I and Q channel.

Manual operation: See "[I/Q Swap](#)" on page 299

14.16.8 SOURce:IQ:OUTPut subsystem

The SOURce:IQ:OUTPut subsystem contains the commands for configuring digital I/Q output signals.

For information about the required options, see:

- "[Required options](#)" on page 272

14.16.8.1 SOURce:IQ:OUTPut:DIGital commands

This section describes the commands of the output of a digital I/Q signal.

Required options

See "[Required options](#)" on page 272.

Common suffixes

The following common suffixes are used in the remote commands:

Suffix	Value	Description
CHANnel<st0>	0	Option: R&S SMCVB-K19, fixed channel number CHANnel0

Example: Enabling and configuring the Dig. IQ HS x digital outputs

Option: R&S SMCVB-K19

```

SCONfiguration:OUTPut:MAPPING:DIGital:STReam1:STATe 1
SOURCE:IQ:OUTPut:DIGital:INTErface HSD
SOURCE:IQ:OUTPut:DIGital:STATe 1
SOURCE:IQ:OUTPut:DIGital:CHANnel0:NAME "CH0"
SOURCE:IQ:OUTPut:DIGital:CHANnel0:SRATe?
// Respons in Hz: "100000000"
// Query the peak power level of the channel.
SOURCE:IQ:OUTPut:DIGital:CHANnel0:POWer:PEP?
// Response in dBFS: "0"
SOURCE:IQ:OUTPut:DIGital:CHANnel0:PEP -20
// Query the RMS power level of the channel.
SOURCE:IQ:OUTPut:DIGital:CHANnel0:POWer:LEVel?
// Response in dBFS: "-20"
SOURCE:IQ:OUTPut:DIGital:CHANnel0:STATe 1

```

<code>[SOURCE<hw>]:IQ:OUTPut:DIGital:STATe</code>	767
<code>[SOURCE<hw>]:IQ:OUTPut:DIGital:INTErface</code>	767
<code>[SOURCE<hw>]:IQ:OUTPut:DIGital:SRATe</code>	768
<code>[SOURCE<hw>]:IQ:OUTPut:DIGital:CDEvice?</code>	768
<code>[SOURCE]:IQ:OUTPut:DIGital:POWer:VIA</code>	768
<code>[SOURCE]:IQ:OUTPut:DIGital:BBMM<ch>:CHANnel<st0>:POWer:PEP</code>	768
<code>[SOURCE]:IQ:OUTPut:DIGital:BBMM<ch>:CHANnel<st0>:POWer:LEVel</code>	769
<code>[SOURCE<hw>]:IQ:OUTPut:DIGital:POWer:STEP:MODE</code>	769
<code>[SOURCE<hw>]:IQ:OUTPut:DIGital:POWer:STEP[:INCRement]</code>	769
<code>[SOURCE<hw>]:IQ:OUTPut:DIGital:PON</code>	770
<code>[SOURCE]:IQ:OUTPut:DIGital:CHANnel<st0>:NAME</code>	770
<code>[SOURCE]:IQ:OUTPut:DIGital:CHANnel<st0>:SRATe</code>	770
<code>[SOURCE]:IQ:OUTPut:DIGital:CHANnel<st0>:STATe</code>	771
<code>[SOURCE]:IQ:OUTPut:DIGital:SRATe:SUM?</code>	771
<code>[SOURCE]:IQ:OUTPut:DIGital:SRATe:MAX?</code>	771

`[SOURCE<hw>]:IQ:OUTPut:DIGital:STATe <State>`

Activates the digital I/Q signal output.

Parameters:

`<State>` 1 | ON | 0 | OFF
 *RST: 0

Example:

```

SOURCE:IQ:OUTPut:DIGital:STATe ON
// activates the output connector

```

Manual operation: See "State" on page 274**`[SOURCE<hw>]:IQ:OUTPut:DIGital:INTErface <BboutInterfMode>`**

Queries the connector at that the signal is output.

Parameters:

<BboutInterfMode> HSDin
HSDin
 Dig. IQ HS x
 *RST: HSDin

[[:SOURce<hw>]:IQ:OUTPut:DIGital:SRate <SRate>

Sets the sample rate of the digital I/Q output signal.

Parameters:

<SRate> float
 Range: 400 to depends on options
 Increment: 0.001
 *RST: 1E8
 Default unit: Hz
 The maximum value depends on the connected receiving device. For more information, see data sheet.

Manual operation: See "[Value](#)" on page 274

[[:SOURce<hw>]:IQ:OUTPut:DIGital:CDEvice?

Queries information on the connected device.

Return values:

<CDevice> string

Example: SOURce:IQ:OUTPut:DIGital:CDEvice?

Usage: Query only

Manual operation: See "[Connected Device](#)" on page 274

[[:SOURce]:IQ:OUTPut:DIGital:POWER:VIA <Via>

Selects the respective level entry field for the I/Q output.

Parameters:

<Via> PEP | LEVel
 *RST: PEP

Example: SOURce:IQ:OUTPut:DIGital:POWER:VIA PEP

Manual operation: See "[Set Level Via](#)" on page 277

**[[:SOURce]:IQ:OUTPut:DIGital:BBMM<ch>:CHANnel<st0>:POWER:PEP
 <BboutPepHs>**

Sets the peak level of the channel of the HS digital I/Q output signal.

The level is relative to full scale of 0.5 V (in terms of dB full scale).

Parameters:

<BboutPepHs> float
 Range: -60 to 0
 Increment: 0.01
 *RST: 0

Example: See [Example "Enabling and configuring the Dig. IQ HS x digital outputs"](#) on page 767.

Manual operation: See ["Peak Level"](#) on page 275

[:SOURce] : IQ : OUTPut : DIGital : BBMM <ch> : CHANnel <st0> : POWer : LEVel
 <BboutHsLevel>

Sets the RMS level of the channel of the HS digital I/Q output signal.

The level is relative to full scale of 0.5 V (in terms of dB full scale).

Parameters:

<BboutHsLevel> float
 Range: -60 to 0
 Increment: 0.01
 *RST: 0

Example: See [Example "Enabling and configuring the Dig. IQ HS x digital outputs"](#) on page 767.

Manual operation: See ["Level"](#) on page 276

[:SOURce <hw>] : IQ : OUTPut : DIGital : POWer : STEP : MODE <Mode>

Defines the type of step size to vary the digital output power step by step.

Parameters:

<Mode> DECimal | USER

DECimal

Increases or decreases the level in steps of 10 dB.

USER

Increases or decreases the level in increments, determined with the command `[:SOURce <hw>] : IQ : OUTPut : DIGital : POWer : STEP [: INCRement]`.

*RST: DECimal

Example:

```
SOURce:IQ:OUTPut:DIGital:POWer:STEP:MODE USER
SOURce:IQ:OUTPut:DIGital:POWer:STEP 5
// Activates the step width to vary the level in 5 dB steps.
```

[:SOURce <hw>] : IQ : OUTPut : DIGital : POWer : STEP [: INCRement] <Increment>

Sets the step width. Use this value to vary the digital I/Q output level step-by-step.

Parameters:

<Increment> float
 Range: 0 to 100
 Increment: 0.01
 *RST: 1

Example: See [\[:SOURce<hw>\]:IQ:OUTPut:DIGital:POWer:STEP:MODE](#) on page 769.

[:SOURce<hw>]:IQ:OUTPut:DIGital:PON <Pon>

Sets the power-on state of the selected digital I/Q output.

Parameters:

<Pon> OFF | UNCHanged
 *RST: OFF

Example:

```
SOURce:IQ:OUTPut:DIGital:PON OFF
// Deactivates the output connector,
// when the instrument is switched on.
```

Manual operation: See ["Power-On State"](#) on page 278

[:SOURce]:IQ:OUTPut:DIGital:CHANnel<st0>:NAME <DigIqHsCHName>

Sets the channel name.

Parameters:

<DigIqHsCHName> string

Example: See [Example"Enabling and configuring the Dig. IQ HS x digital outputs"](#) on page 767.

Options: R&S SMCVB-K19

Manual operation: See ["Name"](#) on page 275

[:SOURce]:IQ:OUTPut:DIGital:CHANnel<st0>:SRATe <DigIqHsSratChan>

Sets the sample rate of the channel of the HS digital I/Q output signal.

Parameters:

<DigIqHsSratChan> float
 Range: 400 to depends on options
 Increment: 0.001
 *RST: 100E6

The maximum value depends on the connected receiving device. For more information, see data sheet.

Example: See [Example"Enabling and configuring the Dig. IQ HS x digital outputs"](#) on page 767.

Options: R&S SMCVB-K19

Manual operation: See ["Sample Rate"](#) on page 275

[[:SOURce]:IQ:OUTPut:DIGital:CHANnel<st0>:STATe <DigIqHsOutChSta>

Activates the channel.

Parameters:

<DigIqHsOutChSta> 1 | ON | 0 | OFF
*RST: 1

Example: See [Example"Enabling and configuring the Dig. IQ HS x digital outputs"](#) on page 767.

Options: R&S SMCVB-K19

Manual operation: See ["Active"](#) on page 276

[[:SOURce]:IQ:OUTPut:DIGital:SRATe:SUM?

[[:SOURce]:IQ:OUTPut:DIGital:SRATe:MAX?

Queries the maximum supported sample rate.

Return values:

<DigIqHsInSRMax> integer
Range: 400 to depends on options
*RST: depends on options
The maximum value depends on the connected receiving device. For more information, see data sheet.

Example: See [Example"Enabling and configuring the Dig. IQ HS x digital outputs"](#) on page 767.

Usage: Query only

Options: R&S SMCVB-K19

Manual operation: See ["Aggregated Link Sample Rate"](#) on page 276

14.16.9 SOURce:LIST subsystem

The SOURce:LIST subsystem contains all commands for defining lists and for handling of list files.

List files have the predefined file extension *.lsw.

Refer to [Chapter 14.5.2, "Accessing files in the default or in a specified directory"](#), on page 583 for general information on file handling in the default and in a specific directory.



- *RST does not affect data lists.
- SCPI refers to the individual lists as segments.

Example: Create an RF list and activate the list mode

The following example shows a command sequence to create an RF list and to activate the list mode. Further hardware settings are not considered.

```
// Reset the instrument to start from an initial state
// Query the available list files in the default
// directory /var/user
// Select the list file or create it (if not existing)
*RST; *CLS
SOUR1:LIST:CAT?
// Response:- shows the name of available list files (if applicable)
SOUR1:LIST:SEL "/var/user/list1.lsw"

// Write the frequency/level/dwell time values in the selected list file
// existing data is overwritten
// Query the number of frequency/power/dwell time entries in the selected list
// Query the amount of free memory (in bytes) for list mode lists
SOUR1:LIST:FREQ 58 MHz, 61 MHz, 73 MHz, 86 MHz, 91 MHz, 92 MHz, 98 MHz
SOUR1:LIST:POW 13 dBm, 12 dBm, 5 dBm, 3 dBm, 0 dBm, 4 dBm, 6 dBm
SOUR1:LIST:DWEL:LIST 10000, 100000, 200000, 19000, 10000, 150000, 220000
SOUR1:LIST:FREQ:POIN?
// 7
SOUR1:LIST:POW:POINT?
// 7
SOUR1:LIST:DWEL:LIST:POIN?
// 7
SOUR1:LIST:FREE?
// 2147483647 (bytes of free memory)

// Use dwell times from list
// Configure the list mode parameters
// Enable RF output
SOUR1:LIST:MODE AUTO
SOUR1:LIST:TRIG:SOUR AUTO
SOUR1:LIST:DWEL:MODE "LIST"

OUTP1:STAT ON

// Use global dwell time
// Set only a part of the list (value pairs 3 to 5) to be processed
// Configure the list mode parameters using global dwell time
// Enable RF output
SOUR1:LIST:IND:START 2
SOUR1:LIST:IND:STOP 4
SOUR1:LIST:MODE AUTO
SOUR1:LIST:TRIG:SOUR AUTO
SOUR1:LIST:DWEL:LIST 500 ms
OUTP1:STAT ON

// Enable the list mode
// Trigger the list (depending on the mode, not needed with trigger
```

```

// mode AUTO); query the current index
// Reset the list to the starting point
SOUR1:FREQ:MODE LIST
SOUR1:LIST:TRIG:EXEC
SOUR1:LIST:RUNN?
SOUR1:LIST:IND?
// 3
// value changes when the value is queried again
SOUR1:LIST:RES

// For list mode STEP use the following commands
*RST; *CLS
// Change list mode to STEP
SOUR1:LIST:MODE STEP
// Activate RF Output1
OUTP1:STAT 1
// Activate the list mode
SOUR1:FREQ:MODE LIST
// For each step: select frequency/powerlevel pair as index from the list
SOUR1:LIST:IND 2
SOUR1:LIST:IND 3
SOUR1:LIST:IND 4

// Use the selected list for path B (with List Mode B default settings)
SOUR2:LIST:SEL "/var/user/list1.lsw"
OUTP2:STAT ON
SOUR2:FREQ:MODE LIST
SOUR2:LIST:IND?
// 2
// value changes when the value is queried again

// Deactivate the list mode
SOUR1:FREQ:MODE CW

```

Example: List mode data exchange

The following example shows a command sequence to export a list (here the RF list created with the example before) into an ASCII file. Further hardware settings are not considered.

```

*RST; *CLS
LIST:DEXC:MODE EXP

// Set ASCII data parameters
// Set the ASCII file extension, the decimal separator
// and the column separator for the ASCII data
SOUR1:LIST:DEXC:AFIL:EXT CSV
SOUR1:LIST:DEXC:AFIL:SEP:DEC DOT
SOUR1:LIST:DEXC:AFIL:SEP:COL COMM

// Select source and destination path/directory

```

```
// Query available listfiles in default directory "/var/user"
SOUR1:LIST:CAT?
// list1
SOUR1:LIST:DEXC:AFIL:SEL "/var/user/list1ASCII"
SOUR1:LIST:DEXC:SEL "/var/user/list1"

// Export the list file data into the ASCII file
SOUR1:LIST:DEXC:EXEC

// Query the available ASCII files with extension .csv
SOUR1:LIST:DEXC:AFIL:CAT?
// Response: "list1ASCII"

// Deactivate the list mode
SOUR1:FREQ:MODE CW
```

- [List mode settings](#)..... 774
- [List mode file operation](#).....780
- [List mode data exchange](#).....782

14.16.9.1 List mode settings

With the following commands, you can create list mode data, select the trigger mode and determine the dwell time.

[:SOURce<hw>]:LIST:DWELI	774
[:SOURce<hw>]:LIST:DWELI:MODE	775
[:SOURce<hw>]:LIST:DWELI:LIST	775
[:SOURce<hw>]:LIST:DWELI:LIST:POINts?	775
[:SOURce<hw>]:LIST:FREQuency	776
[:SOURce<hw>]:LIST:FREQuency:POINts?	776
[:SOURce<hw>]:LIST:INDEx	776
[:SOURce<hw>]:LIST:INDEx:START	777
[:SOURce<hw>]:LIST:INDEx:STOP	777
[:SOURce<hw>]:LIST:RMODE	777
[:SOURce<hw>]:LIST:LEARN	777
[:SOURce<hw>]:LIST:MODE	778
[:SOURce<hw>]:LIST:POWEr	778
[:SOURce<hw>]:LIST:POWEr:POINts?	779
[:SOURce<hw>]:LIST:TRIGger:EXECute	779
[:SOURce<hw>]:LIST:TRIGger:SOURce	779
[:SOURce<hw>]:LIST:RUNNing?	780

[:SOURce<hw>]:LIST:DWELI <Dwell>

Sets the global dwell time. The instrument generates the signal with the frequency / power value pairs of each list entry for that particular period.

See also [Significant parameters and functions](#).

Parameters:

<Dwell> float
 Range: 0.5E-3 to 100
 Increment: 1E-6
 *RST: 0.01

Example: See [Example "Create an RF list and activate the list mode"](#) on page 772.

Manual operation: See ["Global Dwell Time"](#) on page 343

[:SOURce<hw>] :LIST:DWELI:MODE <DwelMode>

Selects the dwell time mode.

Parameters:

<DwelMode> LIST | GLOBal
LIST
 Uses the dwell time, specified in the data table for each value pair individually.
GLOBal
 Uses a constant dwell time, set with command [:
[SOURce<hw> \] :LIST:DWELI.](#)
 *RST: GLOBal

Example: See [Example "Create an RF list and activate the list mode"](#) on page 772.

Manual operation: See ["Dwell Time Mode"](#) on page 343

[:SOURce<hw>] :LIST:DWELI:LIST <Dwell>

Enters the dwell time values in the selected list in μ s.

Parameters:

<Dwell> <Dwell#1>{, <Dwell#2>, ...} | block data
 You can either enter the data as a list of numbers, or as binary block data. The list of numbers can be of any length, with the list entries separated by commas.
 In binary block format, 8 (4) bytes are always interpreted as a floating-point number with double accuracy. See also :
[FORMat \[:DATA \]](#) on page 612 for more details.

Example: See [Example "Create an RF list and activate the list mode"](#) on page 772.

Manual operation: See ["Edit List Mode Data"](#) on page 349

[:SOURce<hw>] :LIST:DWELI:LIST:POINTS?

Queries the number (points) of dwell time entries in the selected list.

Return values:

<Points> integer
 Range: 0 to INT_MAX
 *RST: 0

Example: See [Example "Create an RF list and activate the list mode"](#) on page 772.

Usage: Query only

[:SOURce<hw>]:LIST:FREQuency <Frequency>

Enters the frequency values in the selected list.

Parameters:

<Frequency> <Frequency#1>{, <Frequency#2>, ...} | block data
 You can either enter the data as a list of numbers, or as binary block data.
 The list of numbers can be of any length, with the list entries separated by commas.
 In binary block format, 8 (4) bytes are always interpreted as a floating-point number with double accuracy.
 See also : [FORMat \[: DATA \]](#).
 Range: 300 kHz to RFmax (depends on the installed options)

Example: See [Example "Create an RF list and activate the list mode"](#) on page 772.

Manual operation: See ["Edit List Mode Data"](#) on page 349

[:SOURce<hw>]:LIST:FREQuency:POINts?

Queries the number (points) of frequency entries in the selected list.

Return values:

<Points> integer
 Range: 0 to INT_MAX
 *RST: 0

Example: See [Example "Create an RF list and activate the list mode"](#) on page 772.

Usage: Query only

[:SOURce<hw>]:LIST:INDEx <Index>

Sets the list index in [LIST:MODE STEP](#).

After the trigger signal, the instrument processes the frequency and level settings of the selected index.

Parameters:

<Index> integer
 *RST: 0

Example: See [Example "Create an RF list and activate the list mode"](#) on page 772.

Manual operation: See ["Current Index"](#) on page 342

[:SOURce<hw>]:LIST:INDEX:START <Start>

[:SOURce<hw>]:LIST:INDEX:STOP <Stop>

Sets the start and stop index of the index range which defines a subgroup of frequency/level value pairs in the current list.

Parameters:

<Stop> integer
 Index range
 Only values inside this range are processed in list mode
 Range: 0 to list length
 *RST: 0

Example: See [Example "Create an RF list and activate the list mode"](#) on page 772.

Manual operation: See ["List Range from/to"](#) on page 345

[:SOURce<hw>]:LIST:RMODE <RMode>

Selects the run mode for processing the list.

Parameters:

<RMode> LEARNed | LIVE
LEARNed
 Generates the signal by replaying the previously learned and saved data from the temporary memory.
LIVE
 Generates the signal by processing the list directly.
 *RST: LIVE

Example: See [Example "Create an RF list and activate the list mode"](#) on page 772.

Manual operation: See ["Run Mode"](#) on page 343

[:SOURce<hw>]:LIST:LEARN

Learns the selected list to determine the hardware setting for all list entries. The results are saved with the list.

See also ["Learn List Mode Data list processing mode"](#) on page 332.

- Example:** See [Example"Create an RF list and activate the list mode"](#) on page 772.
- Usage:** Event
- Manual operation:** See "[Learn List Mode Data](#)" on page 344

[:SOURce<hw>]:LIST:MODE <Mode>

Sets the list mode.

The instrument processes the list according to the selected mode and trigger source. See [LIST:TRIG:SOUR AUTO](#), [SING](#) or [EXT](#) for the description of the trigger source settings.

Parameters:

<Mode> AUTO | STEP

AUTO

Each trigger event triggers a complete list cycle.

STEP

Each trigger event triggers only one step in the list processing cycle. The list is processed in ascending order.

*RST: AUTO

- Example:** See [Example"Create an RF list and activate the list mode"](#) on page 772.
- Manual operation:** See "[Mode](#)" on page 343

[:SOURce<hw>]:LIST:POWer <Power>

Enters the level values in the selected list. The number of level values must correspond to the number of frequency values. Existing data is overwritten.

Parameters:

<Power> <Power#1>{, <Power#2>, ...} | block data

You can either enter the data as a list of numbers, or as binary block data.

The list of numbers can be of any length, with the list entries separated by commas.

In binary block format, 8 (4) bytes are always interpreted as a floating-point number with double accuracy.

See also [:FORMat \[:DATA\]](#).

Range: depends on the installed options

Default unit: dBm

- Example:** See [Example"Create an RF list and activate the list mode"](#) on page 772.
- Manual operation:** See "[Edit List Mode Data](#)" on page 349

[:SOURce<hw>]:LIST:POWer:POINts?

Queries the number (points) of level entries in the selected list.

Return values:

<Points> integer
 Range: 0 to INT_MAX
 *RST: 0

Example: See [Example "Create an RF list and activate the list mode"](#) on page 772.

Usage: Query only

[:SOURce<hw>]:LIST:TRIGger:EXECute

Starts the processing of a list in list mode.

Example: See [Example "Create an RF list and activate the list mode"](#) on page 772.

Usage: Event

Manual operation: See ["Execute Single"](#) on page 344

[:SOURce<hw>]:LIST:TRIGger:SOURce <Source>

Selects the trigger source for processing lists.

The designation of the parameters correspond to those in sweep mode. SCPI standard uses other designations for the parameters, which are also accepted by the instrument. The SCPI designation should be used if compatibility is an important consideration. For an overview, see the following table:

Rohde & Schwarz parameter	SCPI parameter	Applies to the list mode parameters:
AUTO	IMMediate	[:SOURce<hw>]:LIST:MODE AUTO
SINGle	BUS	[:SOURce<hw>]:LIST:MODE AUTO or [:SOURce<hw>]:LIST:MODE STEP
EXTernal	EXTernal	[:SOURce<hw>]:LIST:MODE AUTO or [:SOURce<hw>]:LIST:MODE STEP

Parameters:

<Source> AUTO | IMMediate | SINGle | BUS | EXTernal

AUTO|IMMediate

The trigger is free-running, i.e. the trigger condition is fulfilled continuously. The selected list is restarted as soon as it is finished.

SINGle|BUS

The list is triggered by the command [:SOURce<hw>]:LIST:TRIGger:EXECute. The list is executed once.

EXtErnal

The list is triggered externally and executed once.

*RST: AUTO

Example: See [Example"Create an RF list and activate the list mode"](#) on page 772.

Manual operation: See ["Mode"](#) on page 343

[[:SOURce<hw>]:LIST:RUNNING?

Queries the current state of the list mode.

Return values:

<State> 1 | ON | 0 | OFF

1

Signal generation based on the list mode is active.

Example: See [Example"Create an RF list and activate the list mode"](#) on page 772.

Usage: Query only

14.16.9.2 List mode file operation

The following section covers basic commands to file handling in list mode.

[:SOURce<hw>]:LIST:CATalog?	780
[:SOURce<hw>]:LIST:DELeTe	780
[:SOURce<hw>]:LIST:DELeTe:ALL	781
[:SOURce<hw>]:LIST:FREE?	781
[:SOURce<hw>]:LIST:RESet	782
[:SOURce<hw>]:LIST:SELeCt	782

[[:SOURce<hw>]:LIST:CATalog?

Queries the available list files in the specified directory.

Return values:

<Catalog> string

List of list filenames, separated by commas

Example: See [Example"Create an RF list and activate the list mode"](#) on page 772.

Usage: Query only

Manual operation: See ["List Mode Data"](#) on page 345

[[:SOURce<hw>]:LIST:DELeTe <Filename>

Deletes the specified list.

Setting parameters:

<Filename> string
 Filename or complete file path; file extension is optional.

Example: See [\[:SOURce<hw>\]:LIST:DELeTe:ALL](#) on page 781.

Usage: Setting only

Manual operation: See "[List Mode Data](#)" on page 345

[:SOURce<hw>]:LIST:DELeTe:ALL

Deletes all lists in the set directory.

This command can only be executed, if:

- No list file is selected.
- List mode is disabled.

Example:

```
SOUR1:LIST:CAT?
// list,my_list
SOUR1:LIST:DEL "/var/user/list1"
SOUR1:LIST:CAT?
// my_list
SOUR1:FREQ:MODE?
// LIST
SOUR1:LIST:SEL?
// /var/user/my_list.lsw
//deactivate list mode
SOUR1:FREQ:MODE CW
SOUR1:LIST:DELeTe:ALL
SOUR1:LIST:CAT?
// -
// all list files are deleted
```

Usage: Event

Manual operation: See "[List Mode Data](#)" on page 345

[:SOURce<hw>]:LIST:FREE?

Queries the amount of free memory (in bytes) for list mode lists.

Return values:

<Free> integer
 Range: 0 to INT_MAX
 *RST: 0

Example: See [Example"Create an RF list and activate the list mode"](#) on page 772.

Usage: Query only

[:SOURce<hw>]:LIST:RESet

Jumps to the beginning of the list.

Example: See [Example "Create an RF list and activate the list mode"](#) on page 772.

Usage: Event

Manual operation: See ["Reset"](#) on page 344

[:SOURce<hw>]:LIST:SElect <Filename>

Selects or creates a data list in list mode.

If the list with the selected name does not exist, a new list is created.

Parameters:

<Filename> string
Filename or complete file path; file extension can be omitted.

Example: See [Example "Create an RF list and activate the list mode"](#) on page 772.

Manual operation: See ["List Mode Data"](#) on page 345

14.16.9.3 List mode data exchange

With the following commands, you can configure lists in ASCII format and export or import them accordingly.

[:SOURce<hw>]:LIST:DEXChange:AFILe:CATalog?	782
[:SOURce<hw>]:LIST:DEXChange:EXECute	783
[:SOURce<hw>]:LIST:DEXChange:AFILe:EXTension	783
[:SOURce<hw>]:LIST:DEXChange:AFILe:SElect	783
[:SOURce<hw>]:LIST:DEXChange:AFILe:SEParator:COLumn	783
[:SOURce<hw>]:LIST:DEXChange:AFILe:SEParator:DECimal	784
[:SOURce<hw>]:LIST:DEXChange:MODE	784
[:SOURce<hw>]:LIST:DEXChange:SElect	784

[:SOURce<hw>]:LIST:DEXChange:AFILe:CATalog?

Queries the available ASCII files for export or import of list mode data in the current or specified directory.

Return values:

<Catalog> string
List of ASCII files *.txt or *.csv, separated by commas.

Example: See [Example "List mode data exchange"](#) on page 773.

Usage: Query only

Manual operation: See ["Select \(ASCII\) Source/Select \(ASCII\) Destination"](#) on page 347

[:SOURce<hw>]:LIST:DEXChange:EXECute

Executes the import or export of the selected list file, according to the previously set transfer direction with command `[:SOURce<hw>] :LIST:DEXChange:MODE`

Example: See [Example"List mode data exchange"](#) on page 773.

Usage: Event

Manual operation: See ["Import / Export"](#) on page 347

[:SOURce<hw>]:LIST:DEXChange:AFILe:EXTension <Extension>

Determines the extension of the ASCII file for import or export, or to query existing files.

Parameters:

<Extension> TXT | CSV
*RST: TXT

Example: See [Example"List mode data exchange"](#) on page 773.

Manual operation: See ["ASCII File Settings"](#) on page 346

[:SOURce<hw>]:LIST:DEXChange:AFILe:SElect <Filename>

Selects the ASCII file to be imported or exported.

Parameters:

<Filename> string
Filename or complete file path; file extension can be omitted.

Example: See [Example"List mode data exchange"](#) on page 773.

Manual operation: See ["Select \(ASCII\) Source/Select \(ASCII\) Destination"](#) on page 347

[:SOURce<hw>]:LIST:DEXChange:AFILe:SEParator:COLumn <Column>

Selects the separator between the frequency and level column of the ASCII table.

Parameters:

<Column> TABulator | SEMicolon | COMMa | SPACe
*RST: COMMa

Example: See [Example"List mode data exchange"](#) on page 773.

Manual operation: See ["ASCII File Settings"](#) on page 346

[:SOURce<hw>]:LIST:DEXChange:AFILe:SEParator:DECimal <Decimal>

Sets "." (decimal point) or "," (comma) as the decimal separator used in the ASCII data with floating-point numerals.

Parameters:

<Decimal> DOT | COMMa
 *RST: DOT

Example: See [Example "List mode data exchange"](#) on page 773.

Manual operation: See ["ASCII File Settings"](#) on page 346

[:SOURce<hw>]:LIST:DEXChange:MODE <Mode>

Determines the import or export of a list.

Specify the source or destination file with the command [\[:SOURce<hw>\]:LIST:DEXChange:SElect](#).

Parameters:

<Mode> IMPort | EXPort
 *RST: IMPort

Example: See [Example "List mode data exchange"](#) on page 773.

Manual operation: See ["Mode"](#) on page 346

[:SOURce<hw>]:LIST:DEXChange:SElect <Filename>

Selects the ASCII file for import or export, containing a list.

Parameters:

<Filename> string
 Filename or complete file path; file extension can be omitted.

Example: See [Example "List mode data exchange"](#) on page 773.

Manual operation: See ["Select Source/Select ASCII Destination"](#) on page 347

14.16.10 SOURce:PHASe subsystem

This subsystem contains the commands for adjusting the phase of the RF output signal relative to a reference signal of the same frequency.

Example: Programming Example

```
// change the phase relative to the current phase
SOURce1:PHASe 2 DEG
// adopt the setting as the current phase
SOURce1:PHASe:REFerence
```

The following commands are available:

[:SOURce<hw>]:PHASe.....	785
[:SOURce<hw>]:PHASe:REFerence.....	785

[:SOURce<hw>]:PHASe <Phase>

Sets the phase variation relative to the current phase.

Parameters:

<Phase>	float
	Range: -36000 to 36000
	Increment: 0.001
	*RST: 0
	Default unit: DEG

Example: See [Example "Programming Example"](#) on page 784.

Manual operation: See ["Delta Phase"](#) on page 311

[:SOURce<hw>]:PHASe:REFerence

Example: See [Example "Programming Example"](#) on page 784.

Usage: Event

Manual operation: See ["Reset Delta Phase Display"](#) on page 311

14.16.11 SOURce:POWer subsystem

The SOURce:POWer subsystem contains the commands for setting the output level, level control and level correction of the RF signal.

The default units are dBm. To change the units, perform one of the following:

- Enter the unit after the numerical value
Example: :POW 0.5V
- Set the unit with the command :UNIT:POWer.

Example: Configure the settings for NRP power control

The example shows a command sequence to configure the parameters for a closed loop power control setup. It is assumed that you have set up the measurement with the amplifier, external coupler, the power sensor and the R&S SMCV100B as described in [Chapter 8.10.3.3, "NRP power control"](#), on page 372.

```
// Reset the instrument to start from an initial state
*RST; *CLS

// Select the sensor used for nrp power control
// that is e.g., connected to a second USB interface

[:SOURce<hw>]:POWer:SPC:SElect SENS2
```

```
// Configure the nrp power control settings
// use the measured peak power for power control
// set the unit dBm for the target level value
// set the target level, e.g. - 10 dBm
// use the measured target level as reference level
// select single measurement mode to acquire one level value
// set the capture range for the control loop, e.g. +/- 15 dB
// set a time delay between the sensor readings, e.g. 2 ms
```

```
[ :SOURce<hw> ]:POWer:SPC:PEAK ON
:SENSe<ch>:UNIT[:POWer] DMB
[:SOURce<hw>]:POWer:SPC:TARGet -10
[:SOURce<hw>]:POWer:SPC:MEASure
[:SOURce<hw>]:POWer:SPC:MODE SINGLE
[:SOURce<hw>]:POWer:SPC:CRANge 15
[:SOURce<hw>]:POWer:SPC:DELay 2 ms
```

```
// Enable NRP power control measurement
// switch on RF output
// start the single measurement manually
```

```
Output1:STATe 1
```

```
[ :SOURce<hw> ]:POWer:SPC:STATe ON
[:SOURce<hw>]:POWer:SPC:SINGLE
```

[:SOURce<hw>]:POWer:ALC:MODE?	787
[:SOURce<hw>]:POWer:ALC:SONCe	787
[:SOURce<hw>]:POWer:ATTenuation:RFOFF:MODE	787
[:SOURce<hw>]:POWer:EMF:STATe	788
[:SOURce<hw>]:POWer:LBEHaviour	788
[:SOURce<hw>]:POWer:LIMit[:AMPLitude]	788
[:SOURce<hw>]:POWer:MANual	788
[:SOURce<hw>]:POWer:MODE	789
[:SOURce<hw>]:POWer:PEP?	789
[:SOURce<hw>]:POWer:POWer	790
[:SOURce<hw>]:POWer:START	790
[:SOURce<hw>]:POWer:STOP	790
[:SOURce<hw>]:POWer:SPC:CRANge	791
[:SOURce<hw>]:POWer:SPC:DELay	791
[:SOURce<hw>]:POWer:SPC:MEASure	791
[:SOURce<hw>]:POWer:SPC:MODE	791
[:SOURce<hw>]:POWer:SPC:PEAK	792
[:SOURce<hw>]:POWer:SPC:SELEct	792
[:SOURce<hw>]:POWer:SPC:SINGLE	792
[:SOURce<hw>]:POWer:SPC:STATe	792
[:SOURce<hw>]:POWer:SPC:TARGet	793
[:SOURce<hw>]:POWer:STEP:MODE	793
[:SOURce<hw>]:POWer:STEP[:INCRement]	793

<code>[:SOURce<hw>]:POWer[:LEVel][:IMMediate]:OFFSet</code>	794
<code>[:SOURce<hw>]:POWer[:LEVel][:IMMediate]:RCL</code>	794
<code>[:SOURce<hw>]:POWer[:LEVel][:IMMediate][:AMPLitude]</code>	795
<code>[:SOURce<hw>]:POWer[:LEVel][:IMMediate]:REFLevel</code>	795
<code>[:SOURce<hw>]:POWer:RANGe:LOWer?</code>	796
<code>[:SOURce<hw>]:POWer:RANGe:UPPer?</code>	796

`[:SOURce<hw>]:POWer:ALC:MODE?`

Queries the currently set ALC mode.

Return values:

`<PowAlcMode>` 0 | AUTO | 1 | PRESet | OFFTable | ON | OFF | ONSample | ONTable

Example: `POW:ALC:MODE?`
Response: `ONTable`"Table and On" is set automatically.

Usage: Query only

`[:SOURce<hw>]:POWer:ALC:SONCe`

Activates level control for correction purposes temporarily.

Example: `POW:ALC OFF`
Deactivates automatic level control at the RF output.
`POW:ALC:SONC`
Executes level control (once).

Usage: Event

Manual operation: See "[Readjust](#)" on page 310

`[:SOURce<hw>]:POWer:ATTenuation:RFOff:MODE <Mode>`

Selects the state the attenuator is to assume if the RF signal is switched off.

Parameters:

`<Mode>` UNCHanged | FATTenuation

FATTenuation

The step attenuator switches to maximum attenuation

UNCHanged

Retains the current setting and keeps the output impedance constant during RF off.

*RST: n.a. (factory preset: FATTenuation)

Example: `SOURce1:POWer:ATTenuation:RFOff:MODE`
`FATTenuation`
uses maximum attenuation when the RF output is turned off.

Manual operation: See "[RF OFF Mode](#)" on page 354

[:SOURce<hw>]:POWer:EMF:STATe <State>

Displays the signal level as voltage of the EMF. The displayed value represents the voltage over a 50 Ohm load.

Parameters:

<State> 1 | ON | 0 | OFF
*RST: n.a. (factory preset: 0)

Example:

POW:EMF:STAT 1
Activates voltage level display.

Manual operation: See ["Display Level as Voltage of EMF"](#) on page 447

[:SOURce<hw>]:POWer:LBEHaviour <Behaviour>

Set the RF level behaviour.

Parameters:

<Behaviour> AUTO | UNINterrupted
UNINterrupted
Do not use the uninterrupted level settings in combination with the high-quality optimization mode (see [\[:SOURce<hw>\]:BB:IMPairment:OPTimization:MODE](#) on page 747)
*RST: AUTO

Example:

SOURce1:POWer:LBEHaviour AUTO

Manual operation: See ["Setting Characteristics"](#) on page 310

[:SOURce<hw>]:POWer:LIMit[:AMPLitude] <Amplitude>

Limits the maximum RF output level in CW and sweep mode.

It does not influence the "Level" display or the response to the query [\[:SOURce<hw>\]:POWer\[:LEVel\]\[:IMMediate\]\[:AMPLitude\]](#).

Parameters:

<Amplitude> float
Range: depends on the installed options
Increment: 0.01
*RST: n.a. (factory preset: 30)

Example:

SOURce1:POWer:LIMit:AMPLitude 10

Manual operation: See ["Limit"](#) on page 309

[:SOURce<hw>]:POWer:MANual <Manual>

Sets the level for the subsequent sweep step if [SWE:POW:MODE MAN](#).

Use a separate command for each sweep step.

Parameters:

<Manual> float

You can select any level within the setting range, where:

START is set with `[:SOURce<hw>] :POWER:START`

STOP is set with `[:SOURce<hw>] :POWER:STOP`

OFFSet is set with `[:SOURce<hw>] :POWER [:LEVel] [:IMMediate] :OFFSet`

Range: (START + OFFSet) to (STOP + OFFSet)

Increment: 0.01

Default unit: dBm

Example: See [Example "Setup an RF frequency or power sweep"](#) on page 801

Manual operation: See ["Current Level"](#) on page 334

[:SOURce<hw>] :POWER:MODE <Mode>

Selects the operating mode of the instrument to set the output level.

Parameters:

<Mode> CW | FIXed | SWEep

CW|FIXed

Operates at a constant level.

CW and FIXed are synonyms.

To set the output level value, use the command `[:SOURce<hw>] :POWER [:LEVel] [:IMMediate] [:AMPLitude]`.

SWEep

Sets sweep mode.

Set the range and current level with the commands:

`[:SOURce<hw>] :POWER:START` and `[:SOURce<hw>] :POWER:STOP`,

`[:SOURce<hw>] :POWER:MANual`.

*RST: CW

Example: See [Example "Setup an RF frequency or power sweep"](#) on page 801

Manual operation: See ["State \(RF level sweep\)"](#) on page 334

[:SOURce<hw>] :POWER:PEP?

Queries the PEP (Peak Envelope Power) of digital modulation or digital standards at the RF output. This value corresponds to the level specification, displayed in the status bar (header).

Return values:

<Pep> float

- Example:** POW:PEP?
Response: "4"
The PEP value of digital modulation is 4 dBm at the RF output.
- Usage:** Query only
- Manual operation:** See ["PEP"](#) on page 304

[:SOURce<hw>]:POWER:POWER <Power>

Sets the level **at the RF output** connector.

This value does not consider a specified offset.

The command `[:SOURce<hw>]:POWER[:LEVel] [:IMMediate] [:AMPLitude]` sets the level of the "Level" display, that means the level containing offset.

See ["RF frequency and level display with a downstream instrument"](#) on page 305.

Parameters:

<Power> float
Level at the RF output, without level offset
Range: See data sheet
Increment: 0.01
Default unit: dBm

- Example:** SOURce1:POWER:POWER 15
Sets the level at RF output

- Manual operation:** See ["Amplitude"](#) on page 309
See ["Generator Settings used for Measurement"](#) on page 365

[:SOURce<hw>]:POWER:START <Start>

[:SOURce<hw>]:POWER:STOP <Stop>

Sets the RF start/stop level in sweep mode.

Parameters:

<Stop> float
Sets the setting range calculated as follows:
 $(Level_min + OFFSet)$ to $(Level_max + OFFSet)$
Where the values are set with the commands:
`[:SOURce<hw>]:POWER[:LEVel] [:IMMediate]:OFFSet`
`[:SOURce<hw>]:POWER:START`
`[:SOURce<hw>]:POWER:STOP`
Range: Minimum level to maximum level
*RST: -30 (Start)/ -10 (Stop)
Default unit: dBm

- Example:** See [Example"Setup an RF frequency or power sweep"](#) on page 801

- Manual operation:** See ["Start Level / Stop Level"](#) on page 340

[[:SOURce<hw>]:POWER:SPC:CRANge <PowCntrlCRange>

Defines the capture range of the power control system.

Within the range:

Target Level +/- Catch Range

the power control locks and tries to achieve the target level. Readings outside the range are not considered.

Parameters:

<PowCntrlCRange> float
Range: 0 to 50
Increment: 0.01
*RST: 30

Example: See [Example"Configure the settings for NRP power control"](#) on page 785

Manual operation: See ["Catch Range +/-"](#) on page 374

[[:SOURce<hw>]:POWER:SPC:DELay <PowCntrlDelay>

Sets a waiting time for the generator to adjust the output level. After the delay time has elapsed, the power sensor measures the next value.

Parameters:

<PowCntrlDelay> integer
Range: 0 to 1000
*RST: 0

Example: See [Example"Configure the settings for NRP power control"](#) on page 785

Manual operation: See ["Delay Time"](#) on page 375

[[:SOURce<hw>]:POWER:SPC:MEASure

Sets the measured power value as reference level.

Example: See [Example"Configure the settings for NRP power control"](#) on page 785

Usage: Event

Manual operation: See ["Take Measurement as Target Level"](#) on page 374

[[:SOURce<hw>]:POWER:SPC:MODE <ControlMode>

Selects the measurement mode for the power sensor.

Parameters:

<ControlMode> AUTO | SINGle

AUTO

Measures the level values continuously.

SINGle

Executes one measurement, triggered by the command `[:SOURce<hw>] :POWer:SPC:SINGle` on page 792.

*RST: AUTO

Example: See [Example"Configure the settings for NRP power control"](#) on page 785

Manual operation: See ["Mode"](#) on page 374

[:SOURce<hw>] :POWer:SPC:PEAK <PowCntrlPeak>

Activates power control by means of the peak power values, provided the power sensor supports this function.

Parameters:

<PowCntrlPeak> 1 | ON | 0 | OFF

*RST: 0

Example: See [Example"Configure the settings for NRP power control"](#) on page 785

[:SOURce<hw>] :POWer:SPC:SElect <PowCntrlSelect>

Selects the power sensor used for power control.

Parameters:

<PowCntrlSelect> SENS1 | SENS2 | SENS3 | SENS4 | SENSor1 | SENSor2 | SENSor3 | SENSor4

*RST: SENS1

Example: See [Example"Configure the settings for NRP power control"](#) on page 785

Manual operation: See ["Sensor"](#) on page 373

[:SOURce<hw>] :POWer:SPC:SINGle

Triggers the power sensor to measure the power value once.

Usage: Event

Manual operation: See ["Execute Single"](#) on page 374

[:SOURce<hw>] :POWer:SPC:STATe <PowCntrlState>

Starts power control using the selected sensor. The control loop periodically adjusts the output level of the signal generator. After switching off, the running loop is completed.

Parameters:

<PowCntrlState> 1 | ON | 0 | OFF
 *RST: 0

Example: See [Example "Configure the settings for NRP power control"](#) on page 785

Manual operation: See ["State"](#) on page 373

[:SOURce<hw>]:POWER:SPC:TARGET <PowCntrlTarget>

Sets the target level required at the DUT. To define the unit of the power value, use command [:UNIT:POWER](#) on page 839.

Parameters:

<PowCntrlTarget> float
 Range: -50 to 30
 Increment: 0.01
 *RST: -10

Example: See [Example "Configure the settings for NRP power control"](#) on page 785

Manual operation: See ["Target Level"](#) on page 374

[:SOURce<hw>]:POWER:STEP:MODE <Mode>

Defines the type of step width to vary the RF output power step-by-step with the commands [POW UP](#) or [POW DOWN](#).

Parameters:

<Mode> DECimal | USER

DECimal

Increases or decreases the level in steps of ten.

USER

Increases or decreases the level in increments, determined with the command [\[:SOURce<hw> \]:POWER:STEP \[:INCRement \]](#).

*RST: DECimal

Example:
 SOURce1:POWER:STEP:INCRement 2
 SOURce1:POWER:STEP:MODE USER
 SOURce1:POWER:LEVEL:IMMediate:AMPLitude UP
 Increasing the RF level with a step size of 2 dB

Manual operation: See ["Variation Active"](#) on page 307

[:SOURce<hw>]:POWER:STEP[:INCRement] <Increment>

Specifies the step width in the appropriate path for [POW:STEP:MODE USER](#).

To adjust the level step-by-step with this increment value, use the command `POW UP`, or `POW DOWN`.

Parameters:

<Increment> float
 Range: 0 to 200
 Increment: 0.01
 *RST: 1
 Default unit: dB

Example: See `[:SOURce<hw>] :POWer :STEP :MODE` on page 793.

Manual operation: See "Variation Step" on page 307

[:SOURce<hw>] :POWer [:LEVel] [:IMMediate] :OFFSet <Offset>

Sets the level offset of a downstream instrument.

The level at the RF output is not changed.

To query the resulting level, as it is at the output of the downstream instrument, use the command `[:SOURce<hw>] :POWer [:LEVel] [:IMMediate] [:AMPLitude]`.

See "RF frequency and level display with a downstream instrument" on page 305.

Note: The level offset also affects the RF level sweep.

Parameters:

<Offset> float
 Range: -200 to 200
 Increment: 0.01
 *RST: 0
 Default unit: dB
 Level offset is always expreced in dB; linear units (V, W, etc.) are not supported

Example: `POWer :OFFSet 10`
 Sets the RF level offset to 10 dB

Manual operation: See "Offset" on page 309
 See "Generator Settings used for Measurement" on page 365

[:SOURce<hw>] :POWer [:LEVel] [:IMMediate] :RCL <Rcl>

Determines whether the current level is retained or if the stored level setting is adopted when an instrument configuration is loaded.

Parameters:

<Rcl> INCLUDE | EXCLUDE
INCLUDE
 Takes the current level when an instrument configuration is loaded.

EXCLude

Retains the current level when an instrument configuration is loaded.

*RST: INCLude

Example:

POW:RCL INCL

Takes the level value from an instrument configuration loaded with command *RCL.

Manual operation: See "Exclude Level" on page 424

[:SOURce<hw>]:POWer[:LEVel][:IMMediate][:AMPLitude] <Amplitude>

Sets the RF level applied to the DUT.

To activate the RF output use command :OUTPut<hw>[:STATe] ("RF On"/"RF Off").

The following applies $POWer = RF\ output\ level + OFFSet$, where:

- $POWer$ is the values set with `[:SOURce<hw>]:POWer[:LEVel][:IMMediate][:AMPLitude]`
- RF output level is set with `[:SOURce<hw>]:POWer:POWer`
- $OFFSet$ is set with `[:SOURce<hw>]:POWer[:LEVel][:IMMediate]:OFFSet`

Parameters:

<Amplitude>

float

The following settings influence the value range:

$OFFSet$ set with the command `[:SOURce<hw>]:POWer[:LEVel][:IMMediate]:OFFSet`

Numerical value

Sets the level

UP|DOWN

Varies the level step by step.

The level is increased or decreased by the value set with the command `[:SOURce<hw>]:POWer:STEP[:INCRement]`.

Range: (Level_min + OFFSet) to (Level_max + OFFSet)

*RST: -30

Default unit: dBm

Example:

POWer -30

Sets the RF level

Example:

See also `[:SOURce<hw>]:POWer:STEP:MODE` on page 793.

Manual operation: See "Amplitude" on page 309

[:SOURce<hw>]:POWer[:LEVel][:IMMediate]:REFLevel <ReferenceLevel>

Queries the reference level of the user correction.

The reference level is the sum of the amplitude and the level offset, set with the commands `[:SOURce<hw>] :POWer:POWer [:SOURce<hw>] :POWer [:LEVel] [:IMMediate] :OFFSet`.

Parameters:

<ReferenceLevel> float
 Range: -245 to 120
 Increment: 0.01
 *RST: -30

Manual operation: See "[Generator Settings used for Measurement](#)" on page 365

`[:SOURce<hw>] :POWer:RANGe:LOWer?`

`[:SOURce<hw>] :POWer:RANGe:UPPer?`

Queries the current interruption-free range of the level.

Return values:

<Upper> float
 Increment: 0.01
 Default unit: dBm

Example:

```
SOURce1:POWer:RANGe:UPPer?
// -15
SOURce1:POWer:RANGe:LOW?
// -50
```

Usage: Query only

Manual operation: See "[Level Range](#)" on page 310

14.16.12 SOURce:ROSCillator subsystem

The `SOURce:ROSCillator` subsystem contains the commands for setting the external and internal reference frequency.



The commands of this subsystem are not affected by an instrument reset (`*RST` on page 578).

Example: Configuring the reference oscillator

```
// Using 10 MHz external reference source
SOURce:ROSCillator:SOURce EXT
SOURce:ROSCillator:EXTErnal:RFOFF:STATe 1
SOURce:ROSCillator:EXTErnal:FREQuency?
// Response: 10MHZ
SOURce:ROSCillator:EXTErnal:SBANDwidth WIDE
SOURce:ROSCillator:INTErnal:ADJust:STATe 0

// Query calibration value
CALibration:ROSCillator?
// 32767
// Set an internal source
// Activate user-defined adjustment value of 1000
SOURce:ROSCillator:SOURce INT
SOURce:ROSCillator:INTErnal:ADJust:STATe 1
SOURce:ROSCillator:INTErnal:ADJust:VALue 1000

// to resume calibrated state
SOURce:ROSCillator:INTErnal:ADJust:VALue 0
SOURce:ROSCillator:INTErnal:ADJust:STATe 0
// or
// SYSTEM:FPRest
```

[SOURce]:ROSCillator:PRESet.....	797
[SOURce]:ROSCillator:SOURce.....	797
[SOURce]:ROSCillator:EXTErnal:RFOFF[:STATe].....	798
[SOURce]:ROSCillator:EXTErnal:FREQuency.....	798
[SOURce]:ROSCillator:EXTErnal:SBANDwidth.....	798
[SOURce]:ROSCillator:EXTErnal:MLRange?.....	799
[SOURce]:ROSCillator:EXTErnal:NSBandwidth?.....	799
[SOURce]:ROSCillator:OUTPut:FREQuency:MODE.....	799
[SOURce]:ROSCillator[:INTErnal]:ADJust:VALue.....	800
[SOURce]:ROSCillator[:INTErnal]:ADJust[:STATe].....	800

[SOURce]:ROSCillator:PRESet

Resets the reference oscillator settings.

Example: See [Example "Configuring the reference oscillator"](#) on page 797.

Usage: Event

Manual operation: See ["Set to Default"](#) on page 313

[SOURce]:ROSCillator:SOURce <Source>

Selects between internal or external reference frequency.

Parameters:

<Source> INTernal | EXTErnal
 *RST: n.a. (factory preset: INTernal)

Example: See [Example"Configuring the reference oscillator"](#) on page 797.

Manual operation: See ["Source"](#) on page 313

[[:SOURce]:ROSCillator:EXTernal:RFOFF[:STATe] <State>

Determines that the RF output is turned off when the external reference signal is selected, but missing.

Parameters:

<State> 1 | ON | 0 | OFF
 *RST: n.a. (factory preset: 0)

Example: See [Example"Configuring the reference oscillator"](#) on page 797.

Manual operation: See ["Deactivate RF Output \(if external reference is missing\)"](#) on page 314

[[:SOURce]:ROSCillator:EXTernal:FREQUENCY <Frequency>

Sets the frequency of the external reference.

Parameters:

<Frequency> 10MHZ | 13MHZ
 *RST: n.a. (factory preset: 10MHZ)

Example: See [Example"Configuring the reference oscillator"](#) on page 797.

Manual operation: See ["External Reference Frequency"](#) on page 314

[[:SOURce]:ROSCillator:EXTernal:SBANDwidth <SBandwidth>

Selects the synchronization bandwidth for the external reference signal.

See [\[:SOURce\]:ROSCillator:SOURce > External](#).

Depending on the RF hardware version, and the installed options, the synchronisation bandwidth varies.

For more information, see data sheet.

Parameters:

<SBandwidth> WIDE | NARRow
NARRow
 The synchronization bandwidth is a few Hz.
WIDE
 Uses the widest possible synchronization bandwidth.
 *RST: n.a. (factory preset)

Example: See [Example"Configuring the reference oscillator"](#) on page 797.

Manual operation: See ["Synchronization Bandwidth"](#) on page 314

[[:SOURce]:ROSCillator:EXTernal:MLRange?

Queries the minimum locking range for the selected external reference frequency.

Depending on the RF hardware version, and the installed options, the minimum locking range varies.

For more information, see data sheet.

Return values:

<MinLockRange> string

Example: SOUR:ROSC:EXT:MLR?

Usage: Query only

Manual operation: See "[Minimum Locking Range](#)" on page 315

[[:SOURce]:ROSCillator:EXTernal:NSBandwidth?

Queries the nominal synchronization bandwidth for the selected external reference frequency and synchronization bandwidth.

Return values:

<NomBandwidth> string

Example: SOUR:ROSC:EXT:NSB?

Usage: Query only

Manual operation: See "[Nominal Synchronization Bandwidth](#)" on page 315

[[:SOURce]:ROSCillator:OUTPut:FREQUENCY:MODE <OutpFreqMode>

Selects the mode for the output reference frequency.

Parameters:

<OutpFreqMode> DER10M | OFF | LOOPthrough

OFF

Disables the output.

DER10M

Sets the output reference frequency to 10 MHz.

The reference frequency is derived from the internal reference frequency.

LOOPthrough

Forwards the input reference frequency to the reference frequency output.

*RST: n.a. (factory preset: DER10M)

Example: See [Example "Configuring the reference oscillator"](#) on page 797.

Manual operation: See "[Reference Output](#)" on page 315

[[:SOURce]:ROSCillator[:INTernal]:ADJust:VALue <Value>

Specifies the frequency correction value (adjustment value).

Parameters:

<Value> integer
*RST: 0

Example: See [\[:SOURce\]:ROSCillator\[:INTernal\]:ADJust\[:STATe\]](#) on page 800

Manual operation: See ["Adjustment Value"](#) on page 316

[[:SOURce]:ROSCillator[:INTernal]:ADJust[:STATe] <State>

Determines whether the calibrated (off) or a user-defined (on) **adjustment value** is used for fine adjustment of the frequency.

Parameters:

<State> 1 | ON | 0 | OFF
0
Fine adjustment with the calibrated frequency value
1
User-defined adjustment value.
The instrument is no longer in the calibrated state.
The calibration value is, however, not changed. The instrument resumes the calibrated state if you send
`SOURce:ROSCillator:INTernal:ADJust:STATe 0.`
*RST: n.a. (factory preset: 0)

Example: See [Example "Configuring the reference oscillator"](#) on page 797.

Manual operation: See ["Adjustment Active"](#) on page 316

14.16.13 SOURce:SWEep subsystem

The `SOURce:SWEep` subsystem contains the commands for configuring RF sweep signals.



- The keyword [:FREQuency] can be omitted, then the commands are SCPI-compliant.
- To activate an RF sweep mode, use the following commands:
 - RF frequency sweep: SOURce:FREQuency:MODE SWEEp (SOURce:FREQuency:MODE CW (off))
 - RF level sweep: SOURce:POWer:MODE SWEEp (SOURce:POWer:MODE CW (off))
 - RF combined sweep: SOURce:FREQuency:MODE SWEEp (SOURce:FREQuency:MODE CW (off))
- All sweeps can be set independently of each other.

See [Chapter 8.9.1, "Signal generation and triggering in the sweep and list modes"](#), on page 318.

Example: Setup an RF frequency or power sweep

The following example shows a command sequence to set up an RF frequency sweep, triggered by the execute command. For an RF power sweep, replace FREQuency in the SWEEp commands with POWer.

Exceptions are the power spacing (defined with LINear only) and the power step width (defined with LOGarithmic only).

```
// Reset the instrument to start from an initial state
// Switch off display update to improve performance
// (especially with short dwell times)
// Set the sweep mode (first two commands) and the sweep range
// Select linear spacing
// Select the waveform shape for the frequency sweep
*RST; *CLS
SYSTEM:DISPLAY:UPDATE OFF
TRIGGER1:FSWEEP:SOURCE SINGLE
SOURCE1:SWEEP:FREQUENCY:MODE AUTO
SOURCE1:FREQUENCY:SPAN 300 MHz
SOURCE1:FREQUENCY:CENTER 200 MHz
// Alternatively use
// SOURCE1:FREQUENCY:START 50 MHz
// SOURCE1:FREQUENCY:STOP 350 MHz
SOURCE1:SWEEP:FREQUENCY:SPACING LINear
SOURCE1:SWEEP:FREQUENCY:SHAPE SAWTOOTH

// Activate change to start frequency while waiting for next trigger
// Prerequisites: sweep mode single and sweep waveform sawtooth
SOURCE1:SWEEP:FREQUENCY:RETRACE 1
// Alternatively reset all sweeps to their initial value
SOURCE1:SWEEP:RESET:ALL

// Set the step width and dwell time
SOURCE1:SWEEP:FREQUENCY:STEP:LINear 1 MHz
```

```

// Alternatively set the number of steps, then the sweep step width is
// set automatically
SOURcel:SWEep:FREQuency:POINts 301
SOURcel:SWEep:FREQuency:DWELl 500 ms
// With logarithmic spacing select the step width as follows
// (steps of 10 percent of the previous frequency in each instance)
SOURcel:SWEep:FREQuency:SPACing LOG
SOURcel:SWEep:FREQuency:STEP:LOGarithmic 10PCT

// Activate the sweep
// Trigger the sweep (depending on the set mode) and query the status
SOURcel:FREQuency:MODE SWEep
// Perform a one-off RF frequency sweep
SOURcel:SWEep:FREQuency:EXECute
SOURcel:SWEep:FREQuency:RUNning?
// 1
// the frequency sweep is running

// For manual step RF sweep use the following commands
*RST; *CLS
// Activate manual step RF sweep
SOURcel:SWEep:FREQuency:MODE MANual
// Activate the RF frequency sweep.
SOURcel:FREQuency:MODE SWEep
// Activate RF Output1.
Output1:STATe 1
// Input the frequency manually for each step
SOURcel:FREQuency:MANual 200 MHz
SOURcel:FREQuency:MANual 201 MHz
// Alternatively use the UP or DOWN commands with the set step width.
SOURcel:SWEep:FREQuency:STEP:LINear 1 MHz
SOURcel:FREQuency:MANual UP

```

[:SOURce<hw>]:SWEep:POWer:DWELl.....	803
[:SOURce<hw>]:SWEep:POWer:MODE.....	803
[:SOURce<hw>]:SWEep:POWer:POINts.....	803
[:SOURce<hw>]:SWEep:POWer:SPACing:MODE?.....	804
[:SOURce<hw>]:SWEep:POWer:STEP[:LOGarithmic].....	804
[:SOURce<hw>]:SWEep[:FREQuency]:DWELl.....	804
[:SOURce<hw>]:SWEep[:FREQuency]:MODE.....	805
[:SOURce<hw>]:SWEep[:FREQuency]:POINts.....	805
[:SOURce<hw>]:SWEep[:FREQuency]:SPACing.....	805
[:SOURce<hw>]:SWEep:POWer:SHAPE.....	806
[:SOURce<hw>]:SWEep[:FREQuency]:SHAPE.....	806
[:SOURce<hw>]:SWEep:POWer:EXECute.....	806
[:SOURce<hw>]:SWEep[:FREQuency]:EXECute.....	806
[:SOURce<hw>]:SWEep:POWer:RETRace.....	807
[:SOURce<hw>]:SWEep[:FREQuency]:RETRace.....	807
[:SOURce<hw>]:SWEep:POWer:RUNning?.....	807
[:SOURce<hw>]:SWEep[:FREQuency]:RUNning?.....	807

[:SOURce<hw>]:SWEep[:FREQuency]:STEP:LOGarithmic.....	807
[:SOURce<hw>]:SWEep[:FREQuency]:STEP[:LINear].....	807
[:SOURce<hw>]:SWEep:RESet[:ALL].....	808

[:SOURce<hw>]:SWEep:POWer:DWELI <Dwell>

Sets the dwell time for a level sweep step.

Parameters:

<Dwell>	float
	Range: 10E-3 to 100
	Increment: 100E-6
	*RST: 10E-3
	Default unit: s

Example: See [Example "Setup an RF frequency or power sweep"](#) on page 801.

Manual operation: See ["Dwell Time"](#) on page 337

[:SOURce<hw>]:SWEep:POWer:MODE <Mode>

Sets the cycle mode for the level sweep.

Parameters:

<Mode>	AUTO MANual STEP
--------	----------------------

AUTO

Each trigger triggers exactly one complete sweep.

MANual

The trigger system is not active. You can trigger every step individually with the command [\[:SOURce<hw>\]:POWer:MANual](#).

The level value increases at each step by the value that you define with [\[:SOURce<hw>\]:POWer:STEP\[:INCRement\]](#).

Values directly entered with the command [\[:SOURce<hw>\]:POWer:MANual](#) are not taken into account.

STEP

Each trigger triggers one sweep step only. The level increases by the value entered with [\[:SOURce<hw>\]:POWer:STEP\[:INCRement\]](#).

*RST: AUTO

Example: See [Example "Setup an RF frequency or power sweep"](#) on page 801.

Manual operation: See ["Mode"](#) on page 334

[:SOURce<hw>]:SWEep:POWer:POINts <Points>

Sets the number of steps within the RF level sweep range.

See [Chapter 8.9.2.1, "Correlating parameters in sweep mode"](#), on page 326.

Parameters:

<Points> integer
 Range: 2 to Max

Example: See [Example "Setup an RF frequency or power sweep"](#) on page 801.

[[:SOURce<hw>]:SWEep:POWER:SPACing:MODE?

Queries the level sweep spacing. The sweep spacing for level sweeps is always linear.

Return values:

<Mode> LINear
 *RST: LINear

Example: SWE:POW:SPAC:MODE?
 queries the sweep spacing for a level sweep at RF output.
 Result: "LIN"
 linear spacing

Usage: Query only

[[:SOURce<hw>]:SWEep:POWER:STEP[:LOGarithmic] <Logarithmic>

Sets a logarithmically determined step size for the RF level sweep. The level is increased by a logarithmically calculated fraction of the current level.

See [Chapter 8.9.2.1, "Correlating parameters in sweep mode"](#), on page 326.

Parameters:

<Logarithmic> float
 The unit dB is mandatory.
 Range: 0.01 to 139 dB
 Increment: 0.01
 *RST: 1
 Default unit: dB

Example: See [Example "Setup an RF frequency or power sweep"](#) on page 801.

Manual operation: See ["Step"](#) on page 340

[[:SOURce<hw>]:SWEep[:FREQuency]:DWELI <Dwell>

Sets the dwell time for a frequency sweep step.

Parameters:

<Dwell> float
 Range: 1E-3 to 100
 Increment: 100E-6
 *RST: 10E-3
 Default unit: s

Example: See [Example"Setup an RF frequency or power sweep"](#) on page 801.

Manual operation: See ["Dwell Time"](#) on page 337

[:SOURce<hw>]:SWEep[:FREQUENCY]:MODE <Mode>

Sets the cycle mode for the frequency sweep.

Parameters:

<Mode> AUTO | MANual | STEP

AUTO

Each trigger event triggers exactly one complete sweep.

MANual

The trigger system is not active. You can trigger every step individually by input of the frequencies with the command [:SOURce<hw>]:FREQUENCY:MANual.

STEP

Each trigger event triggers one sweep step. The frequency increases by the value entered with [:SOURce<hw>]:SWEep[:FREQUENCY]:STEP[:LINear] (linear spacing) or [:SOURce<hw>]:SWEep[:FREQUENCY]:STEP:LOGarithmic (logarithmic spacing).

*RST: AUTO

Example: See [Example"Setup an RF frequency or power sweep"](#) on page 801.

Manual operation: See ["Mode"](#) on page 334

[:SOURce<hw>]:SWEep[:FREQUENCY]:POINTs <Points>

Sets the number of steps within the RF frequency sweep range.

See [Chapter 8.9.2.1, "Correlating parameters in sweep mode"](#), on page 326.

Two separate POINTs values are used for linear or logarithmic sweep spacing ([:SOURce<hw>]:SWEep[:FREQUENCY]:SPACing LIN | LOG). The command always affects the currently set sweep spacing.

Parameters:

<Points> integer
Range: 2 to Max

Example: See [Example"Setup an RF frequency or power sweep"](#) on page 801.

[:SOURce<hw>]:SWEep[:FREQUENCY]:SPACing <Spacing>

Selects the mode for the calculation of the frequency intervals, with which the current frequency at each step is increased or decreased.

The keyword [:FREQUENCY] can be omitted; then the command is SCPI-compliant.

Parameters:

<Spacing> LINear | LOGarithmic

LINear

Sets a fixed frequency value as step width and adds it to the current frequency.

The linear step width is entered in Hz, see [:SOURce<hw>] : SWEep [:FREQUENCY] :STEP [:LINear].

LOGarithmic

Sets a constant fraction of the current frequency as step width and adds it to the current frequency.

The logarithmic step width is entered in %, see [:SOURce<hw>] : SWEep [:FREQUENCY] :STEP:LOGarithmic.

*RST: LINear

Example: See [Example "Setup an RF frequency or power sweep"](#) on page 801.

Manual operation: See ["Spacing"](#) on page 337

[:SOURce<hw>]:SWEep:POWer:SHAPE <Shape>

[:SOURce<hw>]:SWEep[:FREQUENCY]:SHAPE <Shape>

Determines the waveform shape for a frequency sweep sequence.

Parameters:

<Shape> SAWTooth | TRIangle

*RST: SAWTooth

Example: See [Example "Setup an RF frequency or power sweep"](#) on page 801.

Manual operation: See ["Shape"](#) on page 335

[:SOURce<hw>]:SWEep:POWer:EXECute

[:SOURce<hw>]:SWEep[:FREQUENCY]:EXECute

Executes an RF frequency sweep.

The command performs a single sweep and is therefore only effective in manual sweep mode.

Example: See [Example "Setup an RF frequency or power sweep"](#) on page 801.

Usage: Event

Manual operation: See ["Execute Single Sweep"](#) on page 337

```
[:SOURce<hw>]:SWEep:POWer:RETRace <State>
```

```
[:SOURce<hw>]:SWEep[:FREQuency]:RETRace <State>
```

Activates that the signal changes to the start frequency value while it is waiting for the next trigger event.

You can enable this feature, when you are working with sawtooth shapes in sweep mode "Single" or "External Single".

Parameters:

```
<State>          1 | ON | 0 | OFF
                  *RST:      0
```

Example: See [Example"Setup an RF frequency or power sweep"](#) on page 801.

Manual operation: See ["Retrace"](#) on page 335

```
[:SOURce<hw>]:SWEep:POWer:RUNNING?
```

```
[:SOURce<hw>]:SWEep[:FREQuency]:RUNNING?
```

Queries the current sweep state.

Return values:

```
<State>          1 | ON | 0 | OFF
```

Example: See [Example"Setup an RF frequency or power sweep"](#) on page 801.

Usage: Query only

```
[:SOURce<hw>]:SWEep[:FREQuency]:STEP:LOGarithmic <Logarithmic>
```

Sets a logarithmically determined step width for the RF frequency sweep. The value is added at each sweep step to the current frequency.

See [Chapter 8.9.2.1, "Correlating parameters in sweep mode"](#), on page 326.

Parameters:

```
<Logarithmic>   float
                  The unit is mandatory.
                  Range:      0.01 to 100
                  Increment:  1E-3
                  *RST:      1
                  Default unit: PCT
```

Example: See [Example"Setup an RF frequency or power sweep"](#) on page 801.

Manual operation: See ["Step Linear/Step Logarithmic"](#) on page 339

```
[:SOURce<hw>]:SWEep[:FREQuency]:STEP[:LINear] <Linear>
```

Sets the step width for linear sweeps.

See [Chapter 8.9.2.1, "Correlating parameters in sweep mode"](#), on page 326.

Omit the optional keywords so that the command is SCPI-compliant.

Parameters:

<Linear> float
 Range: 0.001 Hz to (STOP - START)
 Increment: 0.01

Example: See [Example "Setup an RF frequency or power sweep"](#) on page 801.

Manual operation: See ["Step Linear/Step Logarithmic"](#) on page 339

[:SOURce<hw>]:SWEep:RESet[:ALL]

Resets all active sweeps to the starting point.

Usage: Event

Manual operation: See ["Reset Sweep"](#) on page 337

14.17 SYSTem subsystem

The SYSTem subsystem contains a series of commands for general functions which do not directly affect signal generation.

Example: Retrieving instrument specification

Note: The following values are merely an example.

```
// Retrieve information on data sheet versions.
// Query all data sheet versions saved on the instrument:
SYSTem:SPECification:VERsion:CATalog?
"04.03,04.02,04.01,04.00,03.04,03.03,03.02,03.01,03.00,02.96,02.95,02.94,
02.02,02.01,02.00,01.03,01.02,01.01,01.00"

// Query the initial data sheet version on delivery
SYSTem:SPECification:VERsion:FACTory?
// Response: "04.00"

// Select a specific data sheet version:
SYSTem:SPECification:VERsion "04.01"

// Retrieve information on parameters that belong to a particular data sheet.
// Query the IDs of all parameters listed in the selected version:
SYSTem:SPECification:VERsion "04.03"
SYSTem:SPECification:IDEntification:CATalog?
"ID_RF_FREQ_SETTING_TIME_ALC_ON_MS,ID_RF_FREQ_SETTING_TIME_MS,..."

// Query data sheet information on a specific parameter by its ID.
```



```
SYSTEM:SPECification? "ID_RF_FREQ_SETTING_TIME_ALC_ON_MS"  
// Returns the specified value of the parameter.
```

Example: Retrieving information on network-related settings

```
SYSTEM:COMMunicate:NETWork:STATus?  
// 1  
SYSTEM:PROTection1:STATe 0,123456  
  
SYSTEM:COMMunicate:NETWork:IPAddress:MODE STAT  
SYSTEM:COMMunicate:NETWork:IPAddress "10.113.0.104"  
SYSTEM:COMMunicate:NETWork:IPAddress:DNS "10.0.2.166"  
SYSTEM:COMMunicate:NETWork:COMMON:HOSTname?  
// "SMCV100B-102030"  
SYSTEM:COMMunicate:NETWork:COMMON:WORKgroup "instrument"  
SYSTEM:COMMunicate:NETWork:COMMON:DOMAIN "rsint.net"  
SYSTEM:COMMunicate:NETWork:IPAddress:GATeway "10.113.0.1"  
SYSTEM:COMMunicate:NETWork:IPAddress:SUBNet:MASK "255.255.252.0"  
SYSTEM:COMMunicate:NETWork:MACaddress "08 00 27 a3 a1 70"  
SYSTEM:PROTection1:STATe 1
```

Example: Restarting the network

```
SYSTEM:COMMunicate:NETWork:REStart  
// terminates the network connection and sets it up again
```

Example: Finding out VISA resource strings

```
SYSTEM:COMMunicate:NETWork:RESource?  
// Response: "TCPIP::10.113.0.104::inst0::INSTR"  
  
SYSTEM:COMMunicate:HISLip:RESource?  
// Response: "TCPIP::10.113.0.104::hislip0::INSTR"  
  
SYSTEM:COMMunicate:SOCKet:RESource?  
// Response: "TCPIP::10.113.0.104::5025::SOCKET"  
  
SYSTEM:COMMunicate:USB:RESource?  
// "USB::0x0AAD::0x01df::100001::INSTR"
```

Example: Querying the error queue

```
SYSTEM:ERRor:STATic?  
// Response: -221,"Settings conflict", 153,"Input voltage out of range", ...  
// Returns all static errors that are collected in the error queue.  
  
SYSTEM:ERRor:HISTory:ClEar  
// Deletes the history entries.
```

Example: Configuring date and time

```
// Query the date and time setting of the instrument
// Query the current timezone and setting
SYSTem:DATE?
// Response: 2023,1,16;1
SYSTem:TIME?
// Response: 18,15,17;1
SYSTem:TIME:ZONE?
// Response: "";1 //default UTC setting
SYSTem:TIME:PROTOcol?
// Response: "OFF";1 // no protocol selected
SYSTem:NTP:STATe?
// Response: 0;1 // NTP is disabled

// Setting the timezone and NTP time protocol
SYSTem:TIME:ZONE:CATalog?
// Response: "UTC,leap-seconds.list,leapseconds,Africa/Abidjan,..."
SYSTem:TIME:ZONE "Europe/Berlin"
SYSTem:NTP:HOST "timesource.net" // sets the NTP server address
SYSTem:NTP:STATe?
// Response: 1 // the NTP time server is enabled
```

Commands

:SYSTem:ERRor:ALL?	811
:SYSTem:ERRor:CODE:ALL?	812
:SYSTem:ERRor:CODE[:NEXT]?	812
:SYSTem:ERRor:COUNT?	813
:SYSTem:ERRor[:NEXT]?	813
:SYSTem:ERRor:GNEXt?	814
:SYSTem:ERRor:HISTory:CLEar	814
:SYSTem:ERRor:STATic?	814
:SYSTem:DLOCK	815
:SYSTem:KLOCK	815
:SYSTem:NINformation?	815
:SYSTem:ULOCK	816
:SYSTem:LOCK:OWNer?	816
:SYSTem:LOCK:RELease:ALL	816
:SYSTem:LOCK:REQuest[:EXCLusive]?	817
:SYSTem:SAV	817
:SYSTem:RCL	817
:SYSTem:PROTect<ch>[:STATe]	817
:SYSTem:SECurity:VOLMode[:STATe]	818
:SYSTem:COMMunicate:HISLip:RESource?	818
:SYSTem:COMMunicate:NETWork:IPADdress	819
:SYSTem:COMMunicate:NETWork:IPADdress:MODE	819
:SYSTem:COMMunicate:NETWork:MACAddress	819
:SYSTem:COMMunicate:NETWork:RESource?	819
:SYSTem:COMMunicate:NETWork:RESTart	820

:SYSTem:COMMunicate:NETWork:STATus?	820
:SYSTem:COMMunicate:NETWork[:COMMon]:DOMain	820
:SYSTem:COMMunicate:NETWork[:COMMon]:HOSTname	820
:SYSTem:COMMunicate:NETWork[:COMMon]:WORKgroup	821
:SYSTem:COMMunicate:NETWork[:IPADdress]:DNS	821
:SYSTem:COMMunicate:NETWork[:IPADdress]:GATeway	821
:SYSTem:COMMunicate:NETWork[:IPADdress]:SUBNet:MASK	821
:SYSTem:COMMunicate:SOCKet:RESource?	822
:SYSTem:COMMunicate:USB:RESource?	822
:SYSTem:HELP:EXPort	822
:SYSTem:IDENtification	822
:SYSTem:IDENtification:PRESet	823
:SYSTem:IRESpone	823
:SYSTem:ORESpone	823
:SYSTem:LANGuage	824
:SYSTem:INFormation:SCPI	824
:SYSTem:SECurity:SANitize[:STATe]	824
:SYSTem:SECurity:SUPolicy	824
:SYSTem:SPECification?	825
:SYSTem:SPECification:VERSion	825
:SYSTem:SPECification:IDENtification:CATalog?	825
:SYSTem:SPECification:PARAmeter?	825
:SYSTem:SPECification:VERSion:CATalog?	826
:SYSTem:SPECification:VERSion:FACTory?	826
:SYSTem:SRData?	826
:SYSTem:STARtup:COMPLete?	827
:SYSTem:DATE	827
:SYSTem:NTP:HOSTname	827
:SYSTem:NTP:STATe	828
:SYSTem:TIME	828
:SYSTem:TIME:ZONE	828
:SYSTem:TIME:ZONE:CATalog?	828
:SYSTem:TIME:PROTocol	829
:SYSTem:UPTime?	829
:SYSTem:BIOS:VERSion?	829
:SYSTem:VERSion?	830
:SYSTem:OSYStem?	830
:SYSTem:MMEMory:PATH:USER?	830
:SYSTem:DFPR?	830
:SYSTem:REBoot	831
:SYSTem:REStart	831
:SYSTem:SHUTdown	831
:SYSTem:WAIT	831

:SYSTem:ERRor:ALL?

Queries the error/event queue for all unread items and removes them from the queue.

Return values:

<All> string

Error/event_number,"Error/event_description>[;Device-dependent info]"

A comma separated list of error number and a short description of the error in FIFO order.

If the queue is empty, the response is 0, "No error"

Positive error numbers are instrument-dependent. Negative error numbers are reserved by the SCPI standard.

Volatile errors are reported once, at the time they appear. Identical errors are reported repeatedly only if the original error has already been retrieved from (and hence not any more present in) the error queue.

Example:

```
SYST:ERR:ALL?
```

Queries all entries in the error queue.

```
Response: 0, 'no error'
```

No errors have occurred since the error queue was last read out.

Usage:

Query only

Manual operation:

See "[Clear History](#)" on page 844

:SYSTem:ERRor:CODE:ALL?

Queries the error numbers of all entries in the error queue and then deletes them.

Return values:

<All>

string

Returns the error numbers. To retrieve the entire error text, send the command `:SYSTem:ERRor:ALL?`.

0

"No error", i.e. the error queue is empty

Positive value

Positive error numbers denote device-specific errors

Negative value

Negative error numbers denote error messages defined by SCPI.

Example:

```
SYST:ERR:CODE:ALL
```

Queries all entries in the error queue.

```
Response: 0
```

No errors have occurred since the error queue was last read out.

Usage:

Query only

:SYSTem:ERRor:CODE[:NEXT]?

Queries the error number of the oldest entry in the error queue and then deletes it.

Return values:

<Next>

string

Returns the error number. To retrieve the entire error text, send the command `:SYSTem:ERRor:ALL?`.

0

"No error", i.e. the error queue is empty

Positive value

Positive error numbers denote device-specific errors

Negative value

Negative error numbers denote error messages defined by SCPI.

Example:

`SYST:ERR:CODE`

Queries the oldest entry in the error queue.

Response: 0

No errors have occurred since the error queue was last read out.

Usage:

Query only

:SYSTem:ERRor:COUNT?

Queries the number of entries in the error queue.

Return values:

<Count> integer

0

The error queue is empty.

Example:

`SYST:ERR:COUN`

Queries the number of entries in the error queue.

Response: 1

One error has occurred since the error queue was last read out.

Usage:

Query only

:SYSTem:ERRor[:NEXT]?

Queries the error/event queue for the oldest item and removes it from the queue.

Return values:

<Next> string

Error/event_number,"Error/event_description>[;Device-dependent info]"

Error number and a short description of the error.

If the queue is empty, the response is 0, "No error"

Positive error numbers are instrument-dependent. Negative error numbers are reserved by the SCPI standard.

Volatile errors are reported once, at the time they appear. Identical errors are reported repeatedly only if the original error has already been retrieved from (and hence not any more present in) the error queue.

Example: `SYST:ERR?`
 Queries the oldest entry in the error queue.
 Response: 0, 'no error'
 No errors have occurred since the error queue was last read out.

Usage: Query only

Manual operation: See "[Static Notifications/History](#)" on page 844

:SYSTem:ERRor:GNEXt?

Similar to `:SYSTem:ERRor[:NEXT]?`, but queries the next entry from the global persistent error/event queue.

Return values:

<NextGlobalError> string
 Error/event number, "Error/event description" [;Device dependent info]"
 An error number and a short description of the error.
 Positive error numbers are instrument-dependent. Negative error numbers are reserved by the SCPI standard.

Example: `SYST:ERR:GNEX?`
 Returns the next error message from the global error queue.

Usage: Query only

:SYSTem:ERRor:HISTory:CLEar

Clears the error history.

Example: See [Example"Querying the error queue"](#) on page 809

Usage: Event

Manual operation: See "[Clear History](#)" on page 844

:SYSTem:ERRor:STATic?

Returns a list of all errors existing at the time when the query is started. This list corresponds to the display on the info page under manual control.

Return values:

<StaticErrors> string

Example: See [Example"Querying the error queue"](#) on page 809

Usage: Query only

Manual operation: See "[Static Notifications/History](#)" on page 844

:SYSTem:DLOCK <DispLockStat>

Disables the manual operation over the display, including the front panel keyboard of the instrument.

Parameters:

<DispLockStat> 1 | ON | 0 | OFF
 *RST: n.a. (factory preset: 0)

Example:

SYST:DLOC ON
 Activates the display lock. The instrument cannot be operated via the display until it has been enabled with SYST:DLOC OFF.

Manual operation: See ["User Interface"](#) on page 487
 See ["Enabling a locked user interface for manual operation"](#) on page 488

:SYSTem:KLOCK <State>

Disables the front panel keyboard of the instrument.

Parameters:

<State> 1 | ON | 0 | OFF
 *RST: n.a. (factory preset: 0)

Example:

SYST:KLOC ON
 Locks the front panel and external controls.
 To enable the controls, send SYST:KLOC OFF.

Manual operation: See ["User Interface"](#) on page 487
 See ["Enabling a locked user interface for manual operation"](#) on page 488

:SYSTem:NINformation?

Queries the oldest information message ("Error History > Level > Info") in the error/event queue.

Return values:

<NextInfo> string

Example:

:SYSTem:NINformation?
 Queries the oldest entry in the info message queue.
 Response: 90,"Info;=== Instrument startup...
 ==="
 Information message containing error number 90, that states, that the instrument startup is complete.

Usage: Query only

:SYSTem:ULOCK <Mode>

Locks or unlocks the user interface of the instrument.

Parameters:

<Mode>

ENABLEd | DONLy | DISabled | TOFF | VNConly

ENABLEd

Unlocks the display, the touchscreen and all controls for the manual operation.

DONLy

Locks the touchscreen and controls for the manual operation of the instrument. The display shows the current settings.

VNConly

Locks the touchscreen and controls for the manual operation, and enables remote operation over VNC. The display shows the current settings.

TOFF

Locks the touchscreen for the manual operation of the instrument. The display shows the current settings.

DISabled

Locks the display, the touchscreen and all controls for the manual operation.

*RST: n.a. (factory preset: ENABLEd)

Example:

```
:SYST:ULOC DIS
```

Activates the user interface lock, including display and controls.

Manual operation:

See "[User Interface](#)" on page 487

See "[Enabling a locked user interface for manual operation](#)" on page 488

:SYSTem:LOCK:OWNer?

Queries the sessions that have locked the instrument currently.

If an exclusive lock is set, the query returns the owner of this exclusive lock, otherwise it returns `NONE`.

Return values:

<Owner>

string

Example:

```
SYST:LOCK:OWN?
```

Returns the owner of locking.

Response: `NONE`

The instrument is not locked.

Usage:

Query only

:SYSTem:LOCK:RELease:ALL

Revokes the exclusive access to the instrument.

Usage: Setting only

:SYSTem:LOCK:REQuest[:EXCLusive]?

Queries whether a lock for exclusive access to the instrument via ethernet exists. If successful, the query returns a 1, otherwise 0.

Return values:

<Success> integer

Example:

`SYST:LOCK:REQ?`

Queries the state of exclusive locking.

Response: 1

The exclusive locking is active.

Usage: Query only

:SYSTem:SAV <Pathname>

Saves the current R&S SMCV100B settings into a file with defined filename and into a specified directory. The file extension (*.savrc1txt) is assigned automatically.

Setting parameters:

<Pathname> string

Example:

`SYSTem:SAV "/var/user/temp/Test"`

Saves the file `Test.savrc1txt` into the directory `/var/user/temp/`.

Usage: Setting only

:SYSTem:RCL <Pathname>

Loads a file with previously saved R&S SMCV100B settings.

Loads the selected file with previously saved R&S SMCV100B settings from the default or the specified directory. Loaded are files with extension *.savrc1txt.

Setting parameters:

<Pathname> string

Example:

`SYSTem:RCL "/var/user/temp/Test"`

Loads the file `Test.savrc1txt` from the directory `/var/user/temp/`.

Usage: Setting only

:SYSTem:PROTect<ch>[:STATe] <State>[, <Key>]

Activates and deactivates the specified protection level.

Suffix:

<ch> Indicates the protection level.
See also "[Protection](#)" on page 481

Parameters:

<State> 1 | ON | 0 | OFF
*RST: n.a. (factory preset: 1)

Setting parameters:

<Key> integer
The respective functions are disabled when the protection level is activated. No password is required for activation of a level. A password must be entered to deactivate the protection level. The default password for the first level is 123456. This protection level is required to unlock internal adjustments for example.

Example:

To activate protection level:
SYSTem:PROTECT1:STATe 1
Internal adjustments or hostname cannot be changed.
To unlock protection level 1:
SYSTem:PROTECT1:STATe 0,123456
Internal adjustments are accessible.

Manual operation: See "[Protection Level/Password](#)" on page 483

:SYSTem:SECurity:VOLMode[:STATe] <SecPassWord>, <MmemProtState>

Activates volatile mode, so that no user data can be written to the internal memory permanently.

To enable volatile mode, reboot the instrument. Otherwise the change has no effect.

Parameters:

<MmemProtState> 0 | 1 | OFF | ON
*RST: 0

Setting parameters:

<SecPassWord> string
Current security password
The default password is 123456.

Example:

SYSTem:SECurity:VOLMode:STATe "123456", 1
SYSTem:REBoot

Manual operation: See "[Volatile Mode](#)" on page 485

:SYSTem:COMMunicate:HISLip:RESource?

Queries the VISA resource string. This string is used for remote control of the instrument with HiSLIP protocol.

Return values:

<Resource> string

Example: See [Example "Finding out VISA resource strings"](#) on page 809.

Usage: Query only

Manual operation: See ["HISLIP"](#) on page 521

:SYSTem:COMMunicate:NETWork:IPADdress <IpAddress>

Sets the IP address.

Parameters:

<IpAddress> string

Range: 0.0.0.0. to ff.ff.ff.ff

Example: See [Example "Retrieving information on network-related settings"](#) on page 809.

Manual operation: See ["IP Address"](#) on page 519

:SYSTem:COMMunicate:NETWork:IPADdress:MODE <Mode>

Selects manual or automatic setting of the IP address.

Parameters:

<Mode> AUTO | STATic

*RST: n.a. (factory preset: AUTO)

Example: See [Example "Retrieving information on network-related settings"](#) on page 809.

Manual operation: See ["Address Mode"](#) on page 519

:SYSTem:COMMunicate:NETWork:MACaddress <MacAddress>

Queries the MAC address of the network adapter.

This is a password-protected function. Unlock the protection level 1 to access it.

Parameters:

<MacAddress> string

Example: See [Example "Retrieving information on network-related settings"](#) on page 809.

Manual operation: See ["MAC Address"](#) on page 521

:SYSTem:COMMunicate:NETWork:RESource?

Queries the visa resource string for Ethernet instruments.

Return values:

<Resource> string

Example: See [Example "Finding out VISA resource strings"](#) on page 809.

Usage: Query only

Manual operation: See ["VXI11"](#) on page 522

:SYSTem:COMMunicate:NETWork:REStart

Restarts the network.

Example: See [Example "Restarting the network"](#) on page 809.

Usage: Event

Manual operation: See ["Restart Network"](#) on page 519

:SYSTem:COMMunicate:NETWork:STATus?

Queries the network configuration state.

Return values:

<State> 1 | ON | 0 | OFF

Example: See [Example "Retrieving information on network-related settings"](#) on page 809.

Usage: Query only

Manual operation: See ["Network Status"](#) on page 518

:SYSTem:COMMunicate:NETWork[:COMMON]:DOMain <Domain>

Determines the primary suffix of the network domain.

Parameters:

<Domain> string

Example: See [Example "Retrieving information on network-related settings"](#) on page 809.

Manual operation: See ["DNS Suffix"](#) on page 520

:SYSTem:COMMunicate:NETWork[:COMMON]:HOSTname <Hostname>

Sets an individual hostname for the vector signal generator.

Note: We recommend that you do not change the hostname to avoid problems with the network connection. If you change the hostname, be sure to use a unique name.

This is a password-protected function. Unlock the protection level 1 to access it.

Parameters:

<Hostname> string

Example: See [Example"Retrieving information on network-related settings"](#) on page 809.

Manual operation: See ["Hostname"](#) on page 519

:SYSTem:COMMunicate:NETWork[:COMMON]:WORKgroup <Workgroup>

Sets an individual workgroup name for the instrument.

Parameters:

<Workgroup> string

Example: See [Example"Retrieving information on network-related settings"](#) on page 809.

Manual operation: See ["Workgroup"](#) on page 519

:SYSTem:COMMunicate:NETWork[:IPAddress]:DNS <DNS>

Determines or queries the network DNS server to resolve the name.

Parameters:

<DNS> string

Example: See [Example"Retrieving information on network-related settings"](#) on page 809.

Manual operation: See ["DNS Server"](#) on page 521

:SYSTem:COMMunicate:NETWork[:IPAddress]:GATeway <Gateway>

Sets the IP address of the default gateway.

Parameters:

<Gateway> string

Range: 0.0.0.0 to ff.ff.ff.ff

Example: See [Example"Retrieving information on network-related settings"](#) on page 809.

Manual operation: See ["Default Gateway"](#) on page 520

:SYSTem:COMMunicate:NETWork[:IPAddress]:SUBNet:MASK <Mask>

Sets the subnet mask.

Parameters:

<Mask> string

Example: See [Example"Retrieving information on network-related settings"](#) on page 809.

Manual operation: See ["Subnet Mask"](#) on page 520

:SYSTem:COMMunicate:SOCKet:RESource?

Queries the visa resource string for remote control via LAN interface, using TCP/IP socket protocol.

Return values:

<Resource> string

Example: See [Example "Finding out VISA resource strings"](#) on page 809.

Usage: Query only

Manual operation: See ["Socket"](#) on page 522

:SYSTem:COMMunicate:USB:RESource?

Queries the visa resource string for remote control via the USB interface.

Return values:

<Resource> string

Example: See [Example "Finding out VISA resource strings"](#) on page 809.

Usage: Query only

:SYSTem:HELP:EXPort

Saves the online help as zip archive in the user directory.

Example:

```
:SYSTem:HELP:EXPort
MMEM:CDIR?
// "/var/user"
MMEM:CAT?
// .., "Log,DIR,4096", "help.tgz,BIN,69836600"
// confirms that help zip archive is saved.
```

Usage: Event

Manual operation:: "Setup > Help > Export Help to User Path"

:SYSTem:IDENtification <Identification>

Selects the mode to determine the "IDN String" and the "OPT String" for the instrument, selected with command [:SYSTem:LANGuage](#).

Note: While working in an emulation mode, the R&S SMCV100B specific command set is disabled, that is, the SCPI command `SYST:IDEN` is discarded.

Parameters:

<Identification> AUTO | USER

AUTO

Automatically determines the strings.

USER

User-defined strings can be selected.

*RST: n.a. (factory preset: AUTO)

Example: SYST:IDEN AUTO
Automatically assigns the OPT and IDN strings according to the selected instrument language.

Manual operation: See "[Mode](#)" on page 523

:SYSTem:IDENtification:PRESet

Sets the *IDN and *OPT strings in user defined mode to default values.

Example: SYST:IDEN USER
SYST:IDEN:PRES

Usage: Event

Manual operation: See "[Set to Default](#)" on page 523

:SYSTem:IRESpOse <IdnResponse>

Defines the user defined identification string for *IDN.

Note: While working in an emulation mode, the instrument's specific command set is disabled, i.e. the SCPI command SYST:IRES is discarded.

Parameters:

<IdnResponse> string

Example: SYST:IDEN USER
// Selects a user-defined identification
SYST:IRES "Test Device"
// Defines identification string 'test device'
*IDN?
// Response: 'test device'

Manual operation: See "[IDN String](#)" on page 523

:SYSTem:ORESpOse <OResponse>

Defines the user defined response string for *OPT.

Note: While working in an emulation mode, the instrument's specific command set is disabled, i.e. the SCPI command SYST:ORES is discarded.

Parameters:

<OResponse> string

Example: SYST:IDEN USER
// Selects a user-defined identification
SYST:ORES "Test Option"
// Defines the OPT string 'test option'
*OPT?
// Response: 'test option'

Manual operation: See ["OPT String"](#) on page 523

:SYSTem:LANGUage <Language>

Sets the remote control command set.

Parameters:

<Language> string

Example:

```
SYSTem:LANGUage "SCPI"
// selects SCPI command set
```

Manual operation: See ["Language"](#) on page 523

:SYSTem:INFormation:SCPI <InfoString>

Inserts system information in recorded SCPI command lists, for example information on a missing command.

Parameters:

<InfoString> string

Example:

```
SYST:INF:SCPI "missing command"
enters the information into a recorded SCPI command list.
```

:SYSTem:SECurity:SANitize[:STATe] <SecPassWord>, <MmemProtState>

Sanitizes the internal memory.

Parameters:

<MmemProtState> 0 | 1 | OFF | ON
*RST: 0

Setting parameters:

<SecPassWord> string

Example:

```
SYSTem:SECurity:SANitize[:STATe] 1
```

Manual operation: See ["Sanitize"](#) on page 486

:SYSTem:SECurity:SUPolicy <SecPassWord>, <UpdatePolicy>

Configures the automatic signature verification for firmware installation.

Parameters:

<UpdatePolicy> STRict | CONFirm | IGNore
*RST: n.a. (factory preset: CONFirm)

Setting parameters:

<SecPassWord> string

Manual operation: See ["Secure Update Policy"](#) on page 484

:SYSTem:SPECification? <Id>

Retrieves data sheet information for a specific parameter.

Setting parameters:

<Id> string
Identifies the name of the entry in the data sheet, as queried with the command `:SYSTem:SPECification:IDENTification:CATalog?` on page 825

Return values:

<ValList> float
Comma-separated list with the specified and, if available, the typical value of the parameter, as specified in the data sheet.

Example: See [Example"Retrieving instrument specification"](#) on page 808.

Usage: Query only

:SYSTem:SPECification:VERSion <Version>

Selects a data sheet version from the data sheets saved on the instrument.

Further queries regarding the data sheet parameters (<Id>) and their values refer to the selected data sheet.

To query the list of data sheet versions, use the command `:SYSTem:SPECification:VERSion:CATalog?` on page 826.

Parameters:

<Version> string

Example: See `:SYSTem:SPECification?` on page 825.

:SYSTem:SPECification:IDENTification:CATalog?

Queries the parameter identifiers (<Id>) available in the data sheet.

Return values:

<IdList> string
Comma-separated string of the parameter identifiers (<Id>)

Example: See `:SYSTem:SPECification?` on page 825.

Usage: Query only

:SYSTem:SPECification:PARAmeter? <Id>[, <Parameter>]

Retrieves data sheet information for a specific parameter.

Setting parameters:

<Id> string
Identifies the name of the entry in the data sheet.
Query the data sheet parameters with the command `:SYSTem:SPECification:IDEntification:CATalog?`.

<Parameter> float
An additional value the result (ValList) depends on.

Return values:

<ValList> float
Comma-separated list with the specified and, if available, the typical value of the parameter, as specified in the data sheet.

Example:

Note: The following values are merely an example. Your instrument may not support the same parameters.

```
SYST:SPEC:PAR? "ID_RF_FREQ_SETTING_TIME_MS",0.1
SYST:SPEC:PAR? "ID_RF_LEVEL_MAX_GENERAL_DBM",
0.1
```

Usage: Query only

:SYSTem:SPECification:VERSion:CATalog?

Queries all data sheet versions stored in the instrument.

Return values:

<VersCatalog> string

Example: See `:SYSTem:SPECification?` on page 825.

Usage: Query only

:SYSTem:SPECification:VERSion:FACTory?

Queries the data sheet version of the factory setting.

Return values:

<Version> string

Example: See `:SYSTem:SPECification?` on page 825.

Usage: Query only

Manual operation: See "[Versions](#)" on page 850

:SYSTem:SRData?

Queries the SCPI recording data from the internal file.

This feature enables you to transfer an instrument configuration to other test environments, as e.g. laboratory virtual instruments.

Return values:

<FileData> block data

Example:

```

SYSTem:SRData?
// #3118:SOURce1:ROSCillator:SOURce EXT
// :SOURce1:FREQuency:CW 4000000000
// :SOURce1:FREQuency:OFFSet 1000000
// :SOURce1:AM1:STATe 1
// :OUTPut1:STATe 1

```

Usage:

Query only

:SYSTem:STARtup:COMPLete?

Queries if the startup of the instrument is completed.

Return values:

<Complete> 1 | ON | 0 | OFF
 *RST: 0

Example:

```

SYST:STAR:COMP?
Response: 1
the startup of the instrument is completed.

```

Usage:

Query only

:SYSTem:DATE <Year>, <Month>, <Day>

Queries or sets the date for the instrument-internal calendar.

This is a password-protected function. Unlock the protection level 1 to access it.

Parameters:

<Year> integer
 <Month> integer
 Range: 1 to 12
 <Day> integer
 Range: 1 to 31

Example: See [Example"Configuring date and time"](#) on page 810.

Manual operation: See ["Date"](#) on page 857

:SYSTem:NTP:HOSTName <NTPName>

Sets the address of the NTP server. You can enter the IP address, or the hostname of the time server, or even set up an own vendor zone. See the Internet for more information on NTP.

Parameters:

<NTPName> string

Manual operation: See ["NTP Address"](#) on page 857

:SYSTem:NTP:STATe <UseNtpState>

Activates clock synchronization via NTP.

Parameters:

<UseNtpState> 1 | ON | 0 | OFF
 *RST: n.a. (factory preset: 0)

Example: See [Example"Configuring date and time"](#) on page 810.

Manual operation: See ["NTP Address"](#) on page 857

:SYSTem:TIME <Hour>, <Minute>, <Second>

Queries or sets the time for the instrument-internal clock.

This is a password-protected function. Unlock the protection level 1 to access it.

Parameters:

<Hour> integer
 Range: 0 to 23
 <Minute> integer
 Range: 0 to 59
 <Second> integer
 Range: 0 to 59

Example: See [Example"Configuring date and time"](#) on page 810.

Manual operation: See ["Time"](#) on page 857

:SYSTem:TIME:ZONE <TimeZone>

Sets the timezone. You can query the list of the available timezones with [:SYSTem:TIME:ZONE:CATalog?](#).

Parameters:

<TimeZone> string

Example: See [Example"Configuring date and time"](#) on page 810.

Manual operation: See ["Timezone"](#) on page 857

:SYSTem:TIME:ZONE:CATalog?

Queries the list of available timezones.

Return values:

<Catalog>

Example: See [Example"Configuring date and time"](#) on page 810.

Usage: Query only
Manual operation: See ["Timezone"](#) on page 857

:SYSTem:TIME:PROTocol <TimeProtocol>

Sets the date and time of the operating system.

Parameters:

<TimeProtocol> OFF | NONE | 0 | NTP | ON | 1

NONE

Sets the date and time according to the selected timezone, see [:SYSTem:TIME:ZONE:CATalog?](#) on page 828 and [:SYSTem:TIME:ZONE](#) on page 828.

NTP

Sets the date and time derived from the network time protocol. To select the NTP time server, use the commands [:SYSTem:NTP:HOSTname](#) on page 827 and [:SYSTem:NTP:STATe](#) on page 828.

*RST: n.a. (factory preset: NONE)

Example: See [Example"Configuring date and time"](#) on page 810.

Manual operation: See ["Time Protocol"](#) on page 857

:SYSTem:UPTime?

Queries the up time of the operating system.

Return values:

<UpTime> "<ddd.hh:mm:ss>"

Example:

SYSTem:UPTime?
 Response: "0.08:11:00"

Usage: Query only

:SYSTem:BIOS:VERSion?

Queries the BIOS version of the instrument.

Return values:

<Version> string

Example:

SYST:BIOS:VERS?
 queries the BIOS version.
 Response: 123456

Usage: Query only

:SYSTem:VERSion?

Queries the SCPI version the instrument's command set complies with.

Return values:

<Version> string

Example:

SYST:VERS

queries the SCPI version.

Response: "1996"

The instrument complies with the SCPI version from 1996.

Usage: Query only

:SYSTem:OSYStem?

Queries the operating system of the instrument.

Return values:

<OperSystem> string

Example:

SYSTem:OSYStem?

Response: "Linux"

Usage: Query only

:SYSTem:MMEMory:PATH:USER?

Queries the user directory, that means the directory the R&S SMCV100B stores user files on.

Return values:

<PathUser> string

Example:

SYSTem:MMEMory:PATH:USER?

Response: "/var/user/"

Usage: Query only

:SYSTem:DFPR?

Queries the device footprint of the instrument. The retrieved information is in machine-readable form suitable for automatic further processing.

Return values:

<DeviceFootprint> string

Information on the instrument type, device identification and details on the installed FW version, hardware and software options.

Example:

:SYSTem:DFPR?

Usage: Query only

:SYSTem:REBoot

Reboots the instrument including the operating system.

Usage: Event

:SYSTem:REStart

Restarts the instrument without restarting the operating system.

Usage: Event

:SYSTem:SHUTdown

Shuts down the instrument.

Usage: Event

:SYSTem:WAIT <TimeMs>

Delays the execution of the subsequent remote command by the specified time.

This function is useful, for example to execute an SCPI sequence automatically but with a defined time delay between some commands.

See [Chapter 12.4.4, "How to assign actions to the \[★ \(User\)\] key"](#), on page 465.

Setting parameters:

<TimeMs> integer
Wait time in ms
Range: 0 to 10000
*RST: 0

Example:

```
SYSTem:WAIT 10000
// Waits 10s before resetting the instrument.
*RST
```

Usage: Setting only

14.18 STATus subsystem

This system contains the commands for the status reporting system. See also [Chapter 13.4, "Status reporting system"](#), on page 507 for detailed information.

*RST on page 578 has no effect on the status registers.

Value ranges

- Queries return the current value of the respective register, which permits a check of the device status.
Return values: A decimal value in the range 0 to 32767 ($=2^{15}-1$)

- The configuration commands set the respective register thus determining which status changes of the R&S SMCV100B cause the status registers to be changed.
Setting values: A decimal value in the range 0 to 32767 ($=2^{15}-1$)

:STATus:OPERation:CONDition?	832
:STATus:OPERation:ENABle	832
:STATus:OPERation[:EVENT]	832
:STATus:OPERation:NTRansition	833
:STATus:OPERation:PTRansition	833
:STATus:PRESet	833
:STATus:QUEStionable:CONDition	834
:STATus:QUEStionable:ENABle	834
:STATus:QUEStionable[:EVENT]	834
:STATus:QUEStionable:NTRansition	834
:STATus:QUEStionable:PTRansition	835
:STATus:QUEue[:NEXT]?	835

:STATus:OPERation:CONDition?

Queries the content of the CONDition part of the STATus:OPERation register.

This part contains information on the action currently being performed in the instrument. The content is not deleted after being read out because it indicates the current hardware status.

Return values:

<Condition> string

Example: :STATus:OPERation:CONDition?

Usage: Query only

:STATus:OPERation:ENABle <Enable>

Sets the bits of the ENABle part of the STATus:OPERation register. This setting determines which events of the Status-Event part are forwarded to the sum bit in the status byte. These events can be used for a service request.

Parameters:

<Enable> string

Example: :STAT:OPER:ENAB 32767
all events are forwarded to the sum bit of the status byte.

:STATus:OPERation[:EVENT] <Event>

Queries the content of the EVENT part of the STATus:OPERation register. This part contains information on the actions performed in the instrument since the last readout. The content of the EVENT part is deleted after being read out.

Parameters:

<Event> string

Example: `:STAT:OPER:EVEN?`
queries the STATus:OPERation:EVENT register.

:STATus:OPERation:NTRansition <Ntransition>

Sets the bits of the NTRansition part of the STATus:OPERation register. If a bit is set, a transition from 1 to 0 in the condition part causes an entry to be made in the EVENT part of the register. The disappearance of an event in the hardware is thus registered, for example the end of an adjustment.

Parameters:

<Ntransition> string

Example: `:STAT:OPER:NTR 0`
a transition from 1 to 0 in the condition part of the Status:Operation register does not cause an entry to be made in the EVENT part.

:STATus:OPERation:PTRansition <Ptransition>

Sets the bits of the PTRansition part of the STATus:OPERation register. If a bit is set, a transition from 0 to 1 in the condition part causes an entry to be made in the EVENT part of the register. A new event in the hardware is thus registered, for example the start of an adjustment.

Parameters:

<Ptransition> string

Example: `:STAT:OPER:PTR 32767`
all transitions from 0 to 1 in the condition part of the Status:Operation register cause an entry to be made in the EVENT part.

:STATus:PRESet <Preset>

Resets the status registers. All PTRansition parts are set to FFFFh (32767), i.e. all transitions from 0 to 1 are detected. All NTRansition parts are set to 0, i.e. a transition from 1 to 0 in a CONDition bit is not detected. The ENABLE parts of STATus:OPERation and STATus:QUESTionable are set to 0, i.e. all events in these registers are not passed on.

Parameters:

<Preset> string

Example: `STAT:PRES`
resets the status registers.

:STATus:QUEStionable:CONDition <Condition>

Queries the content of the CONDition part of the STATus:QUEStionable register. This part contains information on the action currently being performed in the instrument. The content is not deleted after being read out since it indicates the current hardware status.

Parameters:

<Condition> string

Example:

`:STATus:QUEStionable:CONDition?`
queries the Status:Questionable:Condition register.

:STATus:QUEStionable:ENABle <Enable>

Sets the bits of the ENABle part of the STATus:QUEStionable register. The enable part determines which events of the STATus:EVENT part are enabled for the summary bit in the status byte. These events can be used for a service request.

If a bit in the ENABle part is 1, and the corresponding EVENT bit is true, a positive transition occurs in the summary bit. This transition is reported to the next higher level.

Parameters:

<Enable> string

Example:

`STAT:QUES:ENAB 1`
Problems when performing an adjustment cause an entry to be made in the sum bit.

:STATus:QUEStionable[:EVENT] <Event>

Queries the content of the EVENT part of the STATus:QUEStionable register. This part contains information on the actions performed in the instrument since the last readout. The content of the EVENT part is deleted after being read out.

Parameters:

<Event> string

Example:

`STAT:QUES:EVENT?`
queries the Status:Questionable:Event register.

:STATus:QUEStionable:NTRansition <Ntransition>

Sets the bits of the NTRansition part of the STATus:QUEStionable register. If a bit is set, a transition from 1 to 0 in the condition part causes an entry to be made in the EVENT part of the register.

Parameters:

<Ntransition> string

Example: `STAT:QUES:NTR 0`
 a transition from 1 to 0 in the condition part of the STATus:QUEStionable register does not cause an entry to be made in the EVENT part

:STATus:QUEStionable:PTRansition <PTransition>

Sets the bits of the NTRansition part of the STATus:QUEStionable register. If a bit is set, a transition from 1 to 0 in the condition part causes an entry to be made in the EVENT part of the register.

Parameters:

<PTransition> string

Example: `STAT:QUES:PTR 32767`
 all transitions from 0 to 1 in the condition part of the STATus:QUEStionable register cause an entry to be made in the EVENT part

:STATus:QUEue[:NEXT]?

Queries the oldest entry in the error queue and then deletes it. Positive error numbers denote device-specific errors, and negative error numbers denote error messages defined by SCPI. If the error queue is empty, 0 ("No error") is returned.

The command is identical to `:SYSTem:ERRor[:NEXT]?` on page 813.

Return values:

<Next> string

Example: `:STATus:QUEue?`
 queries the oldest entry in the error queue.
 Response: 0, 'no error'
 no errors have occurred since the error queue was last read out

Usage: Query only

14.19 TEST subsystem

The TEST subsystem contains the commands for performing test routines directly at the hardware assemblies.

The selftest responses with a 0 if the test is performed successfully, otherwise a value other than 0 is returned. None of the commands of this system has a *RST value.

`:TEST<hw>:ALL:START`..... 835
`:TEST<hw>:ALL:RESult?`.....836

:TEST<hw>:ALL:START

Usage: Event

Manual operation: See "Run Module Test" on page 865

Starts the selftest. Use the command `:TEST<hw>:ALL:RESult?` to query the result.

`:TEST<hw>:ALL:RESult?`

Queries the result of the performed selftest. Start the selftest with `:TEST<hw>:ALL:START`.

Return values:

<Result> 0 | 1 | RUNning | STOPped
 *RST: STOPped

Usage: Query only

Manual operation: See "Result" on page 865
 See "Last Full Test" on page 866
 See "Test table" on page 866

14.20 TRIGger subsystem

The TRIGger system contains the commands for selecting the trigger source for the RF sweep.

You can work with an internal or with an externally applied trigger signal. In this case, use the commands in the `SOURCE:INPut` subsystem to configure the signal.

The trigger system of the R&S SMCV100B is a simplified implementation of the SCPI trigger system. The TRIGger system differs from the SCPI system as follows:

- No `INITiate` command; the instrument behaves as if `INITiate:CONTinuous ON` were set.
- Under TRIGger several sweep subsystems exist.
- The trigger source names correspond directly to the various settings of manual control. SCPI uses different names which are also accepted by the instrument. The SCPI names should be used if compatibility is an important consideration.

In addition to these commands, see more trigger-related commands in the modulation and RF signal subsystems.

Table 14-2: Cross-reference between the manual and remote control

R&S proprietary value name	SCPI conform value name	Parameter in manual control
AUTO	IMMediate	"Auto" mode
SINGLE	BUS	"Single" mode.
EXTernal	EXTernal	"Ext Single" and "Ext Step" mode.
EAUTO	-	"Ext Start/Stop" mode.

:TRIGger<hw>:FSweep:SOURce.....	837
:TRIGger<hw>:PSweep:SOURce.....	837
:TRIGger<hw>[:SWEep]:SOURce.....	837
:TRIGger<hw>:FSweep[:IMMediate].....	838
:TRIGger<hw>:PSweep[:IMMediate].....	838
:TRIGger<hw>[:SWEep][:IMMediate].....	838

:TRIGger<hw>:FSweep:SOURce <Source>

:TRIGger<hw>:PSweep:SOURce <Source>

:TRIGger<hw>[:SWEep]:SOURce <Source>

Selects the trigger source for the corresponding sweeps:

- FSweep - RF frequency
- PSweep - RF level
- SWEep - all sweeps

The source names of the parameters correspond to the values provided in manual control of the instrument. They differ from the SCPI-compliant names, but the instrument accepts both variants.

Use the SCPI name, if compatibility is an important issue. Find the corresponding SCPI-compliant commands in [Cross-reference between the manual and remote control](#).

Setting parameters:

<Source> AUTO | IMMediate | SINGLE | BUS | EXTERNAL | EAUTO

AUTO [IMMediate]

Executes a sweep automatically.

In this free-running mode, the trigger condition is met continuously. I.e. when a sweep is completed, the next one starts immediately.

SINGLE [BUS]

Executes one complete sweep cycle.

The following commands initiate a trigger event:

*TRG on page 579

`[:SOURce<hw>]:SWEep:POWer:EXECute`

`[:SOURce<hw>]:SWEep[:FREQuency]:EXECute`

`:TRIGger<hw>[:SWEep][:IMMediate], :TRIGger<hw>:`

`PSweep[:IMMediate] and :TRIGger<hw>:FSweep[:`

`IMMediate].`

Set the sweep mode with the commands:

`[:SOURce<hw>]:SWEep:POWer:MODEAUTO|STEP`

`[:SOURce<hw>]:SWEep[:FREQuency]:MODEAUTO|STEP`

In step mode (STEP), the instrument executes only one step.

EXTERNAL

An external signal triggers the sweep.

EAUTO

An external signal triggers the sweep. When one sweep is finished, the next sweep starts.

A second trigger event stops the sweep at the current frequency, a third trigger event starts the trigger at the start frequency, and so on.

*RST: AUTO

Example: See [Chapter 14.16.13, "SOURCE:SWEep subsystem"](#), on page 800.

Usage: Setting only

:TRIGger<hw>:FSweep[:IMMEDIATE]

:TRIGger<hw>:PSweep[:IMMEDIATE]

:TRIGger<hw>[:SWEep][:IMMEDIATE]

Performs a single sweep and immediately starts the activated, corresponding sweep:

- FSweep - RF frequency
- PSweep - RF level
- SWEep - all sweeps

Effective in the following configuration:

- TRIG:FSW|PSW|[:SWE] :SOUR **SING**
- SOUR:SWE:FREQ|POW:MODE **AUTO**

Alternatively, you can use the IMMEDIATE command instead of the respective SWEep : [FREQ:] | POW:EXECUTE command.

Example: TRIG
Starts all active sweeps.

Usage: Event

Manual operation: See "[Execute Single Sweep](#)" on page 337

14.21 UNIT subsystem

The UNIT subsystem is used to set default units for parameters if no unit is indicated in a command. These settings are valid for the entire instrument.

Example: Setting default units for remote control

```
UNIT:POW V
UNIT:ANGL DEG
```

Sets V (volts) as unit of all power parameters, DEG (degrees) for the phase modulation angle and KMH for the speed.

```
:UNIT:ANGLE.....839
:UNIT:POWer.....839
```

:UNIT:ANGLE <Angle>

Sets the default unit for phase modulation angle. The command affects no other parameters, such as RF phase, or the manual control or display.

Parameters:

```
<Angle>          DEGREE | DEGREE | RADIAN
                  *RST:      RADIAN
```

:UNIT:POWer <Power>

Sets the default unit for all power parameters. This setting affects the GUI, as well as all remote control commands that determine power values.

Parameters:

```
<Power>          V | DBUV | DBM
                  *RST:      DBM
```

15 Troubleshooting and notifications

Handling R&S SMCV100B start-up issues

If the product does not start, a blown fuse in the power supply can be the cause. Contact the Rohde & Schwarz customer service to confirm the fault symptoms. If the power supply has a blown fuse, you must return the product to the Rohde & Schwarz customer service to have the power supply replaced. Follow the instructions from the Rohde & Schwarz customer service.

If you need to transport or ship the instrument, see [Chapter 16, "Transporting"](#), on page 854.

Understanding R&S SMCV100B notifications

The R&S SMCV100B distinguishes between various notifications caused by events or functions. It displays a notification in the "Info" line on the screen temporarily, and saves all notifications in a history list. In addition, an event initiates an entry in the event/error queue of the status reporting system.

See:

- [Chapter 13.4, "Status reporting system"](#), on page 507
- [Chapter 15.4, "Querying notifications"](#), on page 843

15.1 Notifications

Notifications inform about operation states of the instrument, and point out deviations, deficiencies or imperfection of functions that initiate an event in the instrument. The instrument distinguishes the notifications according to the significance of the events by different icons.



Some events require that you eliminate the deviation to make sure that the instrument operates correctly.

To access the notifications and history list dialog, see [Chapter 15.4, "Querying notifications"](#), on page 843. In remote control mode, you can query the notifications using the command `:SYSTem:ERRor:ALL?` on page 811.

15.1.1 Volatile notifications

Volatile notifications report automatic settings in the instrument (e.g. switching off incompatible types of modulation) or on entries that are not accepted by the instrument (e.g. range violations).

Volatile notifications do not normally demand user actions and disappear automatically after a short period of time. They are saved in the history list, however.

Remote command:

```
:SYSTem:ERRor:ALL? or  
:SYSTem:ERRor:CODE[:NEXT]?
```

15.1.2 Permanent notifications

Permanent notifications are displayed if an error occurs that impairs further instrument operation, e.g. a hardware fault. The error signaled by a permanent notification must be eliminated before correct instrument operation can be continued.

The message is displayed until the error is eliminated. It covers the status display in the info line. After error elimination, the message automatically disappears and is also recorded in the history.

Remote command:

```
:SYSTem:ERRor:STATic?
```

15.2 SCPI notifications

The SCPI notifications are similar for all SCPI instruments. Detailed information and an overview of all notifications as defined in SCPI standard can be found in the corresponding documentation.

SCPI notifications have negative codes (numbers). The error text being entered into the error/event queue or being displayed is printed in bold face on the left together with the error code. Below the error text, there is an explanation to the respective error.

15.3 Device-specific notifications

The following table contains all error messages specific for the instrument in alphabetical order and an explanation of the error situation. The positive error codes mark the errors specific to the instrument.

The device-specific error messages set bit 3 in the ESR register.



The index provides a list of the error messages sorted according to their error codes.

Error code	Error	Description	Remedy
50	Extern reference out of range or disconnected	External reference is selected but no external signal is applied or the signal is out of range.	<ul style="list-style-type: none"> Check the selected reference signal source (internal or external) in the "Setup > Reference Oscillator" dialog. Change setting to 'internal' if no appropriate external source is available.
140	This modulation forces other modulations off	A modulation has been switched on which cannot be used at the same time as an already active modulation. The previous modulation has been switched off.	
180	Adjustment failed	Adjustment could not be executed.	Generate the adjustment data and load it into the device
182	Adjustment data missing	Adjustment data is missing.	Generate the adjustment data and load it into the device
183	Adjustment data invalid	Adjustment data is invalid and must be restored.	Generate the adjustment data and load it into the device
200	Cannot access hardware	The data transmission to a module was unsuccessful.	The module is not installed, not properly installed or missing.
201	Hardware revision out of date	A later version of certain parts of the instrument is necessary to execute the function selected.	The driver does not support the installed version of a module.
202	Cannot access the EEPROM	An error occurs when writing or reading a EEPROM.	The EEPROM is possibly defect. Replace it.
203	Invalid EEPROM data	Reading a EEPROM is possible, however the data are inconsistent.	
204	Driver initialization failed	Initialization of a driver fails when booting the instrument firmware.	The driver is not compatible with the hardware or software configuration of the instrument.
241	No current list	There is no list selected. To execute the required operation, a list has to be selected in the related dialog. If no list is available, a new list must be created.	
242	Unknown list type specified	The list type selected is not valid for the required operation.	Check the selected list type.
300	Reference PLL unlocked	The reference frequency source is set "External", but there is no suitable reference source connected.	Use a valid reference frequency source: <ul style="list-style-type: none"> Use the internal reference source, set "Source > Internal". Connect a 10 MHz or 13 MHz reference source at the connector Ref In.
300	Overload (Reverse Power) detected	The connected load feeds in a voltage at the RF output connector RF 50 Ω. Note: The reverse power protection can be triggered, if there is a high RF level and an open RF output, if the DUT is not yet connected.	Remove the overload and switch on the RF output ("RF > On").

Error code	Error	Description	Remedy
300	Over-temperature protection shut-down	The R&S SMCV100B is overheated and/or the fan openings of the R&S SMCV100B are covered.	Relocate the R&S SMCV100B to cool down and remove all coverings from the R&S SMCV100B, see also Chapter 3.1.4, "Setting up the R&S SMCV100B" , on page 25. After cooling down switch on the R&S SMCV100B.
460	Cannot open the file	The selected file cannot be opened.	Check the path and file name.
461	Cannot write file	The file cannot be written.	Check if the file is read-only.
462	Cannot read file	The file cannot be read.	Check if the file contents are compatible with the file type.
463	Filename missing	The required operation cannot be executed because the file name is not specified.	Enter file name when creating list.
464	Invalid filename extension	The file extension is not valid for the required operation.	Check the file extension.
465	File contains invalid data	The selected file contains data that is not valid for the file type. The file extension determines the data that is valid for this file type. If the file extension is changed, the lists are no longer recognized and the data is therefore invalid.	Check the file extension.

15.4 Querying notifications

The R&S SMCV100B monitors the functions performed and automatically detects irregularities. The instrument displays corresponding notifications in the "Info" line and collects all notifications in a history with a detailed description.

Find details to the system notifications in [Chapter 15, "Troubleshooting and notifications"](#), on page 840.

To display information on static notifications and history

1. In the taskbar, select the "Info" icon.
2. For some notifications, the information line appears briefly on the block diagram.

Selecting the info line also opens the dialog.

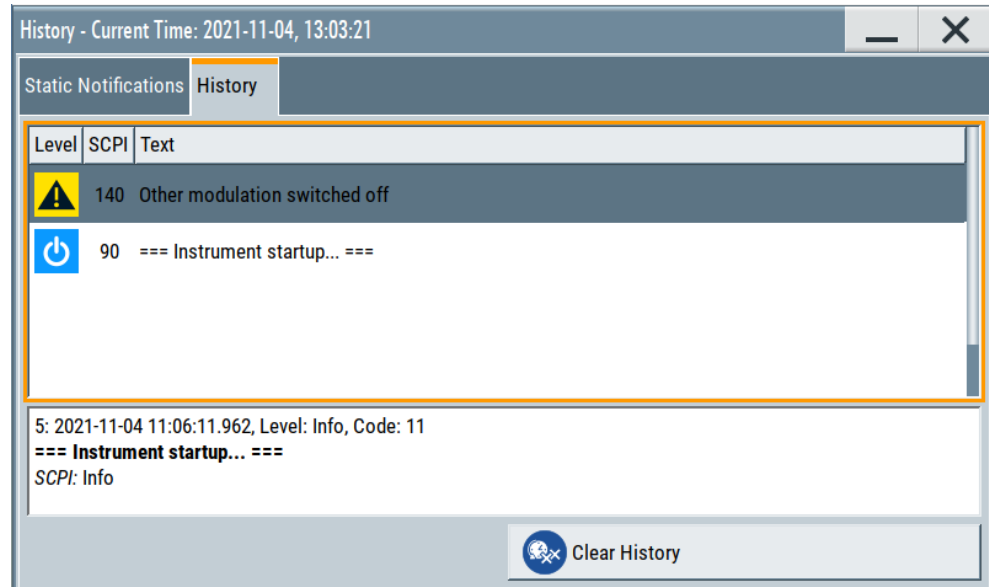

- The "Static Notifications" dialog lists the recently monitored notifications chronologically and displays additional information on the highlighted message.
- The "History" dialog lists the accumulated messages with a short description. Volatile notifications are reported once. If identical errors occur subsequently, they are not reported repeatedly. In the "Info" line, identical errors are displayed repeatedly only if the original error has already disappeared from the display. If queried by SCPI command, identical errors are only reported if the original error has already been retrieved from (and hence not any more present in) the error queue.



Indication and handling of permanent notifications

If any critical error occurs, the R&S SMCV100B automatically shows the  icon in the taskbar. Select the icon to obtain information on the error and the number of occurrences.

The icon is assigned to permanent notifications. The notification and icon are displayed until the error is eliminated.

Static Notifications/History

Toggles between "Static Notifications" and the "History" tab in the info dialog.

Remote command:

`:SYSTem:ERRor[:NEXT]?` on page 813

Each time a `SYST:ERR:NEXT?` query is sent, the eldest entry in the error queue is returned and at the same time cleared in the list.

`:SYSTem:ERRor:STATic?` on page 814

Queries the list of all errors.

Clear History

Clears all messages in the "History" tab.

Remote command:

`:SYSTem:ERRor:ALL?` on page 811

Each time a `SYST:ERR:ALL?` query is sent, the error queue is returned and at the same time cleared.

`:SYSTem:ERRor:HISTory:CLEar` on page 814

Clears the messages in the "History" view.

15.5 Resolving network connection failures

Several issues may cause failures in the network connection to the instrument. This section lists the most likely reasons and the recommended solutions.

Common reasons for network connection failures

- Network connecting cables and cable connectors of poor quality
- Incompatibility between the network interface of the R&S SMCV100B and certain switches or routers available on the market
- An invalid IP address assigned to the instrument

Possible solutions to network connection failures

1. **NOTICE!** Risk of network failure. Connecting to the network can cause network failure. Errors can affect the entire network.

Consult your network administrator before performing the following tasks:

- Connecting the instrument to the network
- Configuring the network
- Changing IP addresses

2. Try out the following to resolve network connection failures:

- Check the network infrastructure. Exchange connecting cables, if obvious damage is visible.
See also "[Cable selection and electromagnetic interference \(EMI\)](#)" on page 26.
- If a link failure is detected, connect the instrument to a different device port or to a different network device.
- Check whether the LAN interface and the required LAN services are enabled.
- If the IP address is set manually (no DHCP) or obtained with the Zeroconf (Avahi) protocol:
 - Check whether the IP address of the instrument is within the network's address range.
 - Check whether the IP address is valid.

15.6 Resolving errors during internal adjustments

Internal adjustments can fail for various reasons, e.g. if the adjustment data is invalid or missing, or if any error causes process to abort.

To resolve a failed adjustment process, you have the following options:

- Abort on error (default setting), see ["To resolve aborted internal adjustments"](#) on page 846
- Continue on error, see ["To continue internal adjustments on error"](#) on page 846

To resolve aborted internal adjustments

If an error occurs, the R&S SMCV100B displays a notification in the "Information" field and saves the notification in the history list.

1. Select "System Config > Info / Notifications".
2. Look up the error code of the notification in the overview of device-specific notifications, see [Chapter 15.3, "Device-specific notifications"](#), on page 841.

The overview provides a brief explanation of all notifications and information on how to fix an error.

3. To resolve an adjustment failure, generate adjustment data and load it into the instrument.
4. Restart internal adjustments as described in ["Running internal adjustments"](#) on page 863

If the error persists:

Contact the Rohde & Schwarz customer support, see [Chapter 15.9, "Collecting information for technical support"](#), on page 851.

To continue internal adjustments on error

If the failed internal adjustments has no significant effect on your application, you can skip it and continue the calibration despite the error message. This function is password-protected.

1. Select "System Config > Setup > Security > Protection".
2. Unlock protection level 1, see ["Protection Level/Password"](#) on page 483.
3. Select "System Config > Setup > Internal Adjustment > Configuration > Continue Adjustment on Error > On".
4. Proceed as described in ["Running internal adjustments"](#) on page 863.

15.7 Measuring USB cable quality

To check the quality of the USB cable, see the service manual of the R&S SMCV100B.

15.8 Requesting instrument configuration and specifications

The R&S SMCV100B is equipped with various hardware and software components. To get an overview of what your instrument is equipped with, you can request the assemblies, hardware and software options, and the firmware version. The components are structured according to the hardware configuration, software options, including the license management, and externally used Rohde & Schwarz equipment, like R&S NRP power sensors.



Software options purchased at a later stage can be activated with a keycode. The activation code is supplied with the software option. How to install options is described in chapter 4 of the R&S SMCV100B service manual.

The installation of hardware options purchased at a later stage is also described in chapter 4 of the service manual. Most of the hardware options have to be installed at an authorized Rohde & Schwarz service center.

15.8.1 Hardware configuration settings

Access:

- ▶ Select "System Config > Setup > Instrument Assembly > Hardware Config".

General	RF Assembly	Baseband Assembly	Counter		X
Assembly	Part Number	Serial Number	Revision	Slot	
SMCV100B	1432.7000k02	0	--		
IPS3	1206.3322.00	100000	00.00	PCI-E slot, is simulated	
BIOS			1.8		
SMARTCARD			--		
FRONTCV	1432.8707.02	100000	01.00	PCI-E slot, is simulated	

The "Hardware Config" dialog lists all installed assemblies and externally connected instruments with information on their part and serial numbers, and revision states. The BIOS version is also listed; firmware updates do not update the BIOS version.

The dialog is divided in tabs, according to the hardware components of the signal domains. The "Counter" tab provides information on the operation time and number of times the instrument was powered on.

The remote commands required to query the hardware configuration are described in [Chapter 14.7, "DIAGnostic subsystem"](#), on page 596.

Assembly

The tables in the tabs show characteristics of the installed assemblies.

"Assembly" Assembly designation.

"Part Number"	Part number of the assembly.
"Serial Number"	Serial number of the assembly.
"Revision"	Revision state of the assembly.
"Slot"	Indicates whether the assembly is connected to the serial bus or PCI bus.

Remote command:

`:DIAGnostic<hw>:BGInfo?` on page 597

Counter

Displays information on the operation times of the R&S SMCV100B.

Operation Time / h ← Counter

Displays the operation time in hours so far.

Remote command:

`:DIAGnostic:INFO:OTIME?` on page 597

Power On Count ← Counter

Displays the number the instrument has been turned on.

Remote command:

`:DIAGnostic:INFO:POCount?` on page 598

Last Factory Calibration ← Counter

Displays the date of the last factory calibration.

Remote command:

`:CALibration:DATA:FACTory:DATE?` on page 594

15.8.2 Versions/options settings

Access:

- ▶ Select "System Config > Setup > Instrument Assembly > Versions / Options".

Firmware	Hardware Options	Software Options	Versions	Conan Packages
Package	Version			
FW	5.00.113			
Service Pack	not installed			
BIOS Version	VirtualBox			
Downgrade Info				
Package	Version			
Factory Version	5.00.113			
Min. Version	4.30.005.26			
The Min. Version is the first version supporting all hardware modules installed in this instrument. Please read release notes carefully before downgrading, some software options and features may get lost.				
Show Open Source Acknowledgments	LucasFonts RSCorpid EULA			

The "Versions/Options" dialog shows the version of the installed instrument firmware, the hardware and software options, the data sheet and the software components of the firmware. The BIOS version is also listed; firmware updates do not update the BIOS version.

The remote commands required to query the hardware configuration are described in [Chapter 14.7, "DIAGnostic subsystem"](#), on page 596.

Firmware

Shows the firmware version and the version of the software platform.

Note: Your instrument is delivered with the latest firmware version available. You can download firmware updates and the "Release Notes" that describe the modifications and the firmware update procedure.

Remote command:

n.a.

Downgrade Info

Shows downgrade information, like factory firmware version and minimum firmware version to that the instrument can be downgraded.

Remote command:

n.a.

Show Open Source Acknowledgments

Accesses the list of the used open-source software packages and the corresponding verbatim license texts.

LucasFonts RSCorpid EULA

Accesses copyright information on LucasFonts font type RSCorpid EULA.

Hardware Options/Software Options

The tables in the "Hardware" and "Software" tabs list the installed hardware and software options.

"Option" Short name of option

"Designation" Name of option

"Expiration Date"

For regular options, "Permanent" is indicated in this column.

Remote command:

*[OPT?](#) on page 577

*[IDN?](#) on page 576

Versions

The "Versions" tab shows the versions of the technical specification of the R&S SMCV100B and of the software components that comprise the firmware.

"Package" Name of the component.

"Version" Current issue of the component.

Remote command:

:[SYSTEM:SPECification:VERSion:FACTory?](#) on page 826

15.8.3 How to query instrument configuration

To get information on the components and installed options of the R&S SMCV100B, proceed as described in the following examples.

Checking the installed hardware options

To find out the installed options:

1. Select "System Config > Setup > Instrument Assembly > Versions/Options".
2. Select "Hardware Options".

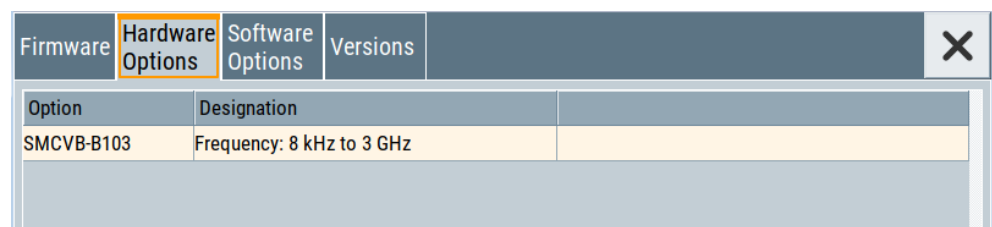

Option	Designation
SMCVB-B103	Frequency: 8 kHz to 3 GHz

The dialog lists all hardware options that are installed on the R&S SMCV100B.

Proceed the same way to get information for instance on the firmware, or the installed software options in the corresponding tab.

Checking the RF hardware assembly

To find out the installed RF hardware:

1. Select "System Config > Setup > Instrument Assembly > Hardware Config".

2. Select "RF Assembly".

General	RF Assembly	Baseband Assembly	Counter		X
Assembly	Part Number	Serial Number	Revision	Slot	
RFCV	1432.8207.02	100000	01.00	USB Simulated	
RFCV MCU (Fw)			00.00.04.05		

The dialog lists the RF hardware components that are installed on the R&S SMCV100B.

Proceed the same way to get information for instance on general or baseband hardware modules, or on the operating times of the R&S SMCV100B in the corresponding tab.

15.9 Collecting information for technical support

If you encounter problems that you cannot solve yourself, contact your Rohde & Schwarz support center at www.rohde-schwarz.com/support. Our support center staff is optimally trained to assist you in solving problems.

The support center finds solutions more quickly and efficiently if you provide them with information on the instrument and an error description.

- The following dialog boxes in the "Setup > Instrument Assembly" menu provide useful information:
 - **Hardware Configuration:** hardware assemblies
 - **Software and Options:** the status of all software and hardware options installed on your instrument
- **System Messages:** displayed in the "Info" line and provide information on any errors that have occurred
- **Support file:** a special file (*.tar.gz file) with important support information that can be created automatically.
The support *.tar.gz file has a user-definable name and contains the following files and information:
 - SgErrors.txt: chronological record of errors
 - SystemRestorationSMCV100B.savrc1.txt: instrument settings at the last correct shutdown of the instrument
 - UndoHistSuppInfo.xml: list of the last user interactions
 - DeviceFootprint_<SerialNumber>_<Date>_<Time>.xml: service-related information on the instrument's configuration.
 - crashlog.txt, coredump: Postmortem debug info
 - Several files with information on the last performed adjustment and self-test.

See also the description of error messages [Chapter 15.1, "Notifications"](#), on page 840.

To collect error information in a support file

1. Connect a USB device to the R&S SMCV100B.
2. Select "System Config > Setup > Maintenance > Create R&S Support Information".
3. In the "Create R&S Support Information" dialog, navigate to the /usb directory. Enter the support filename, for example `RSSupport_DeviceInfo`.

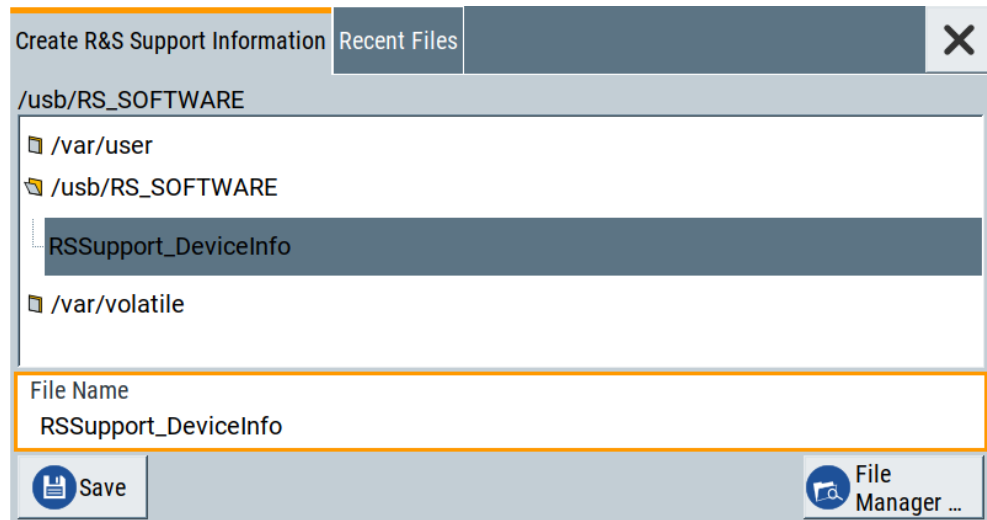

The error information and further required data are collected automatically.

The support file `RSSupport_DeviceInfo.tar.gz` is created and stored in the /usb directory.

Collect the error information and attach it to an email in which you describe the problem. Send the email to the customer support address as listed on the Internet (www.rohde-schwarz.com/support).

To remove sensitive data

- ▶ For information on how to handle or remove the sensitive data from your instrument, refer to the description "R&S SMCV100B Instrument Security Procedures".

To pack and transport the instrument

- ▶ If you need to transport or ship the instrument, see [Chapter 16, "Transporting"](#), on page 854.

15.10 Contacting customer support

Technical support – where and when you need it

For quick, expert help with any Rohde & Schwarz product, contact our customer support center. A team of highly qualified engineers provides support and works with you

to find a solution to your query on any aspect of the operation, programming or applications of Rohde & Schwarz products.

Contact information

Contact our customer support center at www.rohde-schwarz.com/support, or follow this QR code:



Figure 15-1: QR code to the Rohde & Schwarz support page

16 Transporting

Lifting and carrying

See:

- ["Lifting and carrying the product"](#) on page 16
- [Chapter 3.1.1, "Lifting and carrying"](#), on page 24

Packing

Use the original packaging material. It consists of antistatic wrap for electrostatic protection and packing material designed for the product.

If you do not have the original packaging, use similar materials that provide the same level of protection. You can also contact your local Rohde & Schwarz service center for advice.

Securing

When moving the R&S SMCV100B in a vehicle or using transporting equipment, make sure that the R&S SMCV100B is properly secured. Only use items intended for securing objects.

Transport altitude

The maximum transport altitude without pressure compensation is specified in the data sheet.

17 Maintenance, storage and disposal

The product does not require regular maintenance. It only requires occasional cleaning. It is however advisable to check the nominal data from time to time.

17.1 Cleaning

How to clean the product is described in "[Cleaning the product](#)" on page 17.

Do not use any liquids for cleaning. Cleaning agents, solvents, acids and bases can damage the front panel labeling, plastic parts and display.

17.2 Storage

Protect the product against dust. Ensure that the environmental conditions, e.g. temperature range and climatic load, meet the values specified in the data sheet.

17.3 Performing maintenance tasks

The R&S SMCV100B is accurate due to integrated adjustment procedures and the following additional capabilities that assure correct functioning:

- Internal adjustments
Internal adjustments are integrated self-calibration routines, which you can execute directly on the instrument.
How to: See [Chapter 17.3.3.3, "How to use the internal adjustments"](#), on page 863.
Self-calibration routines that require additional equipment are performed at an authorized Rohde & Schwarz service center. For description, see the R&S SMCV100B service manual.
 - Self-test
A self-test is provided for service purposes. We recommend that you perform a selftest, if the instrument does not respond as expected.
How to: [Chapter 17.3.4.2, "How to run hardware module selftests on the R&S SMCV100B"](#), on page 867
 - Test points
If necessary for service purposes, internal test points can be queried. For description, see the R&S SMCV100B service manual.
- | | |
|---|-----|
| • Date and time | 856 |
| • Check front panel | 858 |
| • Internal adjustments | 860 |
| • Selftest | 865 |
| • FPGA/uC update settings | 868 |

17.3.1 Date and time

The R&S SMCV100B uses an internal real-time clock to determine the date and time. It adjusts the time and date to the timezone of your location automatically, by providing a selection list of continents and cities.

The instrument records the time whenever you create or modify files on your instrument or you use timed licenses. By default, the instrument is set to the UTC timezone, but you can select the timezone according to your location.

Moreover, the instrument supports [NTP](#) protocol for synchronizing all connected instruments and computer systems to minimize time delays in the network.

17.3.1.1 Date and time settings

Access:

- ▶ Select "System Config > Setup > Maintenance > Date / Time".

The "Date / Time" dialog contains the time and data settings of the operating system.

This function is password-protected. Unlock the protection level 1 to access it.

You can also set the time zone for your location, and select a time protocol controlled by a time server for synchronization.

The required remote commands are described in [Chapter 14.17, "SYSTEM subsystem"](#), on page 808.

Settings:

Date	857
Time	857
Timezone	857
Time Protocol	857
NTP Address	857

Date

Displays the date set in the operating system in the format [yyyy.mm.dd].

Remote command:

:SYSTem:DATE on page 827

Time

Displays the time set in the operating system in the format [hh.mm.ss].

The time setting corresponds to the selected [Timezone](#).

Remote command:

:SYSTem:TIME on page 828

Timezone

Selects the timezone in the date and time settings of the operating system.

You can select the timezone according to the major cities on the respective continents.

Tip: By typing the first letter, you can quickly navigate through the lists to find the desired destination.

Remote command:

:SYSTem:TIME:ZONE on page 828

:SYSTem:TIME:ZONE:CATalog? on page 828

Time Protocol

Enables the instrument to refer to a network time protocol.

A network time protocol synchronizes the system clocks of all participating devices in a computer network (Ethernet). A time server in the network provides the time base for the connected devices that refer to this time to synchronize events.

You can select a high-precision time protocol to achieve high clock accuracy and thus reduce the impact of varying network delays.

"None" Refers to the selected timezone, see [Timezone](#).

"NTP" Uses the network time protocol (NTP).

Remote command:

:SYSTem:TIME:PROTocol on page 829

NTP Address

Sets the IP address or host name of the NTP server.

When the server is detected and verified, the instrument enables the connection automatically.

Remote command:

:SYSTem:NTP:HOSTname on page 827

:SYSTem:NTP:STATe on page 828

17.3.1.2 How to set date and time

To select the timezone

1. Select "System Config > Setup".
2. Select "Maintenance > Date /Time > Timezone".
3. Select continent and city of your location.
Tip: By typing the first letter, you can quickly navigate through the lists to find the desired destination.
4. Close the dialogs.

The instrument adjusts the time according to the selected location.

To set the date and time

1. Select "System Config > Setup".
2. Select "Security > Protection".
3. Enable the "Protection Level 1".
The default password is *123456*.
4. Select "Setup > Maintenance > Date / Time".
5. Adjust the settings.
6. Close the dialogs.

The instrument sets the new date and time.

17.3.2 Check front panel

Within this dialog, you can verify the functionality of the control keys.

How To: See [Chapter 17.3.2.2, "How to test the front panel"](#), on page 858

17.3.2.1 Check front panel settings

Access:

- ▶ Select "System Config > Setup > Maintenance > Check Front Panel".
Reflecting the front panel, the "Check Front Panel" dialog contains all functions to test the operating elements of the instrument.

17.3.2.2 How to test the front panel

See:

- ["Testing the key panel"](#) on page 859

- "Testing the touchscreen" on page 859
- "Terminating the test" on page 860
- "Debugging" on page 860

Testing the key panel

To perform the key panel test, you operate the keys at the front panel, and check the response of the instrument in the "Check Front Panel" dialog. To perform this test properly, check each key of the front panel. The test is only completed, when you have verified all keys.

During the test, the actual functions of the keys are disabled.

1. Select "System Config > Setup".
2. Select "Maintenance > Check Front Panel"
The "Check Front Panel" dialog opens.
3. Press a key on the front panel.
Check if the corresponding key in the "Check Front Panel" dialog turns green.
4. Press the same key a second time.
Check that the key in the dialog turns red.
Note: Pressing the same key again has no further effect, except for the [Esc] key. Pressing this key a third time, terminates the test procedure.
5. Continue with the next key on the front panel and repeat [step 3](#) to [step 5](#) until all keys are tested.

The test is completed, when each key is verified successfully, confirmed by a "Test passed" message.

Testing the touchscreen

1. Select "System Config > Setup > Check Touch Panel".
2. Drag with your finger one or more lines, for example diagonally across the screen.
The test traces the movements of your finger on the screen.

The following results are expected:

- If the lines are uninterrupted, the touchscreen works properly.

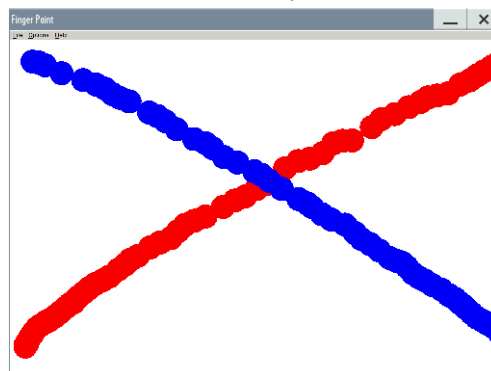

- If there are any gaps, the touch-sensitive functionality is damaged.

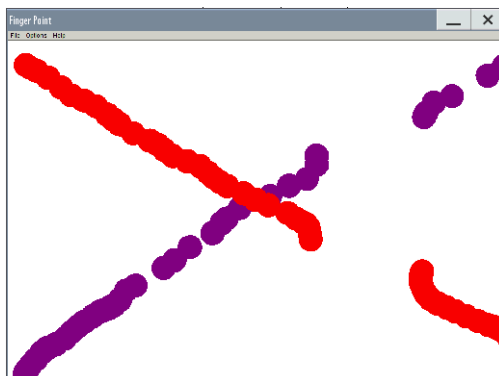

- To return to the "Check Front Panel" dialog, press [Esc].

Terminating the test

- ▶ Press the [Esc] key.
Exits the "Check Front Panel" dialog.

Debugging

1. If you detect a malfunction, for example, when you press the front panel key for the first time, and the color of the button in the dialog turns red (instead of green), the front panel key has probably stuck.
2. Contact the Rohde & Schwarz customer support, see [Chapter 15.9, "Collecting information for technical support"](#), on page 851.

17.3.3 Internal adjustments

Using the integrated adjustment procedures, you can start the calibration directly on the instrument.

17.3.3.1 Internal adjustment settings

Access:

- ▶ Select "System Config > Setup > General > Internal Adjustments".

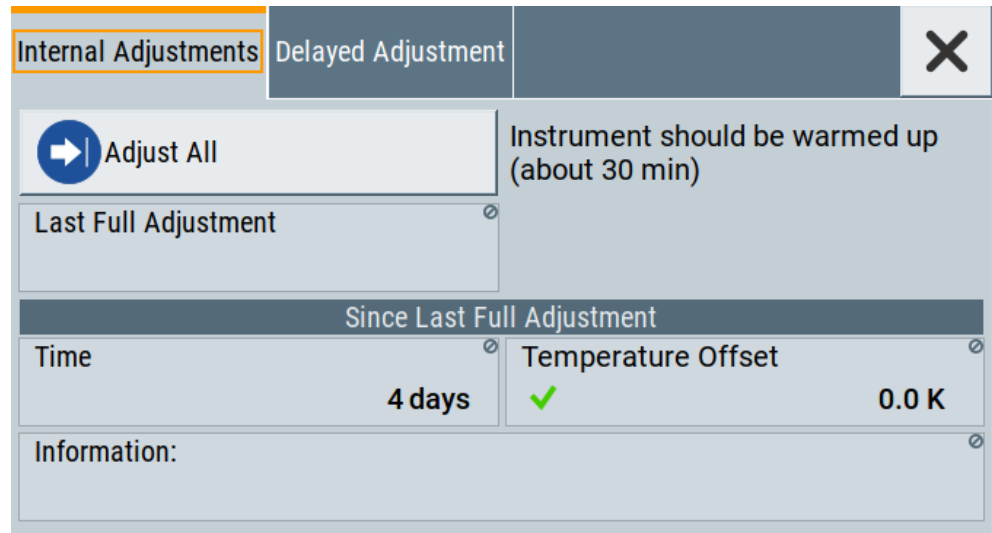

In this dialog, you can perform internal calibration routines, and get information on the last performed calibration.

The "Temperature Offset" indicates the deviation of the current temperature of the instrument, compared to the temperature of the last adjustment.

The remote commands required to define these settings are described in [Chapter 14.6, "CALibration subsystem"](#), on page 592.

How to: See [Chapter 17.3.3.3, "How to use the internal adjustments"](#), on page 863.

Settings

Adjust All

Executes all available internal calibration routines of the instrument.

Note: Before you start the internal adjustment, make sure that you have connected a termination resistor, if necessary.

Remote command:

`:CALibration:ALL[:MEASure]?` on page 592

Last Full Adjustment

Displays the date of the last fully performed adjustment.

Remote command:

`:CALibration<hw>:ALL:DATE?` on page 592

Time

Displays the elapsed time since the last full adjustment.

Remote command:

:CALibration<hw>:ALL:TIME? on page 593

Temperature Offset

Displays the temperature difference, comparing the temperature of the last adjustment to the current instrument temperature.

A green checkmark indicates that the offset is within the permitted range. If the temperature deviates more than ± 5 K, the instrument indicates a warning icon.

Remote command:

:CALibration<hw>:ALL:TEMP? on page 593

Information

Displays information to the current adjustment state.

Remote command:

:CALibration<hw>:ALL:INformation? on page 593

Continue Adjustment on Error

Continues the calibration even though an error was detected. By default adjustments are aborted on error.

This function is password-protected. Unlock the protection level 1 to access it.

Remote command:

:CALibration<hw>:CONTinueonerror on page 594

17.3.3.2 Delayed adjustment settings

Access:

- ▶ Select "System Config > Setup > General > Delayed Adjustment".

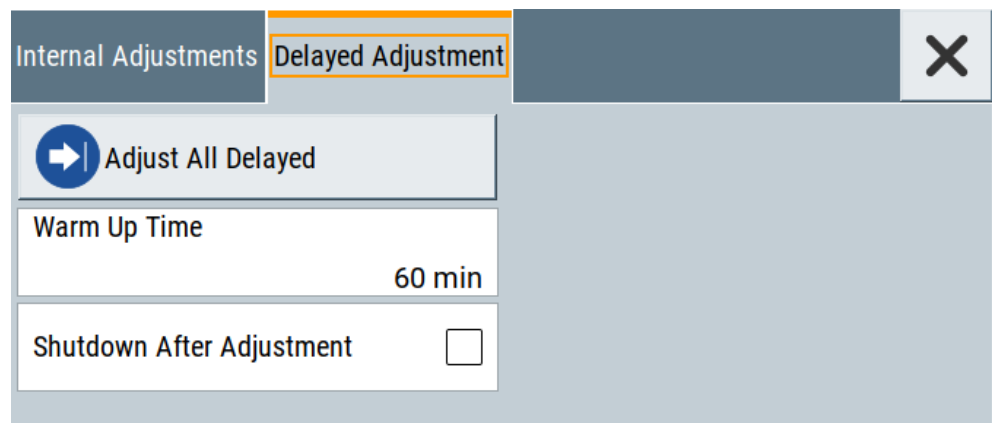

In this dialog, you can set the internal adjustments to start automatically after the selected warm up time and to switch off the instrument after calibration.

The remote commands required to define these settings are described in [Chapter 14.6, "CALibration subsystem"](#), on page 592.

Settings

Adjust All Delayed	863
Warm Up Time	863
Shutdown After Adjustment	863

Adjust All Delayed

Performs all available internal calibration routines of the instrument.

How to: See [Starting internal adjustments automatically](#).

Remote command:

`:CALibration:DELAy[:MEASure]?` on page 595

Warm Up Time

Sets the time for warming up the instrument before the calibration starts automatically.

How to: See [Starting internal adjustments automatically](#).

Remote command:

`:CALibration:DELAy:MINutes` on page 595

Shutdown After Adjustment

Enables the automatic shutdown after internal adjustments.

How to: See [Starting internal adjustments automatically](#).

Remote command:

`:CALibration:DELAy:SHUTdown[:STATe]` on page 595

17.3.3.3 How to use the internal adjustments**Deciding whether to run internal adjustments**

1. Select "System Config > Setup > Internal Adjustment".
2. Check the status and color indication in the section "Since Last Full Adjustment".
Green: internal adjustments are not required.
Red: internal adjustments are required. Observe also the indication in the "Information" field.
3. We recommend that you run internal adjustments in the following cases:
 - Before starting any application that requires a maximum of level accuracy.
 - When a long period of time has passed since the last adjustments.
 - If the ambient temperature of the instrument significantly differs from the one of the last adjustments.
4. Proceed as described in ["Running internal adjustments"](#) on page 863.

Running internal adjustments

1. After switching on, the R&S SMCV100B requires up to 30 minutes to warm up. Wait until the instrument has reached operating temperature to achieve accurate adjustments.

2. **NOTICE!** High output power can damage the DUT. For instruments shipped with firmware versions up to FW 5.00.122.24, high power at the RF 50 Ω output can destroy a connected device under test.
Connect a 50 Ohm terminating resistor with 0.5 W / 27 dBm power rating to the RF 50 Ω output. Terminate the RF output each time before you execute internal adjustments.
3. Select "System Config > Setup > Internal Adjustment > Adjust All".
For instruments that have been shipped with FW 5.10.122.24 and earlier, a warning message prompts you to confirm that you have terminated the RF output.

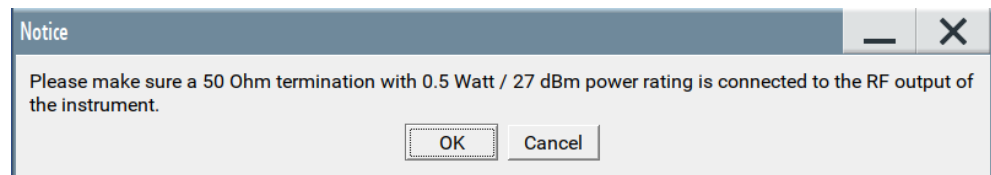

4. Confirm with "Ok".
The adjustment process starts.
The adjustment process takes some time depending on the equipment of the instrument.
If any error occurs, the process aborts. To resolve adjustment issues, see [Chapter 15.6, "Resolving errors during internal adjustments"](#), on page 845.

Starting internal adjustments automatically

The delayed adjustment function executes the adjustments automatically. You can set the warm-up time and shut down after the adjustment process finishes. Using this function, you can execute adjustments without being on-site and start measurements directly when back.

1. If necessary, terminate the RF 50 Ω output. See ["Running internal adjustments"](#) on page 863.
2. Select "System Config > Setup > General > Internal Adjustment".
3. Select "Delayed Adjustment".
4. Set the "Warm Up Time", e.g. 40 min.
The R&S SMCV100B requires a warm-up time of at least 30 min.
5. Enable "Shut Down After Adjustment"
6. Select "Adjust All Delayed".

The process starts with warming up the instrument, indicating the progress in a status dialog. In this dialog, you can abort the process again, if necessary.
After warming up, the R&S SMCV100B executes the internal adjustments and shuts down when finished.

17.3.4 Selftest

Self-test is provided for service purposes.

17.3.4.1 Selftest modules settings

Access:

- ▶ Select "System Config > Setup > Maintenance > Selftest".

The "Modules" dialog opens.

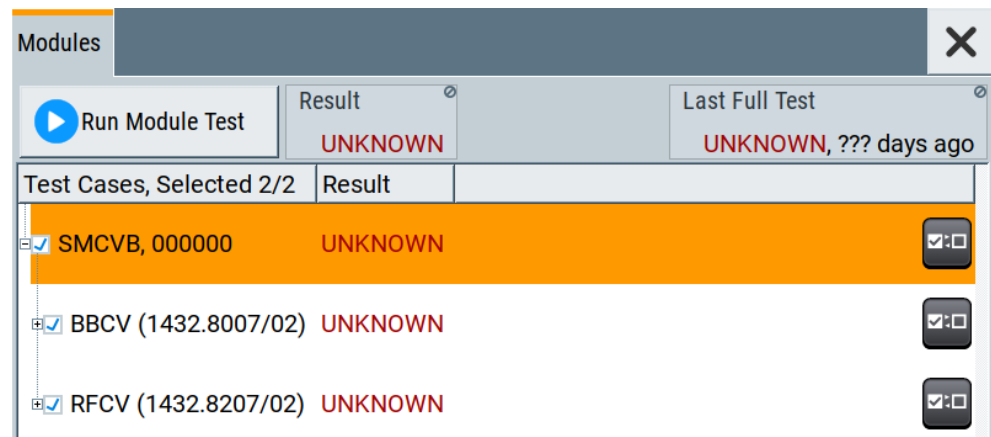

The dialog contains parameters for testing the baseband and RF hardware modules of the R&S SMCV100B.

The remote commands required to define these settings are described in [Chapter 14.19, "TEST subsystem"](#), on page 835.

Run Module Test	865
Result	865
Last Full Test	866
Test table	866

Run Module Test

Runs selftests of the hardware modules selected in the test table.

You can run selftests for the "BBCV" baseband module and the "RFCV" RF module. Also you can execute the tests separately.

Remote command:

`:TEST<hw>:ALL:START` on page 835

Result

Displays the result of the hardware module selftests.

Remote command:

`:TEST<hw>:ALL:RESult?` on page 836

Last Full Test

Displays the result and date of the last hardware module test run including the elapsed time since the last test run.

For example, "PASS, 4 Jul 20, 10 days ago" implies a successful test on July 04, 2020.

Remote command:

:TEST<hw>:ALL:RESult? on page 836

Test table

Displays hardware module selftests available on the R&S SMCV100B.

The table displays the R&S SMCV100B, its serial number, available test cases, test types and test case results.

Test Cases, Selected 2/2	Result	
<input checked="" type="checkbox"/> SMCVB, 000000	UNKNOWN	<input checked="" type="checkbox"/>
<input checked="" type="checkbox"/> BBCV (1432.8007/02)	UNKNOWN	<input checked="" type="checkbox"/>
<input checked="" type="checkbox"/> BuildInTests	UNKNOWN	<input checked="" type="checkbox"/>
<input checked="" type="checkbox"/> RFCV (1432.8207/02)	UNKNOWN	<input checked="" type="checkbox"/>

"Instrument, Serial number"

Displays the instrument and its serial number, e.g., "SMCVB, 123456".

Click to monitor installed test cases and test types.

"Test cases, Test types"

Displays the test case name and part number installed on the R&S SMCV100B including the test type. The following test cases are available:

Test case	Part number	Test types
"BBCV"	1432.8007/02	"BuildInTests"
"RFCV"	1432.8207/02	"BuildInTests"

"Result"

The column displays the selftest results for the instrument, the test cases and the test types.

- "UNKNOWN": No test result available. Select the test and click "Run Module Test" to get test results.
- "PASS": The test is successful.
- "ERROR/FAIL": The test is erroneous.

If you receive an error result, contact the R&S Support, see [Chapter 15.10, "Contacting customer support"](#), on page 852.





Remote command:

:TEST<hw>:ALL:RESult? on page 836





17.3.4.2 How to run hardware module selftests on the R&S SMCV100B

For related settings, see [Chapter 17.3.4.1, "Selftest modules settings"](#), on page 865.

1. Select "System Config > Setup > Maintenance > Selftest > Modules".
2. In the test table, select test cases that you want to execute. By default, the "BBCV" and "RFCV" test cases are selected.
 - a) To view test types included in the test case, click  on the left of the test case. The "BBCV" and "RFCV" offer build-in tests.

Test Cases, Selected 2/2	Result	
<input checked="" type="checkbox"/> SMCVB, 000000	UNKNOWN	
<input checked="" type="checkbox"/> BBCV (1432.8007/02)	UNKNOWN	
<input checked="" type="checkbox"/> BuildInTests	UNKNOWN	
<input checked="" type="checkbox"/> RFCV (1432.8207/02)	UNKNOWN	

- b) To deselect a test case, click  on the right of the test case. For example, deselect "RFCV".

Modules		
 Run Module Test	Result UNKNOWN	Last Full Test UNKNOWN, ??? days ago
Test Cases, Selected 1/2	Result	
<input type="checkbox"/> SMCVB, 000000	UNKNOWN	
<input checked="" type="checkbox"/> BBCV (1432.8007/02)	UNKNOWN	
<input type="checkbox"/> RFCV (1432.8207/02)	UNKNOWN	

3. Click "Run Module Test".

The selected test case tests are executed. After the test run, results with "PASS" or "FAIL" information are available. "UNKNOWN" indicates, that no results are available.

Test Cases, Selected 1/2	Result	Last Full Test
<input type="checkbox"/> SMCVB, 000000	UNKNOWN	UNKNOWN, ??? days ago
<input checked="" type="checkbox"/> BBCV (1432.8007/02)	PASS	
<input type="checkbox"/> RFCV (1432.8207/02)	UNKNOWN	

4. To retrieve composite result information, select all test cases and click "Run Module Test".
- To the right of the "Run Module Test" button, the full selftest "Result" and "Last Full Test" including the test result and the date of the last full test and the elapsed time since the last test run.

Test Cases, Selected 2/2	Result	Last Full Test
<input checked="" type="checkbox"/> SMCVB, 000000	PASS	PASS, 4 Jul 20, 0 days ago
<input checked="" type="checkbox"/> BBCV (1432.8007/02)	PASS	
<input checked="" type="checkbox"/> RFCV (1432.8207/02)	PASS	

17.3.5 FPGA/uC update settings

Access:

- ▶ Select "System Config > Setup > Maintenance > FPGA/μC Update".

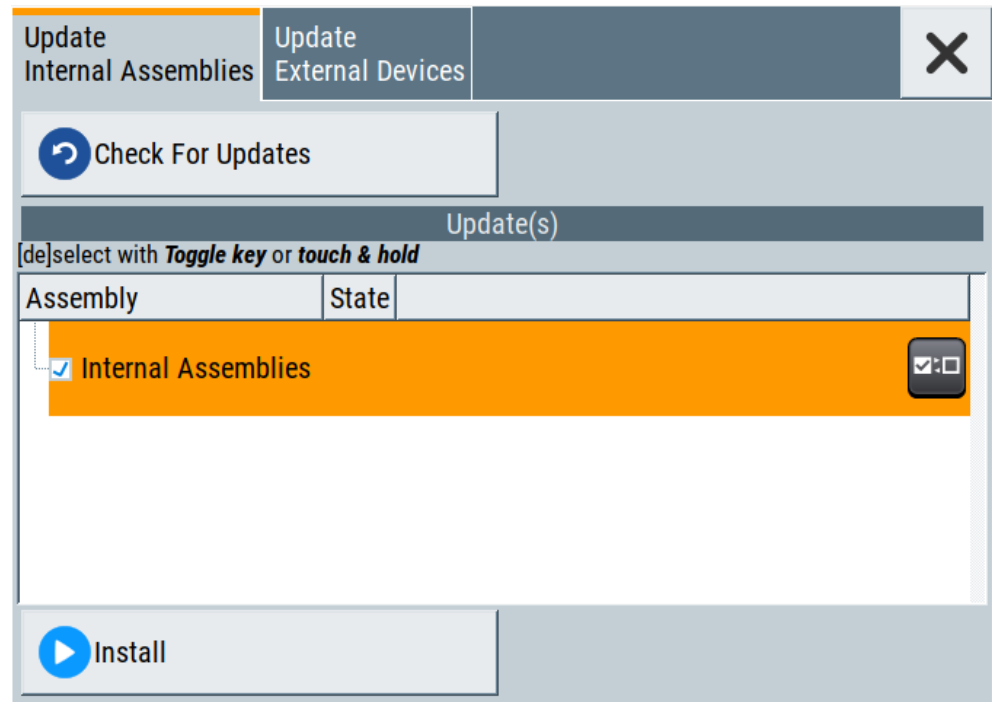

This dialog enables you to check for internal assembly updates and perform updates.

Settings:

Check For Updates.....	869
Assembly.....	869
Install.....	869
Update External Devices.....	869
└ Check For Updates.....	870

Check For Updates

Check for updates of the FPGA/μC.

Remote command:

n.a.

Assembly

The table shows the installed assemblies and their states.

"Assembly" Assembly designation.

"State" Indicates the current state of installed assemblies.

Install

Install all available updates for the FPGA/μC.

Remote command:

n.a.

Update External Devices

This dialog shows the update options of external devices connected to the instrument.

Check For Updates ← Update External Devices

Check for updates of external devices.

Remote command:

n.a.

17.4 Disposal

Rohde & Schwarz is committed to making careful, ecologically sound use of natural resources and minimizing the environmental footprint of our products. Help us by disposing of waste in a way that causes minimum environmental impact.

Disposing electrical and electronic equipment

A product that is labeled as follows cannot be disposed of in normal household waste after it has come to the end of its service life. Even disposal via the municipal collection points for waste electrical and electronic equipment is not permitted.



Figure 17-1: Labeling in line with EU directive WEEE

Rohde & Schwarz has developed a disposal concept for the eco-friendly disposal or recycling of waste material. As a manufacturer, Rohde & Schwarz completely fulfills its obligation to take back and dispose of electrical and electronic waste. Contact your local service representative to dispose of the product.

Annex

A Reference

The chapter provides reference information on GUI and remote control operation of the R&S SMCV100B.

A.1 Extensions for user files.....	871
A.2 Unit shortcuts.....	871

A.1 Extensions for user files

The [Table A-1](#) lists all available file extensions for user files. The currently available files on the instrument depend on the installed options.

Table A-1: List of the automatically assigned file extensions in the instrument

Function	List type	Contents	File suffix
Instrument State	Settings	Instrument settings	*.savrc1txt
User Menu	Settings	User-defined favorite settings	*.user_menu
License Key		License Key	*.xml
"User Correction"	List	User-defined level correction values	*.uco
"List Mode"	List	User-defined frequency/level value pairs	*.lsw
	Settings	Response file	*.txt
"NRP Settings"	Settings	R&S NRP Settings	*.nrp, *.rsu
SCPI command list	List	Export file containing list of SCPIs	*.iec
SCPI command script		SCPI script file formats: Plain SCPI, MATLAB, NICVI, Python3	*.txt, *.m, *.c, *.py
R&S Support Info Archive	Support File	Automatically collected support information	*.tar.gz
Tutorials	Tutorial files	Lists containing SCPIs and explanations	*.tut

A.2 Unit shortcuts

When specifying units or quantities during data entry, the R&S SMCV100B provides the following shortcuts for simplified input.

Shortcut	Designation	Context	Unit
a, A	ampere	Current	A
	atto-	Area, surface	am ²
c, C	centi-	Distance, length	cm
d, D	deci-	Distance, length	dm
		Level, power	dB, dBFS, dBm, dBu, dBW
	degree	Phase, polar/spherical coordinates	deg
e, E	exa-	Area, surface	em ²
f, F	femto-	Area, surface	fm ²
g, G	giga-	Area, surface	Gm ²
		Data rate, sample rate, symbol rate	Gbit/s, Gsample/s, Gsymbol/s, Gchip/s
		Frequency	GHz
		Impedance, resistance	GΩ
h, H	hertz	Frequency	Hz
k, K	kilo-	Area, surface	km ²
		Data rate, sample rate, symbol rate	kbit/s, ksample/s, ksymbol/s, kchip/s
		Distance, length	km
		Frequency	kHz
		Impedance, resistance	kΩ
		Velocity	km/h
m, M	milli-	Area, surface	mm ²
		Current	mA
		Distance, length	mm
		Electromagnetic force, level	mV
		Power	mW
		Time, period, etc.	ms
	mega-	Area, surface	Mm ²
		Data rate, sample rate, symbol rate	Mbit/s, Msample/s, Msym/s, Mchip/s
		Frequency	MHz
		Impedance, resistance	MΩ
n, N	nano-	Area, surface	nm ²
		Current	nA
		Distance, length	nm
		Electromagnetic force, level	nV

Shortcut	Designation	Context	Unit
		Power	nW
		Time, period, etc.	ns
o, O	ohm	Impedance, resistance	Ω
p, P	peta-	Area, surface	pm^2
	percent	Level, ratio	%
	pico-	Area, surface	pm^2
		Current	pA
		Electromagnetic force, level	pV
		Power	pW
		Time, period, etc.	ps
r, R	radiant	Phase, polar/spherical coordinates	rad
s, S	second	Time, period, etc.	s
t, T	terra-	Area, surface	Tm^2
		Data rate, sample rate, symbol rate	Tbit/s, Tsample/s, Tsym/s, Tchip/s
		Frequency	THz
		Impedance, resistance	T Ω
u, U	micro-	Current	μA
		Distance, length	μm
		Electromagnetic force, level	μV
		Power	μW
		Time, period, etc.	μs
v, V	volt	Level, voltage	V
w, W	watt	Level, power	W

Glossary: List of the often used terms and abbreviations

Symbols

/hdd: Provided for backward compatibility with R&S SMBV in remote control; internally mapped to `/var/user/`.

A

Avahi: A licensed [Zeroconf](#) networking feature, including DNS service. The feature enables a device to self-configure an IP address and subnet mask automatically, when a [DHCP](#) server in the LAN is not available.

B

Base unit: This term describes a R&S SMCV100B equipped with baseband generator and R&S SMCVB-B103.

Baseband: The baseband signal, i.e. the I/Q stream at the output of the "Baseband" block.

In rear cases, the term Baseband is used as abbreviation of a "Baseband" block itself.

Baseband domain: A common term for signal processing up to the I/Q modulation. The signal in the baseband domain of the R&S SMCV100B is digital.

Baseband signal: [Baseband](#)

BS: Base station

C

Channel (digital Input, Digital Output): The signal provided at a digital interface connector or the output stream at the digital output interface can consist of several multiplexed channels. Do not mistake the term *channel* used here with the term signal path. A digital channel is a part of an I/Q stream.

Clock: A mandatory reference clock signal for generating the timing pulse in the instrument.

Complete file path: The complete file path specifies the root directory and all subdirectories that contain a file or folder.

Synonyms to this expression are "full file path" and "absolute file path".

See also [Chapter 14.5.2, "Accessing files in the default or in a specified directory"](#), on page 583.

Computer name: [Hostname](#)

Continuous Wave Mode: [CW/Mod](#)

CW/Mod: An internally generated control signal that turns off/on digital modulation, i.e. the signal is generated in unmodulated form.

D

Daisy chain: A connection scheme in which instruments are connected together in sequence, i.e. an output of the first one is connected to an input of the second one, etc.

DHCP: Dynamic Host Configuration Protocol

DNS: Domain Name System server

E

e.g.: For example

F

File transfer: The transmission of files from or to the instrument by a remote client. The instrument supports the standard methods File Transfer Protocol (FTP) and file sharing according to Server Message Protocol (SAMBA/SMB).

G

Glossary: List of the often used terms and abbreviations

GUI: Graphical User Interface

H

Hostname: An unambiguous indication of the instrument in a LAN that uses a [DNS](#) server.

The default hostname follows the syntax `SMCV100B-<serial number>`, e.g. `SMCV100B-102030`.

See [Serial number](#).

Synonym: [Computer name](#)

HUMS: Health and utilization monitoring system.

I

i.e.: That is

I/Q Stream: [Stream](#)

L

Level: In the Baseband domain, a term describing the signal level of the independent I and Q signals during signal processing (e.g. baseband signal leveling, modulation, etc.).

LSB: Least significant bit

M

Marker: User-defined digital signal for synchronizing external devices to the generated data stream.

Do not mistake the term *marker (signal)* used here with the term [Marker \(graphical signal display\)](#).

Marker (graphical signal display): Markers are tools for numerical readout of measured data in diagrams.

Marker signal: [Marker](#)

MIMO: Multiple Input Multiple Outputs

mSata: Memory that holds the operating system, the firmware, and used data. Throughout this description, this memory is referred as an internal memory.

MSB: Most significant bit

MxN: Representation of a [MIMO](#) system, where M is the number of the transmitting Tx antennas and N the number of the receiving Rx antennas.

N

NTP: (Network Time Protocol)

A networking protocol for highly accurate clock synchronization between computer systems and instruments in local area networks, or over the public Internet.

P

PC: Personal computer

PN sequence: [PRBS generator](#)

Power: A term describing the signal level in the RF domain or defining the length of the I/Q vector in the Baseband domain.

PRBS generator: Delivers pseudo-random binary sequences of differing length and duration. They are known as maximum length sequences, and are generated with the aid of ring shift registers with feedback points determined by the polynomial.

Primary-secondary instrument mode: Setup with one or two R&S SMCV100B connected to one R&S SMW. In this multi-instrument setup, the R&S SMCV100B operates as secondary instrument.

The primary instrument generates and outputs a dedicated synchronization signal (Sync Out), that has to be fed into the secondary instruments.

See [Chapter 9, "Configuring a multi-instrument setup"](#), on page 387.

Product page: A designation of the R&S SMCV100B product page <https://www.rohde-schwarz.com/product/SMCV100B.html>

R

Remote access: [Remote operation](#)

Remote control: The operation of the R&S SMCV100B by remote control commands or programs to perform automated tests. The instrument is connected to a system controller via LAN/VXI-11 or USB using Virtual Instrument Software Architecture (VISA). The instrument is controlled either directly, or supported by instrument drivers.

Remote device: External device controls the R&S SMCV100B in remote operation mode, see [Remote operation](#).

Synonyms: External controller, Client device,

Remote operation: Allows you to operate the R&S SMCV100B from a remote device via VNC.

Both the R&S SMCV100B and the remote device are connected in a LAN.

Synonym: Remote access

Removable memory: General term describing mass memory that can be unmounted from the instrument.

RF: Radio Frequency

S

Serial number: Unique instrument identification, provided on the rear panel of the instrument and required to build the [Computer name](#).

The serial number are the last 6 digits in the string <stock no.>-<serial number>, e.g. SMCV100B-102030.

See [Figure 3-4](#).

SISO: Single Input Single Output

Smart device: A mobile, cordless device, such as a smartphone or tablet, capable of Internet browsing.

Synonyms: Smartphone, Tablet

Star configuration: A connection scheme for several instruments that consists of one central instrument and several other instruments, all connected to the central one.

Stream: An I/Q stream describes the signal at the input of the "I/Q Stream Mapper" up to the output connectors of the instrument.

Symbol Clock: Represents the frequency and exact timing of the transmission of the individual symbols

Symbol Rate: Calculated as follows:

"Symbol Rate" = "Bit Rate" / Number of bits transmitted with each symbol

Sync signal: In primary-secondary instrument mode, this term describes the signal generated by the primary instrument and fed to the secondary instruments. The synchronization signal is a precise signal that facilitates the time alignment between the instruments and acts as trigger signal.

System drive: The system drive is a μ SD card that holds the operating system, the firmware, and the user data.

Throughout this description, the system drive is referred as an internal memory.

T

Trigger: Internally generated or externally supplied signal which starts signal generation at a particular point in time.

Trigger event: A trigger event is caused by the received trigger signal or executed manual trigger.

U

UE: User equipment

USBTMC: (USB Test & Measurement Class)

A protocol built on top of USB for communication with USB devices. Using VISA library, it supports service request, triggers, and other specific operations.

User directory: Describes the default file storage location for user data.

In the file system, user directory is indicated as `/var/user/`.

It is physically located on the internal memory or on the removable memory.

W

Waveform: A file with settings provided for repeatable tests with the same test signal.

Z

Zeroconf: Zero-configuration, see [Avahi](#).

List of remote commands (base unit)

:CALibration:ALL[:MEASure]?	592
:CALibration:DATA:FACTory:DATE?	594
:CALibration:DELAy:MINutes	595
:CALibration:DELAy:SHUTdown[:STATe]	595
:CALibration:DELAy[:MEASure]?	595
:CALibration:ROSCillator[:DATA]	594
:CALibration<hw>:ALL:DATE?	592
:CALibration<hw>:ALL:INFormation?	593
:CALibration<hw>:ALL:TEMP?	593
:CALibration<hw>:ALL:TIME?	593
:CALibration<hw>:CONTInueonerror	594
:DEVice:PRESet	580
:DIAGnostic:INFO:OTIME?	597
:DIAGnostic:INFO:POCount?	598
:DIAGnostic<hw>:BGInfo:CATalog?	597
:DIAGnostic<hw>:BGInfo?	597
:DIAGnostic<hw>:POINT:CATalog?	598
:DIAGnostic<hw>[:MEASure]:POINT?	598
:DISPlay:ANNotation:AMPLitude	608
:DISPlay:ANNotation:FREQuency	609
:DISPlay:ANNotation[:ALL]	609
:DISPlay:BRIGhtness	608
:DISPlay:BUtTon:BRIGhtness	608
:DISPlay:DIALog:CLOSe	610
:DISPlay:DIALog:CLOSe:ALL	611
:DISPlay:DIALog:ID?	609
:DISPlay:DIALog:OPEN	610
:DISPlay:PSAVe:HOLDoff	607
:DISPlay:PSAVe[:STATe]	607
:DISPlay:UPDate[:STATe]	608
:FORMat:BORDer	611
:FORMat:SREGister	611
:FORMat[:DATA]	612
:HCOPY:DATA?	614
:HCOPY:DEVice:LANGuage	614
:HCOPY:FILE[:NAME]	614
:HCOPY:FILE[:NAME]:AUTO:DIRectory	615
:HCOPY:FILE[:NAME]:AUTO:DIRectory:CLEar	616
:HCOPY:FILE[:NAME]:AUTO:FILE?	616
:HCOPY:FILE[:NAME]:AUTO:STATe	616
:HCOPY:FILE[:NAME]:AUTO?	615
:HCOPY:FILE[:NAME]:AUTO[:FILE]:DAY:STATe	616
:HCOPY:FILE[:NAME]:AUTO[:FILE]:MONTH:STATe	616
:HCOPY:FILE[:NAME]:AUTO[:FILE]:NUMBer?	617
:HCOPY:FILE[:NAME]:AUTO[:FILE]:PREFix	617
:HCOPY:FILE[:NAME]:AUTO[:FILE]:PREFix:STATe	617
:HCOPY:FILE[:NAME]:AUTO[:FILE]:YEAR:STATe	616

:HCOPy:IMAGe:FORMat.....	614
:HCOPy:REGion.....	614
:HCOPy[:EXECute].....	615
:INITiate<hw>[:POWer]:CONTinuous.....	626
:KBOard:LAYout.....	617
:MEMory:HFRee?.....	591
:MMEMory:CATalog:LENGth?.....	587
:MMEMory:CATalog?.....	586
:MMEMory:CDIRectory.....	587
:MMEMory:COpy.....	587
:MMEMory:DATA.....	588
:MMEMory:DCATalog:LENGth?.....	589
:MMEMory:DCATalog?.....	589
:MMEMory:DELeTe.....	589
:MMEMory:LOAD:STATe.....	589
:MMEMory:MDIRectory.....	590
:MMEMory:MOVE.....	590
:MMEMory:MSIS.....	590
:MMEMory:RDIRectory.....	591
:MMEMory:STORe:STATe.....	591
:OUTPut:ALL[:STATe].....	618
:OUTPut:USER<ch>:DIRectioN.....	650
:OUTPut:USER<ch>:SIGNal.....	651
:OUTPut<hw>:AFIXed:RANGe:LOWer?.....	620
:OUTPut<hw>:AFIXed:RANGe:UPPer?.....	620
:OUTPut<hw>:AMODE.....	619
:OUTPut<hw>:IMPedance?.....	619
:OUTPut<hw>:PROTection:CLEAr.....	620
:OUTPut<hw>:PROTection:TRIPped?.....	620
:OUTPut<hw>[:STATe].....	618
:OUTPut<hw>[:STATe]:PON.....	619
:READ<ch>[:POWer]?.....	627
:SCONfiguration:EXTeRnal:ACONnect.....	640
:SCONfiguration:EXTeRnal:DISPlay.....	640
:SCONfiguration:EXTeRnal:HSDigital:DIRectioN?.....	641
:SCONfiguration:EXTeRnal:HSDigital:RCONnection:STATe?.....	642
:SCONfiguration:EXTeRnal:HSDigital:REMote:CONNect.....	646
:SCONfiguration:EXTeRnal:HSDigital:REMote:DISConnect.....	647
:SCONfiguration:EXTeRnal:HSDigital:REMote:INFO?.....	647
:SCONfiguration:EXTeRnal:HSDigital:REMote:INITialization:FILE.....	648
:SCONfiguration:EXTeRnal:HSDigital:REMote:ISElect.....	646
:SCONfiguration:EXTeRnal:HSDigital:RF:COUPLing.....	642
:SCONfiguration:EXTeRnal:HSDigital:RF:FREQuency.....	643
:SCONfiguration:EXTeRnal:HSDigital:RF:FREQuency:OFFSet.....	643
:SCONfiguration:EXTeRnal:HSDigital:RF:POWer.....	643
:SCONfiguration:EXTeRnal:HSDigital:RF:POWer:OFFSet.....	643
:SCONfiguration:EXTeRnal:HSDigital:RF:STATe.....	644
:SCONfiguration:EXTeRnal:HSDigital<ch>:INAMe?.....	642
:SCONfiguration:EXTeRnal:HSDigital<ch>:IQConnection:STATe?.....	641
:SCONfiguration:EXTeRnal:HSDigital<ch>:REMote:DETeCt?.....	646

:SCONfiguration:EXTernal:HSDigital<ch>:REMote:ICONnect.....	647
:SCONfiguration:EXTernal:HSDigital<ch>:REMote:SEND.....	648
:SCONfiguration:EXTernal:PBEHaviour.....	641
:SCONfiguration:EXTernal:REMote:ADD.....	645
:SCONfiguration:EXTernal:REMote:CLEan.....	648
:SCONfiguration:EXTernal:REMote:CONNect[:ALL].....	641
:SCONfiguration:EXTernal:REMote:DISConnect[:ALL].....	641
:SCONfiguration:EXTernal:REMote:INITialization:CATalog?.....	647
:SCONfiguration:EXTernal:REMote:LIST?.....	645
:SCONfiguration:EXTernal:REMote:PURGe.....	648
:SCONfiguration:EXTernal:REMote:REName.....	646
:SCONfiguration:EXTernal:REMote:SCAN.....	644
:SCONfiguration:EXTernal:REMote:SCAN:STATe?.....	644
:SCONfiguration:MULTIinstrument:MODE.....	638
:SCONfiguration:MULTIinstrument:STATe.....	638
:SCONfiguration:MULTIinstrument:TRIGger:SYNChronization?.....	638
:SCONfiguration:OUTPut:MAPPing:HSDigital:CHANnel<dj>:STReam<st>:STATe.....	639
:SCONfiguration:OUTPut:MAPPing:RF:STReam<st>:STATe.....	639
:SCONfiguration:OUTPut:MAPPing:STReam<st>:FOFFset.....	639
:SCONfiguration:OUTPut:MAPPing:STReam<st>:POFFset.....	639
:SENSe<ch>:UNIT[:POWer].....	628
:SENSe<ch>[:POWer]:APERture:DEFault:STATe.....	628
:SENSe<ch>[:POWer]:APERture:TIME.....	628
:SENSe<ch>[:POWer]:CORRection:SPDevice:LIST?.....	629
:SENSe<ch>[:POWer]:CORRection:SPDevice:SElect.....	629
:SENSe<ch>[:POWer]:CORRection:SPDevice:STATe.....	629
:SENSe<ch>[:POWer]:DISPlay:PERManent:PRiority.....	629
:SENSe<ch>[:POWer]:DISPlay:PERManent:STATe.....	630
:SENSe<ch>[:POWer]:FILTer:LENGth:AUTO?.....	630
:SENSe<ch>[:POWer]:FILTer:LENGth[:USER].....	630
:SENSe<ch>[:POWer]:FILTer:NSRatio.....	631
:SENSe<ch>[:POWer]:FILTer:NSRatio:MTIME.....	631
:SENSe<ch>[:POWer]:FILTer:SONCe.....	631
:SENSe<ch>[:POWer]:FILTer:TYPE.....	632
:SENSe<ch>[:POWer]:FREQuency.....	632
:SENSe<ch>[:POWer]:LOGGing:STATe.....	633
:SENSe<ch>[:POWer]:OFFSet.....	633
:SENSe<ch>[:POWer]:OFFSet:STATe.....	633
:SENSe<ch>[:POWer]:SNUMber?.....	634
:SENSe<ch>[:POWer]:SOURce.....	634
:SENSe<ch>[:POWer]:STATus[:DEVice]?.....	634
:SENSe<ch>[:POWer]:TYPE?.....	635
:SENSe<ch>[:POWer]:ZERO.....	635
:SLISt:CLEar:LAN.....	625
:SLISt:CLEar:USB.....	625
:SLISt:CLEar[:ALL].....	626
:SLISt:ELEMent<ch>:MAPPing.....	626
:SLISt:SCAN:LSENSor.....	624
:SLISt:SCAN:USENSor.....	625
:SLISt:SCAN[:STATe].....	624

:SLIST:SENSor:MAP.....	626
:SLIST[:LIST]?.....	624
:SOURce<hw>:PRESet.....	581
:STATus:OPERation:CONDition?.....	832
:STATus:OPERation:ENABLE.....	832
:STATus:OPERation:NTRansition.....	833
:STATus:OPERation:PTRansition.....	833
:STATus:OPERation[:EVENT].....	832
:STATus:PRESet.....	833
:STATus:QUEStionable:CONDition.....	834
:STATus:QUEStionable:ENABLE.....	834
:STATus:QUEStionable:NTRansition.....	834
:STATus:QUEStionable:PTRansition.....	835
:STATus:QUEStionable[:EVENT].....	834
:STATus:QUEue[:NEXT]?.....	835
:SYSTem:BIOS:VERSion?.....	829
:SYSTem:COMMunicate:HISLip:RESource?.....	818
:SYSTem:COMMunicate:NETWork:IPAdDress.....	819
:SYSTem:COMMunicate:NETWork:IPAdDress:MODE.....	819
:SYSTem:COMMunicate:NETWork:MACAdDress.....	819
:SYSTem:COMMunicate:NETWork:RESource?.....	819
:SYSTem:COMMunicate:NETWork:REStart.....	820
:SYSTem:COMMunicate:NETWork:STATus?.....	820
:SYSTem:COMMunicate:NETWork[:COMMOn]:DOMain.....	820
:SYSTem:COMMunicate:NETWork[:COMMOn]:HOSTname.....	820
:SYSTem:COMMunicate:NETWork[:COMMOn]:WORKgroup.....	821
:SYSTem:COMMunicate:NETWork[:IPAdDress]:DNS.....	821
:SYSTem:COMMunicate:NETWork[:IPAdDress]:GATeway.....	821
:SYSTem:COMMunicate:NETWork[:IPAdDress]:SUBNet:MASK.....	821
:SYSTem:COMMunicate:SOCKet:RESource?.....	822
:SYSTem:COMMunicate:USB:RESource?.....	822
:SYSTem:DATE.....	827
:SYSTem:DFPR?.....	830
:SYSTem:DLOCK.....	815
:SYSTem:ERRor:ALL?.....	811
:SYSTem:ERRor:CODE:ALL?.....	812
:SYSTem:ERRor:CODE[:NEXT]?.....	812
:SYSTem:ERRor:COUNT?.....	813
:SYSTem:ERRor:GNEXt?.....	814
:SYSTem:ERRor:HISTory:CLEar.....	814
:SYSTem:ERRor:STATic?.....	814
:SYSTem:ERRor[:NEXT]?.....	813
:SYSTem:FPReset.....	581
:SYSTem:HELP:EXPort.....	822
:SYSTem:IDENtification.....	822
:SYSTem:IDENtification:PRESet.....	823
:SYSTem:INFormation:SCPI.....	824
:SYSTem:IRESpone.....	823
:SYSTem:KLOCK.....	815
:SYSTem:LANGUage.....	824

:SYSTem:LOCK:OWNer?	816
:SYSTem:LOCK:RELease:ALL	816
:SYSTem:LOCK:REQuest[:EXCLusive]?	817
:SYSTem:MMEMory:PATH:USER?	830
:SYSTem:NINformation?	815
:SYSTem:NTP:HOSTname	827
:SYSTem:NTP:STATe	828
:SYSTem:ORESpone	823
:SYSTem:OSYSem?	830
:SYSTem:PRESet	581
:SYSTem:PROTect<ch>[:STATe]	817
:SYSTem:RCL	817
:SYSTem:REBoot	831
:SYSTem:RESart	831
:SYSTem:SAV	817
:SYSTem:SECurity:SANitize[:STATe]	824
:SYSTem:SECurity:SUPolicy	824
:SYSTem:SECurity:VOLMode[:STATe]	818
:SYSTem:SHUTdown	831
:SYSTem:SPECification:IDENtification:CATalog?	825
:SYSTem:SPECification:PARAmeter?	825
:SYSTem:SPECification:VERSion	825
:SYSTem:SPECification:VERSion:CATalog?	826
:SYSTem:SPECification:VERSion:FACTory?	826
:SYSTem:SPECification?	825
:SYSTem:SRData?	826
:SYSTem:STARtup:COMPLete?	827
:SYSTem:TIME	828
:SYSTem:TIME:PROTocol	829
:SYSTem:TIME:ZONE	828
:SYSTem:TIME:ZONE:CATalog?	828
:SYSTem:ULOCK	816
:SYSTem:UPTime?	829
:SYSTem:VERSion?	830
:SYSTem:WAIT	831
:TEST<hw>:ALL:RESult?	836
:TEST<hw>:ALL:STARt	835
:TRIGger<hw>:FSWeep:SOURce	837
:TRIGger<hw>:FSWeep[:IMMediate]	838
:TRIGger<hw>:PSWeep:SOURce	837
:TRIGger<hw>:PSWeep[:IMMediate]	838
:TRIGger<hw>[:SWEep]:SOURce	837
:TRIGger<hw>[:SWEep][:IMMediate]	838
:UNIT:ANGLE	839
:UNIT:POWer	839
[:SOURce]:BB:GRAPhics:ADD	749
[:SOURce]:BB:GRAPhics:CLOSe	749
[:SOURce]:BB:GRAPhics:FFTFscale	750
[:SOURce]:BB:GRAPhics:FFTLen	750
[:SOURce]:BB:GRAPhics:SOURce	749

[[:SOURce]:CORREction:CSET:CATalog?.....	756
[[:SOURce]:CORREction:CSET:DELeTe.....	757
[[:SOURce]:INPut:TRIGger:SLOPe.....	765
[[:SOURce]:INPut:USER:CLOCK:IMPedance.....	652
[[:SOURce]:INPut:USER:CLOCK:LEVel.....	652
[[:SOURce]:INPut:USER:CLOCK:SLOPe.....	652
[[:SOURce]:INPut:USER:TRIGger:IMPedance.....	652
[[:SOURce]:INPut:USER:TRIGger:LEVel.....	652
[[:SOURce]:INPut:USER:TRIGger:SLOPe.....	653
[[:SOURce]:INPut:USER<ch>:DIRection.....	650
[[:SOURce]:INPut:USER<ch>:SIGNal.....	651
[[:SOURce]:IQ:OUTPut:DIGital:BBMM<ch>:CHANnel<st0>:POWER:LEVel.....	769
[[:SOURce]:IQ:OUTPut:DIGital:BBMM<ch>:CHANnel<st0>:POWER:PEP.....	768
[[:SOURce]:IQ:OUTPut:DIGital:CHANnel<st0>:NAME.....	770
[[:SOURce]:IQ:OUTPut:DIGital:CHANnel<st0>:SRATe.....	770
[[:SOURce]:IQ:OUTPut:DIGital:CHANnel<st0>:STATe.....	771
[[:SOURce]:IQ:OUTPut:DIGital:POWER:VIA.....	768
[[:SOURce]:IQ:OUTPut:DIGital:SRATe:MAX?.....	771
[[:SOURce]:IQ:OUTPut:DIGital:SRATe:SUM?.....	771
[[:SOURce]:ROSCillator:EXTErnal:FREQuency.....	798
[[:SOURce]:ROSCillator:EXTErnal:MLRAnge?.....	799
[[:SOURce]:ROSCillator:EXTErnal:NSBAnDwidth?.....	799
[[:SOURce]:ROSCillator:EXTErnal:RFOFF[:STATe].....	798
[[:SOURce]:ROSCillator:EXTErnal:SBANdwidth.....	798
[[:SOURce]:ROSCillator:OUTPut:FREQuency:MODE.....	799
[[:SOURce]:ROSCillator:PRESet.....	797
[[:SOURce]:ROSCillator:SOURce.....	797
[[:SOURce]:ROSCillator[:INTErnal]:ADJJust:VALue.....	800
[[:SOURce]:ROSCillator[:INTErnal]:ADJJust[:STATe].....	800
[[:SOURce<hw>]:AWGN:BRATe.....	743
[[:SOURce<hw>]:AWGN:BWIDth.....	741
[[:SOURce<hw>]:AWGN:BWIDth:COUPling[:STATe].....	741
[[:SOURce<hw>]:AWGN:BWIDth:NOISe?.....	742
[[:SOURce<hw>]:AWGN:BWIDth:RATio.....	741
[[:SOURce<hw>]:AWGN:CNRatio.....	743
[[:SOURce<hw>]:AWGN:DISP:MODE.....	742
[[:SOURce<hw>]:AWGN:ENRatio.....	743
[[:SOURce<hw>]:AWGN:FREQuency:RESUlt?.....	745
[[:SOURce<hw>]:AWGN:FREQuency:TARGet.....	745
[[:SOURce<hw>]:AWGN:MODE.....	740
[[:SOURce<hw>]:AWGN:POWER:CARRier.....	744
[[:SOURce<hw>]:AWGN:POWER:MODE.....	742
[[:SOURce<hw>]:AWGN:POWER:NOISe.....	744
[[:SOURce<hw>]:AWGN:POWER:NOISe:TOTal?.....	744
[[:SOURce<hw>]:AWGN:POWER:RMODE.....	743
[[:SOURce<hw>]:AWGN:POWER:SUM:PEP?.....	745
[[:SOURce<hw>]:AWGN:POWER:SUM?.....	744
[[:SOURce<hw>]:AWGN:STATe.....	740
[[:SOURce<hw>]:BB:ARBITrary:CLOCK.....	703
[[:SOURce<hw>]:BB:ARBITrary:CLOCK:SOURce.....	730

[:SOURce<hw>]:BB:ARBitrary:MCARrier:CARRier:COUNT.....	714
[:SOURce<hw>]:BB:ARBitrary:MCARrier:CARRier:MODE.....	714
[:SOURce<hw>]:BB:ARBitrary:MCARrier:CARRier:SPACing.....	714
[:SOURce<hw>]:BB:ARBitrary:MCARrier:CARRier<ch>:CONFLict?.....	720
[:SOURce<hw>]:BB:ARBitrary:MCARrier:CARRier<ch>:DELay.....	719
[:SOURce<hw>]:BB:ARBitrary:MCARrier:CARRier<ch>:FILE.....	720
[:SOURce<hw>]:BB:ARBitrary:MCARrier:CARRier<ch>:FREQUency.....	718
[:SOURce<hw>]:BB:ARBitrary:MCARrier:CARRier<ch>:PHASe.....	719
[:SOURce<hw>]:BB:ARBitrary:MCARrier:CARRier<ch>:POWer.....	719
[:SOURce<hw>]:BB:ARBitrary:MCARrier:CARRier<ch>:STATe.....	718
[:SOURce<hw>]:BB:ARBitrary:MCARrier:CFACTOR:MODE.....	715
[:SOURce<hw>]:BB:ARBitrary:MCARrier:CLIPping:CFACTOR.....	715
[:SOURce<hw>]:BB:ARBitrary:MCARrier:CLIPping:CUToff.....	716
[:SOURce<hw>]:BB:ARBitrary:MCARrier:CLIPping[STATe].....	716
[:SOURce<hw>]:BB:ARBitrary:MCARrier:CLOAd.....	717
[:SOURce<hw>]:BB:ARBitrary:MCARrier:CLOCK?.....	718
[:SOURce<hw>]:BB:ARBitrary:MCARrier:CREate.....	718
[:SOURce<hw>]:BB:ARBitrary:MCARrier:EDIT:CARRier:DELay:STEP.....	722
[:SOURce<hw>]:BB:ARBitrary:MCARrier:EDIT:CARRier:DELay[START].....	723
[:SOURce<hw>]:BB:ARBitrary:MCARrier:EDIT:CARRier:EXECute.....	723
[:SOURce<hw>]:BB:ARBitrary:MCARrier:EDIT:CARRier:FILE.....	723
[:SOURce<hw>]:BB:ARBitrary:MCARrier:EDIT:CARRier:PHASe:STEP.....	721
[:SOURce<hw>]:BB:ARBitrary:MCARrier:EDIT:CARRier:PHASe[START].....	722
[:SOURce<hw>]:BB:ARBitrary:MCARrier:EDIT:CARRier:POWer:STEP.....	721
[:SOURce<hw>]:BB:ARBitrary:MCARrier:EDIT:CARRier:POWer[START].....	721
[:SOURce<hw>]:BB:ARBitrary:MCARrier:EDIT:CARRier:START.....	720
[:SOURce<hw>]:BB:ARBitrary:MCARrier:EDIT:CARRier:STATe.....	720
[:SOURce<hw>]:BB:ARBitrary:MCARrier:EDIT:CARRier:STOP.....	720
[:SOURce<hw>]:BB:ARBitrary:MCARrier:OFILe.....	717
[:SOURce<hw>]:BB:ARBitrary:MCARrier:POWer:REFerence.....	717
[:SOURce<hw>]:BB:ARBitrary:MCARrier:PRESet.....	713
[:SOURce<hw>]:BB:ARBitrary:MCARrier:SAMPles?.....	715
[:SOURce<hw>]:BB:ARBitrary:MCARrier:SETTing:CATalog?.....	713
[:SOURce<hw>]:BB:ARBitrary:MCARrier:SETTing:LOAD.....	713
[:SOURce<hw>]:BB:ARBitrary:MCARrier:SETTing:STORE.....	713
[:SOURce<hw>]:BB:ARBitrary:MCARrier:TIME.....	715
[:SOURce<hw>]:BB:ARBitrary:MCARrier:TIME:MODE.....	716
[:SOURce<hw>]:BB:ARBitrary:PRESet.....	696
[:SOURce<hw>]:BB:ARBitrary:SIGNAL:TYPE.....	697
[:SOURce<hw>]:BB:ARBitrary:STATe.....	696
[:SOURce<hw>]:BB:ARBitrary:TRIGger:ARM:EXECute.....	725
[:SOURce<hw>]:BB:ARBitrary:TRIGger:DELay:UNIT.....	726
[:SOURce<hw>]:BB:ARBitrary:TRIGger:EXECute.....	725
[:SOURce<hw>]:BB:ARBitrary:TRIGger:OUTPut<ch>:DELay.....	729
[:SOURce<hw>]:BB:ARBitrary:TRIGger:OUTPut<ch>:DINSec?.....	730
[:SOURce<hw>]:BB:ARBitrary:TRIGger:OUTPut<ch>:MODE.....	728
[:SOURce<hw>]:BB:ARBitrary:TRIGger:OUTPut<ch>:OFFTime.....	728
[:SOURce<hw>]:BB:ARBitrary:TRIGger:OUTPut<ch>:ONTTime.....	728
[:SOURce<hw>]:BB:ARBitrary:TRIGger:OUTPut<ch>:PATtern.....	728
[:SOURce<hw>]:BB:ARBitrary:TRIGger:OUTPut<ch>:PULSe:DIVider.....	729

[:SOURce<hw>]:BB:ARBitrary:TRIGger:OUTPut<ch>:PULSe:FREQuency?.....	729
[:SOURce<hw>]:BB:ARBitrary:TRIGger:PTIME?.....	726
[:SOURce<hw>]:BB:ARBitrary:TRIGger:RMODE?.....	724
[:SOURce<hw>]:BB:ARBitrary:TRIGger:SLENgth.....	724
[:SOURce<hw>]:BB:ARBitrary:TRIGger:SLUNit.....	725
[:SOURce<hw>]:BB:ARBitrary:TRIGger:SMODE.....	708
[:SOURce<hw>]:BB:ARBitrary:TRIGger:SOURce.....	724
[:SOURce<hw>]:BB:ARBitrary:TRIGger[:EXTErnal]:DELay.....	726
[:SOURce<hw>]:BB:ARBitrary:TRIGger[:EXTErnal]:INHibit.....	727
[:SOURce<hw>]:BB:ARBitrary:TRIGger[:EXTErnal]:RDELay?.....	727
[:SOURce<hw>]:BB:ARBitrary:TRIGger[:EXTErnal]:SYNChronize:OUTPut.....	725
[:SOURce<hw>]:BB:ARBitrary:TRIGger[:EXTErnal]:TDELay.....	727
[:SOURce<hw>]:BB:ARBitrary:TSIGnal:CIQ:CREate.....	700
[:SOURce<hw>]:BB:ARBitrary:TSIGnal:CIQ:CREate:NAMed.....	700
[:SOURce<hw>]:BB:ARBitrary:TSIGnal:CIQ:I.....	697
[:SOURce<hw>]:BB:ARBitrary:TSIGnal:CIQ:Q.....	697
[:SOURce<hw>]:BB:ARBitrary:TSIGnal:RECTangle:AMPLitude.....	697
[:SOURce<hw>]:BB:ARBitrary:TSIGnal:RECTangle:CREate.....	700
[:SOURce<hw>]:BB:ARBitrary:TSIGnal:RECTangle:CREate:NAMed.....	700
[:SOURce<hw>]:BB:ARBitrary:TSIGnal:RECTangle:FREQuency.....	698
[:SOURce<hw>]:BB:ARBitrary:TSIGnal:RECTangle:OFFSet.....	698
[:SOURce<hw>]:BB:ARBitrary:TSIGnal:RECTangle:SAMPles.....	698
[:SOURce<hw>]:BB:ARBitrary:TSIGnal:SINE:CREate.....	700
[:SOURce<hw>]:BB:ARBitrary:TSIGnal:SINE:CREate:NAMed.....	700
[:SOURce<hw>]:BB:ARBitrary:TSIGnal:SINE:FREQuency.....	699
[:SOURce<hw>]:BB:ARBitrary:TSIGnal:SINE:PHASe.....	699
[:SOURce<hw>]:BB:ARBitrary:TSIGnal:SINE:SAMPles.....	699
[:SOURce<hw>]:BB:ARBitrary:WAVeform:CATalog:LENGTh?.....	701
[:SOURce<hw>]:BB:ARBitrary:WAVeform:CATalog?.....	701
[:SOURce<hw>]:BB:ARBitrary:WAVeform:CLOCK.....	704
[:SOURce<hw>]:BB:ARBitrary:WAVeform:DATA.....	702
[:SOURce<hw>]:BB:ARBitrary:WAVeform:DELeTe.....	701
[:SOURce<hw>]:BB:ARBitrary:WAVeform:FREE?.....	702
[:SOURce<hw>]:BB:ARBitrary:WAVeform:HDDStreaming:STATe.....	704
[:SOURce<hw>]:BB:ARBitrary:WAVeform:POINts?.....	702
[:SOURce<hw>]:BB:ARBitrary:WAVeform:SELEct.....	701
[:SOURce<hw>]:BB:ARBitrary:WAVeform:TAG?.....	703
[:SOURce<hw>]:BB:ARBitrary:WSEGment:CLOAd.....	708
[:SOURce<hw>]:BB:ARBitrary:WSEGment:CONFIgure:BLANK:APPend.....	709
[:SOURce<hw>]:BB:ARBitrary:WSEGment:CONFIgure:CATalog?.....	710
[:SOURce<hw>]:BB:ARBitrary:WSEGment:CONFIgure:CLOCK.....	710
[:SOURce<hw>]:BB:ARBitrary:WSEGment:CONFIgure:CLOCK:MODE.....	710
[:SOURce<hw>]:BB:ARBitrary:WSEGment:CONFIgure:COMMENT.....	711
[:SOURce<hw>]:BB:ARBitrary:WSEGment:CONFIgure:DELeTe.....	711
[:SOURce<hw>]:BB:ARBitrary:WSEGment:CONFIgure:LEVel[:MODE].....	710
[:SOURce<hw>]:BB:ARBitrary:WSEGment:CONFIgure:MARKer:ESEGment.....	708
[:SOURce<hw>]:BB:ARBitrary:WSEGment:CONFIgure:MARKer:FSEGment.....	708
[:SOURce<hw>]:BB:ARBitrary:WSEGment:CONFIgure:MARKer:MODE.....	708
[:SOURce<hw>]:BB:ARBitrary:WSEGment:CONFIgure:OFILe.....	711
[:SOURce<hw>]:BB:ARBitrary:WSEGment:CONFIgure:SEGment:APPend.....	711

[:SOURce<hw>]:BB:ARBitrary:WSEgment:CONFigure:SEGment:CATalog?	706
[:SOURce<hw>]:BB:ARBitrary:WSEgment:CONFigure:SElect	711
[:SOURce<hw>]:BB:ARBitrary:WSEgment:CREate	707
[:SOURce<hw>]:BB:ARBitrary:WSEgment:LMODe	706
[:SOURce<hw>]:BB:ARBitrary:WSEgment:NAME?	705
[:SOURce<hw>]:BB:ARBitrary:WSEgment:NEXT	705
[:SOURce<hw>]:BB:ARBitrary:WSEgment:NEXT:EXECute	705
[:SOURce<hw>]:BB:ARBitrary:WSEgment:NEXT:SOURce	706
[:SOURce<hw>]:BB:ARBitrary:WSEgment:SEquence:APPend	707
[:SOURce<hw>]:BB:ARBitrary:WSEgment:SEquence:SElect	706
[:SOURce<hw>]:BB:ARBitrary:WSEgment?	705
[:SOURce<hw>]:BB:ARBitrary[:TRIGger]:SEquence	724
[:SOURce<hw>]:BB:CFACtor?	662
[:SOURce<hw>]:BB:DM:APSK16:GAMMa	673
[:SOURce<hw>]:BB:DM:APSK32:GAMMa	673
[:SOURce<hw>]:BB:DM:AQPSk:ANGLE	671
[:SOURce<hw>]:BB:DM:ASK:DEPTh	672
[:SOURce<hw>]:BB:DM:CLISt:CATalog?	682
[:SOURce<hw>]:BB:DM:CLISt:COPI	685
[:SOURce<hw>]:BB:DM:CLISt:DATA	685
[:SOURce<hw>]:BB:DM:CLISt:DELeTe	683
[:SOURce<hw>]:BB:DM:CLISt:FREE?	683
[:SOURce<hw>]:BB:DM:CLISt:POINts?	684
[:SOURce<hw>]:BB:DM:CLISt:SElect	682
[:SOURce<hw>]:BB:DM:CLISt:TAG?	687
[:SOURce<hw>]:BB:DM:CLOCk:SOURce	681
[:SOURce<hw>]:BB:DM:CODing	671
[:SOURce<hw>]:BB:DM:DLISt:CATalog?	682
[:SOURce<hw>]:BB:DM:DLISt:COPI	685
[:SOURce<hw>]:BB:DM:DLISt:DATA	686
[:SOURce<hw>]:BB:DM:DLISt:DATA:APPend	687
[:SOURce<hw>]:BB:DM:DLISt:DELeTe	683
[:SOURce<hw>]:BB:DM:DLISt:FREE?	684
[:SOURce<hw>]:BB:DM:DLISt:POINts	684
[:SOURce<hw>]:BB:DM:DLISt:SElect	682
[:SOURce<hw>]:BB:DM:DLISt:TAG?	687
[:SOURce<hw>]:BB:DM:FILTer:PARAmeter:APCO25	669
[:SOURce<hw>]:BB:DM:FILTer:PARAmeter:APCO25Lsm:GAUSSs	669
[:SOURce<hw>]:BB:DM:FILTer:PARAmeter:APCO25Lsm:LOWPass	669
[:SOURce<hw>]:BB:DM:FILTer:PARAmeter:COSSine:BANDwidth	669
[:SOURce<hw>]:BB:DM:FILTer:PARAmeter:COSSine[:ROLLoff]	669
[:SOURce<hw>]:BB:DM:FILTer:PARAmeter:GAUSSs	669
[:SOURce<hw>]:BB:DM:FILTer:PARAmeter:LPASSs	669
[:SOURce<hw>]:BB:DM:FILTer:PARAmeter:LPASSEVM	669
[:SOURce<hw>]:BB:DM:FILTer:PARAmeter:PGAuss	669
[:SOURce<hw>]:BB:DM:FILTer:PARAmeter:RCOSSine	669
[:SOURce<hw>]:BB:DM:FILTer:PARAmeter:SPHase	669
[:SOURce<hw>]:BB:DM:FILTer:TYPE	669
[:SOURce<hw>]:BB:DM:FLISt:CATalog?	682
[:SOURce<hw>]:BB:DM:FLISt:DELeTe	683

[:SOURce<hw>]:BB:DM:FLISt:FREE?.....	683
[:SOURce<hw>]:BB:DM:FLISt:POINts?.....	685
[:SOURce<hw>]:BB:DM:FLISt:SELEct.....	682
[:SOURce<hw>]:BB:DM:FORMat.....	671
[:SOURce<hw>]:BB:DM:FSK:DEViation.....	672
[:SOURce<hw>]:BB:DM:FSK:VARiable:SYMBOL<ch0>:DEViation.....	672
[:SOURce<hw>]:BB:DM:FSK:VARiable:TYPE.....	673
[:SOURce<hw>]:BB:DM:MLISt:CATalog?.....	682
[:SOURce<hw>]:BB:DM:MLISt:DELEte.....	683
[:SOURce<hw>]:BB:DM:MLISt:FREE?.....	684
[:SOURce<hw>]:BB:DM:MLISt:POINts?.....	685
[:SOURce<hw>]:BB:DM:MLISt:SELEct.....	682
[:SOURce<hw>]:BB:DM:PATTern.....	667
[:SOURce<hw>]:BB:DM:PRAMp:ATTenuation.....	675
[:SOURce<hw>]:BB:DM:PRAMp:BBONly[:STATe].....	675
[:SOURce<hw>]:BB:DM:PRAMp:FDELay.....	675
[:SOURce<hw>]:BB:DM:PRAMp:RDELay.....	675
[:SOURce<hw>]:BB:DM:PRAMp:SHAPE.....	674
[:SOURce<hw>]:BB:DM:PRAMp:SOURce.....	674
[:SOURce<hw>]:BB:DM:PRAMp:TIME.....	674
[:SOURce<hw>]:BB:DM:PRAMp[:STATe].....	676
[:SOURce<hw>]:BB:DM:PRBS[:LENGth].....	667
[:SOURce<hw>]:BB:DM:PRESet.....	666
[:SOURce<hw>]:BB:DM:SETTing:CATalog?.....	667
[:SOURce<hw>]:BB:DM:SETTing:DELEte.....	668
[:SOURce<hw>]:BB:DM:SETTing:LOAD.....	668
[:SOURce<hw>]:BB:DM:SETTing:STORE.....	668
[:SOURce<hw>]:BB:DM:SOURce.....	666
[:SOURce<hw>]:BB:DM:SRATE.....	666
[:SOURce<hw>]:BB:DM:STANdard.....	666
[:SOURce<hw>]:BB:DM:STANdard:ULISt:CATalog?.....	667
[:SOURce<hw>]:BB:DM:STANdard:ULISt:DELEte.....	668
[:SOURce<hw>]:BB:DM:STANdard:ULISt:LOAD.....	668
[:SOURce<hw>]:BB:DM:STANdard:ULISt:STORE.....	668
[:SOURce<hw>]:BB:DM:STATe.....	665
[:SOURce<hw>]:BB:DM:SWITChing:STATe.....	674
[:SOURce<hw>]:BB:DM:TRIGger:ARM:EXECute.....	677
[:SOURce<hw>]:BB:DM:TRIGger:DELay:UNIT.....	678
[:SOURce<hw>]:BB:DM:TRIGger:EXECute.....	677
[:SOURce<hw>]:BB:DM:TRIGger:EXTernal:SYNChronize:OUTPut.....	677
[:SOURce<hw>]:BB:DM:TRIGger:OUTPut<ch>:DELay.....	681
[:SOURce<hw>]:BB:DM:TRIGger:OUTPut<ch>:MODE.....	679
[:SOURce<hw>]:BB:DM:TRIGger:OUTPut<ch>:OFFTime.....	680
[:SOURce<hw>]:BB:DM:TRIGger:OUTPut<ch>:ONTime.....	680
[:SOURce<hw>]:BB:DM:TRIGger:OUTPut<ch>:PATTern.....	680
[:SOURce<hw>]:BB:DM:TRIGger:OUTPut<ch>:PULSe:DIVider.....	680
[:SOURce<hw>]:BB:DM:TRIGger:OUTPut<ch>:PULSe:FREQUency?.....	681
[:SOURce<hw>]:BB:DM:TRIGger:RMODE?.....	677
[:SOURce<hw>]:BB:DM:TRIGger:SENGth.....	676
[:SOURce<hw>]:BB:DM:TRIGger:SOURce.....	676

[:SOURce<hw>]:BB:DM:TRIGger[:EXternal]:DELay.....	678
[:SOURce<hw>]:BB:DM:TRIGger[:EXternal]:INHibit.....	679
[:SOURce<hw>]:BB:DM:TRIGger[:EXternal]:RDELay?.....	679
[:SOURce<hw>]:BB:DM:TRIGger[:EXternal]:TDELay.....	678
[:SOURce<hw>]:BB:DM[:TRIGger]:SEQuence.....	676
[:SOURce<hw>]:BB:FOFFset.....	660
[:SOURce<hw>]:BB:GENeral:AM:DEPTH.....	733
[:SOURce<hw>]:BB:GENeral:AM:FREQuency.....	733
[:SOURce<hw>]:BB:GENeral:AM:PERiod.....	733
[:SOURce<hw>]:BB:GENeral:AM:SHAPE.....	734
[:SOURce<hw>]:BB:GENeral:AM[:STATe].....	734
[:SOURce<hw>]:BB:GENeral:FM:DEVIation.....	731
[:SOURce<hw>]:BB:GENeral:FM:FREQuency.....	732
[:SOURce<hw>]:BB:GENeral:FM:PERiod.....	732
[:SOURce<hw>]:BB:GENeral:FM:SHAPE.....	732
[:SOURce<hw>]:BB:GENeral:FM[:STATe].....	732
[:SOURce<hw>]:BB:GENeral:PM:DEVIation.....	734
[:SOURce<hw>]:BB:GENeral:PM:FREQuency.....	735
[:SOURce<hw>]:BB:GENeral:PM:PERiod.....	735
[:SOURce<hw>]:BB:GENeral:PM:SHAPE.....	735
[:SOURce<hw>]:BB:GENeral:PM[:STATe].....	735
[:SOURce<hw>]:BB:GENeral:PULM:DOUBle:DELay.....	736
[:SOURce<hw>]:BB:GENeral:PULM:DOUBle:WIDTh.....	736
[:SOURce<hw>]:BB:GENeral:PULM:MODE.....	736
[:SOURce<hw>]:BB:GENeral:PULM:PERiod.....	737
[:SOURce<hw>]:BB:GENeral:PULM:TRANSition:TYPE.....	737
[:SOURce<hw>]:BB:GENeral:PULM:VIDeo:POLarity.....	737
[:SOURce<hw>]:BB:GENeral:PULM:WIDTh.....	737
[:SOURce<hw>]:BB:GENeral:PULM[:STATe].....	738
[:SOURce<hw>]:BB:GRAPhics:MODE.....	748
[:SOURce<hw>]:BB:GRAPhics:SRATe:MODE.....	748
[:SOURce<hw>]:BB:GRAPhics:SRATe:USER.....	749
[:SOURce<hw>]:BB:GRAPhics:TRIGger:SOURce.....	750
[:SOURce<hw>]:BB:IMPairment:IQRatio[:MAGNitude].....	746
[:SOURce<hw>]:BB:IMPairment:LEAKage:I.....	746
[:SOURce<hw>]:BB:IMPairment:LEAKage:Q.....	746
[:SOURce<hw>]:BB:IMPairment:OPTimization:MODE.....	747
[:SOURce<hw>]:BB:IMPairment:QUADrature[:ANGLE].....	747
[:SOURce<hw>]:BB:IMPairment:STATe.....	747
[:SOURce<hw>]:BB:POFFset.....	661
[:SOURce<hw>]:BB:POWer:PEAK?.....	662
[:SOURce<hw>]:BB:POWer:RMS?.....	662
[:SOURce<hw>]:BB:PROGress:MCODer:ARBITrary:MCARrier?.....	751
[:SOURce<hw>]:BB:PROGress:MCODer:ARBITrary:WSEgment?.....	751
[:SOURce<hw>]:BB:PROGress:MCODer?.....	751
[:SOURce<hw>]:BB:ROUte.....	661
[:SOURce<hw>]:BBIN:ALEVel:EXECute.....	659
[:SOURce<hw>]:BBIN:CDEvice?.....	655
[:SOURce<hw>]:BBIN:CHANnel<ch0>:BB:STATe.....	655
[:SOURce<hw>]:BBIN:CHANnel<ch0>:NAME.....	655

[[:SOURce<hw>]:BBIN:CHANnel<ch0>:POWer:CFACtor.....	656
[[:SOURce<hw>]:BBIN:CHANnel<ch0>:POWer:PEAK.....	656
[[:SOURce<hw>]:BBIN:CHANnel<ch0>:POWer:RMS.....	656
[[:SOURce<hw>]:BBIN:CHANnel<ch0>:SRATe.....	656
[[:SOURce<hw>]:BBIN:DIGital:ASETting:STATe.....	658
[[:SOURce<hw>]:BBIN:DIGital:INTerface.....	654
[[:SOURce<hw>]:BBIN:FOFFset.....	660
[[:SOURce<hw>]:BBIN:MODE.....	657
[[:SOURce<hw>]:BBIN:MPERiod.....	658
[[:SOURce<hw>]:BBIN:POFFset.....	661
[[:SOURce<hw>]:BBIN:POWer:CFACtor.....	659
[[:SOURce<hw>]:BBIN:POWer:PEAK.....	659
[[:SOURce<hw>]:BBIN:POWer:RMS?.....	660
[[:SOURce<hw>]:BBIN:ROUte.....	661
[[:SOURce<hw>]:BBIN:SRATe:MAX?.....	658
[[:SOURce<hw>]:BBIN:SRATe:SOURce.....	657
[[:SOURce<hw>]:BBIN:SRATe:SUM?.....	657
[[:SOURce<hw>]:BBIN:SRATe[:ACTual]?.....	658
[[:SOURce<hw>]:BBIN:STATe.....	654
[[:SOURce<hw>]:CORRection:CSET:DATA:FREQUency.....	754
[[:SOURce<hw>]:CORRection:CSET:DATA:FREQUency:POINts?.....	755
[[:SOURce<hw>]:CORRection:CSET:DATA:POWer.....	754
[[:SOURce<hw>]:CORRection:CSET:DATA:POWer:POINts?.....	755
[[:SOURce<hw>]:CORRection:CSET:DATA[:SENSor<ch>][:POWer]:SONCe.....	755
[[:SOURce<hw>]:CORRection:CSET:DATA[:SENSor<ch>][:POWer]:SONCe.....	756
[[:SOURce<hw>]:CORRection:CSET[:SELEct].....	755
[[:SOURce<hw>]:CORRection:DEXChange:AFILe:CATalog?.....	757
[[:SOURce<hw>]:CORRection:DEXChange:AFILe:EXTension.....	757
[[:SOURce<hw>]:CORRection:DEXChange:AFILe:SELEct.....	758
[[:SOURce<hw>]:CORRection:DEXChange:AFILe:SEParator:COLumn.....	758
[[:SOURce<hw>]:CORRection:DEXChange:AFILe:SEParator:DECimal.....	758
[[:SOURce<hw>]:CORRection:DEXChange:EXECute.....	758
[[:SOURce<hw>]:CORRection:DEXChange:MODE.....	759
[[:SOURce<hw>]:CORRection:DEXChange:SELEct.....	759
[[:SOURce<hw>]:CORRection:VALue?.....	755
[[:SOURce<hw>]:CORRection:ZERoing:STATe.....	756
[[:SOURce<hw>]:CORRection[:STATe].....	756
[[:SOURce<hw>]:DM:FILTer:PARAmeter.....	670
[[:SOURce<hw>]:FREQUency:CENTer.....	763
[[:SOURce<hw>]:FREQUency:MANual.....	762
[[:SOURce<hw>]:FREQUency:MODE.....	760
[[:SOURce<hw>]:FREQUency:MUlTiplier.....	762
[[:SOURce<hw>]:FREQUency:OFFSet.....	762
[[:SOURce<hw>]:FREQUency:SPAN.....	763
[[:SOURce<hw>]:FREQUency:STARt.....	763
[[:SOURce<hw>]:FREQUency:STEP:MODE.....	764
[[:SOURce<hw>]:FREQUency:STEP[:INCRement].....	765
[[:SOURce<hw>]:FREQUency:STOP.....	764
[[:SOURce<hw>]:FREQUency[:CW FIXed].....	760
[[:SOURce<hw>]:FREQUency[:CW FIXed]:RCL.....	761

[:SOURce<hw>]:IQ:OUTPut:DIGital:CDEvice?	768
[:SOURce<hw>]:IQ:OUTPut:DIGital:INTErface	767
[:SOURce<hw>]:IQ:OUTPut:DIGital:PON	770
[:SOURce<hw>]:IQ:OUTPut:DIGital:POWer:STEP:MODE	769
[:SOURce<hw>]:IQ:OUTPut:DIGital:POWer:STEP[:INCRement]	769
[:SOURce<hw>]:IQ:OUTPut:DIGital:SRATe	768
[:SOURce<hw>]:IQ:OUTPut:DIGital:STATe	767
[:SOURce<hw>]:IQ:STATe	766
[:SOURce<hw>]:IQ:SWAP[:STATe]	766
[:SOURce<hw>]:LIST:CATalog?	780
[:SOURce<hw>]:LIST:DELete	780
[:SOURce<hw>]:LIST:DELete:ALL	781
[:SOURce<hw>]:LIST:DEXChange:AFILe:CATalog?	782
[:SOURce<hw>]:LIST:DEXChange:AFILe:EXTension	783
[:SOURce<hw>]:LIST:DEXChange:AFILe:SELect	783
[:SOURce<hw>]:LIST:DEXChange:AFILe:SEParator:COLumn	783
[:SOURce<hw>]:LIST:DEXChange:AFILe:SEParator:DECimal	784
[:SOURce<hw>]:LIST:DEXChange:EXECute	783
[:SOURce<hw>]:LIST:DEXChange:MODE	784
[:SOURce<hw>]:LIST:DEXChange:SELect	784
[:SOURce<hw>]:LIST:DWELI	774
[:SOURce<hw>]:LIST:DWELI:LIST	775
[:SOURce<hw>]:LIST:DWELI:LIST:POINts?	775
[:SOURce<hw>]:LIST:DWELI:MODE	775
[:SOURce<hw>]:LIST:FREE?	781
[:SOURce<hw>]:LIST:FREQuency	776
[:SOURce<hw>]:LIST:FREQuency:POINts?	776
[:SOURce<hw>]:LIST:INDEx	776
[:SOURce<hw>]:LIST:INDEx:STARt	777
[:SOURce<hw>]:LIST:INDEx:STOP	777
[:SOURce<hw>]:LIST:LEARn	777
[:SOURce<hw>]:LIST:MODE	778
[:SOURce<hw>]:LIST:POWer	778
[:SOURce<hw>]:LIST:POWer:POINts?	779
[:SOURce<hw>]:LIST:RESEt	782
[:SOURce<hw>]:LIST:RMODE	777
[:SOURce<hw>]:LIST:RUNNing?	780
[:SOURce<hw>]:LIST:SELect	782
[:SOURce<hw>]:LIST:TRIGger:EXECute	779
[:SOURce<hw>]:LIST:TRIGger:SOURce	779
[:SOURce<hw>]:PHASe	785
[:SOURce<hw>]:PHASe:REFerence	785
[:SOURce<hw>]:POWer:ALC:MODE?	787
[:SOURce<hw>]:POWer:ALC:SONCe	787
[:SOURce<hw>]:POWer:ATTenuation:RFOff:MODE	787
[:SOURce<hw>]:POWer:EMF:STATe	788
[:SOURce<hw>]:POWer:LBEHaviour	788
[:SOURce<hw>]:POWer:LIMit[:AMPLitude]	788
[:SOURce<hw>]:POWer:MANual	788
[:SOURce<hw>]:POWer:MODE	789

[[:SOURce<hw>]:POWer:PEP?.....	789
[[:SOURce<hw>]:POWer:POWer.....	790
[[:SOURce<hw>]:POWer:RANGe:LOWer?.....	796
[[:SOURce<hw>]:POWer:RANGe:UPPer?.....	796
[[:SOURce<hw>]:POWer:SPC:CRANGe.....	791
[[:SOURce<hw>]:POWer:SPC:DELay.....	791
[[:SOURce<hw>]:POWer:SPC:MEASure.....	791
[[:SOURce<hw>]:POWer:SPC:MODE.....	791
[[:SOURce<hw>]:POWer:SPC:PEAK.....	792
[[:SOURce<hw>]:POWer:SPC:SELect.....	792
[[:SOURce<hw>]:POWer:SPC:SINGle.....	792
[[:SOURce<hw>]:POWer:SPC:STATe.....	792
[[:SOURce<hw>]:POWer:SPC:TARGet.....	793
[[:SOURce<hw>]:POWer:STARt.....	790
[[:SOURce<hw>]:POWer:STEP:MODE.....	793
[[:SOURce<hw>]:POWer:STEP[:INCRement].....	793
[[:SOURce<hw>]:POWer:STOP.....	790
[[:SOURce<hw>]:POWer[:LEVel][:IMMediate]:OFFSet.....	794
[[:SOURce<hw>]:POWer[:LEVel][:IMMediate]:RCL.....	794
[[:SOURce<hw>]:POWer[:LEVel][:IMMediate]:REFLevel.....	795
[[:SOURce<hw>]:POWer[:LEVel][:IMMediate][:AMPLitude].....	795
[[:SOURce<hw>]:SWEep:POWer:DWELL.....	803
[[:SOURce<hw>]:SWEep:POWer:EXECute.....	806
[[:SOURce<hw>]:SWEep:POWer:MODE.....	803
[[:SOURce<hw>]:SWEep:POWer:POINts.....	803
[[:SOURce<hw>]:SWEep:POWer:RETRace.....	807
[[:SOURce<hw>]:SWEep:POWer:RUNNing?.....	807
[[:SOURce<hw>]:SWEep:POWer:SHApe.....	806
[[:SOURce<hw>]:SWEep:POWer:SPACing:MODE?.....	804
[[:SOURce<hw>]:SWEep:POWer:STEP[:LOGarithmic].....	804
[[:SOURce<hw>]:SWEep:RESet[:ALL].....	808
[[:SOURce<hw>]:SWEep[:FREQUency]:DWELL.....	804
[[:SOURce<hw>]:SWEep[:FREQUency]:EXECute.....	806
[[:SOURce<hw>]:SWEep[:FREQUency]:MODE.....	805
[[:SOURce<hw>]:SWEep[:FREQUency]:POINts.....	805
[[:SOURce<hw>]:SWEep[:FREQUency]:RETRace.....	807
[[:SOURce<hw>]:SWEep[:FREQUency]:RUNNing?.....	807
[[:SOURce<hw>]:SWEep[:FREQUency]:SHApe.....	806
[[:SOURce<hw>]:SWEep[:FREQUency]:SPACing.....	805
[[:SOURce<hw>]:SWEep[:FREQUency]:STEP:LOGarithmic.....	807
[[:SOURce<hw>]:SWEep[:FREQUency]:STEP[:LINear].....	807
{[TRACE] LIST [#]: Pos0:State0; Pos1:State1; ...PosN-1:StateN-1}.....	181
{[TRACE] LIST [#]: Pos0:State0; Pos1:State1; ...PosN-1:StateN-1}.....	189
{BURST LIST [#]: Pos0:State0; Pos1:State1; ...PosN-1:StateN-1}.....	181
{BURST LIST [#]: Pos0:State0; Pos1:State1; ...PosN-1:StateN-1}.....	189
{CLOCK: frequency}.....	177
{COMMENT: string}.....	175
{CONTROL LENGTH: ControlLength}.....	177
{CONTROL LENGTH: ControlLength}.....	188
{CONTROL LIST WIDTH4–Length: #m0m1...mx...mM-1}.....	186

{COPYRIGHT: string}.....	175
{CW MODE LIST [#]: Pos0:State0; Pos1:State1; ...PosN-1:StateN-1}.....	181
{CW MODE LIST [#]: Pos0:State0; Pos1:State1; ...PosN-1:StateN-1}.....	189
{DATA BITLENGTH: BitLength}.....	187
{DATA LIST-Length: #d0d1...dx...dN-1...}.....	188
{DATE: yyyy-mm-dd;hh:mm:ss}.....	176
{EMPTYTAG-Length: #EmptySequence}.....	178
{HOP LIST [#]: Pos0:State0; Pos1:State1; ...PosN-1:StateN-1}.....	181
{HOP LIST [#]: Pos0:State0; Pos1:State1; ...PosN-1:StateN-1}.....	189
{LEVATT LIST [#]: Pos0:State0; Pos1:State1; ...PosN-1:StateN-1}.....	181
{LEVATT LIST [#]: Pos0:State0; Pos1:State1; ...PosN-1:StateN-1}.....	189
{LEVEL OFFS: RMSOffset_dB,PeakOffset_dB}.....	179
{MAP LIST [#]: Pos0:State0; Pos1:State1; ...PosN-1:StateN-1}.....	181
{MAP LIST [#]: Pos0:State0; Pos1:State1; ...PosN-1:StateN-1}.....	189
{MARKER LIST [#]: Pos0:State0; Pos1:State1; ...PosN-1:StateN-1}.....	181
{MARKER LIST [#]: Pos0:State0; Pos1:State1; ...PosN-1:StateN-1}.....	189
{MARKER MODE [#]: GENERATOR}.....	180
{MWV_SEGMENT_CLOCK_MODE: Mode}.....	184
{MWV_SEGMENT_CLOCK: ClockSeg0, ClockSeg1, ..., ClockSegN-1}.....	184
{MWV_SEGMENT_COUNT: NumOfSeg}.....	183
{MWV_SEGMENT_DURATION: SegDur0, SegDur1, ..., SegDurN-1}.....	183
{MWV_SEGMENT_FILES: "FileNameSeg0.wv", "FileNameSeg1.wv", ..., "FileNameSegN-1.wv"}.....	186
{MWV_SEGMENT_LENGTH: SamplesSeg0, SamplesSeg1, ..., SamplesSegN-1}.....	183
{MWV_SEGMENT_LEVEL_MODE: Mode}.....	185
{MWV_SEGMENT_LEVEL_OFFS:	
RMSOffs_dBSg0,PeakOffs_dBSg0, ..., RMSOffs_dBSgN-1, PeakOffs_dBSgN-1}.....	185
{MWV_SEGMENT_SETTINGS_FILE: SegSettingFilePath}.....	186
{MWV_SEGMENT_START:	
SampleStartOffsetSeg0, SampleStartOffsetSeg1, ..., SampleStartOffsetSegN-1}.....	184
{MWV_SEGMENTx_COMMENT: text}.....	186
{SAMPLES: Samples}.....	180
{TYPE: magic, xxxxxxxx}.....	174
{WAVEFORM-Length: #I0Q0I1Q1...IxQx...IN-1QN-1...}.....	182
*CLS.....	576
*ESE.....	576
*ESR?.....	576
*IDN?.....	576
*IST?.....	577
*OPC.....	577
*OPT?.....	577
*PRE.....	577
*PSC.....	577
*RCL.....	578
*RST.....	578
*SAV.....	578
*SRE.....	579
*STB?.....	579
*TRG.....	579
*TST?.....	579
*WAI.....	579

DIAGnostic:HUMS:DELeTe:ALL.....	599
DIAGnostic:HUMS:DEViCe:HISTory:DELeTe:ALL.....	600
DIAGnostic:HUMS:DEViCe:HISTory?.....	599
DIAGnostic:HUMS:FORMat.....	600
DIAGnostic:HUMS:SAVE.....	601
DIAGnostic:HUMS:STATe.....	601
DIAGnostic:HUMS:TAgS:ALL?.....	601
DIAGnostic:HUMS:TAgS:DELeTe.....	602
DIAGnostic:HUMS:TAgS:DELeTe:ALL.....	602
DIAGnostic:HUMS:TAgS[:VALue].....	602
SYSTem:COMMunicate:REST:ENABle.....	603
SYSTem:COMMunicate:SNMP:COMMunity:RO.....	603
SYSTem:COMMunicate:SNMP:COMMunity:RW.....	603
SYSTem:COMMunicate:SNMP:CONtAct.....	604
SYSTem:COMMunicate:SNMP:LOCation.....	604
SYSTem:COMMunicate:SNMP:USM:USER.....	604
SYSTem:COMMunicate:SNMP:USM:USER:ALL?.....	605
SYSTem:COMMunicate:SNMP:USM:USER:DELeTe.....	605
SYSTem:COMMunicate:SNMP:USM:USER:DELeTe:ALL.....	605
SYSTem:COMMunicate:SNMP:VERSiOn.....	605

Index

Symbols

/var/user directory	581
/var/volatile directory	581
>L	555
&LLO	555
&NREN	555
50 - Extern reference out of range or disconnected	842
140 - This modulation forces other modulations off	842
180 - Adjustment failed	842
182 - Adjustment data missing	842
183 - Adjustment data invalid	842
200 - Cannot access hardware	842
201 - Hardware revision out of date	842
202 - Cannot access the EEPROM	842
203 - Invalid EEPROM data	842
204 - river initialization failed	842
241 - No current list	842
242 - Unknown list type specified	842
300 - Over-temperature protection shut-down	843
300 - Overload (Reverse Power) detected	842
300 - Reference PLL unlocked	842
460 - Cannot open the file	843
461 - Cannot write file	843
462 - Cannot read file	843
463 - Filename missing	843
464 - Invalid filename extension	843
465 - File contains invalid data	843

A

About	
Attenuator	353
Power-On/EMF	447
Reference oscillator	312
UCOR	355, 356
Accept	
Security settings	491
Access configuration menu	
Graphics	405
Accidental trigger	
Avoiding	91
Accurate level measurement	
Measurement period	252
Active connections	
Remote access	523
Active elements	68
Add LAN sensor	
NRP sensor mapping	382
Add sensor	
NRP sensor mapping	382
Add USBTMC sensor	
NRP sensor mapping	382
Add, change, delete	
User key action	465
Additive noise	286
Adjust	
BB input signal	272
Display and keyboard	445
Display settings	444
Keyboard settings	444
Adjustment frequency	
Reference oscillator	316

Adjustments	
All	861
All delayed	863
Continue	862
Delay settings	862
Information	862
Last full adjustment	861
Settings	861
Shutdown	863
Warm up time	863
Advanced configuration	
LXI	539
All packages	
Secure update policy	484
Alphanumeric parameters	72
AM	80
AM settings	241
AM depth	242
Modulation frequency	242
Modulation period	242
Modulation shape	242
State	242
Angle alpha	
AQPSK	113
Annotation	
Disable amplitude display	486
Disable frequency display	486
Disable level	486
Aperture time	
Power sensors	379
Append	
Blank segment	201
Sequencing play list	208
Waveform	200, 201
Application	
External digital signal	250
Application cards	23
Application notes	23
Apply	
Assistant settings	234
External digital signal	250
Settings of external RF and I/Q instrument	264
Apply and connect	
Settings of external RF and I/Q instrument	264
APSK	
Code rate	114
Gamma	114
ARB	62
Play list	191
Sequencer mode	191
Subsystem	687
ARB multi-carrier	
Conflict	232
Mode	225
ARB sequencer mode	192, 204
ARbitrary waveform generator	137
Arm trigger	
DM	102
Armed_Auto	
Common settings	101
Armed_Retrigger	
Common settings	101
ASK depth	113

- ATSC 3.0 77
 - ATSC-M/H 77
 - Attenuation 118
 - Attenuator
 - About 353
 - RF signal 353
 - Settings 354
 - Attenuator settings
 - Level range 354
 - Mode 354
 - RF OFF mode 354
 - Auto
 - Common settings 101
 - Auto level set 272
 - Auto once
 - Power sensors 379
 - Power viewer 379
 - Automatic level control
 - Readjust internal switch position 310
 - Automation 499
 - Autonegotiation
 - Failed 845
 - Avahi
 - LAN services 489
 - Average level
 - Power viewer 377
 - Avoiding signal gaps 195
 - Avoiding wrap-around 195
 - AWGN
 - Additive white Gaussian noise 280
 - Subsystem 738
 - AWGN mode 286
 - AWGN test signal 140
- B**
- B x T
 - DM 115
 - Bandwidth
 - Cosine filter 116
 - Bandwidth coupling 286
 - Baseband
 - Channel 271
 - Input 62
 - Output 62
 - Baseband generator 62
 - Baseband input
 - see BB input 267
 - Baseband only
 - Mandatory setting 118
 - Baseband signal
 - Shifting quickly in RF domain 248
 - Basic phase modulation
 - Modulation frequency 240
 - Modulation period 241
 - Modulation shape 241
 - State 240
 - Φ deviation 241
 - Basic workflow
 - Multi-segment waveform 212
 - Basics
 - Editor 350, 362
 - Export list files 365
 - Fill with sensor list files 364
 - Import list files 365
 - BB input 62
 - BB output 62
 - BBIN 267
 - Bench top, placing 25
 - Binary data
 - Edit, rules 167
 - Bit energy to noise power density 289
 - Bit rate 288
 - Block diagram
 - Display 66
 - Blue LED
 - State indication (active) 273
 - Broadcast standard
 - Supported 77
 - Brochures 22
 - Browser settings
 - LXI 537
 - Burst gate 83
 - Bytes order
 - Definition 611
- C**
- C-List
 - See control list 120, 124, 164
 - Calibrate RF output level with power sensor 383
 - CALibration subsystem 592
 - Carrier
 - Delay 231
 - Frequency 231
 - Gain 231
 - Index 231
 - State 231
 - State start/stop 233
 - Carrier + Interferer
 - PEP 291
 - Carrier + Noise
 - PEP 291
 - Carrier graph 234
 - Carrier leakage 295
 - Carrier impairments 297
 - Carrier power 289
 - Carrier spacing 226
 - Carrier/Noise ratio 289
 - Carrying the instrument 24
 - Catch range
 - NRP power control 374
 - CCDF diagram 398
 - CCDF display 398
 - Center frequency
 - Changing without adjusting the RF 248
 - Central storage
 - Accessing 439
 - Change password
 - Setup (security) 493
 - Change user password
 - Setup (security) 493
 - Channel
 - Name 271, 275
 - State 276
 - Stream 275
 - Check front panel
 - Key panel test 859
 - Performing 858
 - Settings 858
 - Check touch panel
 - Touchscreen test 859
 - Checking parameters and dependencies 458
 - Checking the instrument 24

- Clean
 - List of external RF and I/Q instrument 262
- Cleaning 855
- Clear
 - NRP sensor mapping 382
 - RF output protection 355
 - User menu 461
- Clear history
 - Undo/Redo 497
- Clear status
 - Remote 576
- Clipping 226
- CList
 - See control list 124, 164
- Clock
 - Frequency 146
 - Rate 146
- Clock rate
 - Blank segment 201
- Clock rate mode
 - Multi-segment waveform 203
- Clock signal
 - Internal 82
- Clock source 105
 - Internal 82
- Close
 - Show SCPI command 558
- Coding
 - DM 109
- Command sequence
 - Remote 579
- Commands of all settings
 - SCPI list 423
- Comment 199
- Complementary cumulative distribution function 398
- Computer name
 - see hostname 545
- CONDition 510
- Configuration
 - Restoring 425
 - Restoring instrument settings 421
- Configuration list
 - Multi-segment waveform 192
- Configure
 - Control signal 122
- Configuring LAN services 488
- Confirm unsigned
 - Secure update policy 484
- Confirm user password
 - Setup (security) 492, 493
- Conflict 232
- Connect
 - External RF and I/Q instrument 264
- Connect all remote 257
- Connect remote instruments
 - Keep connection on preset 258
 - On start-up 257
- Connected device 270, 274
- Connecting
 - Keyboard 29
 - LAN 27
 - Memory stick 29
 - Monitor 28
 - Mouse 29
 - Power 27
 - To Dig. IQ HS x 31
 - To IP Data 32
 - To Ref In/Ref Out 31
 - To RF 31
 - To RF coaxial connectors 29
 - USB devices 29
- Connecting to RF coaxial connectors
 - To connect to pluggable connectors 30
 - To connect to screwable connectors 30
 - To prepare for connecting 30
- Connection fault
 - 169.254.*.* 845
- Connector
 - AC power supply 40
 - Direction 456
 - Display Port 40
 - Find 266
 - Global 450, 456
 - High-speed digital IQ 41
 - Identify 266
 - IP data 41
 - LAN 40
 - Mapping 449
 - Ref In 42
 - Ref Out 42
 - RF 50 Ω 39
 - Shared 450
 - Show 266
 - Signal 456
 - USB 39, 41
 - User 450, 456
 - USER 41
- Connector direction
 - Settings 258
- Connector local, global
 - Signal, how to define 457
- Constant I/Q test signal 140
 - Settings 150
- Constellation diagram 396
- Context-sensitive menu 68
- Continue
 - Internal adjustments 862
- Continue on error
 - Failed internal adjustments 846
- Control list
 - ASCII format 124, 164
 - Binary format 165
 - Edit, rules 167
 - How to assign 125, 166
 - Manually (Control data editor) 124
 - Select 111
 - Tags 164
- Control signal 82
- Copy
 - Instrument settings 430
 - Several files 428, 436, 437
 - Show SCPI command 558
- Counter 848
- Create 199, 229
 - Multi-carrier waveforms 220
 - New directory 430
- Create and load 199, 229
- Crest factor
 - Channel 271
 - Match 251
 - Where to find the value 252
- Crest factor mode 226
- Current frequency
 - Sweep 334

- Current index
 - List mode 342
- Current level
 - Sweep 334
- Current segment 209
- Custom digital modulation 62
- Customer support 852
- Cut
 - Instrument settings 430
- Cut off frequency factor 115
- CW
 - Frequency 306
- CW (continuous wave) 82
- CW frequency 287, 292
- CW interferer 286
- CW mode
 - Output level 309
- CW signal
 - Generate in baseband 109
 - Settings 304
- CW/Mod 83
- D**
- D-List
 - See data list 166
- DAB 78
- DARC 80
- Data entry 71
- Data format
 - Definition 612
- Data list 110
 - Access 426
 - Binary format 167
 - Edit, rules 167
 - Editor 118
 - How to access 583
 - How to assign 126, 167
 - How to create 125
 - Manually (data list editor) 126
 - Select 111
 - Select, edit, new 427
 - Standard modulation data source 81
 - Tags 166
- Data sheets 22
- Data source
 - Data list 81
 - DM 110
 - Extern serial data 110
 - Pattern 81
 - PRBS generator 81
- Date 857
- DC carrier leakage
 - Eliminating 248
 - How to shift baseband signal 248
- Deactivate RF output 314
- Deactivated licenses 469
- Declassification 486
- Default directory
 - Mass memory 581
 - User data 414, 582
- Default settings 224
 - ARB 145
 - DM 108
- Default values
 - Remote 578
- Define
 - User key action 465
- Delay
 - Falling edge of ramp envelope 118
 - Marker 105
 - Rising edge of ramp envelope 117
 - Trigger 103
- Delay start 234
- Delay step 234
- Delay time
 - NRP power control 375
- Delete
 - Instrument settings 430
 - List mode file 345
 - Sequencing list 208
 - Waveform 200, 201
- Delete instrument settings 589
- Delta frequency
 - External RF and I/Q instrument 260
- Delta phase
 - RF frequency 311
- Detect
 - External RF and I/Q instrument 262
- Deviation
 - FSK modulation 113
 - Variable FSK 114
- Device ID 468, 830
 - NRP sensor mapping 382
- Device reset 580
- Device-specific notifications 841
- DHCP 544
- Dialog boxes 70
- Differential coding
 - DM 109
- DIG IQ auto setting 272
- Digital I/Q
 - Input 267
- Digital inputs
 - Connector type 269
- Digital modulation
 - See DM 106
- Digital output
 - State 273
- Digital standard 62
- Direction
 - Connector 258
- Directory
 - Temporary data 581
 - User data 581
- Disable
 - Frequency display 486
 - Level display 486
- Disconnect all remote 257
- Display
 - Active elements 68
 - Block diagram 66
 - Brightness 446
 - Context-sensitive menu 68
 - Info line 68
 - Information 65
 - Keyboard layout 446
 - Lock 487
 - Mapped connectors 257
 - On-screen keypad 68
 - Power sensors 377
 - SCPI list 558
 - Screen saver 446

- Settings 445
- Setup 445
- Status bar 66
- Tab labels 68
- Taskbar 67
- Wait time (screen saver) 446
- Display correction file data
 - UCOR 359
- Display correction value
 - UCOR 359
- Display port
 - Connector 40
- DISPlay subsystem 606
- Display unit 405
- Disposal 855
- Distortion-free range
 - Max bandwidth 142
 - Resampling 142
- DList
 - See data list 166
- DNS server 521
- DNS suffix 520
- Documentation overview 21
- Downgrade information 849
 - Factory version 849
 - Min. version 849
- DRM 79
- DTMB 78
- Duration
 - Measurement period external digital signal 252
- DVB-C 79
- DVB-S 79
- DVB-S2 79
- DVB-S2x 79
- DVB-T 78
- DVB-T2 78
- Dwell time
 - Sweep 337
- Dwell time mode
 - List mode 343
- E**
- Edge form of ramp envelope 117
- Edge slope of ramp envelope 117
- Edit
 - Binary data 167
 - Data list 118
 - Editor 350, 362
 - List mode data 345
 - Ramp in control list 122
 - UCOR data 359
- Editor
 - Basics 350, 362
 - Edit 350, 362
 - Fill with sensor 350, 362
 - Goto 350, 362
 - Save 350, 362
 - Save as 350, 362
- EMF display
 - RF level 447
- Emulating front panel keys 74
- Emulation
 - IDN string 523
 - Language 523
 - Mode 523
 - Set IDN and OPT to default 523
- Enable
 - LAN interface 489
- ENABLE 510
- Enable registers
 - Remote 577
- Enter license key 468
- Enter password
 - Setup (security) 491
- Error log 851
- Error message
 - Missing burst gate marker in waveform file, please disable RF power ramping. 145
 - No or empty waveform file 145
- Error messages 843
 - Adjustment data invalid (183) 842
 - Adjustment data missing (182) 842
 - Adjustment failed (180) 842
 - Cannot access hardware (200) 842
 - Cannot access the EEPROM (202) 842
 - Cannot open file (460) 843
 - Cannot read file (462) 843
 - Cannot write file (461) 843
 - Driver initialization failed (204) 842
 - Extern reference out of range or disconnected (50) .. 842
 - File contains invalid data (465) 843
 - Filename missing (463) 843
 - Hardware revision out of date (201) 842
 - Invalid EEPROM data (203) 842
 - Invalid filename extension (464) 843
 - No current list (241) 842
 - Over-temperature protection shut-down (300) 843
 - Overload (Reverse Power) detected (300) 842
 - Reference PLL unlocked (300) 842
 - SCPI 841
 - See notifications 840
 - This modulation forces other modulations off (140) .. 842
 - Unknown list type specified (242) 842
- Error queue 511
- Error queue query 812, 813
- ESE (event status enable register) 512
- ESR 508
- ESR (event status register) 512
- EVENT 510
- Event status enable register (ESE) 512
 - Remote 576
- Event status register (ESR) 512
 - Remote 576
- Exclude frequency 424
- Exclude level 424
- Execute
 - Next segment 211
 - Single sweep 337
 - Trigger (list mode) 344
- Execute single
 - NRP power control 374
- Expiration date of option 850
- Export
 - Execute 347, 367
 - SCPI 428
 - SCPI export 560
 - SCPI list 559
 - SCPI settings 559
- Export deactivation response 468
- Export license key 469
- Export list files
 - Basics 365

- Express level in
 - Volts 785
- External digital signal
 - Application fields 250
 - Apply 250, 267
 - Baseband input 267
 - Feed to the instrument 250
 - Interface type 269
 - Possible applications 250
 - Required if 250
- External frequency
 - Reference oscillator 314
- External instrument
 - Settings 258, 260
- External RF and I/Q
 - Alias name 263
 - Settings 255
- External trigger
 - Common source 278
 - Configuring 278
 - Providing the instrument with 278
- External Trigger Delay
 - DM 103
- Eye diagram 397
- F**
- Factory
 - Preset 418
- Factory version
 - Firmware 849
- Fall delay 118
- Feedback
 - Connector 456
 - Signal 456
- Feeding
 - External digital signal 250, 267
- File
 - Multi-carrier table 232
 - SCPI export 560
 - Waveform 145
- File catalog
 - List mode 345
- File contents
 - Multi-segment waveform 200
- File handling 415
- File list 586
- File manager 428
- File name 441
- File select
 - Dialog 426
- File server
 - Data exchange 439
- File sharing 434
- File storage location 581
- File system 413
 - Accessing 434
- File transfer 415
 - From file server 439
 - FTP/SAMBA 499
 - How to 434
- File type selection 430
- Files
 - User data 413
- Fill
 - User correction data 350, 362
- Fill table
 - Automatically 350, 362
 - UCOR 359
- Fill with sensor
 - Basics 364
 - Editor 350, 362
- Filter
 - DM 115
 - Power sensors 378
- Filter cut off frequency 226
- Filter length
 - Auto 379
 - User-defiend 379
- Filter parameter
 - B x T 115
 - Cut off frequency factor 115
 - Impact 96
 - Roll off factor 115
- Finding out the default directory 414, 582
- Firmware
 - Factory version 849
 - Min. version 849
 - Version 849
- Firmware options
 - see software options 62
- Fixed
 - Frequency 306
- Flexible dynamic switch over 213, 214
 - Without signal interruptions 214
- Floating
 - License server 470
- Floating licenses 850
- FM 80
- FM settings 238
 - FM deviation 240
 - Modulation frequency 239
 - Modulation period 239
 - Modulation shape 239
 - State 239
- FM/PhiM/AM settings 238
- Format
 - SCPI Export 560
- FORMat subsystem 611
- FPGA/μC
 - Check for updates 869
 - Check for updates of external 870
 - Update installation internal assembly 869
 - Update table 869
- Frequency
 - Annotation disable 486
 - CW, fixed 306
 - Multiplier 307
 - Offset 307
 - Power sensors 378
 - RF signal 306
 - Test signal ARB 148
 - UCOR 359
- Frequency offset
 - Between the I/Q streams 255
 - External signal 247
 - Internal signal 247
- Front panel
 - Checking 858
 - Connectors 39
 - Overview 35
- Front panel test
 - Performing 858

- FSK deviation 113
- FSK type
 - Variable FSK 114
- FTP
 - How to access the instrument 434
 - LAN services 489
- Function keys
 - Overview 38
- G**
- Gain
 - Impairment 294
- Gain imbalance 294
- Gain start 233
- Gain step 233
- Gateway 520
- General configuration of instrument 444
- General instrument functions
 - User key 460
 - User menu 460
- General instrument settings 444
 - Checking parameters and dependencies 458
- General workflow
 - Multi-segment waveform 212
- Generate test signal
 - HD 148, 150, 151
 - RAM 148, 150, 151
- Generating an unmodulated signal 304
- Generating short sequences 91
- Getting started 21
- Global dwell time
 - List mode 343
- Goto
 - Editor 350, 362
- Graphical signal monitoring 394
- Graphics
 - Number of samples 403
- Grey LED
 - State indication (inactive) 273
- GUI
 - Setting 448
- GUI update
 - Setup 444
- H**
- Hard copy
 - Create, how to 443
 - File format 441, 442
 - Print, how to 443
- Hardcopy 440
 - Options 441
- Hardware channel
 - External RF and I/Q 263
- Head panel
 - See Status bar 37
- Header
 - See Status bar 37
- Help 22, 72
- High-speed switch over
 - How to 215
- HiSlip
 - Visa resource string 521
- HiSLIP
 - Resource string 502
- History
 - Undo/Redo 497
- Host name
 - NRP sensor mapping 382
 - see hostname 545
- Hostname 519
 - Changing 545
 - External RF and I/Q 263
 - LXI 536
 - Syntax 545
 - Use instead of IP address 545
- Hotspot 67
- How to
 - Access RF settings 303
 - Activate RF signal output 303
 - Calibrate RF output level with power sensor 383
 - Change the default directory 583
 - Internal adjustments 863
 - Query hardware options 850
 - Query RF assembly 850
 - Resolve adjustments errors 845
 - Run a hardware module selftest 867
 - Run delayed adjustments 864
 - Set RF frequency and level 304
 - Use an complete file path 583
 - Use the hostname instead of IP address 545
 - User key 465
 - User menu 462
- HTTP
 - LAN services 489
- HUMS 525
 - About 516
 - Add device tags 535
 - Delete device tag entry 535
 - Delete device tags 535
 - Delete history 526
 - Device ID 534
 - Device tag key 534
 - Device tag value 534
 - Device tags 533
 - Enhanced settings 526, 527
 - Export history 527
 - Protocol settings 528
 - REST 528
 - SNMP protocol 528
 - SNMPv2 access 529
 - SNMPv2 community 529
 - SNMPv2 configuration 528
 - SNMPv3 user 529
 - State 526
- I**
- I offset 295
- I/Q connection
 - Status 259
- I/Q diagram 395
- I/Q Impairments
 - Linear 294
- I/Q modulation 298
 - Performance optimization 300
- I/Q output digital
 - Settings 272
- I/Q stream mapper
 - Settings 254
- I/Q swap 299

- Identification
 - Emulation mode 523
 - Remote 576
 - Identify
 - Connector 266
 - Identify connector
 - Setting 266
 - IDN string
 - Emulation mode 523
 - Imbalance
 - Impairments 297
 - Impairment
 - Digital 294
 - Linear 294
 - Impairments
 - Digital 296
 - Import
 - Execute 347, 367
 - SCPI 428
 - Import license key 468
 - Import list files
 - Basics 365
 - Import/Export
 - Lists 346
 - Select file 347, 367
 - Inactive licenses 469
 - Index
 - List mode 342
 - Info line 68, 843
 - Information
 - Internal adjustments 862
 - Inhibit trigger 92
 - Input
 - Clock slope 457
 - Impedance Clock/Trigger 457
 - Threshold Clock/Trigger 457
 - Trigger slope 457
 - Input connector 41
 - Input waveform file 234
 - Input/output signals and interfaces
 - Overview 249
 - Installed assembly 847
 - Instrument
 - Carrying 24
 - Checking 24
 - Lifting 24
 - Operating site 24, 25
 - Unpacking 24
 - Instrument configuration
 - External 260
 - Instrument control 64
 - Instrument emulations 516, 522
 - Instrument help 22
 - Instrument name
 - External RF and I/Q instrument 259
 - Instrument security procedures 22
 - Instrument settings
 - Recall 578, 589
 - Save 578, 591
 - Interferer
 - CW, generation 280
 - Interfering signal
 - Use an external digital signal 250
 - Internal
 - Clock reference 82
 - Internal adjustments
 - How to 863
 - Internal adjustment
 - Continue on error 846
 - Internal adjustments 846
 - Abort on error 845
 - Troubleshooting 845
 - Interrupt 514
 - IP address 502
 - Changing 544
 - Dynamic 519
 - External RF and I/Q 263
 - LXI 536
 - Not recognized 845
 - NRP sensor mapping 382
 - Zeroconf 519
 - IP address mode 519
 - IP configuration
 - LXI 539
 - IQ subsystem 765
 - ISDB-T 78
 - IST 508
 - IST flag
 - Remote 577
- ## J
- J.83/B 79
- ## K
- key 444
 - Key
 - ★ (User) 38
 - Access on a remote computer 74
 - Emulation 74
 - Esc 38
 - Freq/Level 38
 - Help 38
 - Home 38
 - On/Standby 37
 - Preset 38
 - RF on/off 38
 - Save/Rcl 38
 - Key panel test
 - Check front panel 859
 - Keyboard
 - On-screen 71
 - Setting 448
 - Settings 445
 - Setup 445
 - Subsystem 617
 - Usage 64
 - Keypad
 - On-screen 71
- ## L
- LAN
 - Connecting 27
 - Environment 27
 - Interface 502
 - IP address 502
 - Main services 489
 - Reset 537
 - Samba services 490
 - Services 488
 - LAN configuration 543
 - LXI 538

- LAN interface
 - Avahi 489
 - Enable 489
 - FTP 489
 - HTTP 489
 - LAN over SCPI 489
 - SMB (Samba) 489
 - SSH 489
 - VNC 489
- LAN status
 - LXI 536
- Language
 - Emulation 523
- Last factory calibration 848
- Last full adjustment
 - Internal adjustments 861
- Last full test
 - Hardware modules selftest 866
- Layout
 - Keyboard 446
- Learn
 - List mode 344
- Learn list mode data
 - List mode 344
- Length
 - Control list 122
- Lev Att
 - see Level attenuation 83
- LEV_ATT 118
- Level
 - Annotation disable 486
 - Behavior (RF) 310, 341, 375
- Level attenuation 83
 - DM 118
- Level default unit
 - Change 785
- Level in SCPI in V 785
- Level limit 309, 375
- Level mode
 - Multi-segment waveform 202
- Level offset
 - Power sensors 378
 - RF level 309
 - State (power sensors) 378
- Level range
 - Attenuator settings 354
- Level settings
 - On start-up 447
- LF output
 - Sweep reset 337
- Libraries
 - Access 168
 - Download file 169
 - Load file 171
 - Play file 171
 - Required options 168
 - Save file 170
- License
 - Keys 466
- License for software option 850
 - Infos 849
- License server
 - Add remote connection 479
 - Enable connection restrictions 478
 - Restrict remote connection 477
- Licenses 466
 - Server 470
 - Settings 466
- Lifting the instrument 24
- Limit
 - RF level 309, 375
- List
 - Define 345
 - Range 345
 - State 342
 - Values, defining 349, 361
- List file
 - Catalog 345
- List mode
 - Create list automatically 350, 362
 - Current index 342
 - Dwell time mode 343
 - Edit 345
 - Execute trigger 344
 - Export user data 347, 367
 - File settings, import/export 346, 366
 - Global dwell time 343
 - Import/export 346, 366
 - Learn list mode data 344
 - Load from file 347, 367
 - Load user data 346
 - Reset 344
 - Select file 345
 - Settings 341
 - State 342
 - Trigger execute 344
 - Trigger source 343
- Load
 - See recall 422
 - User filter 116
 - Waveform 145
- Load instrument settings 578, 589
- Load list 198
- Load user mapping 113
- Loading
 - Trying out 56
- Local to remote switch over 555
- Lock
 - Display 487
- LSB/MSB order
 - Definition 611
- LucasFonts
 - RSCorpid EULA 849
- LVD-M transporting MAN altitude TEMPLATE 854
- LXI
 - Advanced configuration 539
 - Browser settings 537
 - Configuration 571
 - Hostname 536
 - IP address 536
 - IP configuration 539
 - LAN configuration 538
 - LAN status 536
 - MAC address 536
 - Ping 540
 - Remote trace (SCPI) 541
 - Reset (LXI) 537
 - Status settings 536
 - Tracing 554
- LXI settings 536

M

Mac address	521
MAC address	
LXI	536
Maintenance	855
Managing license keys	466
Managing licenses	466
Manual interaction	64
Map network share	
Settings	430
Map stream X to connector	
Settings	255
Mapping network drives/folders	
How to	432
Marker	85
Marker Delay	105
MARKER LIST	181, 189
Marker output signals	84
Marker positions	123
Marker trace	
Periodical	177, 188
Mass storage location	581
Matching	
Crest factor	251
Measured level	
NRP level control	374
Measurement period	272
How long	252
Min. version	
Firmware	849
Minimum locking range	315
Mode	
Attenuator settings	354
Emulation	523
Graphics	403
IP address	519
List	343
NRP power control	374
Sweep	334
User variation	307, 310
Modulation data	
Source internal	81
Modulation type	113
Monitoring	
Signal parameter	394
Mount network drive	
How to	432
Mounting, in a rack	26
Mouse	
Usage	64
Multi carrier signal	
General principle	222
Multi instrument mode	
Assign signal	393
Mode	393
State	392
Multi-carrier waveforms	220
Multi-segment	
Crest factor	211
Multi-segment table	200
Multi-segment waveform	
File contents	200
Multi-segment waveform sequencing	192
Multiple files	
Copy	428, 436, 437

Multiplier	
Frequency	307

N

Naming conventions	
Allowed file names	413
Network	
Connection fails	845
Environment	27
Settings	518
Network share	
Mapping	430
Mapping, how to	432
Network status	518
New list	198
New password	
Setup (security)	493
New user password	
Setup (security)	492
Next segment	209
Mode	210
Source	211
Noise	
Additive, generation	280
Pure, generation	280
Noise bandwidth	
AWGN	292
Noise only	286
Noise power	
System bandwidth	290
Total bandwidth	291
Noise ratio	
Power sensors	379
Non-dedicated connectors	449
Notifications	840, 843
Device-specific	841
NRP level control	
Measured level	374
NRP power control	372
Catch range	374
Delay time	375
Execute single	374
Mode	374
Reference level	374
Remote command sequence	785
Select sensor	373
Settings	372
State	373
Take measured level as reference	374
Target level	374
NRP power viewer	369
Settings	371
Use S-Parameter	380
NRP sensor configuration	375
NRP sensor mapping	380
Add LAN sensor	382
Add sensor	382
Add USBTMC sensor	382
Clear	382
Connector	381
Device ID	382
Host name	382
IP address	382
Protocol	381
Scan	382
Sensor name	381, 382

Serial number	382
Settings	381
NTP	
Address	857
NTRansition	510
Number of carriers	225
Number of licenses	850
Numeric data entry	71
Numeric parameters	71
O	
Offset	
Frequency	307
Offset I/Q	
Impairments	297
Old password	
Setup (security)	493
Old user password	
Setup	492
On-screen keyboard	72
On-screen keypad	68
On/Off ratio marker	86
Open source acknowledgment (OSA)	23
Open-source acknowledgments	849
Operating site	
Choosing	24
Setting up the instrument	25
Operation	
Manual	64
Operation complete	
Remote	577
Operation hours	848
Operation mode	422
Optimization mode	
I/Q	300
RF	300
Optimize crest factor	
Multi-carrier	226
Option	
Expiration date	849
R&S SMCVB-K19	41
Option: expiration date	850
Options	
Identification (remote)	577
see user manual	62
Oscillator	
Reference	312
Output	
SCPI list (select file)	560
OUTPut	
Subsystem	618
Output connector	41
Output connectors	
RF 50 Ω	39
Output file	199, 229
Multi-segment waveform	192
Output queue	508
Overflow	
Avoid	252
External signal	252
Oversampling factor	142
Overview	
External RF and I/Q	266

P

Parallel poll register enable	
Remote	577
Parameters	
Entering	71, 72
Password	
Change (security password)	493
Change (user password (security))	493
Confirm (security password)	493
Confirm (user password (security))	492
Enter (security password)	491
New (security password)	493
New (user password (security))	492
Old (security password)	493
Old user password	492
Protection level	483
Password management	
Security	491
Paste	
Instrument settings	430
Pattern	
Data source	110
Standard modulation data source	81
PCI bus	847
Peak power	
Channel	271
Digital output	275, 277
PEP	
Carrier + Noise	291
Percentage of signal bandwidth	
Graphics	404
Performance	
I/Q modulation	300
Period	
Blank segment	201
Periodical	
Marker trace	177, 188
Periodical markers	162
Phase	
Subsystem	784
Phase modulation settings	240
Phase offset	248
Between the I/Q streams	255
Phase reference	311
Phase start	233
Phase step	234
Ping	
LXI	540
Placing, on a bench top	25
Play list	192, 199, 206, 211
Play list file	
Sequencing list file	192
Playlist	
See play list	192
PN sequence	
See PRBS	81
Position	
Cursor in graphical display	123
Power	
Carrier + Interferer	291
Carrier + Noise	291
Connecting the instrument	27
Signal + Interferer	291
Signal + Noise	291
UCOR	359
Power of starting carrier	233

- Power on
 - Key 37
 - Power ramp
 - Restrict to baseband 118
 - Power ramping 83, 117
 - Power reference 227
 - Power sensors
 - Activation 377
 - Aperture time 379
 - Auto once 379
 - Filter 378
 - Filter length 379
 - Frequency 378
 - Level (average) 377
 - Level (peak) 377
 - Level offset 378
 - Noise ratio 379
 - NRP power control 372
 - Serial number 376
 - Source 377
 - State 377
 - State (level offset) 378
 - Timeout 379
 - Unit 377
 - Update 371
 - Use default aperture time 379
 - Zero 377
 - Power Sensors
 - Display 377
 - Power spectrum 399
 - Power supply
 - Connector 40
 - Power viewer
 - Auto once 379
 - Power-On
 - Settings 447
 - Power-On count 848
 - Power-On state
 - I/Q digital output 278
 - RF level 447
 - Power-On/EMF
 - About 447
 - RF signal 447
 - PPE 508
 - PRBS generator
 - Standard modulation data source 81
 - PRBS type 110
 - Prefix, year, month, Day 442
 - Preparing for use 24
 - Preset
 - Factory preset 418
 - Ramp 122
 - Print
 - Hard copy 443
 - Processing time 91
 - ARB 151
 - Protection
 - Settings 482
 - Setup 481
 - Protection level
 - 1 481
 - 2 481
 - 3, 4, 5 481
 - Adjustments 481
 - Calibration 481
 - Factory only 481
 - Protection level 483
 - Service department 481
 - PTRansition 510
 - Pulse divider marker 85
 - Pulse frequency marker 85
 - Pulse modulation settings 242
 - Double pulse delay 244
 - Double pulse width 244
 - Pulse mode 243
 - Pulse period 243
 - Pulse width 244
 - State 243
 - Transition type 244
 - Video polarity 244
 - Purge
 - List of external RF and I/Q instrument 262
- ## Q
- Q offset 295
 - QR code 535
 - Quadrature offset
 - Impairments 297
 - Quadrature Offset 295
 - Quantified Licenses 469
 - Queries
 - Status 514
 - Questionable status register 513
 - Quick shift of the baseband signal
 - How to 248
- ## R
- R&S signed packages
 - Secure update policy 484
 - R&S SMCVB-K200 469
 - Rack, mounting 26
 - Ramp
 - All up or all down 122
 - Low to high and vice versa 122
 - Ramp function 117
 - Ramp time 117
 - Ratio noise/system bandwidth
 - Minimum 286
 - RDS 80
 - Readjust
 - Automatic level control 310
 - Rear panel
 - Overview 39
 - Recall
 - Instrument settings 424
 - User menu 461
 - Recall instrument settings 578, 589
 - Recall intermediate 424, 578
 - Recorded SCPI commands
 - SCPI list 559
 - Rectangular test signal 140
 - Rectangular test signals
 - Settings 148
 - Redo 496
 - Clear history 497
 - History 497
 - Settings 497
 - State 497
 - Reference curve
 - Show, hide, assign 406

- Reference frequency output
 - Loop through 315
- Reference oscillator 312
 - Adjustment 316
 - Adjustment frequency 316
 - External frequency 314
 - Output frequency 315
 - Preset 313
 - RF off state 314
 - Source 313
 - Synchronization bandwidth 314
- Registers 508
- Release notes 23
- Reload
 - SCPI list 560
- Remote access 499
 - Active connections 523
 - DNS server 521
 - DNS suffix 520
 - HISLIP resource (VISA resource string) 521
 - HUMS 525
 - Identification 523
 - IDN string 523
 - Instrument emulations 522
 - IP address mode 519
 - Language 523
 - Network gateway 520
 - Network hostname 519
 - Network IP address 519
 - Network Mac address 521
 - Network resource (Ethernet resource string) 522
 - Network settings 518
 - Network status 518
 - OPT string 523
 - QR code 535
 - see Remote operation from a computer 64
 - Set IDN and OPT to default 523
 - Settings 516
 - Socket resource (VISA resource string) 522
 - Subnet mask 520
 - Visa resource strings 521
 - VXI11 resource (VISA resource string) 522
 - Workgroup name 519
- Remote connection
 - Add floating license server 479
 - Configure license server restrictions 477, 478
 - Status 259
- Remote control 74
 - Access modes 500
 - Command 265
 - Command sequence 266
 - History 266
 - IQ digital 766
 - Mode 265
 - Programming examples 575
 - RF envelope 766
 - SCPI 499
 - Source subsystem 649
 - Trace 266
- Remote operation 74
 - VNC 499
- Remote trace
 - LXI 541
- Removing sensitive data 851
- Rename
 - File 590
 - Instrument settings 430
- Resampling
 - External baseband signal 252
- Reset
 - List mode 344
 - RF frequency (delta phase) 311
 - Sweep 337
- Reset device parameters 580
- Reset values
 - Remote 578
- Resolution
 - Graphics 404
- Resolving internal adjustment failures 845
- Resource string
 - VISA 502
- Restart marker 204
- Restoring configuration 417
- Result
 - Hardware modules selftest 865
- Resulting file name 442
- Retrace
 - Sweep 335
- Retrigger
 - Common settings 101
- RF
 - Signal 302
- RF 50 Ω connector 39
- RF couple
 - External RF and I/Q instrument 260
- RF frequency
 - Configuring 304
 - External RF and I/Q instrument 260
- RF frequency sweep
 - State 334
- RF level
 - Configuring 304
 - EMF display 447
 - External RF and I/Q instrument 260
 - Offset 309
 - PEP 304
 - Power-On state 447
 - Setting characteristics 310, 341, 375
 - Settings 308
- RF level sweep
 - State 334
- RF OFF mode
 - Attenuator settings 354
- RF off state
 - Reference oscillator 314
- RF ON, RF OFF, RF ON/OFF 303
- RF output
 - Amplitude 309
 - Impedance 303
 - PEP 304
 - Protection 355
 - State 303
- RF Output
 - Level range 310, 341
- RF output signal
 - Phase 311
 - Phase reference 311
- RF path
 - External RF and I/Q 263
- RF phase
 - Configuring 304
- RF signal
 - Attenuator 353
 - Frequency 306

- Power-On/EMF 447
- User correction 355
- RF state
 - External RF and I/Q instrument 260
- Rise delay 117
- RMS
 - Digital output 276, 278
- RMS power
 - Channel 271
- Roll off factor
 - DM 115
- Rotary knob 39
 - User variation 307, 310
- Run module test
 - Hardware modules selftest 865
- S**
- S-Parameter
 - Activate corrections 380
- Safety instructions 15, 22
- Samba services
 - SMB client 490
 - SMB server 490
- SAMBA/SMB
 - How to access the instrument 434
- Sample rate
 - Aggregated 272, 276
 - Channel 271, 275
 - Link 272, 276
 - Source 269
 - Where to find the value 252
- Samples
 - Blank segment 201
- Samples per period 148
- Sanitize 486
- save
 - Save 422
- Save
 - Control list 123
 - Editor 350, 362
 - Instrument settings 423
 - Sequencing list 206
 - User menu 461
- Save and load 421
- Save as
 - Editor 350, 362
- Save hard copy as
 - bmp, jpg, png 441, 442
- Save immediate 424
- Save instrument settings 578, 591
- Save intermediate 578
- Save list 199
- Save/Recall 225, 421
 - Dialog 422
 - DM 108
 - How to 425
 - SCPI-Export 562
- Saving
 - Trying out 56
- Saving files 583
- Scan
 - NRP sensor mapping 382
- Scan for
 - External RF and I/Q instrument 262
- SCONfiguration subsystem 635
- SCPI
 - Error messages 841
 - Export 428
 - Export settings 559
 - Import 428
 - LAN services 489
 - Output file 560
 - SCPI export 560
 - Select file 560
 - Show file content 560
 - SCPI Export
 - Format 560
 - SCPI list
 - Commands of all settings 423
 - Display 558
 - Export 559
 - Recorded SCPI commands 559
 - Show all commands 423
 - SCPI remote trace
 - LXI 541
 - SCPI script
 - Select 465
 - SCPI-Export
 - Save/Recall 562
 - Screen saver
 - Activate 448
 - State 446
 - Wait time 446
 - Secure update policy
 - All packages 484
 - Confirm unsigned 484
 - R&S signed packages 484
 - Security
 - Accept settings 491
 - Change password (setup) 493
 - Change user password (setup) 493
 - Confirm password (setup) 493
 - Confirm user password (setup) 492
 - Display lock 487
 - Enter password (setup) 491
 - New password (setup) 493
 - New user password (setup) 492
 - Old password (setup) 493
 - Old user password 492
 - Password management 491
 - Sanitize 486
 - Secure update policy 484
 - Security password 493
 - Settings 483
 - Setup 481
 - USB storage (setup) 485
 - User name (setup) 492
 - User password 492
 - Volatile memory 485
 - Security password
 - Security 493
 - Setup 493
 - Security procedures 22
 - Security settings 481
 - Segment # 200
 - Segment down 200, 201, 208
 - Segment marker 203
 - Segment up 200, 201, 208
 - Select
 - List mode data file 345
 - Setup file 465
 - User correction data file 359

- Select file 427
- Select instrument
 - External RF and I/Q 262
- Self-test
 - About 855
 - Remote 579
- Selftest
 - How to run a hardware module selftest 867
 - Last full test 866
 - Result 865
 - Run module test 865
 - Test table 866
- Sensitive information
 - Protecting 414, 420
- Sensor
 - NRP power control 373
- Sensor name
 - NRP sensor mapping 382
- Sequencing graph 208
- Sequencing list 199, 206, 211
 - Load 206
 - New 206
- Serial bus 847
- Serial number 40, 545
 - NRP sensor mapping 382
 - Power sensors 376
- Service manual 22
- Service request (SRQ) 511, 514
- Service request enable register (SRE) 511
 - Remote 579
- Services
 - LAN 488
- Set according to 109
- Set IDN and OPT to default
 - Emulation mode 523
- Set level via
 - Digital output 277
- Set noise level via 288
- Set to default 224
 - ARB 145
 - DM 108
- Settings
 - Active connections 523
 - Attenuator 354
 - Check front panel 858
 - Delayed adjustment 862
 - Display 445
 - Instrument emulations 522
 - Internal adjustments 861
 - Keyboard 445
 - Licenses 466
 - List mode 341
 - Managing 413
 - NRP power control 372
 - NRP power viewer 371
 - NRP sensor mapping 381
 - On power-on 447
 - Protection 482
 - Remote access 516
 - RF level 308
 - SCPI export 559
 - Security 483
 - UCOR 358
 - Undo/Redo 497
 - User key 464
- Setup
 - Accept security settings 491
 - Adjusting display 444
 - Adjusting keyboard 444
 - Annotation frequency 486
 - Annotation level 486
 - Change password 493
 - Change password (security) 493
 - Confirm password 492
 - Confirm password (security) 493
 - Display lock 487
 - Enter password (security) 491
 - GUI update 444
 - Keyboard settings 445
 - Layout (keyboard) 446
 - New password 492
 - New password (security) 493
 - Old password (security) 493
 - Password (protection) 483
 - Performing the front panel test 858
 - Protection level 483
 - Screen saver 446
 - Secure update policy 484
 - Security password 493
 - USB storage (security) 485
 - User name (security) 492
 - User password 492
 - Wait time 446
- Setup files
 - Data exchange 439
- Shape
 - Sweep 335
- Shared connectors
 - Global connectors 450
- Shifting the baseband signal 245
- Shortcut to a network drives
 - How to 432
- Show
 - SCPI list 423
- Show file content
 - SCPI export 560
- Show powers for output
 - AWGN 288
- Show SCPI command 558
 - Close 558
 - Copy 558
- Signal + Interferer
 - PEP 291
- Signal + Noise
 - PEP 291
- Signal duration 227
- Signal generation status 102
- Signal monitoring
 - Graphical display 394
- Signal period mode 227
- Signal power 289
- Signal to connector mapping
 - How to 457
- Signal/Noise ratio 289
- Sine test signal 140
- Sine test signals
 - Settings 147
- Single
 - Common settings 101
 - Execute (list mode) 344
- SMB (Samba)
 - LAN services 489

- Socket
 - Visa resource string 522
- Softkey bar
 - See Taskbar 67
- Software options 62
- Source
 - Graphics 403
 - Power ramp control 117
 - Power sensors 377
 - Reference oscillator 313
 - Sweep trigger 334
- Source points for graphic display 399
- Source subsystem
 - Remote control commands 649
- Spacing
 - Frequency sweep 337, 339
 - RF level sweep 340
- Span
 - Frequency sweep 339
- Specified trigger delay 103
- Spectrum display 399
- SRE 508
- SRE (service request enable register) 511
- SRQ (service request) 511, 514
- SSH
 - LAN services 489
- Standard 109
- Standard settings 224
 - DM 108
- Standard-compliant signals 77
- Standby
 - Key 37
- Start
 - Frequency sweep 338
 - RF level sweep 340
- Start delay 234
- Start phase 233
- Start/stop carrier index 233
- Starting gain 233
- Starting the signal generation with the first sample 91
- State
 - Adjustment (reference oscillator) 316
 - ARB 144
 - AWGN 285
 - BB Input 269
 - DM 108
 - I/Q digital output 274
 - I/Q modulation 299
 - Impairments 297
 - List mode 342
 - NRP power control 373
 - Power sensors 377
 - RF frequency sweep 334
 - RF level sweep 334
 - RF output 303
 - RF output protection 355
 - Screen saver 446
 - UCOR 359
 - Undo/Redo 497
- Status
 - Queries 514
 - Remote connection to external RF and I/Q 259
- Status bar
 - Display 66
- Status byte
 - Remote 576, 579
- Status byte (STB) 511
- Status information 468
- Status register
 - Response format definition 611
- Status registers 508
 - CONDition 510
 - ENABLE 510
 - EVENT 510
 - Model 510
 - NTRansition 510
 - Parts 510
 - PTRansition 510
- Status reporting system 507
 - Application 514
 - Common commands 575
- Status settings
 - LXI 536
- STB 508
- Step
 - Frequency sweep 339
 - Linear (frequency sweep) 339
 - Logarithmic (frequency sweep) 339
 - RF level sweep 340
- Step width
 - User variation 307, 310
- Stop
 - Frequency sweep 338
 - RF level sweep 340
- Storage 855
- Storage location
 - /usb/ 413
 - /var/user 413
 - /var/volatile 413
 - Mass memory 581
- Stream distributing
 - Settings 255
- Stream mapping
 - Settings 255
- Subnet mask 520
- Subsystem
 - Keyboard 617
 - OUTPut 649
 - Phase 784
 - Power 785
 - SOURce:INPut 649
- Sum signal
 - How to shift basebands 248
- Support 851
- Suppressing
 - Carrier leakage 248
- Surveillance
 - Signal generation 394
- Sweep
 - Center frequency 339
 - Current frequency 334
 - Current level 334
 - Dwell time 337
 - Execute single 337
 - Frequency span 339
 - Mode 334
 - Reset 337
 - Retrace 335
 - Shape 335
 - Spacing 337, 339, 340
 - Start/stop frequency 338
 - Start/stop level 340
 - State (RF frequency) 334
 - State (RF level) 334

- Step 339, 340
- Trigger manually 337
- Switch over
 - Flexible 214
 - High speed 215
- Switching
 - Modulation to CW 114
 - On or off 34
- Symbol rate
 - DM 109
- Symbolic name
 - External RF and I/Q 263
- Sync. output to trigger 103
- Synchronization
 - Assign signal 393
 - Mode 393
 - State 392
- Synchronization bandwidth
 - Reference oscillator 314
- Synchronize
 - External RF and I/Q instrument 260
- Synchronizing
 - Several instruments 278
 - Signal generation 278
- Synchronous generation start 87
- System
 - Factory preset 418
- System bandwidth
 - AWGN 286
- T**
- T-DMB 78
- Tab labels 68
- Tag type 184
 - Clock 177
 - Comment 175
 - Control length 177, 188
 - Control list width4 186
 - Copyright 175
 - Data bit length 187
 - Data list 188
 - Date 176
 - Emptytag length 178
 - Level offset 179
 - Magic 174
 - Marker mode 180
 - Samples 180
 - Segment clock mode 184
 - Segment comment 186
 - Segment count 183
 - Segment duration 183
 - Segment files 186
 - Segment length 183
 - Segment level mode 185
 - Segment level offset 185
 - Segment start 184
 - Settings file 186
 - Trace list 181, 189
 - Waveform length 182
- Take measured level as reference
 - NRP power control 374
- Tapping points 399
- Target crest factor 226
- Target level
 - NRP power control 374
- Temperature offset
 - Internal adjustments 862
- Temporary files 414, 420
- Test
 - Check front panel 858
- Test signal
 - Amplitude of test signal 149
 - ARB generator 140
 - Frequency 148, 149
 - Offset DC 150
 - Phase offset Q 148
 - Samples per period 148, 149
 - Value I, Q 150
- Test table
 - Hardware modules selftest 866
- Testing
 - High-power amplifiers 235
- Text entry 71
- Time
 - UTC 857
- Time protocol
 - Settings 857
- Timeout
 - Filter (power sensors) 379
- Tooltips
 - Show 72
- Touchscreen
 - Compared with mouse 64
 - Overview 36
 - Usage 64
- Touchscreen test
 - Perform 859
- Trace
 - Enable in graphic 406
- Tracing
 - Messages 554
 - SCPI commands 554
- Tracking
 - Signal parameter 394
- Transmitter test
 - Generating multi carrier signal 235
- Trigger
 - Event (remote) 579
 - Execute (list mode) 344
 - Generate signal manually 456
 - Manually 456
 - Sweep, manually 337
- Trigger delay
 - Actual 104
 - Expressed in seconds 103
 - Expressed in time 103
 - Resulting 104
 - Unit 103
- Trigger Delay
 - DM 103
- Trigger event 87
 - Delay 92
 - Suppress 92
- Trigger example 211
- Trigger Mode
 - Common settings 101
- Trigger signal duration 102
- Trigger signals
 - Baseband 86

- Trigger source
 - Graphics 403
 - List mode 343
 - Sweep 334
- Trigger Source
 - DM 102
- Trigger, accidental
 - Avoiding 91
- Triggering
 - Multi-segment waveform 194
 - Segment 194
- Tripped
 - RF output protection 355
- U**
- UCOR
 - About 356
 - Calibrate RF output level with power sensor 383
 - Data 359
 - Display correction file data 359
 - Display correction value 359
 - Edit data 359
 - Export user data 347, 367
 - File catalog 359
 - File settings, import/export 346, 366
 - Fill with sensor 364
 - Import/export 346, 366
 - Load from file 347, 367
 - RF signal 355
 - Select file 359
 - Settings 358
 - State 359
 - Values, defining 349, 361
- Undo
 - Clear history 497
 - History 497
 - Settings 497
 - State 497
- Units X-axis
 - Change 405
- Unmodulated signal 83
- Unpacking the instrument 24
- Up-conversion
 - Important parameters 251
- USB
 - Storage (security) 485
- Use default aperture time
 - Power sensors 379
- User clock 203
- User correction
 - see UCOR 355
- User data
 - Access 426
 - Load from a specific directory 584
- User files 413
- User filter
 - Catalog 116
 - Delete 116
- User interface
 - Lock 487
- User key 460
 - Action name 464
 - Add, change, delete action 465
 - Assign actions 465
 - Define action 464, 465
 - SCPI command 465
 - Select dialog ID 465
 - Settings 464
 - Toggle between define and execute mode 465
- User manual 22
- User mapping
 - Catalog 113
 - Delete 113
- User menu 460
 - Access 462
 - Clear 461
 - Create 462
 - Recall 461
 - Save 461
 - Settings 461
- User name
 - Setup (security) 492
- User password
 - Security 492
 - Setup 492
- User preset 417
- User variation
 - Activating 307, 310
 - Level 307, 310
 - RF 307, 310
- User-definable preset
 - Recall 461
- Utility keys
 - Overview 38
- V**
- Value
 - Sample rate 274
- Variable FSK
 - Deviation 114
 - Selecting 114
- Varying
 - RF frequency and level 307, 310
- Vector diagram 395
- Vector modulation 298
- Verifying
 - Signal parameter 394
- Version
 - Firmware 849
- Videos 23
- VISA 501
 - Resource string 502
- Visa resource string
 - Ethernet 522
 - HISLIP 521
 - Socket 522
 - VXI11 522
- Visa resource strings 521
- VNC
 - LAN services 489
 - Using in a LAN 74
- Volatile memory 414, 420
- Volatile mode
 - Activate 485
- VXI11
 - Visa resource string 522
- W**
- Wait
 - Remote 579

Wait time	
Screen saver	446
Wanted signal	
Use an external digital signal	250
Warnings	840, 843
Waveform	
Edit, rules	167
Info	145, 200
Load file	145
Maximum length	142
Optimizing	142
Waveform file	
Corrupted, reasons	167
What's new	21
White papers	23
Wi-Fi	
WLAN	568
Workflow	
Multi-segment waveform	212
Workgroup name	519
Wrap-around	
Avoiding problems	222
Overcome problem	214
Z	
Zero	
Power Sensors	377
Zeroconf	
IP address	845
Zeroconf (Avahi) protocol	544
Zoom	
Control list display	123