

P5122 200 MHz 100X High Voltage Probe

Instructions



P5122 100X Probe

The P5122 Probe is a high voltage probe with 100X attenuation and a compensation range of 10 to 25 pF. The probe is designed for use with Tektronix TPS2000 and THS3000 series floating oscilloscopes with high input impedance (1 M Ω). The probe has no user- or Tektronix-serviceable parts.

⚠ WARNING. The reference contact ring (see below) is always the same voltage as the reference lead. To avoid arc flash, always ensure the insulation sleeve or hook tip is installed to cover the reference contact ring.

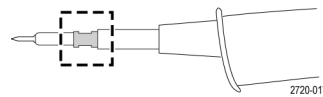

Connecting the Probe to the Oscilloscope

Connect the probe as shown in the illustrations below.

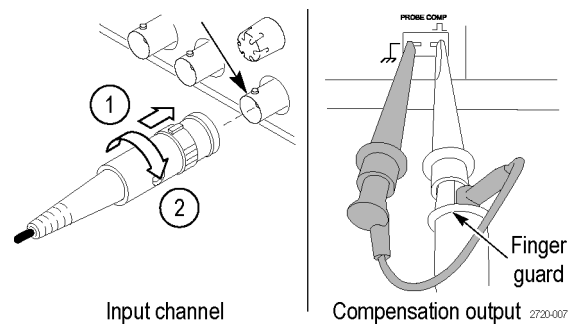

Compensating the Probe

Due to variations in oscilloscope input characteristics, the low-frequency compensation of the probe may need adjustment after moving the probe from one oscilloscope channel to another.

If a 1 kHz calibrated square wave displayed at 1 ms/division shows significant differences between the leading and trailing edges, perform the following steps to optimize low-frequency compensation:

1. Connect the probe to the oscilloscope channel that you plan to use for your measurements.
2. Connect the probe to the probe compensation output terminals on the oscilloscope front panel.

⚠ WARNING. To avoid electric shock, only connect to the Probe Comp signal on the oscilloscope when making this adjustment.

3. Depress the locking pin inside the protective sleeve.
4. Turn the sleeve and the cable end until the adjustment is visible through the opening.

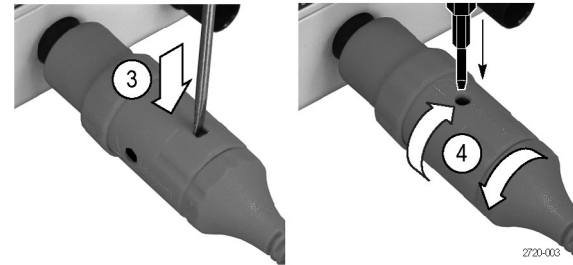

5. Push AUTOSET or otherwise adjust your oscilloscope to display a stable waveform.
6. Adjust the trimmer in the probe until you see a perfectly flat-top square wave on the display. (See illustration.)

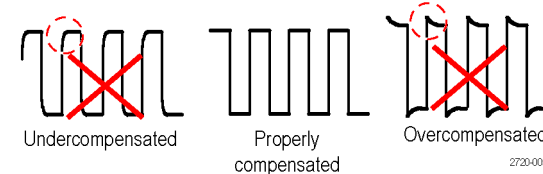

⚠ WARNING. To avoid electric shock, only use the insulated adjustment tool when making compensation adjustments.

7. Turn the sleeve back and lock the sleeve in place.

⚠ WARNING. To avoid electric shock, ensure that the sleeve is locked in the closed position after making compensation adjustments.

Connecting the Probe to the Circuit

Use the standard accessories included with the probe to connect to your circuit. (See Table 1.)



⚠ WARNING. To avoid electric shock when using the probe or accessories, keep fingers behind the finger guard of probe body & accessories (as shown).

To reduce risk of shock, when using the probe on floating measurements, ensure the reference lead accessories are fully mated before connecting the probe to the circuit under test.

Standard Accessories

The standard accessories included with the probe can be reordered as a kit. The kit includes one of each item shown below. Order Tektronix part number 020-3046-00.

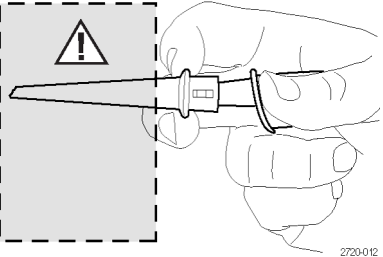
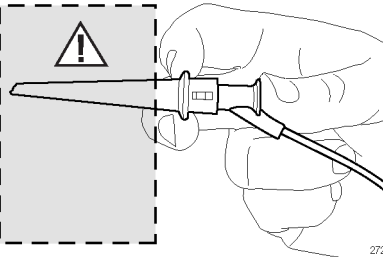
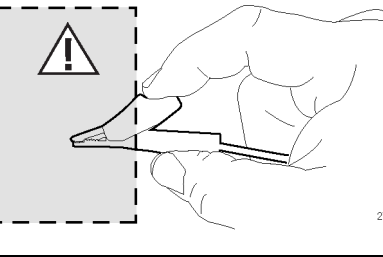
Table 1: Probe accessories kit

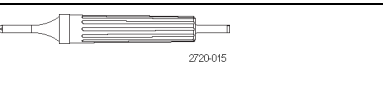
Item	Description
	Hook tip 1. Press onto probe tip 2. Squeeze the hook tip to extend the conductive hook 3. Clamp hook onto conductor
	Reference lead, with hook clip 1. Secure lead to probe head ground pin 2. Connect hook clip to circuit reference
	Reference lead, with mini-alligator clip 1. Secure lead to probe head ground pin 2. Squeeze clip and connect to circuit reference
	Ground spring for probe tip 1. Press onto probe tip 2. Probe circuits with nearby reference test points
	Adjustment tool Use only this insulated tool for compensation adjustments

Specifications

Read the caution below if you are using the probe with the TPS2000 series oscilloscope input set to AC coupling.

CAUTION. When the oscilloscope input is set to AC Coupling, do not probe DC levels >300 V or AC signals less than 1 Hz and >300 V_{RMS}. (See graph below.)

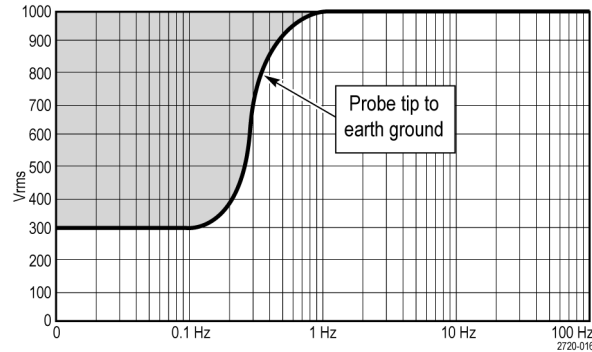

Refer to the reference lead derating curve below when making floating measurements.

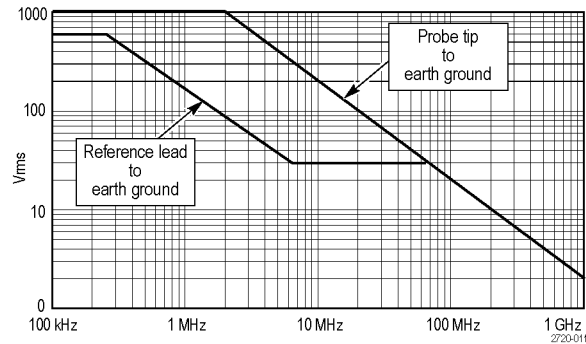

Table 2: Electrical and mechanical specifications

Characteristic	Specification
Bandwidth	DC to 200 MHz (-3 dB)
System attenuation accuracy	100:1
Compensation range	10 pF-25 pF
System input resistance	100 MΩ
System input capacitance	4.6 pF
Maximum tip input voltage	1000 V CAT II

Characteristic	Specification
Maximum reference lead voltage to ground	600 V CAT II
Cable length	1.2 m

Table 3: Environmental specifications

Characteristics	Description
Temperature	
Maximum operating	+40 °C (+104 °F)
Minimum operating	+5 °C (+40 °F)
Nonoperating	-55 °C to +75 °C (-67 °F to +167 °F)
Humidity	80% up to +30 °C (+86 °F), falling linearly to 50% at +40 °C (+104 °F)
Altitude	
Operating	2.0 km (6,600 ft) maximum
Nonoperating	15 km (50,000 ft) maximum

Table 4: Certifications and compliances

Characteristics	Description								
EC Declaration of Conformity	Compliance was demonstrated to the following specification as listed in the Official Journal of the European Communities: Low Voltage Directive 2006/95/EC: EN61010-031: 2002								
Measurement Category Descriptions	<table border="1"> <thead> <tr> <th>Category</th> <th>Examples of Products in this Category</th> </tr> </thead> <tbody> <tr> <td>CAT III</td> <td>Distribution-level mains, fixed installation</td> </tr> <tr> <td>CAT II</td> <td>Local-level mains, appliances, portable equipment</td> </tr> <tr> <td>CAT I</td> <td>Circuits not directly connected to mains.</td> </tr> </tbody> </table>	Category	Examples of Products in this Category	CAT III	Distribution-level mains, fixed installation	CAT II	Local-level mains, appliances, portable equipment	CAT I	Circuits not directly connected to mains.
Category	Examples of Products in this Category								
CAT III	Distribution-level mains, fixed installation								
CAT II	Local-level mains, appliances, portable equipment								
CAT I	Circuits not directly connected to mains.								
Pollution Degree 2	Do not operate in environments where conductive pollutants may be present (as defined in IEC 61010-1). Rated for indoor use only.								
Additional Safety Standards	UL61010B-1, First Edition & UL61010B-2-031, First Edition. CAN/CSA-C22.2 No. 1010.1-92, & CAN/CSA-C22.2 No. 1010.2.031-94 IEC61010-031:2002								



Equipment Recycling. This product complies with the European Union's requirements according to Directive 2002/96/EC on waste electrical and electronic equipment (WEEE). For more information about recycling options, check the Support/Service section of the Tektronix Web site (www.tektronix.com).

Safety Summary

Review the following safety precautions to avoid injury and prevent damage to this product or any products connected to it. To avoid potential hazards, use this product only as specified. Using the probe or accessories in a manner not specified could result in a shock or fire hazard.

To Avoid Fire or Personal Injury

For Use With TPS2000 and THS3000 Series Oscilloscopes Only. Do not float the reference lead of this probe above the rated float voltage (600 V RMS CAT II).

Connect and Disconnect Properly. Connect the probe output to the measurement instrument before connecting the probe to the circuit under test. Disconnect the probe input and the probe reference lead from the circuit under test before disconnecting the probe from the measurement instrument.

Avoid Electric Shock. To avoid injury or loss of life, do not connect or disconnect probes or test leads while they are connected to a voltage source.

Observe All Terminal Ratings. To avoid fire or shock hazard, observe all ratings and markings on the product. Consult the product manual for further ratings information before making connections to the product.

Avoid Electric Shock. When using probe accessories, never exceed the lowest rating of the probe or its accessory, whichever is less, including the measurement category and voltage rating.

Avoid Electric Overload. To avoid injury or fire hazard, do not apply potential to any input, including the reference inputs, that varies from ground by more than the maximum rating for that input.

Avoid Exposed Circuitry and Do not Operate Without Covers. Do not touch exposed connections and components when power is present.

Inspect The Probe And Accessories. Before each use, inspect probe and accessories for damage (cuts, tears,

defects in the probe body, accessories, cable jacket, etc.). Do not use if damaged.

Do Not Operate in Wet/Damp Conditions.

Do Not Operate in an Explosive Atmosphere.

Keep Product Surfaces Clean and Dry.

Safety Terms and Symbols Terms in This Manual.

These terms may appear in this manual:

WARNING. Warning statements identify conditions or practices that could result in injury or loss of life.

CAUTION. Caution statements identify conditions or practices that could result in damage to this product or other property.

Symbols on the Product. These symbols may appear on the product:



CAUTION
Refer to Manual

Contacting Tektronix

Web site: www.tektronix.com
Phone: 1-800-833-9200
Address: Tektronix, Inc.
Department or name (if known)
14200 SW Karl Braun Drive
P.O. Box 500
Beaverton, OR 97077
USA
Email: techsupport@tektronix.com

Warranty Information

For warranty information, go to www.tektronix.com/warranty

