



SignalVu-PC
Vector Signal Analysis Software
Help



077-0720-20



SignalVu-PC
Vector Signal Analysis Software
Help

Register now!
Click the following link to protect your product.
tek.com/register



077-0720-20 March 2024

Copyright © 2024, Tektronix. 2024 All rights reserved. Licensed software products are owned by Tektronix or its subsidiaries or suppliers, and are protected by national copyright laws and international treaty provisions. Tektronix products are covered by U.S. and foreign patents, issued and pending. Information in this publication supersedes that in all previously published material. Specifications and price change privileges reserved. All other trade names referenced are the service marks, trademarks, or registered trademarks of their respective companies.

TEKTRONIX and TEK are registered trademarks of Tektronix, Inc.

Tektronix, Inc.
14150 SW Karl Braun Drive
P.O. Box 500
Beaverton, OR 97077
US

For product information, sales, service, and technical support visit [tek.com](https://www.tek.com) to find contacts in your area. For warranty information visit [tek.com/warranty](https://www.tek.com/warranty).

Contents

Get Started.....	21
Welcome.....	21
Software and Documentation.....	21
How to install product software.....	21
How to activate and purchase new application licenses (options).....	22
How to manage the 5GNR analysis license.....	26
How to activate legacy options (application licenses).....	28
How to activate options in free trial (evaluation) mode.....	30
How to manage legacy option licenses.....	30
Available application options.....	31
Features by product.....	33
Available product documentation.....	34
Available demonstration guides.....	35
Video tutorials.....	36
Orientation.....	36
Selecting Files for Analysis.....	36
Right-Click Action Menu.....	37
Elements of the Display.....	39
Restoring Default Settings.....	42
Presets.....	42
Setting Options.....	50
Connectivity.....	55
Measurements.....	59
Multi-channel Analysis.....	59
Selecting Displays.....	59
Available Measurements.....	61
General Signal Viewing.....	73
Overview.....	73
DPX primer.....	73
DPX display overview.....	90
DPX display.....	90
DPX settings.....	95
Traces tab.....	96
Horiz & Vert Scale Tab.....	99
Bitmap Scale Tab.....	100
Time & Freq Tab.....	100
Density Tab.....	101
Time Overview Display.....	102
Time Overview Settings.....	104
Navigator View.....	105
Trace Tab.....	106
Spectrum Display.....	109
Spectrum Settings.....	111
Scale Tab.....	112

Spectrogram Display.....	112
Spectrogram Settings.....	116
Trace Tab.....	117
Amplitude Scale Tab.....	117
Time & Freq Scale Tab.....	118
Amplitude Vs Time Display.....	119
Amplitude Vs Time Settings.....	121
Freq & BW Tab.....	121
Frequency Vs Time Display.....	122
Frequency Vs Time Settings.....	124
Phase Vs Time Display.....	124
Phase Vs Time Settings.....	126
RF I & Q vs Time Display.....	126
RF I & Q vs Time Settings.....	128
Common Controls General Signal Viewing Shared Measurement Settings.....	129
Freq & BW Tab — Freq vs Time, Phase vs Time, RF I & Q vs Time Display.....	131
Freq & Span Tab.....	131
Traces Tab.....	132
Traces tab - Math Trace.....	135
BW Tab.....	136
Scale Tab.....	137
Prefs Tab.....	139
Analog Modulation.....	144
Overview.....	144
AM Display.....	144
AM Settings.....	145
Parameters Tab.....	146
Trace Tab.....	147
Scale Tab.....	149
Prefs Tab.....	149
FM Display.....	150
FM Settings.....	151
Parameters Tab.....	152
Trace Tab.....	153
Scale Tab.....	154
Prefs Tab.....	155
PM Display.....	156
PM Settings.....	157
Parameters Tab.....	158
Trace Tab.....	159
Scale Tab.....	161
Prefs Tab.....	161
RF Measurements.....	163
Overview.....	163
Channel Power and ACPR (Adjacent Channel Power Ratio) Display.....	163
RF Channel Power Measurement.....	165
Channel Power.....	165
Average Channel Power.....	165
Adjacent Channel Leakage Power Ratio.....	166

Adjacent Channel Power.....	166
Channel Power and ACPR Settings.....	166
Channels Tab for ACPR.....	166
Signal Strength Display.....	168
Signal Strength Settings.....	169
Freq & RBW Tab for Signal Strength display.....	170
Measurement Params Tab for Signal Strength display.....	170
Channels Tab for Signal Strength display.....	171
Scale Tab for Signal Strength display.....	172
Prefs Tab.....	172
MCPR (Multiple Carrier Power Ratio) Display.....	173
Multiple Carrier Power Ratio.....	176
MCPR Settings.....	176
Freq & RBW Tab for ACPR and MCPR Displays.....	177
Measurement Params for ACPR and MCPR Displays.....	178
Channels Tab for MCPR.....	179
Occupied BW & x dB BW Display.....	181
Occupied Bandwidth.....	183
Occupied BW & x dB BW Settings.....	183
Parameters Tab.....	184
Spurious display.....	185
Spurious display settings.....	189
Parameters Tab.....	189
Reference Tab.....	190
Ranges and Limits Tab.....	191
CCDF Display.....	195
CCDF Settings.....	196
Scale Tab.....	197
Parameters Tab.....	197
Phase Noise Display.....	198
Phase Noise Settings.....	201
Frequency Tab.....	202
Parameters Tab.....	203
Settling Time Measurement Overview.....	203
Settling Time Displays.....	208
Settling Time Settings.....	214
Common Controls Settling Time Displays Shared Measurement Settings.....	215
Define Tab for Settling Time Displays.....	215
Time Params Tab for Settling Time Displays.....	216
Mask Tab for Settling Time Displays.....	217
Trace Tab for Settling Time Displays.....	218
Scale Tab for Settling Time Displays.....	219
Prefs Tab for Settling Time Displays.....	220
SEM Display.....	221
Spectrum Emission Mask Settings.....	224
Parameters Tab - SEM.....	224
Processing Tab - SEM.....	226
Ref Channel Tab.....	227
Offsets & Limits Table Tab - SEM.....	228

Scale Tab - SEM.....	229
Prefs Tab - SEM.....	230
Common Controls RF Measurements Shared Measurement Settings.....	230
Freq & RBW Tab.....	231
Traces Tab.....	232
Scale Tab.....	234
Prefs Tab.....	235
Tracking Generator.....	237
Overview.....	237
Transmission Gain Display Settings.....	240
Freq Setup - Tracking generator.....	240
Track Gen tab - Tracking generator.....	241
Prefs tab - Tracking generator.....	241
Scale tab - Tracking generator.....	242
Traces tab - Tracking generator.....	243
Calibration for Cable Loss, Return Loss, and DTF measurements.....	245
Overview.....	245
Calibration types.....	245
How to perform a new calibration.....	246
How to load a User calibration.....	249
How to load a Factory calibration.....	249
How to save a calibration.....	250
Calibration status messages.....	254
Return Loss Measurements.....	255
Return Loss measurements overview.....	255
How to make a Cable Loss measurement.....	255
How to make a Return Loss measurement.....	258
How to make a Distance to Fault measurement.....	260
How to change the vertical scale units.....	263
How to select the appropriate settings for DTF Setup.....	263
How to improve the display of distance to fault measurements.....	263
How to improve the resolution of distance to fault measurements.....	264
RL/DTF display overview.....	264
Cable Loss and RL DTF Display Settings.....	267
Cable Loss Display Settings.....	267
Setup - Cable Loss.....	267
Parameters tab - Cable Loss.....	267
Cable Type.....	268
Traces tab - Cable Loss.....	269
Scale tab - Cable Loss.....	270
Prefs tab - Cable Loss.....	271
RL/DTF Display Settings.....	271
DTF Setup button – RL/DTF.....	272
Setup - RL/DTF.....	273
Parameters tab - RL/DTF.....	273
Cable Type.....	274
Displays tab - RL/DTF.....	275
Traces tab - RL/DTF.....	275
Scale tab - RL/DTF.....	277

Prefs tab - RL/DTF.....	278
WLAN Measurements.....	279
WLAN Measurements Overview.....	279
WLAN Channel Response Display.....	281
WLAN Channel Response Settings.....	282
WLAN Constellation Display.....	283
WLAN Constellation Settings.....	284
WLAN EVM Display.....	285
WLAN EVM Settings.....	286
WLAN Magnitude Error Display.....	287
WLAN Magnitude Error Settings.....	288
WLAN Phase Error Display.....	289
WLAN Phase Error Settings.....	290
WLAN Power vs Time Display.....	291
WLAN Power vs Time Settings.....	293
WLAN Spectral Flatness Display.....	293
WLAN Spectral Flatness Settings.....	295
WLAN Summary Display.....	295
WLAN Summary Settings.....	298
WLAN Symbol Table Display.....	299
WLAN Symbol Table Settings.....	301
WLAN Analysis Shared Measurement Settings.....	302
Modulation Params Tab - WLAN.....	302
Analysis Params Tab - WLAN.....	303
Data Range Tab - WLAN.....	304
Analysis Time Tab - WLAN.....	305
Trace Tab - WLAN.....	306
Traces Tab - WLAN Channel Response.....	306
Scale Tab - WLAN.....	307
EVM Tab - WLAN.....	309
Prefs Tab - WLAN.....	309
802.11ad and 802.11ay Analysis.....	311
Overview of 802.11ad and 802.11ay.....	311
802.11ad/11ay Constellation Display.....	316
802.11ad/11ay EVM vs Time.....	319
802.11ad/11ay Symbol Table Display.....	322
802.11ad/11ay Summary Display.....	323
802.11ad/11ay Control Panel Settings.....	326
Modulation Params tab – 802.11ad/11ay.....	327
Analysis Params tab – 802.11ad/11ay.....	327
Advanced Params tab – 802.11ad/11ay.....	328
Analysis Time tab – 802.11ad/11ay.....	329
EVM tab – 802.11ad/11ay.....	331
Scale tab – 802.11ad/11ay.....	332
Prefs tab – 802.11ad/11ay.....	333
Traces tab – 802.11ad/11ay.....	334
Limits tab – 802.11ad/11ay.....	334
OFDM Analysis.....	336
OFDM Analysis Overview.....	336

OFDM Channel Response Display.....	336
OFDM Channel Response Settings.....	338
OFDM Constellation Display.....	338
OFDM Constellation Settings.....	339
OFDM EVM Display.....	340
OFDM EVM Settings.....	341
OFDM Spectral Flatness Display.....	341
OFDM Spectral Flatness Settings.....	342
OFDM Magnitude Error Display.....	343
OFDM Magnitude Error Settings.....	344
OFDM Phase Error Display.....	344
OFDM Phase Error Settings.....	345
OFDM Power Display.....	346
OFDM Power Settings.....	347
OFDM Summary Display.....	347
OFDM Summary Settings.....	348
OFDM Symbol Table Display.....	349
OFDM Symbol Table Settings.....	350
OFDM Analysis Shared Measurement Settings.....	350
Modulation Params Tab - OFDM.....	351
Advanced Params Tab - OFDM.....	351
Data Range Tab - OFDM.....	352
Analysis Time Tab - OFDM.....	353
Trace Tab - OFDM.....	354
Scale Tab - OFDM.....	355
Prefs Tab - OFDM.....	356
Pulsed RF.....	358
Pulsed RF Overview.....	358
Cumulative Histogram Display.....	360
Cumulative Histogram display settings.....	362
Cumulative Statistics Table display.....	364
Cumulative Statistics Table display settings.....	367
Pulse-Ogram display.....	367
Pulse-Ogram display settings.....	369
Pulse Table display.....	369
Pulse Table display settings.....	371
Pulse Trace display.....	371
Pulse Trace display settings.....	373
Pulse Statistics display.....	374
Pulse Statistics settings.....	379
Pulsed RF measurement settings.....	380
Measurements Tab.....	383
Params Tab.....	383
Define Tab.....	385
Levels Tab.....	389
Freq Estimation Tab.....	389
Analysis Tab.....	390
Traces Tab.....	391
Scale Tab.....	392

Prefs Tab.....	394
EMC Accessories.....	398
Overview.....	398
Radiated tests introduction.....	398
EMI-BICON-ANT (ABF-900A biconical antenna).....	400
EMI-TRIPOD (AT-812 antenna tripod).....	402
EMI-CLP-ANT (ALC-100 Log Periodic Dipole Array (antenna)).....	403
EMI-PREAMP (PAM-103 preamplifier).....	403
Radiated pre-compliance test setup (30 MHz to 300 MHz).....	404
Radiated pre-compliance test setup (300 MHz to 1 GHz).....	407
Conducted tests introduction.....	409
EMI-LISN50UH (TBLC08 Line Impedance Stabilization Network).....	410
CABLE (coaxial Type N to Type N).....	411
EMI-LISN5UH (TBOH01 Line Impedance Stabilization Network).....	411
EMI-TRANS-LIMIT (LIT-153A transient limiter).....	411
EMI-NF-AMP (TBWA2 amplifier).....	412
EMI-NF-PROBE (TBPS01 near field probe set).....	413
Accounting for accessories contributions in EMCVu software.....	413
EMC Analysis.....	414
Introduction to EMC Analysis.....	414
Pre-compliance.....	418
How to perform an EMC pre-compliance test.....	418
EMC Project Setup Wizard.....	422
Accessories tab.....	423
Ranges and Limits tab.....	427
Reports.....	432
Measure ambient.....	433
Re-measure spot.....	434
Generating and saving reports.....	435
EMC Troubleshooting.....	439
Harmonic Markers.....	440
Inspect.....	440
Level Target.....	443
Compare Traces.....	444
Persistence Display.....	446
EMC-EMI display.....	447
EMC-EMI settings.....	452
Parameters tab - EMC.....	452
Emission Type tab - EMC.....	453
Accessories tab - EMC.....	454
Accessories setup.....	455
Available accessories in the drop-down lists.....	456
Edit accessory contributions.....	456
Changing accessory details.....	458
Loading accessories from a file.....	458
Two types of mismatch issues when recalling the .csv file.....	458
Sorting the Freq column in the Loss Table.....	459
Combined impact of gains/losses.....	460
Calculation of combined impact of accessories gains/losses.....	462

Warning when frequency range of scan does not match.....	465
External correction in DPX.....	465
Ranges & Limits tab - EMC.....	465
Change range Start and Stop frequencies.....	467
Specify Spot requirements.....	468
Set limits.....	468
Perform Pass/Fail testing.....	468
Measurement Type tab - EMC.....	469
Traces tab — EMC.....	472
Ambient tab - EMC.....	476
Scale tab — EMC.....	478
Prefs tab — EMC.....	478
APCO P25 Analysis.....	480
P25 Overview.....	480
P25 Constellation Display.....	491
P25 Constellation Settings.....	493
P25 Eye Diagram Display.....	493
P25 Eye Diagram Settings.....	495
P25 Power vs Time Display.....	496
P25 Power vs Time Settings.....	498
P25 Summary Display.....	498
P25 Summary Settings.....	501
P25 Symbol Table Display.....	501
P25 Symbol Table Settings.....	503
P25 Frequency Dev vs Time Display.....	504
P25 Frequency Dev Vs Time Settings.....	506
P25 Analysis Shared Measurement Settings.....	506
Modulation Params Tab - P25.....	507
Analysis Params Tab - P25.....	509
Analysis Time Tab - P25.....	509
Test Patterns Tab - P25.....	511
Trace Tab - P25.....	511
Scale Tab - P25.....	512
Trig MeasTab - P25.....	513
Prefs Tab - P25.....	514
Limits Tab - P25.....	514
LTE Analysis.....	516
LTE Overview.....	516
LTE ACLR display.....	528
LTE ACLR Settings.....	530
LTE Channel Spectrum display.....	531
LTE Channel Spectrum Settings.....	533
LTE Constellation display.....	533
LTE Constellation Settings.....	534
LTE Power vs Time display.....	535
LTE Power vs Time Settings.....	537
LTE Analysis Measurement Settings.....	537
Channels tab - LTE.....	538
Parameters tab - LTE.....	540

Processing tab - LTE.....	541
Offsets and Limits Table tab - LTE.....	542
Scale tab - LTE.....	544
Prefs tab - LTE.....	546
Freq and RBW tab - LTE.....	547
Measurement Params tab - LTE.....	548
Modulation Params tab - LTE.....	548
Analysis Params tab - LTE.....	549
Analysis Time tab - LTE.....	550
Trace tab - LTE.....	551
Limit tab - LTE.....	551
5G NR Analysis.....	553
Overview.....	553
Supported 5G NR Measurements.....	554
5G NR Standards Preset Test Setups.....	554
5G NR Displays.....	562
5G NR Status Messages.....	562
NR Adjacent Channel Power Display.....	563
NR Adjacent Channel Power Display Settings.....	565
NR Channel Power Display.....	565
NR Channel Power Display Settings.....	566
NR Constellation Display.....	567
NR Constellation Display Settings.....	568
NR Spectral Emission Mask display.....	568
NR Spectral Emission Mask Display Settings.....	570
NR Occupied Bandwidth Display.....	571
NR Occupied Bandwidth Display Settings.....	572
NR EVM Display.....	572
NR EVM Settings.....	574
NR Power vs Time Display.....	574
NR Power vs Time Settings.....	575
NR Summary Display.....	576
NR Summary Display Settings.....	580
NR Analysis Measurement Settings.....	581
ACP Tab.....	582
Signal Configuration Tab.....	583
Subblock Configuration Tab.....	584
Carrier Configuration Tab.....	585
Physical Uplink Shared Channel for Component Carrier 1 Window.....	587
Physical Downlink Shared Channel for Component Carrier 1 Window.....	592
Averaging Tab.....	595
Prefs Tab.....	596
OBW Tab.....	597
PVT Tab.....	598
CHP Tab.....	598
SEM Tab.....	599
Modulation Accuracy Tab.....	601
Estimation Tab.....	602
Traces Tab.....	603

Bluetooth Analysis.....	604
Overview.....	604
Bluetooth Constellation display.....	613
BT Constellation Settings.....	615
Bluetooth Eye Diagram display.....	615
BT Eye Diagram Settings.....	617
Bluetooth Carrier Frequency Offset and Drift display.....	618
BT CF Offset and Drift Settings.....	620
Bluetooth Summary display.....	621
BT Summary Settings.....	624
Bluetooth Symbol Table display.....	625
BT Symbol Table Settings.....	628
Bluetooth Frequency Dev vs Time display.....	629
BT Frequency Dev Vs Time Settings.....	631
Bluetooth 20dB Bandwidth display.....	632
BT 20dB BW settings.....	634
Bluetooth InBand Emission display.....	634
Bluetooth Analysis Measurement Settings.....	636
Standard Params tab - BT.....	637
Analysis Params tab - Bluetooth.....	639
Analysis Time tab - Bluetooth.....	639
Limits tab - Bluetooth.....	641
Scale tab - Bluetooth.....	642
Traces tab - Bluetooth.....	643
Prefs tab - Bluetooth.....	645
Parameters tab - Bluetooth.....	646
Freq & RBW tab - Bluetooth.....	647
Measurement Params tab - Bluetooth.....	648
Audio Analysis and Demodulation.....	649
Overview.....	649
Audio Spectrum Display.....	649
Audio Spectrum Settings.....	650
Audio Summary Display.....	651
Audio Summary Settings.....	652
Audio Analysis Measurement Settings.....	652
Params1 Tab.....	653
Params2 Tab.....	654
Audio Filters Tab.....	655
Scale Tab.....	658
Hum & Noise Tab.....	659
Prefs Tab.....	660
Audio Demodulation.....	660
GP Digital Modulation.....	662
Overview.....	662
Constellation Display.....	663
Constellation Settings.....	664
Demod I & Q vs Time Display.....	665
Demod I & Q vs Time Settings.....	667
EVM vs Time Display.....	668

EVM vs Time Settings.....	669
Eye Diagram Display.....	670
Eye Diagram Settings.....	672
Frequency Deviation vs Time Display.....	673
Frequency Deviation vs Time Settings.....	675
Magnitude Error vs Time Display.....	676
Magnitude Error vs Time Settings.....	678
Phase Error vs Time Display.....	679
Phase Error vs. Time Settings.....	680
Signal Quality Display.....	681
Signal Quality Settings.....	686
Symbol Table Display.....	687
Symbol Table Settings.....	688
Trellis Diagram Display.....	689
Trellis Diagram Settings.....	691
GP Digital Modulation Shared Measurement Settings.....	692
Source Selection.....	692
Standard Settings Button.....	694
Modulation Params Tab.....	695
Freq & BW Tab.....	701
Equalizer Tab.....	701
Advanced Params Tab.....	703
Find Tab.....	706
Analysis Time Tab.....	707
Trace Tab.....	708
Scale Tab.....	710
Prefs Tab.....	711
Symbol Maps.....	712
Overview: User Defined Measurement and Reference Filters.....	717
User Filter File Format.....	717
Marker Measurements.....	721
Using Markers.....	721
Controlling Markers with the Right-Click Actions Menu.....	721
Measuring Frequency and Power in the Spectrum Display.....	723
Marker Action Controls.....	724
Peak.....	724
Next Peak.....	724
Marker to Center Frequency.....	725
Enabling Markers and Setting Marker Properties.....	725
Using the Markers Toolbar.....	726
Measuring Noise Using Delta Markers in the Spectrum Display.....	727
Mask Testing.....	730
The Mask Test Tool.....	730
Mask Test Settings.....	730
Define Tab (Mask Test).....	730
Actions Tab.....	735
Analyzing Data.....	737
Analysis Settings.....	737
Analysis Time Tab.....	737

Spectrum Time Tab.....	739
Frequency Tab.....	741
Units Tab.....	744
Replay Overview.....	744
Replay Menu.....	746
Acq Data.....	747
DPX Spectra.....	747
Replay All Selected Records.....	747
Replay Current Record.....	747
Replay from Selected.....	747
Pause.....	747
Stop.....	747
Select All.....	747
Select Records from History.....	747
Replay Toolbar.....	748
Amplitude Corrections.....	749
Amplitude Settings.....	749
Internal Settings Tab.....	749
External Gain/Loss Correction Tab.....	750
Controlling the Acquisition of Data.....	753
Run Menu: Continuous Versus Single Sequence.....	753
Run.....	753
Resume.....	753
Abort.....	753
Acquire.....	754
IQ Sampling Parameters.....	756
Acquisition Data.....	757
Source Configuration.....	757
MSO Settings.....	759
Advanced.....	759
Frequency Reference.....	761
Timing Reference.....	762
External Downconverter.....	764
The Recording Control Panel.....	767
Record Setup.....	767
Record.....	770
Playback.....	773
Triggering.....	776
Trigger configuration.....	776
Trigger source.....	777
Trigger type.....	780
Power trigger.....	780
Frequency Mask trigger.....	781
Mask Editor (Frequency Mask Trigger).....	783
DPX Density trigger.....	785
Event Tab.....	786
Time Qualified Tab.....	787
Advanced Tab (Triggering).....	789
Actions Tab (Triggering).....	789

Trigger save and status.....	790
Global Synchronization Settings.....	791
Measurement Settings	792
Source Settings.....	792
Channel Settings.....	793
GNSS and Antenna Features.....	795
How to set up GNSS.....	795
How to use the Antenna feature.....	797
How to use Map It.....	802
Configure In/Out and IQ Streaming.....	805
IQ Streaming overview.....	805
IQ Streaming API.....	806
40 GbE IQ Streaming Ethernet.....	807
IQ Streaming LVDS.....	808
Signal Database and Channel Navigation.....	811
How to use the Signal Database.....	811
Channel Navigation toolbar.....	814
Signal Classification.....	816
Overview.....	816
Signal Survey toolbar.....	823
Managing Data, Settings, and Pictures.....	828
Saving and Recalling Data, Settings, and Pictures.....	828
Data, Settings, and Picture File Formats.....	836
Printing Screen Shots.....	841
Reference.....	842
Application Help.....	842
About the Vector Signal Analysis Software.....	842
Mapping Measurements.....	843
Main menu overview.....	843
File Menu.....	845
Recall.....	845
Save / Save As.....	846
Measurement Data Info.....	847
Acquisition Data.....	848
Print.....	849
Print Preview.....	849
View Menu.....	849
Full Screen.....	851
Status Bar.....	851
Run Menu.....	853
Replay Menu.....	854
Markers Menu.....	854
Setup Menu.....	854
Presets Menu.....	855
Tools Menu.....	855
Alignments.....	856
Battery Status tab.....	857
Connect menu.....	858
Window menu.....	859

Help Menu.....	860
PI Command Search tool.....	860
Favorites bar menus.....	861
Error and Information Messages.....	862
Displaying the Windows Event Viewer.....	867
How to Find Out if Software Upgrades are Available.....	868
Settings.....	868
Glossary.....	872
Accuracy.....	872
ACLR.....	872
ACPR Measurement.....	872
Acquisition.....	872
Analysis Length.....	872
Analysis Time.....	872
ASK.....	872
Block.....	872
Calibrator.....	872
Carrier.....	873
Carrier Frequency.....	873
Carrier Signal.....	873
Carrier-to-Noise Ratio (C/N).....	873
CCDF - Complimentary Cumulative Distribution Function.....	873
CDMA.....	873
Center Frequency.....	873
Check Mark Indicator.....	873
CISPR.....	873
CW.....	874
CW Signal.....	874
DANL.....	874
dBfs.....	874
dBm.....	874
dBmV.....	874
dBuV.....	874
Decibel.....	874
Detection.....	874
Display Reference Level.....	874
Distortion.....	875
Dynamic Range.....	875
EVM.....	875
Export.....	875
FastFrame.....	875
FFT.....	875
Filter.....	875
FM.....	875
Frame.....	875
Frequency.....	875
Frequency Band.....	876
Frequency Domain View.....	876
Frequency Drift.....	876

Frequency Range.....	876
Frequency Span.....	876
Frequency Settling Time.....	876
GPIB.....	876
Graticule.....	876
Grayed Out.....	876
I/Q.....	876
IF.....	877
Import.....	877
Impulse Response.....	877
Input Impedance.....	877
LISN.....	877
Local Oscillator (LO).....	877
Marker.....	877
Max Hold.....	877
MCPR (Multiple Carrier Power Ratio).....	877
Min Hold.....	877
Modulate.....	878
Modulating Signal.....	878
Modulation.....	878
Noise.....	878
Noise Bandwidth (NBW).....	878
Noise Floor.....	878
Open (Recall).....	878
OQPSK.....	878
Phase Settling Time.....	878
PM.....	878
Primary Marker.....	879
PSK.....	879
QAM.....	879
Real-Time Analysis.....	879
Real-Time Bandwidth.....	879
Real-Time Seamless Capture.....	879
Reference Level.....	879
Residual FM (Incidental FM).....	879
Residual Response.....	879
RBW.....	880
Ripple.....	880
Secondary Marker.....	880
Sensitivity.....	880
Shape Factor (Skirt Selectivity).....	880
Signal.....	880
Signal Strength.....	881
Span.....	881
Span Per Division (Span/Div).....	881
Spectrogram.....	881
Spectrum.....	881
Spectrum Analysis.....	881
Spectrum Analyzer.....	881

Contents

Spectrum Time.....	881
Spur/Spot.....	881
Index.....	882

Get Started

Welcome

This Help provides in-depth information on how to use the SignalVu-PC Vector Signal Analysis Software.

Using the signal analysis engine of the RSA5100 and RSA6100 Series real-time signal analyzer, this vector signal analysis software helps you move your analysis of acquisitions off the instrument.

SignalVu-PC allows you to connect to the RSA306B, RSA500A series, RSA600A series, RSA7100 spectrum analyzers, and 5 Series/6 Series/6 Series B/5 Series B MSO or LPD oscilloscope. Here after, this will be referred to as MSO/LPD. With Option CON installed, you can also connect to a MDO4000B/C series oscilloscope to acquire live data. Several features and settings become available in SignalVU-PC once connected to one of these instruments. These are noted where appropriate throughout this Help document.



Note: Some of the screen illustrations in this document are taken from the vector signal analysis software version that runs on the RSA5100 Series Real-time Signal Analyzers. These instruments support additional hardware-based functionality and buttons that are not present in the SignalVu™ or SignalVu-PC application.

Software and Documentation

This section contains information about software installation and licensing, product documentation, and options.

How to install product software

Available software upgrades can be downloaded from the Tektronix Web site. To see if a software upgrade is available for your product, use your browser to go to www.tek.com/software. Search by the product model number.

Applications and licenses

The SignalVu-PC product software is made up of the base software and any additionally purchased applications software (licensed optional software). The base software provides access to the standard SignalVu-PC applications. It is available for download, free of charge, from the Tektronix Web site at www.Tek.com/downloads. Once you have the base version, you can purchase licenses for optional SignalVu-PC applications or choose to activate 30-day free trials of those applications.

SignalVu-PC optional applications (purchased after December 4, 2015) are controlled via license files, rather than the previous method of installing license keys.

SignalVu-PC licenses can be associated with and stored on either your PC or any RSA300 series, RSA500 series, RSA600 series, RSA7100 spectrum analyzers, 5 Series/6 Series/6 Series B MSO and LPD. Two types of licenses (Node-locked and Floating) are available, and there are three methods to purchase them, (1) as an option to your hardware, or separately as a (2) Node-locked or (3) Floating license. Licenses are managed using the Tektronix Asset Management System (AMS) on Tek.com. If your licenses are purchased as an option to your instrument, use of the Tektronix AMS is not required for you to use them. Just connect the instrument to your PC with SignalVu-PC, and the licenses will be recognized automatically.

Tektronix is working to make it easier for you to manage the options you purchase for SignalVu-PC. If you purchase an optional license after December 4, 2015, you will set up a product license account that allows you to manage your product licenses. However, you can still activate or reactivate any options you have already purchased using the same option keys in the same way.



Note: Options purchased prior to December 4, 2015 are referred to as legacy options.

You will find the information you need to activate currently held legacy option licenses, newly purchased option licenses, and free trial licenses in the Help topics below:

- [How to activate and purchase new application licenses \(options\)](#) on page 22

- [How to activate legacy options \(application licenses\)](#) on page 28
- [How to activate options in free trial \(evaluation\) mode](#) on page 30
- [How to manage legacy option licenses](#) on page 30
- [Available application options](#) on page 31

How to activate and purchase new application licenses (options)

A variety of optional, licensed applications are available for purchase for SignalVu-PC. These licenses can be associated with and stored on either your PC or any RSA300 series, RSA500 series, RSA600 series, RSA7100 spectrum analyzers, 5 Series/6 Series/6 Series B MSO and LPD. Licenses can be purchased as an option to your hardware, or separately as a Node-locked or a Floating license.

Contact your local Tektronix Account Manager to purchase a license. If your purchased license is not ordered as an option to your instrument, you will receive an email with a list of the applications purchased and the URL to the Tektronix Product License Web page, where you will create an account and can then manage your licenses using the Tektronix Asset Management System (AMS): www.tek.com/products/product-license.

AMS provides an inventory of the license(s) in your account. It enables you to check out or check in a license and view the history of licenses.



Note: If you purchased licenses as options to the RSA7100, these licenses are pre-installed on the instrument. No activation or installation is required.

Optional applications are enabled by one of the following license types.

License type	Description
Node locked license (NL) purchased as an option to your instrument	<p>This license is initially assigned to a specific host id, which can be either a PC or an instrument. It can be reassigned to either a PC or another spectrum analyzer two times using Tek AMS.</p> <p>When associated with an instrument, this license is factory-installed on that instrument at the time of manufacture. It will be recognized by any PC operating with SignalVu-PC when the instrument is connected. However, the licensed application is deactivated from the PC if the licensed instrument is disconnected.</p> <p>This is the most common form of licensing, as it simplifies management of your applications.</p>
Node locked license (NL) purchased separately	<p>This license is initially assigned to a specific host id, which can be either a PC or an instrument. It can be reassigned to either a PC or instrument two times using Tek AMS.</p> <p>This license is delivered via email and is associated with either your PC or with an instrument when you install the license.</p> <p>This license should be purchased when you want your license to stay on your PC, or if you have an existing USB instrument on which you would like to install a license.</p>

Table continued...

License type	Description
Floating license (FL) purchased separately	<p>This license can be moved between different host ids, which can be either PCs or instruments. It can be reassociated to different PCs or instruments an unlimited number of times using Tek AMS.</p> <p>This license is delivered via email and is associated with either your PC or with an instrument when you install the license.</p> <p>This is the most flexible license and is recommended in applications where the license needs to be moved frequently.</p>

You can view a list of the currently installed application licenses and options in your product as follows:

- Select **Tools > Licenses > Manage** from the application's main toolbar.
- Select **Help > About Tektronix Real Time Signal Analyzer** to view a list of the installed options.

How to install a license

Before installing an application license, you must first have purchased one and downloaded the license to your product or a portable memory device. The following instructions include information about how to download and purchase licenses.

See [Available application options](#) on page 31

(Visit www.tek.com/products/product-license.)

1. Select **Tools> Licenses > Manage** to open the Manage Licenses window.

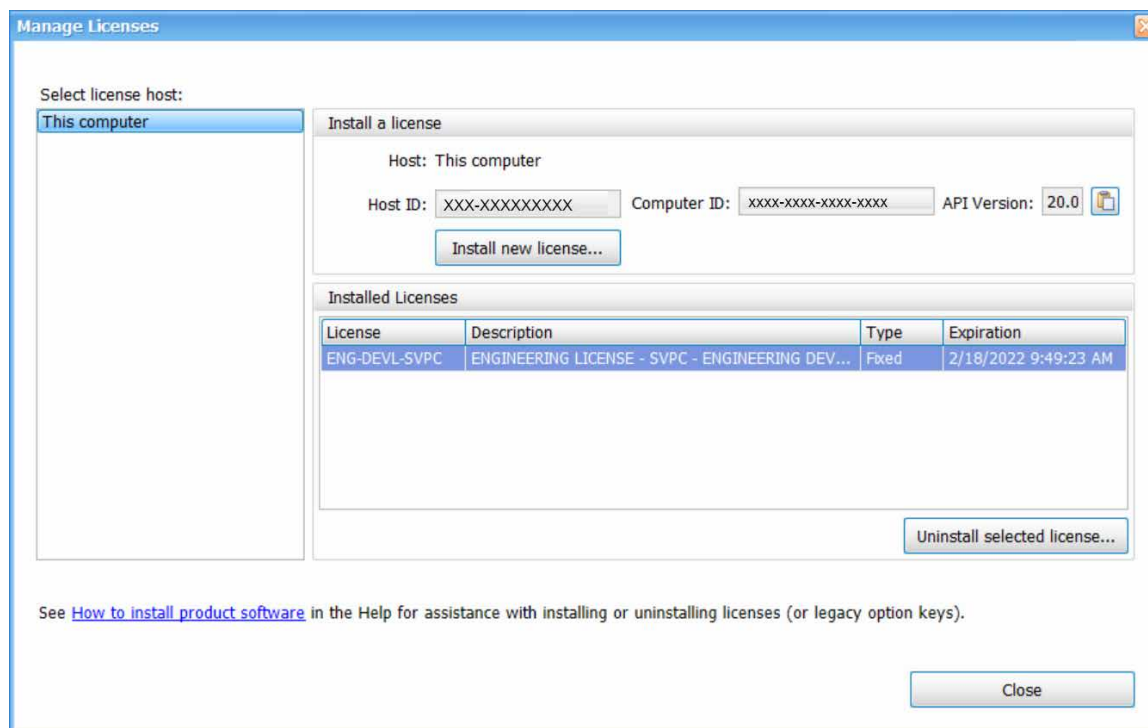

2. Select **This computer** or other license host from the list on the left side of the window. Notice that the Host ID field will populate with the ID for the selected host. Currently installed licenses associated with that host will also appear in the bottom right panel of the window under Installed Licenses.



Note: Host ID, Computer ID, and API Version fields are required for installing the 5GNR analysis plugin. To install other analysis plugins only Host ID is required.

3. If you already have a license file (*.lic) downloaded, click the **Install new license** button and navigate to the license you want to install, and then click **Open**. The license will install and appear in the Installed Licenses list. This task is now complete.
4. If the license you want to install is in your TekAMS system account, do the following:
 - a. Select the host on which you want to install the license from the **Select license host** list. For example, if you want to install the license on the computer, select **This computer**. Notice that the Host ID field on the right will populate with the ID for the selected host.
 - b. Click  to copy the host ID.



Note: To Install the 5GNR analysis plugin, Click  to copy the Host ID, Computer ID, and API Version.

- c. Navigate to the TekAMS system, log in, and enter the host ID in the appropriate field. The Tek AMS system can be accessed from a link on this page www.tek.com/products/product-license.



Note: For the 5GNR analysis plugin, enter the Host ID and Computer ID.

- d. Follow the instructions online to download the desired license file (*.lic).
 - e. Once the license is downloaded, perform step 3 on page 24 above.
5. If you do not have a license yet, do the following:
 - a. Using an Ethernet connection, navigate to www.Tek.com/products and find your product.
 - b. Click on the Additional Options tab. This tab lists all available software license options.
 - c. Find the option you want, then click on the related link to download a free trail version.
 - d. Click on the related link to request a quote.
 - e. After your purchase is complete, you will receive instructions for creating a TekAMS account to access and manage your licenses. Once your account is set up, perform step 4 on page 24 above.

How to return a license

You can return (uninstall) a license from a particular product as follows:

1. Select **Tools > Licenses > Manage** to open the Manage Licenses window.
2. In the **Manage Licenses** window, select the license you want to return.

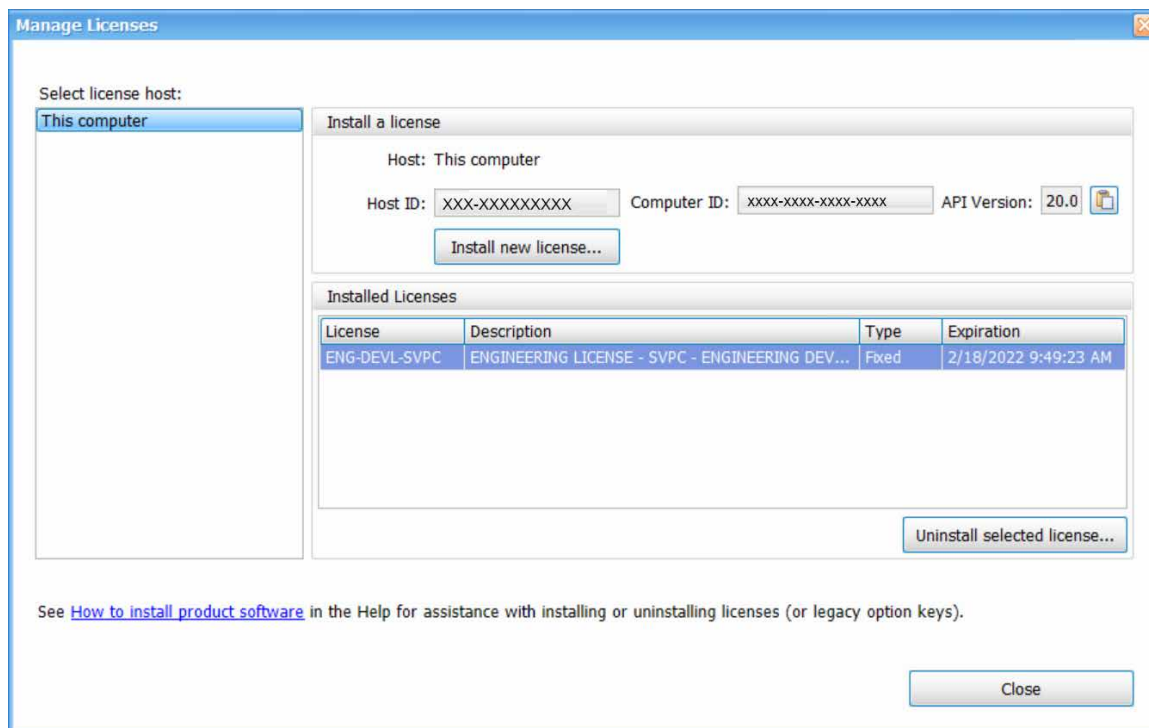

3. Click **Uninstall selected license**. The following window will appear.

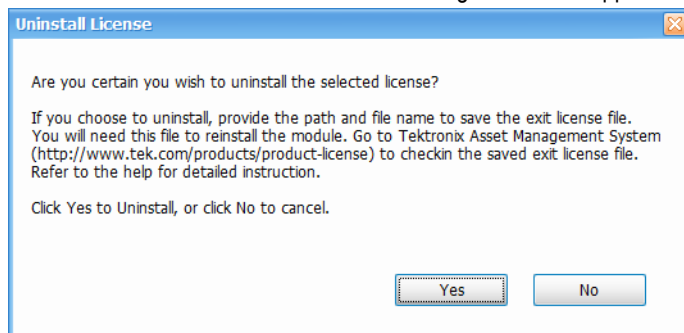

4. Click **Yes** to uninstall the license. You will then be prompted to save an exit license file. This is the file you will check into (return to) your TekAMS account.
5. Save the exit license file to the desired location.
6. Click **Close**.
7. Navigate to your TekAMS account and check in the saved exit license file.

How to move a license to a different host

You can return a purchased license and then reassign it to a different host, as indicated below. See the [Available application options](#) on page 31 topic for a list of available application licenses.

- **Node locked license (NL)**: This license type can be reassigned no more than two times. This allows you to reassign the license in the case of an upgrade to a new Windows platform, for example.

- **Floating license (FL):** This license type can be reassigned an unlimited number of times. When assigning a floating license, you need to specify the host id and the duration the feature is to be enabled on the host. After the license expires, the feature is automatically disabled on that host and the license is then available to be assigned to a different host.
- **Free trial license (FT):** This license type expires after 30 days.

See also:

www.tek.com/products/product-license

[How to install a license](#) on page 23

[How to return a license](#) on page 24

How to manage the 5GNR analysis license

After installing the SignalVu-PC 5GNR Analysis plugin, it needs to be activated on that instrument/PC/laptop. The activation requires an activation code which is 20 digit alphanumeric characters separated by a hyphen between every four characters. The following topics give procedure to activate or deactivate the 5GNR Analysis.

5GNR Analysis activation

1. Start the SignalVu-PC application.
2. On the **Tools** menu, click **Manage 5GNR Analysis Activation....** The **Manage 5GNR Analysis Activation** dialog box appears.

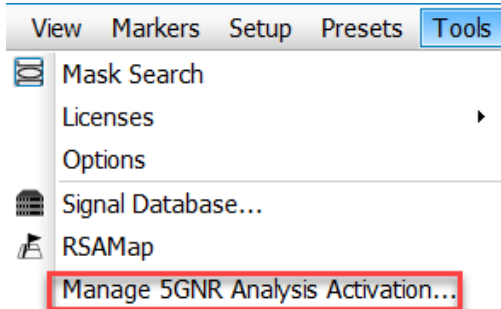

3. If you do not have the activation code, under **Activation**, click **Copy**, and then close the **Manage 5GNR Analysis Activation** dialog box.

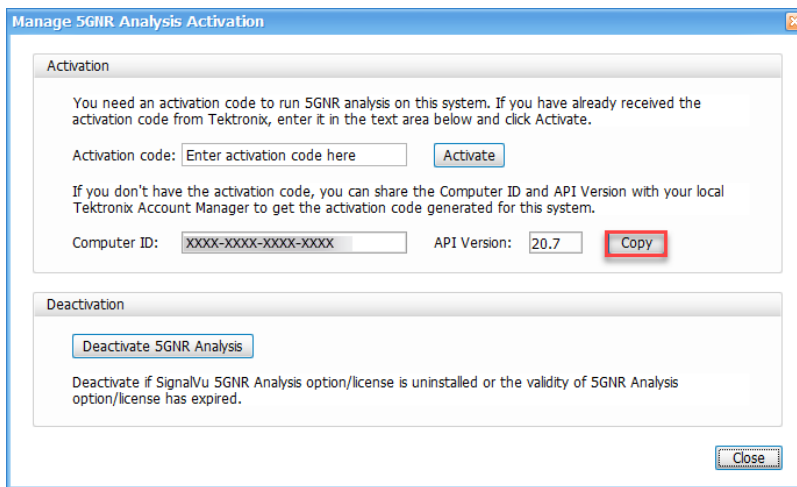



Note: Share the *Computer ID* and *API Version* that you have copied with your local Tektronix account manager to get the activation code generated for this system.

- If you have the activation code, under **Activation**, in the **Activation code** box, enter the activation code that you received from Tektronix, and then click the **Activate**.

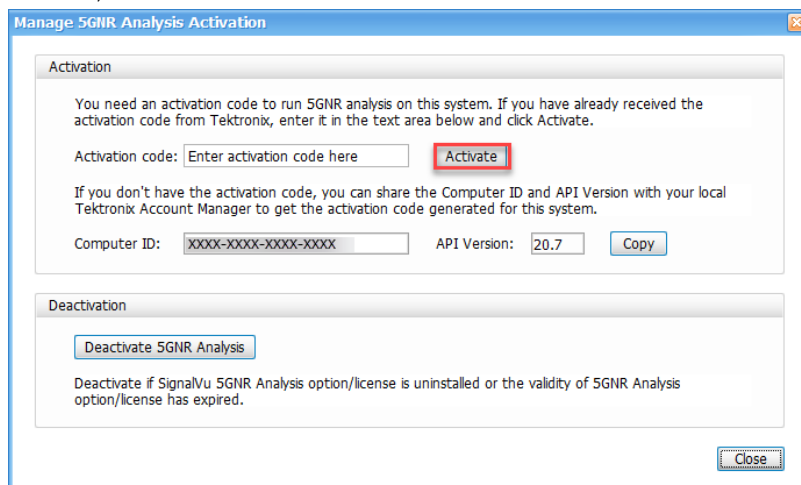

- If you receive the “5G NR Analysis activation failed. Please enter a valid activation code.” message, click **OK**, and then contact your local Tektronix support or Account Manager to get the correct activation code.

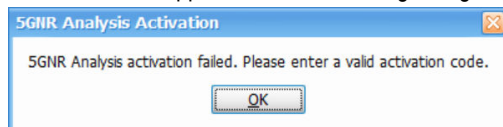

- If you receive the “5G NR Analysis activation successful” message, click **OK**.

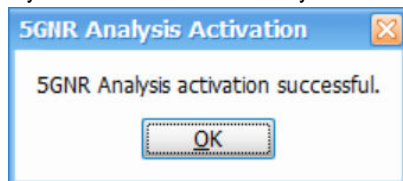

- Close the **Manage 5G NR Analysis Activation** dialog box and restart the SignalVu-PC application.

5G NR Analysis de-activation

- Start the SignalVu-PC application.
- On the **Tools** menu, click **Manage 5G NR Analysis Activation...**. The **Manage 5G NR Analysis Activation** dialog box appears.

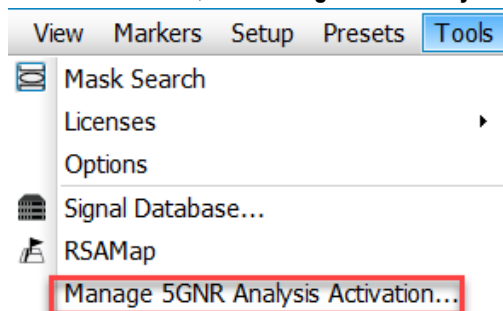

- Under **Deactivation**, click **Deactivate 5G NR Analysis**.

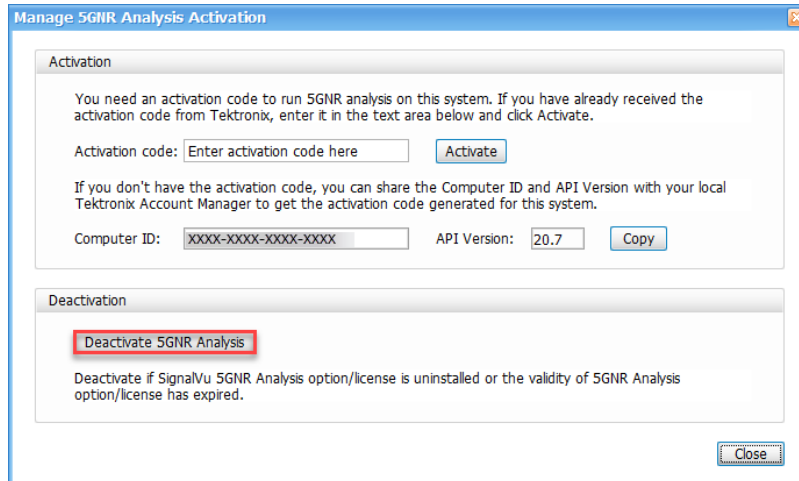

4. Click **OK** and continue with 5GNR Analysis de-activation.

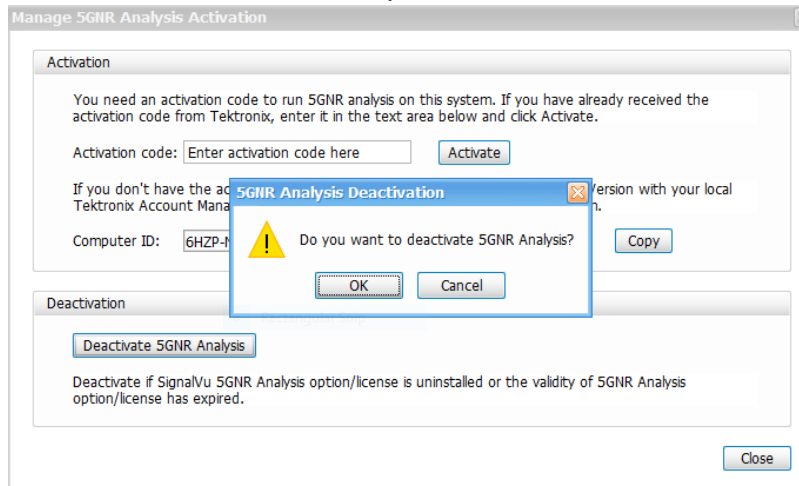

5. If you receive the “5GNR Analysis deactivation successful” message, click **OK**, and then restart the SignalVu-PC application.

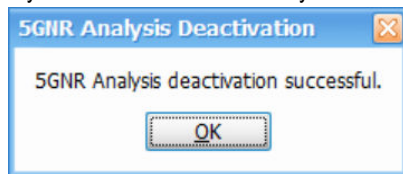

How to activate legacy options (application licenses)

Activating options requires internet access. However, you can activate options on a PC that does not have internet access by using a second PC that does have internet access to contact the license server and use it to download a license file. The license file can then be transferred to the PC on which the option is to be activated. In order to use any options you have purchased for SignalVu-PC, you must activate each option individually one of the following two ways:

To activate an option with Internet access

1. Launch the SignalVu-PC application.
2. Select **Tools > Licenses > Legacy > Activate...** to view the Activate Legacy License dialog.

3. In the dialog, select **Auto**.

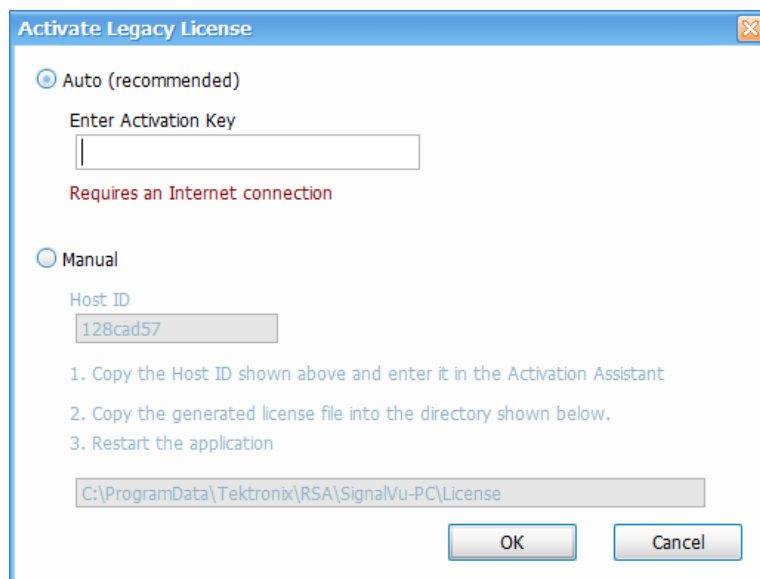

4. In the **Enter Activation Key** text box, enter the option activation key provided when you purchased the option.
5. Click **OK**. SignalVu-PC will contact the license server and install a license file provided by the license server.
6. Repeat the steps above to activate each option, using the activation key specific to each option.

To activate an option without Internet access

To activate options on a PC without internet access, you need use the Offline Activation Tool. The tool is provided with SignalVu-PC as a separate installation file.

1. Launch the SignalVu-PC application.
2. Select **Tools > Licenses > Legacy > Activate...** to view the Activate Legacy License dialog.
3. In the dialog, select **Manual**.

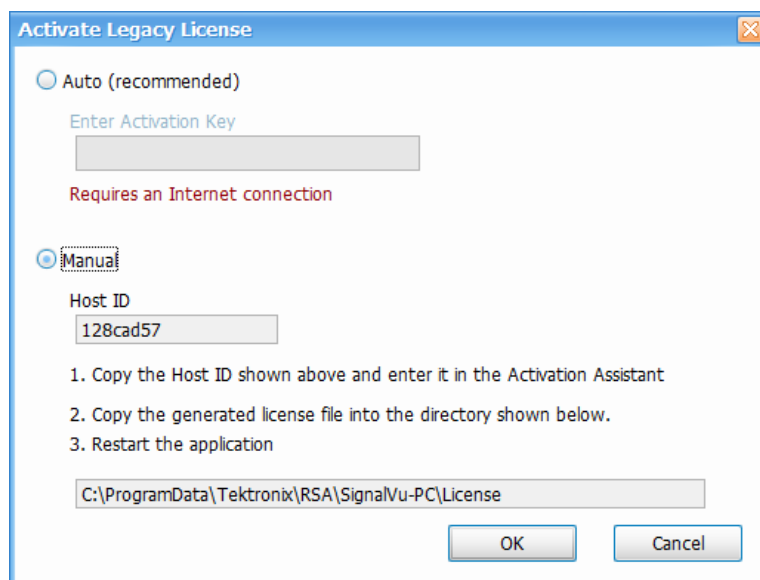

4. Write down the **Host ID** shown in your Activate Legacy License dialog, and then click **Cancel** to close the window.

5. Install the **Activation Assistant** software on a PC that has internet access.

The Activation Assistant software is located at:

- If you installed SignalVu-PC from a DVD or USB flash drive, navigate to the device, open the Offline Activation Tool folder, and run the Setup file located there.
 - If you downloaded SignalVu-PC from the Web, navigate to the location you extracted the installation files. Open the Offline Activation Tool folder and run the Setup file located there.
6. Launch the Activation Assistant application and follow the instructions to generate a license file. Repeat this step for each option that you have purchased. You will also need the option activation key you received.

Activation keys are specific to each option, therefore you must acquire a license file for each option purchased.

7. Copy the license file (or files) to the following location the PC on which SignalVu-PC is to be activated:

```
C:\ProgramData\Tektronix\RSA\SignalVu-PC\License
```

8. Restart the SignalVu-PC application.

How to activate options in free trial (evaluation) mode

If you don't have a license for one (or any) SignalVu-PC options, you can activate each option in evaluation mode for 30 days. Trial licenses are available at <https://www.tek.com/product-software-series/signalvu-pc>.



Note: Each option has its own evaluation period.

To activate an option in evaluation mode:

1. Launch **SignalVu-PC**.
2. Launch **SignalVu**.
3. Select **Tools > Licenses > Legacy > Manage...** to view the Manage Legacy License dialog.
4. Select the option you want to evaluate, and then click the **Start 30-day evaluation** button.

The Current Status box will change to display the number of days remaining for evaluation. Repeat this procedure for each of the options you wish to evaluate.

How to manage legacy option licenses

Options are licensed for use on a single PC. However, you can move SignalVu-PC and its options from one PC to another PC by deactivating each option on the current installation and reactivating them on another PC. Each activated option needs to be deactivated as follows:

1. Launch the application.
2. Select **Tools > Licenses > Legacy > Manage...** to view the Manage Legacy License dialog.
3. Use the drop-down list under Option to select one of the options that is activated.

For example: **OFDM Measurements (SignalVu-PC SVO)**.

4. Starting with each installed option, click **Deactivate License**. Continue selecting options and clicking Deactivate License until all the options have been deactivated.

The SignalVu-PC options are now deactivated. You can now install the software on another PC and activate the options in the new installation.

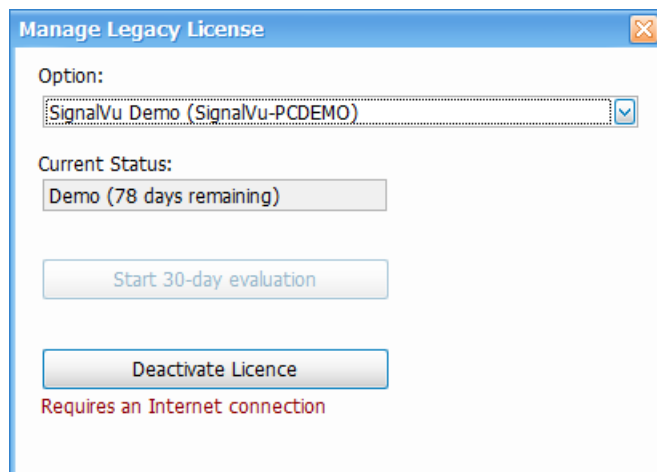

Note: You can view already installed and activated options from the **Tools > Licenses > Legacy > Manage...** window.

Available application options

The following table shows available optional applications for SignalVu-PC.

Application description	Application (option)	License type
AM/FM/PM/Direct Audio Analysis	SVANL-SVPC	Node Locked
	SVAFL-SVPC	Floating
Settling Time (frequency and phase) measurements	SVTNL-SVPC	Node Locked
	SVTFL-SVPC	Floating
General Purpose Digital Modulation Analysis	SVMNL-SVPC	Node Locked
	SVMFL-SVPC	Floating
800 MHz acquisition bandwidth (for frequencies > 3.6 GHz (RSA7100 only)	B800NL-SVPC	Node Locked
	B800FL-SVPC	Floating
Pulse Radar Analysis	SVPNL-SVPC	Node Locked
	SVPFL-SVPC	Floating
Phase Noise measurements (5/6 Series MSO and RSA7100)	PHASNL-SVPC	Node Locked
	PHASFL-SVPC	Floating
Advanced triggers (Frequency Mask, Density) (RSA7100 only)	TRIGHNL-SVPC	Node Locked
	TRIGHFL-SVPC	Floating
EMI Pre-compliance and Troubleshooting (Includes CISPR detector support on RSA306B, RSA500 series, RSA600 series, and RSA5000 series only)	EMCVUNL-SVPC	Node Locked
	EMCVUFL-SVPC	Floating

Table continued...

Application description	Application (option)	License type
Flexible OFDM Analysis	SVONL-SVPC	Node Locked
	SVOFL-SVPC	Floating
WLAN 802.11a/b/g/j/p measurements	SV23NL-SVPC	Node Locked
	SV23FL-SVPC	Floating
WLAN 802.11n measurements (Requires SV23NL-SVPC or SV23FL-SVPC)	SV24NL-SVPC	Node Locked
	SV24FL-SVPC	Floating
WLAN 802.11ac measurement to work with analyzer of acquisition bandwidth \leq 40 MHz and MDO (Requires SV23NL-SVPC or SV23FL-SVPC and SV24NL-SVPC or SV24FL-SVPC)	SV25NL-SVPC	Node Locked
	SV25FL-SVPC	Floating
WLAN 802.11ac measurement to work with analyzer of any acquisition bandwidth and MDO (Requires SV23NL-SVPC or SV23FL-SVPC and SV24NL-SVPC or SV24FL-SVPC)	SV25HNL-SVPC	Node Locked
	SV25HFL-SVPC	Floating
APCO P25 measurements	SV26NL-SVPC	Node Locked
	SV26FL-SVPC	Floating
Bluetooth measurements ¹	SV27NL-SVPC	Node Locked
	SV27FL-SVPC	Floating
Bluetooth 5 measurements ¹ (Requires SV27NL-SVPC or SV27FL-SVPC)	SV31NL-SVPC	Node Locked
	SV31FL-SVPC	Floating
Mapping	MAPNL-SVPC	Node Locked
	MAPFL-SVPC	Floating
SignalVu-PC connection to the 5/6 Series MSO oscilloscopes Live connection and base SignalVu-PC VSA measurements using the 5 or 6 Series MSO Oscilloscope (with opt. SV-RFVT); electronically downloaded canned software	CONNL-SVPC	Node Locked
	CONFL-SVPC	Floating
WLAN 802.11a/b/g/j/p/n/ac and option to connect to MDO4000B/C. (This option bundles the following: SV23NL-SVPC or SV23FL-SVPC, SV24NL-SVPC or SV24FL-SVPC, SV25NL-SVPC or SV25FL-SVPC, and CONNL-SVPC or CONFL-SVPC) Bundle of WLAN 802.11a/b/g/j/p/n/ac (SV23, SV24, and SV25) and Live Connect (CON) to 5/6 Series MSO or LPD64 (requires Opt. SV-RFVT) electronically downloaded canned software	SV2CNL-SVPC	Node Locked
	SV2CFL-SVPC	Floating
LTE Downlink RF measurements ²	SV28NL-SVPC	Node Locked
	SV28FL-SVPC	Floating
5G NR Uplink/Downlink RF Power, Bandwidth, Demodulation, and Error Vector Magnitude measurements	5GNRNL-SVPC	Node Locked
	5GNRFL-SVPC	Floating

Table continued...

¹ Bluetooth is a registered trademark of Bluetooth SIG, Inc.

² LTE is a trademark of ETSI.

Application description	Application (option)	License type
WiGig 802.11ad and 802.11ay measurements (only for offline analysis)	SV30NL-SVPC	Node Locked
	SV30FL-SVPC	Floating
EMI CISPR detectors	SVQPNL-SVPC	Node Locked
	SVQPFL-SVPC	Floating
Signal survey and classification	SV54NL-SVPC	Node Locked
	SV54FL-SVPC	Floating
Playback of recorded files (RSA500A series and RSA600A series only)	SV56NL-SVPC	Node Locked
	SV56FL-SVPC	Floating
Streaming data to RAID and 40 GbE (RSA7100 only)	STREAMNL-SVPC	Node Locked
	STREAMFL-SVPC	Floating
Streaming IQ data to a custom API application (RSA7100 only)	CUSTOM-APINL-SVPC	Node Locked
Return loss, VSWR, cable loss, and distance to fault (RSA500A series and RSA600A series only)	SV60NL-SVPC	Node Locked
	SV60FL-SVPC	Floating
Education-only version of all modules for SignalVu-PC	EDUFL-SVPC	Floating



Tip: See the [Features by product](#) on page 33 topic for more information.

Features by product

The following table lists a subset of features that may or may not be available for your analyzer when connected to SignalVu-PC. A “√” means the feature is available with the specified product. A n X means the feature is planned for a future release. Some of these features require specific options be installed. You can view a list of options for SignalVu-PC. [Available application options](#) on page 31

Feature	RSA300 Series	RSA500 Series	RSA600 Series	RSA7100 Series
Audio demodulation (listening)	√	√	√	
DPX Spectrogram (DPXogram)	√	√	√	√
Fast Frame				√
Frequency Mask Trigger				√
Phase Noise (Option PHAS-SVPC) (RSA7100 only)				√
DPX Density Trigger				√
Time Qualified Trigger				√

Table continued...

Feature	RSA300 Series	RSA500 Series	RSA600 Series	RSA7100 Series
Internal GPS		√	√	√
Playback of recorded files (Option SV56-SVPC)	√	√	√	
Playback of recorded files (external application)	√	√	√	√
Tracking generator and return loss, VSWR, cable loss, and distance to fault (Option 04 with SV60-SVPC)		√	√	

Available product documentation

In addition to this Help, the following documents are available. For the most up to date documentation, visit the Tektronix Web site www.tektronix.com/manuals.

Product documents

- **SignalVu-PC Quick Start User Manual** (Tektronix part number 077-1024-XX). This PDF document explains how to install and activate the SignalVu-PC software. The instructions also provide a brief overview of the SignalVu-PC interface to get you started. It is available for download at www.Tek.com/manuals and can also be accessed from the Help menu in the application.
- **SignalVu-PC Programmer Manual** (077-0721-XX). This PDF document provides detailed descriptions of the remote commands for the SignalVu-PC software and explains how to use the programming interface for SignalVu-PC.
- **SignalVu-PC Printable Help Document (PDF)** (077-0720-XX). A PDF file version of this Help that can be printed.
- **RSA500 Series Installation and Safety Manual** (Tektronix part number 071-3452-XX). This document explains how to install the instrument and battery, connect, and prepare the RSA500 Series instruments for use. It is available for download at www.Tek.com/manuals and is shipped as a printed manual with your instrument.
- **WFM200BA Rechargeable Battery Pack Instructions** (Tektronix part number 075-1041-XX). This document contains information for handling, storing, maintaining, recycling, and transporting the WFM200BA Li-Ion rechargeable battery pack. For use with the RSA500 Series instruments.
- **WFM200BC External Battery Charger Instructions** (Tektronix part number 071-1042-XX). This document describes how to use the WFM200BC external battery charger to recharge the WFM200BA Li-Ion battery pack. For use with the RSA500 Series instruments.
- **RSA600 Series Installation and Safety Manual** (Tektronix part number 071-3460-XX). This document explains how to install, connect, and prepare the RSA600 Series instruments for use. It is available for download at www.Tek.com/manuals and is shipped as a printed manual with your instrument.
- **RSA306B Installation and Safety Manual** (Tektronix part number 071-3483-XX). This document explains how to install, connect, and prepare the RSA306B instrument for use. It is available for download at www.Tek.com/manuals and is shipped as a printed manual with your instrument.
- **RSA7100 Quick Start User Manual** (Tektronix part number 071-3504-XX). This document explains how to install, connect, and prepare the RSA7100 instrument for use. It also contains some basic operation procedures to get you started. It is available for download at www.Tek.com/manuals and is shipped as a printed manual with your instrument.
- If you are using an RSA306B, RSA500 Series, RSA600 Series, RSA7100, or MDO4000/B or C Series instrument with SignalVu-PC, you can find more product related documents than those listed above online at www.Tek.com/manuals.

The most recent versions of the product documentation, in PDF format, can be downloaded from www.Tek.com/manuals. You can find the manuals by searching on the product name and selecting the Manuals filter.

Available demonstration guide and handbook

Available for download on www.Tek.com.

- **5G NR**

There are two documents, 5G New Radio Demonstration Guide and 5G NR AWG Handbook.

In the 5G New Radio Demonstration guide, you will learn how to analyze Uplink and Downlink frames of 5G signal using the 5G NR analysis plugin installed on SignalVu analysis software.

In the 5G NR AWG handbook, you will learn how to create 5G NR waveforms in uplink or downlink directions, single or multiple carriers at the desired center frequency.

Available demonstration guides

Available for download on www.Tek.com.

- **Interference Hunting**

This demonstration guide shows how spectrum management operators can discover and capture signals of interest, using Swept DPX, with as short as 100 us duration and 100% Probability of Intercept (POI) that would be easily hidden with traditional instruments. DPX can now be used to sweep across the entire instrument's frequency range. With traditional swept spectrum analyzers and vector signal analyzers, only 1 spectrum trace is displayed. With Swept DPX, the instrument dwells at each step to build the entire spectrum with thousands of spectrums displayed in a way that is usable for the engineers or spectrum managers.

- **EMC Precompliance and EMC testing**

With this demonstration guide, you will explore what you can do with the Tektronix USB spectrum analyzer with EMCVu. Applications range from simple frequency / amplitude measurements of RF signals to real-time and modulation analysis that provide you with a complete system view of your device under test.

- **Signal Locating**

RSA Map tool in the Tektronix RSA/SignalVu-PC/SPECMON lets you use an on-screen map to record the location and value of RSA/SignalVu-PC/SPECMON measurements. With RSA Map you can use a GPS receiver to automatically position measurements at your current location on maps with geophysical reference information. The example in this Demo guide uses a free online mapping source OpenStreetMap to capture maps. OpenStreetMap is a collaborative project to create a free editable map of the world. It can capture a map anywhere in the world and can export it in its native format, bitmap image, and embeddable HTML.

- **LTE**

In this demonstration guide, you will learn how to make LTE downlink measurements either using RSA demo board for base station transmitter tests, or using an antenna for the over-the-air signal analysis.

- **5G NR**

There are two documents, 5G New Radio Demonstration Guide and 5G NR AWG Handbook.

In the 5G New Radio Demonstration guide, you will learn how to analyze Uplink and Downlink frames of 5G signal using the 5G NR analysis plugin installed on SignalVu-PC analysis software.

In the 5G NR AWG handbook, you will learn how to create 5G NR waveforms in uplink or downlink directions, single or multiple carriers at the desired center frequency.

- **Internet of Things (IoT)**

In this demonstration guide, you will learn how to use Tektronix USB RSA to make the standard certification tests on IoT devices. Wireless technology standards are needed to ensure that products can interoperate within the ecosystem where they will be deployed. There are a number of technologies to choose from, including Wi-Fi®, Bluetooth®, ZigBee®, and LoRa®. However, to adhere to the standard, new products will need to meet qualification as defined per the standard selected. Failing qualification can mean design turns that will delay the final product release and draw additional significant development cost.

- **SignalVu-PC**

This demonstration guide is designed to help you understand the benefits of SignalVu PC for analysis of waveforms captured by Tektronix DPO/DSA/MSO Series digital oscilloscopes, MDO4000 Multi-Domain Oscilloscopes and Tektronix Real Time Signal Analyzers. Applications include: CW Tone, Wideband Radar, Hopping Waveforms, Wideband Modulation, Multi-domain oscilloscope acquisitions, AM/FM/PM/Audio Analysis, Signal Monitoring with RTSA waveforms, and WLAN 802.11ac Signal Analysis.

Video tutorials

You can browse the Tektronix YouTube channel (www.youtube.com/user/tektronix) to find video tutorials about various topics related to your product. You can also subscribe to the Tektronix YouTube channel to keep up with new postings.

Searching for topics

For example, you can watch a video tutorial about performing basic EMI testing with a spectrum analyzer, or how to use WLAN presets and connect to an MDO4000C oscilloscope. To find a video on a topic, do the following. The following image shows you what the Tektronix YouTube Channel looks like.

1. Click on the search icon located just above the video you see when the page first loads.

Note: This icon allows you to search the Tektronix YouTube channel specifically. The search icon located at the top of the page allows you to search all of YouTube.

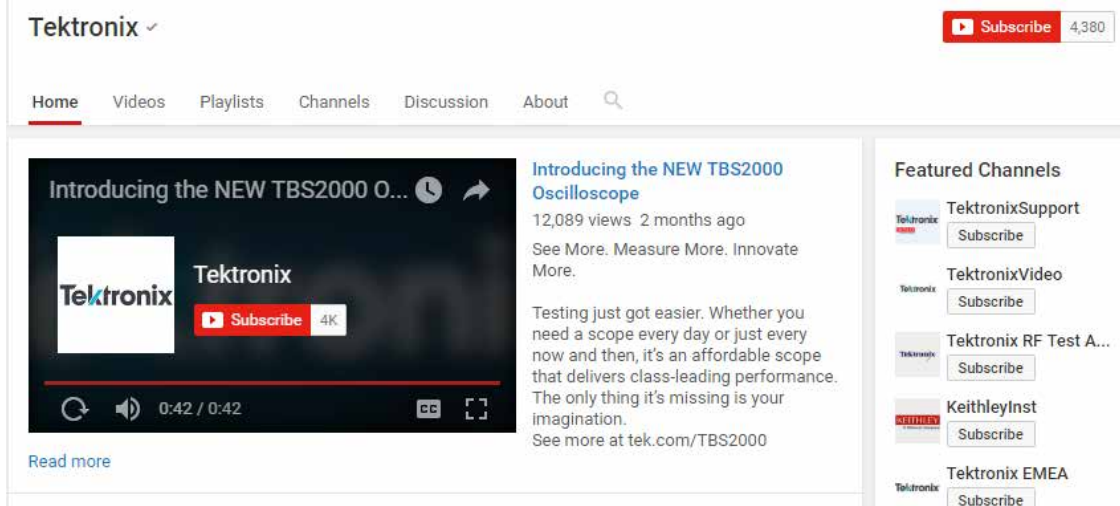

2. Type in the key phrase you are looking for in the search field. For example, "WLAN".
3. Click the search icon to start the search.
4. Videos related to the topic will appear. Click a video to view it.

Orientation

This section contains information about the SignalVu-PC software user interface.

Selecting Files for Analysis



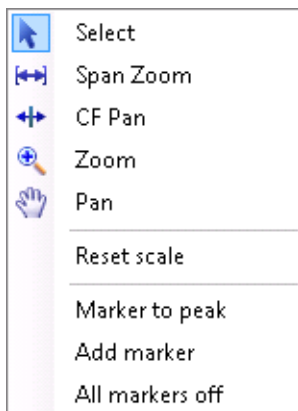

The SignalVu-PC software can analyze waveform files saved by Tektronix oscilloscopes and real-time signal analyzers. SignalVu-PC can open several file types, including .wfm, .tiq, .iqt and .mat files. For more detailed information on opening the supported file types, see [Recalling waveforms with SignalVu-PC](#) on page 829

Right-Click Action Menu

You can change marker settings and how waveforms are displayed by using the right-click Actions menu.



To use the right-click Actions menu, right-click in the graph area.

Icon	Menu	Description
	Select	Selects markers and adjusts their position.
	Span Zoom	Zooms the graph area about the selected point. Right-click in the graph display at a point of interest and drag to increase or decrease the span about the point of interest. Span Zoom adjusts the span control.
	CF Pan	Adjusts the Center Frequency according to horizontal movement.
	Zoom	Adjusts horizontal and vertical scale of the graph. The first direction with enough movement becomes the primary scale of adjustment. Adjustment in the secondary direction does not occur until a threshold of 30 pixels of movement is crossed. Dragging to the left or down zooms out and displays a smaller waveform (increases the scale value). Dragging to the right or up zooms in and displays a larger waveform (decreases the scale value).
	Pan	Adjusts horizontal and vertical position of the waveform. The first direction with enough movement becomes the primary direction of movement. Movement in the secondary direction does not occur until a threshold of 30 pixels of movement is crossed.
-	Reset Scale	Returns the horizontal and vertical scale and position settings to their default values.
-	Marker to peak	Moves the selected marker to the highest peak. If no marker is turned on, this control automatically adds a marker.
-	Add marker	Defines a new marker located at the horizontal center of the graph.
-	All markers off	Removes all markers.

SignalVu-PC Markers Menu

The SignalVu-PC Markers menu appears when you right-click on a marker. The SignalVu-PC Markers menu enables you to assign a marker to a different trace and pan the trace to place the marker at the measurement frequency.

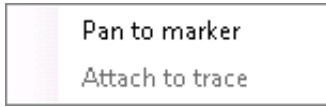

Icon	Menu	Description
-	Pan to marker	Adjusts horizontal position of the waveform to locate the selected marker at the measurement frequency.
-	Assign to trace	Assigns the selected marker to Trace 1, Trace 2, Trace 3 or the Math trace. A trace must be enabled to assign a marker to it.

Elements of the Display

General application window areas. The main areas of the application window are shown in the following figure.

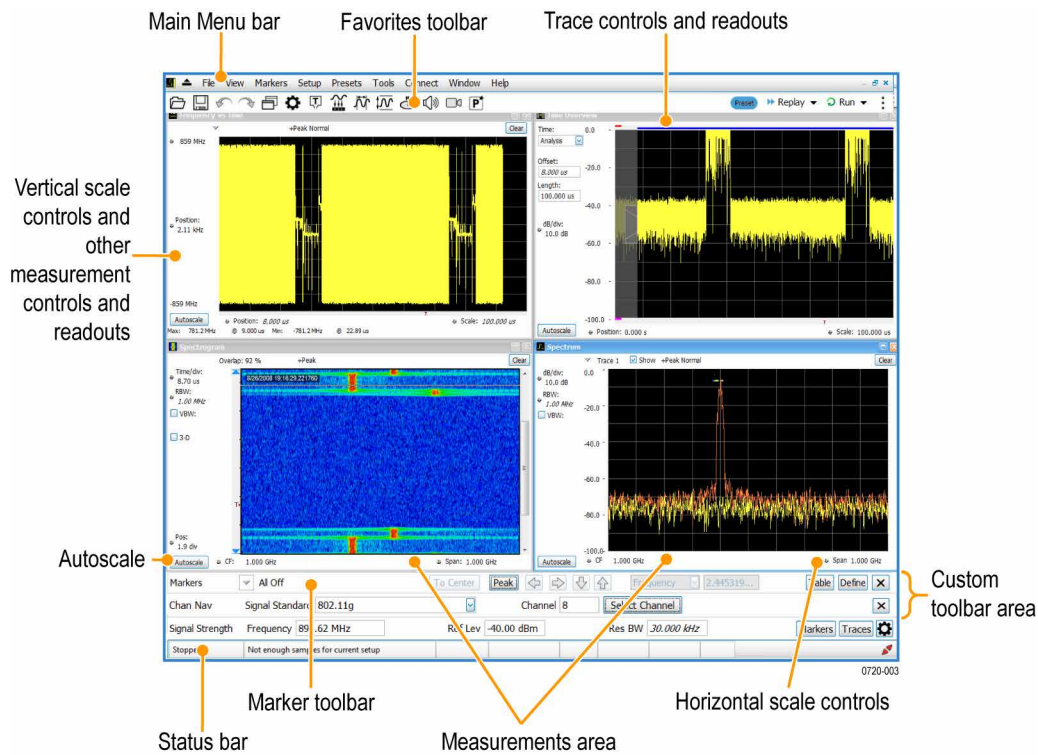

Note: If values or buttons on the application UI become truncated or displaced, you may need to adjust the Microsoft Windows display settings or custom DPI percentage setting.

Specific elements of the application display window. Specific elements of the display are shown in the following figure. More detailed information is available in the [Main menu overview](#) on page 843 section.

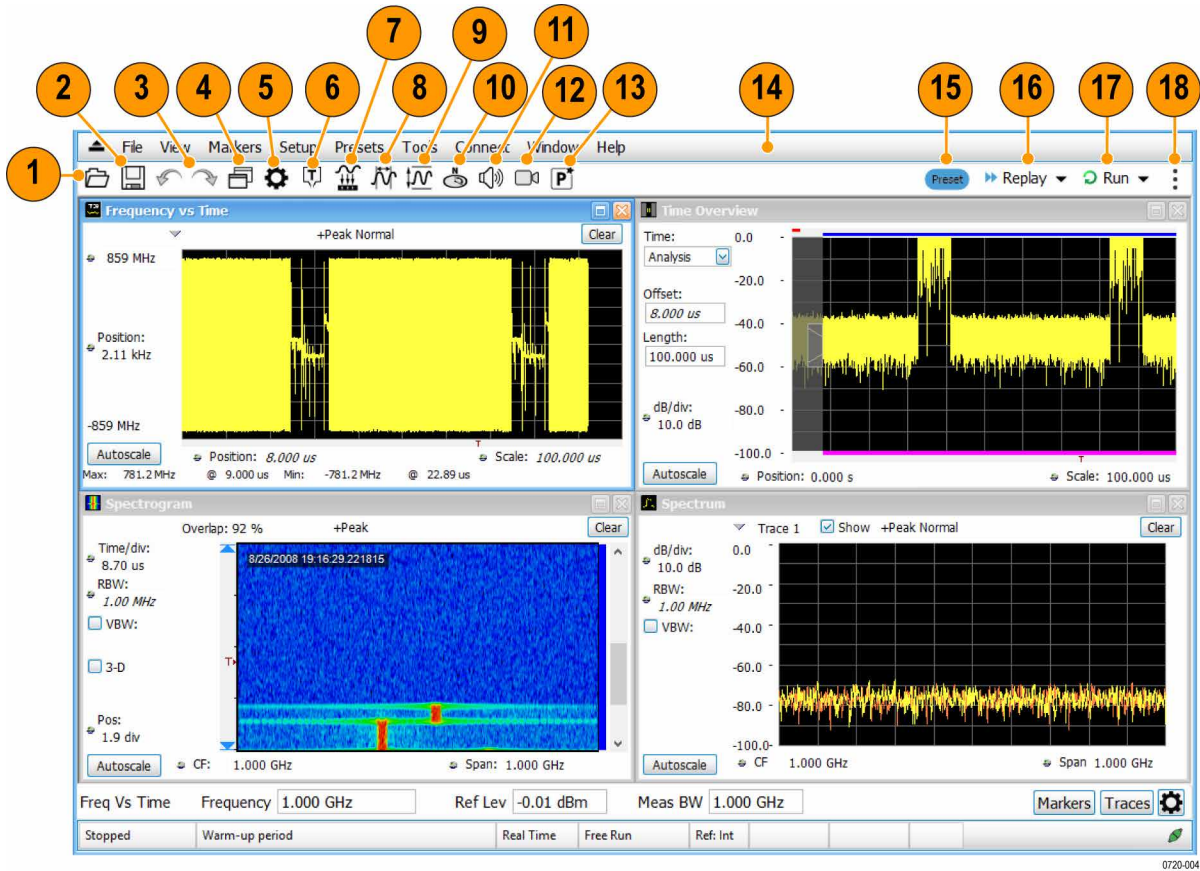

Ref number	Setting	Description
1	Recall	Displays the Open window in order to recall setup files, acquisition data files, or trace files.
2	Save	Opens the Save As dialog in order to save setup files, pictures (screen captures), acquisition data files, or export measurement settings.
3	Undo/Redo	Undoes or redoes the previous edit to a display or measurement settings, a preset, or a measurement change.
4	Displays	Opens the Select Displays dialog box so that you can select measurement displays.
5	Settings	Opens the Settings control panel for the selected display. Each display has its own control panel.
6	Trigger (Only available when connected to an RSA306, RSA306B, RSA500A series, and RSA600A series, RSA7100 series, or MDO4000B/C.)	Opens the Trigger control panel so that you can define the instrument trigger settings.

Table continued...

Ref number	Setting	Description
7	Acquire	Opens the Acquire control panel, which displays the Sample Rate and Record length of the recalled waveform file.
8	Analysis	Opens the Analysis control panel so that you can define the analysis settings such as frequency, analysis time, and units.
9	Amplitude	Opens the Amplitude control panel so that you can define the Reference Level, configure internal attenuation, and specify external gain/loss corrections.
10	GNSS/Antenna	Opens the GNSS/Antenna control panel so that you can configure and activate an internal or external GNSS receiver and antenna.
11	Audio Demodulation	Opens the Audio control panel so that you can define the audio demodulation settings for the RSA306, RSA306B, RSA500A series, RSA600A series, and RSA7100.
12	Recording	Opens the Recording control panel so that you can record and configure recording of signals. For detailed information, see the Setup Menu on page 854 topic.
13	Favorite User Presets	Click to select from a list of custom favorite User presets and load the selected preset. For more detailed information, see the Make a User preset on page 46 topic.
14	Main menu bar	Contains access to menus. For detailed information, see the Main menu overview on page 843 topic.
15	Preset	Recalls the Presets on page 42 preset.
16	Replay	Runs a new measurement cycle on the existing acquisition data record using any new settings. See the Replay Menu on page 746 topic for more details.
17	Run and Run/Stop toolbar (Only available when connected to an RSA306, RSA306B, RSA500A series, and RSA600A series, RSA7100 series, or MDO4000B/C.)	<ul style="list-style-type: none"> • Run menu and Run/Stop toolbar <p>Starts and stops data acquisitions and specifies the run conditions. For example, if you select Single in the Run/Stop toolbar (or Run Single in the Run menu), a single measurement cycle is run. If you select Continuous in the Run/Stop toolbar (or Run Continuous in the Run menu), the data acquisition runs until stopped.</p> <ul style="list-style-type: none"> • Run menu <p>The Run menu also includes Resume and Abort.</p> <p>Resume restarts data acquisition, but does not reset accumulated results, such as Average or MaxHold. This allows you to stop acquisitions temporarily, then continue.</p> <p>Abort immediately halts the current acquisition/measurement cycle. In-process measurements and acquisitions are not allowed to complete.</p> <p>See the Run Menu on page 853 topic for more details.</p>

Table continued...

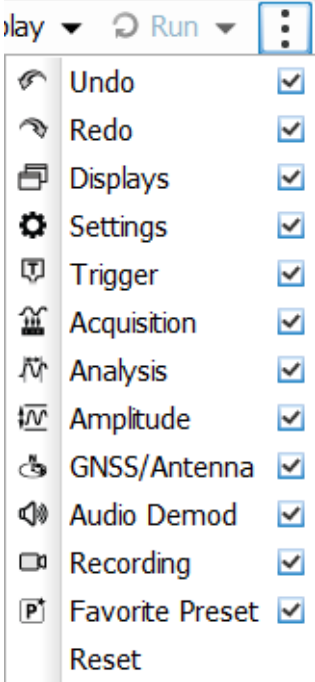
Ref number	Setting	Description
18	⋮	<p>The Edit Favorites icon allows you access the below menu, which allows you to edit the contents of the Favorites bar. For more information, see the Favorites bar menus on page 861 topic.</p> 

Restoring Default Settings

To restore the software to its factory default settings:

1. Select **Presets > Preset Options**.
2. In the Presets tab of the Options control panel, click to view the **Preset type** drop down menu and select **Main**.
3. Click to view the **Presets** drop down menu and select **Original**.
4. Click the red X icon in the top right corner of the Options control panel to close the panel.
5. Select **Presets > Main** from the menu bar to return the software to its original factory default settings.



Note: You can also click the **Preset** button on the right-hand side of the menu bar to load the Main preset.

Presets

Main menu bar: Presets

SignalVu-PC includes a set of standard configurations that are tailored to specific applications or types of analysis. These configurations, referred to as Presets, open selected displays and load settings that are optimized to address specific application requirements. You can also make your own User presets to fit your application. Any User preset can be added to the Favorites bar, enabling one-button access to your most used setups.

Preset Options

Select the **Presets > Preset Options** menu to open the Options control panel. Once you have chosen these settings, you can access any preset or list of presets from **Presets** on the menu bar.

- **Preset type:** Select the Preset type.
- **Presets:** Select the specific preset you want to display for the selected preset type.
- **Preset action:** Selecting a preset from the Preset drop down menu results in one of two actions depending on which item you choose in the **Preset action** list: **Recall selected preset** will immediately execute a preset when it is selected from the Presets menu. **Show list** will display a list of presets subtypes from which you can then select the preset you want to recall.

Available Presets

Select **Presets** from the menu bar to access the presets shown in the following table. Preset subtypes are managed in the Presets > [Preset Options](#) on page 43 menu.

Preset	Description
Main	
Current	This Preset sets the analyzer to display a Spectrum display with settings appropriate for typical spectrum analysis tasks.
Restoring Default Settings on page 42	This Preset is the original factory preset used with your original SignalVu-PC software. This version of the factory preset is included to allow you to maintain compatibility with existing remote control software.
DPX primer on page 73 (Only available when an RSA306, RSA306B, RSA500A series, RSA600A series, or RSA7100 series is connected.)	
Open the DPX display	The Open the DPX display opens the DPX display without closing existing displays.
Swept	The DPX Swept Preset displays the DPX Spectrum display with the span set to maximum and the center frequency set to 1/2 the span.
Real Time	The DPX Real Time Preset displays the DPX Spectrum display with the center frequency set to 1.5 GHz and the span set to the maximum available real-time bandwidth.
Standards	
WLAN Measurements Overview on page 279	This preset sets the analyzer to display the WLAN Summary, WLAN Constellation, and SEM displays. After you select the standards and bandwidth, the software configures these displays to apply the parameters appropriate for typical WLAN analysis tasks.

Table continued...

P25 Overview on page 480	This preset sets the analyzer to display the P25 MCPR, Summary, P25 Constellation, and Time Overview displays. After you select the standard and modulation type, the software configures these displays to apply the parameters appropriate for typical P25 analysis tasks.
Overview on page 604	This preset loads a set of Bluetooth displays and test setup to perform Bluetooth SIG RF tests. The software configures these displays to apply the parameters appropriate for Bluetooth analysis tasks.
LTE Overview on page 516	This preset loads a set of LTE displays and a test setup, frame structure, and channel bandwidth to perform LTE tests. The software configures these displays to apply the parameters appropriate for LTE analysis tasks.
5GNR Analysis	This preset loads a set of 5GNR displays and a test setup, frame structure, and channel bandwidth to perform 5GNR tests. The software configures these displays to apply the parameters appropriate for 5GNR analysis tasks.
Overview of 802.11ad and 802.11ay on page 311	This preset loads a set of standards (Control PHY and Single carrier PHY) for 802.11ad and 802.11ay for offline analysis.
Application	
Application Preset: Modulation Analysis on page 48	The Modulation Analysis setup application preset provides you with the most common displays used during modulation analysis. Only present when Option 21 is installed.
Application Preset: Pulse Analysis on page 48	The Pulse Analysis application preset provides you with the most common displays used during pulse analysis, and makes changes to the default parameters to settings better optimized for pulsed signal analysis.
Application Preset: Phase Noise on page 48	The Phase Noise application preset opens the Phase Noise display, and makes changes to the default parameters to settings better optimized for phase noise analysis. Only present when a RSA7100 connected with Option PHAS-SVPC installed.
Application Preset: Time-Frequency Analysis on page 49	The Time-Frequency preset configures the analyzer with settings suited to analyzing signal behavior over time.
Application Preset: Spectrum Analysis on page 49	The Spectrum Analysis application preset provide you with the settings commonly used for general purpose spectrum analysis.
Application Preset: Spur Search Multi Zone 9k-1GHz on page 50	The Spur Search application preset sets the analyzer to display all spurs that exceed the Threshold and Excursion values for the entire 9 kHz through 1 GHz range.
User (Favorites)	
Table continued...	

User Preset 1	This preset sets the analyzer to show these displays: Frequency vs Time, Time Overview, Spectrogram, and Spectrum. Settings commonly used for general purpose analysis are loaded.
User Preset 2	This preset sets the analyzer to show the Spurious display. Settings commonly used for spur analysis are loaded.
Interference Hunting	This preset sets the analyzer to show the DPX and Signal Strength displays.
Other user presets	User presets you create and save will appear in the Preset drop down menu of the User Presets window. Any User preset that you have designated as a Favorite will be marked with an *.

Recalling a Preset

To recall a preset, select **Presets** and then the desired preset type.



Note: You can set which presets to recall from the Presets > [Preset Options](#) on page 43 control panel.



Note: You can also click the Preset button on the top right side of the menu bar to load the Main preset.

User (Favorites) Presets

Select the **Presets > User (Favorites)** menu to open the User Presets window. The Presets drop-down list shows the three default user presets provided with the software.

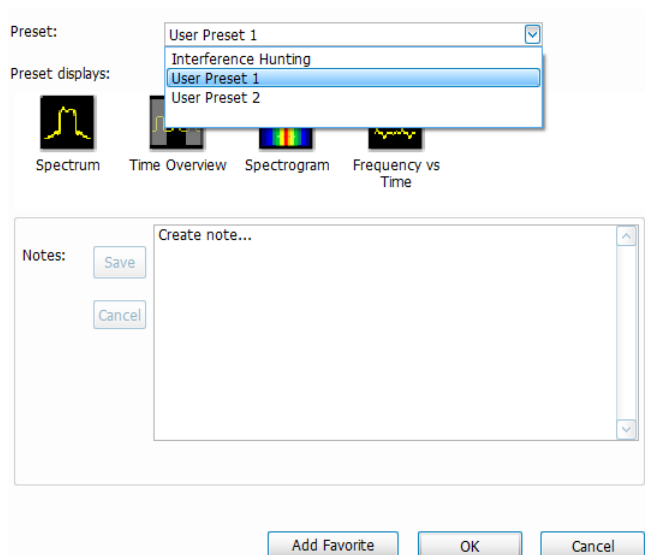

- **User Preset 1:** Sets up the Spectrum, Time Overview, Spectrogram, and Frequency vs Time displays.
- **User Preset 2:** Sets up the Spurious display.
- **Interference Hunting:** Sets up the DPX and Signal Strength displays.

Make a User preset

You can add your own User presets to the list that appears in the User Presets dialog box as follows:

1. Select **Save As** from the **File** menu to open the **Save As** dialog box.
2. Select to save to C:\SignalVu-PC Files\User Presets.
3. Enter a file name. The name you give the file will appear in the User Presets dialog box list.
4. Select the .Setup file type file from the **Save as type** drop-down list.
5. Click **Save**.

Make a User preset a Favorite preset. You can place one or more User presets on the Favorites bar as a Favorite preset for quick access. Do this as follows:

1. Select **Presets > User** to open the User Presets window.
2. Select the desired preset from the Presets drop-down list.
3. Click the **Add Favorite** button. The preset will now have an * next to it. You can do this for more than one preset.

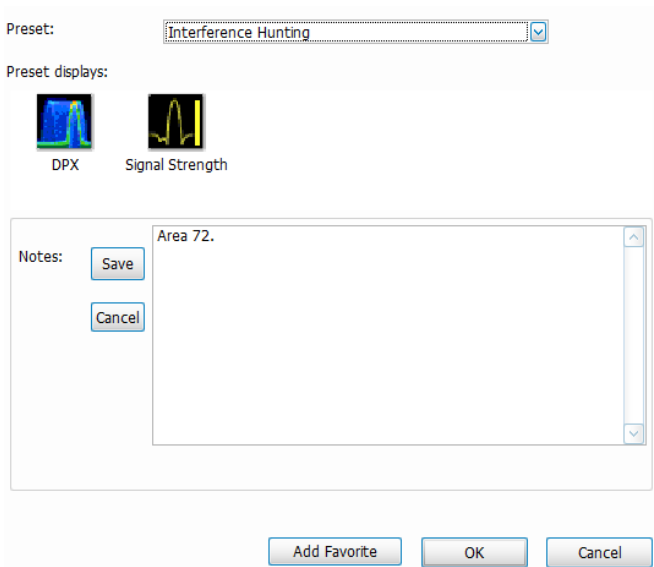

4. If desired, add a note for this preset in the Notes field and then click the **Save** button. Whenever you recall this preset, this note will appear in a separate window, as shown below.

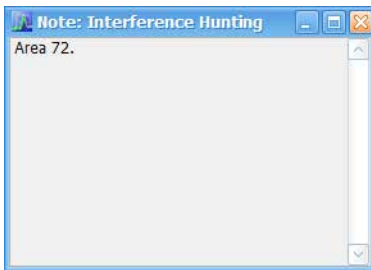

5. Click the **OK** button in the User Presets window.
6. Click on the **P*** icon on the Favorites bar and you will see the recently added Favorite preset listed.
7. When you are ready to recall a Favorite preset, click **P*** and select the preset from the list that appears.
8. To remove a Favorite preset, select it from the User Presets window and click the **Remove Favorite** button. The * should disappear from the list.

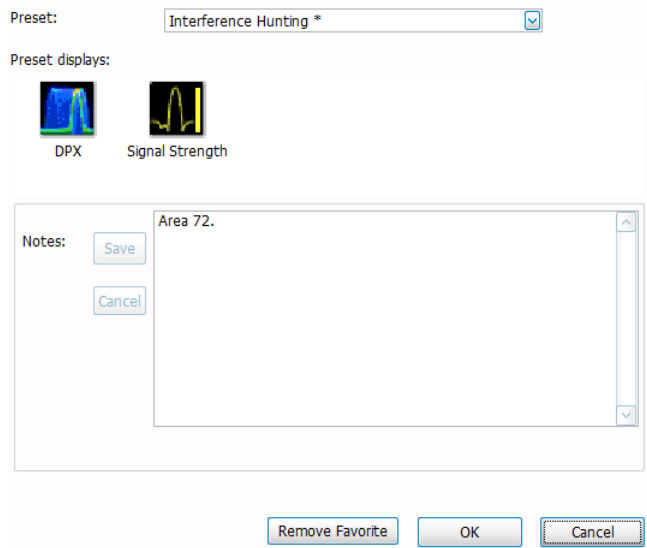

Standards Presets

The Standards presets allow you to recall preconfigured displays for the standards that you select. You can select from the following standards groups.

- **WLAN:** The IEEE wireless LAN (WLAN) standards specify the wireless interface between two wireless clients or a wireless client and a base station. The WLAN presets allow you to access displays preconfigured for the WLAN standards and bandwidths you select.



Note: More information is available about WLAN standards [WLAN Measurements Overview](#) on page 279. You can also watch a video tutorial about WLAN Presets at www.youtube.com/user/tektronix. Click [here](#) for information about searching the Tektronix YouTube channel for videos.

- **P25:** The Project 25 (P25) TIA-102 standards specify the design of interoperable digital two-way wireless communications products. The P25 presets allow you to access displays preconfigured for the P25 standards you select. You can choose either the Phase 1 (FDMA) standard or the Phase 2 (TDMA) standard.



Note: More information is available about P25 standards [#unique_29/unique_29_Connect_42_B-Overview](#) on page 480.

- **Bluetooth:** The Bluetooth standards specify short range RF signals. The Bluetooth presets allow you to access displays preconfigured for the specific Bluetooth standards you select: Basic Rate, Low Energy, and Enhanced Data Rate (EDR).



Note: More information is available about Bluetooth standards [Bluetooth Analysis](#).

- **LTE:** The LTE standards ensure that the RF signals meet 3GPP measurements specifications. The LTE presets test setups load pre-configured displays and control setting as suggested by the selected standard to accelerate the test setup of the analyzer.



Note: More information is available about LTE standards and test setups on page 516.

- **5G NR:** The 5G NR standards ensure that the RF signals meet 3GPP measurements specifications. The 5G NR presets test setups load pre-configured displays and control setting as suggested by the selected standard to accelerate the test setup of the analyzer.



Note: More information is available about 5G NR standards and test setups [5G NR Overview](#).

- **802.11ad and 802.11ay:** Supports the set of standards for 802.11ad (Control PHY and Single carrier PHY) and for 802.11ay (single carrier PHY at RF up to 70 GHz in DPO70000 DX series oscilloscopes, the DPO70000SX (with ATI) series oscilloscopes, and on personal computers running SignalVu-PC for offline analysis. The ATI oscilloscope supports real time data analysis at RF, without any downconverters.



Note: More information is available about 802.11ad and 802.11ay standards [802.11ad and 801.11ay Overview](#).

Application Preset: Modulation Analysis

The Modulation Analysis application preset opens the following displays:

- **DPX display:** Shows you a continuous spectrum monitoring of the specified carrier frequency.
- **Signal Quality:** Shows a summary of modulation quality measurements (EVM, rho, Magnitude Error, Phase Error, and others).
- **Constellation:** Shows the I and Q information of the signal analyzed in an I vs Q format.
- **Symbol Table:** Shows the demodulated symbols of the signal.

To use the Modulation Analysis preset (assuming the Preset action is set to Show list in the Presets tab of the Options control panel):

1. Select **Presets > Application**. Select **Modulation Analysis** and then click **OK**.
2. Set the measurement frequency. Your signal should appear in the DPX display.
3. Set the reference level so that the peak of your signal is about 10 dB below the top of the DPX display.
4. Set the modulation parameters for your signal. This includes the Modulation Type, Symbol Rate, Measurement Filter, Reference Filter, and Filter Parameter. All of these settings are accessed by selecting **Tools > Settings**.

For most modulated signals, the Modulation Analysis application preset should present a stable display of modulation quality. Additional displays can be added by selecting **Setup > Displays**, and other settings can be modified to better align with your signal requirements.

Application Preset: Phase Noise

The Phase Noise application preset opens the Phase Noise display. (Only available on the RSA7100 with Option PHAS-SVPC installed.)

To use the Phase Noise preset (assuming the Preset action is set to Show list in the Presets tab of the Options control panel):

1. Select **Presets > Application**. Select **Phase Noise** and then click **OK**.
2. Set the center frequency. Your signal should appear in the Phase Noise display.
3. Set the reference level so that the peak of your signal is about 10 dB below the top of the DPX display.
4. Set the modulation parameters for your signal. This includes the Modulation Type, Symbol Rate, Measurement Filter, Reference Filter, and Filter Parameter. All of these settings are accessed by selecting **Tools > Settings**.

Application Preset: Pulse Analysis

The Pulse Analysis application preset opens the following displays:

- **DPX:** The DPX display is opened with the maximum available span.
- **Time Overview:** Shows amplitude vs. time over the analysis period.
- **Pulse Table:** This shows a full report for the user-selected pulse measurements. If you want to clear the Pulse Table results for a new acquisition, open the Time Overview window and select Autoscale. This causes the pulse table to refresh.
- **Pulse Trace:** Shows the trace of the selected pulse and a readout of the selected measurement from the pulse table.

- **Pulse Cumulative Histogram:** Shows a histogram that support statistics over multiple acquisitions. It shows basic pulse measurements and has user definable bins for the cumulated pulses. It provides detailed information about the bins and its content.
- **Pulse Cumulative Statistics Table:** Shows a statistics table that provides information on Standard Deviation, Average, Max, and Min over different acquisitions.
- **Pulse-Ogram:** Shows a correlated Amplitude Time vs Time and frequency vs time display, where Y is pulse parameter, X is pulse duration, and Z is number of pulses. It shows you a definable number of stacked pulses in amplitude versus time (reference being the trigger time), as well as in amplitude versus frequency. This display will also show the information as an 'ogram, where the pulse number is being scanned over time.

You can make a selected pulse and measurement appear in the Pulse Trace display by highlighting it in the Pulse Measurement Table. Key pulse-related parameters that are set by the Pulse Analysis application preset are:

- **Measurement Filter:** No Filter-Max BW
- **Measurement Bandwidth:** This is set to the maximum real-time bandwidth of the instrument.



Note: The label on the “Measurement Bandwidth” setting is just “Bandwidth”. Like the main instrument Preset command and the other application presets, the Pulse Analysis application preset also sets most other instrument controls to default values.

- **Analysis Period:** This is set to 2 ms to ensure a good probability of catching several pulses for typical signals.
- **Power threshold to detect pulses:** This is set to -10 dBc.
- **Minimum OFF time between pulses:** This is set to 400.000 ns to ensure a good probability of catching several pulses for typical signals.
- **Max number of pulses:** Check this box to limit the number of pulses to measure.

To use the Pulse Analysis preset (assuming the Preset action is set to Show list in the Presets tab of the Options control panel):

1. Select **Presets > Application**. Select **Pulse Analysis** and then click **OK**.
2. Set the Center Frequency control to the carrier frequency of your pulsed signal.
3. Set the Reference Level to place the peak of the pulse signal approximately 0-10 dB down from the top of the Time Overview display.
You may need to trigger on the signal to get a more stable display. This is set up in the Trigger control panel. (“Trig” button). Using the Power trigger type with the RF Input source works well for many pulsed signals.
4. Set the Analysis Period to cover the number of pulses in your signal that you want to analyze. To do this, click in the data entry field of the Time Overview window and set the analysis length as needed.

Application Preset: Spectrum Analysis

The Spectrum Analysis application preset opens a Spectrum display and sets several parameters. The Spectrum Analysis preset sets the analyzer as follows.

- **Spectrum Analysis :** Sets the frequency range to maximum for the analyzer, and sets the RF/IF optimization to **Minimize Sweep Time**.

To use the Spectrum Analysis preset (assuming the Preset action is set to Show list in the Presets tab of the Options control panel):

1. Select **Presets > Application**. Select **Spectrum Analysis** and then click **OK**.
2. Set the measurement frequency using the front-panel knob or keypad.
3. Adjust the span to show the necessary detail.

Application Preset: Time-Frequency Analysis

The Time-Frequency Analysis application preset opens the following displays:

- **Time Overview:** Shows a time-domain view of the analysis time 'window'.
- **Spectrogram:** Shows a three-dimensional view of the signal where the X-axis represents frequency, the Y-axis represents time, and color represents amplitude.
- **Frequency vs. Time:** This display's graph plots changes in frequency over time and allows you to make marker measurements of settling times, frequency hops, and other frequency transients.
- **Spectrum:** Shows a spectrum view of the signal. The only trace showing in the Spectrum graph after selecting the Time-Frequency Analysis preset is the Spectrogram trace. This is the trace from the Spectrogram display that is selected by the active marker. Stop acquisitions with the Run button because its easier to work with stable results. In the Spectrogram display, move a marker up or down to see the spectrum trace at various points in time.

The analysis period (scale) is set to 5 ms.

To use the Time-Frequency Analysis preset (assuming that Time-Frequency Analysis is the selected preset on the list of Application Presets and Preset action is set to Recall selected preset):

1. Select **Presets > Application**. Select **Time-Frequency Analysis** and then click **OK**.
2. When the preset's displays and settings have all been recalled and acquisitions are running, adjust the center frequency and span to capture the signal of interest.
3. Set the Reference Level to place the peak of the signal approximately 0-10 dB down from the top of the Spectrum graph.
4. If the signal is transient in nature, you might need to set a trigger to capture it. Connect to an MDO oscilloscope or an RSA306, RSA306B, RSA500A series, RSA600A series, or RSA7100 series spectrum analyzer and use its triggering functions to capture the signal. (Option CON is required to connect to an MDO.)

When the signal has been captured, the spectrogram shows an overview of frequency and amplitude changes over time. To see frequency transients in greater detail, use the Frequency vs. Time display.

The Time-Frequency Analysis preset sets the analysis period to 5 ms. The Spectrum Span is 40 MHz. The RBW automatically selected for this Span is 300 kHz. For a 300 kHz RBW, the amount of data needed for a single spectrum transform is 7.46 μ s. A 5 ms Analysis Length yields 671 individual spectrum transforms, each one forming one trace for the Spectrogram to display as horizontal colored lines. This preset scales the Spectrogram time axis (vertical axis) to -2, which means that the Spectrogram has done two levels of time compression, resulting in one visible line for each four transforms. This results in 167 lines in the Spectrogram for each acquisition, each covering 29.84 μ s.

Application Preset: Spur Search Multi Zone 9k-1GHz

The Spur Search Multi Zone 9k-1GHz application preset opens the Spurious display, which is set to display all spurs that exceed the Threshold and Excursion values for the entire 9 k through 1 GHz range.

To use the Spur Search Multi Zone 9k-1GHz preset (assuming that Preset action is set to Recall selected preset):

1. Select **Presets > Application**. Select **Spur Search Multi Zone 9k-1GHz** and then click **OK**.
2. Click **Setup > Settings** when the preset's display and settings have all been recalled and acquisitions are running.
3. Select the **Ranges and Limits** tab in the Spurious Settings control panel to view the spur information. You can click the **Expand** button to view the table in a separate window.



Note: You can read more about the [Spurious display](#) on page 185 and its various parameters and settings in the RF Measurements section.

Setting Options

Main menu bar: Tools > Options

There are several settings you can change that are not related to measurement functions. The Option settings control panel is used to change these settings.

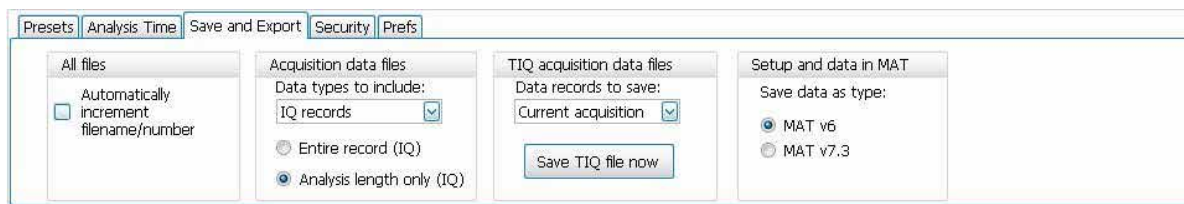

Settings tab	Description
Presets	Use this tab to configure Presets. You can select Presets and specify the action to take when a preset is recalled.
Analysis Time	Use this tab to specify the method used to automatically set the analysis and spectrum offsets when the Time Zero Reference on page 739 is set to Trigger.
Save and Export	Use this tab to specify whether or not save files are named automatically and what information is saved in acquisition data files.
Security	Selecting the Hide Sensitive readouts check box causes the instrument to replace measurement readouts with a string of asterisks.
Prefs	Use this tab to select different color schemes for the measurement graphs and specify how markers should react when dragged.

Presets

The Presets tab in the Options control panel allows you to specify actions taken when you press the Preset button. You can read more about this tab [here](#).

Analysis Time

The Analysis Time tab in the Options control panel is used to specify the method used to automatically set the analysis and spectrum offsets when the [Time Zero Reference](#) on page 739 is set to Trigger. The available settings are:

- Include trigger point – Selects an algorithm that uses the measurements to determine how far in advance of the trigger to set the analysis offset. The analyzer tries to ensure that data about the trigger point is included in the analyses.
- Start at trigger point (legacy) – The method used by the instrument in prior versions, which sets the Analysis Offset to zero when possible. The analyzer tries to ensure that data following the trigger point is included in the analyses. Use this method if your measurements or procedures depend on past behavior of the Auto Analysis Offset function.

Save and Export

The Save and Export tab allows you to specify whether or not files are saved with an automatically generated name, and how much data is saved in an acquisition data file.

All files. The **Automatically increment filename/number** function can automatically name saved files by appending a number to a base file name. Use this tab to enable/disable automatic naming of files. For example, if **Automatically Increment Filename Number** is disabled, when you select Save from the File menu, you will have to enter a name for the file.

Acquisition data files. This setting specifies whether saved data files include the entire acquisition record or only the data for the analysis length (a subset of the acquisition record).

TIQ acquisition data files. Specifies which data records to save. You can choose from the following:

- Current acquisition: Saves the current acquisition.
- Current frame: If Fast Frame is enabled, saves only the current frame. The current frame is the one most recently analyzed.
- Selected frames: If Fast Frame is enabled, saves the specified frames.
- All in history: Saves all acquisition records in the history.
- Save TIQ file now: Invokes the Save As dialog box with the Save as type drop-down list set to TIQ.

Setup and data in MAT. Specifies which MATLAB data type to save. You can choose from the following:

- MAT v6 (Level 5)
- MAT v7.3 (Level 7.3)

MATLAB Level 5 file size is limited to 2 GB. If you try to save more than 2 GB in MATLAB Level 5 (v6 format), the following warning shows and prompts you to select Level 7.3 format.



Security

The Security tab enables you to hide sensitive readouts in displays with readouts, such as the OFDM Summary display.

Prefs

The Prefs tab enables you to set properties that apply to all displays.

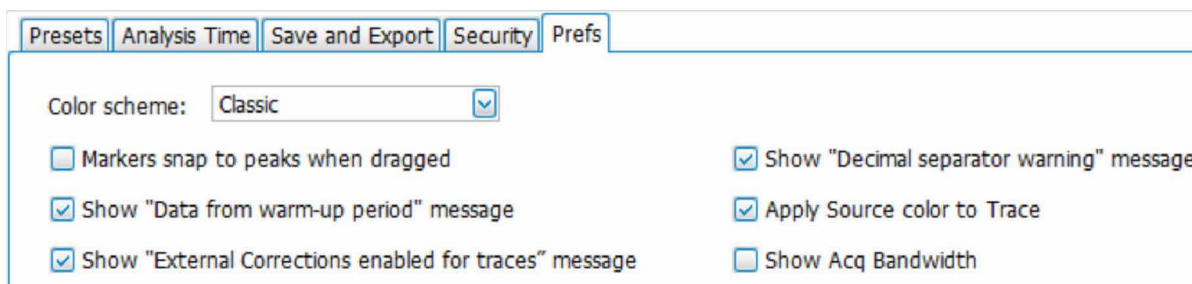

Color scheme. The Color scheme setting provides three color schemes for the measurement graphs. The color scheme setting does not change the overall instrument application or Windows color scheme.

- Thunderstorm – This scheme displays graphs in shades of blue. This provides a less vibrant color scheme than the default setting.

- Blizzard – This scheme displays graphs with a white background to save ink when printing.
- Classic – The default setting. This scheme displays the graph area with a black background.

Markers snap to peaks when dragged. When selected, this setting causes markers to automatically jump to the *next peak* when you drag them. When this setting is deselected, you can drag a marker to any point on the trace.

Show “Data from warm-up period” message. When selected, this setting allows the data warm-up message to show in the status area of the display.

Show “External Connections enabled for traces” message. When selected, this setting allows the external connections message to show.

Show “Decimal separator warning” message. When unchecked, the message that warns users that the application only supports point decimal separators is disabled. Check the box to allow the message to pop up when users enter non-point decimal separators.

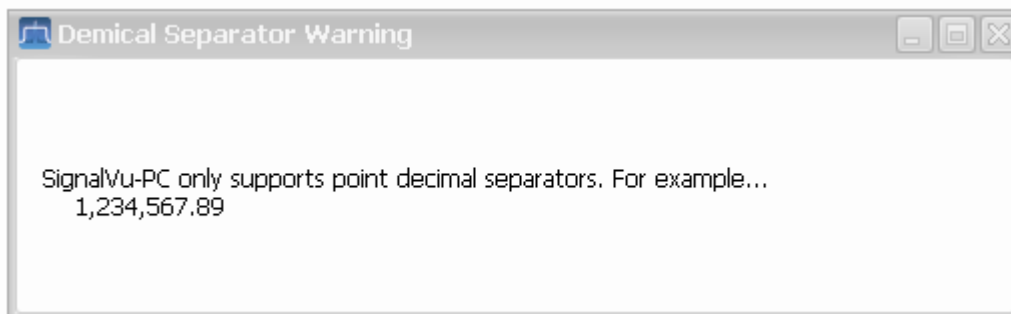

Apply Source Color to Trace

When enabled, it displays the trace 1 color as per the corresponding source color of the oscilloscope. This checkbox is applicable only for multisource setup (MSO 4/5/6 Series/LPD). By default, it is enabled. The source color label is available in the Source Configuration tab, next to the source name.



Note: This is not applicable to multi-acquisition measurements like spectrogram and DPX.

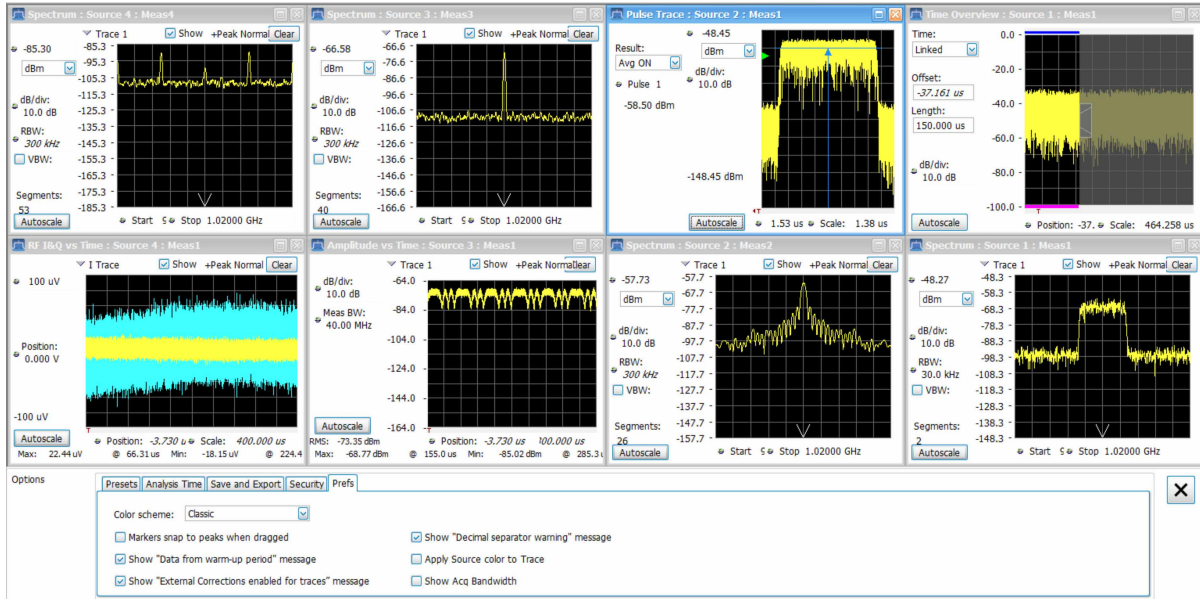

Figure 1: Measurement traces without the source color enabled.

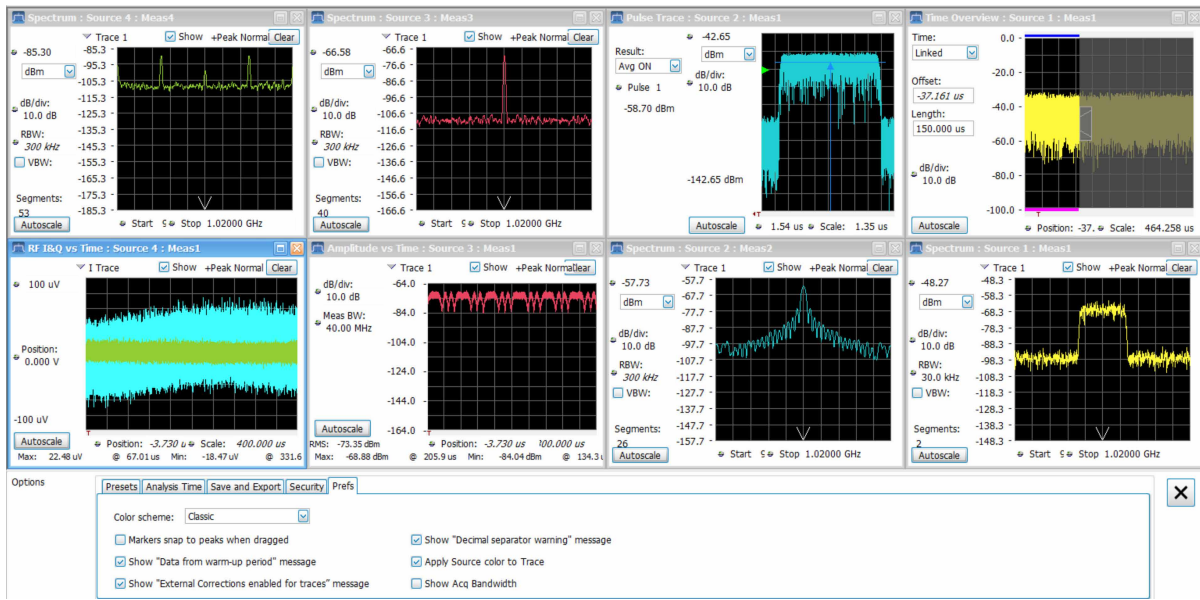

Figure 2: Measurement traces with the source color enabled.

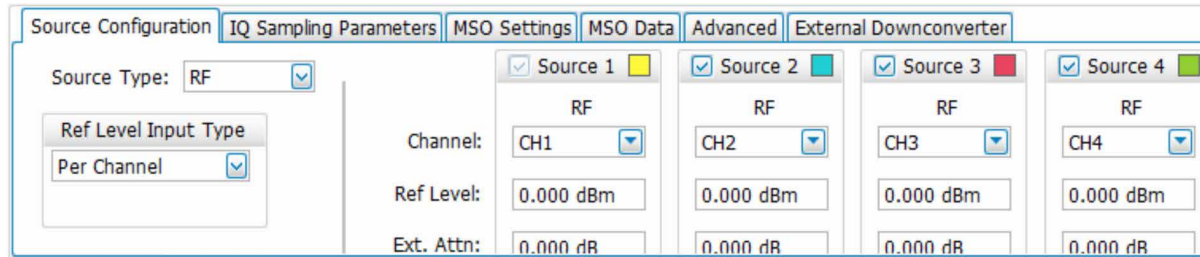

Figure 3: Source color labels in the Source Configuration tab.

Show Acquisition Bandwidth

When enabled, it displays the acquisition bandwidth of the current setup in the spectrum measurement.

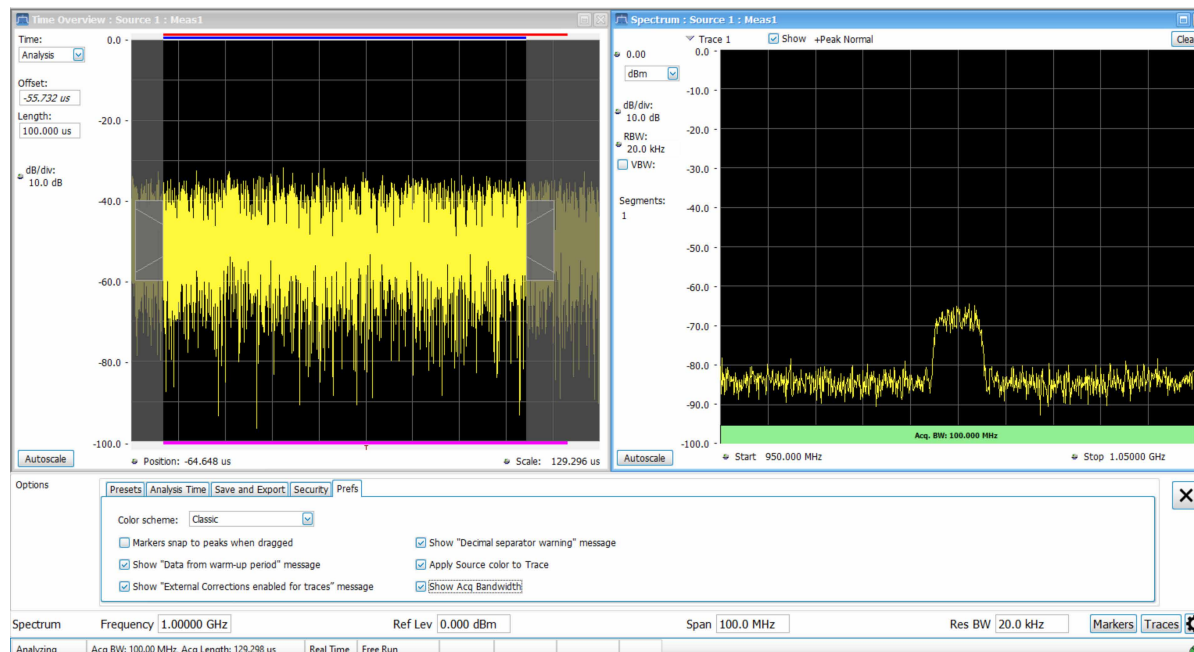

Figure 4: Acquisition bandwidth is displayed on the spectrum trace.

Connectivity

The Connect menu allows you to connect your PC (with SignalVu-PC installed) to the following instruments:

- RSA306, RSA306B, RSA500A series, and RSA600A series spectrum analyzers via USB 3.0
- RSA7100 spectrum analyzer to the CTRL7100 via PCIe port
- MDO4000B/C Series instrument via USB, wireless, or LAN (Option CON required)
- 5 Series/6 Series/6 Series B/5 Series B MSO or LPD oscilloscope.
- The 5GNR analysis plug-in is supported on Windows 10 (SignalVu-PC), 5 Series/6 Series/6 Series B MSO oscilloscope models.



Note: Multiple instruments may be connected to the PC that runs SignalVu-PC, but only one instrument at a time can be connected to SignalVu-PC.



Tip: See the [Features by product](#) on page 33 topic for more information about which features are available with which connected analyzers.



Connecting to a Spectrum Analyzer

USB3 connection. Establishing a connection to an RSA306, RSA306B, RSA500A series, and RSA600A series is as simple as connecting the USB cable from the PC to the RSA, either before or after starting the SignalVu-PC application. During the connection process, SignalVu-PC indicates that it is finding and connecting to the instrument. Please wait for the connection process to complete before using the software.



Note: Your PC may notify you that it has found a new USB device and has loaded the device drivers. If you see these notifications, wait until the drivers are loaded before continuing.

PCIe connection. Establishing a connection to an RSA7100 is as simple as connecting the PCIe cable from the CTRL7100 to the RSA and then powering on the controller. The controller automatically turns on the RSA and launches the SignalVu-PC application.

The SignalVu-PC application always monitors the ports. Anytime an RSA is discovered, a connection is immediately established causing the Connect status indicator to turn green (). Disconnecting the RSA from the PC also disconnects the SignalVu-PC application, causing the Connect status indicator to turn red ().

If the SignalVu-PC application is already connected to another instrument (either USB, PCIe, or network), an automated connection will not take place. In this situation, do the following:



1. Select **Disconnect From Instrument** to end the existing connection.
2. Select **Connect To Instrument**. You should see the USB connected RSA in the instrument list.
3. Select the instrument.



Note: RSA306 devices require SignalVu-PC version 3.4.0253 or higher. RSA306B devices require SignalVu-PC version 3.7.01xx or higher. The latest version of software is available from the Tektronix web site www.Tek.com/downloads.

4. A Connect Status dialog box will appear to confirm the instrument is connected and SignalVu-PC can receive live data from the instrument.



Note: You can quickly verify connection status by looking at the **Connected** indicator icon. It is green () when an instrument is connected. It is red () when it is not. You can also view the name of the instrument that is connected by hovering the pointer over the connection icon.

5. When you want to connect to a different instrument, select **Disconnect From Instrument** to end the current connection.

Connecting to an MDO4000B/C Series instrument



Note: You can watch a video tutorial about using Connect (Option CON) to connect to an MDO4000B/C Series instrument and about WLAN Presets at www.youtube.com/user/tektronix. Learn more about the Tektronix YouTube channel [here](#).

USB connection. To establish a connection using USB, perform the following procedures in the order given.

1. Check that the MDO4000B/C is on.
2. Connect a USB cable to the MDO.
3. Connect the other end of that USB cable to the PC.



Note: Your PC may notify you that it has found a new USB device and has loaded the device drivers. If you see these notifications, wait until the drivers are loaded before continuing.

4. Double click the SignalVu-PC icon on the Desktop to start the application.
5. Click **Connect** on the menu bar to view the drop down menu.



Note: See [Elements of the Display](#) on page 39 for information about menus and toolbars.

6. Select **Connect To Instrument**. You should see the USB connected MDO in the Connect To Instrument list.





Note: If the PC is currently connected by LAN or USB to another instrument, that connection will also show in the Connect To Instrument list. You must select **Disconnect From Instrument** to end that connection before connecting to the newly found instrument.

7. If you do not see the USB MDO, click **Search for Instrument**. TekVISA is now searching for instruments. A notification will briefly appear stating that the instrument was found. Check that the newly found instrument now appears in the **Connect To Instrument** list.
8. Select the instrument.

9. A Connect Status dialog box will appear to confirm the instrument is connected and SignalVu-PC can receive live data from the instrument.



Note: You can quickly verify connection status by looking at the **Connected** indicator square at the bottom of the screen. It is green () when an instrument is connected. It is red () when it is not. You can also view the name of the instrument that is connected by hovering the pointer over the .

10. Use SignalVu-PC to configure the MDO. Frequency, Amplitude, Span, Bandwidth, and Time Scaling parameters for the RF channels can only be changed using SignalVu-PC.



Note: Press F1 on your keyboard to open the SignalVu-PC help for information about configuring and using the application. You can also click on Help > User Manual in the SignalVu-PC menu bar to open the help.

11. When you are ready to connect to a different instrument, select **Disconnect From Instrument** to first end the current connection.



Note: For more search options using TekVISA, go to the Visa Resource Manager (double click in the applications tray).

LAN or wireless connection. To establish a connection using a LAN or wireless connection, perform the following procedures in the order given.

1. Check that the PC has a working LAN or wireless network connection.
2. Use an Ethernet cable to connect the MDO to the network.
3. Check that the MDO is on and wait for the IP Address to display on the screen. Write down the IP address to help you identify the MDO in the SignalVu-PC application.
4. Double click the SignalVu-PC icon on the Desktop to start the application.
5. Click **Connect** on the menu bar to view the drop down menu.



Note: See [Elements of the Display](#) on page 39 for information about menus and toolbars.



6. Select **Search For Instrument**. TekVISA is now searching for instruments.
7. A notification will briefly appear stating that the instrument was found. Check that the newly found instrument now appears in the **Connect To Instrument** list and then click on the instrument name to connect.



Note: If the PC is currently connected by LAN/wireless or USB to another MDO4000B/C, that connection will also show in the Connect To Instrument list. You must select **Disconnect From Instrument** to end that connection before connecting to the newly found instrument.

8. If you do not see the LAN address of the MDO, click **Manually Search for LAN Instrument**. You will then need to enter the IP address of the MDO into the IP Address dialog box and click **Connect**.
9. A Connect Status dialog box will appear to confirm the instrument is connected and SignalVu-PC can receive live data from the instrument.



Note: You can quickly verify connection status by looking at the **Connected** indicator square at the bottom of the screen. It is green () when an instrument is connected. It is red () when it is not. You can also view the name of the instrument that is connected by hovering the pointer over the .

10. Use SignalVu-PC to configure the MDO. Frequency, Amplitude, Span, Bandwidth, and Time Scaling parameters for the RF channels can only be changed using SignalVu-PC.



Note: Press F1 on your keyboard to open the SignalVu-PC help for information about configuring and using the application. You can also click on Help > User Manual in the SignalVu-PC menu bar to open the help.

11. When you are ready to connect to a different instrument, select **Disconnect From Instrument** to first end the current connection.



Note: For more search options using TekVISA, go to the Visa Resource Manager (double click in the Windows applications tray).

Measurements

Multi-channel Analysis

The Multi-channel analysis feature is available when the SignalVu-PC is connected to MSO/LPD. The feature allows to add same measurement for different sources. This number of sources depends on the number of channels connected to MSO/LPD. Multiple incoming signals from different sources (RF/IQ/Differential IQ) can be acquired, analyzed and results can be viewed at same time in multiple displays.



Note: SignalVu-PC supports multi-channel analysis for the Pulsed RF plugin, GP Demodulation plugin measurements, and General Signal Viewing Plugin except for DPX measurement. The number of Sources depends upon the sources available in instrument.

Selecting Displays

Main menu bar: **Setup > Displays**

Favorites toolbar:



Use the **Select displays** dialog and select the **Source** to choose the displays that appear on the screen. You can add multiple displays for different sources.

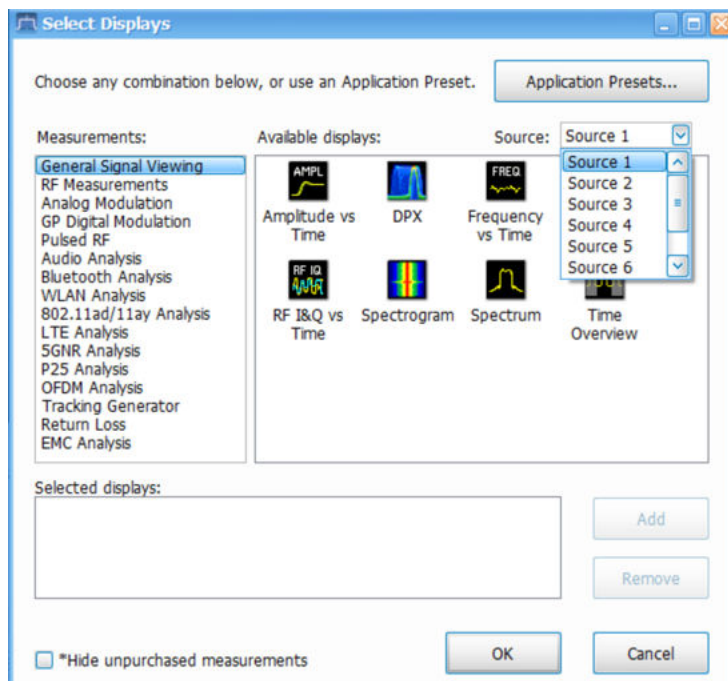

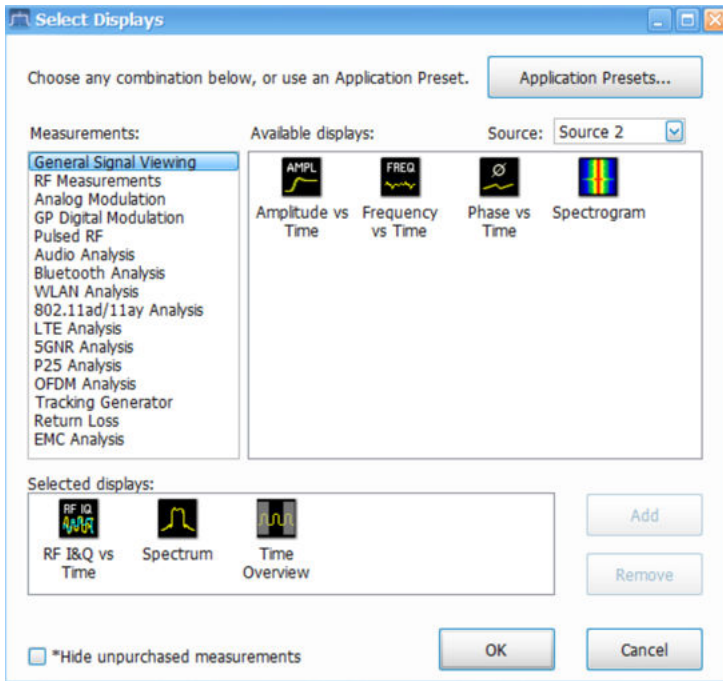
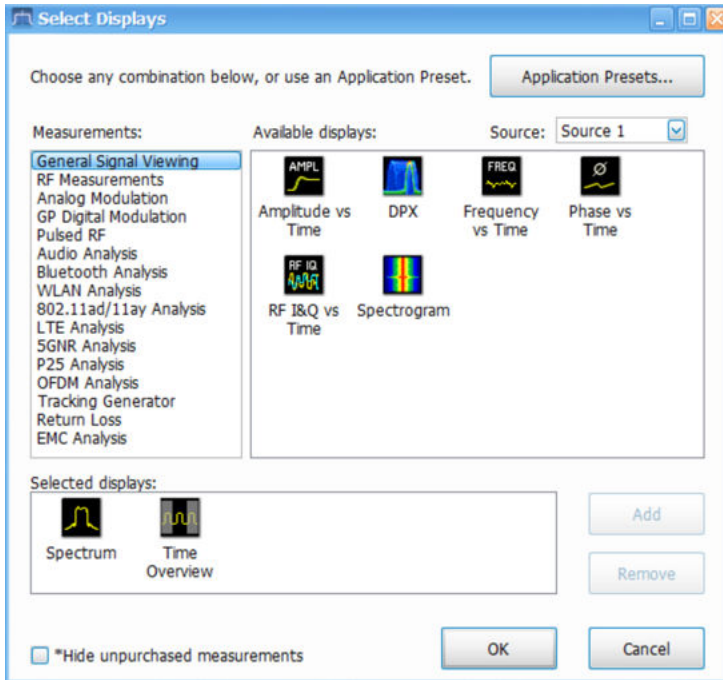

To select displays:

1. Select **Setup > Displays** or click the icon.
2. Select **Source(s)** from the drop-down list.
3. Select one of the choices under **Measurements** for the selected source. The measurement chosen determines the choices available in **Available displays** for the selected source.



Note: Tracking Generator appears under Measurements. Transmission/Gain is the related display. This display is not available for use with an RSA7100 or RSA306.

4. Double-click the desired display in the **Available displays** box or select the desired display and click **Add**.
5. Click **OK**.



Note: Display shows Instance number, Measurement Type and Source, when Measurement is added.

- Display title (Spectrum Measurement added to Source n for first time) - "Spectrum 1 (Source n)".
- Display title (Spectrum Measurement added to Source n for second time) - "Spectrum 2 (Source n)".

Interactions between Displays

Different displays require different settings to achieve optimum results. The application automatically adjusts settings to optimize them for the selected display. Depending on application settings, displays stop displaying results if not selected.

Available Measurements

Available automatic measurements include RF power measurements, OFDM analysis, WLAN analysis, APCO P25 analysis, Bluetooth analysis, LTE analysis, 5GNR analysis, 802.11ad and 802.11ay (for offline analysis only), audio analysis, analog modulation measurements, digital modulation measurements, return loss, distance to fault, and pulsed RF measurements.



Tip: See the [Features by product](#) on page 33 topic for more information about which features are available with which connected analyzers.

Power measurements

Measurement	Description
Channel Power	The total RF power in the selected channel (located in the Chan Pwr and ACPR display).
Adjacent Channel Power Ratio (ACPR)	Measure of the signal power leaking from the main channel into adjacent channels.
Signal Strength	Measure of signal strength (channel power and peak channel power).
Multi-Carrier Power Ratio (MCPR)	The ratio of the signal power in the reference channel or group of channels to the power in adjacent channels.
Peak/Avg Ratio	Ratio of the peak power in the transmitted signal to the average power in the transmitted signal (located in the CCDF display).
CCDF	The Complementary Cumulative Distribution Function (CCDF) shows how much time a signal spends at or above a given power level relative to the average power of a measured signal.

OFDM analysis

Measurement view	Description
Channel Response	Plots the channel response (magnitude or phase) versus the subcarrier or frequency. Here, the channel refers to all sources of signal frequency response impairment up to the analyzer input, including the transmitter itself, as well as any transmission medium through which the signal travels between the transmitter and the analyzer.
Constellation	Shows the WLAN signal modulation amplitude and phase in I (horizontal) versus Q (vertical) form. For multicarrier WLAN OFDM signals, the points show all data symbol subcarriers' modulation. For single-carrier 802.11b, each point corresponds to a single modulated chip.
EVM	The normalized RMS value of the error vector between the measured signal and the ideal reference signal over the analysis length. The EVM is generally measured on symbol or chip instants and is reported in units of percent and dB. EVM is usually measured after best-fit estimates of the frequency error and a fixed phase offset have been removed. These estimates are made over the analysis length. Displays RMS and Peak values with location of Peak value.
Flatness	Ratio of the peak power in the transmitted signal to the average power in the transmitted signal
Mag Error	The RMS magnitude difference between the measured signal and the reference signal magnitude. Displays RMS and Peak values with location of Peak value.
Phase Error	The RMS phase difference between the measured signal and the ideal reference signal. Displays RMS and Peak values with location of Peak value.
Power	shows the data symbols' individual subcarrier Power values versus symbol interval (time) and subcarrier (frequency).

Tracking generator measurement

Measurement	Description
Transmission Gain (Requires Option 04)	Measure the gain/loss and response of filters, amplifiers, attenuators, and other such devices.

Return loss measurements

Measurement	Description
Cable loss	Measure cable attenuation.
Return loss / VSWR	Measure return loss and VSWR on filters and antennas.
Distance to fault (DTF)	Measure distance to fault to find the fault.

WLAN measurements

Measurement view	Description
Channel Response	Plots the channel response (magnitude or phase) versus the subcarrier or frequency. Here, the channel refers to all sources of signal frequency response impairment up to the analyzer input, including the transmitter itself, as well as any transmission medium through which the signal travels between the transmitter and the analyzer.
Constellation	Shows the WLAN signal modulation amplitude and phase in I (horizontal) versus Q (vertical) form. For multicarrier WLAN OFDM signals, the points show all data symbol subcarriers' modulation. For single-carrier 802.11b, each point corresponds to a single modulated chip.
EVM	The normalized RMS value of the error vector between the measured signal and the ideal reference signal over the analysis length. The EVM is generally measured on symbol or chip instants and is reported in units of percent and dB. EVM is usually measured after best-fit estimates of the frequency error and a fixed phase offset have been removed. These estimates are made over the analysis length. Displays RMS and Peak values with location of Peak value.
Flatness	Ratio of the peak power in the transmitted signal to the average power in the transmitted signal
Mag Error	The RMS magnitude difference between the measured signal and the reference signal magnitude. Displays RMS and Peak values with location of Peak value.
Phase Error	The RMS phase difference between the measured signal and the ideal reference signal. Displays RMS and Peak values with location of Peak value.
Power vs Time	The signal power amplitude versus time. For 802.11b signals, the packet Power-On and Power-Down ramp times are also measured.
Summary	Shows several measurements of WLAN signal quality.
Symbol Table	Shows decoded data values for each data symbol in the analyzed signal packet. For OFDM (non-802.11b) signals, results are presented with subcarrier (frequency) indices in the horizontal dimension and symbol (time) intervals in the vertical dimension. For 802.11b signals, the Preamble, Header, and Data (PSDU) symbol values are presented sequentially, with symbol indices in the left column.

802.11ad and 802.11ay measurements

Measurement view	Description
Constellation	Shows the 802.11ad/ay signal modulation amplitude and phase in I (horizontal) versus Q (vertical) form.
EVM vs Time	Shows the EVM plotted against time in seconds or symbols. The analysis region in which the measurement is done is indicated by a purple line in the Time Overview display to indicate the region of analysis.
Symbol Table	Shows decoded data values for each data symbol in the analyzed signal packet.
Table continued...	

Measurement view	Description
Summary	Shows several measurements of 802.11ad/ay signal quality.

Digital Modulation measurements

Table 1: Measurements for all modulation types except nFSK, C4FM, OQPSK and SOQPSK

Measurement	Description
EVM	The normalized RMS value of the error vector between the measured signal and the ideal reference signal over the analysis length. The EVM is generally measured on symbol or chip instants and is reported in units of percent and dB. EVM is usually measured after best-fit estimates of the frequency error and a fixed phase offset have been removed. These estimates are made over the analysis length. Displays RMS and Peak values with location of Peak value.
Phase Error	The RMS phase difference between the measured signal and the ideal reference signal. Displays RMS and Peak values with location of Peak value.
Mag Error	The RMS magnitude difference between the measured signal and the reference signal magnitude. Displays RMS and Peak values with location of Peak value.
MER (RMS)	The MER is defined as the ratio of I/Q signal power to I/Q noise power; the result is indicated in dB.
IQ Origin Offset	The magnitude of the DC offset of the signal measured at the symbol times. It indicates the magnitude of the carrier feed-through signal.
Frequency Error	The frequency difference between the measured carrier frequency of the signal and the user-selected center frequency of the instrument.
Gain Imbalance	The gain difference between the I and Q channels in the signal generation path. Constellations with gain imbalance show a pattern with a width that is different from height.
Quadrature Error	The orthogonal error between the I and Q channels. The error shows the phase difference between I and Q channels away from the ideal 90 degrees expected from the perfect I/Q modulation. Not valid for BPSK modulation type.
Rho	The normalized correlated power of the measured signal and the ideal reference signal. Like EVM, Rho is a measure of modulation quality. The value of Rho is less than 1 in all practical cases and is equal to 1 for a perfect signal measured in a perfect receiver.

Table 2: Measurements for OQPSK and SOQPSK modulation types

Measurement	Description
EVM	The normalized RMS value of the error vector between the measured signal and the ideal reference signal over the analysis length. The EVM is generally measured on symbol or chip instants and is reported in units of percent and dB. EVM is usually measured after best-fit estimates of the frequency error and a fixed phase offset have been removed. These estimates are made over the analysis length. Displays RMS and Peak values with location of Peak value.
Offset EVM	Offset EVM is like EVM except for a difference in the time alignment of the I and Q samples. For EVM, I and Q samples are collected at the same time, for every symbol decision point (twice the symbol rate for offset modulations). For Offset EVM, the I and Q symbol decision points are time-aligned before collecting the I and Q samples. In this case, one I and one Q sample is collected for each symbol (half as many samples as the same number of symbols for (non-offset) EVM).
Phase Error	The RMS phase difference between the measured signal and the ideal reference signal. Displays RMS and Peak values with location of Peak value.
Mag Error	The RMS magnitude difference between the measured signal and the reference signal magnitude. Displays RMS and Peak values with location of Peak value.
MER (RMS)	The MER is defined as the ratio of I/Q signal power to I/Q noise power; the result is indicated in dB.
IQ Origin Offset	The magnitude of the DC offset of the signal measured at the symbol times. It indicates the magnitude of the carrier feed-through signal.
Frequency Error	The frequency difference between the measured carrier frequency of the signal and the user-selected center frequency of the instrument.
Gain Imbalance	The gain difference between the I and Q channels in the signal generation path. Constellations with gain imbalance show a pattern with a width that is different from height.
Quadrature Error	The orthogonal error between the I and Q channels. The error shows the phase difference between I and Q channels away from the ideal 90 degrees expected from the perfect I/Q modulation. Not valid for BPSK modulation type.
Rho	The normalized correlated power of the measured signal and the ideal reference signal. Like EVM, Rho is a measure of modulation quality. The value of Rho is less than 1 in all practical cases and is equal to 1 for a perfect signal measured in a perfect receiver.

Table 3: Measurements for nFSK modulation types

Measurement	Description
Peak FSK err	Peak value of the frequency deviation error at the symbol point.
RMS FSK Err	RMS value of the frequency deviation error at the symbol point.
Table continued...	

Measurement	Description
Peak Mag Err	The Peak magnitude difference between the measured signal and the reference signal magnitude.
RMS Mag Err	The RMS magnitude difference between the measured signal and the reference signal magnitude.
Freq Error	The frequency difference between the measured carrier frequency of the signal and the user-selected center frequency of the instrument.
Freq Deviation	Frequency distance from the center frequency at the symbol point.
Symbol Rate Error	This compares the user-entered symbol rate to the instrument calculated symbol rate of the analyzed signal.
Symbol Rate	When in Auto-symbol rate, the instrument calculates the symbol rate of the signal and the instrument calculates the error between the user entered value and the instrument calculated value.

Table 4: Measurements for C4FM modulation type

Measurement	Description
RMS Error Magnitude	RMS value of the frequency deviation error at the symbol point.
Carrier Frequency Error	Frequency difference between averaged signal frequency and the center frequency.
Deviation	Frequency distance from the center frequency at the symbol point.
Length	Number of symbols in the analysis area.

Analog Modulation measurements

Table 5: Measurements for AM modulation

Measurement	Description
+AM	Positive peak AM value.
-AM	Negative peak AM value.
Total AM	Total AM value, which is equal to the peak-peak AM value divided by 2.

Table 6: Measurements for FM modulation

Measurement	Description
+Pk	Positive peak frequency deviation.
-Pk	Negative peak frequency deviation.
RMS	RMS value of the frequency deviation.
Pk-Pk/2	Peak-to-peak frequency deviation divided by 2.
Pk-Pk	Peak-to-peak frequency deviation.

Table 7: Measurements for PM modulation

Measurement	Description
+Pk	Positive peak phase deviation.
-Pk	Negative peak phase deviation.
RMS	RMS value of the phase deviation.
Pk-Pk	Peak-to-peak phase deviation.

APCO P25 measurements

Measurement	Description
RF output power	Measure of RF output power when the transmitter is connected to the standard load during defined duty cycle.
Operating frequency accuracy	Measure of the ability of the transmitter to operate on its assigned frequency.
Unwanted emissions (ACPR)	Ratio of the total power of a transmitter under prescribed conditions and modulation to that of the output power that falls within a prescribed bandwidth centered on the nominal frequency of adjacent channels.
Frequency deviation	Measurement of the amount of frequency deviation that results for a Low Deviation and High Deviation test pattern.
Modulation fidelity	Measures the degree of closeness to which the modulation follows the ideal theoretical modulation determined by the rms difference between the actual deviation and the expected deviation for the transmitted symbols.

Table continued...

Measurement	Description
Symbol rate accuracy	Measures the ability of the transmitter to operate at the assigned symbol rate (4.8 kHz for Phase 1, 6 kHz for Phase 2).
Transmitter power and encoder attack time	Measures the time required for a transmitter to prepare and transmit information on the radio channel after changing state from standby to transmit (applies to conventional mode).
Transmitter power and encoder attack time with busy/idle operations	Measures the time required for a transmitter to prepare and transmit information on the radio channel after the receiving channel changes state from busy to idle.
Transmitter throughput delay	Measures the time it requires for audio changes in the microphone to be encoded and transmitted over the air.
Transient frequency behavior	Measures the difference of the actual transmitter frequency and assigned transmitter frequency as a function of time when the RF output power is switched on or off.
HCPM transmitter logical channel time alignment	Measures the ratio of total transmitter power under prescribed conditions and modulation to the peak power that falls in a prescribed bandwidth centered on the nominal frequency of the adjacent channel during the transmitter power ramping interval.

Bluetooth measurements

Measurement	Description
Modulation characteristics	Verifies that the modulation characteristics of the transmitted signal are correct. This measurement can only be done if the payload has the bit pattern 10101010 or 11110000.
Carrier frequency offset and drift	Verifies that the carrier frequency offset and carrier drift of the transmitted signal is within the specified limits for the Basic Rate and Low Energy standards. This test can be done only if the payload contains 10101010 bit pattern.
Output power	Verifies the maximum peak and average power emitted from the EUT. The standard recommends this test be done for a PRBS payload pattern.
In-band emission / ACPR	Verifies that the in-band spectral emission is within limits. The standard document recommends that this measurement be done with Hopping off, finding the integrated power in 1 MHz band (with RBW 100 kHz) in 80 channels starting from 2401 MHz to 2481 MHz. The integrated power values calculated in the adjacent channels are compared against recommended limits (except the three channels around transmitted frequency). This measurement is referred to as ACPR in the Basic Rate standards document.
20 dB bandwidth	Verifies if the emissions inside the operating frequency range are within limits. This measurement is done with Hopping off. The difference between frequency points at which the power level drops to 20 dB below the peak power of the emission is found as 20 dB bandwidth.
Frequency range	These measurements verify if the emissions inside the operating frequency range are within the limits.

Table continued...

Measurement	Description
Power density	This measurement verifies the maximum RF output power density.
Out-of-band spurious emission	This measurement can be done for FCC or ETSI masks using the Spurious display.
Relative power	Verifies the relative power in the GFSK and PSK part of the Enhanced Data Rate signal. This measurement is supported only when an Enhanced Data Rate signal is detected.

LTE measurements

Measurement	Description
Cell ID detection	The Cell ID is detected from the input LTE signal. For TDD and FDD.
Adjacent Channel Leakage Ratio (ACLR)	The Adjacent Channel integrated power is calculated and shown. The relative power compared to the reference signal is also computed. The computed power is compared against limits suggested by the selected standard and pass/fail is reported. For TDD and FDD.
Channel Power	The channel power is calculated in the channel bandwidth. For TDD and FDD.
Occupied Bandwidth	The Occupied bandwidth is calculated as bandwidth containing 99% of the total integrated power in the selected span around the selected center frequency. For TDD and FDD.
Operating Band Unwanted Emission	The power in the offset regions is calculated and presented and compared against limits set in the offset and limits table and pass/fail is reported. For TDD and FDD.
T _{OFF}	The power in off-slot region is computed and compared against selected limits. For TDD only.

5GNR measurements

Measurement	Description
Modulation Accuracy (ModACC)	It measures the deviation of the received symbol relative to the ideal transmitted symbol. The IQ data is processed to identify the OFDM Symbol boundaries and FFT is performed using the various settings under the Modulation Accuracy tab. The subcarrier data is equalized and then data and DMRS are extracted to perform various EVM measurements as per the 3GPP Spec and then used for display in Constellation Display. The Estimation tab provides advanced settings related to IQ Impairments and Frequency Offset estimation and corrections.
Channel Power (CHP)	The measurement is used to verify the maximum carrier output power across the frequency range. It includes the measurement of individual carrier power under carrier aggregation mode. The Integrated Bandwidth type can be chosen between Channel and Signal Bandwidth to include or remove the Guard Bands between carriers respectively.
Adjacent Channel Power (ACP)	It measures the power leakage from the carrier channels into the neighboring frequency channels, commonly referred to as offset channels. The RBW, sweep time, and Spectral Window can be selected from the measurement options tab. By default, 2 offset channels are enabled for measurement.
Spectral Emission Mask (SEM)	It measures the spurious emissions of a transmitter in the immediate frequency bands and compares against the limit chosen in the settings. The RBW settings and the width of the bands can be selected from the measurement options tab. Predefined band settings as per 3GPP are also provided in the options.
Occupied Bandwidth (OBW)	The OBW is the bandwidth containing 99% of the total integrated power of the transmitted spectrum, centered on the assigned channel frequency.
Error Vector Magnitude (EVM)	The EVM vs Symbol or EVM vs Time will give the EVM of OFDM symbols present in the number of symbols considered or the time within a slot.
Power vs Time (PVT)	The PVT measurement measures the time domain power dynamics of the NR signal.

Pulse measurements

Measurement	Description
Average ON Power	The average power transmitted during pulse on.
Peak Power	Maximum power during pulse on.
Average Transmitted Power	The average power transmitted, including both the time the pulse is on and the time it is off, and all transition times.
Pulse Width	The time from the rising edge to the falling edge at the -3 dB / -6 dB level (50%) of the user selected 100% level. Level is user selectable for Volts or Watts.
Rise Time	The time required for a signal to rise from 10% to 90% (or 20% to 80%) of the user selected 100% level.
Fall Time	The time required for a signal to fall from 90% to 10% (or 80% to 20%) of the user selected 100% level.
Repetition Interval	The time from a pulse rising edge to the next pulse rising edge.
Repetition Rate	The inverse of repetition interval.

Table continued...

Measurement	Description
Duty Factor (%)	The ratio of the width to the pulse period, expressed as a percentage.
Duty Factor (Ratio)	The ratio of the pulse width to the pulse period.
Ripple	<p>Ripple is the peak-to-peak ripple on the pulse top. It does not include any preshoot, overshoot, or undershoot. By default, the first 25% and the last 25% of the pulse top is excluded from this measurement to eliminate distortions caused by these portions of the pulse.</p> <p>If the Amplitude units selected in the Amplitude panel (affects all amplitude measurements for the analyzer) are linear, the Ripple results will be in %Volts. For log units, the Ripple results will be in %Watts. The default for the general Units control is dBm, so the Ripple results default is %Watts.</p> <p>See also Ripple on page 880.</p>
Ripple dB	The Ripple measurement expressed in dB.
Droop	Droop is the power difference between the beginning and the end of the pulse On time. A straight-line best fit is used to represent the top of the pulse. The result is a percentage referenced to the Average ON Power.
Droop dB	The Droop measurement expressed in dB.
Overshoot	The amount by which the signal exceeds the 100% level on the pulse rising edge. Units are %Watts or %Volts.
Overshoot dB	The Overshoot measurement expressed in dB.
Pulse-ref-Phase Difference	The phase difference between the current pulse and the first pulse in the analysis window. The instantaneous phase is measured at a user-adjustable time following the rising edge of each pulse.
Pulse-ref Freq Difference	The difference between the frequency of the current pulse and frequency of the previous pulse. The instantaneous frequency is measured at a user-adjustable time following the rising edge of each pulse.
RMS Freq Error	The RMS Frequency Error measurement is the RMS average of the Freq Error vs. Time trace, computed over the Measurement Time.
Max Freq Error	The maximum frequency error is the difference between the measured carrier frequency of the signal and the user-selected center frequency of the analyzer.
RMS Phase Error	The RMS Phase Error measurement is the RMS average of the Phase vs Time trace, computed over the Measurement Time.
Max Phase Error	The phase is measured at each point during the pulse's ON time. The phase error for each point is the difference between the measured phase value and the calculated ideal phase value. After the phase error is calculated for all points in the acquisition record, the largest error in the positive direction and the largest in the negative direction are determined. Whichever of these two values has the greater absolute value is designated the Max Phase Error.

Table continued...

Measurement	Description
Freq Deviation	The Frequency Deviation measurement is the difference between the maximum and minimum measured values of the signal frequency during the Measurement Time.
Phase Deviation	The Phase Deviation is the difference between the maximum and minimum Phase values measured during the ON time of a pulse.
Impulse Response Amplitude	The difference in dB between the levels of the main lobe and highest side lobe.
Impulse Response Time	The difference in time between the main lobe and highest side lobe.
Absolute Frequency	The absolute pulse frequency measured at a point specified by the user. The measurement includes carrier frequency as well. The measurement point should be within the pulse width, starting from the 50% point.
Pulse-Pulse Frequency Difference	The difference between the frequency of the current pulse and frequency of the previous pulse. The instantaneous frequency is measured at a user-adjustable time following the rising edge of each pulse.
Pulse-Pulse Phase Difference	The phase difference between the selected pulse and the first pulse in the analysis window. The instantaneous phase is measured at a user-adjustable time following the rising edge of each pulse.

General Signal Viewing

Multiple incoming signals from different sources (RF/IQ/Differential IQ) can be acquired when connected to MSO/LPD. The results can be viewed at the same time in multiple displays.

Overview

The displays in General Signal Viewing (**Displays > Source > Measurements > General Signal Viewing**) are:

- Amplitude vs Time
- Frequency vs Time
- Phase vs Time
- RF I & Q vs Time
- Spectrogram
- Spectrum
- Time Overview
- DPX (currently not supported for MSO/LPD)

These displays provide extensive time-correlated multi-domain views that connect problems in time, frequency, phase and amplitude for enabling you to more quickly understand cause and effect when troubleshooting.



Tip: See the [Features by product](#) on page 33 topic for more information about which features are available with which connected analyzers.

DPX primer

The information in this section is from the Tektronix DPX Primer, available separately as an application note and for download from www.tek.com. The DPX display can detect extremely brief signals and processes many thousands of spectrums per second. It then displays all these spectrums as a color-graded bitmap that reveals low-amplitude signals beneath stronger signals sharing the same frequency at different times.

The strong signal in the DPX spectrum graph, shown in the [Figure 5](#) on page 73 below, is a repeating pulse at a fixed frequency. There is also a lower-power CW signal that steps very quickly through the same span. During the pulse's on time, the power of the two signals is additive, resulting in nearly undetectable differences in the pulse envelope shape. But during the time the pulse is off, the sweeping signal is detected and shown in its true form. Both signals are visible in the bitmap because at least one full cycle of their activities occurs within a single DPX display update.

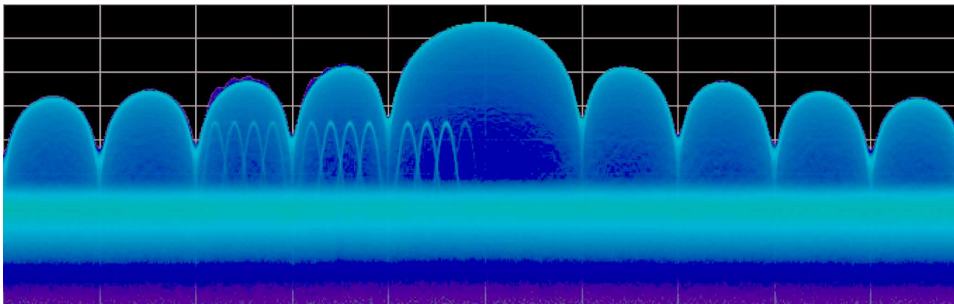

Figure 5: DPX spectrum graph

Compare the [Figure 6](#) on page 74 display of a traditional swept spectrum analyzer figure and that of a [Figure 7](#) on page 74. The signal captured is a typical WLAN interchange between a nearby PC and a more-distant network access point (AP). The laptop signal is nearly 30 dB stronger than the AP's signal because it is closer to the measuring antenna.

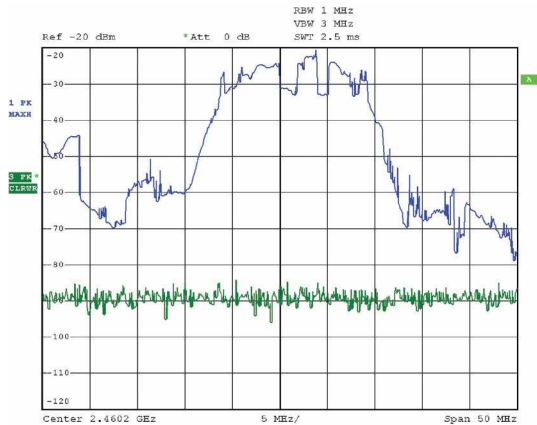

Figure 6: Display of a traditional swept spectrum analyzer

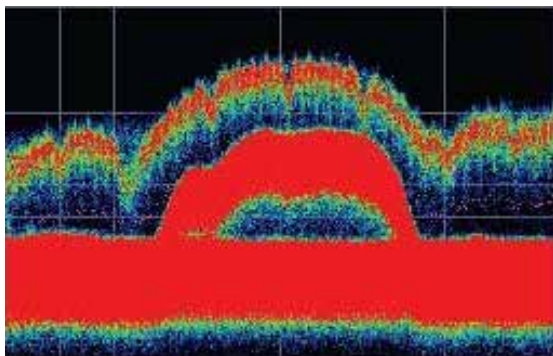

Figure 7: Real-time signal analyzer with a DPX display

The [Figure 6](#) on page 74, uses line traces that can show only one level for each frequency point, representing the largest, the smallest or the average power. After many sweeps, the Max Hold trace shows a rough envelope of the stronger laptop signal. +Peak detection was selected for the other trace in an attempt to capture the weaker but more frequent AP signal, but the bursts are very brief, so the likelihood of seeing one in any particular sweep is small. It will also take a long time to statistically capture the entire spectrum of a bursted signal due to the architecture of the swept spectrum analysis.

The [Figure 7](#) on page 74, reveals much more insight on the same signal. Since it is a bitmap image instead of a line trace, you can distinguish many different signals occurring within each update period and/or different version of the same signal varying over time. The heavy band running straight across the lower third of the graph is the noise background when neither the laptop nor the AP is transmitting. The red lump of energy in the middle is the ON shape of the AP signal. Finally, the more delicate spectrum above the others is the laptop transmissions. In the color scheme used for this demonstration (“Temperature”), the hot red color indicates a signal that is much more frequent than signals shown in cooler colors. The laptop signal, in yellow, green and blue, has higher amplitude but doesn't occur nearly as often as the AP transmissions because the laptop was downloading a file when this screen capture was taken.

How DPX works

This section explains how DPX displays are created. The input RF signal is conditioned and down-converted as usual for a signal analyzer, then digitized. The digitized data is processed in SignalVu-PC, creating very fast spectral transforms. The resulting frequency-domain waveforms are rasterized to create the bitmaps.

The DPX bitmap that you see on screen is composed of pixels representing x, y, and z values for frequency, amplitude, and Density. A multi-stage process, shown in the following four figures, creates this bitmap, starting with analog-to-digital conversion of the input signal.

Simplified Flow of Multi-stage Processing from RF Input Through to Spectrum Processing:

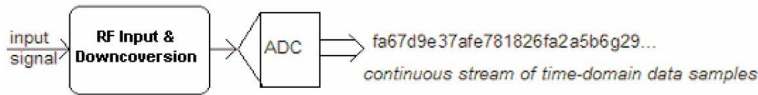

Figure 8: RF signals are downconverted and sampled into a continuous data stream.



Figure 9: Samples are segmented into data records for FFT processing based on the selected resolution bandwidth.



Figure 10: Data records are processed in the DPX transform engine

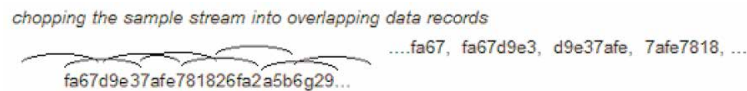

Figure 11: Overlapping the FFTs shortens the minimum event duration required for 100% probability of intercept.

Collecting spectral data. Sampling and digitization is continuous. The digitized data stream is chopped into data records whose length is based on the desired resolution bandwidth (RBW). An additional requirement is placed on FFT length by the desired number of points in a trace. The DPX transform engine performs a discrete Fourier transform on each record, continually producing spectral waveforms.

As long as spectral transforms are performed faster than the acquisition data records arrive, the transforms can overlap each other in time, so no events are missed in between. Minimum event length for guaranteed capture depends on the length of the data records being transformed. An event must last through two consecutive data records in order for its amplitude to be accurately measured. Shorter events are detected and visible on screen, but may be attenuated. The DPX Spectrum RBW setting determines the data record length; narrow RBW filters have a longer time constant than wide RBW filters. This longer time constant requires longer FFTs, reducing the transform rate.

The spectral waveforms are plotted onto a grid of counting cells called the “bitmap database”. The number held by each database cell is the z-axis count. For simplicity, the small example grid used in the following grids is 11x10, so our spectral waveforms will each contain 11 points. A waveform contains one (y) amplitude value for each (x) frequency. As waveforms are plotted to the grid, the cells increment their values each time they receive a waveform point.

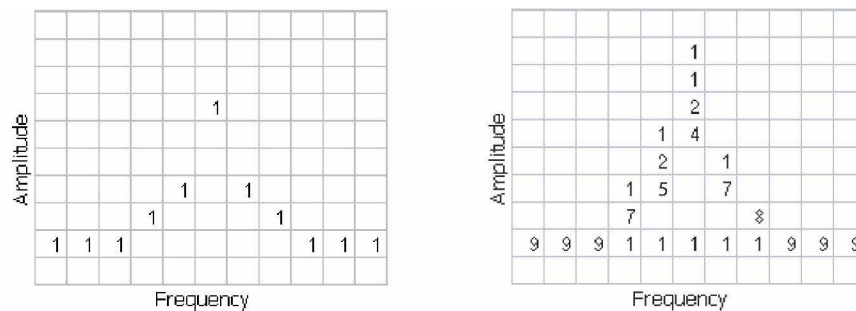

Figure 12: Example 3-D Bitmap Database after 1 (left) and 9 (right) updates. Note that each column contains the same total number of “hits”.

The grid on the left shows what the database cells might contain after a single spectrum is plotted into it. Blank cells contain the value zero, meaning that no points from a spectrum have fallen into them yet.

The grid on the right shows values that our simplified database might contain after an additional eight spectral transforms have been performed and their results stored in the cells. One of the nine spectrums happened to be computed as a time during which the signal was absent, as you can see by the string of “1” occurrence counts at the noise floor.

Frame updates. The maximum rate for performing the variable-length frequency transforms that produce those waveforms can be greater than 292,000 per second. Measurement settings that slow this transform rate include narrowing the RBW and increasing the number of points for the line traces available in the DPX display along with the bitmap. Even at their slowest, spectral transforms are performed orders of magnitude faster than a physical display can respond, and also too fast for humans to see, so there's no need to update the screen or measurements at this rate. Instead, the grid collects thousands of waveforms into "frames", each covering about 50 milliseconds (ms). A 50 ms frame contains the counts from up to 14,600 waveforms. After each frame's waveforms have been mapped into the grid, the cell occurrence counts are converted to colors and written to the DPX bitmap, resulting in a bitmap update rate of around 20 per second.

The maximum rate for performing the variable-length frequency transforms that produce those waveforms varies with the PC you use and the length of the transform. Rates greater than 1 million transforms per second are performed with the RSA7100. Measurement settings that slow this transform rate include narrowing the RBW and increasing the number of points for the line traces available in the DPX display along with the bitmap. Even at their slowest, spectral transforms are performed orders of magnitude faster than a physical display can respond, and also too fast for humans to see, so there's no need to update the screen or measurements at this rate. Instead, the grid collects thousands of waveforms into "frames", each covering about 50 milliseconds (ms). The actual frame rate varies with resolution bandwidth and the processor used in your PC. After each frame's waveforms have been mapped into the grid, the cell occurrence counts are converted to colors and written to the DPX bitmap, resulting in a bitmap update rate of around 20 per second.

Frame length sets the time resolution for DPX measurements. If the bitmap shows that a -10 dBm signal at 72.3 MHz was present for 10% of one frame's duration (5 ms out of 50 ms), it isn't possible to determine just from the DPX display whether the actual signal contained a single 5 ms pulse, one hundred 50 microsecond (μ s) pulses, or something in between. For this information, you need to examine the spectral details of the signal or use another display with finer time resolution, such as Frequency vs. Time or Amplitude vs. Time.

Converting occurrence counts to color. About 20 times per second, the grid values are transferred to the next process step, in which the z-axis values are mapped to pixel colors in the visible bitmap, turning data into information. In this example, warmer colors (red, orange, yellow) indicate more occurrences. The color palette is user-selectable, but for now we will assume the default "temperature" palette.

Number of Occurrences	Color
0	black
1	blue
2	light blue
3	cyan
4	green blue
5	green
6	yellow
7	orange
8	red orange
9	red

The result of coloring the database cells according to the number of times they were written into by the nine spectrums, one per pixel on the screen, creates the DPX displays.

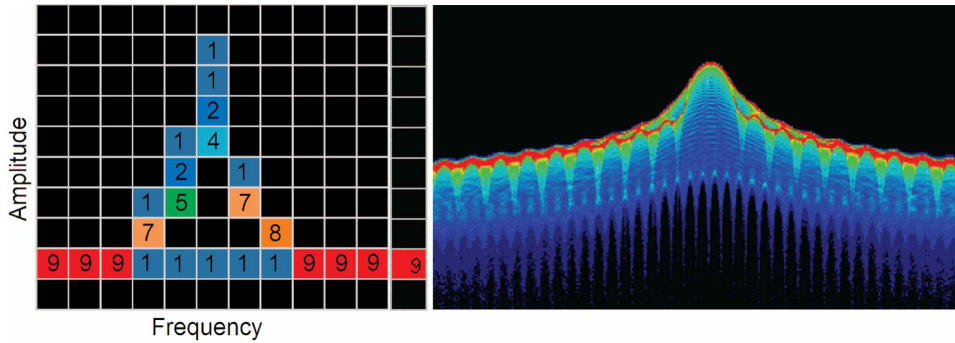

Figure 13: Color-coded low-resolution example (left) and a real DPX display (right).

In addition to the choice of palette, there are z-axis scaling adjustments for Maximum, Minimum, and Curve. Maximum sets the occurrence value that will be mapped to the highest color in the palette. Minimum sets the occurrence value for the lowest color. In the “temperature” palette, the highest color is deep red and the lowest is dark blue. Occurrence values less than the selected Minimum are represented with black pixels, while pixels that exceed the selected Maximum are red in hue but somewhat transparent. Values between Maximum and Minimum are represented by the other colors of the palette.

Adjusting the Minimum above the black default allows you to concentrate most of your color resolution over a small range of medium or higher occurrence rates to visually discriminate between different signals that have nearly equal probability values.

To see why adjustable color scaling is useful compare the following figures. On the Scale tab, the Max control is set to 100% in the first figure. The range of colors now covers the full z-axis range of densities from 0 to 100%. The signals used to create this bitmap are fairly diffused in both frequency and amplitude, so most pixels have low occurrence counts or density values and the upper half of the color palette is unused.

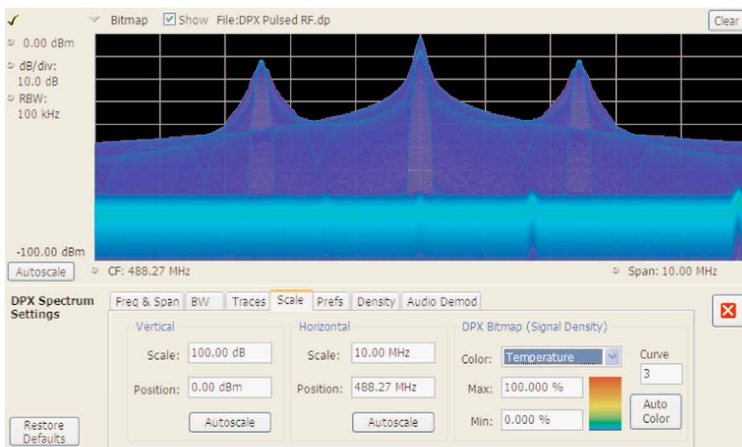

Figure 14: DPX spectrum bitmap with default color scale settings.

When the Auto Color button is selected, the Maximum control's value is set to the highest pixel value in the current bitmap, shown below. Now none of the available colors remain unused. The entire palette is mapped to the occurrence values present at the time the button is selected, providing better visual resolution for low densities. Selecting the Autoscale button in the DPX display scales all three axes based on current results.

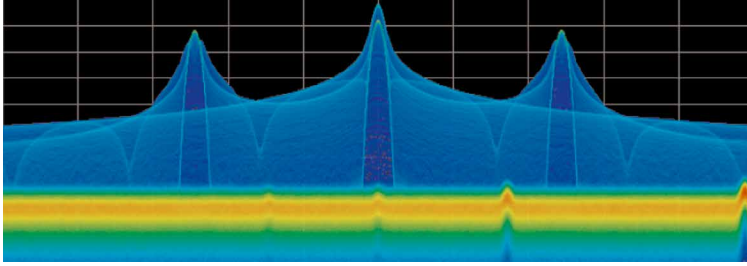

Figure 15: The Auto Color function optimizes the color scale settings

Color mapping curves

The mapping between z-axis values and color does not have to be linear. The Curve control lets you choose the shape of the mapping equation. A Curve setting of 1 selects the straight-line relationship. Higher Curve numbers pull the curve upwards and to the left, concentrating color resolution on lower densities. Settings less than 1 invert the curve, moving the focus of the color range towards higher density values. The following Figure 16 on page 78 shows the mapping curves.

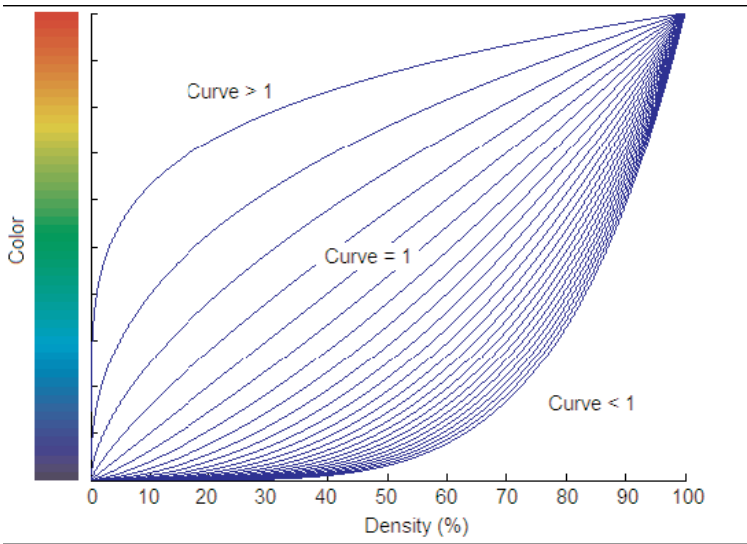

Figure 16: Representative color mapping curves for the "Temperature" palette.

Using the same signal shown in the Figure 14 on page 77 and Figure 15 on page 78, the impact of the Curve control can be observed. With the Curve control set to 1 in the Scale tab, shown in the below Figure 17 on page 78, the mapping between color and density is linear, so the colors spread evenly across the full density range. The color distribution is visible in the colored palette illustration to the left of the Curve control in the Settings panel.

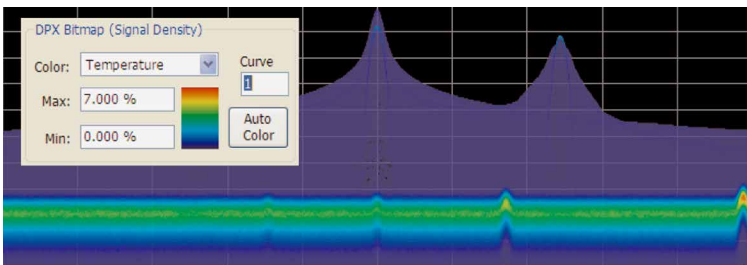

Figure 17: Over a narrow Signal Density range, the color curve is set to 1.

When the Curve control is set to 0.5, as shown in the below Figure 18 on page 79, the best color resolution is in the upper half of the density range, and only the dark blues are assigned to densities below 50%. Note the difference in the palette illustration.

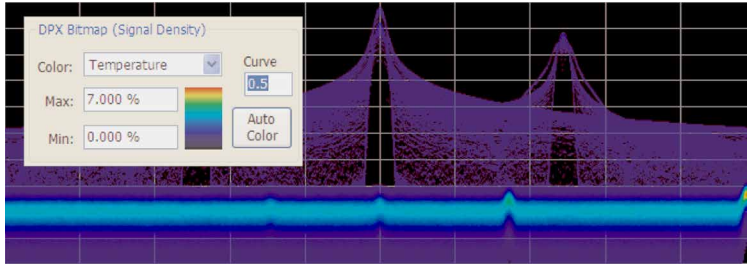

Figure 18: Adjusting to values less than 1, increases the contrast for viewing events in the top half of the selected density range.

In the below [Figure 19](#) on page 79, the Curve control is increased to 3. The majority of colors shifts to the lower half of the density scale, but various shades of orange and red are still available for densities above 50%.

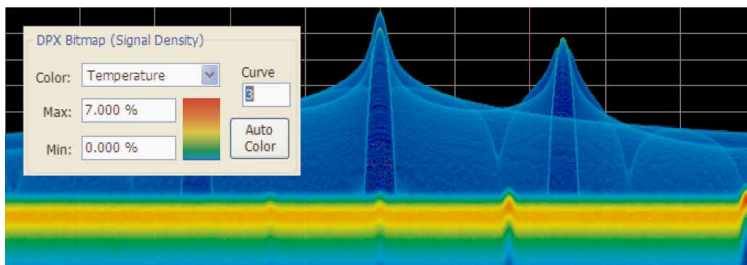

Figure 19: For color curve settings greater than 1, better contrast is provided for events near the low end of the density range.

Swept DPX

DPX Spectrum is not limited in span by its real-time bandwidth. Like the regular Spectrum display, DPX Spectrum steps through multiple real-time frequency segments, building a wide-span display with line traces and the bitmap. See the below [Figure 20](#) on page 79.

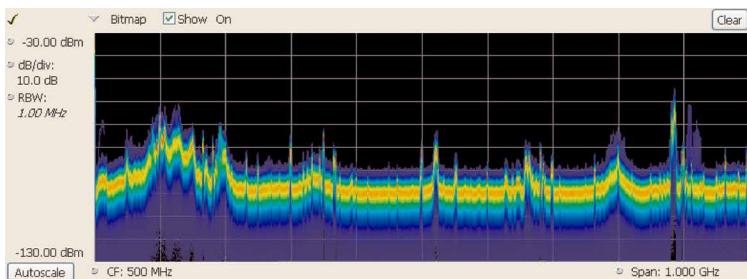

Figure 20: Off-air ambient signals over a 1 GHz span in the swept DPX display.

The analyzer “dwells” in each frequency segment for one or more DPX frames, each containing the results of up to 14,600 spectral transforms. Dwell time is adjustable, so you can monitor each segment of the sweep for up to 100 seconds before moving to the next step. While dwelling in a segment, the probability of intercept for signals within that frequency band is the same as in normal, real-time spans.

A full pixel bitmap is created for every segment and compressed horizontally to the number of columns needed for displaying the frequency segment. Compression is done by averaging pixel densities of the points being combined together. The final swept bitmap contains a representation of the same pixel bitmap resolution, just like the non-swept bitmaps. Line traces are also created in full for each segment, and then horizontally compressed to the user-selected number of trace points for the full span.

A complex algorithm for determining the number and width of each frequency segment has been implemented. The variables in the equation include user-adjustable control settings like Span, RBW, and number of trace points, RF and IF optimization, and Acquisition BW. Installed hardware options also can affect the span segmentation.

A helpful piece of information for operators is the actual Acquisition Bandwidth used for capturing each segment. “Acq BW” is shown in the Acquire control panel on the Sampling Parameters tab. Acq BW is typically set automatically by the instrument, based on the needs of all the open displays, but can also be set manually. In either case, the displayed bandwidth is used for every frequency segment in

the swept DPX display, though in practice, the displayed portion of the segment is somewhat narrower than the actual Acquisition BW, for performance reasons.

The entire instrument frequency range of many GHz can be covered in a DPX sweep. The Dwell Time control sets the amount of time DPX spends in each segment. This control, shown below, can be set between 50 ms and 100 seconds.

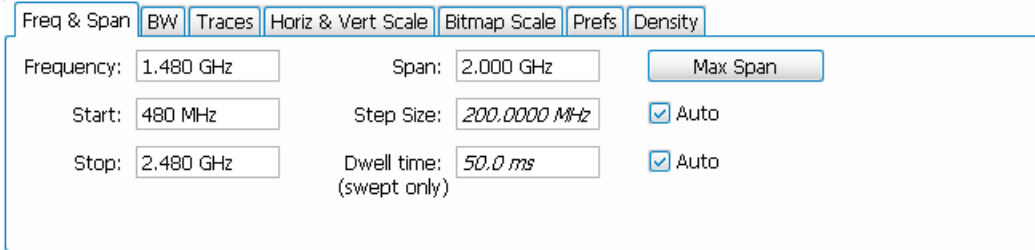



Figure 21: During swept DPX operation, the Dwell time control adjusts the observation time of each frequency segment used to construct the composite DPX display.

Guaranteed capture in DPX real-time spans

All Tektronix real time spectrum analyzers are specified for the minimum signal duration for 100% probability of capture and display. This number can vary based on the processor used for SignalVu-PC. In the case of the RSA7100, the processor is from Tektronix, and we provide published performance in the datasheet and *RSA7100 Specifications and Performance Verification Technical Reference* (available for download from www.tek.com). In the case of USB RF spectrum analyzers, minimum signal duration can be as brief as 16 μs. See the datasheet for your instrument to determine its performance.

You can also, at any time, have the instrument report its minimum signal duration by displaying it on the DPX spectrum screen as follows.

1. Check that the DPX spectrum display is active.
2. Click  to view the DPX settings control panel.
3. Select the **Prefs** tab.
4. Check the **Show parameter readouts** box. The minimum signal duration for 100 % POI will appear on the right side of the display.

The following table shows the specified minimum signal duration (MSD) for 100% probability of intercept under various combinations of Span and RBW in DPX for a representative signal analyzer. As you can see, MSD is affected by multiple factors.

Table 8: Minimum signal duration specifications

				Minimum Event Duration 100% POI (μs)	
Span(MHz)	RBW(kHz)	FFTLlength	Spectrum/sec	Base unit	Opt. 09
110 MHz	10000	1024	292,969	17.3	3.7
	1000	1024	292,969	19.5	5.8
	300	2048	146,484	28.5	14.8
	100	4096	73,242	37.6	37.6
	30	16384	18,311	134.6	134.6
	20	32768	18,311	229.2	229.2

Table continued...

Span(MHz)	RBW(kHz)	FFTLenght	Spectrum/sec	Minimum Event Duration 100% POI (μs)	
				Base unit	Opt. 09
40 MHz	5000	1024	292,969	17.5	3.9
	1000	1024	292,969	19.4	5.8
	300	1024	146,484	25	11.4
	100	2048	73,242	37.6	30.8
	30	4096	36,621	93.6	93.6
	20	8192	18,311	147.3	147.3
	10	16384	18,311	194.5	294.5
	20	4096	73,242	133.9	133.9
	10	8192	36,621	267.8	267.8

To demonstrate the POI in action, a challenging bi-stable signal is used. A CW sinusoid sits at 2.4453 GHz most of the time, but every 1.28 seconds, its frequency changes for about 100 μs before returning to normal. The duty factor of this transient is less than 0.01%.

Below [Figure 22](#) on page 81 shows a swept analyzer set up for a 5-second sweep of its MaxHold trace. It shows that there is something occurring around the signal. This sweep rate was empirically determined to be the optimum rate for reliable capture of this signal in the shortest time. Faster sweep times can reduce the probability of intercept and result in fewer intersections of the sweep with the signal transient.

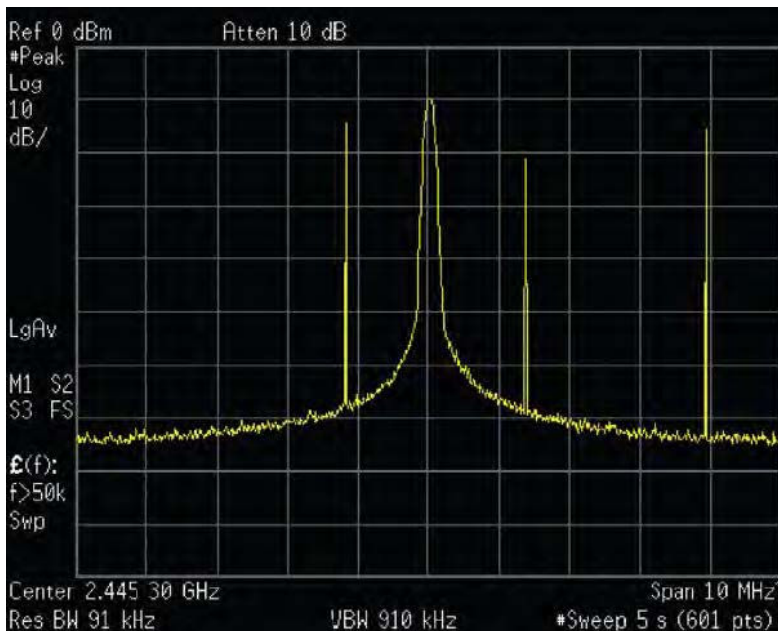

Figure 22: Swept spectrum display of the infrequent transient.

The DPX display shown in the below [Figure 23](#) on page 82 shows the exact same event, also captured over a 5 second period. A lot more information can be discovered about the transient. It is obvious at first glance that the signal is hopping by about 3 MHz, with 1.2 MHz of frequency overshoot on transitions

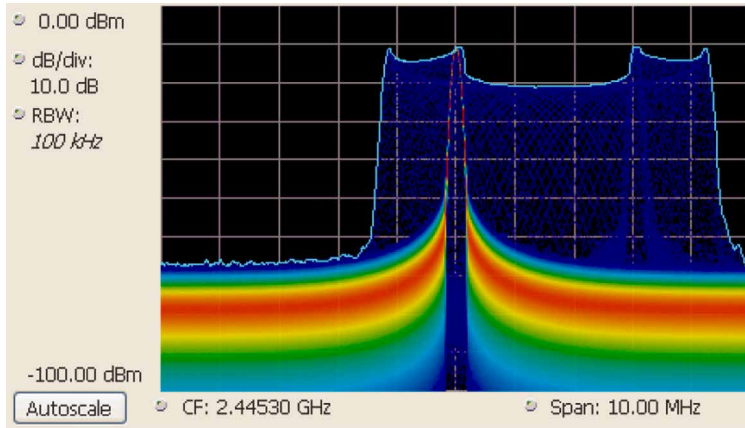

Figure 23: The DPX spectrum display after 5 seconds. The MaxHold trace is cyan.

Guaranteed capture in DPX swept spans

Probability of intercept (POI) for signals within a single segment, while DPX is dwelling in that segment, is the same as for non-swept DPX operation. But just as in traditional swept analyzers, during the time the acquisition is tuned to any one segment, the analyzer is not monitoring signals in any of the other segments, so probability of capture in segments other than the current one is zero. Because of the wide real-time bandwidth, the number of segments needed to cover the span is much less than for swept analyzers, so the overall probability of intercept is significantly better for DPX sweeps.

Another factor affecting POI is number of trace points. The bitmap is always 801 points wide, but the line traces allow user selection for number of points. 801 is the default and the other choices are 2401, 4001, and 10401. Frequency transforms for traces containing more than 801 points take longer, and this lower waveform update rate increases the minimum signal duration proportionally. This caution applies for swept and non-swept operation. The trace length control is on the Prefs tab in the DPX control panel.

DPX Density measurements



Note: DPX Density measurements are only available when an RSA7100 is connected.

Density is a measure of the amount of time during a defined measurement period during which signals are present within a particular area of the DPX Spectrum bitmap. A clean CW tone gives a 100% reading, while a pulse that is on for one microsecond out of every millisecond reads 0.1%. This section describes how density is computed from hit counts.

If we plot 41 more waveforms into the example grid we used previously (in addition to the nine we already plotted), each column ends with a total of 50 hits (see the below [Figure 24](#) on page 83). The density for any one cell in a column is its own count value divided by 50, expressed in percent as shown in the [Figure 25](#) on page 83. The math is very simple: a cell with 24 counts has a 48% density. In practice, instead of batches of 50 waveforms, we collect a frame of thousands of waveforms before each update to the density bitmap.

					4					
					6					
					13					
					18					
				1	3	1				
		1	2	4		4				
1	2	1	43	41	2	38	6	1	2	2
47	46	47	5	4	3	7	43	47	46	47
2	2	1			1		1	2	2	1

Figure 24: Grid showing cell counts after 50 waveforms. For each column, the sum of z-axis values is 50.

0%	0%	0%	0%	0%	0%	0%	0%	0%	0%	0%
0%	0%	0%	0%	0%	8%	0%	0%	0%	0%	0%
0%	0%	0%	0%	0%	12%	0%	0%	0%	0%	0%
0%	0%	0%	0%	0%	26%	0%	0%	0%	0%	0%
0%	0%	0%	0%	0%	36%	0%	0%	0%	0%	0%
0%	0%	0%	0%	2%	6%	2%	0%	0%	0%	0%
0%	0%	2%	4%	8%	0%	8%	0%	0%	0%	0%
2%	4%	2%	86%	82%	4%	76%	12%	2%	4%	4%
94%	92%	94%	10%	8%	6%	14%	86%	94%	92%	94%
4%	4%	2%	0%	0%	2%	0%	2%	4%	4%	2%

Figure 25: Grid after converting occurrence counts to percent density values. The sums of the cell density measurements within each column are all 100%.

Measuring density with markers

Hit counts are cleared after every frame update, as long as Persistence is not turned on. The density value for any pixel is simply the percent of time it was occupied during the most recent 50 ms frame. Markers can be used to see the Density value for one or more individual points on the screen, enabling measurements of the signal density at any interesting point in the DPX display.

In the below [Figure 26](#) on page 84, Wireless LAN signals are analyzed in the presence of a Bluetooth radio signal in the 2.4 GHz ISM band.

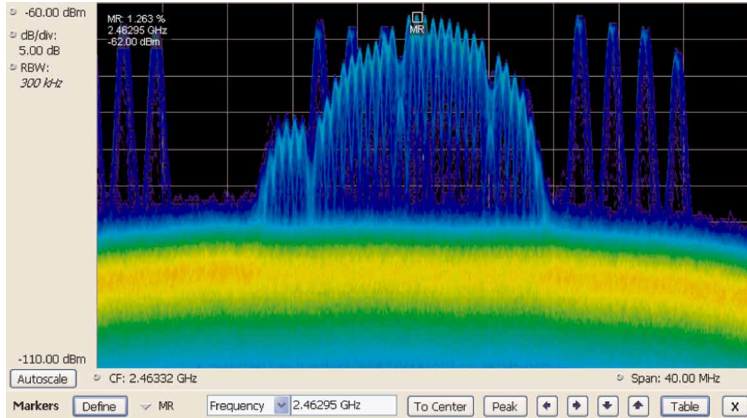

Figure 26: DPX display of WLAN and Bluetooth signals, with a marker on the highest signal.

The “Marker to Peak” function was used to find the peak signal recorded in the display. The marker readout in the upper left corner of the above [Figure 26](#) on page 84 shows the Density, Amplitude, and Frequency for the pixel you selected with the marker. By adding additional markers, you can measure the signal density differences between multiple signals of interest.

Marker peak search in the DPX bitmap

Markers on the DPX bitmap can search for peaks, similar to marker peak searching on spectrum line traces. For a human, it is pretty easy to discern “signals” in the bitmap picture. Your brain intuitively identifies strings of contiguous bright pixels. This isn't so easy for a computer. The first thing the RSA must do for any peak search is analyze pixel density values to identify apparent signals. Then it can sift through these density peaks for the amplitude peaks you want to find.

Z-axis density values for the pixels in each column of the bitmap are internally converted into histograms to find density peaks indicating the presence of signals. Table 2 shows the five middle columns from the example grid we used to illustrate density measurements in a previous section (See [Figure 25](#) on page 83). The density values for each pixel in the middle, highlighted column are plotted on the y axis in the bar chart in the [Figure 27](#) on page 85. The bar chart x axis is bitmap row number, numbering from the top of the table.

Table 9: Bitmap section showing density values.

0%	0%	0%	0%	0%
0%	0%	8%	0%	0%
0%	0%	12%	0%	0%
0%	0%	26%	0%	0%
0%	0%	36%	0%	0%
0%	2%	6%	2%	0%
4%	8%	0%	8%	0%
86%	82%	4%	76%	12%
10%	8%	6%	14%	86%
0%	0%	2%	0%	2%

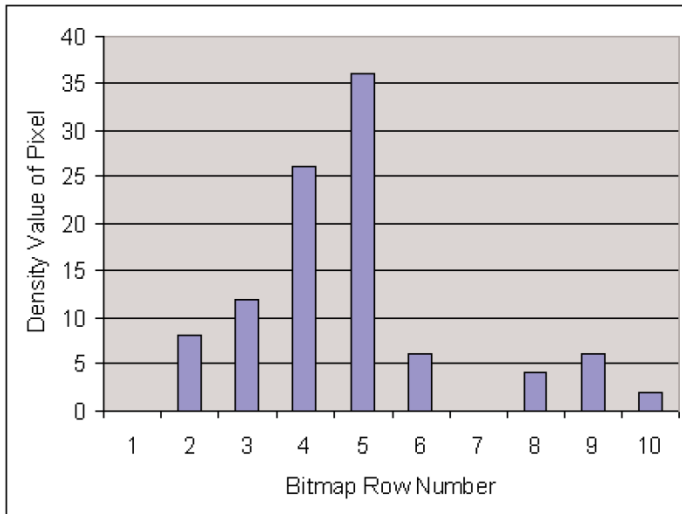

Figure 27: Bar chart of the density values in the bold column of Table 2.

Assume that Density Threshold is set to 5% and Density Excursion to 5% also. Starting with $x=1$ in the bar chart, test each bar against the threshold. The threshold criteria is met at $x=2$. Keep testing until you find a bar that is shorter than the previous bar by at least the Excursion setting. In this case it is $x=6$. This tells us that a “signal” covers rows 2 through 5. Its density peak is at row 5.

Now you can look for another peak. Continue looking at bars to the right and you will find a density value at row 9 that meets the threshold criteria, but since there are no bars to the right of it that meet the excursion criteria, we can't declare row 9 a signal because it fails to meet the excursion criteria. If row 1 had 1% density, then row 9 would be a density peak.

Once density peaks are found for all columns in the bitmap, we can start looking for the amplitude peaks. When the **Peak** button is selected, the analyzer checks the histograms of every column in the bitmap and finds the density peak with the highest amplitude. The amplitude search has its own versions of Threshold and Excursion settings, but in dBm and dB units. When **Next Peak Down** command is given, the search will scan inside the current column for the next density peak. **Next Peak Right** examines each column to the right of the current marker location to locate density peaks that also meet the amplitude peak criteria.

To demonstrate the value of marker peak search in the DPX bitmap, we will use the time-multiplexed signals showing multiple amplitude levels from an example earlier in this manual. The **Peak** button and its menu equivalent place the active marker on the peak signal in the below [Figure 28](#) on page 85. The peak signal is the density peak of highest amplitude in the bitmap.

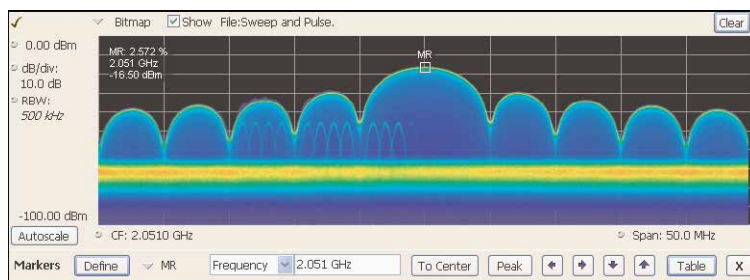

Figure 28: The marker was positioned by selecting the Peak button. Density, frequency, and amplitude measurements at the marker are displayed in the upper left corner of the graph.

The Marker Toolbar, at the bottom of the above [Figure](#), allows easy navigation of peak signals (**Peak Left**, **Peak Right**, **Next Peak Up**, or **Next Peak Down**). Selecting the arrow keys enables the marker to search for amplitude/density peaks at other frequencies, while the **Next Peak Up** and **Next Peak Down** arrows enable the marker to search for other high-density points at the same frequency.

In the Define Peaks tab of the Define Markers control panel (see the below [Figure 29](#) on page 86), you can adjust the density threshold and excursion controls to modify search behavior. The amplitude threshold and excursion controls also apply to DPX marker searches.

Smoothing keeps the marker from finding multiple peaks within the same apparent signal by averaging an adjustable number of pixel densities together, but it does not affect the single-pixel measurement readout displayed by the marker.

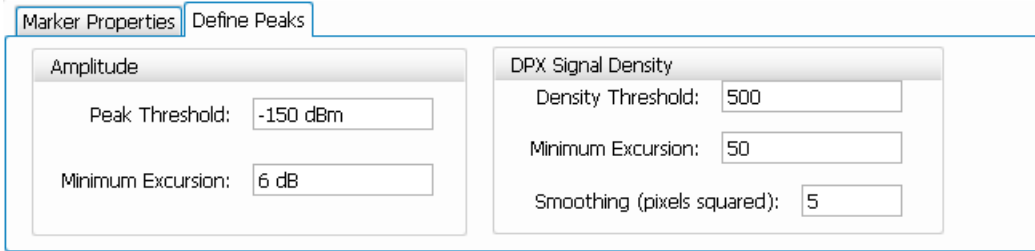

Figure 29: Amplitude and Signal Density controls can be adjusted to define Peak search behavior.

Density measurements over an adjustable area (The Box)

The density for a single pixel is its ratio of actual hits versus possible hits over a defined time period, and markers display these density values. For measuring density over an area larger than one pixel, the DPX display includes a measurement box you can resize and drag around in the DPX display.

If you could make the box so narrow that it contained only points within a single column of pixels, the density of this area would be the sum of the included pixels' density values. For example, if the box was three pixels tall and the density values for these pixels were 4, 2, and 7% respectively, the overall density for the three-pixel area would be 13%. Imagine a box one pixel wide and as tall as the graph. Assume that the input signal's amplitude was such that all hits fell at or near the vertical center of the screen. Since 100% of the waveforms written to the bitmap passed through the box, the density for the box is 100%.

$$\text{Density of an area} = \frac{(\text{Sum of densities of all pixels})}{(\text{Number of columns})}$$

When you widen the box to cover a broader range of frequencies, software computes the density sum for the included pixels in each column inside the box. The aggregate density value for this box is the average density, calculated by adding the column density sums then dividing by the number of columns. For a 100% result, there must not be any hits above the top edge of the box or below its bottom edge. In other words, every waveform drawn across the graph entered the box through its left side and exited the box through its right side, with no excursions out the top or bottom. The below [Figure 30](#) on page 86 demonstrates this principle on a CW signal. As you can see on the left-hand side, no amplitudes exist above or below the box; the density of the signal is 100%. On the right hand side, there are signals below the box, therefore the density is less than 100%.

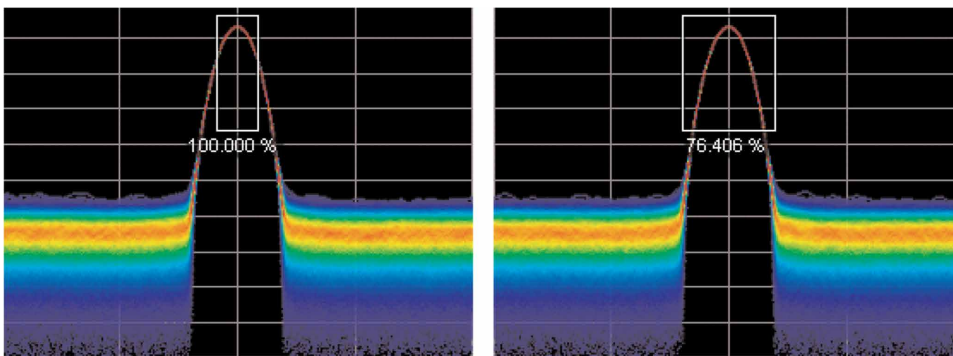

Figure 30: Density of signals defined within an area. Left: Correct measurement of a CW signal. All columns in the box include the signal. Right: Incorrect measurement area. The measurement is accurate, but probably not what you expected. Some columns in the box contain no hits, so they contribute zeros to the calculation of average density.

The density measurement box's vertical size and location are always set in dB and dBm, no matter what units you have selected for measurements. The box is not draggable when the selected units are linear (such as Amps, Volts, Watts...), though you can still adjust its size and location using the Frequency and Amplitude controls. Since the vertical scale is non-linear, a box of constant amplitude changes visual height as it changes vertical position, a disconcerting effect if you are trying to drag it.

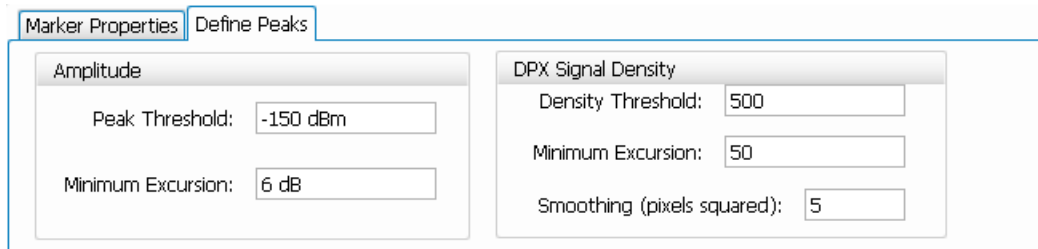

Figure 31: DPX Density control panel is used to define the area of interest for DPX density measurements.

A readout will appear somewhere in the graph. If the box is off-screen, the readout will be accompanied by an arrow pointing towards the invisible box. Drag the density readout to the area you want to measure.

Persistence

Previous sections of this topic have assumed that persistence was not applied to the DPX bitmap. Without persistence, hit counts in the grid are cleared after each frame update. Now we will describe how persistence modifies this behavior, starting with infinite persistence because it is simpler than variable persistence.

Hit counts are not cleared between frames if infinite persistence is enabled. When the instrument is set up for continuous acquisitions, hits keep collecting until you stop acquisitions or click the Clear button above the DPX display. Software keeps track of the total number of waveforms computed during the entire collection period. Density equals the total number of hits to a cell divided by the total number of waveforms.

Variable persistence is trickier. A single-occurrence signal shown in the bitmap does not disappear suddenly upon the next frame update, nor does it linger forever. It fades gradually away. The user sets a time constant for the Dot Persistence control which determines how long it takes for signals to fade. Fading is accomplished by reducing the hit count in every cell, after each frame update, by a factor based on the persistence time constant. The longer the time constant, the less the hit counts are reduced.

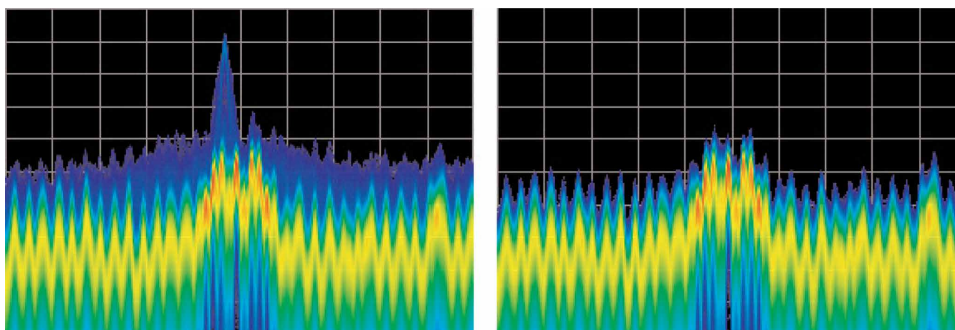

Figure 32: Example of fast transient discovery with and without variable persistence turned on. In the display on the left, with variable persistence of 10 seconds, the occasional sub-second transient that spikes up above the normal signals is held in the display rather than disappearing as soon as the signal goes away. The display on the right, with persistence turned off, requires watching the display continually to see the brief signal.

Not only are single-occurrence signals allowed to remain in the display for awhile by variable persistence, additional hits keep piling on. The result is that cell values are no longer pure hit counts; they include counts due to new hits from waveforms plus proportionally reduced counts from prior frames. As part of translating hit counts into density values, a new software algorithm uses a finite-series equation to discriminate between the effects of persistence and the arrival of new hits. The inflationary effects of persistence on cell counts are removed, so density readings represent the true ratio of actual hits to possible hits over the persistence interval.

The density computation for variable persistence is a very good estimate of true signal density, with errors of less than 0.01%. For exact density measurements, use either no persistence or infinite persistence.

Another subtlety of persistence is its smoothing effect on the density measurement of intermittent signals. Consider a pulse that is on for 10 ms and off for 90 ms of each 100 ms cycle. We will make the simplifying assumption that the pulse ON time always falls entirely within a single DPX frame update (50 ms). If persistence is not applied, the density measurement is computed on each individual frame. The results will be 20% for each frame containing the ON time and 0% for the other frames. If infinite persistence is enabled, however,

the density measurement will settle to 10% after the second frame, and remain at this value for as long as the pulsing continues. With persistence, the density is effectively computed over many frames.

Persistence effects on density

Persistence does not alter colors in a density-based bitmap. Its effect is to extend the amount of time over which densities are calculated, leaving signal events visible for the persistence duration.

Before the introduction of density measurements and extra-long hit counters, persistence caused colors to “bloom”, becoming more and more intense over time as the hit counts increased. Longer persistence intervals caused increased blooming, turning crisp signals into fat red stripes. When hit counts are converted to density values, the display is not subject to this effect. As long as the input signals maintain reasonably stable repetition rates and duty ratios, their density values will also remain stable despite ever-increasing hit counts in the underlying grid cells.

If you are accustomed to the original hit-count-based persistence displays, it may seem counter-intuitive that repeating signals in a density-based bitmap will not get brighter and redder over time with infinite persistence. A quick review of the density algorithm explains why: the hit count is divided by the total number of waveforms over the persistence interval. For example, if a signal occupies a pixel 50% of the time over a period of 15 minutes, the density reading will be 50% throughout the entire 15 minutes, though the underlying hit count is steadily increasing.

Z-axis resolution

Another factor that can cause color bloom is overflow of the hit counters. If a pixel could only count up to 1000 hits, its density and color values would clip at 100% after just 1000 hits, even if waveform points continue to arrive in the same pixel location. counts add up really fast for highly-repetitive signals. Deeper counters permit higher hit counts, so overflow happens much later, as shown in Table 4.

Table 10: Comparison of DPX z-axis resolution and its effect on saturation.

Hit Count	36-bit custom float (equivalent to 33-bit integer)
Maximum Hit Count	2^{33}
Minimum Time until Overflow (for pixels with 100% density)	8.1 hours

Clipping due to overflow of the counters in one or more cells will not occur until hours have passed, or even days.

One more benefit to having deeper hit counters is better visual resolution of density. RSAs with the highest-performance DPX hardware installed use floating-point numbers to count hits, allowing us to count billions of waveforms while retaining one-hit resolution, providing better than 99 dB of dynamic range for density measurements. Density measurements in $\mu\%$, n%, and even f% ranges are quite possible for extremely rare signals captured with infinite persistence.

With straight-line mapping between density and color (Curve setting of 1), resolution is fixed by the number of colors in the palette. For non-linear mappings (Curve settings higher or lower than 1), most of the colors are concentrated at either the low or high end of the density scale, so you can visually discriminate finer differences between density values in that range.

Persistence adjustments

Dot Persistence can be enabled for the “Bitmap” trace using the Settings control panel. The Persistence can be displayed as Infinite or Variable. For Variable Persistence, you can select the time constant for fading in seconds as shown in the below [Figure 33](#) on page 89.

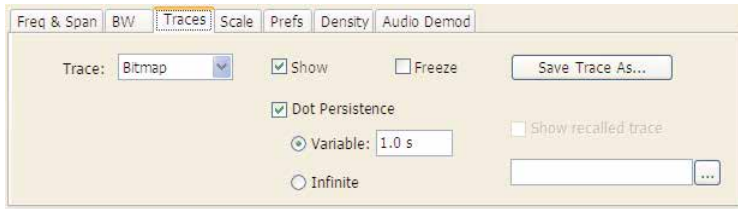

Figure 33: The trace settings control panel allows user control of persistence parameters.

the below [Figure 34](#) on page 89 demonstrates the observed behavior of variable persistence when a CW signal, represented in the first frame, is turned off. Even if the event was instantaneous and was confined within a single frame, you will observe the color changing to indicate lower and lower density values, until the signal finally disappears entirely.

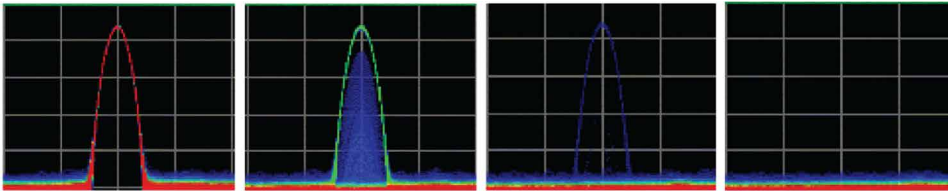

Figure 34: With variable persistence, a brief CW signal captured by DPX remains in the display for an adjustable period of time before fading away.

DPX density trigger

(Applies only to the RSA7100 with option TRIGH.)

The standard DPX display shows you a clear picture of transients and other hard-to-find signals and goes well beyond helping you discover these difficult to find signals by actually triggering on their appearance to capture them into acquisition memory for in-depth analysis. If you can see it in the DPX bitmap, you can trigger on it.

Other trigger methods can detect signals that exceed an amplitude threshold, or even a sophisticated amplitude vs. frequency mask, but they cannot find a signal at a particular frequency if another signal of higher amplitude is sometimes present at that same frequency. As shown in the following [Figure 35](#) on page 89, the DPX Density trigger can discriminate signals within a precise amplitude-frequency range without the operator having to know any characteristics of the target signal besides where it might show up in the DPX Spectrum graph.

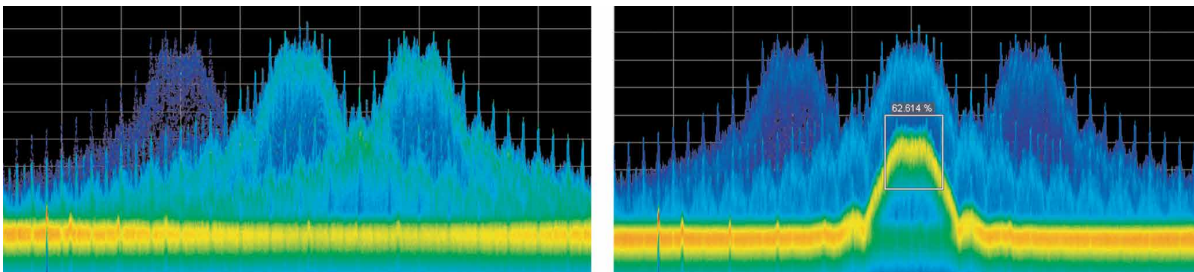

Figure 35: Example of Density Trigger. Left: A free-run DPX display showing pulses with varying frequency. Occasionally, a short pulse in the middle appears for a split instant, but it is hard to capture it with just a Run/Stop button. Right: The triggered DPX displays shows the low-amplitude pulse that was not apparent in the untriggered display. The analyzer was set to trigger whenever the average density in the user-drawn box measured 50% or higher.

The DPX Density trigger uses the same screen-based measurement box as the DPX Density measurement. While the target signal is absent, the density measurement characterizes the “normal” signals within the box. When the target signal finally appears, the density value increases. The trigger system monitors the density measurement and activates a trigger whenever the density value exceeds the adjustable density threshold. The only thinking you have to do is to set this threshold to a level somewhere between the normal density readings and the density due to the trouble-making signal. However, the instrument software can compute the threshold value automatically.

Trigger On This™

The Trigger On This™ function allows you to point and click to set up the DPX density trigger. By right-clicking on a spot within the DPX display, or pressing and holding your finger on the touchscreen display for about a second, a menu selection will appear. Selecting **Trigger On This** causes a DPX Density box to appear and automatically adjusts the threshold. The DPX display will now only update whenever the automatic threshold is exceeded. Subsequently, if needed for your signal, open the Trigger control panel to adjust the density threshold or the size of the measurement box until the event is reliably captured.

DPX density trigger timing

The time resolution for DPX density measurements is the frame length, around 50 ms. A basic implementation of the DPX density trigger concept is also frame-based, so a trigger event that occurs anywhere within a frame will not be recognized until the end of the frame. Therefore, the worst case trigger uncertainty is 50 ms.

DPX density trigger doesn't always have to wait until the end of a frame before firing. For the common configuration of triggering when the measured density is higher than the threshold, the density measurement in the trigger can be computed many times within each frame and it can fire the trigger as soon as the threshold is exceeded.

Consider the case where the threshold is zero. As soon as a single waveform causes a hit within the measurement box, we know that the density is greater than zero. It takes a little longer to test for a 5 or 10% density, and even more time for thresholds at or near 100%.

The DPX density trigger can also be set to fire when the measured density is below the threshold value. This is useful when you suspect that your signal is missing some of the time. For a signal that is supposed to be CW, you can set the trigger controls to acquire when the density measurement of the signal peak drops below 100%. When using the "lower than" form of the DPX density trigger, the time resolution is one frame because of the following logic: We can't be sure the actual density is less than, say, 15% until at least 85% of the full test time has elapsed. In order to keep things simple and fast in the trigger module, the RSA just waits until the end of each 50 ms frame to do the "lower than" comparisons.

Persistence and DPX density trigger

The smoothing effect of persistence on density measurements can help in determining a good threshold value. With persistence turned off, an infrequent signal's density reading jumps between higher and lower values as it turns on and off, and it can be hard to read these flashing numbers. By turning persistence on, you instruct the instrument to average the density over a longer time period. This density result is somewhere between the ON and OFF density values - the very definition of a good trigger threshold.

Like the DPX density measurement, the DPX density trigger is affected by persistence. The trigger decision is made on the persisted measured value in the box.

DPX display overview

The DPX display enables you to see how traces change over time and thus displays signal events that cannot be seen on a swept spectrum analyzer. A DPX Spectrum indicates how traces change in two ways. First, it uses color shading to show how consistent the shape of a trace is. Second, it uses persistence to hold signals on the screen so you can see them longer.

Read more about the DPX display in the following topics:

[DPX display](#) on page 90

[DPX settings](#) on page 95

DPX display

The DPX display works by using a two-dimensional array to represent points on the display. Each time a trace writes to a point on the display, a counter in the array is incremented. A color is assigned to each point in the display based on the value of its counter. Thus, as acquisitions occur over time, a colored waveform, the Bitmap, develops on the display that shows how frequently each display point has been written to.

An important feature of the DPX display is dot persistence. Dot persistence sets how long a point on the display will be visible. You can set the Dot Persistence to be Variable or Infinite. In variable persistence mode, you specify a decay period that limits how long a point will be displayed. In infinite persistence mode, once a point in the display has been written to, it will remain visible indefinitely.



Tip: See the [Features by product](#) on page 33 topic for more information about which features are available with which connected analyzers.

The DPX display can plot the trace in the following views:

- **Spectrum** – This view plots power on the vertical axis versus frequency on the horizontal axis. This display is similar to a standard Spectrum display. In the spectrum display, you can view any of three traces, a math trace, and the selected DPX-ogram trace.
- **DPXogram** (available when an RSA306, RSA306B, RSA500A series, RSA600A series, or RSA7100 instrument is connected). This view is a spectrogram version (time plotted along the vertical axis versus frequency on the horizontal axis) of the DPX Spectrum trace. DPX spectrogram (on the instrument that created the DPX acquisition data) creates the spectrogram in real time, and does not require an acquisition to be transferred into memory and analyzed. Because of this real time processing, there are no gaps in the spectral lines, even for monitoring periods that can last for several days.
- **Split** - This view consists of two DPX views. A DPXogram view appears on the top half of the display and a DPX Spectrum view appears on the bottom half of the display.

To display a DPX view:

1. Recall a DPX waveform acquisition data file.
2. Select **Frequency** and set the measurement frequency.
3. Select the **Displays** icon or **Setup > Displays**. This displays the **Select Displays** dialog box.
4. From the **Measurements** box, select **General Signal Viewing**.
5. Select **DPX** from the **Available displays** box.
6. Click the **Add** button. This will add the DPX icon to the Selected Displays box (and remove it from the Available displays box).
7. Click the **OK** button. This displays the DPX Spectrum view.
8. Select the desired view from the drop-down list on the left side of the graph.

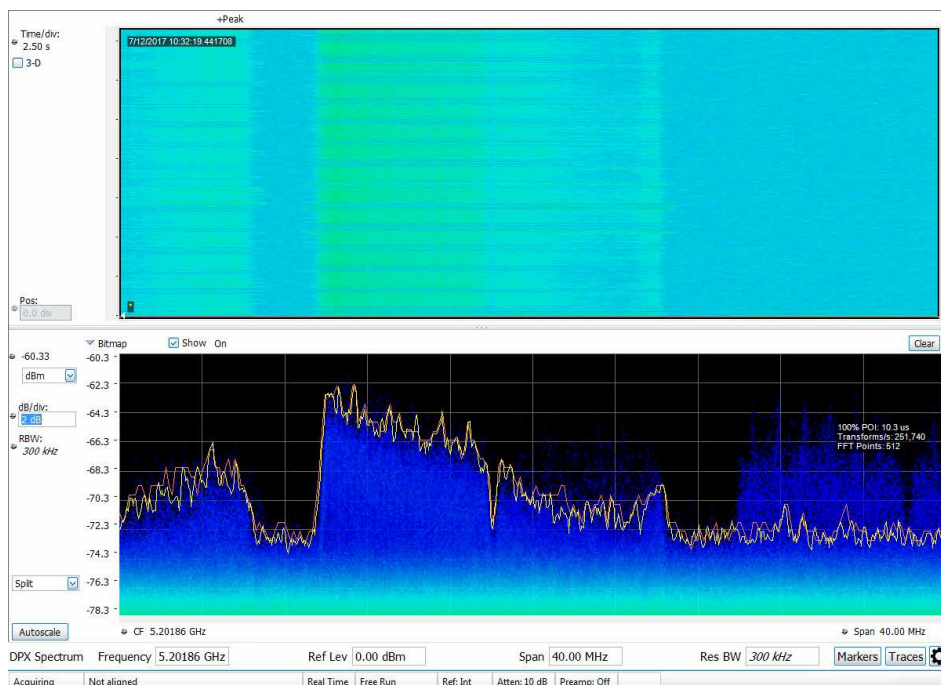
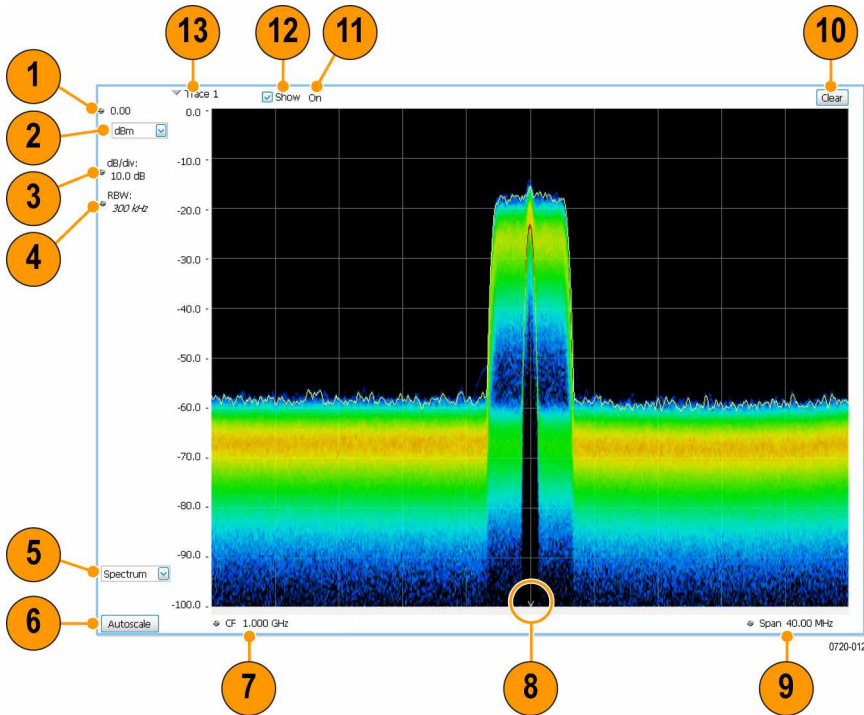

Figure 36: Example of the DPX Split view

Elements of the DPX display



Item	Display element	Description
1	Vert Position	Sets the top of graph value. This is only a visual control for panning the graph. The Reference Level is adjusted in the Toolbar and the Ampl control panel. By default, Vert Position = Ref Level.
2	Units	Sets the global Amplitude units for all the views in the analysis window. This will change the Amplitude selection in the Units tab of Analysis control panel.
3	dB/div	Sets the vertical scale value. The maximum value is 20.00 dB/division.
4	RBW	Sets the resolution bandwidth. Note that when the RBW is set to Auto, its value is italicized.
5	DPX view	Selects the DPX view. Choices are Spectrum, DPXogram, and Split.
6	Autoscale	Adjusts the Vertical and Horizontal scaling to display the entire trace on screen.
7	CF	Adjusts the analyzer center frequency.
8	CF indicator	Indicates the center frequency.
9	Span/Scale	Span - Adjusts frequency range of the measurement. Scale - If Horizontal scale has been manually adjusted in Settings > Scale, then this control adjusts the visual graph scaling without affecting the Span.
10	Clear	Erases the bitmap and traces in the graph and restarts multi-trace functions (Avg, Hold).

Table continued...

Item	Display element	Description
11	Function	Readout of the Detection and Function selections for the selected trace.
12	Show	Controls whether the selected Trace is visible or not. When trace is Off, the box is not checked.
13	Trace	Selects a trace. Touching here pops up a context menu listing the available traces, whether they are enabled or not. If you select a trace that is not currently enabled, it will be made enabled.

Additional elements of the DPXogram split display

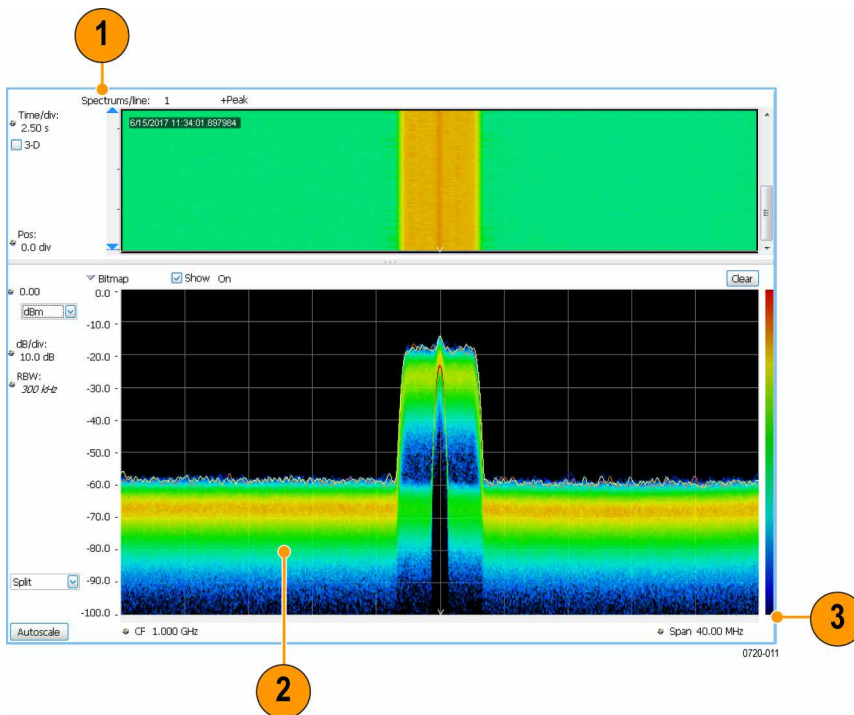

This display is only available when a compatible real time spectrum analyzer is connected.

Item	Display element	Description
1	Spectrums/line	Appears only when the display is stopped. Readout of the number of spectrum lines represented by each line of the DPXogram display. This value changes when the Time/div or Time resolution settings are changed. Line time depends on RBW and FFT processing.
2	DPXogram trace	The selected line in the DPXogram graph can be shown in the DPX Spectrum graph of the Split view. The most recent DPXogram line, usually at the bottom of the graph, is selected by default. If any markers are on, the selected marker determines the selected line.

Table continued...

Item	Display element	Description
3	Color scale	Legend at the right side of the DPX Spectrum display. This element illustrates the relationship between the colors in the DPXogram plot and the amplitude axis of the DPX Spectrum plot. This scale changes with Color (DPXogram) palette selection and Max and Min settings on the Ampl Scale tab.

Time resolution of DPXogram display

Due to the large amount of data produced by the DPX hardware during acquisitions, a compressed version of the plot is shown while running. This plot is limited to 500 lines, with each line having 267 points. However, a much longer record, with higher frequency resolution is being collected. As soon as the instrument is stopped, this underlying data is shown, replacing the temporary version. There are 50 lines in each vertical division of the 2-D DPXogram plot, so the time resolution of the graph is Time/div divided by 50. However, you can set the instrument to collect multiple spectra per line, allowing you to zoom in later on this high-time-resolution data.

$$Time\ Resolution = \frac{10 \times Time/Division}{500}$$

When the DPXogram display is stopped, the analyzer can display the full resolution of the captured data. The Time Resolution readout applies only when the DPXogram is running.

Effects of changing time resolution. The Time Resolution control affects acquisition parameters for the DPX hardware. This means that if you change the Time Resolution value while the instrument is stopped, the new value applies to the NEXT acquisition, and might not represent the results currently shown in the display.

Time resolution can be changed either directly, by manually adjusting the Time Resolution control, or automatically, by changing the Time/div control. Auto is the default, yielding one spectrum per line in the display. When the Time Resolution is decreased below its auto value, multiple spectra are collected to create each line in the DPXogram graph. Once you stop the instrument, you can decrease the Time/div value or use Zoom to see increased time resolution.

If the time resolution is set to a very small number while the Time/div is set to a large value, you might notice that there is a limit to the number of spectra that can be collected. This limit depends on the number of trace points selected. The number of lines available for the USB-RF instruments and the RSA7100 are different. The RSA7100 has a much deeper memory for this application and can display over 1 million lines, depending up the selected trace length. See individual datasheets for more information. The time capacity for any combination of settings is displayed in the Time and Frequency panel of the DPX settings display.

Screen actions on markers in the graph area

Action	Description
Mouse click within 1/2 div. of a marker	Selects the marker and updates the marker display to show the selected marker's values.
Click on a marker to select and then use the arrow keys to move the marker	Adjust the setting associated with the Marker.
Click and drag a marker	Changes marker position to the "drop point". You can use Tools > Options > Prefs to change whether markers jump from one peak to the next while dragging or move smoothly along the trace.

Available traces for display

The DPX display can be viewed as a DPX Spectrum display or as a Split display. The Split display consists of a DPXogram display on the top half and a DPX Spectrum display on the bottom half.

For the DPXogram display, only one trace is available: the DPXogram trace.

For the Split display, you can display the Bitmap trace, Trace 1, Trace 2, Trace 3, Math trace, and Ogram Line (the selected line from the DPXogram display) on the DPX Spectrum portion of the display.



Note: The DPXogram display is only available when a compatible real time spectrum analyzer is connected.

See also. [Changing the DPX Display Settings](#)

DPX settings

Main menu bar: Setup > Settings



The measurement settings for the DPX display are shown in the following table.

Settings tab	Description
Freq & Span Tab	Sets frequency and span parameters for the DPX display. This tab appears for the Spectrum and DPXogram displays.
BW	Sets Resolution Bandwidth.
Traces	Allows you to select the number and types of traces to display and their functions.
Horiz & Vert Scale	Sets the vertical and horizontal scale parameters for all the DPX views. (Available only when Spectrum view is active.)
Bitmap Scale	Sets the DPX Bitmap display parameters. (Available only when Spectrum view or Split view is active.)
Amplitude Scale	The Amplitude Scale tab allows you to change the vertical scale and offset, enable the 3-D Waterfall display, and set the color scheme used for the DPXogram trace. (Available only when DPXogram view or Split view is active.)
Time & Freq	The Time and Freq Scale tab allows you to change the vertical and horizontal scale settings, number of points in the trace, and Time resolution. (Available only when DPXogram view or Split view is active.)
Prefs	Specifies whether certain display elements are visible.
Density	Specifies location and size for the DPX Density measurement box. (Available only when Spectrum view or Split view is active.)



Tip: See the [Features by product](#) on page 33 topic for more information about which features are available with which connected analyzers.

Traces tab

The Traces tab allows you to set the display characteristics of displayed traces in the DPX display. The Traces tab settings vary depending on the DPX display view enabled (Spectrum, DPXogram, or Split).

Figure 37: Traces tab with Trace1 and average selected

Figure 38: Traces tab with DPXogram selected

Figure 39: Traces tab with Bitmap selected

Figure 40: Traces tab with Math Trace selected



Note: The DPXogram display is available only when a compatible real time spectrum analyzer is connected.

Setting	Description
Trace drop-down list	Selects which trace to configure. The available traces are Bitmap, Trace 1, Trace 2, Trace 3, and Math. A DPXogram trace selection is also available when an RSA306, RSA306B, RSA500A series, RSA600A series, or RSA7100 instrument is connected.
Show	Specifies whether or not the trace shown in the Trace setting is displayed.
Freeze	Halts updates to the selected trace.
Detection	Sets the Detection method used for the trace. Available detection methods are +Peak, -Peak, and Avg (VRMS).
Function	Selects the trace processing method. Available settings are: Normal, Average, and Hold.
Count	Sets the number of traces averaged to generate the displayed trace. (Present only when Function is set to Average.)
Intensity (Available only when Bitmap is selected)	Use Intensity to control the visibility of events. An increased intensity level allows a single, short event to be seen. This also makes such an event subject to the persistence controls. This allows you to see the effect of the Persistence controls on infrequent events. Range is 1-100%. Resolution: 1.
Dot Persistence (Available only when Bitmap is selected)	Allows a dot to remain visible if it is not updated with new data. Choices for this setting are Variable and Infinite.
Variable	The Variable dot persistence setting controls how long a point in the display is visible before fading. Range: 100 ms – 60 s. Resolution 0.1.
Infinite	The Infinite dot persistence setting prevents a point in the display from fading (not available for the DPXogram trace).
Trace minus Trace (Available only when Math Trace is selected)	The Math trace is a mathematically-derived trace defined as Trace A minus Trace B. You can select Trace 1, 2, or 3 to serve as either Trace A or Trace B.
Save Trace As	Saves the selected trace to a file for later recall and analysis.
Show Recalled Trace	Displays a saved trace instead of a live trace.

Detection

Trace Detection occurs when the trace is being decimated by the measurement. For example, if the maximum number of trace points is 100,000, and the selected analysis region is 200,000 samples, the measurement must decimate the 200,000 resulting trace points by 2 to prevent exceeding the 100,000 trace point limit. Since only one value can be selected for each trace point, an algorithm must be used to select (detect) the appropriate value to use.

The available detection methods are:

- **+Peak** – Each point on the trace is the result of detecting the positive peak value present in the set of IQ samples available to that trace point.
- **-Peak** – Each point on the trace is the result of detecting the negative peak value present in the set of IQ samples available to that trace point.
- **Avg (VRMS)** [Average V_{RMS}] – Each point on the trace is the result of determining the RMS Voltage value for all of the IQ samples available to the trace point. When displayed in either linear (Volts, Watts) or Log (dB, dBm), the correct RMS value results. When the averaging function is applied to a trace, the averaging is performed on the linear (Voltage) values, resulting in the correct average for RMS values.



Note: The Detection setting does not affect the trace until the spectrum length is longer than the Auto setting.

Dot Persistence

Dot Persistence is the characteristic of the DPX display that determines how long a pixel in the display remains visible.

To set the Persistence:

1. Select **Setup > Settings**.
2. Select the **Traces** tab.
3. Select the Bitmap trace.
4. Select **Dot Persistence**.
5. Select either **Infinite** or **Variable**.
6. If you select Variable, enter a value in the text box. The Variable persistence value can be set from 0.05 to 100 seconds.

DPX Trace Processing

The +Peak, -Peak, and Average traces can be processed to display in different ways. The Function setting controls trace processing.

- **Hold** - Displays the value in the trace record for each display point. Each new trace display point is compared to the previous maximum value and the greater value is retained for display and subsequent comparisons. Available for traces using +Peak or -Peak detection.
- **Normal** - Displays the trace record for each display point without additional processing. Available for all detection selections.
- **Average** - Default setting for the Average. Multiple traces are averaged together to generate the displayed trace. There is one vertical value for each underlying frequency data point. Once the specified number of traces have been acquired and averaged to generate the displayed trace, each new trace takes the place of the oldest trace in the calculation. The **Count** setting specifies how many traces are averaged. Available for traces using Average detection.

Trace averaging uses the exponential method. If Count = 10, the newest trace's contribution to the averaged trace is 10%. When Count is not checked, the algorithm assumes the maximum number of traces contributing to the average is 2^{32} .

Saving Traces

To save a trace for later analysis:

1. Select the **Save Trace As** button. This displays the Save As dialog box.
2. Type a name for the saved trace and click **Save**.

Recalling Traces

You can recall a previously saved trace for comparison to a live trace. First, specify a trace for recall and second, enable Show Recalled Trace.

To select a trace for recall:

1. Click the ... button to display the Open dialog box.

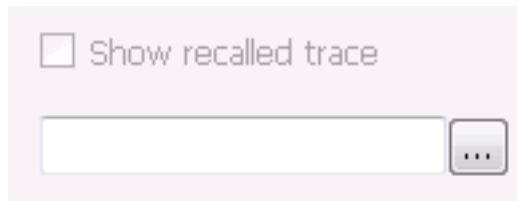

2. Navigate to the desired file and click **Open**.
3. Check the **Show Recalled Trace** check box.
4. Verify that the trace's **Show** check box is selected (either on this tab or next to the drop-down list located at the top-left corner of the graph).

Horiz & Vert Scale Tab

The Horiz & Vert Scale tab allows you to change the vertical scale settings used for the Bitmap trace. Changing the scale settings changes how the trace appears on the display but does not change control settings such as Measurement Frequency.

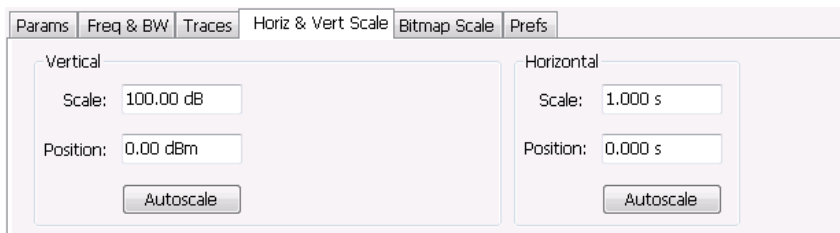

Setting	Description
Vertical	Controls the vertical position and scale of the trace display.
Scale	Changes the vertical scale.
Offset	Adjusts the Reference Level away from the top of the trace display.
Reset Scale	Sets Scale to its default value and Offset to zero. Disabled when Units (Setup > Analysis > Units) is set to Watts or Volts.
Autoscale	Resets the scale of the vertical axis to contain the complete trace. Disabled when Units (Setup > Analysis > Units) is set to Watts or Volts.
Horizontal	Controls the horizontal position and scale of the trace display.
Scale	Changes the horizontal scale.
Position	Adjusts the horizontal position of the signal. This does not change the center frequency.
Autoscale	Resets the scale of the horizontal axis to contain the complete trace.

Bitmap Scale Tab

The Bitmap Scale tab allows you to set the color scheme used for the Bitmap trace. Changing the DPX bitmap Color, Max and Min scale settings changes how the trace appears on the display but does not change control settings such as Measurement Frequency.

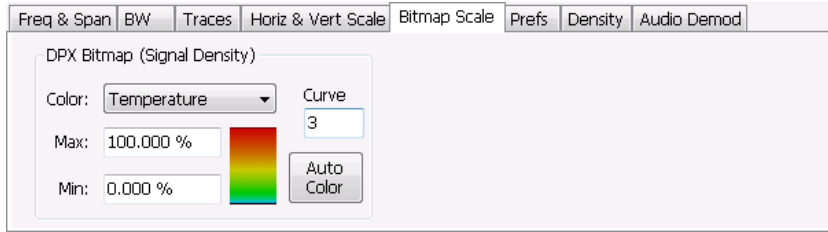

Setting	Description
DPX Bitmap (Signal Density)	Controls the appearance and scale of the DPX Bitmap trace.
Color	Allows you to select the color palette used for the DPX Bitmap trace.
Max	Sets the hit density represented by the top of the color scale. "Clipping" occurs for densities greater than this value. Range: 1p% - 100%; Default: 100%.
Min	Sets the hit density represented by the bottom of the color range. Range: 0 - 80%; Default: 0.
Curve	Adjusts how colors are mapped to the signal density. The mapping can be linear (Curve = 1), or it can be set to concentrate the resolution on the lower level of the range (Curve > 1) or the mapping can be set to show the best resolution on the upper range of density or hit count (Curve < 1).
Auto Color	Adjusts the Max and Min settings to display the broadest range of colors.

Time & Freq Tab

The Time and Freq tab allows you to change the vertical and horizontal scale settings, and set the time resolution and number of trace points of the DPXogram display.

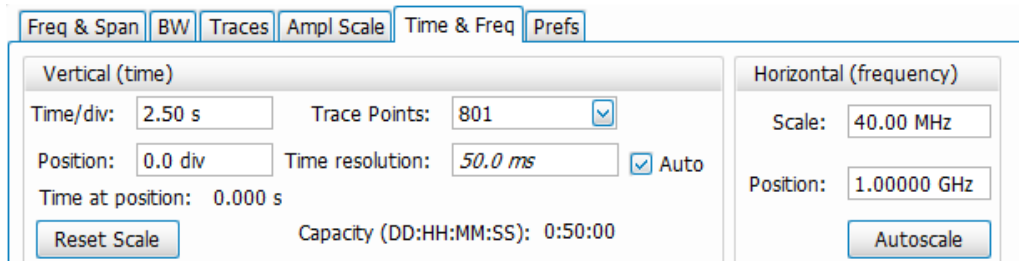

Setting	Description
Vertical (time)	

Table continued...

Setting	Description
Time/div	For most Spectrogram applications. Primary time scale control is Time/div. Time scale can be zoomed in or out when acquisitions are stopped.
Position	The position of the DPXogram record at the bottom of the display. Position cannot be changed while acquisitions are active, and is reset to zero when acquisitions are started again.
Time at position	Displays the time of the DPXogram line shown at the bottom of the graph. This time is relative to the Time Zero Reference of the current acquisition. If Position is set to a negative value, the Time at position readout will be blanked.
Reset Scale	Sets the Time/div and Position settings to their default values.
Trace Points	Sets the number of trace points computed for each DPXogram line. These are the points used for marker measurements and for results export.
Time resolution	Specifies the length of time represented by each line in the graph. 'Line time depends on RBW and FFT processing.
Auto	Sets the time represented by each line in the graph to be adjusted by the analyzer (checked) or manually (when unchecked). When Auto is enabled, Time Resolution change based on Time/div.
Capacity	Readout of the total length of time that can be captured. This readout is provided so that you can see how changing the Trace Points and Time resolution affects the amount of data that can be captured. Capacity is represented in the format dd:hh:mm:ss.
Horizontal (frequency)	
Scale	Sets the displayed frequency range of the graph. This control affects only visual scaling, and does not change the acquisition or analysis parameters.
Position	Sets the frequency displayed at the center of the graph. Changing this value does not change the Frequency setting.
Autoscale	Sets the frequency scale to the Spectrogram Span value.

Density Tab

The Density tab specifies the parameters of the measurement box used for measuring average signal density of an area in the bitmap. The measurement box is also used by DPX Density triggering.

Show measurement
 (measurement always visible for DPX Trigger)

Freq & Span | BW | Traces | Horiz & Vert Scale | Bitmap Scale | Prefs | **Density**

Measurement box
 Frequency: +/-
 Amplitude: +/-

To measure the average signal density over a rectangular portion of the DPX bitmap, you can adjust the size and location of the measurement area using these controls, or by dragging the measurement box in the graph. You move the box by dragging the readout. You adjust the size of the box by dragging the corners or edges.

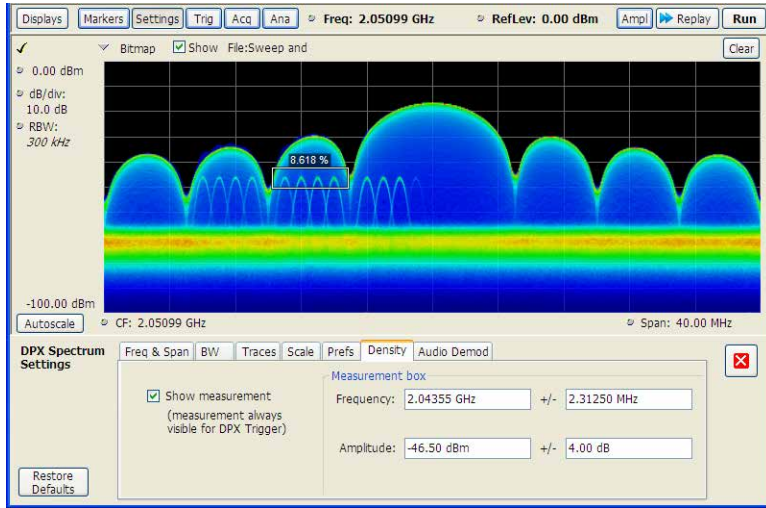

Setting	Description
Show Measurement	Shows or hides the measurement box in the graph when Triggering is not set to DPX Density. If Triggering is set to DPX Density, the measurement box is always visible.
Frequency	Specifies the frequency at the center of the measurement box. The +/- value specifies the width of the measurement box.
Amplitude	Specifies the amplitude of the center of the measurement box. The +/- value specifies the height of the measurement box.

Time Overview Display

The Time Overview display shows the entire acquisition record and shows you how the spectrum time and analysis time fit within the acquisition record. This enables you to see how you can adjust the spectrum time and analysis time to measure portions of the data.

You can specify the maximum number of trace points in the Time Overview display. You can set the maximum number of trace points to 1K, 10K, 100K, 1M points or to Never decimate. If the Acquisition Length includes more than 10,000 sample points (and Max trace points is not set to Never decimate), the trace is decimated (using the +Peak method, similar to +Peak detection in a Spectrum display) to 10,000 points. This decimated trace is what is used for marker measurements.

The Time Overview window displays the Spectrum Length and Analysis Length. The Spectrum Length is the period of time within the acquisition record over which the spectrum is calculated. The Analysis Length is the period of time within the acquisition record over which all other measurements (such as Amplitude vs. Time) are made. The Spectrum Length and Analysis Length can be locked together so that the data used to produce the Spectrum display is also used for measurement displays; however, they do not have to be tied together. They are by default specified separately and used to analyze different parts of the acquisition record.

When connected to MSO/LPD, time overview display for given source will have its own analysis, spectrum time and offset. You can analyze different portions of acquisition record for different sources independently by configuring in time overview display or in analysis control panel that is each Source can be configured to its own Time Mode (Analysis, Spectrum and Linked), Offset and Length.

Elements of the Time Overview Display

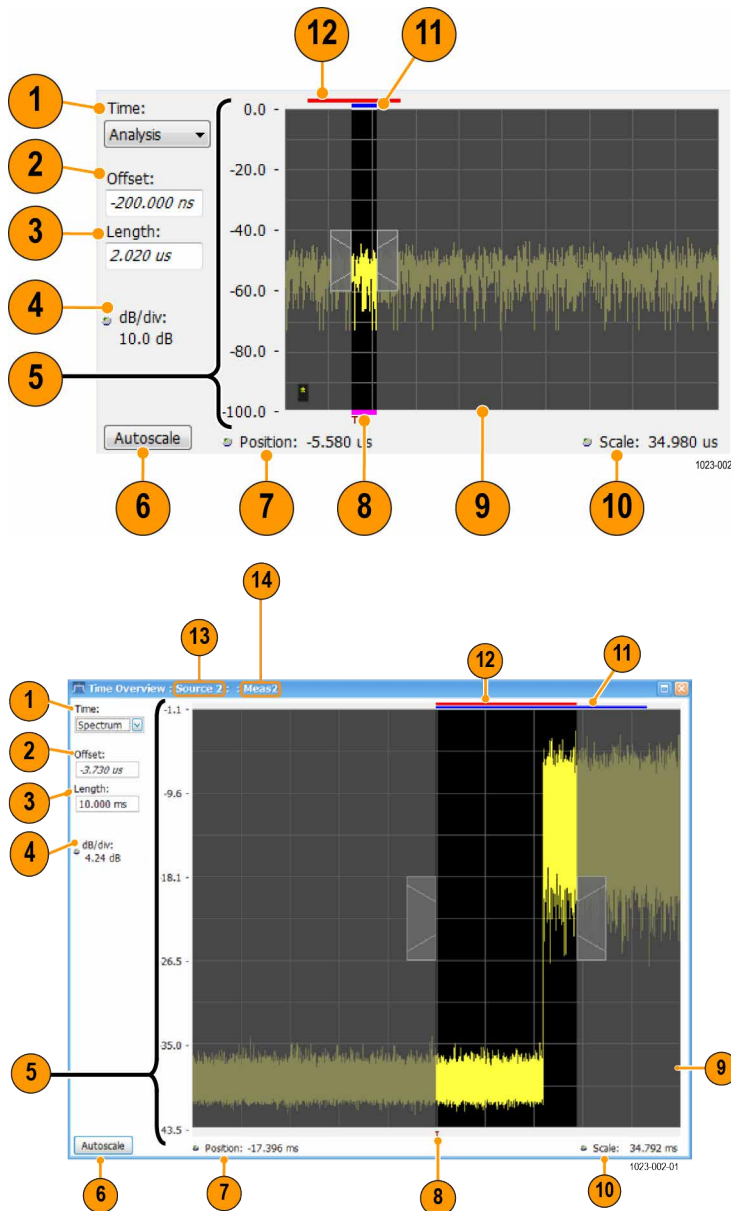

The above figure is shown when connected to MSO/LPD.

Item	Element	Description
1	Time	Select the type of time analysis to be performed. You can select Analysis, Spectrum, or Linked.
2	Offset	Sets the offset of the selected analysis time control.
3	Length	Sets the length of the selected analysis time control.

Table continued...

Item	Element	Description
4	Position and Scale	Adjusts the vertical scale and position.
5	Scale indicators	Shows the vertical scale.
6	Autoscale button	Resets the horizontal scale to display the entire acquisition record and the vertical scale to show all trace points.
7	Horizontal offset	Adjusts the horizontal offset.
8	Results Timeline	This fuchsia line indicates the portion of the record actually used for calculating the selected result. For example: if a pulse measurement is selected, it shows the period of the specific pulse. For a constellation display, it shows the points included in the demodulation.
9	Amplitude vs. Time graph	The trace represents the entire acquisition record (at full horizontal scale). The graph indicates the Analysis Length or Spectrum Length on the graph with a darker background.
10	Horizontal Scale	Adjusts the span of the graph. By decreasing the scale, the graph essentially becomes a window that you can move over the acquisition record by adjusting the offset.
11	Spectrum Length and Offset Indicator (red line, top of graph)	This red line indicates the Spectrum Length and Offset. The longer the time, the longer the bar. Adjusting the offset shifts the bar left or right.
12	Analysis Length and Offset Indicator (blue line, top of graph below red line)	The blue line indicates the Analysis Length and Offset. The longer the time, the longer the bar. Adjusting the offset shifts the bar left or right.
When connected to MSO/LPD		
13	Source	Source corresponds to selected display.
14	Measurement Instance number	Represents the instance of measurement display created.



Note: The area with black background (not gray) in the Amplitude vs. Time Graph highlights the control selected in the Analysis Time Control drop-down list.

[Changing the Time Overview Display Settings](#)

Time Overview Settings

Main menu bar: **Setup > Settings**



The Setup settings for Time Overview are shown in the following table.

Settings tab	Description
Scale	Adjusts the vertical and horizontal scale and offset of the display.

Table continued...

Settings tab	Description
Trace	Allows you to select the types of trace to display and its function.
Prefs	Specifies whether or not certain display elements are shown.

Navigator View

The Time Overview Navigator View places the Time Overview display across the top of the application screen. This allows you to adjust the area of interest in the Navigator View and see the results simultaneously in the other displays. For example, in the following image, adjusting the mask in the Navigator View moves the trace and markers in all of the other displays.

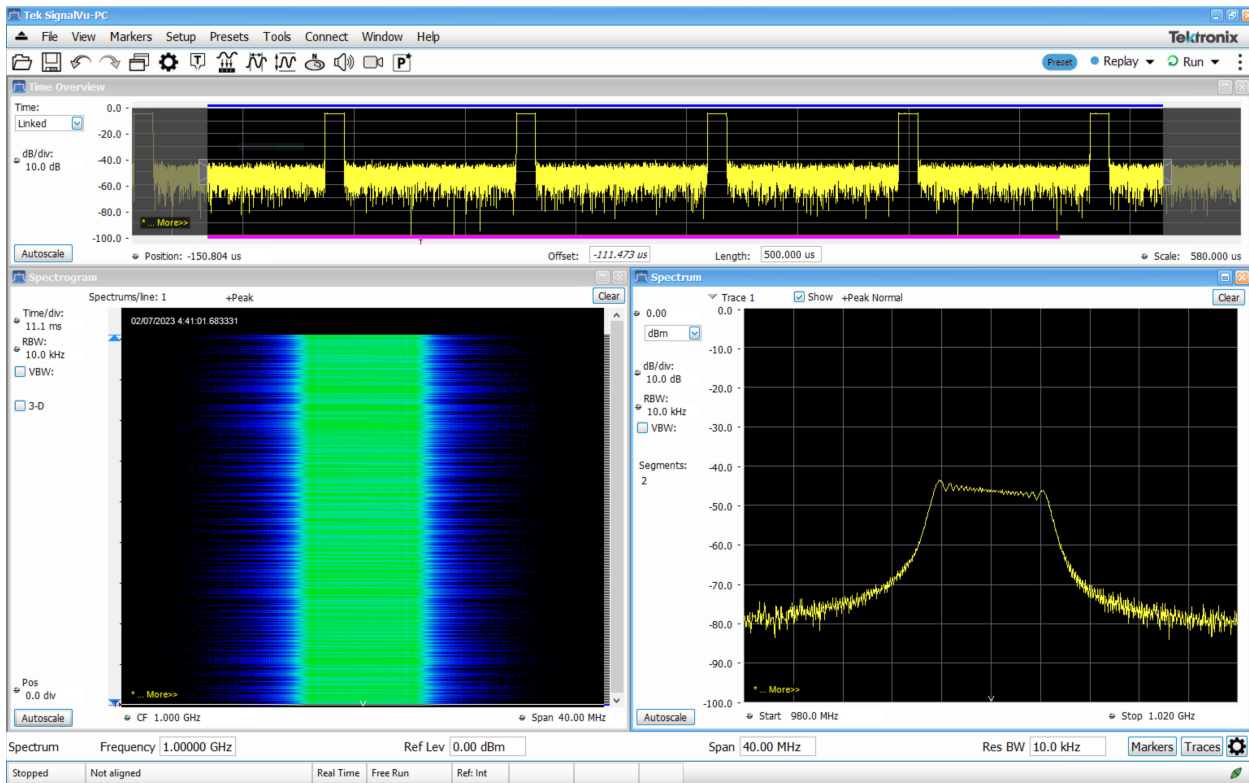

When connected to MSO/LPD, Time Overview Navigator View places the Source 1 Time Overview display across the top of the application screen as shown in the picture below.

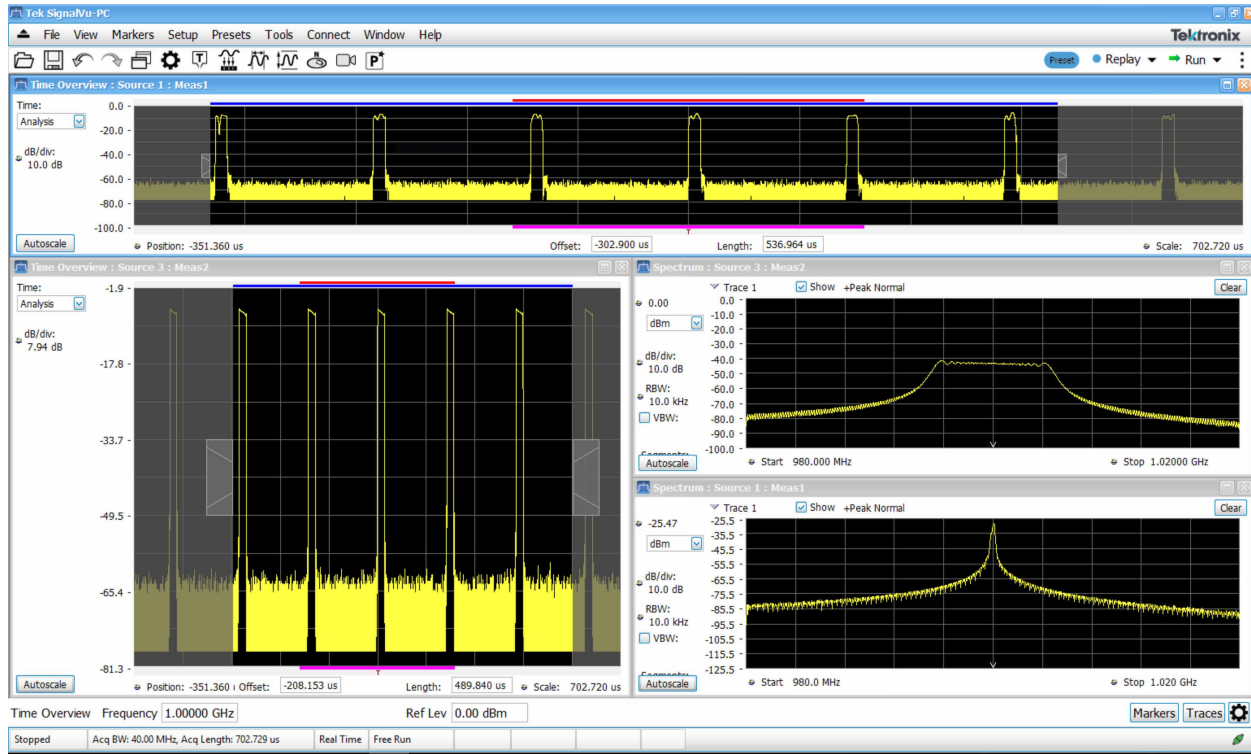
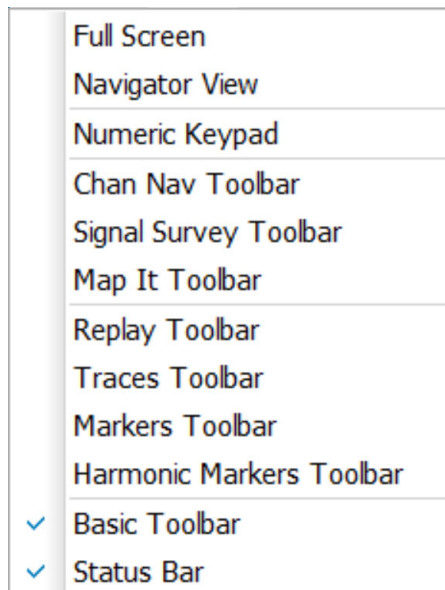

Figure 41: Navigator view when connected to MSO/LPD

Show Navigator View

To show the Navigator View, select **View > Navigator View**. To remove the Navigator View, deselect Navigator View in the View menu.



Trace Tab

The Trace Tab allows you to set the display characteristics of displayed traces.

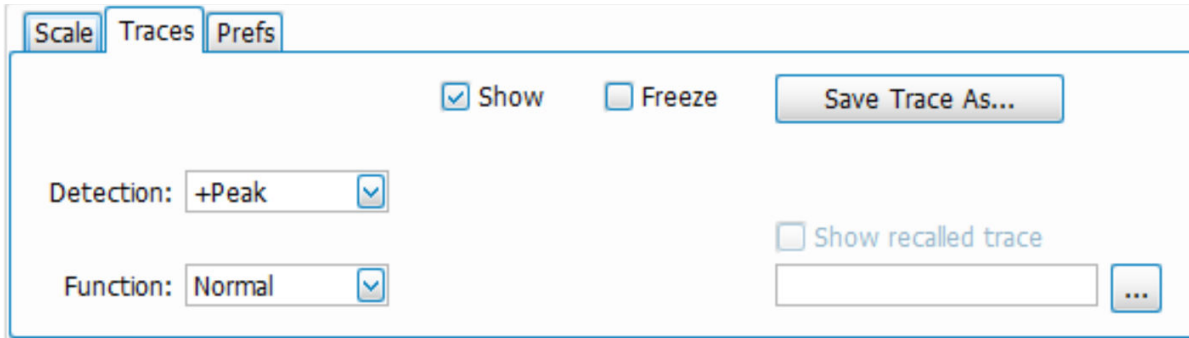

Setting	Description
Show	Shows / hides the selected trace.
Detection	Sets the Detection method used for the trace. Not available for saved traces. Available detection methods are +Peak, -Peak, +/-Peak, Avg (VRMS), and Sample. Not all detection methods are available in all displays.
Function	Selects the trace processing method. Available settings are: Normal, Average, Max Hold, and Min Hold.
(Number of Traces)	Sets the number of traces averaged to generate the displayed trace. (Present only when Function is set to Average.)
Freeze	Halts updates to the selected trace.
Save Trace As	Saves the selected trace to a file for later recall and analysis.
Show Recalled trace	Displays a saved trace instead of a live trace.

Detection

Trace Detection occurs when the trace is being decimated by the measurement. For example, if the maximum number of trace points is 100,000, and the selected analysis region is 200,000 samples, the measurement must decimate the 200,000 resulting trace points by 2 to prevent exceeding the 100,000 trace point limit. Since only one value can be selected for each trace point, an algorithm must be used to select (detect) the appropriate value to use.

The IQ samples in a data acquisition can be detected in a variety of ways. The number of IQ samples available to each trace point varies with both analysis length and trace length. For example, with Spectrum Length set to 'Auto' in the Analysis menu, the instrument analyzes just enough samples to produce one IQ sample pair per trace point. In this case, the detection method chosen has very little effect, as the +Peak, -Peak, Avg (VRMS) and Sample values are all equal. Changing the Spectrum Length causes the available detection methods to differ in value because they have a larger set of samples for the various detection methods to process.

The available detection methods (depending on the display) are:

- **+Peak** – Each point on the trace is the result of detecting the positive peak value present in the set of IQ samples available to that trace point.
- **-Peak** – Each point on the trace is the result of detecting the negative peak value present in the set of IQ samples available to that trace point.

- **+/-Peak** – Selects the highest and lowest values of all the samples contained in two consecutive acquisition intervals.
- **Avg (VRMS) [Average V_{RMS}]** – Each point on the trace is the result of determining the RMS Voltage value for all of the IQ samples available to the trace point. When displayed in either linear (Volts, Watts) or Log (dB, dBm), the correct RMS value results. When the averaging function is applied to a trace, the averaging is performed on the linear (Voltage) values, resulting in the correct average for RMS values.
- **Sample** – The result is calculated based on the first sample available in the set of IQ samples for each trace point.

Trace Processing

Traces can be processed to display in different ways. The Function setting controls trace processing.

- **Normal** - Each new trace is displayed and then replaced by the next trace. Each data point contains a single vertical value.
- **Average** - Multiple traces are averaged together to generate the displayed trace. There is one vertical value for each underlying frequency data point. Once the specified number of traces have been acquired and averaged to generate the displayed trace, each new trace takes the place of the oldest trace in the calculation. The **Number of Traces** setting specifies how many traces averaged.
- **Max Hold** - Displays the maximum value in the trace record for each display point. Each new trace display point is compared to the previous maximum value and the greater value is retained for display and subsequent comparisons.
- **Min Hold** - Displays the minimum value in the trace record for each display point. Each new trace display point is compared to the previous minimum value and the lesser value is retained for display and subsequent comparisons.

Saving Traces

To save a trace for later analysis:

1. Select the Save icon . This displays the **Save As** dialog box.
2. Navigate to the desired folder or use the default.
3. Type a name for the saved trace and click **Save**.

Recalling Traces

You can recall a previously saved trace for analysis or comparison to a live trace.

To select a trace for recall:

1. Select the trace into which the recalled trace will be loaded, from the Trace drop-down list.
2. Check the **Show** check box.
3. Click the ... button to display the Open dialog box.

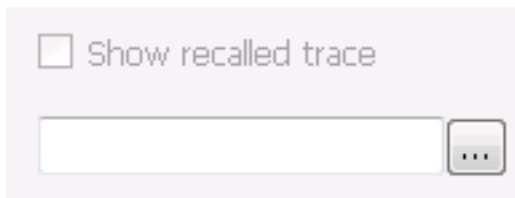

4. Navigate to the desired file and click **Open**.
5. Check the **Show Recalled Trace** check box.
6. Verify that the trace's **Show** check box is selected (either on this tab or next to the drop-down list located at the top-left corner of the graph).

Spectrum Display

When connected to MSO/LPD, multiple incoming signals from different sources (RF / IQ / Differential IQ) can be acquired, analyzed and results viewed at same time in multiple displays.

To display a spectrum:

1. Click the **Displays** button or select **Setup > Displays**.
2. Select **Source** from the drop-down list.
3. From the Measurements box, select **General Signal Viewing**.
4. Double-click the **Spectrum** icon in the **Available displays** box. This adds the Spectrum icon to the **Selected displays** box (and removes it from the Available displays box). Alternatively, you can click the Spectrum icon and then click the Add button to select Spectrum for display.
5. Click the **OK** button.

Elements of the Spectrum Display

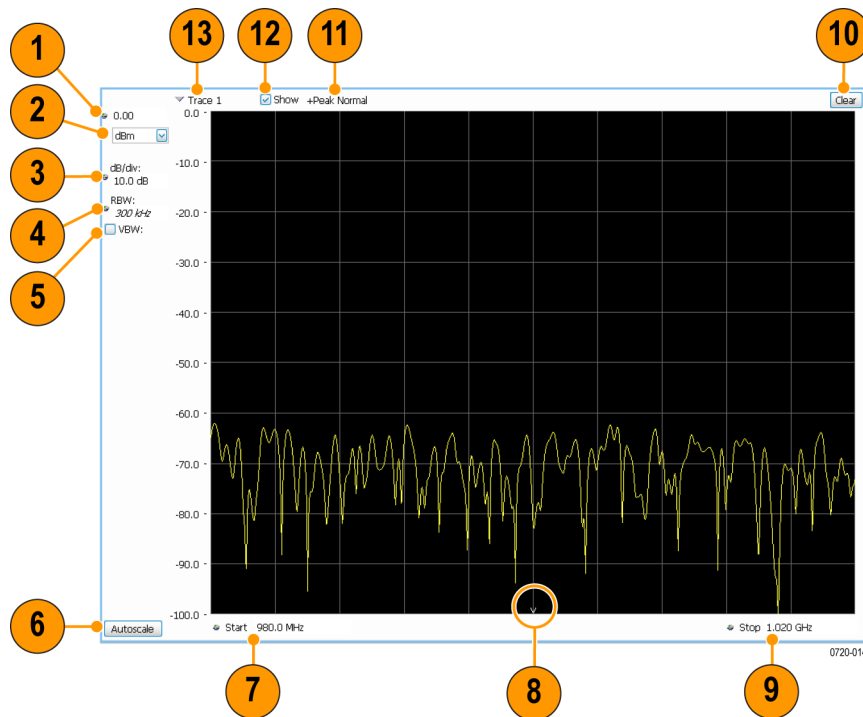

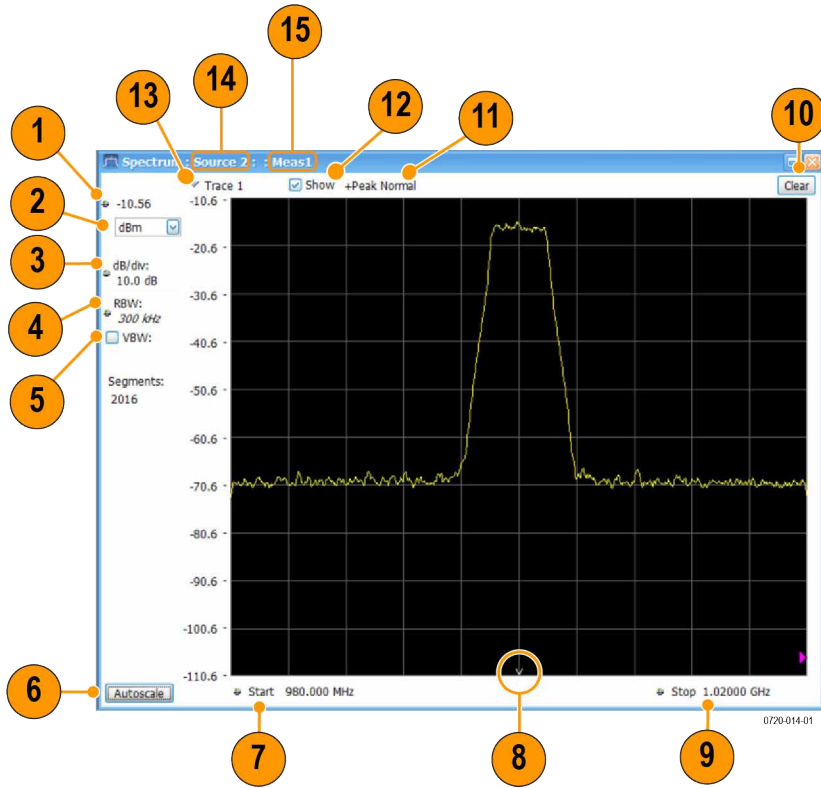

The above figure is shown when connected to MSO/LPD.

Item	Display element	Description
1	Vertical position	Sets the top of graph value. This is only a visual control for panning the graph. The Reference Level is adjusted in the Toolbar and the Amplitude control panel. By default, Vert Position = Ref Level.
2	Units	Sets the global Amplitude units for all the views in the analysis window. This will change the Amplitude selection in the Units tab of Analysis Control panel.
3	dB/div	Sets the vertical scale value. The maximum value is 20.00 dB/division.
4	RBW	Sets the resolution bandwidth. Note that when the RBW is set to Auto, its value is italicized.
5	VBW	Enables the VBW (Video Bandwidth) filter. See Setup > Settings > BW Tab on page 136.
6	Autoscale	Adjusts the Vertical and Horizontal scaling to display the entire trace on screen.
7	Position	Default function is CF - center frequency (equivalent to the Freq setting). If Horizontal scaling has been manually adjusted in Settings > Scale, then Offset will replace CF as the setting at the bottom-left corner of the screen.
8	CF indicator	Indicates the center frequency.

Table continued...

Item	Display element	Description
9	Span / Scale	Default function is Span - frequency difference between the left edge of the display and the right edge. If Horizontal scaling has been manually adjusted in Settings > Scale, then Scale will replace Span as the setting at the bottom-right corner of the screen.
10	Clear	Restarts multi-trace functions (Avg, Hold).
11	Function	Readout of the Detection and Function selections for the selected trace.
12	Show	Controls whether the selected Trace is visible or not. When trace is Off, the box is not checked.
13	Trace	Selects a trace. Clicking here pops up a context menu listing the available traces, whether they are enabled or not. If you select a trace that is not currently enabled, it will be made enabled.
When connected to MSO/LPD		
14	Source	Source corresponds to selected display.
15	Measurement Instance number	Represents the instance of measurement display created.

Changing the Spectrum Display Settings

Spectrum Settings

Main menu bar: Setup > Settings



The settings for the Spectrum display are shown in the following table.

Settings tab	Description
Freq & Span	Sets frequency and span parameters for the Spectrum Analysis display.
BW	Sets Resolution Bandwidth and windowing parameters.
Traces	Sets Trace display parameters.
Traces (Math)	Sets the traces used to create the Math trace.
Scale Tab on page 112	Sets vertical and horizontal scale and position parameters.
Prefs Tab on page 139	Specifies whether or not certain display elements are shown.

Scale Tab

The Scale tab allows you to change the vertical and horizontal scale settings. Changing the scale settings changes how the trace appears on the display but does not change control settings such as Measurement Frequency. In effect, these controls operate like pan and zoom controls.

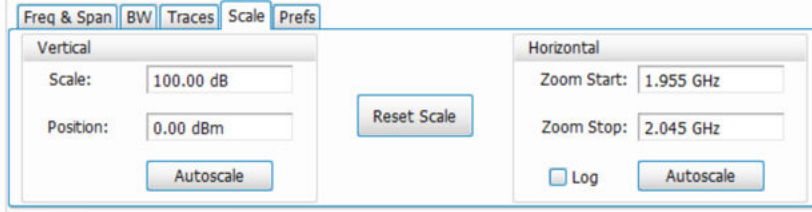

The above figure shows the scale tab when connected to MSO/LPD

Setting	Description
Vertical	
Scale	Changes the vertical scale.
Position	Vertical Position adjusts the top of graph amplitude value. This control allows you to move (“pan”) the traces up and down in the graph without changing the Reference Level.
Autoscale	Resets the Offset so that the trace appears below the top of the graph.
Horizontal	
Scale	Allows you to change the range of frequencies shown in the graph without changing the span or measurement frequency.
Position	Allows you pan the graph.
Autoscale	Resets Scale to the Span setting.
Reset Scale	Resets all settings to their default values.
Log scale	Resets the display to show the frequency axis in a logarithmic scale.

Spectrogram Display

The Spectrogram is a display with the vertical axis (time) composed of successive spectral displays, each having the amplitude represented by color or intensity. The horizontal axis represents frequency. The most recently acquired spectrum results are added to the bottom of the spectrogram. The addition of a new spectrum can occur at the fastest rate that new spectra can be plotted, or, if you choose, new spectra can be added at a timed rate. The spectrogram view is well-suited to displaying long-term trends of spectral data. The maximum number of lines that can be displayed in a spectrogram is 31,250.

The spectrogram can also be displayed in a 3-D waterfall format. In the 3-D waterfall format, the spectrogram displays the time axis along a simulated Z-axis.

When Connected with MSO/LPD, multiple incoming signals from different sources (RF / IQ / Differential IQ) can be acquired, analyzed and the results can be viewed at same time in multiple displays.

 **Note:** Spectrogram data is shared with the Spectrum display. There is no linkage between DPX and Spectrogram.

To display a Spectrogram:

1. Select the **Displays** button or select **Setup > Displays**. This displays the **Select Displays** dialog box.
2. Select **Source(s)** from drop-down list.
3. From the **Measurements** box, select **General Signal Viewing**.
4. Double-click the **Spectrogram** icon in the **Available Displays** box. This adds the Spectrogram icon to the Selected displays box.
5. Click the **OK** button. This displays the spectrogram view.
6. To display a 3-D version of the spectrogram, select the 3-D checkbox.

Elements of the Spectrogram Display

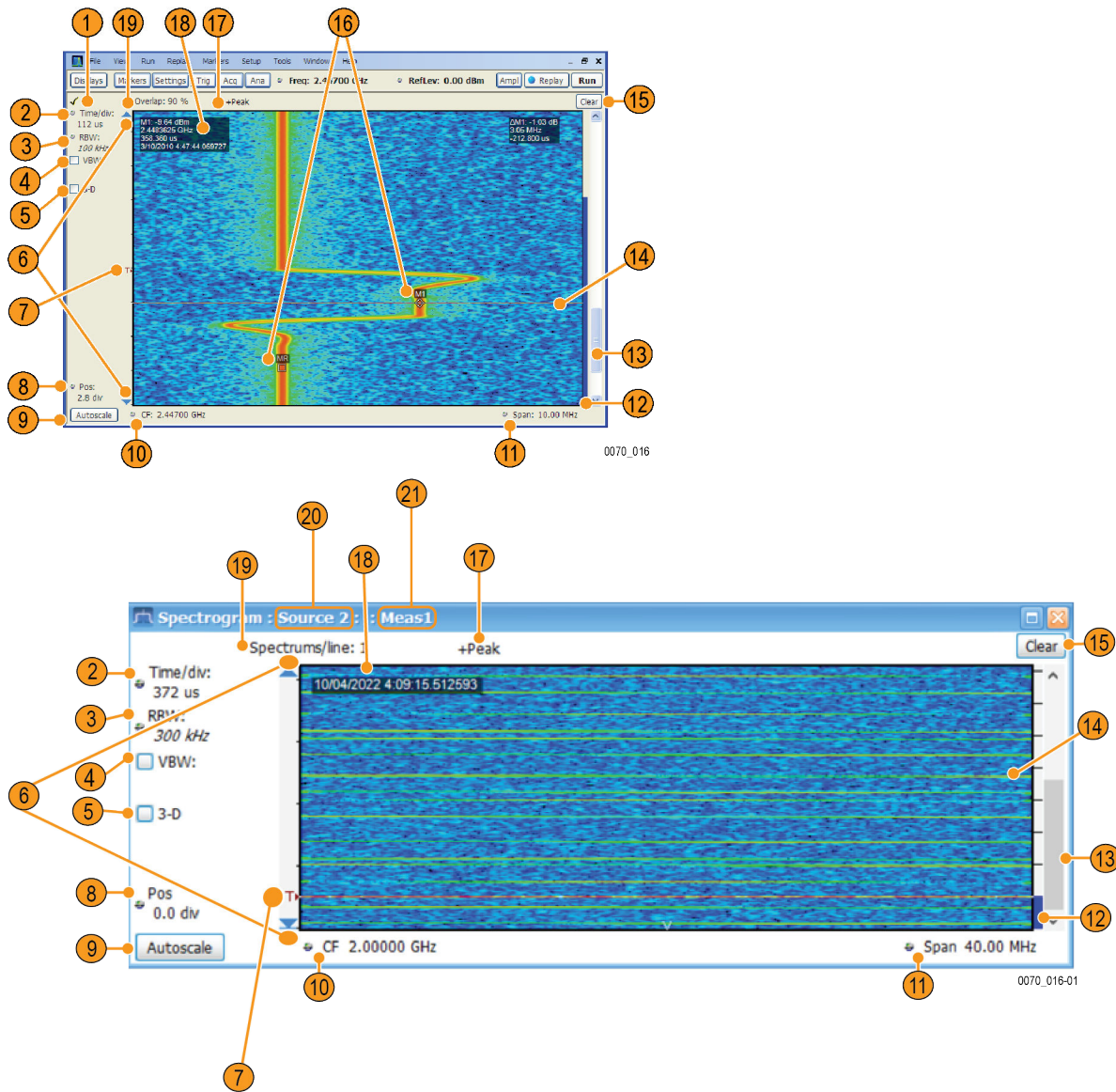

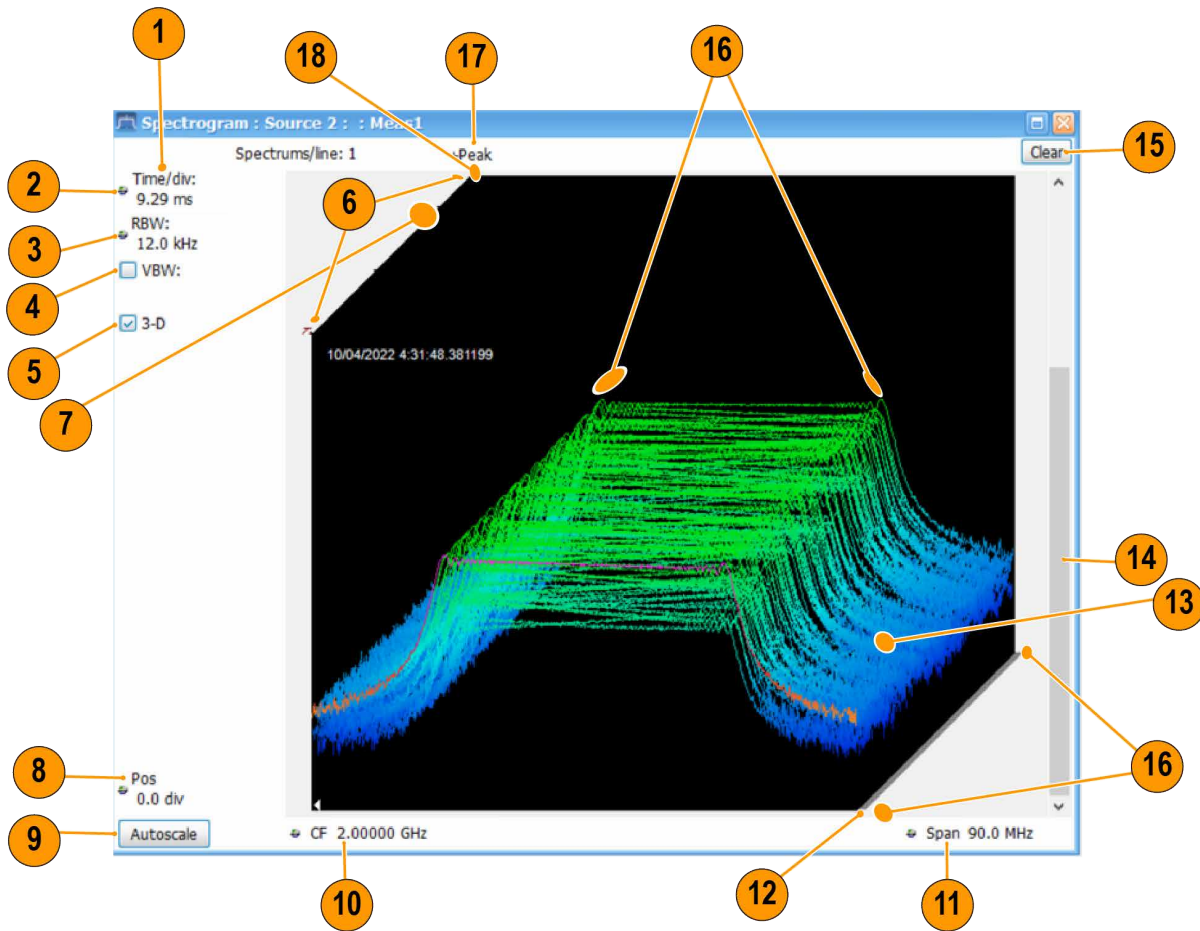
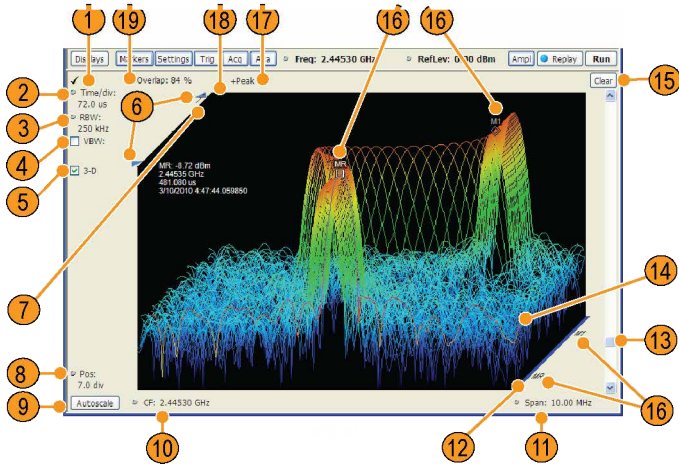

The above figure is shown when connected to MSO/LPD.

Item	Display element	Description
2	Time/div	Sets the length of time represented by each vertical division. Divisions are indicated by tick marks along the left edge of the graph.

Table continued...

Item	Display element	Description
3	RBW	Sets the resolution bandwidth. Note that when the RBW is set to Auto, its value is italicized.
4	VBW	Enables the VBW (Video Bandwidth) filter. See Setup > Settings > BW Tab on page 136 .
5	3-D checkbox	Enables and disables the 3-D view.
6		Shows the positions of the start and stop records selected on the Select data records tab. Drag the indicators to select which records will be played by Replay All. Note that these are not visible while acquisitions are running; the instrument must be stopped for the indicators to be visible.
7	Selected records indicators	Trigger indicator. This icon indicates the trigger point within the current acquisition.
8	Pos	Position indicates the bottom line visible in graph. Changing this setting scrolls the window up and down through the displayed acquisition records.
9	Autoscale	Resets Vertical and Horizontal scale and Pos to default values.
10	CF	Sets the Center Frequency.
11	Span	Sets the span of the spectrogram display.
12	Current data record indicator	A blue line indicates the current data record. When the analysis length is short, the blue line appears as a thin line much like the selected indicator line. When the analysis length is relatively long, the blue line appears more like a blue bar.
13	Position scroll bar	Changes the position of the trace in the window. Changing the position scroll bar is the same as adjusting the Pos setting.
14	Selected indicator	This inverse-colored line indicates the Spectrogram line that will appear in the Spectrum display when the Spectrogram trace is enabled. This line is attached to the selected marker.
15	Clear	Clears the spectrogram display; however, data records in acquisition history remain in memory and are available for replay. To clear memory, select File > Acquisition Data Info > Delete All Data .
16	Marker Indicators	These icons indicate the position of markers in the spectrogram. You can move markers by dragging the desired marker indicator.
17	Detection setting	Displays the selected Detection method (see Trace Tab on page 117 tab).
18	Marker readout	Marker readout for the selected marker. In the Spectrogram display, the marker readout includes a date and timestamp. The time is displayed in a 24-hour format. The timestamp readout can be shown or hidden independently of the other marker readouts (see Prefs Tab on page 139).

Table continued...

Item	Display element	Description
19	Time Scale status readout	Three readouts can appear here depending on settings: Time/update, Spectrums/line, and Overlap. See Time Scale Status Readout on page 116.
When connected to MSO/LPD		
20	Source	Source corresponds to selected display.
21	Measurement Instance number	Represents the instance of measurement display created.

Time Scale Status Readout

Three types of readouts can appear in the display depending on settings:

- Time/update – Displays minutes:seconds when Spectrum Monitor is selected in the **Settings > Time & Freq Scale** tab in the **Vertical (Time)** section.
- Spectrums/line – Displays an integer number when vertical scale is Normal and each line contains the results from one or more frequency transforms (whether zoomed out or not).
- Overlap – Displays the overlap percentage when vertical scale is Normal and each line's transform shares some points with the transforms of lines before and after it (zoomed in). Overlap can only be done when the Analysis Length > 2x RBW frame length.

The Spectrogram can show results from one or multiple acquisitions and it can show one or multiple lines for each acquisition.

[Changing the Spectrogram Display Settings](#)

Spectrogram Settings

Main menu bar: **Setup > Settings**



The Setup settings for the Spectrogram display are visible when Spectrogram is the selected display.

Settings tab	Description
Freq & Span Tab	Sets frequency and span parameters for the Spectrogram display.
BW Tab on page 136	Sets Resolution Bandwidth and windowing parameters.
Trace Tab on page 117	Sets Trace display parameters.
Amplitude Scale Tab on page 117	Selects between 2-D and 3-D, sets height scale, position and orientation for 3-D display. Sets color parameters for the spectrogram trace.
Time & Freq Scale Tab	Sets the vertical and horizontal scale parameters for the spectrogram trace. The Spectrum Monitor controls are also on this tab.
Prefs Tab on page 139	Specifies whether or not certain display elements are shown.

Trace Tab

The Spectrogram Trace tab controls let you specify the Detection method, save traces, and recall saved traces for display. The Spectrogram Trace tab does not have all the controls that other Trace tabs contain, however, it does have a unique display element, the Selected Line readout. For details on Detection, Freeze, and saving and recalling traces, see the [Traces Tab](#) on page 132.



Selected Line

Displays the time at the Selected Line. If Markers are enabled, the selected line is positioned by the selected marker. If no markers are enabled, the selected line is the first line in the current analysis period.

Amplitude Scale Tab

The Amplitude Scale tab allows you to change the vertical and horizontal scale settings, enable the 3-D Waterfall display, and set the color scheme used for the spectrogram trace.

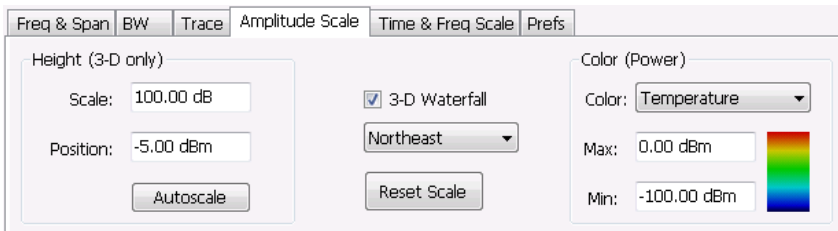

Setting	Description
Height (3-D only)	
Scale	Changes the vertical scale for trace Amplitude in the graph (not the vertical scale for Time).
Position	Specifies the level displayed at the bottom edge of the graph. (Bottom front edge in the 3-D view).
Autoscale	Adjusts the vertical position and scale of the trace lines to bring them into the visible portion of the graph.
3-D Waterfall	Displays the spectrogram in a 3-D format.
Northeast	Shifts the perspective of the 3-D graph so that the oldest traces move back and to the right.
Northwest	Shifts the perspective of the 3-D graph so that the oldest traces move back and to the left.
Reset Scale	Resets the Height and Color settings to their default values.

Table continued...

Setting	Description
Color (Power)	
Color	Displays a drop-down list that allows you to set the color scheme used for the spectrogram trace.
Max	Sets the maximum power level represented by the top of the color scale.
Min	Sets the minimum power level represented by the bottom of the color scale.

Time & Freq Scale Tab

The Time and Freq Scale tab allows you to change the vertical and horizontal scale settings, enable the 3-D Waterfall display, and set the color scheme used for the spectrogram trace.

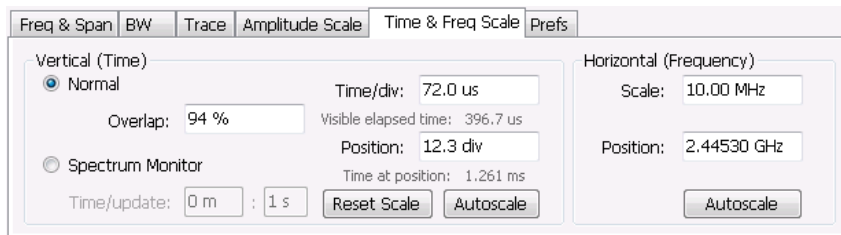

Setting	Description
Vertical (Time)	
Normal	For most Spectrogram applications. Primary time scale control is Time/div. Time scale can be zoomed in or out.
Spectrum Monitor	For long-term signal monitoring applications. In spectrum monitor mode, each line in the spectrogram represents the period of time specified by the Time/update parameter. Time scale can be zoomed out, but not zoomed in (no overlap).
Time/update	Sets the time, in minutes and seconds, represented by each line of the spectrogram. Only available in Spectrum Monitor.
Reset Scale	Resets the Time/div and Pos settings to their default values.
Autoscale	Scales the vertical (time) axis to compress all existing trace lines into the visible area of the graph. Resets the Position value to zero, placing the most recent spectrogram line at the bottom of the spectrogram display. Only Position is affected by Autoscale when Spectrum Monitor is selected.
Time/div	Sets the time displayed per division.
Visible elapsed time	Displays the length of time visible in the display. This does not represent the total time available to view.

Table continued...

Setting	Description
Position	Adjusts vertical position of the trace within the graph area. Setting represents the offset, in divisions, between the bottom of the graph and the bottom (most recent) line in the results trace.
Time at position	Displays the time of the spectrogram line shown at the bottom of the graph. This time is relative to the Time Zero Reference of the current acquisition.
Horizontal (Frequency)	
Scale	Sets the frequency range of the graph without changing the Span value.
Position	Sets the frequency displayed at the center of the graph. Changing this value does not change the Freq setting.
Autoscale	Sets the frequency scale to the Spectrogram Span value.

Spectrum Monitor

Spectrum Monitor performs long term monitoring. The monitor mode compresses time into each line of the spectrogram, which enables you to monitor long periods of time (from 1 second per line up to 600 minutes per line). You can capture up to 31,250 lines.

During each line's collection period, spectrum transforms are computed for each acquisition taken by the instrument. As each transform completes, it is incorporated into the current spectrogram line. How each line of the spectrogram is created in spectrum monitor mode depends on the detection setting (Settings > Trace). For example, if Detection is set to +Peak, each spectrogram line is effectively a peak hold display of all the spectral data captured since the prior line.

Amplitude Vs Time Display

The Amplitude vs. Time display plots the signal amplitude against time. The amplitude appears on the vertical axis while time is plotted along the horizontal axis.

Note that the trace(s) in the Amplitude vs. Time display can be set to a maximum of 100,000 points (however, the actual number of trace points can extend up to 1,000,000 points if Max trace points is set to Never Decimate). If the Analysis Length includes more than the selected Max trace points value, the trace is decimated (using the method specified with the Detection control) to be equal to or less than the Max trace points setting (except when Max trace points is set to Never Decimate). This decimated (or undecimated) trace is what is used for marker measurements and for results export. You can set the Max trace points on the **Settings > Prefs** tab.

To show Amplitude vs. Time display:

1. Press the **Displays** button or select **Setup > Displays**.
2. Select **Source(s)** from drop-down list.
3. In the **Select Displays** dialog, select **General Signal Viewing** in the **Measurements** box.
4. In the **Available displays** box, double-click the **Amplitude vs. Time** icon or select the icon and click **Add**. The Amplitude vs. Time icon will appear in the **Selected displays** box and will no longer appear under Available displays.
5. Click **OK**.

Elements of the Display

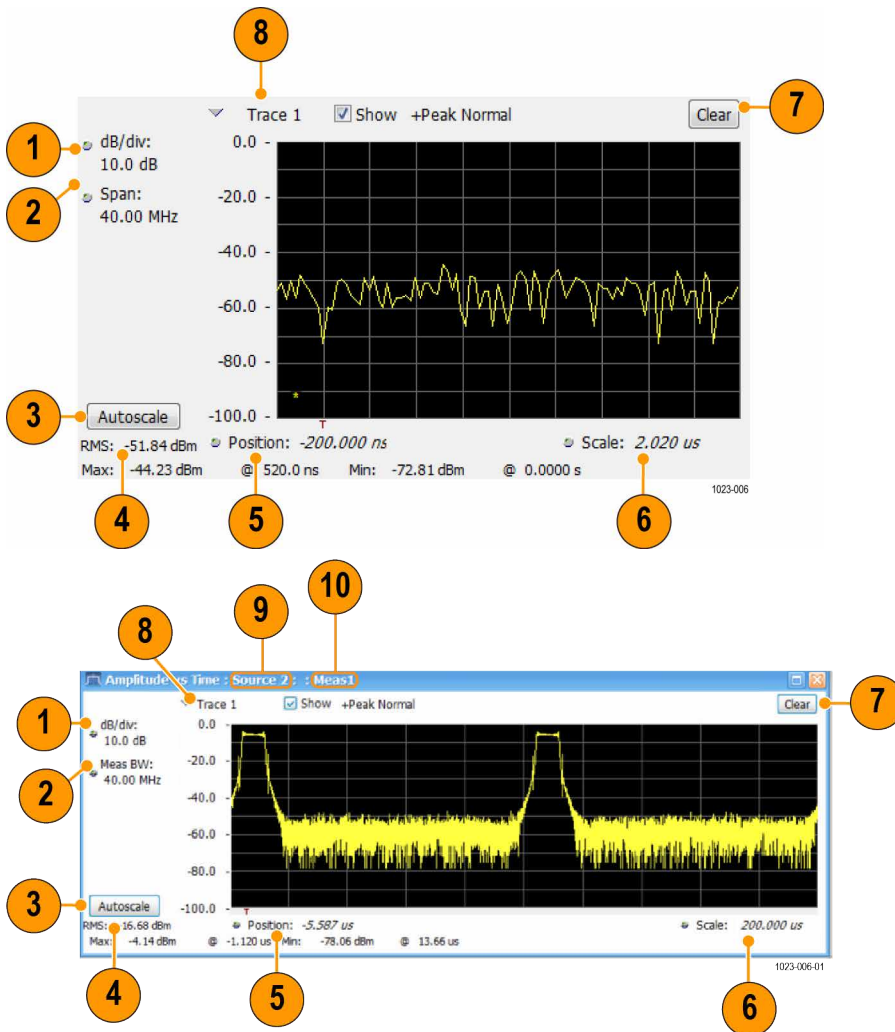

The above figure is shown when connected to MSO/LPD

Item	Display element	Description
1	Vertical scale adjustment	Adjusts the vertical scaling.
2	Span	Adjust the bandwidth of the data to be analyzed. (Not the period of time shown in the display.)
3	Autoscale	Adjusts the vertical and horizontal settings to provide the best display.
4	Offset	Adjust the horizontal offset.
5	Max and Min readouts	Displays the maximum and minimum amplitudes, as well as when those values occur.
6	Scale	Sets the time spanned by the graph.

Table continued...

Item	Display element	Description
7	Clear button	Restarts multi-trace functions (Avg, Hold).
8	Trace function	Displays the current trace function setting (Settings > Trace tab > Function).
When connected to MSO/LPD		
9	Source	Source corresponds to selected display.
10	Measurement Instance number	Represents the instance of measurement display created.

Reference. [Changing Amplitude vs Time Display Settings](#)

Amplitude Vs Time Settings

Main menu bar: Setup > Settings



The settings for the Amplitude vs. Time display are shown in the following table.

Settings tab	Description
Freq & BW Tab	Sets the Bandwidth Method used for setting the measurement bandwidth.
Traces Tab on page 132	Allows you to select the type of trace to display and their functions.
Traces (Math)	Sets the traces used to create the Math trace.
Scale Tab on page 137	Sets the vertical and horizontal scale parameters.
Prefs Tab on page 139	Specifies whether certain display elements are visible.

Freq & BW Tab

The Freq > BW (Bandwidth) tab allows you to specify the bandwidth parameters used for setting measurement bandwidth. This determines what Acq BW the measurement will request.

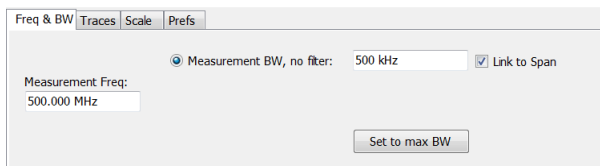

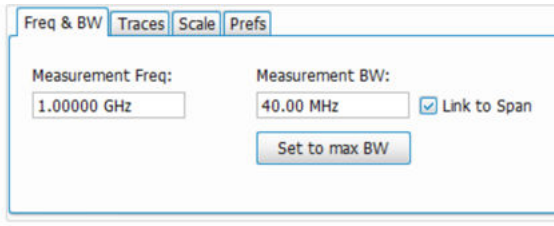

The above figure shows the Freq & BW tab when connected to MSO/LPD

Settings	Description
Measurement BW	This control limits the bandwidth of measurements. You use the measurement bandwidth setting to improve the signal-to-noise ratio of the measurement, resulting in lower measurement uncertainty. However, if the measurement bandwidth is set too low, resulting in fewer samples per second, it can reduce the number of points within the measurement length below the 256 stable samples required, thus causing the analysis to fail.

Frequency Vs Time Display

The Frequency vs. Time Display shows how the signal frequency varies with time.

Note that the trace(s) in the Frequency vs. Time display can be set to a maximum of 100,000 points (however, the actual number of trace points can extend up to 1,000,000 points if Max trace points is set to Never Decimate). If the Analysis Length includes more than the selected Max trace points value, the trace is decimated (using the method specified with the Detection control) to be equal to or less than the Max trace points setting (except when Max trace points is set to Never Decimate). This decimated (or undecimated) trace is what is used for marker measurements and for results export. You can set the Max trace points on the **Settings > Prefs** tab.

When connected to MSO/LPD, multiple incoming signals from different sources (RF / IQ / Differential IQ) can be acquired, analyzed and results viewed at same time in multiple displays.

To display the Frequency vs. Time Display:

1. Select the **Displays** button or **Setup > Displays**.
2. Select **Source(s)** from drop-down list.
3. In the **Select Displays** dialog, select **General Signal Viewing** in the **Measurements** box.
4. In the **Available displays** box, double-click the **Frequency vs. Time** icon or select the icon and click **Add**. The Frequency vs. Time icon will appear in the **Selected displays** box and will no longer appear under Available displays.
5. Click **OK** to display the Freq vs. Time display.

Elements of the Display

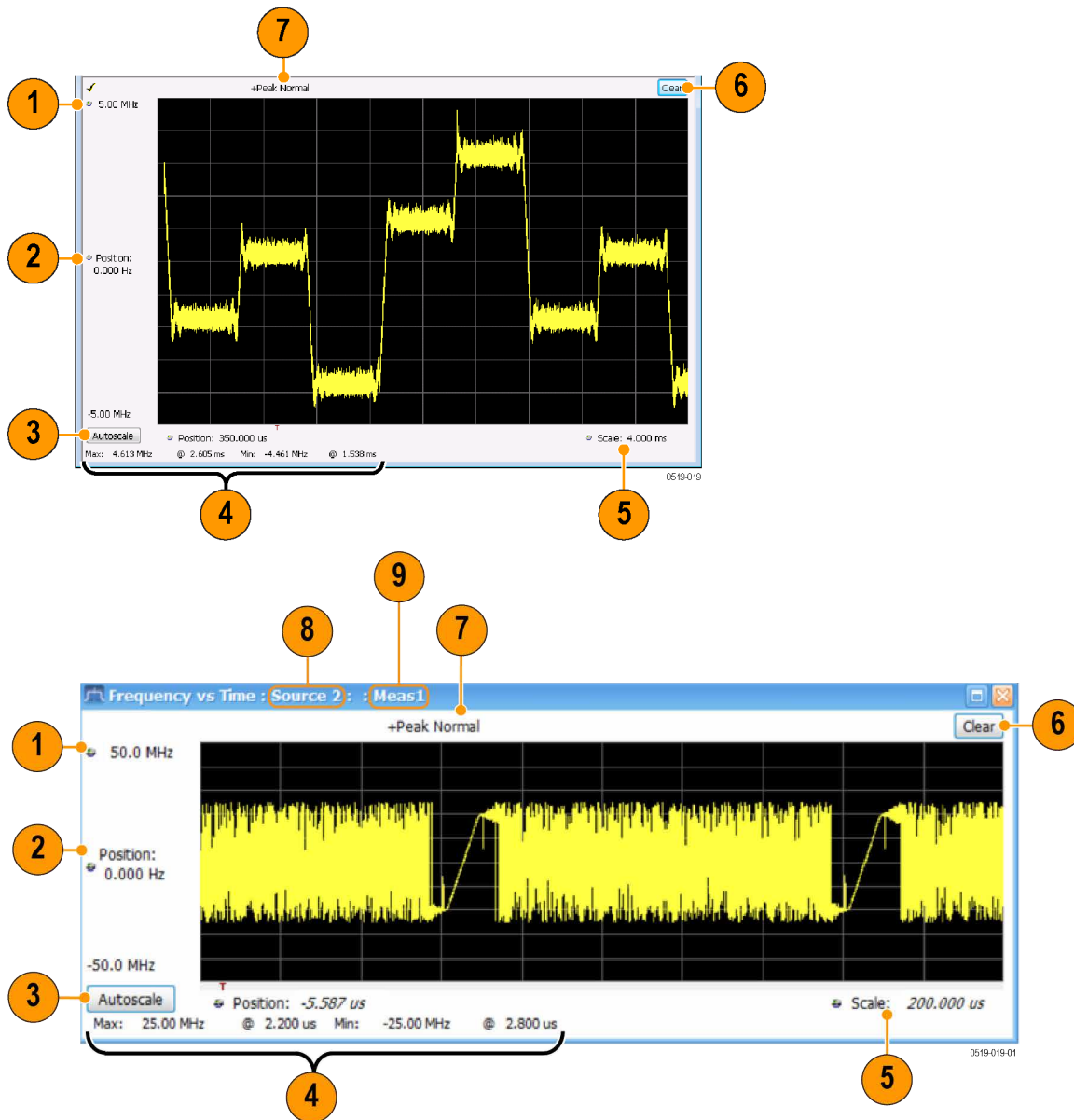

The above figure is shown when connected to MSO/LPD.

Item	Display element	Description
1	Top of graph adjustment	Use the knob to adjust the frequency range displayed on the vertical axis.
2	Offset adjustment	Adjusts the frequency shown at the center of the display.
3	Autoscale button	Adjusts the offset and range for both vertical and horizontal to provide the best display.
4	Maximum and Minimum frequency readouts	Displays the maximum and minimum values, as well as when those values occur.

Table continued...

Item	Display element	Description
5	Horizontal Scale	Sets the time spanned by the graph.
6	Clear button	Restarts Average trace.
7	Trace function	Displays the current trace function setting (Settings > Trace > Function).
When connected to MSO/LPD		
8	Source	Source corresponds to selected display.
9	Measurement Instance number	Represents the instance of measurement display created.

Changing Frequency vs Time Display Settings

Frequency Vs Time Settings

Main menu bar: Setup > Settings



The Setup settings for Frequency vs. Time are shown in the following table.

Settings tab	Description
<i>Freq & BW</i>	Sets the frequency and bandwidth parameters.
<i>Traces</i>	Sets the trace display parameters.
<i>Scale</i>	Sets the Vertical and Horizontal scale and offset parameters.
<i>Prefs</i>	Specifies whether certain display elements are visible.

Phase Vs Time Display

The Phase vs. Time display plots the signal phase against time. The phase appears on the vertical axis while time is plotted along the horizontal axis.

Note that the trace(s) in the Phase vs. Time display can be set to a maximum of 100,000 points (however, the actual number of trace points can extend up to 1,000,000 points if Max trace points is set to Never Decimate). If the Analysis Length includes more than the selected Max trace points value, the trace is decimated (using the method specified with the Detection control) to be equal to or less than the Max trace points setting (except when Max trace points is set to Never Decimate). This decimated (or undecimated) trace is what is used for marker measurements and for results export. You can set the Max trace points on the **Settings > Prefs** tab.

When connected to MSO/LPD, multiple incoming signals from different sources (RF / IQ / Differential IQ) can be acquired, analyzed and results viewed at same time in multiple displays.

To display Phase vs. Time:

1. Press the **Displays** button or select **Setup > Displays**.
2. Select **Source(s)** from the drop-down list.

3. In the **Select Displays** dialog, select **General Signal Viewing** in the **Measurements** box.
4. In the **Available displays** box, double-click the **Phase vs. Time** icon or select the icon and click **Add**. The Phase vs. Time icon will appear in the **Selected displays** box and will no longer appear under Available displays.
5. Click **OK** to show the Phase vs. Time display.

Elements of the Display

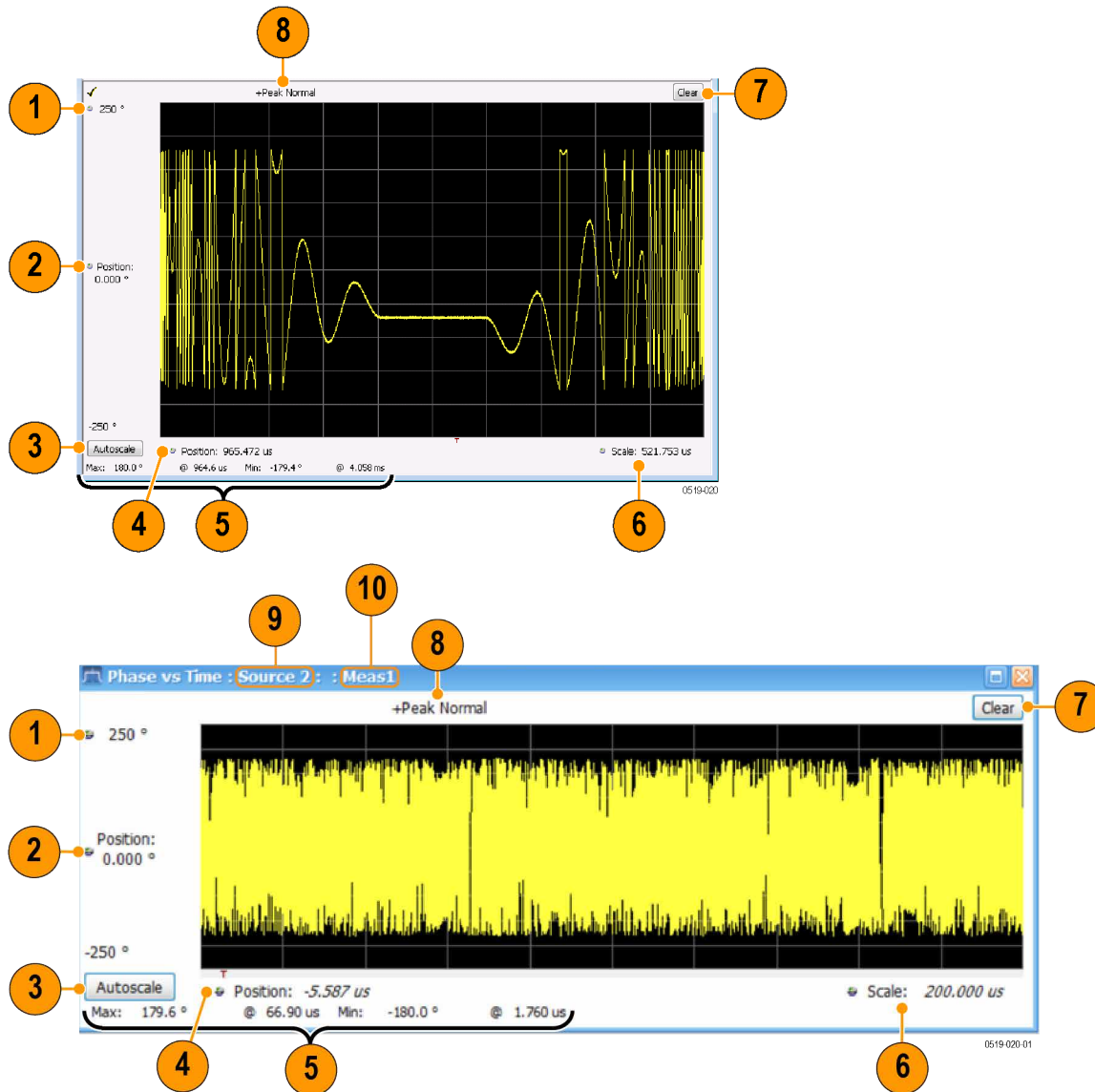

The above figure is shown when connected to MSO/LPD.

Item	Display element	Description
1	Top of graph adjustment	Adjusts the vertical scale. Use the knob to adjust the value of the top of the graph.
2	Vertical offset adjustment	Adjusts the phase error shown at the vertical center of the display.

Table continued...

Item	Display element	Description
3	Autoscale button	Adjusts the vertical and horizontal settings so that the entire trace fits in the view.
4	Horizontal Offset	Adjusts the horizontal position of the trace.
5	Max and Min readouts	Displays the maximum and minimum value of the phase error within the analysis times and the times at which they occurred.
6	Horizontal Scale	Sets the time spanned by the graph.
7	Clear button	Restarts multi-trace functions (Avg, Hold).
8	Trace function	Shows the trace function as set on the Settings > Trace tab.
When connected to MSO/LPD		
9	Source	Source corresponds to selected display.
10	Measurement Instance number	Represents the instance of measurement display created.

Changing the Phase vs Time Display Settings

Phase Vs Time Settings

Main menu bar: Setup > Settings



The settings for the Phase vs. Time display are shown in the following table.

Settings tab	Description
<i>Freq & BW</i>	Sets the frequency and bandwidth parameters.
<i>Traces</i>	Sets the trace display parameters.
<i>Scale</i>	Sets the Vertical and Horizontal scale and offset parameters.
<i>Prefs</i>	Specifies whether certain display elements are visible.

RF I & Q vs Time Display

This is a plot of the baseband In-Phase (I) and Quadrature (Q) components of a modulated carrier. The plot is in the time domain, with I and/or Q values the Y-axis.

Note that the trace(s) in the RF I & Q vs. Time display can be set to a maximum of 100,000 points (however, the actual number of trace points can extend up to 1,000,000 points if Max trace points is set to Never Decimate). If the Analysis Length includes more than the selected Max trace points value, the trace is decimated (using the method specified with the Detection control) to be equal to or less than the Max trace points setting (except when Max trace points is set to Never Decimate). This decimated (or undecimated) trace is what is used for marker measurements and for results export. You can set the Max trace points on the **Settings > Prefs** tab.

When connected to MSO/LPD, multiple incoming signals from different sources (RF / IQ / Differential IQ) can be acquired, analyzed and results viewed at same time in multiple displays.

To display an RF I & Q vs. Time display:

1. Select the **Displays** button or select **Setup > Displays**. This shows the **Select Displays** dialog box.
2. Select **Source(s)** from the drop-down list.
3. From the **Measurements** box, select **General Signal Viewing**.
4. Double-click the **RF I & Q vs. Time** icon in the **Available Displays** box. This adds the RF I & Q vs. Time icon to the **Selected displays** box.
5. Click the **OK** button.

Elements of the Display

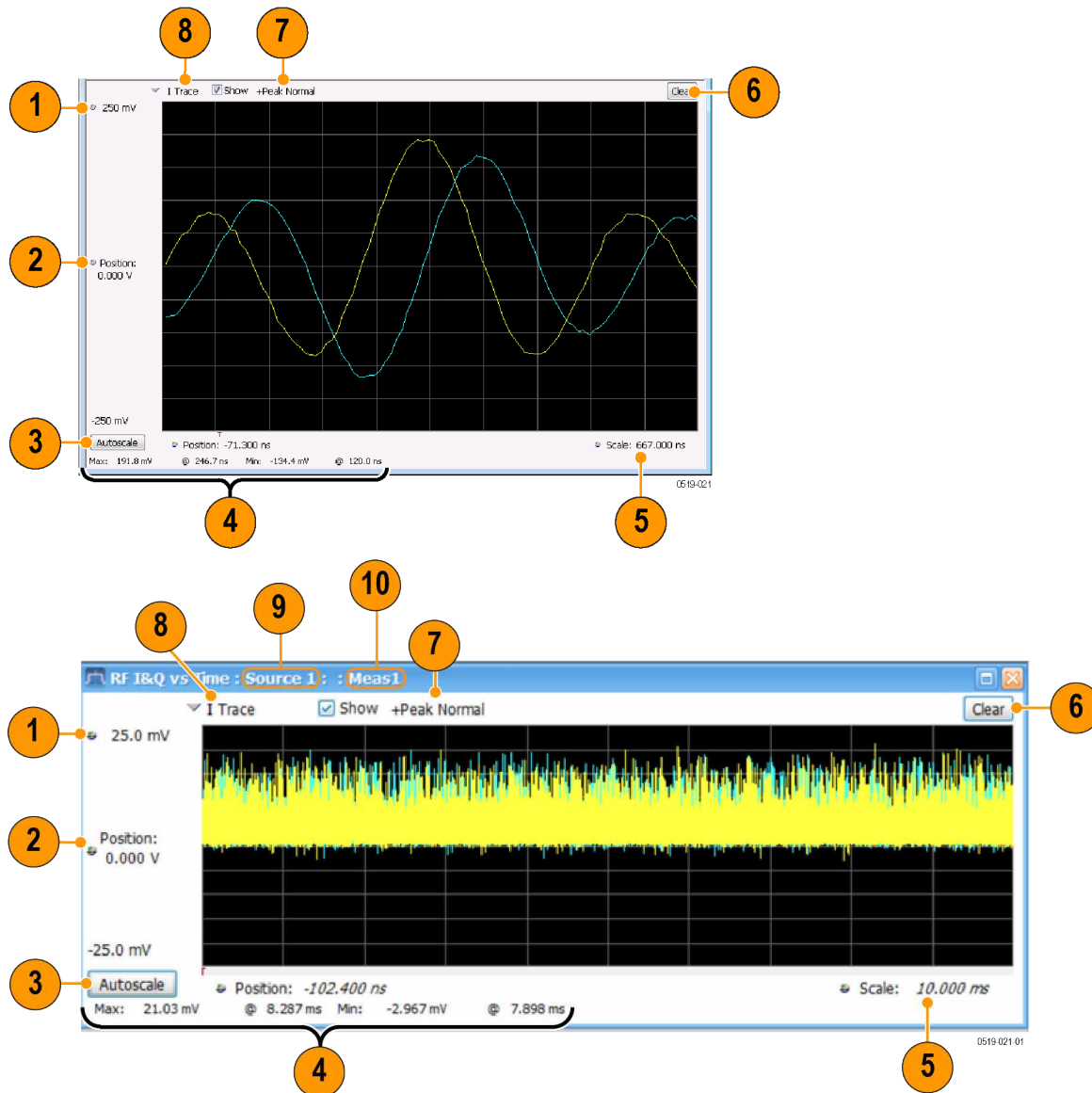

The above figure is shown when connected to MSO/LPD.

Item	Display element	Description
1	Top of Graph adjustment	Use the knob to adjust the vertical scaling.
2	Vertical offset adjustment	Adjusts the level shown at the center of the display.
3	Autoscale button	Adjusts the offset and scale for both vertical and horizontal to provide the best display.
4	Maximum and Minimum level readouts	Displays the maximum and minimum values, within the Analysis Time, as well as the times at which they occurred.
5	Scale	Sets the time spanned by the graph.
6	Clear button	Restarts multi-trace functions (Avg, Hold).
7	Trace function	Displays the current trace function setting (Settings > Trace > Function). If the traces are averaged, the number of averages is displayed.
8	Trace Control	Selects which trace is displayed (using the drop-down list) and which trace is active (click on the trace name to display a menu).
When connected to MSO/LPD		
9	Source	Source corresponds to selected display.
10	Measurement Instance number	Represents the instance of measurement display created.

[Changing the RF I & Q vs Time Display Settings](#)

RF I & Q vs Time Settings

Main menu bar: **Setup > Settings**



The Setup settings for RF I&Q vs. Time are shown in the following table.

Settings tab	Description
Freq & BW Tab	Sets the frequency and bandwidth parameters.
Traces	Sets the trace display parameters.
Scale	Sets the Vertical and Horizontal scale and offset parameters.
Prefs	Specifies whether certain display elements are visible.

Common Controls General Signal Viewing Shared Measurement Settings

Source Selection

Source can be changed for selected measurement from Settings control panel using Source drop-down.

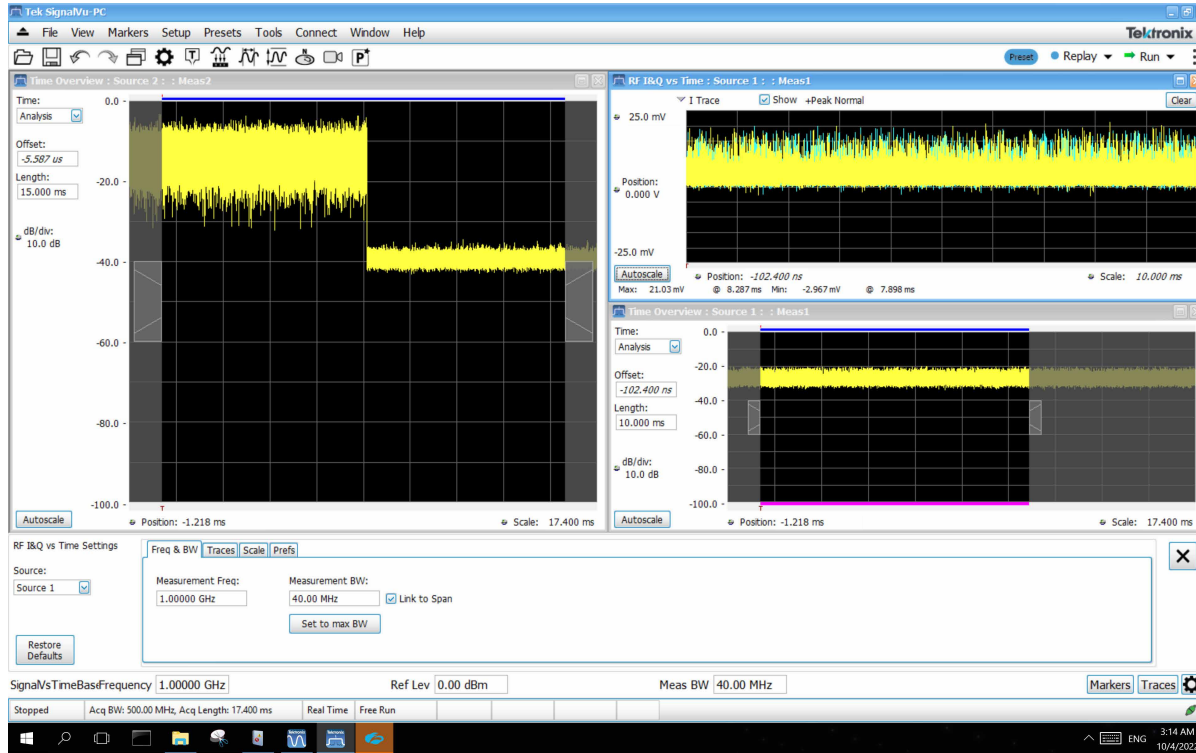

The above figure is shown when connected to MSO/LPD.

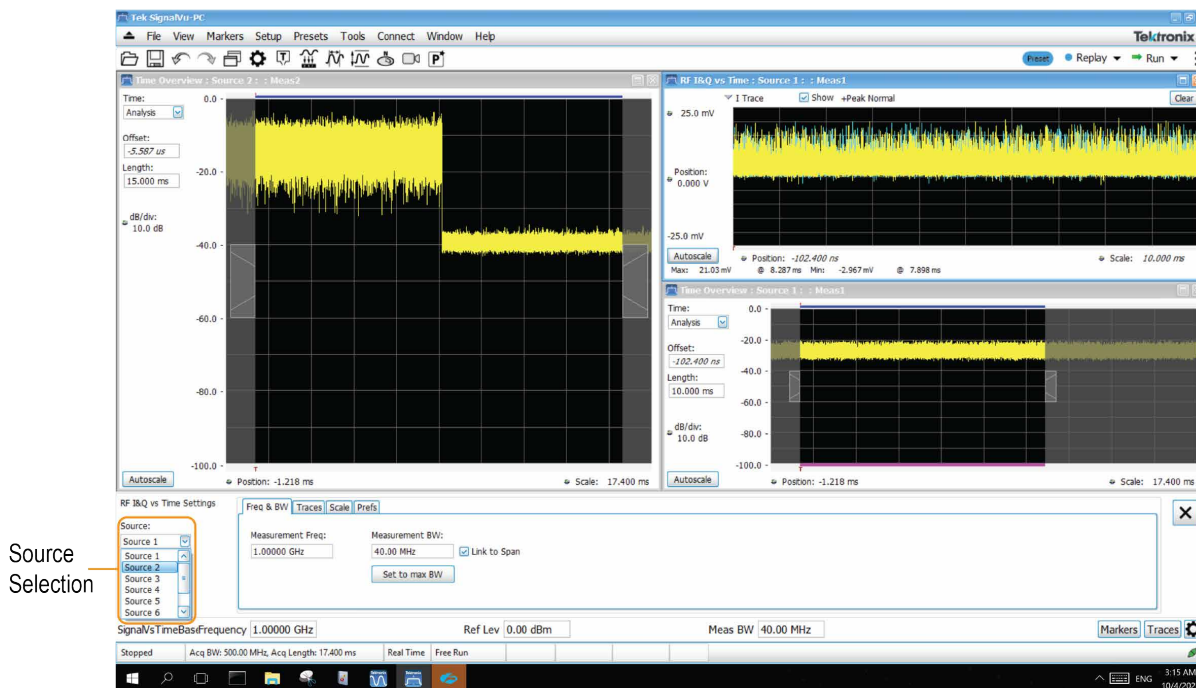

The above Error pop-up figure is shown when connected to MSO/LPD.

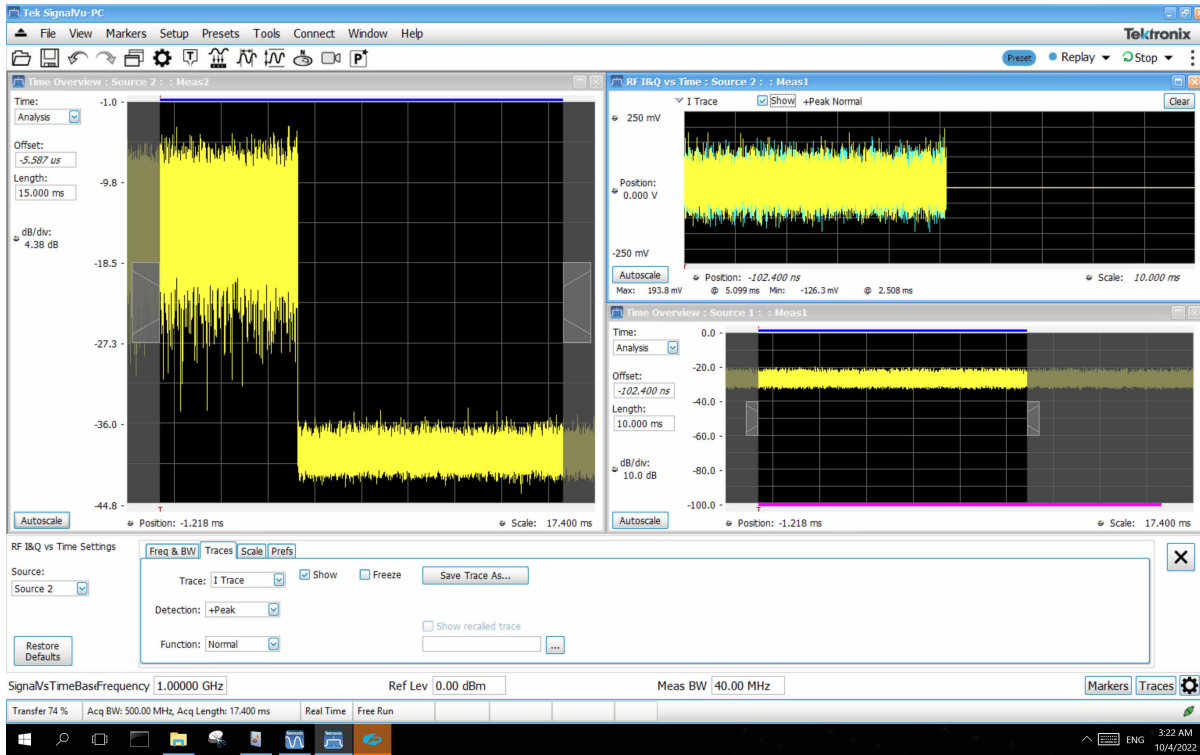

The above figure is shown when connected to MSO/LPD.

You can change source for a particular display and it can be viewed in title bar of measurement display.



Note: Use different sources, if you are adding same type of measurements. For example: Two or more spectrum measurements cannot be connected to same source. They must have distinct sources. Acquisition must be stopped in order to change source.

The control panel tabs in this section are identical or very similar for each of the displays in the General Signal Viewing folder (Setup > Displays). Some tabs are shared by all the displays, some tabs are shared by only a couple of displays.

For some tabs, the control values are shared across all the General Signal Viewing displays. For other control values, each display has unique values for the controls. Details are provided for the specific tabs.

Table 11: Common controls for general signal viewing displays

Settings tab	Description
Freq & Span	Sets the frequency and span parameters.
Traces	Sets the trace display parameters.
Traces – Math	Sets the traces used to create the Math trace.
BW	Sets the Bandwidth Method used for setting the measurement bandwidth.
Scale	Sets the Vertical and Horizontal scale and offset parameters.
Prefs	Specifies whether certain display elements are visible.

Freq & BW Tab — Freq vs Time, Phase vs Time, RF I & Q vs Time Display

The Freq & BW tab provides access to settings that control frequency settings for the Freq vs Time, Phase vs Time, RF I & Q vs Time display.

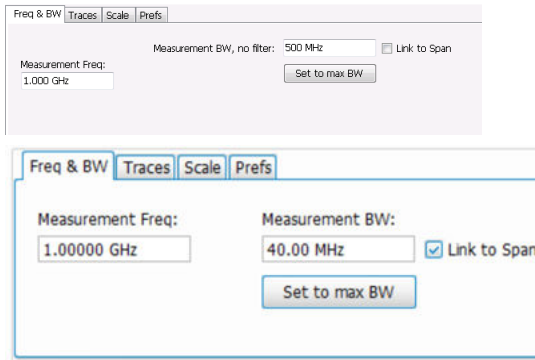

Above figure is shown when connected to MSO/LPD

Setting	Description
Measurement Freq	The frequency at the which measurements are made. This value is the same as the setting for Frequency in the Application bar.
Measurement BW	This control limits the bandwidth of measurements. You use the measurement bandwidth setting to improve the signal-to-noise ratio of the measurement, resulting in lower measurement uncertainty. However, if the measurement bandwidth is set too low, resulting in fewer samples per second, it can reduce the number of points within the measurement length below the 256 stable samples required, thus causing the analysis to fail.
Link to Span	When enabled, the measurement bandwidth of the RF I & Q display is determined by the span of the analyzer. When unchecked, the measurement bandwidth is specified by the user, and no additional filter is applied.
Set to max BW	Sets the measurement bandwidth to the maximum acquisition bandwidth of the instrument.

Freq & Span Tab

The Freq & Span tab provides access to settings that control frequency settings for the trace display. The control values set in this tab are shared by all the General Signal Viewing displays.

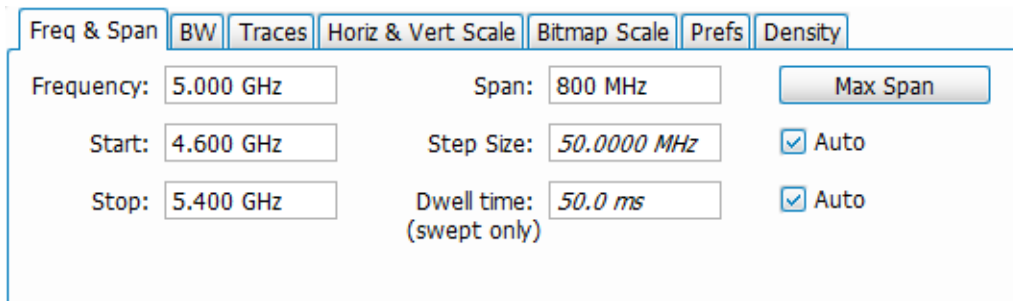

Setting	Description
Frequency	The frequency at the center of the selected span.
Start	The lowest frequency in the span.
Stop	The highest frequency in the span.
Span	The difference between the start and stop frequencies. This is the measurement bandwidth for the general signal viewing displays.
Step Size	Sets the increment/decrement size for Frequency, Start, and Stop values.
Dwell time (DPX display only)	The amount of time the DPX sweep remains in a frequency segment collecting data and updating the bitmap and traces before moving on to the next higher frequency segment. The minimum Dwell Time setting is 50 ms, the normal update rate for DPX computations. Maximum Dwell Time per frequency segment is 100 s. The number of frequency segments and their start/stop frequencies are internally determined based on span, acquisition bandwidth, RBW, and other parameters.
Max Span	Sets the span to the maximum value.
Auto checkbox	Sets the Step Size and Dwell time automatically when checked.

Frequency, Start, Stop, and Span frequencies are correlated

Changing the values for center frequency, start frequency, stop frequency or span will change the values for the other settings, depending on which setting you change. For example, if you change the center frequency, the start and stop frequencies will be adjusted automatically to maintain the same span.

If, however, the start and stop frequencies are changed so that they are closer than the minimum span setting, the start and stop frequencies will be adjusted to maintain the minimum span setting.

Setting changed manually	Settings changed automatically as a result	Setting not automatically changed
Start	Center, Span	Stop
Stop	Center, Span	Start
Center Frequency	Start, Stop	Span
Span	Start, Stop	Center

Traces Tab

The Traces Tab allows you to set the display characteristics of displayed traces.

Setting	Description
Trace	Selects a trace. (This setting is not present for every display.)
Show	Shows / hides the selected trace.
Detection	Sets the Detection method used for the trace. Not available for saved traces. Available detection methods are +Peak, -Peak, +/-Peak, Avg (VRMS), Sample, CISPR Avg, CISPR Pk, and CISPR QPk. Not all detection methods are available in all displays. (CISPR detection requires Option SVQPNL or SVQPFL.)
Function	Selects the trace processing method. Available settings are: Normal, Average, Max Hold, and Min Hold.
Count	Sets the number of traces averaged to generate the displayed trace. (Present only when Function is set to Average, Min Hold, or Max Hold.)
Freeze	Halts updates to the selected trace.
Save Trace As	Saves the selected trace to a file for later recall and analysis.
Show Recalled trace	Displays a saved trace instead of a live trace. When a trace is recalled, controls such as show, freeze, function, and detection of trace will be disabled.

Trace

Available traces for Spectrum are: Trace 1, Trace 2, Trace 3, Math, and Spectrogram. Other displays support fewer traces. Traces 1-3 are based on the input signal and enable you to display the input signal using different processing. For example, you could display Trace 1 with Function set to Normal, Trace 2 with Function set to Max Hold and Trace 3 with Function set to Min Hold.

The Math trace is the result of subtracting one trace from another.

The Spectrogram trace applies only to the Spectrum display and is available only if the Spectrogram display is shown. The Spectrogram trace shows the trace selected in the Spectrogram as a spectrum trace.

Detection

Trace Detection is used to reduce the results of a measurement to the desired number of trace points. For example, if the maximum number of trace points is 100,000, and a measurement over the selected analysis length yields 200,000 points, the measurement must decimate these 200,000 trace points by 2 to prevent exceeding the 100,000 trace point limit. Since only one value can be represented for each trace point, an algorithm must be used to select (detect) the appropriate value to use.

The results array from an analysis can be detected (or “decimated”) in a variety of ways. The number of results points produced for each trace point varies with both analysis length and trace length. For example, the frequency transform used for the Spectrum display produces just one output value for each desired trace point. In this case, the detection method chosen has no effect, as no decimation is required. Increasing the Analysis Length (or for the Spectrum display, the Spectrum Length), causes the available detection method's output traces to differ from each other because they have a larger set of samples for the various detection methods to process.

The available detection methods (depending on the display) are:

- **+Peak** – The highest value is selected from the results to be compressed into a trace point.
- **-Peak** – The lowest value is selected from the results to be compressed into a trace point.
- **+/-Peak** – Both the highest and lowest values are selected from the results to be compressed into a trace point.
- **Avg (VRMS)** [Average V_{RMS}] – Each point on the trace is the result of determining the RMS Voltage value for all of the results values it includes. When displayed in either linear (Volts, Watts) or Log (dB, dBm), the correct RMS value results.
- **Avg (of logs)** – The detector is used to emulate legacy spectrum analyzer results and for the specification of displayed average noise level. In older swept analyzers, a voltage envelope detector is used in the process of measuring signal level, and the result is then converted to Watts and then to dBm. Averaging is then applied to the resultant traces.

For CW signals, this method results in an accurate power measurement. However, with random noise and digitally modulated carriers, errors result from this 'average of logs' method. For random noise, the average of logs methods results in power levels -2.51 dB lower than that measured with a power meter, or with a signal analyzer that measures the rms value of a signal, and performs averaging on the calculated power in Watts and not dBm or other log-power units.

This detector should be used when following a measurement procedure that specifies it, or when checking the Displayed Averaged Noise Level (DANL) of the instrument. The 'average of logs' detection and trace function is used for DANL specification to provide similar results to other spectrum/signal analyzers for comparison purposes. Use of the Average of Logs method of measurement is not recommended for digitally modulated carriers, as power measurement errors will occur.



Note: The Detection setting does not affect the trace until the spectrum length is longer than the Auto setting.

- **Sample** – The first value is selected from the set of results to be compressed into a trace point.
- **CISPR Peak** – The trace value is calculated by the methods described for peak detectors in the CISPR documents.
- **CISPR QPk** – The trace value is calculated by the methods described for quasi peak detectors in the CISPR documents.
(Requires Option SVQPNL or SVQPFL.)
- **CISPR Avg** – The trace value is calculated by the methods described for average detectors in the CISPR documents.
(Requires Option SVQPNL or SVQPFL.)

Trace Processing

Traces can be processed to display in different ways. The Function setting controls trace processing.

- **Normal** - Each new trace is displayed and then replaced by the next trace. Each data point contains a single vertical value.
- **Average** - Multiple traces are averaged together to generate the displayed trace, which will contain just one vertical value for each underlying frequency data point. Once the specified number of traces have been acquired and averaged to generate the displayed trace, additional traces contribute to the running average, except in Single Sequence run mode. In the case of Single Sequence, the instrument stops running after the specified number of traces have been averaged together. The **Number of Traces** setting specifies how many traces are averaged. The averaging is performed on the linear (Voltage) values, resulting in the correct RMS average).
- **Max Hold** - Displays the maximum value in the trace record for each display point. Each new trace's display point is compared to the previous maximum value and the greater value is retained for display and subsequent comparisons.
- **Min Hold** - Displays the minimum value in the trace record for each display point. Each new trace's display point is compared to the previous minimum value and the lesser value is retained for display and subsequent comparisons.

Saving Traces

To save a trace for later analysis:

1. Select the **Save Trace As** button. This displays the Save As dialog box.
2. Navigate to the desired folder or use the default.
3. Type a name for the saved trace and click **Save**.

Recalling Traces

You can recall a previously saved trace for analysis or comparison to a live trace.

To select a trace for recall:

1. Select the trace into which the recalled trace will be loaded, from the Trace drop-down list.
2. Check the **Show** check box.
3. Click the ... button to display the Open dialog box.

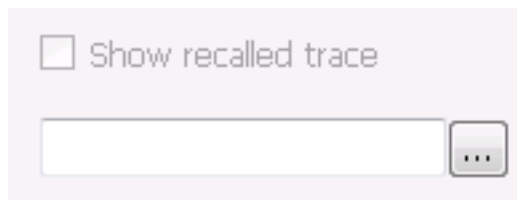

4. Navigate to the desired file and click **Open**.
5. Check the **Show Recalled Trace** check box.
6. Verify that the trace's **Show** check box is selected (either on this tab or next to the drop-down list located at the top-left corner of the graph).

Traces tab - Math Trace

This tab is not a distinct tab, it is just how the Traces tab appears when Math is selected in the Traces drop-down list.

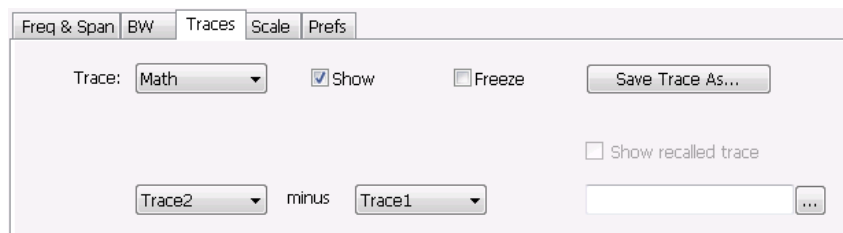

Trace 4 is a mathematically-derived trace defined as Trace A minus Trace B. You can select Trace 1, 2, or 3 to serve as either Trace A or Trace B.

Setting	Description
Trace	When set to Trace 4 (Math), this tab is displayed.
Show	Shows / hides the selected trace.
Freeze	Halts updates to the selected trace.
Save Trace As	Saves the selected trace to a file for later recall and analysis.

Table continued...

Setting	Description
Trace minus Trace	Selects which traces serve as Trace A and Trace B.

BW Tab

The BW (bandwidth) tab allows you to change Resolution Bandwidth and Video Bandwidth settings, and set the windowing method used by the transform process by selecting a filter shape (not present for all displays).

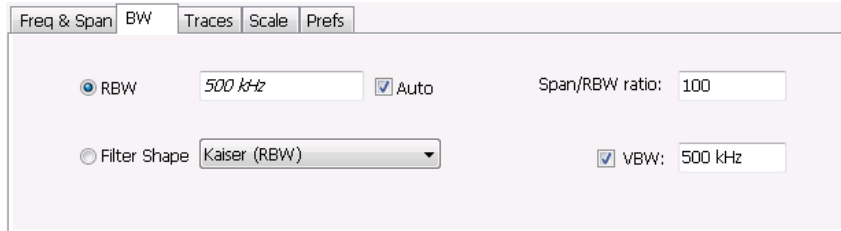

Setting	Description
RBW	Sets the Resolution Bandwidth value to be used in the spectrum analysis view. The value is italicized when Auto is selected.
Auto	When Auto is checked, the RBW is calculated as a percentage of the Span. Kaiser is selected as the windowing method. When Auto is unchecked, the RBW is set by the user. Selecting any Window other than Kaiser changes the RBW setting to manual.
Span/RBW ratio	If Auto is checked, this value is used to calculate the RBW. If Auto is unchecked, this setting is not selectable.
Filter Shape	Specifies the windowing method used for the transform (when Auto is unchecked). (Spectrum and Spectrogram displays only.)
VBW	Adjusts the VBW (Video Bandwidth) value. (Spectrum and Spectrogram displays only.)

Filter shape settings

In the analyzer, computationally efficient discrete Fourier transform algorithms such as FFT (Fast Fourier Transform) or CZT (Chirp-Z Transform) are generally employed to transform time-domain signals into frequency-domain spectra. There is an assumption inherent in the mathematics of Discrete Fourier Transforms that the data to be processed is a single period of a periodically repeating signal. The discontinuities between successive frames will generally occur when the periodic extension is made to the signal. These artificial discontinuities generate spurious responses not present in the original signal, which can make it impossible to detect small signals in the presence of nearby large ones. This phenomenon is called spectral leakage.

Applying a filter, such as Kaiser, to the signal to be transformed is an effective method to combat the spectral leakage problem. Generally the filter has a bell shape. Multiplying the transform frame by the filter function eliminates or reduces the discontinuities at the ends of the frame, however, at the expense of increased RBW.

Filter shape characteristics

The choice of filter shape depends on its frequency response characteristics such as side-lobe level, equivalent noise bandwidth and maximum amplitude error. Use the following guidelines to select the best filter shape.

Filter Shape	Characteristics
Kaiser (RBW)	Best side-lobe level, shape factor closest to the traditional Gaussian RBW.
-6dB RBW (MIL)	These filters are specified for bandwidth at their -6 dB point, as required by military EMI regulations.
CISPR	These filters comply with the requirements specified in the P-CISPR 16 -1-1 document for EMI measurements.
Blackman-Harris 4B	Good side-lobe level.
Uniform (None)	Best frequency resolution, poor side-lobe level and amplitude accuracy.
Flat-Top (CW ampl)	Best amplitude accuracy, best representation of brief events captured near the beginning or end of the time-domain data frame, poor frequency resolution.
Hanning	Good frequency resolution, high side-lobe roll-off rate.

VBW

The VBW setting enables/disables the Video Bandwidth filter. VBW is used in traditional swept analyzers to reduce the effect of noise on the displayed signal. The VBW algorithm in the analyzer emulates the VBW filters of traditional swept analyzers.

The maximum VBW value is 10 times the current RBW setting. The minimum VBW value is 1/10,000 of the RBW setting. VBW is disabled when the Filter shape is set to CISPR.



Note: If you are following a procedure that says to "set VBW to three times the RBW value or greater", it means that the test should be conducted with no VBW effects. In the SignalVu-PC software, this condition is met by disabling the VBW function.

Scale Tab

The Scale tab allows you to change the vertical and horizontal scale settings. Changing the scale settings changes how the trace appears on the display but does not change control settings such as Measurement Frequency. In effect, these controls operate like pan and zoom controls.

The Scale tab values are unique to each display. Also, note that each display uses horizontal and vertical units that are appropriate for the display. For example, for the Spectrum display uses power (dBm) units and frequency (Hz) units; the Amplitude vs. Time display uses power (dBm) and time (seconds) units; and the Phase vs. Time display uses phase (degrees) and time (seconds) units.

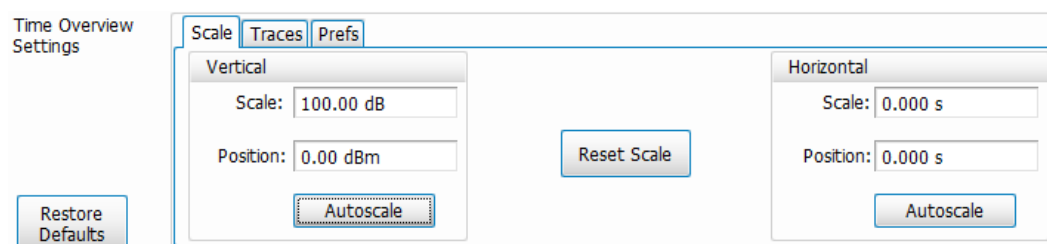

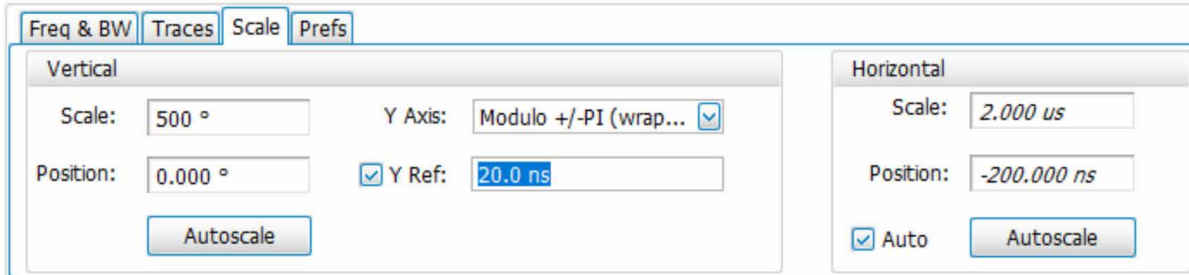

Figure 42: Phase Vs Time Scale Tab

Setting	Description
Vertical	Controls the vertical position and scale of the trace display.
Scale	Changes the vertical scale.
Position	Vertical position adjusts the reference level away from top of the graph.
Autoscale	Resets the scale of the vertical axis to contain the complete trace.
Horizontal	Controls the horizontal position and scale of the trace span of the trace display and position of the trace.
Scale	Changes the range shown between the left and right sides of the graph.
Position	Changes the position of the acquisition record shown at the left edge of the graph.
Reset Scale	Resets all settings to their default values.
Y Ref (Phase Vs Time measurement)	When enabled, the phase at the Y ref value becomes reference phase and is set to 0. When the checkbox is disabled, you can observe the phase values of the sources in their respective Phase Vs Time displays.

Phase difference

The phase difference between sources can be measured when SignalVu-PC is connected to MSO 4/5/6 Series. It allows you to calculate the phase difference using individual Phase vs Time display marker values of the respective sources. A Y Ref check box is provided to enable or disable the Y Ref value. When check box is checked, the phase at the Y ref value becomes reference phase and is set to 0 else you can observe the phase values of the sources in their respective Phase vs Time displays. The respective marker difference value from the two displays can be used to calculate the phase difference between the sources.

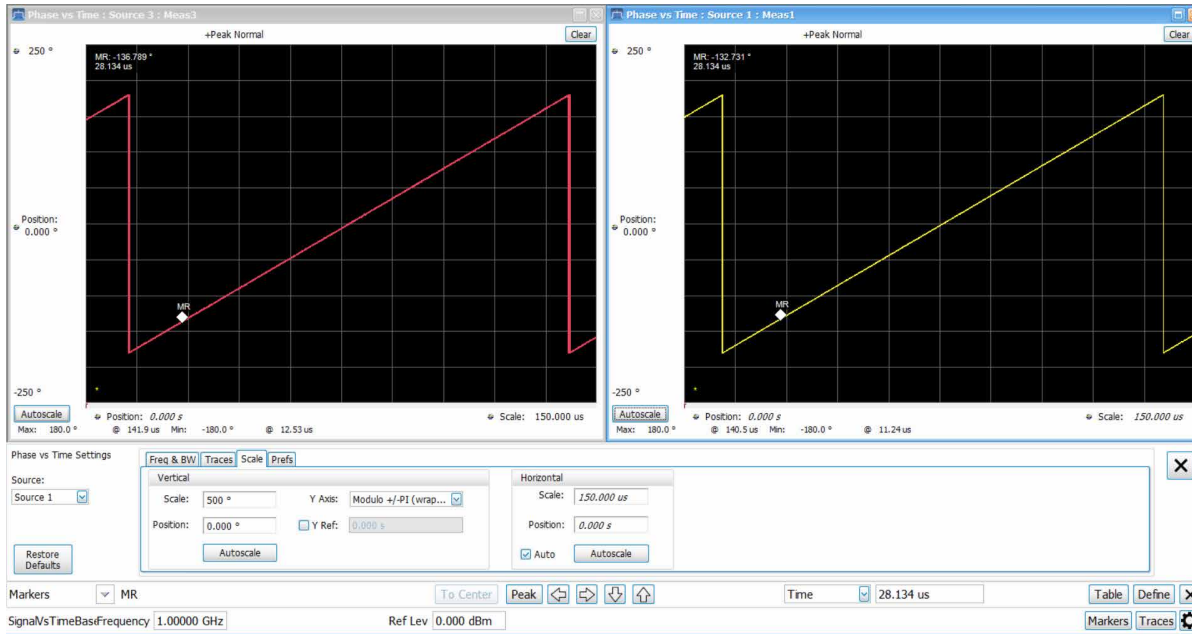

Figure 43: Y ref disabled, Reference Marker shows the absolute value

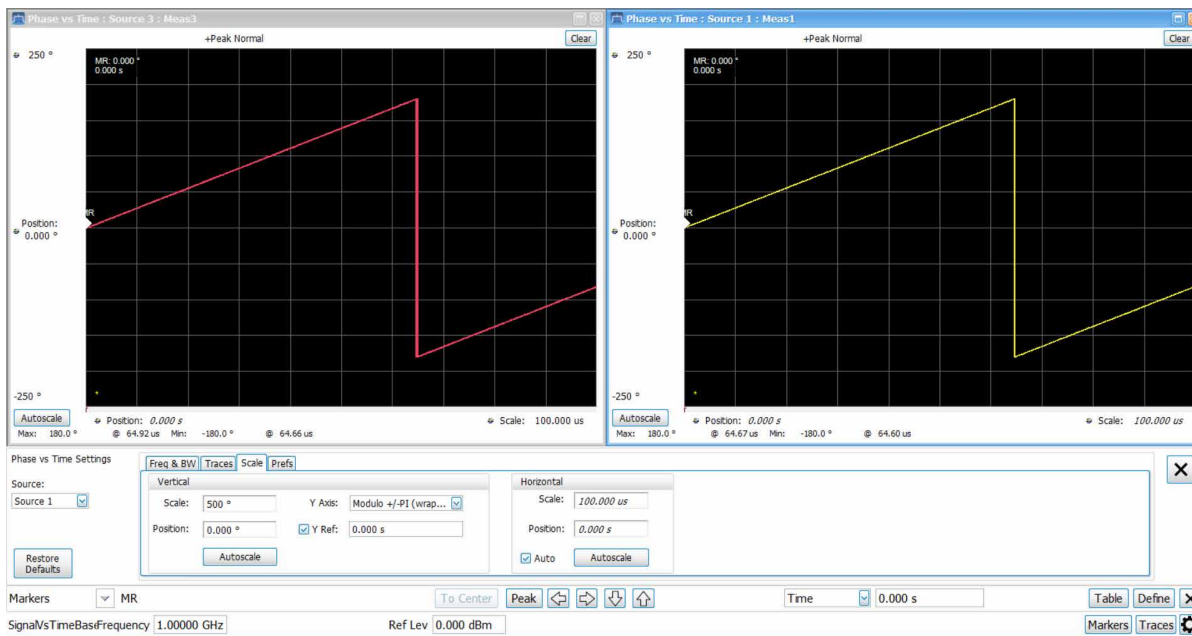

Figure 44: Y ref enabled, Reference Marker shows 0

Prefs Tab

The Prefs tab enables you to change parameters of the measurement display. The parameters available on the Prefs tab vary depending on the selected display, but include such items as enabling/disabling marker Readout and switching the Graticule display on/off.

Each of the General Signal Viewing displays maintains its own separate values for the controls that appear on the Prefs tab. Some parameters appear with most displays while others appear with only one display.

For example, in the following image, the Show Marker readout in graph check box appears in the Prefs tab for every display. However, the Show Power Trigger level check box only appears on the Amplitude vs Time Prefs tab.

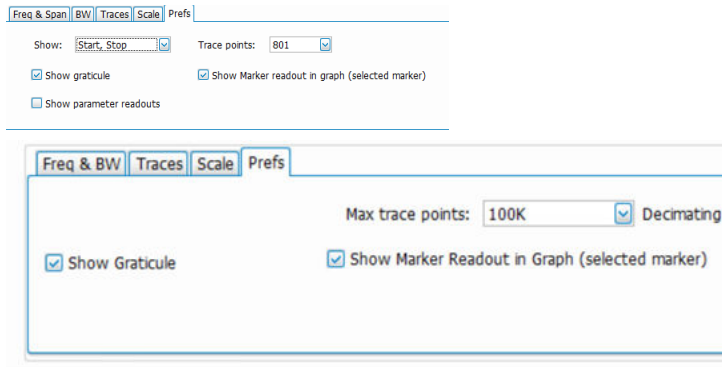

The above figure shows pref tab when connected to MSO/LPD

The following image shows the Prefs tab for the Time Overview display.

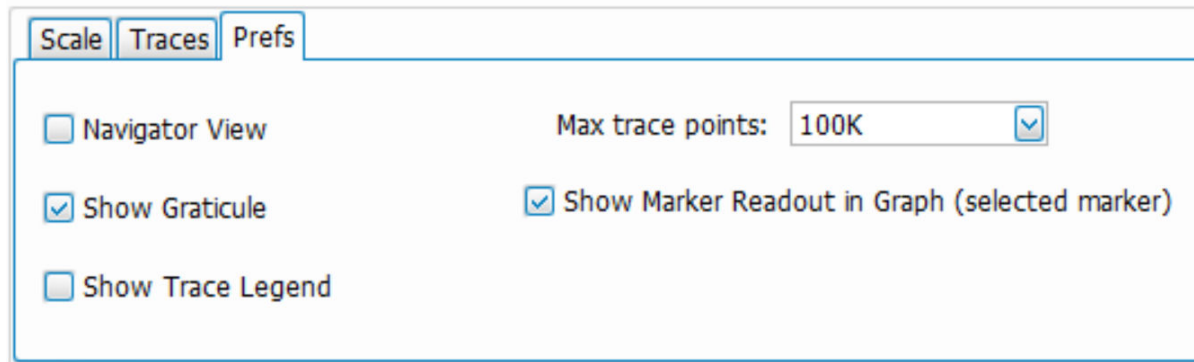

The following image shows the Prefs tab for the DPX display when DPXogram or Split is the selected view.

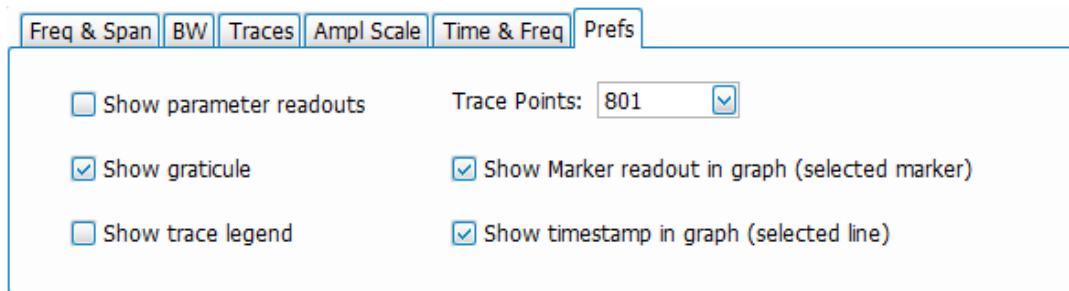

The following image shows the Prefs tab for the DPX display when Spectrum is the selected view.

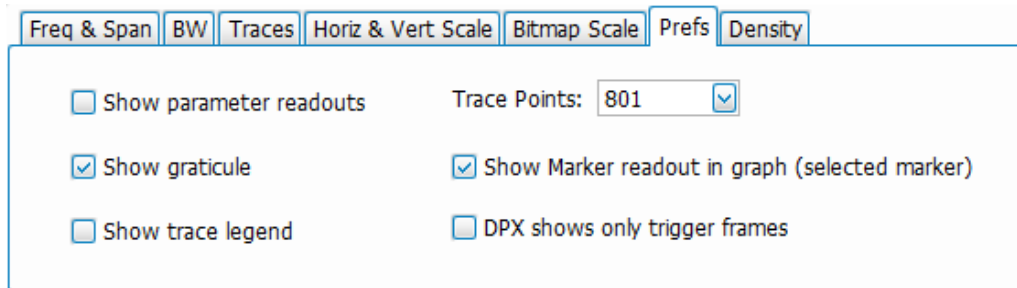

The following table explains the controls that can appear on the Prefs tab.

Setting	Description
Show	Sets the horizontal settings that appear below the graph area. You can select Start, Stop or Center, Span.
Trace points	Sets the number of trace points used for marker measurements and for results export.
Max trace points (Time Overview display only)	Sets the maximum number of trace points used for marker measurements and for results export.
Show trace legend	Enables display of a legend in the measurements area that shows the Detection method and Function setting for displayed traces. The color of the legend text matches the color of the associated trace.
Show graticule	Check to display the graticule. Uncheck to hide the graticule.
Navigator View (Time Overview display only)	Places the Time Overview display across the top of the application window, above all other active displays.
Show parameter readouts	<p>For the DPX display, enables/disables the display of DPX parameters. The parameters readout shows 100% Probability of Intercept, Transforms/s, and FFT Points.</p> <p>For the Spectrum display, enables/disables display of Sweep speed and FFT Points.</p> <p> Note: Using the Cable Loss, RL/DTF, or Transmission Gain displays at the same time as the Spectrum display can cause the sweep speed in Spectrum to be reduced. Closing the non-Spectrum display will return the sweep speed to the correct speed.</p>
Show Marker readout in graph (selected marker)	Shows or hides the readout for the selected marker in the graph area.
Show timestamp in graph (selected line)	For spectrogram displays, this readout shows or hides the timestamp associated with the selected line or marker position.
DPX shows only trigger frames	For the DPX Spectrum display, check to show only trigger frames.
Show Power Trigger Level	Displays or hides a green line in the graph that indicates the level at which the power trigger is set. The line is not displayed if Trigger is set to Free Run.

Show parameter readouts for DPX Spectrum

The elements of the Show parameter readouts are:

100% POI

This is the minimum event duration required to ensure 100% Probability of Intercept or event capture. This duration depends on interaction between span, RBW, and FFT length. You can use the POI time value to determine if you are at risk of either missing a narrow transient or of its captured amplitude being less than the actual signal.

Table 12: Minimum signal duration for 100% probability of trigger at 100% amplitude

Frequency-Mask and DPX signal processing				Minimum signal duration, 100% probability of intercept, Frequency-Mask and DPX density trigger (µs)	
Span	RBW (kHz)	FFT length	Spectrums/sec	Standard	
				Full amplitude	-3 dB
165 MHz	20000	1024	390,625	15.5	15.4
	10000	1024	390,625	15.6	15.4
	1000	1024	390,625	17.8	15.7
	300	2048	195,313	23.4	16.3
	100	8192	48,828	44.5	23.4
	30	32768	12,207	161.9	91.7
85 MHz	10000	1024	390,625	15.6	15.4
	1000	1024	390,625	17.8	15.7
	500	1024	390,625	20.2	15.9
	300	1024	390,625	23.4	16.3
	100	4096	97,656	44.5	23.4
	30	16384	24,414	121.0	50.7
	20	16384	24,414	161.0	55.6
40 MHz	5000	1024	390,625	15.8	15.4
	1000	1024	390,625	17.8	15.7
	300	1024	390,625	23.3	16.3
	100	2048	195,313	39.4	18.3
	30	4096	97,656	90.4	21.8
	20	8192	48,828	140.7	36.3
	10	16384	24,414	281.3	72.6

Table continued...

Frequency-Mask and DPX signal processing				Minimum signal duration, 100% probability of intercept, Frequency-Mask and DPX density trigger (μ s)	
Span	RBW (kHz)	FFT length	Spectrums/sec	Standard	
				Full amplitude	-3 dB
25 MHz	3800	1024	390,625	16.0	15.4
	1000	1024	390,625	17.7	15.7
	300	1024	390,625	23.4	16.3
	200	1024	390,625	27.4	16.8

Transforms/s

This is the number of transforms/second being performed by the DPX engine. It is a function of the selected resolution bandwidth and number of trace points. The desired RBW determines the number of points required in each transform, which alters the transform rate. Additionally, the selected trace length may place requirements on the number of points required in the transform independent of the selected resolution bandwidth.

FFT Points

The approximate number of points in the FFT of the input signal. FFT points provides an indication of frequency resolution, but it is not an exact measurement. Note that higher numbers for FFT points mean that the instrument is taking a longer string of input samples for each FFT, which decreases the time resolution.

Table 13: Minimum FFT length versus trace length - independent of span and RBW

Trace length (points)	Minimum FFT length
801	1,024
2,401	4,096
4,001	8,192
10,401	16,384

Analog Modulation

Overview

The displays in Analog Modulation (**Displays > Measurements > Analog Modulation**) are:

- AM
- FM
- PM

The Analog Modulation displays provide measurements and time-domain trace displays.

AM Display

The Amplitude Modulation Display is a graph of Modulation Factor vs Time. The AM display includes three numeric readouts.

To show the AM display:

1. Select the **Displays** button or select **Setup > Displays**. This shows the **Select Displays** dialog box.
2. From the **Measurements** box, select **Analog Modulation**.
3. Double-click the **AM** icon in the **Available Displays** box. This adds the AM icon to the **Selected displays** box.
4. Click the **OK** button. This shows the AM display.

Elements of the Display

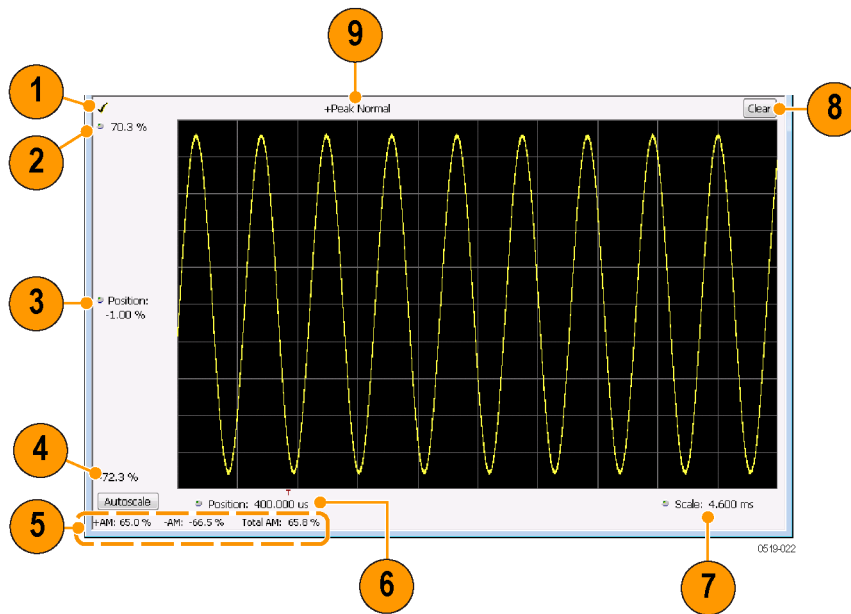

Item	Element	Description
1	Check mark indicator	The check mark indicator in the upper, left-hand corner of the display shows when the AM display is the optimized display.  Note: When <i>Best for multiple windows</i> is selected in the Amplitude control panel's RF & IF Optimization control, none of the measurement displays shows a checkmark, as there is not a single optimized measurement.
2	Top of Graph	Sets the %AM indicated at the top of the graph by increasing or decreasing the vertical scale. Changing the top value affects the bottom of graph value because the graph scales about vertical center. Also, note that the top of graph setting interacts with the internal vertical scale setting (which is not user settable).
3	Position	Specifies the %AM shown at the center of the graph display.
4	Bottom Readout	Displays the value of the modulation factor shown at the bottom of graph.
5	Measurement readouts	Displays numeric values for the +AM (positive modulation factor), -AM (negative modulation factor), and Total AM.
6	Position	Specifies the horizontal position of the trace on the graph display.
7	Scale	Adjusts the horizontal range of the graph. By decreasing the scale (time across the entire graph), the graph essentially becomes a window that you can move over the trace by adjusting the position.
8	Clear	Erases the trace from the graph.
9	Trace Detection readout	Displays the Settings > Trace > Detection setting.

Changing the AM Settings

AM Settings

Main menu bar: Setup > Settings



The AM Settings control panel provides access to settings that control parameters of the AM Display.

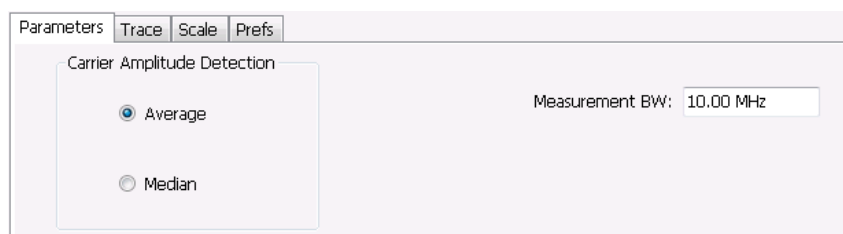

Setting	Description
Parameters	Sets the Carrier Amplitude Detection method. You can choose either Average or Median.
Trace	Sets Trace display parameters.
Scale	Sets vertical and horizontal scale and position parameters.
Prefs	Specifies whether or not certain display elements are shown. Specifies the maximum number of points shown in the display graph.

Parameters Tab

The Parameters tab enables you to specify two parameters that control the carrier amplitude detection.

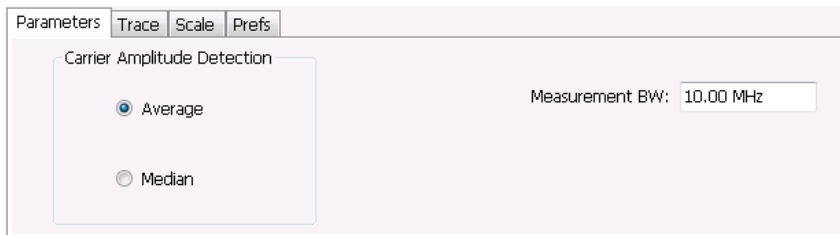

Setting	Description
Average	Selects the Average method for computing the average baseline for measurements.
Median	Selects the Median method for computing the average baseline for measurements.
Measurement BW	Specifies the bandwidth about the center frequency at which measurements are made.

AM Modulation

An amplitude modulated carrier can be described mathematically by:

$$X(t) = [A + a(t)] \cos \omega_0 t$$

A, in the above equation, represents the carrier amplitude, a(t) represents the time-varying modulation and ω_0 represents the carrier frequency.

The signal modulation envelope is given by:

$$E_M(t) = A + a(t)$$

There are several ways to express the AM modulation depth, expressed as a percentage.

Peak method

$$AM\text{ModulationDepth} = \frac{\text{Max}[A + a(t)]}{A}$$

Trough Method

$$AM\ Modulation\ Depth = \frac{Min [A + a (t)]}{A}$$

Max-Min Method

$$AM\ Modulation\ Depth = \frac{Max [A + a (t)] - Min [A + a (t)]}{2A}$$

In each case, the value of the carrier amplitude, A , needs to be estimated from the input signal.

The instrument represents signals in a sampled form. The sampled envelope can be expressed as a function of sample index K and sampling period T as:

$$E_M [KT] = A + a [KT]$$

The instrument allows the choice of two methods for estimating the carrier amplitude:

Average Method

$$A = Average \{E_M [KT]\}$$

Median Method

$$A = Median \{E_M [KT]\}$$

In both cases, the instrument computes the average and the median over the analysis period. It should be noted that the two methods give the same result for sinusoidal modulation where the sampling frequency is much higher than the modulation frequency.

Trace Tab

The Trace Tab allows you to set the display characteristics of a trace.

Setting	Description
Show	Shows/hides the trace. If the instrument continues to run, the measurement results below the graph display continue to update even if the trace is hidden.
Detection	Sets the Detection method used for the trace. Available detection methods are +Peak, -Peak, and Avg (VRMS). Not available for saved traces.
Function	Selects the trace processing method. The only available setting is Normal.

Table continued...

Setting	Description
Freeze	Halts updates to the trace.
Save Trace As	Saves the trace to a file for later recall and analysis.
Show recalled trace	Displays a saved trace instead of a live trace.

Detection

Detection refers to the method of processing the data acquisition points when creating a trace. The IQ samples in a data acquisition can be detected in a variety of ways. The number of IQ samples available to each trace point varies with both analysis length and trace length. For example, with Spectrum Length set to 'Auto' in the Analysis menu, the instrument analyzes just enough samples to produce one IQ sample pair per trace point. In this case, the detection method chosen has very little effect, as the +Peak, -Peak, and Avg (VRMS) are all equal. Changing the Spectrum Length causes the available detection methods to differ in value because they have a larger set of samples for the various detection methods to process.

The available detection methods are:

- **+Peak** – Each point on the trace is the result of detecting the positive peak value present in the set of IQ samples available to that trace point.
- **-Peak** – Each point on the trace is the result of detecting the negative peak value present in the set of IQ samples available to that trace point.
- **Avg (VRMS)** [Average V_{RMS}] – Each point on the trace is the result of determining the RMS Voltage value for all of the IQ samples available to the trace point. When displayed in either linear (Volts, Watts) or Log (dB, dBm), the correct RMS value results. When the averaging function is applied to a trace, the averaging is performed on the linear (Voltage) values, resulting in the correct average for RMS values.

Trace Processing

Traces can be processed to display in different ways. The Detection setting controls trace decimation, when needed. When the trace points each cover more than one sample data point, the vertical results values for multiple data points are combined into each trace point. Each trace point ends up with a single vertical value.

- **Average** - Each trace point is computed by averaging together the multiple results points it represents.
- **+Peak** - Each trace point represents the highest vertical value among the results it includes.
- **-Peak** - Each trace point represents the lowest vertical value among the results it includes.

Saving Traces

To save a trace for later analysis:

1. Select the **Save Trace As** button. This displays the Save As dialog box.
2. Navigate to the desired folder or use the default.
3. Type a name for the saved trace and click **Save**.

Recalling Traces

You can recall a previously saved trace for analysis or comparison to a live trace.

To select a trace for recall:

1. Click the ... button to display the Open dialog box.
2. Navigate to the desired file and click **Open**.
3. Check the **Show Recalled Trace** check box.
4. Verify that the **Show** check box is selected.

Scale Tab

The Scale tab allows you to change the vertical and horizontal scale settings. Changing the scale settings changes how the trace appears on the display but does not change control settings such as Measurement Frequency. In effect, these controls operate like pan and zoom controls.

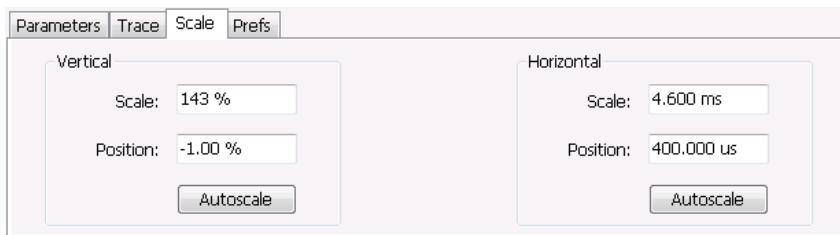

Setting	Description
Vertical	
Scale	Changes the range shown between the top and bottom of the graph.
Position	Adjusts the level shown at the center of the graph.
Autoscale	Resets the Position so that the entire trace is in the graph.
Horizontal	
Scale	Changes the range shown between the left and right sides of the graph.
Position	Adjusts the position of the acquisition record shown at the left edge of the graph.
Autoscale	Resets the Scale and Position settings to provide the optimum display.

Prefs Tab

The Prefs tab enables you to change appearance characteristics of the AM display.

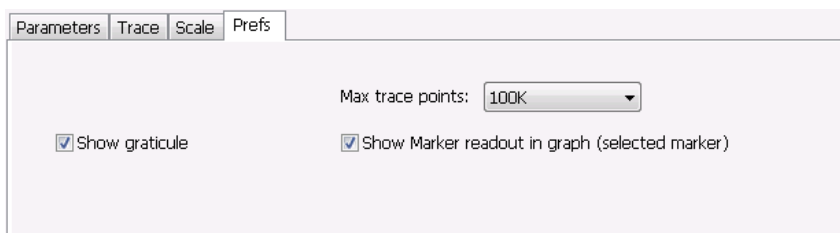

Item	Element	Description
1	Check mark indicator	<p>The check mark indicator in the upper, left-hand corner of the display shows when the FM display is the optimized display.</p> <p> Note: When <i>Best for multiple windows</i> is selected in the Amplitude control panel's RF & IF Optimization control, none of the measurement displays shows a checkmark, as there is not a single optimized measurement.</p>
2	Top of Graph control	Sets the frequency indicated at the top of the graph. Since the Position value at the vertical center of this graph remains constant as the Top of Graph value is adjusted, the Vertical Scale increases as the Top of Graph value increases, which also affects the bottom of graph readout. Vertical Scale can also be controlled from the Settings control panel's Scale tab.
3	Position	Specifies the frequency shown at the center of the graph display. Changing this value moves the trace up and down in the graph, which affects the Top of Graph and Bottom of Graph values as well.
4	Bottom of Graph Readout	Displays the frequency value at the bottom of the graph.
5	Measurement readouts	Displays numeric values for the +Pk (positive frequency deviation), -Pk (negative frequency deviation), RMS (RMS value of the deviation), Pk-Pk (peak-to-peak frequency deviation), and Pk-Pk/2 (peak-to-peak frequency deviation divided by two).
6	Position	Specifies the horizontal position of the trace on the graph display.
7	Scale	Adjusts the time range of the graph. By decreasing the scale (full-scale time over 10 divisions), the graph essentially becomes a window that you can move over the acquisition record by adjusting the horizontal position.
8	Clear	Clears the trace and numeric measurement results.
9	Trace Detection readout	Displays the Settings > Trace > Detection setting.
10	Freq Error	This readout can show Freq Error or Freq Offset. When it displays Freq Error, it shows the difference between the instrument Frequency setting and the measured value of the signal's carrier frequency. When it displays Freq Offset, it shows the frequency offset specified on the Settings > Parameters tab. If Freq Error is displayed, it also indicates that the Carrier frequency detection setting is Auto. If Freq Offset is displayed, it indicates that the Carrier frequency detection setting is manual.

Changing the FM Settings

FM Settings

Main menu bar: Setup > Settings



The FM Settings control panel provides access to settings that control parameters of the FM Display.

Parameters Trace Scale Prefs

Burst detect threshold: -100 dBc

Measurement BW: 100.0 kHz

Frequency offset: -50.54 Hz Auto

Load from marker

Setting	Description
Parameters	Sets the burst detection threshold, measurement bandwidth, and carrier frequency detection method.
Trace	Sets Trace display parameters.
Scale	Sets vertical and horizontal scale and position parameters.
Prefs	Specifies whether or not certain display elements are shown. Specifies the maximum number of points shown in the display graph.

Parameters Tab

The Parameters tab enables you to specify parameters for carrier detection.

Parameters Trace Scale Prefs

Burst detect threshold: -100 dBc

Measurement BW: 100.0 kHz

Frequency offset: -50.54 Hz Auto

Load from marker

Setting	Description
Burst detect threshold	This parameter specifies the power level used to determine whether a burst is present. A valid burst is required to take measurements. The burst detected first is used for the analysis. The units for burst detect threshold are dBc, relative to the maximum acquisition sample data points level.
Measurement BW	Specifies the bandwidth about the center frequency at which measurements are made.
Frequency offset	Displays the carrier signal's offset from the instrument's measurement frequency. Auto is used to select the method for determining the carrier frequency. When Auto is selected, the instrument determines the carrier frequency by analyzing the signal. When Auto is deselected, you can set the carrier frequency offset using Frequency Offset.
Load from Marker	Pressing this button sets the frequency offset to the frequency offset of the selected marker. (Pressing this button automatically deselects Auto.)

Frequency Offset

In Auto (Auto is selected), the instrument scans the measurement bandwidth about the measurement frequency and looks for the highest-powered signal. This is defined as the carrier frequency. In Manual (Auto is deselected), the carrier frequency is specified by adding/subtracting the specified Frequency offset from the measurement frequency. Range: $-(\text{Measurement BW} \times 1.1)/2$ to $+(\text{Measurement BW} \times 1.1)/2$. If the **Load from Marker** button is pressed, the frequency offset is determined from the phase difference between the two markers on screen compared to the time between the two markers. This function is useful for removing frequency slope from the phase modulated signal.

Load from Marker

When the Auto check box is selected, the instrument scans the measurement bandwidth about the center frequency and looks for the highest-powered signal. This is defined as the carrier frequency. When the Auto check box is deselected, the carrier frequency is specified by adding/subtracting the specified Frequency offset from the center frequency. Pressing the Load from Marker button loads the marker frequency into the Frequency offset box.

Trace Tab

The Trace Tab allows you to set the display characteristics of displayed traces.

Setting	Description
Show	Shows / hides the trace. If the instrument continues to run, the measurement results below the graph display continue to update even if the trace is hidden.
Detection	Sets the Detection method used for the trace. Available detection methods are +Peak, -Peak, and Avg (VRMS). Not available for saved traces.
Function	Selects the trace processing method. The only available setting is Normal.
Freeze	Halts updates to the trace.
Save Trace As	Saves the trace to a file for later recall and analysis.
Show Recalled trace	Displays a saved trace instead of a live trace.

Detection

Detection refers to the method of processing the data acquisition points when creating a trace. The IQ samples in a data acquisition can be detected in a variety of ways. The number of IQ samples available to each trace point varies with both analysis length and trace length. For example, with Spectrum Length set to 'Auto' in the Analysis menu, the instrument analyzes just enough samples to produce one IQ sample pair per trace point. In this case, the detection method chosen has very little effect, as the +Peak, -Peak, and Avg (VRMS) are all equal.

Changing the Spectrum Length causes the available detection methods to differ in value because they have a larger set of samples for the various detection methods to process.

The available detection methods are:

- **+Peak** – Each point on the trace is the result of detecting the positive peak value present in the set of IQ samples available to that trace point.
- **-Peak** – Each point on the trace is the result of detecting the negative peak value present in the set of IQ samples available to that trace point.
- **Avg (VRMS)** [Average V_{RMS}] – Each point on the trace is the result of determining the RMS Voltage value for all of the IQ samples available to the trace point. When displayed in either linear (Volts, Watts) or Log (dB, dBm), the correct RMS value results. When the averaging function is applied to a trace, the averaging is performed on the linear (Voltage) values, resulting in the correct average for RMS values.

Trace Processing

Traces can be processed to display in different ways. The Function setting controls trace processing.

- **Normal** - Each new trace is displayed and then replaced by the next trace. Each data point contains a single vertical value.
- **Average** - Each trace point is computed by averaging together the multiple results points it represents.
- **+Peak** - Each trace point represents the highest vertical value among the results it includes.
- **-Peak** - Each trace point represents the lowest vertical value among the results it includes.

Saving Traces

To save a trace for later analysis:

1. Select the **Save Trace As** button. This displays the Save As dialog box.
2. Navigate to the desired folder or use the default.
3. Type a name for the saved trace and click **Save**.

Recalling Traces

You can recall a previously saved trace for analysis or comparison to a live trace.

To select a trace for recall:

1. Click the ... button to display the Open dialog box.
2. Navigate to the desired file and click **Open**.
3. Check the **Show Recalled Trace** check box.
4. Verify that the **Show** check box is selected.

Scale Tab

The Scale tab allows you to change the vertical and horizontal scale settings. Changing the scale settings changes how the trace appears on the display but does not change control settings such as Measurement Frequency. In effect, these controls operate like pan and zoom controls.

Setting	Description
Vertical	
Scale	Changes the range shown between the top and bottom of the graph.
Position	Adjusts the frequency shown at the center of the graph.
Autoscale	Resets the Position so that the entire trace fits within the graph.
Horizontal	
Scale	Changes the range shown between the left and right sides of the graph.
Position	Adjusts the position of the acquisition record shown at the left edge of the graph.
Autoscale	Resets the Scale and Position settings to provide the optimum display.

Prefs Tab

The Prefs tab enables you to change appearance characteristics of the FM display.

Setting	Description
Show graticule	Shows or hides the graticule.
Show Marker readout in graph (selected marker)	Shows or hides the readout for the selected marker in the graph area.

Table continued...

Setting	Description
Max trace points	The trace in the FM display can be set to a maximum of 100,000 points (however, the actual number of trace points can extend up to 500,000 points if Max trace points is set to Never Decimate). If the Analysis Length includes more than the selected Max trace points value, the trace is decimated (using the method specified with the Detection control) to be equal to or less than the Max trace points setting (except when Max trace points is set to Never Decimate). This decimated (or undecimated) trace is what is used for marker measurements and for results export.

PM Display

The Phase Modulation Display shows Phase vs. Time. The vertical axis units are degrees and the horizontal axis units are seconds. When taking measurements, only the first burst in the Analysis period is analyzed. No trace points are shown for data outside the first detected burst, nor are measurements made on data outside the first detected burst.

Elements of the Display

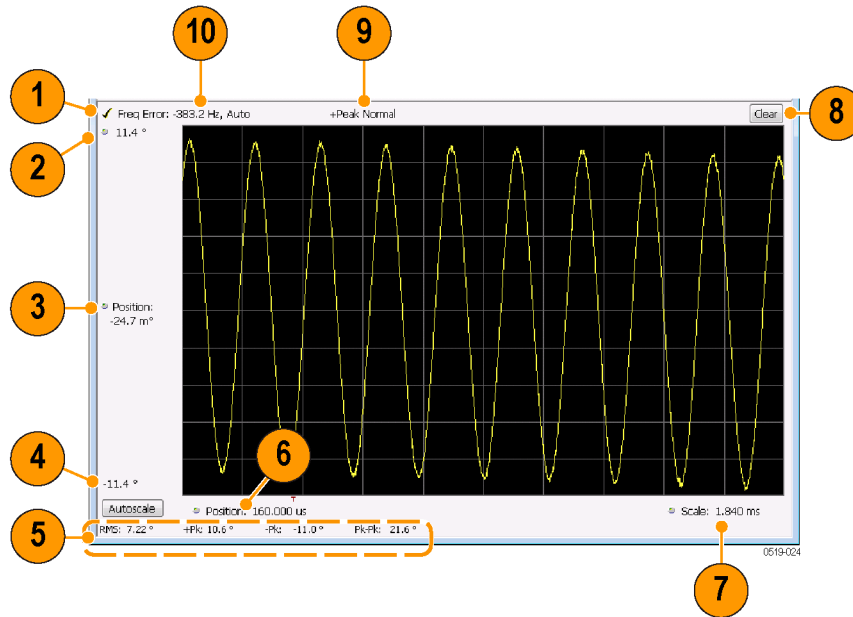

Item	Element	Description
1	Check mark indicator	<p>The check mark indicator in the upper, left-hand corner of the display shows when the PM display is the optimized display.</p> <p>Note: When <i>Best for multiple windows</i> is selected in the Amplitude control panel's RF & IF Optimization control, none of the measurement displays shows a checkmark, as there is not a single optimized measurement.</p>

Table continued...

Item	Element	Description
2	Top of Graph control	Sets the phase value indicated at the top of the graph. Since the Position value at the vertical center of this graph remains constant as the Top of Graph value is adjusted, the Vertical Scale increases as the Top of Graph value increases, which also affects the bottom of graph readout. Vertical Scale can also be controlled from the Settings control panel's Scale tab.
3	Position	Specifies the phase shown at the center of the graph display. Changing this value moves the trace up and down in the graph, which affects the Top of Graph and Bottom of Graph values as well.
4	Bottom of Graph Readout	Displays the phase value at the bottom of the graph.
5	Measurement readouts	Displays numeric values for the +Pk (positive phase deviation), -Pk (negative phase deviation), Pk-Pk (peak-to-peak phase deviation), and RMS (RMS value of the phase deviation).
6	Position	Specifies the horizontal position of the trace on the graph display.
7	Scale	Adjusts the time range of the graph. By decreasing the scale (full-scale time over 10 divisions), the graph essentially becomes a window that you can move over the acquisition record by adjusting the horizontal position.
8	Clear	Clears the measurement results.
9	Trace Detection readout	Displays the Trace Detection setting (see Settings > Trace > Detection).
10	Freq Error	This readout can show Freq Error or Freq Offset. When it displays Freq Error, it shows the difference between the instrument Frequency setting and the measured value of the signal's carrier frequency. When it displays Freq Offset, it shows the frequency offset specified on the Settings > Parameters tab. If Freq Error is displayed, it also indicates that the Carrier frequency detection setting is Auto. If Freq Offset is displayed, it indicates that the Carrier frequency detection setting is manual.

[Changing the PM Settings](#)

PM Settings

Main menu bar: Setup > Settings



The PM Settings control panel provides access to settings that control parameters of the PM Display.

Parameters Trace Scale Prefs

Burst detect threshold: -100 dBc

Measurement BW: 1.000 MHz

Frequency offset: -383.2 Hz Auto
 Load Δ from marker

Phase offset: 128 ° Auto
 Load from marker

Setting	Description
Parameters	Sets the Carrier Frequency Detection method. You can choose either Automatic or Manual. Sets burst threshold and phase detection method.
Trace	Sets Trace display parameters.
Scale	Sets vertical and horizontal scale and position parameters.
Prefs	Specifies whether or not certain display elements are shown. Specifies the maximum number of points shown in the display graph.

Parameters Tab

The Parameters tab enables you to specify parameters that control the carrier frequency and phase detection.

Parameters Trace Scale Prefs

Burst detect threshold: -100 dBc

Measurement BW: 1.000 MHz

Frequency offset: -383.2 Hz Auto
 Load Δ from marker

Phase offset: 128 ° Auto
 Load from marker

Setting	Description
Burst detect threshold	Specifies the power level used to determine whether a burst is present. A valid burst is required to take measurements. The burst detected first is used for the analysis. The units for burst detect threshold are dBc, relative to the maximum acquisition sample data points level.
Measurement BW	Specifies the bandwidth about the center frequency at which measurements are made.
Frequency offset	Displays the carrier signal's frequency offset from the instrument's Measurement Frequency. Auto is used to select the method for determining the carrier frequency. When Auto is selected, the instrument determines the carrier frequency by analyzing the signal. When Auto is deselected, you can set the carrier frequency offset using Frequency Offset.
Load Δ from Marker	Pressing this button disables the Auto Frequency Offset function and sets the Frequency offset to the frequency offset calculated from the difference between MR (the marker reference) and the selected marker (or M1 if MR is currently the selected marker).

Table continued...

Setting	Description
Phase offset	Displays the phase offset. When Auto is selected, the instrument determines the phase offset. When Auto is deselected, the user sets the phase offset with this control.
Load from marker	Pressing this button sets the phase offset to the phase offset of the selected marker. (Pressing this button automatically deselects Auto.)

Frequency Offset

In Auto (Auto is selected), the instrument scans the measurement bandwidth about the Measurement Frequency and looks for the highest-powered signal. This is defined as the carrier frequency. In Manual (Auto is deselected), the carrier frequency is specified by adding/subtracting the specified Frequency offset from the Measurement Frequency. Range: $-(\text{Measurement BW} * 1.1) / 2$ to $+(\text{Measurement BW} * 1.1) / 2$. If the **Load Δ from marker** button is pressed, the frequency offset is determined from the phase difference between the two markers on screen compared to the time between the two markers. This function is useful for removing frequency slope from the phase modulated signal.

Phase Offset

In Auto (Auto is selected), the instrument sets the phase offset to fit the waveform to the screen centering 0° phase on the vertical axis. The actual phase offset is indicated on the Phase Offset readout. In Manual (Auto is deselected), the instrument sets the phase offset using the value specified in Phase offset. For example, when Phase offset is set to 10° , the waveform shifts upward by 10° on screen. Selecting **Load from marker** sets the phase offset to the value of the selected marker. Range: -180 to $+180^\circ$.

Trace Tab

The Traces Tab allows you to set the display characteristics of displayed traces.



Setting	Description
Show	Shows / hides the trace. If the instrument continues to run, the measurement results below the graph display continue to update even if the trace is hidden.
Detection	Sets the Detection method used for the trace. Available detection methods are +Peak, -Peak, and Avg (VRMS). Not available for saved traces.
Function	Selects the trace processing method. The only available setting is Normal.
Freeze	Halts updates to the trace.
Save Trace As	Saves the trace to a file for later recall and analysis.
Show Recalled trace	Displays a saved trace instead of a live trace.

Detection

Detection refers to the method of processing the data acquisition points when creating a trace. The IQ samples in a data acquisition can be detected in a variety of ways. The number of IQ samples available to each trace point varies with both analysis length and trace length. For example, with Spectrum Length set to 'Auto' in the Analysis menu, the instrument analyzes just enough samples to produce one IQ sample pair per trace point. In this case, the detection method chosen has very little effect, as the +Peak, -Peak, and Avg (VRMS) are all equal. Changing the Spectrum Length causes the available detection methods to differ in value because they have a larger set of samples for the various detection methods to process.

The available detection methods are:

- **+Peak** – Each point on the trace is the result of detecting the positive peak value present in the set of IQ samples available to that trace point.
- **-Peak** – Each point on the trace is the result of detecting the negative peak value present in the set of IQ samples available to that trace point.
- **Avg (VRMS)** [Average V_{RMS}] – Each point on the trace is the result of determining the RMS Voltage value for all of the IQ samples available to the trace point. When displayed in either linear (Volts, Watts) or Log (dB, dBm), the correct RMS value results. When the averaging function is applied to a trace, the averaging is performed on the linear (Voltage) values, resulting in the correct average for RMS values.

Trace Processing

Traces can be processed to display in different ways. The Function setting controls trace processing.

- **Normal** - Each new trace is displayed and then replaced by the next trace. Each data point contains a single vertical value.
- **Average** - Each trace point is computed by averaging together the multiple results points it represents.
- **+Peak** - Each trace point is represents the highest vertical value among the results it includes.
- **-Peak** - Each trace point is represents the lowest vertical value among the results it includes.

Saving Traces

To save a trace for later analysis:

1. Select the **Save Trace As** button. This displays the Save As dialog box.
2. Navigate to the desired folder or use the default.
3. Type a name for the saved trace and click **Save**.

Recalling Traces

You can recall a previously saved trace for analysis or comparison to a live trace.

To select a trace for recall:

1. Click the ... button to display the Open dialog box.
2. Navigate to the desired file and click **Open**.
3. Check the **Show Recalled Trace** check box.
4. Verify that the **Show** check box is selected.

Scale Tab

The Scale tab allows you to change the vertical and horizontal scale settings. Changing the scale settings changes how the trace appears on the display but does not change control settings such as Measurement Frequency. In effect, these controls operate like pan and zoom controls.

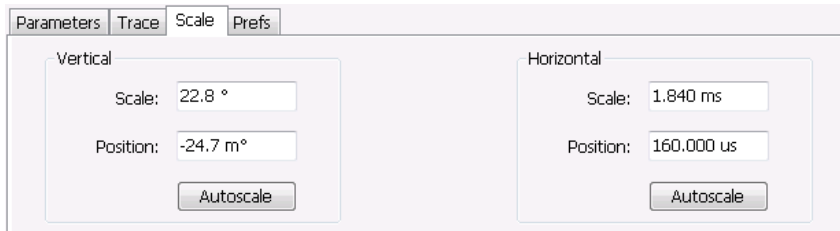

Setting	Description
Vertical	
Scale	Changes the range shown between the top and bottom of the graph.
Position	Adjusts the phase shown at the center of the graph.
Autoscale	Resets the Position so that the entire trace in the graph.
Horizontal	
Scale	Changes the range shown between the left and right sides of the graph.
Position	Adjusts the phase shown at the left edge of the graph.
Autoscale	Resets the Scale and Position settings to show the entire trace within the graph.

Prefs Tab

The Prefs tab enables you to change appearance characteristics of the PM display.

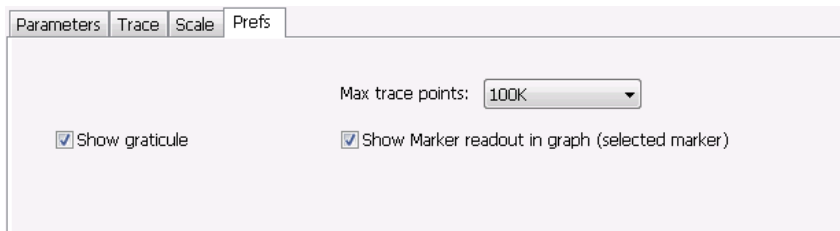

Setting	Description
Show graticule	Shows or hides the graticule.
Show Marker readout in graph (selected marker)	Shows or hides the readout for the selected marker in the graph area.

Table continued...

Setting	Description
Max trace points	The trace in the PM display can be set to a maximum of 100,000 points (however, the actual number of trace points can extend up to 500,000 points if Max trace points is set to Never Decimate). If the Analysis Length includes more than the selected Max trace points value, the trace is decimated (using the method specified with the Detection control) to be equal to or less than the Max trace points setting (except when Max trace points is set to Never Decimate). This decimated (or undecimated) trace is what is used for marker measurements and for results export.

RF Measurements

Overview

The displays in RF Measurements (**Displays > Measurements > RF Measurements**) are:

- CCDF
- Channel Power and ACPR
- Frequency and Phase Settling Time (Option SVT)
- MCPR
- Occupied Bandwidth
- Phase Noise (Option PHASNL-SVPC / PHASFL-SVPC, RSA7100 only)
- Spurious
- Signal Strength

The RF Measurements power measurements and signal statistics help you characterize components and systems.

Power Measurements

Measurement	Description
Channel Power	The total RF power in the selected channel (located in the ACPR display).
Adjacent Channel Power Ratio	Measure of the signal power leaking from the main channel into adjacent channels.
Multi-Carrier Power Ratio	The ratio of the signal power in the reference channel or group of channels to the power in adjacent channels.
Peak/Avg Ratio	Ratio of the peak power in the transmitted signal to the average power in the transmitted signal (located in the CCDF display).
CCDF	The <i>Complementary Cumulative Distribution Function</i> (CCDF). CCDF shows how much time a signal spends at or above a given power level relative to the average power of a measured signal.

Channel Power and ACPR (Adjacent Channel Power Ratio) Display

Use the **Channel Power and ACPR** measurement to measure channel power by itself, or adjacent channel leakage ratio with one main channel.

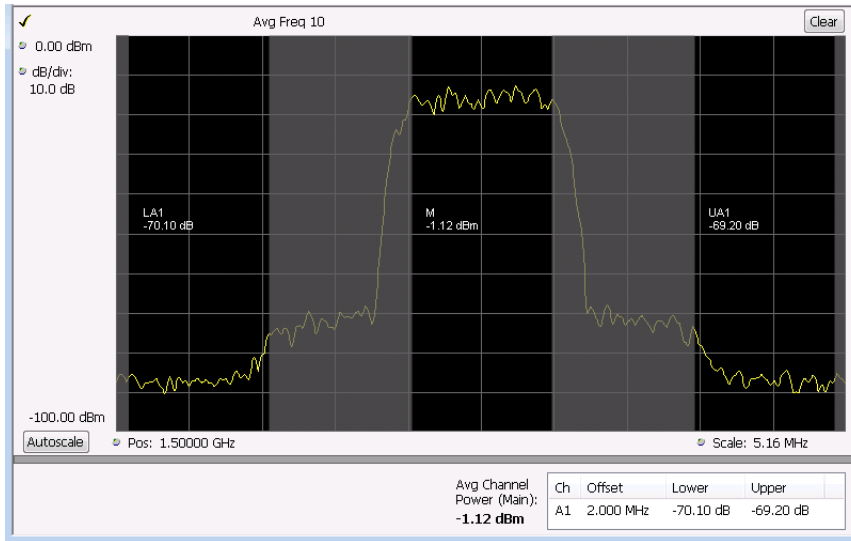

Measuring Adjacent Channel Power Ratio

1. If needed, recall the acquisition data file you wish to analyze.
2. Select the **Displays** button.
3. Select **RF Measurements** from the **Measurements** box.
4. Double-click **Chan Power and ACPR** in the Available displays box. Click **OK** to complete your selection.
5. Select **Settings** to display the Settings control panel for Chan Power and ACPR (the tab displayed will be the tab displayed the last time the Settings panel was opened).

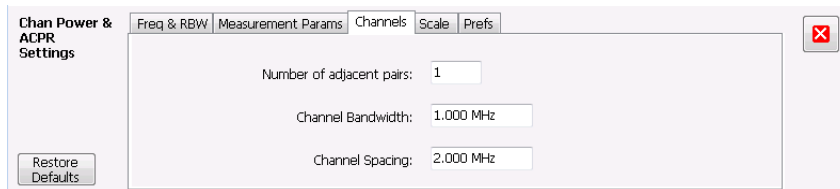

6. Select the **Freq & RBW** tab and adjust the frequency to that of your main channel. You can also change the frequency from the Status bar found at the bottom left side of the display.
7. To set the number of adjacent channels, select the **Channels** tab. Enter the number of channels in the **Number of adjacent pairs** value box. If zero is entered for the number of adjacent pairs, the resultant measurement will be channel power only.



Note: As you add adjacent channels, the span of the display is adjusted so that all the channels can be seen. Use the horizontal scale and offset to zoom the display in on any portion of the trace.

8. To set the spacing between channel centers, enter the required value in the **Channel Spacing** value box.
9. To set the channel bandwidth, enter the required value in the **Channel Bandwidth** value box.
10. After you have configured the channel settings, click the close button in the Settings panel or press **Settings** again to remove the Settings panel.
11. Click **Run** to take the measurements. Click **Replay** if you are using recalled acquisition data.

Viewing Results

Measurement results are displayed in a table below the graph and within the graph itself (which can be enabled/disabled in the Settings > Prefs tab). To see all measurements, you might need to scroll the table. The size of the results table can be changed by dragging the horizontal divider bar between the graph and table areas.

Channel Power (Main): -1.94 dBm	Ch	Offset	Lower	Upper
	A1	2.000 MHz	-65.69 dB	-64.82 dB

Heading	Description
Channel	Identifies the displayed channels. A1 means the first adjacent channel. A2 means second adjacent channel. Adjacent channels are numbered according to their offset from the Main channel. The closest channel is numbered 1. The next closest channel is numbered 2; and so forth.
Lower	The power measured for the lower adjacent channel. Adjacent channel power measurements are displayed in dB relative to the Main channel.
Upper	The power measured for the upper adjacent channel. Adjacent channels power measurements are displayed in dB relative to the Main channel.
Avg Channel Power (Main)	The power measured for the Main channel. The detection type used for measuring channel power and adjacent channel powers is Average. This means that the average of the linear (pre-log) samples is used to determine the power. The Main channel power is displayed in dBm.

[Setting Channel Power and ACPR Settings Parameters](#)

RF Channel Power Measurement

The RF channel power gives an indication of the total average (and other measures) RF power in a given channel.

For some communications systems, there is an “out-of-service” total power measurement defined in the specifications that calls for a specified constant modulation. In this case, the output power should be relatively constant. For many measurements, this may not be the case, and the Power Measurement results will vary as the signal varies.

Average power is the square root of the sum of the squares of the voltage samples over the measurement time.

The defined “channel” width for the Power Measurement defines the bandwidth and shape of the filter used to remove any RF power on frequencies outside of the channel bandwidth.

Channel Power

The total RF power in the selected frequency band. The detection type used for measuring channel power is Average. This means that the average of the linear (pre-log) samples is used to determine the channel power. To measure channel power, use the ACLR measurement, and set the number of adjacent channels to zero. This results in only the channel power being measured.

Average Channel Power

The total RF power in the selected channel (located in the ACPR display).

Adjacent Channel Leakage Power Ratio

Adjacent Channel Leakage power Ratio (ACLR) is the ratio of the mean power centered on the assigned channel frequency to the mean power centered on an adjacent channel frequency. In the 3GPP specification, both the main channel and adjacent channels are required to be filtered with RRC (Root Raised Cosine) filters.

Adjacent Channel Power

Measure of the signal power leaking into nearby channels.

Channel Power and ACPR Settings

Main menu bar: Setup > Settings



The settings for the Channel Power and ACPR display are shown in the following table.

Freq & RBW	Measurement Params	Channels	Scale	Prefs
Meas Freq: 1.50000 GHz		RBW: 30.000 kHz	<input checked="" type="checkbox"/> Auto	
Step: 2.0000 MHz	<input checked="" type="checkbox"/> Auto	<input type="checkbox"/> VBW:		

Settings tab	Description
Freq & RBW	Specify the frequency and resolution bandwidth used for the ACPR measurement.
Measurement Params	Specify several parameters that control the measurement, such as channel filter, chip rate, averaging, and correcting for noise floor.
Channels (ACPR)	This tab specifies the BW and offset parameters of the Channels for the selected ACPR measurement.
Scale	Specifies the vertical and horizontal scale settings.
Prefs	Specifies whether certain display elements are visible.

Restore defaults. Sets parameters for a 1-channel WCDMA measurement.

Channels Tab for ACPR

The Channels tab is where you specify parameters for the channels measured in the ACPR display.

Freq & RBW	Measurement Params	Channels	Scale	Prefs
Number of adjacent pairs: <input type="text" value="1"/>				
Channel Bandwidth: <input type="text" value="1.000 MHz"/>				
Channel Spacing: <input type="text" value="2.000 MHz"/>				

Setting	Description
Number of adjacent pairs	Specifies the number of adjacent channel pairs. Range: 1 - 50; Resolution 1.
Channel Bandwidth	Specifies the frequency width of each channel (all channels share the same value). The maximum channel bandwidth is 39.6 MHz for USB instruments.
Channel Spacing	Specifies the difference in frequency between the centers of each channel.

The following figure illustrates the settings controlled from the Channels tab.

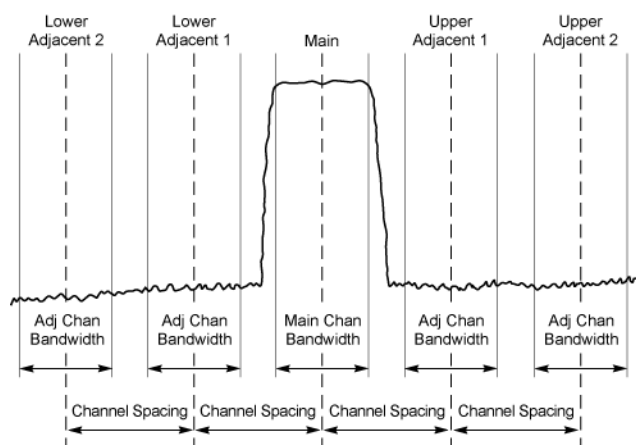

Changing the Number of Adjacent Pairs

1. Select **Number of adjacent pairs** number entry box.
2. Enter a value for the number of adjacent pairs using the knob or the keypad.



Note: As you change the value for the number of adjacent pairs, the analyzer will update the spectrum display to identify the adjacent channels.

3. Select the Close box when you have finished making changes.

Changing the Channel Bandwidth

1. Select the **Channel Bandwidth** number entry box.
2. Enter a value for the number of adjacent pairs using the knob or the keypad.



Note: As you change the value for the number of adjacent pairs, the analyzer will update the display to indicate the channel bandwidth.

3. Select the Close box when you have finished making changes.

Channel Spacing

1. Select **Channel Spacing** number entry box.
2. Enter a value for the difference in center frequency between channels using the knob or the keypad.



Note: As you change the value for the number of adjacent pairs, the analyzer will update the display to indicate the channel bandwidth.

3. Select **Close** when you have finished making changes.

Signal Strength Display

Use the **Signal Strength** display to measure signal strength (channel power and peak channel power).

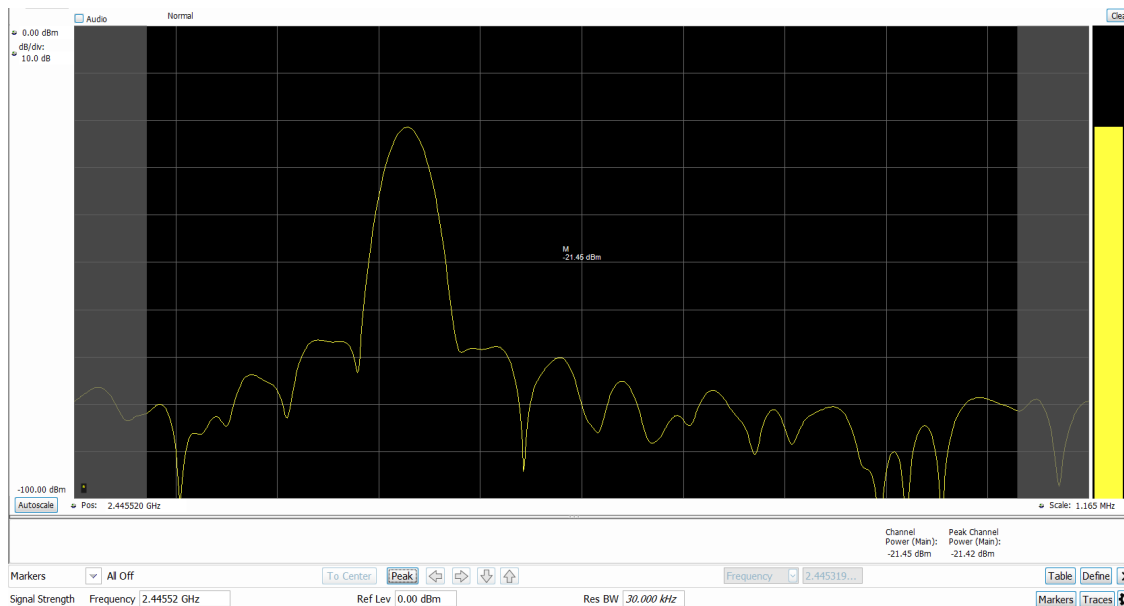

Measuring channel power and field strength

1. Select the **Displays** button.
2. Select **RF Measurements** from the **Measurements** box.
3. Double-click **Signal Strength** in the Available displays box. Click **OK** to complete your selection.
4. Tune the analyzer to the channel. To do this, you can enter the frequency directly into the Frequency field on the Basic Toolbar (see the bottom of the above image), or you can use the **Select Channel** button on the Channel Navigation toolbar.
5. Press the **Run** button to take the measurements. If you are using a data acquisition file, click **Replay**.
6. If you are measuring a signal with a directional antenna, select the **Audio** check box located above the graph, on the left side.

When Audio is checked, the analyzer sounds a tone that varies in frequency with the channel power. If you change the direction of the antenna and the channel power drops, the frequency of the audio tone will also drop. If the channel power increases, the audio tone frequency will also increase.

As channel power changes, the vertical channel power bar graph located on the far right side of the measurement display will rise and fall with the channel power.

Viewing Results

Measurement results are displayed below the graph and within the graph itself (the latter of which can be enabled/disabled in the Signal Strength Settings > Prefs tab).

Channel Power (Main):	Peak Channel Power (Main):
-10.00 dBm	14.09 dBm

Figure 45: Results for Signal Strength measurement

Heading	Description
Channel Power (Main)	The integrated power measured for the Main channel.
Peak Channel Power (Main)	The maximum integrated power measured for the Main channel.

[Signal Strength Settings](#) on page 169

Signal Strength Settings

Menu Bar: Setup > Settings



The settings for the Signal Strength display are shown in the following table.

Freq & RBW	Measurement Params	Channels	Scale	Prefs
Meas Freq: 1.50000 GHz	RBW: 30.000 kHz	<input checked="" type="checkbox"/> Auto		
Step: 2.0000 MHz	<input checked="" type="checkbox"/> Auto	<input type="checkbox"/> VBW:		

Settings tab	Description
Freq & RBW	Specify the frequency and resolution bandwidth used for the signal strength measurements.
Measurement Params	Specify several parameters that control the measurement, averaging, external amplitude corrections, and display units.
Channels	This tab specifies the BW
Scale	Specifies the vertical and horizontal scale settings.
Prefs	Specifies trace points, trace detection, and visible display elements (graticule, marker readouts, etc) for the Signal Strength measurement display.

Freq & RBW Tab for Signal Strength display

The Freq & RBW tab specifies frequency parameters for the signal strength measurements.

Meas Freq: 1.00000 GHz RBW: 30.000 kHz Auto

Step: 2.0000 MHz Auto VBW:

Setting	Description
Meas Freq	Specifies the center/measurement frequency.
Step	The Step control sets the increment/decrement size for the adjustment of the center frequency. If Auto is enabled, the analyzer will adjust the Step size as required.
RBW	Select Auto or Manual. Adjusts the RBW for the entire measurement. This setting is Independent of the Spectrum view's RBW setting.
VBW	Adjusts the VBW (Video Bandwidth) value. VBW Maximum = 10 times the current RBW value. VBW Minimum = 1/10,000 RBW setting.



Note: While the center frequency and step settings on this control tab are shared between ACPR, MCPR and Occupied Bandwidth, the RBW setting is not shared. The RBW setting is unique for each measurement.

VBW

The VBW setting enables/disables the Video Bandwidth filter. VBW is used in traditional swept analyzers to reduce the effect of noise on the displayed signal. The VBW algorithm in the analyzer emulates the VBW filters of traditional swept analyzers.

The maximum VBW value is 10 times the current RBW setting. The minimum VBW value is 1/10,000 of the RBW setting.



Note: If you are following a procedure that says to "set VBW to three times the RBW value or greater", it means that the test should be conducted with no VBW effects. In the application, this condition is met by disabling the VBW function.

Measurement Params Tab for Signal Strength display

The Measurement Params tab is where you set parameters that control the Signal Strength measurement.

Average: Frequency Domain Number: 10

Off
Time Domain
Frequency Domain

Amplitude Units

Ext Corrections

[Freq & RBW](#) | [Measurement Params](#) | [Channels](#) | [Scale](#) | [Prefs](#)

Average: ▾

[Amplitude Units](#)

[Ext Corrections](#)

Parameter	Description
Average	Enables/disables measurement averaging. Averaging can be enabled in either the Frequency Domain or Time Domain.
Frequency domain	This setting takes the average linear value of the traces (so that rms values are preserved). The number of averages is user-defined. Frequency domain averaging is available in spans larger (or smaller) than the maximum real time bandwidth. This is the mode to use unless you need to extract maximum dynamic range from an ACPR measurement.
Time domain	This setting takes the average linear value of the traces. It is useful if you need to extract maximum dynamic range from an ACPR measurement. The number of traces is user defined. But, the signals must be triggered and repeating. That is, the signal needs to be exactly the same for each acquisition. When this condition is met, each waveform contains the same signal, but the random noise changes from acquisition to acquisition and the average value of the random noise is lowered, while the signal value remains constant. Time domain averaging is not available in spans wider than the maximum real-time bandwidth.
Off	This setting turns averaging off.
Number	Specifies the number of acquisitions to be averaged when Averaging is set to Frequency Domain. Specifies the number of successive capture records that are averaged when Averaging is set to Time Domain.
Amplitude Units	Opens the Units Tab on page 744 dialog box.
Ext Corrections	Opens the External Gain/Loss Correction dialog box.

Channels Tab for Signal Strength display

The Channels tab is where you specify the channel bandwidth measured in the Signal Strength display.

[Freq & RBW](#) | [Measurement Params](#) | [Channels](#) | [Scale](#) | [Prefs](#)

Channel Bandwidth:

Changing the Channel Bandwidth

1. Select the **Channel Bandwidth** number entry box.

2. Enter a value for the channel bandwidth.
3. Select the Close box when you have finished making changes.

Scale Tab for Signal Strength display

The Scale tab allows you to change the vertical and horizontal scale settings. Changing the scale settings changes how the trace appears on the display but does not change control settings such as Center Frequency.

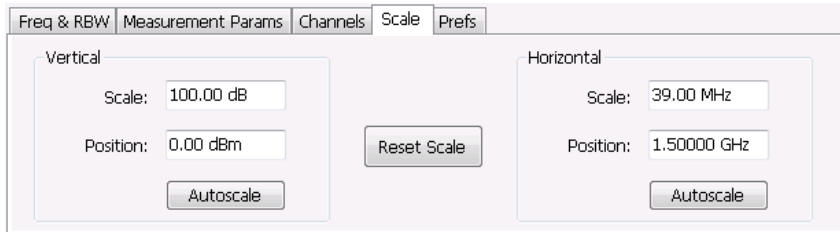

Setting	Description
Vertical	Controls the vertical position and scale of the trace display.
Scale	Changes the vertical scale units. This is only accessible when the vertical units are set to dBm.
Autoscale	Automatically scales the vertical axis to contain the complete trace.
Horizontal	Controls the span of the trace display and position of the trace.
Scale	Allows you to, in effect, change the span.
Autoscale	Automatically scales the horizontal axis to optimize the display of the trace.
Reset scale	Resets all settings to their default values.

Prefs Tab

The Prefs tab enables you to change parameters of the measurement display. The parameters include enabling/disabling Marker Readout, switching the Graticule display on/off, and trace points and detection.

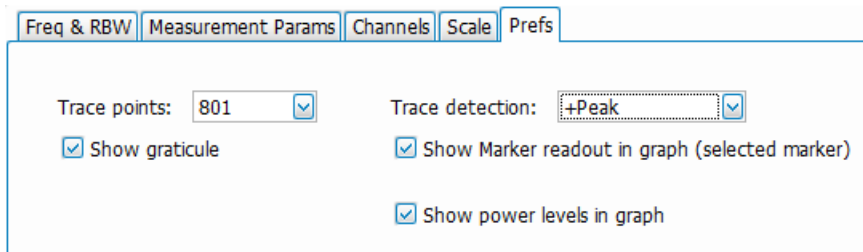

Setting	Description
Trace Points	Sets the number of trace points computed for each line. These are the points used for marker measurements and for results export.
Show graticule	Shows or hides the graticule.
Trace Detection	<p>+Peak: Shows the peak power in a bin (of chosen RBW) if there are multiple points to choose from within a bin.</p> <p>Avg (VRMS): Shows the average power in a bin (of chosen RBW) if there are multiple points to choose from within a bin.</p>
Show Marker readout in graph (selected marker)	Shows or hides the readout for the selected marker in the graph area.

MCPR (Multiple Carrier Power Ratio) Display

Use the MCPR measurement to measure adjacent channel power ratio for multiple main channels or when adjacent channel pairs have different offsets and/or bandwidths. The MCPR display show the Reference Power and the ratio of each adjacent channel to the Reference Power. You can select whether the Reference Power is the total of all active channels or a single channel.

Measuring Multiple Carrier Power Ratio

1. Recall an appropriate acquisition data file, if needed.
2. Press the front-panel **Displays** button.
3. From the **Select Displays** window, select **RF Measurements** or **P25 Analysis** from the Measurements box.
4. Double-click the **MCPR** icon in the **Available displays** box. Click **OK** to complete your selection.
5. Press the **Settings** button. This displays the control panel for MCPR (the tab displayed will be the tab displayed the last time the Settings panel was opened).

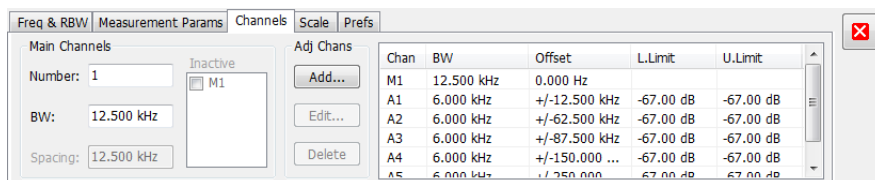

6. Select the **Freq & RBW** tab and adjust the frequency to that of the main channel. You can also adjust the frequency on the Status bar using the Frequency field on the bottom left of the display.
7. Click on the **Channels** tab. To set the number of Main channels, enter the number of Main channels in the **Number** text entry box under **Main Channels**.



Note: As you add channels, the span of the display will be adjusted so that all the channels can be seen.

8. To set the bandwidth of all main channels, enter a value in the **BW** value box.
9. To set the spacing between the main channels, enter a value in the **Spacing** value box.
10. To prevent a main channel power level from being included in the Power Reference (Total) calculation, select the channel to be excluded in the **Inactive** box.
11. To add adjacent channels, click the **Add** button under **Adj Chans**.

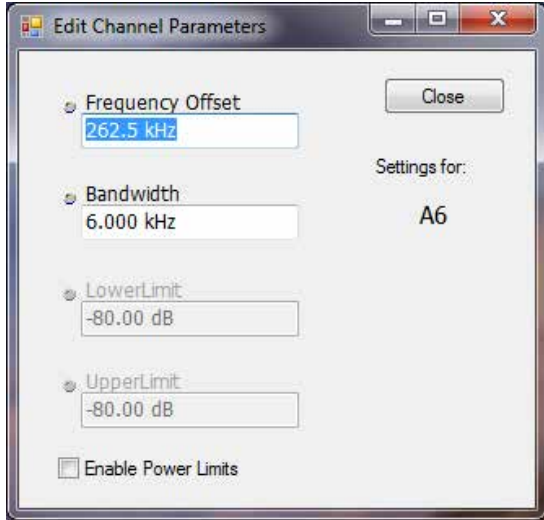

12. To edit Frequency Offset or Bandwidth, click within the value box and use the front-panel knob or your keyboard to set the value. Click **Close** to save your changes.



Note: Frequency Offset is the difference between the center frequency of the selected channel and the Measurement Frequency. All channels (Main or Adjacent) are specified by their offset from the Measurement Frequency.

13. To enable and define power limits, check the **Enable Power Limits** box and enter the desired Upper and Lower limits. You can read more about power limits [here](#).

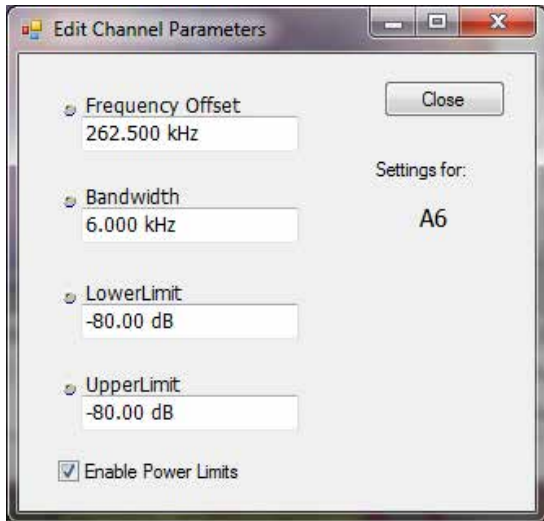

14. After you have configured the Main and Adjacent channels, click the close button in the Settings panel or the **Settings** button to remove the settings panel.
15. Click the **Run** button to take the measurements. Click the **Replay** button if you are using a recalled acquisition data file.

Viewing Results

MCPR measurement results are displayed both in the spectrum graph and in a table below the spectrum display. Individual Main channel power measurements appear in the graph under their channel identifiers. Individual adjacent channel power ratios also appear in the graph under the adjacent channel identifier.

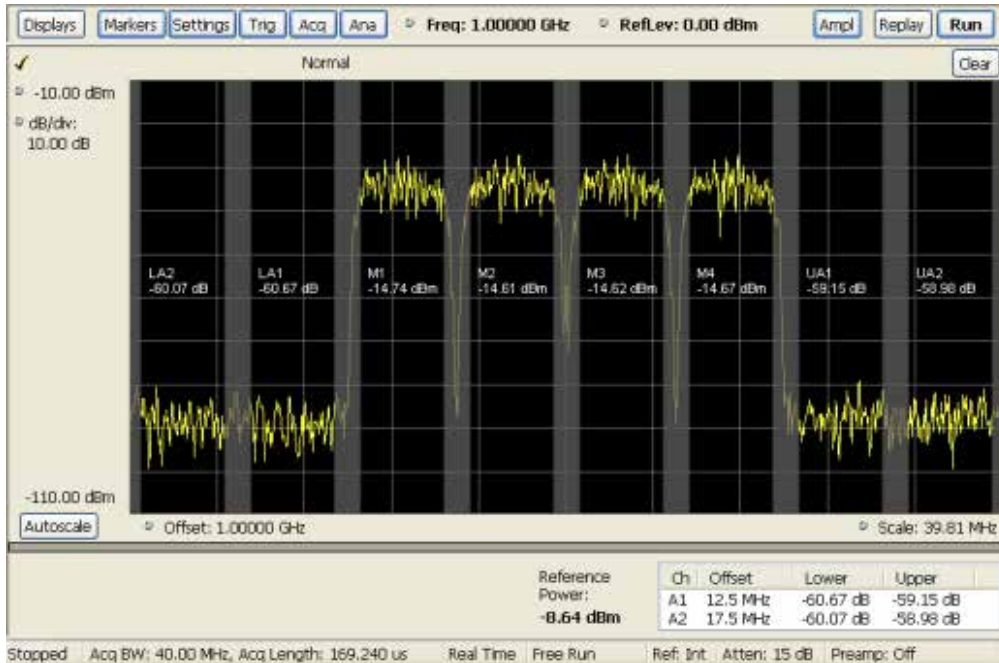

The following table details the entries in the results table.

Heading	Description
Ch	Identifies the adjacent channels. Adjacent channels are numbered according to their offset from the Main channel. The closest channel is numbered 1. The next closest channel is numbered 2; and so forth. The prefix "L" means lower; "U" means upper.
Offset	The offset is the difference in frequency between the Measurement Frequency and the center frequency of the channel.
Lower	Displays the ratio of the lower adjacent channel power to the Power Reference.
Upper	Displays the ratio of the upper adjacent channel power to the Power Reference.
L. Limit	Displays the lower power limit.
U. Limit	Displays the upper power limit.
Power Reference	Depending on the selected Power Ref, this readout displays either the power of the selected main channel or the total power in the active main channels.

Depending on the number of adjacent channels, to see all the measurements, you might need to drag the divider bar between the main display and the results table at the bottom of the window to change the height of the results table.

[Setting M CPR Measurement Parameters](#)

Setting Power Limits

When power limits are enabled (**Settings > Channels > Add** or **Settings > Channels > Edit**), the comparison of the actual results of an adjacent channel is done against the limits. If there is a failure, the Lower and Upper power cells in the M CPR table will be red and the

failure segments of the trace display will be red. The words **Fail** in red will also appear in the top left corner of the display (even if one adjacent band fails). See the following image for an example.

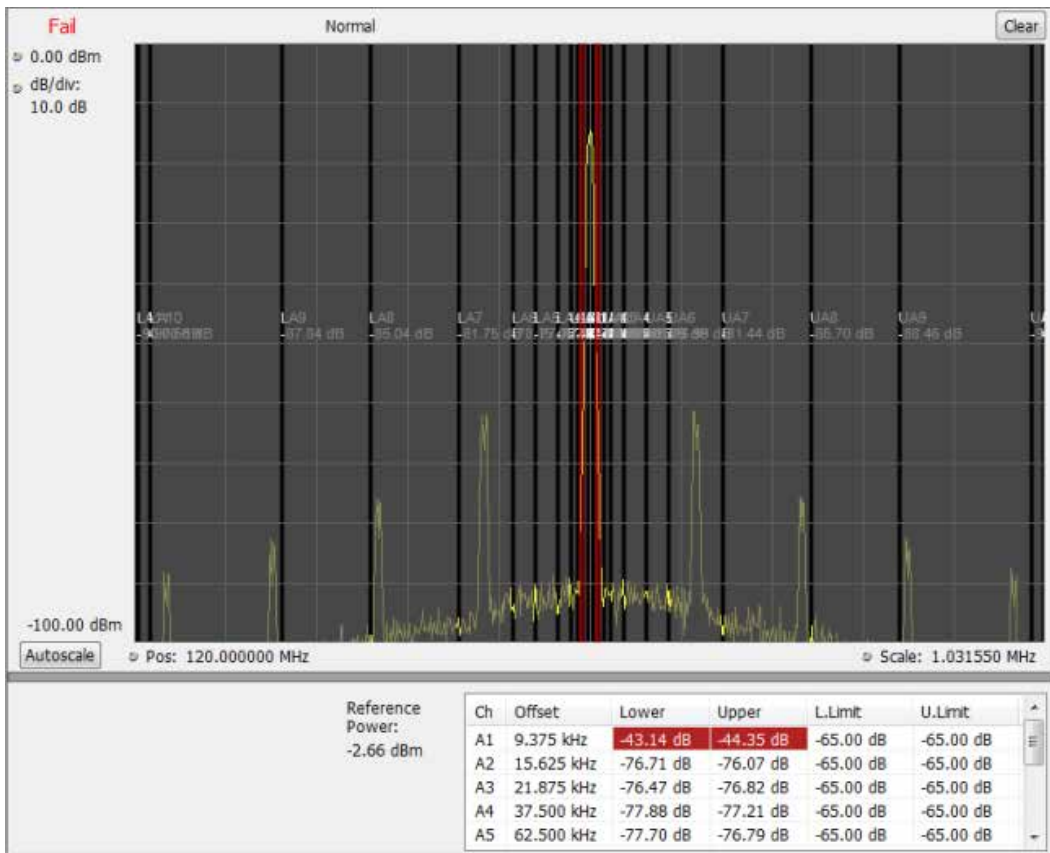

Multiple Carrier Power Ratio

The ratio of the signal power in an adjacent channel to the power in one or more main channels.

MCPR Settings

Main menu bar: **Setup > Settings**

The Setup control panel tabs for MCPR (Multiple Carrier Power Ratio) are:

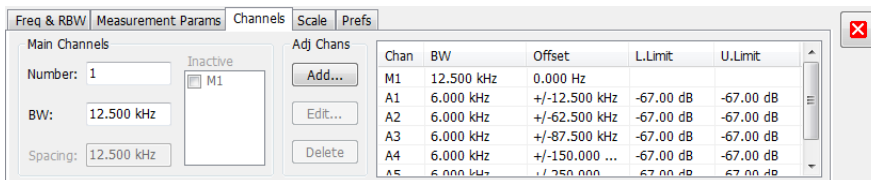

Settings tab	Description
Freq & RBW	Specify the frequency and resolution bandwidth used for the MCPR measurements.

Table continued...

Settings tab	Description
Measurement Params	Specifies parameters controlling how the MCPR measurement is made.
Channels	Specifies the parameters of the channels to be measured.
Scale	Specifies the vertical and horizontal scale and offset values.
Prefs	Specifies whether or not certain display elements are shown.

Restore defaults. Sets parameters for a 4-carrier WCDMA measurement.

Freq & RBW Tab for ACPR and MCPR Displays

The Freq & RBW tab specifies frequency parameters for the Channel Power & ACPR measurements and MCPR measurement.

Setting	Description
Meas Freq	Specifies the center/measurement frequency.
Step	The Step control sets the increment/decrement size for the adjustment of the center frequency. If Auto is enabled, the analyzer will adjust the Step size as required.
RBW	Select Auto or Manual. Adjusts the RBW for the entire measurement. This setting is Independent of the Spectrum view's RBW setting.
VBW	Adjusts the VBW (Video Bandwidth) value. VBW Maximum = 10 times the current RBW value. VBW Minimum = 1/10,000 RBW setting.



Note: While the center frequency and step settings on this control tab are shared between ACPR, MCPR and Occupied Bandwidth, the RBW setting is not shared. The RBW setting is unique for each measurement.

VBW

The VBW setting enables/disables the Video Bandwidth filter. VBW is used in traditional swept analyzers to reduce the effect of noise on the displayed signal. The VBW algorithm in the analyzer emulates the VBW filters of traditional swept analyzers.

The maximum VBW value is 10 times the current RBW setting. The minimum VBW value is 1/10,000 of the RBW setting.

Measurement Params for ACPR and MCPR Displays

The Measurement Params tab is where you set parameters that control the ACPR and MCPR measurements.

Requires triggered synchronous signal

Freq & RBW | **Measurement Params** | Channels | Scale | Prefs

Average: Time Domain | Number: 10 | Channel Filter: Root-raised Cosine

Correct for Noise Floor

Power Reference: Total (active channels) | Filter Parameter: 0.22

Chip Rate: 3.84 MHz

Freq & RBW | **Measurement Params** | Channels | Scale | Prefs

Average: Frequency Domain | Number: 10 | Channel Filter: Root-raised Cosine

Correct for Noise Floor

Filter Parameter: 0.22

Symbol/Chip Rate: 3.84 MHz

Parameter	Description
Average	Enables/disables measurement averaging. Averaging can be enabled in either the Frequency Domain or Time Domain.
Frequency-domain	This setting takes the average linear value of the traces (so that rms values are preserved). The number of averages is user-defined. Frequency domain averaging is available in spans larger (or smaller) than the maximum real time bandwidth. This is the mode to use unless you need to extract maximum dynamic range from an ACPR measurement.
Time-domain	This setting takes the average linear value of the traces. It is useful if you need to extract maximum dynamic range from an ACPR measurement. The number of traces is user defined. But, the signals must be triggered and repeating. That is, the signal needs to be exactly the same for each acquisition. When this condition is met, each waveform contains the same signal, but the random noise changes from acquisition to acquisition and the average value of the random noise is lowered, while the signal value remains constant. Time domain averaging is not available in spans wider than the maximum real-time bandwidth.
Off	This setting turns Average off.
Number	Specifies the number of acquisitions to be averaged when Averaging is set to Frequency Domain. Specifies the number of successive capture records that are averaged when Averaging is set to Time Domain.
Correct for Noise Floor	Enables/disables the Noise Floor Correction function.
Power Reference	Specifies power against which the results are compared. Choices available are each of the existing main channels and "Total (active channels)". Only present when MCPR is the selected display.
Channel Filter	Specify the channel filter used. Select between None (default) and Root-raised Cosine.

Table continued...

Parameter	Description
Filter Parameter	Value entry box for the Root-raised Cosine filter Adjacent Channel Filter. Present only when the Channel Filter is set to Root-raised Cosine.
Chip Rate	Value entry box for the Root-raised Cosine chip rate. Present only when the Channel Filter is set to Root-raised Cosine.

Correct for Noise Floor

This setting is only available when an RSA500 series or RSA600 series instrument is connected.

When this setting is enabled, the instrument applies a correction to the ACPR or MCPR measurement to reduce the effect of instrument noise on the results. It generates this correction by taking a preliminary acquisition to measure the instrument noise floor. Once this is done, the measurement proceeds, applying the correction to each result. When any relevant settings (reference level, attenuator, frequency, or span) are changed, the instrument performs a new noise measurement and correction.

The noise correction signal is created by switching off the input to the RSA and performing acquisitions of the instrument internal noise. A minimum of 100 acquisitions are averaged to create the noise reference signal. It is possible to increase the number of acquisitions for creation of the noise reference signal. When frequency domain averaging is enabled and the number of averages exceeds 100, the number of frequency domain averages becomes the total number of acquisitions to determine the instrument internal noise. Noise is measured for each channel defined by the measurement. The noise reference from each channel is subtracted from the incoming signal power for each channel to create the corrected result. All calculations are performed in Watts, and then converted to the desired units.

The amount of noise correction is limited to 12 dB to avoid the possibility of a negative power measurement. This is a rare condition that could occur if the subtraction of the reference power from the channel power results in a negative value (or 'infinite' dBm).

The measured values differ from the displayed trace in two ways. First, any filtering applied to the channels is not displayed on the trace. Second, the single value of measured noise for a channel is subtracted from each trace point in the channel, rather than offsetting the entire channel by a single amount. This produces a smooth trace with no discontinuities at the channel edges.

Channels Tab for MCPR

Main menu bar: Setup > Settings > Channels



The Channels tab is where you specify the parameters for the channels measured in the MCPR display.

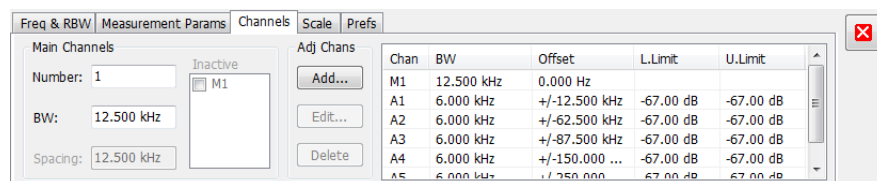

Setting	Description
Main Channels	
Number	Sets the number of Main channels.

Table continued...

Setting	Description
BW	Sets the bandwidth of the Main channels. The maximum channel bandwidth is 39.6 MHz for USB instruments.
Spacing	Sets the frequency difference between the centers of the Main channels.
Inactive	Selected channels are ignored by the measurement routine.
Adj Chans	
Add	Opens the Edit Channel Parameters dialog, which you use to specify the parameters of a new pair of adjacent channels. You can add up to 50 adjacent channel pairs.
Edit	Opens the Edit Channel Parameters dialog box. (You must first select a channel to enable the Edit button.)
Delete	Deletes the selected main channel or adjacent channel pair.
Channel Definition table	A table of the parameters for every channel. Offset is the frequency difference between the Center Frequency and center of the selected channel. Nothing in the table is editable directly. You can set the upper and lower limits by clicking on the Add button.

The following figure illustrates the settings controlled from the Channels tab.

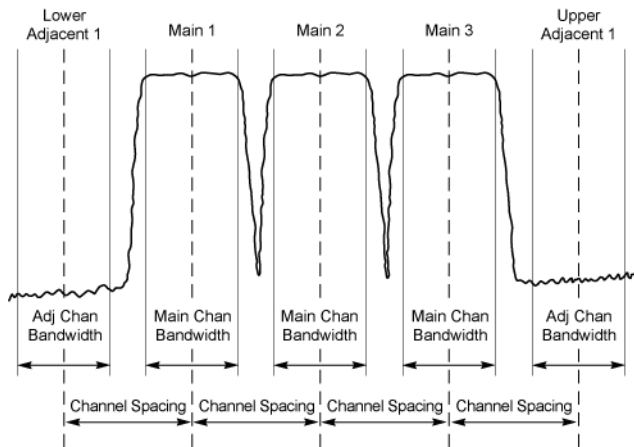

Editing Channel Parameters

To edit the offset or bandwidth of a Main channel:

1. Select the value in the **BW** or **Spacing** number entry boxes.
2. Adjust the value as required. All the Main channels share the same BW and Spacing.
3. Select the appropriate check box to make a channel Inactive, as appropriate.
4. Click the Close button when you have finished making changes.

To edit the offset or bandwidth of an Adjacent channel:

1. Select the channel to be edited in the channel definition table.

2. Select **Edit**. This displays the **Edit Channel Parameters** dialog box.
3. Adjust the values for the **Frequency Offset**, **Bandwidth**, and upper and lower **Limits**, as required.
4. Click the Close button when you have finished making changes.

Adding Channels

To add a main channel:

1. Select the **Number** entry box.
2. Use the knob to enter a value for the desired number of Main channels.
3. Click the Close button when you have finished making changes.

To add an adjacent channel pair:

1. Select **Add**. This displays the **Edit Channel Parameters** dialog box.
2. Use the knob to enter values for the **Frequency Offset**, **Bandwidth**, and upper and lower **Limits**, as required. The Frequency Offset is measured from the Meas Frequency of the Main channels.
3. Click the Close button when you have finished making changes.

Deleting Channels

To delete a main channel:

1. Select the **Number** entry box.
2. Use the knob to reduce the number of channels or enter a new value using the front-panel keypad.
3. Click the Close button when you have finished making changes.

To delete an adjacent channel:

1. Select the channel to be deleted in the channel definition table.
2. Select **Delete**. This removes the selected channel from the channel table.
3. Click the Close button when you have finished making changes.

Occupied BW & x dB BW Display

The Occupied BW display shows the bandwidth within which 99% (a user-defined value, the default is 99%) of the power transmitted within the measurement bandwidth falls.

To show the Occupied BW display:

1. Recall an appropriate acquisition data file.
2. Press the **Displays** button or select **Setup > Displays**.
3. In the **Select Displays** dialog, select **RF Measurements** in the **Measurements** box.
4. In the **Available displays** box, double-click the **Occupied Bandwidth** icon or select the icon and click **Add**. The Occupied Bandwidth icon will appear in the **Selected displays** box and will no longer appear under Available displays.
5. Click **OK** to display the Occupied Bandwidth.
6. Press the **Replay** button to take measurements on the recalled acquisition data file.

Elements of the Display

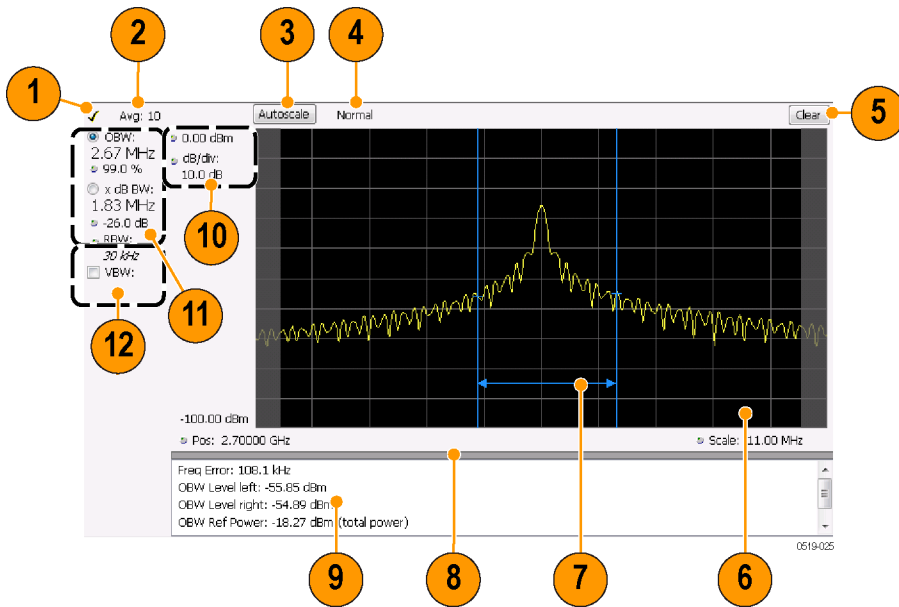

Item	Display element	Description
1	Check mark indicator	The check mark indicator denotes the display for which the acquisition hardware is optimized. This indicator appears only when the display is the selected display. <div style="display: flex; align-items: center;"> <p>Note: When <i>Best for multiple windows</i> is selected in the Amplitude control panel's RF & IF Optimization control, none of the measurement displays shows a checkmark, as there is not a single optimized measurement.</p> </div>
2	Averaging readout	Appears when averaging is enabled (Settings > Parameters tab > Average results). Displays "Avg: n of m" while averaging the results and "Avg: m" once the requested number of results have been averaged.
3	Autoscale	Adjusts the vertical and horizontal settings so that the entire trace fits in the graph.
4	Trace function readout	Displays either Normal or MaxHold to indicate trace function.
5	Clear	Resets count for Average and MaxHold functions. Enabled only when Averaging or MaxHold is enabled. Pressing Clear will clear the trace and, if acquisition is running, restart the averaging or hold process.
6	Graph	Displays the input signal. Shaded areas indicate the measurement bandwidth (Settings > Parameters tab > Measurement BW).
7	Blue lines	The blue lines indicate where the selected results (selected in the Main results area) are being measured on the trace.
8	Grid divider	Determines the portion of the display allocated to the graph and detailed results area. You can move the grid divider all the way to the top or bottom and any position in between.

Table continued...

Item	Display element	Description
9	Detailed results area	Displays additional measurements results.
10	Position and dB/div Units (not shown)	Position sets the top of graph value. The dB/div setting is the vertical scale value. Sets the global amplitude units for all the views in the analysis window. This will change the amplitude selection in the Units tab of the Amplitude control panel.
11	Main results area	Displays results for Occupied Bandwidth (OBW) and x dB bandwidth. Use the two radio buttons to select which of the two results are illustrated in the graph with the blue lines and arrows. There are also controls for adjusting OBW % Power, x dB BW, and RBW.
12	VBW	Enables the VBW (Video Bandwidth) filter. Displays current VBW filter setting. See Setup > Settings > Freq & RBW tab .

Detailed Results Readouts

Measurement	Description
Freq Error	The frequency difference between the measured carrier frequency of the signal and the user-selected center frequency of the analyzer.
OBW Level left	The signal level at the left edge of the occupied bandwidth.
OBW Level right	The signal level at the right edge of the occupied bandwidth.
OBW Ref Power	The total power measured within the measurement bandwidth.
x dB BW Ref Power	The peak power measured within the measurement bandwidth.

[Changing the Occupied Bandwidth Settings](#)

Occupied Bandwidth

Bandwidth within which some defined percentage of the power transmitted on a single channel lies.

Occupied BW & x dB BW Settings

Main menu bar: Setup > Settings

The control panel tabs for the Occupied Bandwidth display are shown in the following table.

Settings tab	Description
Freq & RBW	Allows you to specify the Center Frequency, Step size and RBW.
Table continued...	

Settings tab	Description
Parameters	Allows you to specify the Occupied BW % Power, x dB level, Measurement BW, enable averaging and the Max Hold function.
Scale	Allows you to set the vertical and horizontal scale parameters.
Prefs	The Prefs tab enables you to set characteristics of the measurement display.

Parameters Tab

The Parameters tab enables you to specify parameters that control the Occupied BW measurement.

The screenshot shows the 'Parameters' tab interface with the following settings:

- Occupied BW % Power: 99.0 %
- x dB level: -26.0 dB
- Measurement BW: 10.00 MHz
- Max Hold spectral data
- Average results
- Count: 10

Setting	Description
Occupied BW % Power	Specifies the proportion of power within the occupied bandwidth (referenced against the total power in the measurement bandwidth).
x dB level	x dB level defines the x dB BW level search threshold.
Measurement BW	Specifies the frequency range used by the measurement.
Max Hold spectral data	Enables the Max Hold function.
Average results	Enables/disables results averaging. Note that this is not an averaging of the trace, but an averaging of the results.
Count	Specifies the number of results averaged to calculate the Occupied BW. Range: 2 to 10,000.

x dB Level

The x dB level determines the x dB BW. The instrument analyzes the spectrum trace to locate the frequencies at which the level is x dB down from the peak level calculated over the measurement bandwidth. The frequency difference between the upper and lower crossing thresholds is the x dB BW.

Range: -80.0 to -1.0 dB; Resolution: 0.1%; Inc/dec small: 0.1%, large: 1%; Default: -26 dB

Max Hold Spectral Data

Max Hold displays the maximum value in the acquisition record for each display point. Each new trace display point is compared to the previous maximum value and the greater value is retained for display and subsequent comparisons.

Spurious display

To show the Spurious display:

1. Recall an appropriate acquisition data file.
2. Click the **Displays** button or select **Setup > Displays**.
3. From the Measurements box, select **RF Measurements**.
4. Double-click the **Spurious** icon in the **Available displays** box. This adds the Spurious icon to the **Selected displays** box (and removes it from the Available displays box). Alternatively, you can click the Spurious icon and then click the Add button to select Spurious for display.
5. Click the **OK** button.
6. Press the **Replay** button to take measurements on the recalled acquisition data file.

Elements of the Spurious Display

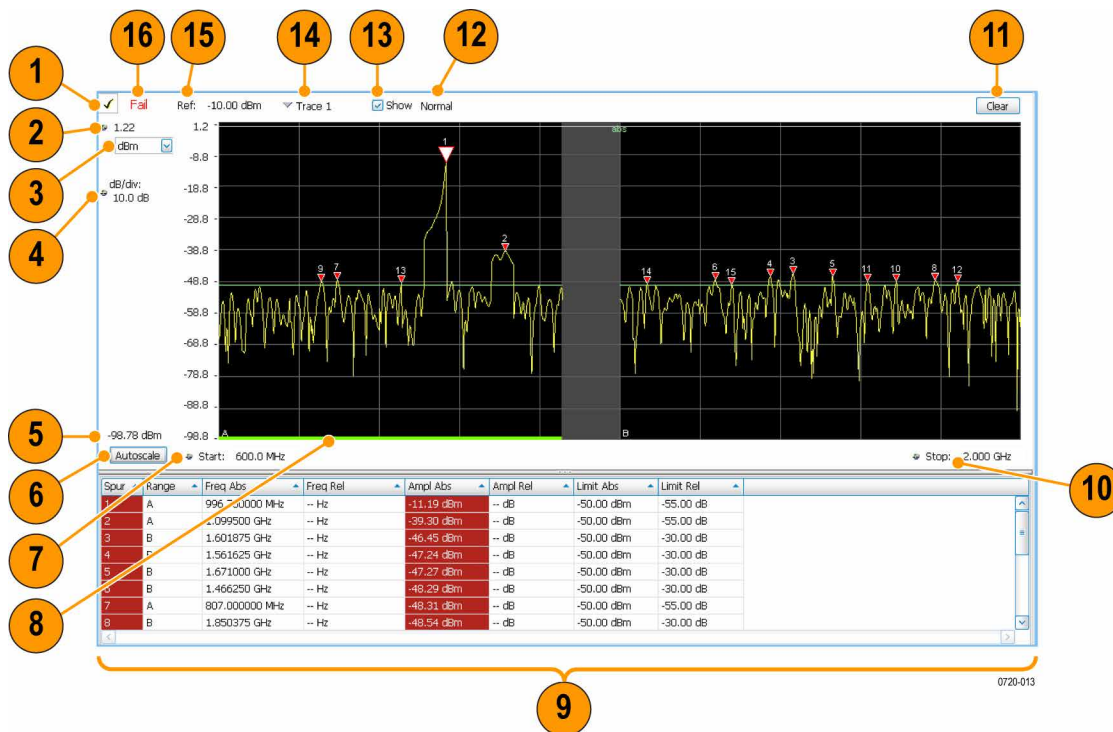

Item	Display element	Description
1	Check mark indicator	Indicates the display for which the acquisition hardware is optimized. <div style="display: flex; align-items: center;"> <p>Note: When <i>Best for multiple windows</i> is selected in the Amplitude control panel's RF & IF Optimization control, none of the measurement displays shows a checkmark, as there is not a single optimized measurement.</p> </div>

Table continued...

Item	Display element	Description
2	Vert Position	Sets the top of graph value. This is only a visual control for panning the graph. The Reference Level is adjusted in the Toolbar and the Ampl control panel. By default, Vert Position = Ref Level.
3	Units	Sets the global Amplitude units for all the views in the analysis window. This will change the Amplitude selection in the Units tab of Analysis Control panel.
4	dB/ div	Sets the vertical scale value. The maximum value is 20.00 dB/division.
5	Bottom-of-graph readout	Indicates the amplitude at the bottom of the graph. This value changes with the dB/div and Vertical Position settings.
6	Autoscale	Adjusts the Vertical and Horizontal scaling to display the entire trace on screen. Selects Multi-range display mode.
7	Start	Adjusts the graph start frequency. This setting affects only visual scaling, not measurement parameters.
8	Green bar	Indicates the range that is selected on the Settings > Ranges and Settings > Limits tabs.
9	Spur table	Displays spur measurements. See the following table for details.
10	Stop	Adjusts the graph stop frequency. This setting affects only visual scaling, not measurement parameters.
11	Clear	Restarts multi-trace functions (Average, Max Hold).
12	Trace function	Indicates the trace processing method. If Average or Max Hold is selected, this readout displays the number of traces being processed (averaged or compared for the Max Hold value).
13	Show	Controls whether the selected trace is visible or not. When trace is Off, the box is not checked.
14	Trace	Selects a trace. Clicking here pops up a context menu listing the available traces, whether they are enabled or not. If you select a trace that is not currently enabled, it will be made enabled.
15	Ref:	If enabled, displays the power reference level.
16	Pass / Fail readout	Indicates whether one or more spurs have exceeded a limit specified on the Settings > Limits tab.

Elements of the Spurious Graph Display

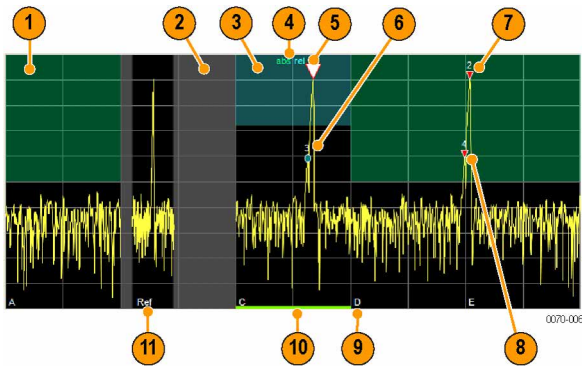

Item	Display element	Description
1		The green line or shading indicates an Abs (absolute) limit. The absolute limit is enabled when the mask is set to Abs, Abs & Rel, or Abs OR Rel. Note that absolute and relative amplitude masks can overlap.
2		The gray-shaded area indicates a portion of the spectrum where no measurements are being taken.
3		The cyan line or shading indicates a Relative limit. The relative limit is enabled when the mask is set to Rel, Abs & Rel, or Abs OR Rel. Note that absolute and relative amplitude masks can overlap.
4	abs rel	Reminder that green-shaded areas highlight absolute limits and cyan-shaded areas highlight relative limits.
5		This indicates the selected spur, when it is in violation of the limits. In Run mode, this is the peak spur violation. The selected marker is highlighted in the Spur table below the graph with a blue background.
6		A spur marker. Indicates a spur that does not exceed the mask settings. See the Settings > Ranges and Limits tab .
7		A violation marker. Indicates a spur that exceeds the mask settings. See the Settings > Ranges and Limits tab .
--		Indicates the selected spur when it is not in violation of the limits. The selected marker is highlighted in the Spur table below the graph with a blue background.
8	1, 2, 3...	A Spur number. The number indicates the row in the spur table that corresponds to the spur. The instrument can display up to 999 spurs.
9	A, B, C, D...	Identifies the enabled ranges.
10	Green bar	Indicates the range selected on the Settings > Ranges and Limits tab tab.
11	Ref	Indicates the location of the power reference. See Settings > Reference .

Elements of the Spur Table

Spur	Range	Freq Abs	Freq Rel	Ampl Abs	Ampl Rel	Limit Abs	Limit Rel
1	B	1.751145 GHz	– Hz	-5.91 dBm	4.09 dB	-15.00 dBm	-15.00 dB
2	E	2.053875 GHz	– Hz	-8.99 dBm	1.01 dB	-15.00 dBm	-10.00 dB
3	D	1.903950 GHz	– Hz	-10.48 dBm	-0.48 dB	-50.00 dBm	-57.00 dB
4	A	1.748826 GHz	– Hz	-39.57 dBm	-29.57 dB	-57.00 dBm	-30.00 dB
5	D	1.899062 GHz	– Hz	-40.31 dBm	-30.31 dB	-50.00 dBm	-57.00 dB

Column	Description
Spur	A number that identifies a spur in the graph area. The instrument can display a maximum of 999 spurs.
Range	The letter representing the frequency range where the spur is located.
Freq Abs	The absolute frequency at which the spur occurs.
Freq Rel	The relative frequency at which the spur occurs. The relative frequency is the difference between the absolute frequency (absolute) and the carrier frequency.
Ampl Abs	The absolute amplitude of the spur.
Ampl Rel	The relative amplitude at which the spur occurs. The relative amplitude is the difference between the absolute amplitude and the carrier amplitude. See the Settings > Limits tab.
Lim Abs	The value of the absolute amplitude limit at the spur frequency. This value can vary even with small spur frequency changes if the start and stop limit values are different. See the Settings > Ranges and Limits tab.
Lim Rel	The relative amplitude limit at which the spur occurs. This value can vary even with small spur frequency changes if the start and stop relative amplitude limit values are different. See the Settings > Ranges and Limits tab.
Blue background	The cell in the Spur column with a blue background identifies the selected spur.
Red background	Cells in the Spur column with a red background identify violations. Cells in the results area with a red background identify the measurement that exceeded a limit.

Rearranging the Columns in the Spur Table

You can rearrange the order of the columns in the Spur Table. To move a column, click on the column heading and drag it to the desired position.

Sorting the Rows in the Spur Table

You can sort the rows in the Spur table by clicking on the column heading. For example, if you click on the Freq Abs heading, the results in the Spur table will be sorted by frequency. If you click on Range, the rows will be sorted by range. Clicking a second time on the same heading reverses the order.

[Changing the Spurious Display Settings](#)

Spurious display settings

Main menu bar: Setup > Settings



The control panel tabs for the Spurious display are shown in the following table.

Settings tab	Description
Parameters	Specifies whether the graph displays one range or multiple ranges. Specifies whether all spurs are shown or only spurs over specified limits.
Reference	Specifies the Power Reference level.
Ranges	Specifies start and stop frequencies of ranges and which ranges to take measurements in. Sets parameters that define a spur. Review, save and load the Range table from this tab.
Limits	Specifies Pass/Fail limit parameters.
Traces	Specifies the trace Function.
Scale	Specifies the vertical and horizontal scale settings.
Prefs	Specifies the appearance features of the graph area.

Restore defaults. Sets the Spurious parameters to their default values.

Parameters Tab

The Parameters tab enables you to specify settings that control the Spurious measurement.

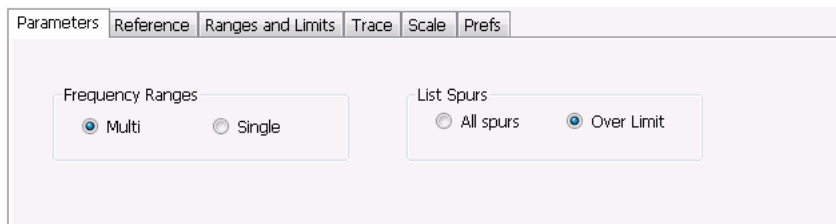

Setting	Description
Frequency Ranges	
Multi	Enables the instrument to display all enabled ranges in the graph.
Single	Limits the graph to the display of only one range. The displayed range is set to the range that contains the selected spur.
List Spurs	

Table continued...

Setting	Description
All spurs	Displays any spur that exceeds the Threshold and Excursion values set on the Ranges tab.
Over Limit	Displays only spurs that exceed both the Threshold and Excursion values set on the Ranges tab and the limits specified on the Limits tab.

Reference Tab

The Reference tab enables you to specify the Power Reference parameter. The Power reference parameter is used to calculate relative values in the Spur table and to calculate relative amplitude limits.

The screenshot shows the 'Reference' tab in a software interface. It features a 'Power reference:' dropdown menu with options: 'Manual level' (selected), 'Carrier', 'Manual level', and 'No reference'. To the right, there is a 'Reference power level:' text input field containing the value '-10.00 dBm'. Above the main content are several tabs: 'Parameters', 'Reference', 'Ranges and Limits', 'Trace', 'Scale', and 'Prefs'.

Setting	Description
Power Reference	Specifies the power reference level used for relative values and limits.
No reference	Power level readings are calculated only for absolute values, no relative values are calculated.
Manual level	The reference level for relative measurements is specified by the Reference power level setting.
Carrier	The reference level for relative measurements is based on the power level calculated at the specified carrier frequency.

Setting the Power Reference Level to No Reference

This screenshot shows the 'Reference' tab with the 'Power reference:' dropdown menu set to 'No reference'. The rest of the interface, including the other tabs and the 'Reference power level' field, is not visible in this specific view.

To set the power reference to No Reference:

- Select **No reference** from the **Power reference** drop-down list.

Setting the Power Reference Level to Manual Level

Parameters Reference Ranges and Limits Trace Scale Prefs

Power reference: **Manual level** Reference power level: -10.00 dBm

To set the power reference to manual level:

1. Select **Manual level** from the **Power reference** drop-down list. This displays the **Reference power level** entry box.
2. Specify the desired power level in the **Reference power level** entry box.

Setting the Power Reference Level to Carrier

Parameters Reference Ranges and Limits Trace Scale Prefs

Power reference: **Carrier**

Frequency: 1.466000 GHz Res BW: 85 kHz Detection: **+Peak**

Channel width: 8.500 MHz Auto

Threshold: -10.00 dBm Integration BW: 2 MHz

To set the power reference to Carrier:

1. Select **Carrier** from the **Power reference** drop-down list.
2. To set the Carrier frequency, specify the necessary values in the **Frequency** and **Channel width** entry boxes .
3. Specify the **Threshold** level.
4. Specify the **Integration BW**. The Integration BW is the bandwidth over which the carrier is measured.
5. If necessary, specify the Resolution Bandwidth by changing the value in the **Res BW** entry box. Auto is the recommended setting.
6. Set the **Detection** method. Select **+Peak**, **Avg (VRMS)**, or **Avg (of logs)**.



Note: If the power level measured over the Integration BW about the carrier frequency is below the threshold level, the instrument concludes that no carrier is present and no relative measurements will be taken. Absolute measurements will still be taken.

Ranges and Limits Tab

Use the Ranges and Limits tab to specify the parameters that control the Spurious measurement. From the Ranges and Limits tab, you specify the start and stop frequencies for ranges, whether or not a range is enabled, the parameters that specify what constitutes a spur, measurement filter shape and bandwidth, and the detection method used for processing signals, as well as the pass/fail parameters for limit testing.

	On	Start (Hz)	Stop (Hz)	Filter Shape	BW (Hz)	Auto	Detector	VBW (Hz)	VBW On
A	X	1.492500G	1.507500G	RBW	100.000k	X	+Peak	100k	
B	X	1.512500G	1.537500G	RBW	200.000k	X	+Peak	200k	
C		0.000000	0.000000	RBW	1.000M	X	+Peak	1M	
D		0.000000	0.000000	RBW	1.000M	X	+Peak	1M	
E		0.000000	0.000000	RBW	1.000M	X	+Peak	1M	

Expand
Reset layout
Load...
Save...

Setting	Description
Expand	Displays the Ranges and Limits Table in a new, resizable window.
Reset layout	You can reorder columns in the Ranges and Limits Table by dragging the columns to a new position. Clicking Reset Layout returns the column order to the factory default order.
Load	Click to load a saved Ranges and Limits table from a file. The default directory is the last folder to which you saved an Acq data export (.CSV) file.
Save	Click to save the current Ranges and Limits table to a file. The default directory is the last folder to which you saved an Acq data export (.CSV) file.

To specify the ranges and limits for the Spurious measurement:

- Edit the values in the Ranges and Limits table.

You can edit the Ranges and Limits table in two ways:

- Edit values directly from the Ranges and Limits tab. You will need to scroll the table to access all settings.
- Click the **Expand** button. This displays the Ranges and Limits Table in a new window that can be sized to the full screen.

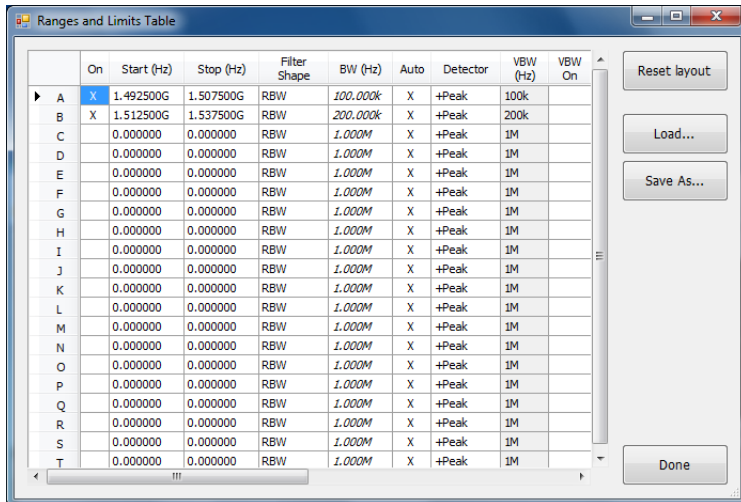

The following table describes the parameters that are set in the Ranges and Limits Table.

Table 14: Ranges and Limits Table Settings

Setting	Description
On	Specifies whether or not measurements are taken in the specified range.
Start (Hz)	Readout of the start frequency for the selected range.
Stop (Hz)	Readout of the stop frequency for the selected range.
Filter shape	Specifies the filter shape used for the Spurious measurement.

Table continued...

Setting	Description
BW (Hz)	Specifies the bandwidth used for the selected filter shape.
Auto	Sets the BW automatically. If CISPR is selected for Filter shape, this control is disabled.
Detector	For CISPR detectors, this selection enables calculation as per the methods described in the CISPR documents. Supported CISPR detectors include CISPR Pk, CISPR QPk, and CISPR Avg. (Requires option SVQPNL or SVQPFL.) and CISPR Avg. For non-CISPR detectors, this selection indicates the processing method used for compressing excess intermediate data into the desired number of trace points.
VBW (Hz)	Adjusts the VBW (Video Bandwidth) value. VBW Maximum: 10 times RBW current value; VBW Minimum: 1/10,000 RBW setting. Disabled when Filter shape is set to CISPR.
VBW On	Specifies whether the VBW filter is applied.
Thrshld (dBm)	Threshold specifies the level that must be exceeded for a signal peak to be recognized as a spur. A signal peak must also exceed the Excursion setting to be considered a spur.
Excrsn (dB)	Excursion specifies the peak to peak magnitude that must be exceeded for a signal peak to be recognized as a spur. A signal transition must also exceed the Threshold setting to be considered a spur.
Mask	Selects the type of limits used for Pass/Fail testing. Spurs that exceed the mask settings are considered violations. The available choices are shown below.
Abs	Spurs that exceed the Absolute limits settings are identified as violations.
Rel	Spurs that exceed the Relative limits settings are identified as violations.
Abs & Rel	Spurs that exceed both the Absolute and Relative limits settings are identified as violations.
Abs OR Rel	Spurs that exceed either the Absolute or Relative limits settings are identified as violations.
Off	Turns off limit testing for the selecting range. Measurements are still taken in the range, but violations are not flagged. Signal peaks that exceed the Threshold and Excursions values will still be identified as spurs.
(Abs Start and Abs Stop)	Absolute amplitude limits are not based on the measured carrier amplitude or manual reference. Start and stop values can be different.
Abs Start (dBm)	Abs Start specifies the limit at the start frequency of the range.
Abs Stop (dBm)	Abs Stop specifies the limit at the stop frequency of the range.
Abs Same	Sets the limit at the start and stop frequencies to the value set for the start frequency.

Table continued...

Setting	Description
(Rel Start and Rel Stop)	Relative amplitude limits are calculated from the Power Reference. If the Power Reference is set to the Carrier level, the relative amplitude limits will change with the carrier level. Start and stop values can be different.
Rel Start (dB)	Specifies the limit at the start frequency of the range.
Rel Stop (dB)	Specifies the limit at the stop frequency of the range.
Rel Same	Sets the limit at the stop frequency to the value set for the start frequency.
Save As	Click to save the current Ranges and Limits table to a file.
Load	Click to load a saved Ranges and Limits table from a file.
Done	Save changes and close the Ranges and Limits Table window.

Changing the Range Start and Stop Frequencies

To change the range start and stop frequencies, edit the Start and Stop frequencies in the Ranges and Limits Table:

1. Click the **Expand** button on the **Settings > Range and Limits** tab. This displays the Ranges and Limits Table.
2. Click the **On** box for a range to take measurements in the range.
3. Click on the Start or Stop frequency setting to change it. Type in a number for the frequency and a letter as a multiplier. You can use k, m, or g to set the frequency multiplier.
4. Click **Done** to save your changes.

Specifying Spur Requirements

A spur is a signal peak that exceeds both the Threshold and Excursion settings in the Ranges and Limits table. The Threshold and Excursion settings are absolute values; they are not calculated relative to a reference. The Threshold and Excursion settings are specific to the selected range. If you want to use different settings for spurs in different ranges, you have to set the values separately for each range. The Excursion control is used to avoid interpreting a single spur as multiple narrower spurs by requiring the amplitude to drop by the Excursion amount between spurs. Raising the Threshold value means that fewer, larger signals will be identified as spurs.

To specify the spur requirements for a range:

1. Click the **Expand** button on the **Range and Limits** tab. This displays the Ranges and Limits Table.
2. Select the **Range (A–T)** for which you want to specify the spur requirements.
3. Set the **Thrshld** value.
4. Set the **Excrsn** value.

Setting Limits

Use the Limits settings in the Ranges and Limits Table to specify the pass/fail parameters for the Spurious measurement. When the Mask setting is set to any value except off, the instrument identifies any signal peak that exceeds the specified limits as a violation and displays Fail on the screen. If no signal peak exceeds the limits, the instrument displays Pass on the screen.

Performing Pass/Fail Limit Testing

To set limits:

1. Click the **Expand** button on the **Range and Limits** tab. This displays the Ranges and Limits Table.
2. Adjust the Start and Stop frequencies as required for each range you want to test.
3. For ranges that you wish to test, verify that the **On** box is checked.
4. For each range you wish to test, select the desired **Mask** type from the drop-down list.
5. Set the limits as desired in the **Abs Start**, **Abs Stop**, **Rel Start**, and **Rel Stop** boxes. The values you can edit depend on the mask type you select.
6. Verify that the **Thrshld** and **Excrsn** values are set as required. These are the values that define a spur.
7. Click **Done** to save your changes and close the Range and Limits Table window.
8. Click **Run** to begin testing.

CCDF Display

The CCDF (Complementary Cumulative Distribution Function) is a statistical characterization that plots power level on the x-axis and probability on the y-axis of a graph. Each point on the CCDF curve shows what percentage of time a signal spends at or above a given power level. The power level is expressed in dB relative to the average signal power level. The CCDF Display also shows the Average power level and the Peak/Average ratio.

To show the CCDF display:

1. Recall an appropriate acquisition data file.
2. Press the **Displays** button or select **Setup > Displays**. This shows the **Select Displays** dialog box.
3. From the **Measurements** box, select **RF Measurements**.
4. Double-click the **CCDF** icon in the **Available Displays** box. This adds the CCDF icon to the **Selected displays** box.
5. Click the **OK** button.
6. Press the **Replay** button to take measurements on the recalled acquisition data file.

Elements of the CCDF Display

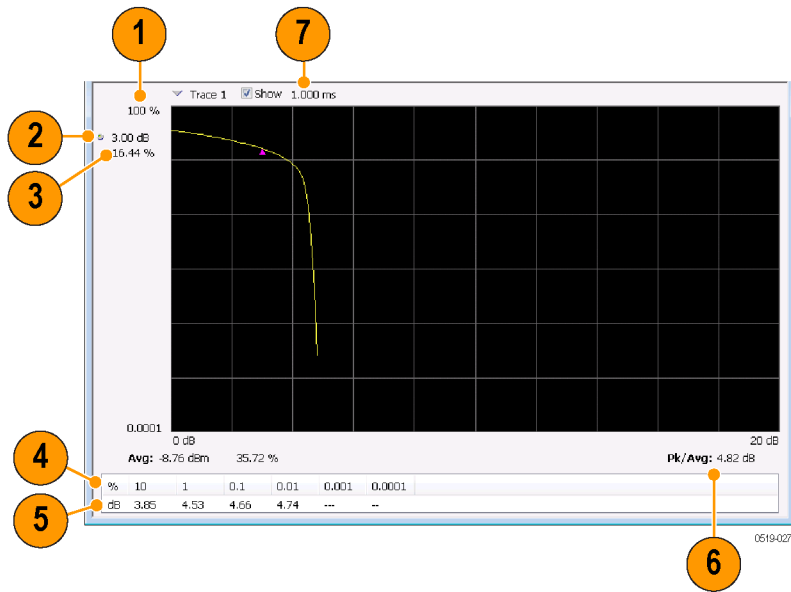

Item	Display element	Description
1	100%	The top of the graph represents the 100% probability that the signal will be at or above the average signal level.
2	Power level select	Adjust to display the value of the CCDF curve at a specific power level. The selected power level is indicated by a small triangle on the CCDF curve.
3	CCDF value	Readout of the value of the CCDF curve at the selected power level.
4	Avg	Readout of the Average power level and the CCDF value at the Average power level.
5	Readout Table	Readout of the CCDF curve at six points.
6	Pk / Avg	Readout of the Peak to Average power ratio.
7	Measurement time	Readout of the length of time used for the measurement. Displays --- s when the Measurement time is set to continuous.

Changing the CCDF Display Settings

CCDF Settings

Main menu bar: Setup > Settings



The control panel tabs for the CCDF Display are shown in the following table.

Settings tab	Description
Parameters	Specifies the time to be measured.
Traces	Select the trace to be measured and select reference trace for display.
Scale	Specifies the vertical and horizontal scale settings.
Prefs	Specifies whether on not certain display elements are shown.

Restore defaults. Sets the CCDF parameters to their default values.

Scale Tab

The Scale tab for the CCDF display allows you to change the start and stop points for the horizontal trace. Changing the scale settings changes how the trace appears on the display but does not change control settings such as Center Frequency.

The screenshot shows the 'Scale' tab selected in a software interface. Under the 'Horizontal' section, there are two input fields: 'Start:' with the value '0.00 dB' and 'Stop:' with the value '20.00 dB'. To the right of these fields is a button labeled 'Reset Scale'.

Setting	Description
Rest Scale	Resets all settings to their default values.
Horizontal	Controls the span of the trace display and position of the trace.
Start	Sets the starting range of the trace.
Stop	Sets the end range of the trace.

Parameters Tab

The Parameters tab enables you to specify several parameters that control signal acquisition for the CCDF Display.

The screenshot shows the 'Parameters' tab selected. Under the 'Measurement Time' section, there are three radio button options: 'Single (use Analysis Length)' (which is selected), 'Total Time: 20.000 ms', and 'Continuous'. To the right of these options is a 'Span:' field with the value '85.0 MHz'.

Setting	Description
Single	When Single is selected, the CCDF measurement is based on the Analysis Time parameters set on Analysis control panel (Setup > Analysis > Analysis Time), shared by all displays. In Single, CCDF is time-correlated with the other open displays.
Total Time	When Total Time is selected, you can adjust its value. The value set here changes the Analysis Length (and Acquisition Length, if needed) to 20 msec. If the Total Time value is longer than the Analysis Length, CCDF uses multiple acquisitions to collect signal data.
Continuous	When Continuous is selected, the CCDF measurement combines each new record (Actual Analysis Length) into the existing result. It does not erase and start over until user presses STOP or CLEAR.
Span	Specifies the range of frequencies used for analysis.

Single

To have statistically meaningful results, CCDF works best when calculated on at least 1 ms of data. Depending on the Analysis Time setting, the CCDF display may present error messages:

- If the Actual Analysis Time is greater than 1 ms, the CCDF Display will calculate the trace without any problems.
- If the Actual Analysis time is less than 1 ms, the CCDF Display will measure the data as best it can, but if it receives fewer than 20 samples, the CCDF display will clear the trace and report "Not enough samples".

Total Time

Setting the Measurement Time to Total Time changes the Analysis Length (and Acquisition Length, if needed) to 20 msec. This can impact other measurements. For instance, the OBW measurement would change because it would get more analysis length than it normally needs, so switching in/out of the CCDF Total Time selection noticeably affects OBW results. This happens to a lesser amount when Measurement Time is set to Single or Continuous. This is because each sets Analysis Length to 1 msec. These different Analysis Lengths may affect other measurements, too.

Phase Noise Display

Phase Noise is available on SignalVu-PC when connected to an RSA7100, MSO 4/5/6 Series and LPD with Option PHASNL-SVPC or PHASFL-SVPC. Phase Noise measures and graphs the power in a 1 Hz bandwidth referenced to the carrier power. This is repeated for many frequency points across a user-adjustable span.

To show the Phase Noise display:

1. Click the **Displays** button or select **Setup > Displays**.
2. From the Measurements box, select **RF Measurements**.
3. Double-click the **Phase Noise** icon in the **Available displays** box. This adds the Phase Noise icon to the **Selected displays** box (and removes it from the Available displays box). Alternatively, you can click the Phase Noise icon and then click the **Add** button to select Phase Noise for display, or drag the Phase Noise icon to the Selected Displays box.
4. Click the **OK** button.

Elements of the Phase Noise Display

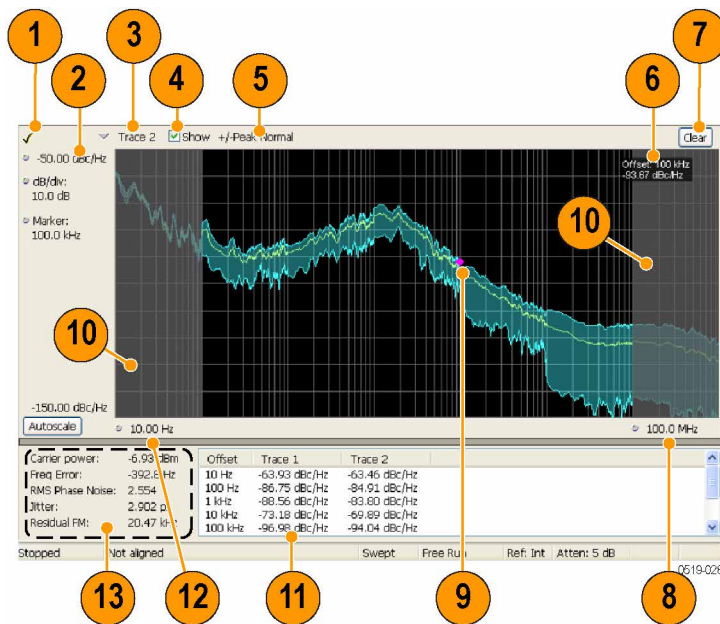

Item	Display element	Description
1	Check mark indicator	Indicates the display for which the acquisition hardware is optimized. Note: When <i>Best for multiple windows</i> is selected in the Amplitude control panel's RF & IF Optimization control, none of the measurement displays shows a checkmark, as there is not a single optimized measurement.
2	Vert Position (dBc/Hz)	Sets the top of graph value. This is only a visual control for panning the graph.
3	Trace selector	Selects a trace.
4	Show check box	Shows/hides the selected trace.
5	Detection method / Average count	Displays the Detector method used for the trace. If Average detection is enabled, the number of averaged traces appears here.
6	Measurement Marker readout	Readout of the value of the phase noise at the selected offset. The Phase Noise measurement marker does not affect the results reported in the readouts or table below the graph, nor is it associated with markers in any other display.
7	Clear	Restarts multi-trace function (Average).
8	Horizontal stop	Readout of the Right Horizontal frequency value. This setting affects only visual scale, not measurement bandwidth. (See Settings > Scale)
9	Measurement marker	Indicates the position of the measurement point.
10	Integration frequency range indicators	The gray-shaded areas denote the frequencies outside the integration frequency range. (See Settings > Settings > Frequency)

Table continued...

Item	Display element	Description
11	Phase Noise Table	Displays the phase noise values at different offsets.
12	Horizontal start	Readout of the Left Horizontal frequency value. Affects only visual scaling, not measurement bandwidth. (See Settings > Scale)
13	Measurement results readouts	Display of the different measured values.

Elements of the Measurement Results Readout / Phase Noise Table

Carrier power:	-6.93 dBm	Offset	Trace 1	Trace 2
Freq Error:	-392.8 Hz	10 Hz	-63.93 dBc/Hz	-63.46 dBc/Hz
RMS Phase Noise:	2.554 °	100 Hz	-86.75 dBc/Hz	-84.91 dBc/Hz
Jitter:	2.902 ps	1 kHz	-88.56 dBc/Hz	-83.80 dBc/Hz
Residual FM:	20.47 kHz	10 kHz	-73.18 dBc/Hz	-69.89 dBc/Hz
		100 kHz	-95.98 dBc/Hz	-94.04 dBc/Hz

Readout	Description
Carrier power	The power level at the carrier frequency.
Freq Error	The measured carrier frequency error.
RMS Phase Noise	The RMS value of the phase noise, measured over the Integration BW.
Jitter	The jitter in seconds, measured over the Integration BW. Includes the effects of random and coherent jitter.
Residual FM	The residual frequency modulation, measured over the Integration BW.
Trace 1	The phase noise on trace 1 at different frequency offset values. Note that if Trace 1 is set to +/- Peak detection, the value displayed in the table is the +Peak value.
Trace 2	The phase noise on trace 2 at different frequency offset values. Note that if Trace 2 is set to +/- Peak detection, the value displayed in the table is the +Peak value.

[Changing the Phase Noise Settings](#)

How Phase Noise Is Measured

If carrier tracking is on, the instrument measures phase noise relative to the highest-amplitude signal within about 20 MHz of the user-entered frequency. The difference between center frequency and the frequency of the measured carrier is reported as frequency error. If carrier tracking is not on, the instrument measures phase noise relative to the amplitude at the user-entered frequency.

The unit will tune to a number of offsets from the carrier frequency, and calculate the spectrum for the frequency range about each offset using a resolution bandwidth appropriate for the offset frequency. This is done to optimize speed while maintaining acceptable frequency resolution. A table of the values used for measurement frequency offset, resolution bandwidths, hardware IF filter bandwidths and RF attenuations is shown below.

Measurement frequency offset range	Measured span	RBW use for spectrum calculation	RF Attenuation
10 Hz to 100 Hz	10 MHz	1 Hz	Auto from ref level
100 Hz to 1 kHz	10 MHz	2 Hz	Auto from ref level
1 kHz to 10 kHz	10 kHz	20 Hz	Auto from ref level
10 kHz to 100 kHz	10 MHz	200 Hz	Auto from ref level
100 kHz to 1 MHz	10 MHz	1 kHz	Auto from ref level
1 MHz to 10 MHz	10 MHz	10 kHz	Auto from ref level
10 MHz to 100 MHz	20 MHz	100 kHz	Auto from ref level
100 MHz to 1 GHz	20 MHz	1000 kHz	Auto from ref level

After acquisition and calculation, the spectrum is corrected to display power in a 1 Hz bandwidth referenced to the carrier power (dBc/Hz). The correction algorithm does not discriminate between noise signals and coherent signals in making the dBc/Hz correction. Since all measured signals are corrected as if they were noise, coherent signal measurement results can contain errors in level. This is a key difference between an SA-based measurement and a dedicated phase noise tester.

The largest difference between operation of a swept spectrum analyzer and a real-time signal analyzer when measuring phase noise is a result of the wide acquisition bandwidths found in the real-time signal analyzer.



At an offset less than or equal to 10 MHz, acquisition bandwidth is 10 MHz. At an offset above 10 MHz, acquisition bandwidth is 20 MHz. In both cases, the RF attenuation is set automatically based on the reference level.

Phase Noise Settings

Main menu bar: Setup > Settings



The control panel tabs for the Phase Noise display are shown in the following table.



Note: Phase Noise is only available with SignalVu-PC when an RSA7100 is connected with Option PHASNL-SVPC or PHASFL-SVPC installed.

Settings tab	Description
<i>Frequency</i>	Specify Measurement BW and Integration BW. Enable carrier frequency tracking and specify the Carrier threshold level.
<i>Parameters</i>	Specifies the Optimization method.
<i>Traces</i>	Specifies trace parameters such as detection method and whether smoothing is enabled. Traces can also be saved and loaded for reference from this tab.
<i>Scale</i>	Specify vertical and horizontal scale settings.
<i>Prefs</i>	Specify appearance features of the graph area.

Restore defaults. Sets the Phase Noise parameters to their default values.

Frequency Tab

Use the Frequency tab to specify parameters used for taking the Phase Noise measurement.

Setting	Description
Measurement BW	This sets the frequency range for the phase noise measurement range. The instrument's Frequency control is used to set the "carrier frequency of interest". The widest available start/stop range is from 10 Hz greater than the carrier frequency ("Start Offset") to 1 GHz above the carrier ("Stop Offset"). Very small start offsets will take significant time to measure as very narrow resolution bandwidths are used in to achieve small-offset measurements. Large-offset stop frequencies cause small effects on measurement time, but will increase the displayed scale of the phase noise plot.
Start Offset	Sets the starting point for the Phase Noise plot. Offset is from the carrier frequency. The minimum start offset is 10 Hz. The maximum start offset is 100 MHz. The setting is limited to powers of ten (1, 10, 100...).

Table continued...

Setting	Description
Stop Offset	Sets the stopping point for the Phase Noise plot. Offset is from the carrier frequency. The minimum start offset is 100 Hz. The maximum stop offset is 1 GHz. The Stop offset value must be at least 10X the Start offset value. The setting is limited to powers of ten (1, 10, 100...).
Integration BW	Integration bandwidth sets the frequency range over which integrated results for phase noise (labeled "RMS Phase Noise") and jitter are calculated. Integration start and stop cannot exceed the measurement bandwidth. If you set the integration bandwidth greater than the measurement, the error message 'Setup error: Integration BW exceeds Measurement BW' will appear.
Start Offset	Specifies the Integration BW's start offset from the carrier frequency.
Stop Offset	Specifies the Integration BW's stop offset from the carrier frequency.
Track carrier frequency	The instrument finds the carrier signal and measures its frequency at least once each time the Phase Noise measurement is taken and reports the error between the Freq setting and the measured frequency of the carrier. When Track carrier frequency is enabled, the measurement adjusts its tuning to counteract the carrier error or drift. When carrier tracking is disabled, the measurement is made using the Freq setting specified by the user.
Carrier threshold	The minimum power level required for the signal to be recognized as a carrier. If no signal is found above this level within 20 MHz of the Freq setting, the Phase Noise measurement will fail.

Parameters Tab

The Parameters tab enables you to specify acquisition settings that control the Phase Noise measurement.

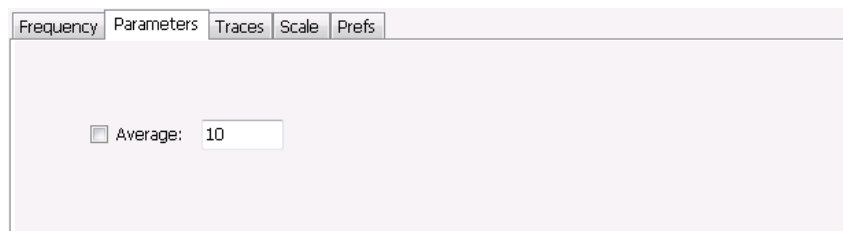

Average. Specifies whether averaging is used or not. This setting affects integrated numeric results and the trace display. The range for this setting is 2 to 100. The default setting is disabled.

Settling Time Measurement Overview

The Settling Time measurement (Option SVTOption 12) is used to measure frequency and phase settling time of frequency-agile oscillators and subsystems. Automated measurements can reduce user-to-user measurement variations, improve repeatability and measurement confidence, and save time in gathering results.

Measurement Definitions

Settling time. The time measured from a reference point to when the signal of interest settles to within user-defined tolerance.

Settled frequency. The final reference frequency, determined automatically or manually. The tolerance band is centered about this settled frequency.

Settled phase. The final reference phase, determined automatically or manually. The tolerance band is centered about this settled phase.

Mask Testing

Mask testing is a tool to automatically determine the pass/fail state of the Device-Under-Test. The mask is defined over three or fewer user-defined time zones, with an independent limit band for each time zone. If the mask is violated, the area of violation is highlighted in red on screen, and a Fail message is displayed. The pass/fail status of the mask test can be queried over GPIB for rapid results. To configure Mask testing, see the [Mask tab](#).

The instrument's Search function can watch the Settling Time measurement for either pass or fail results, and perform actions such as stopping or saving data when the defined condition occurs. See [Mask Test Settings](#) on page 730 for details on configuring Mask Test.

Frequency Settling Time Theory of Operation

The following paragraphs describe how a frequency and phase settling measurement is made.

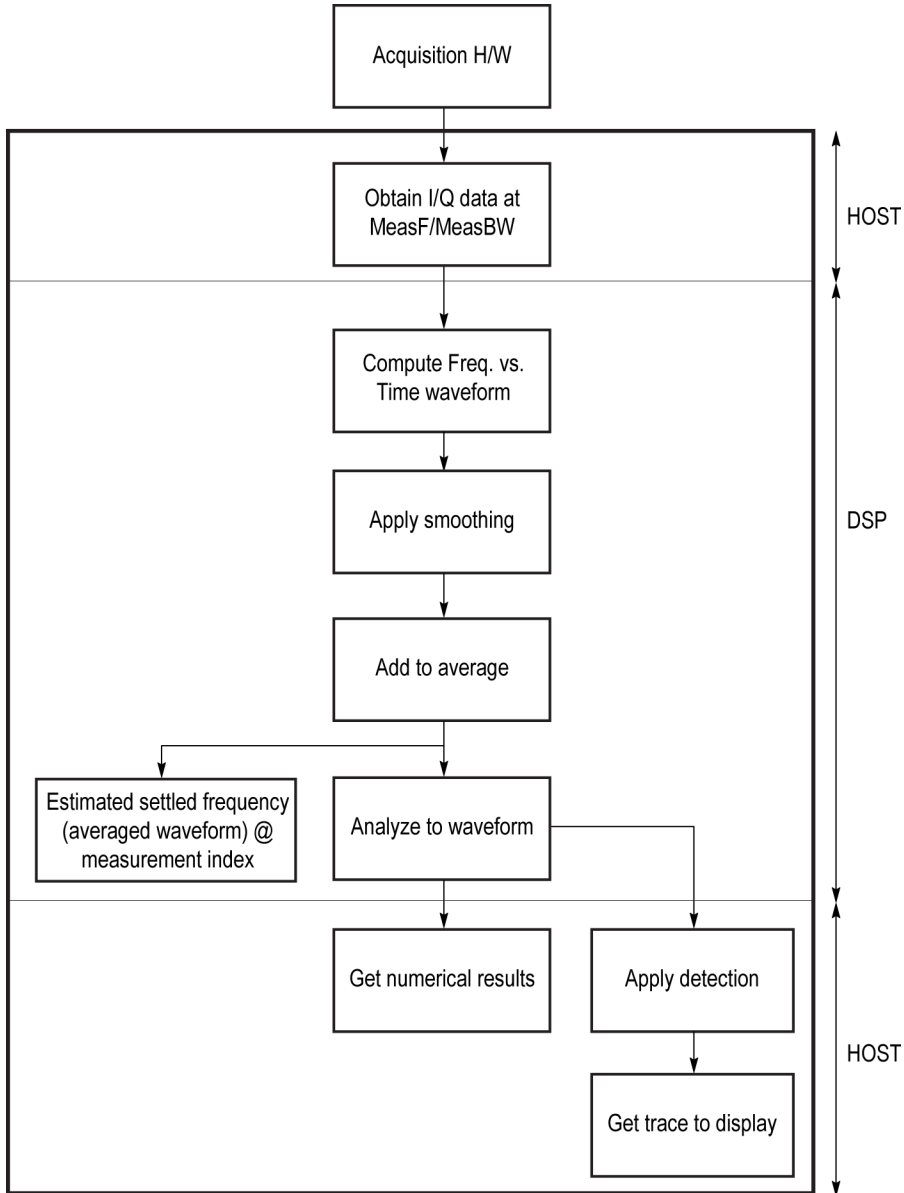

Figure 46: Frequency settling time flow diagram

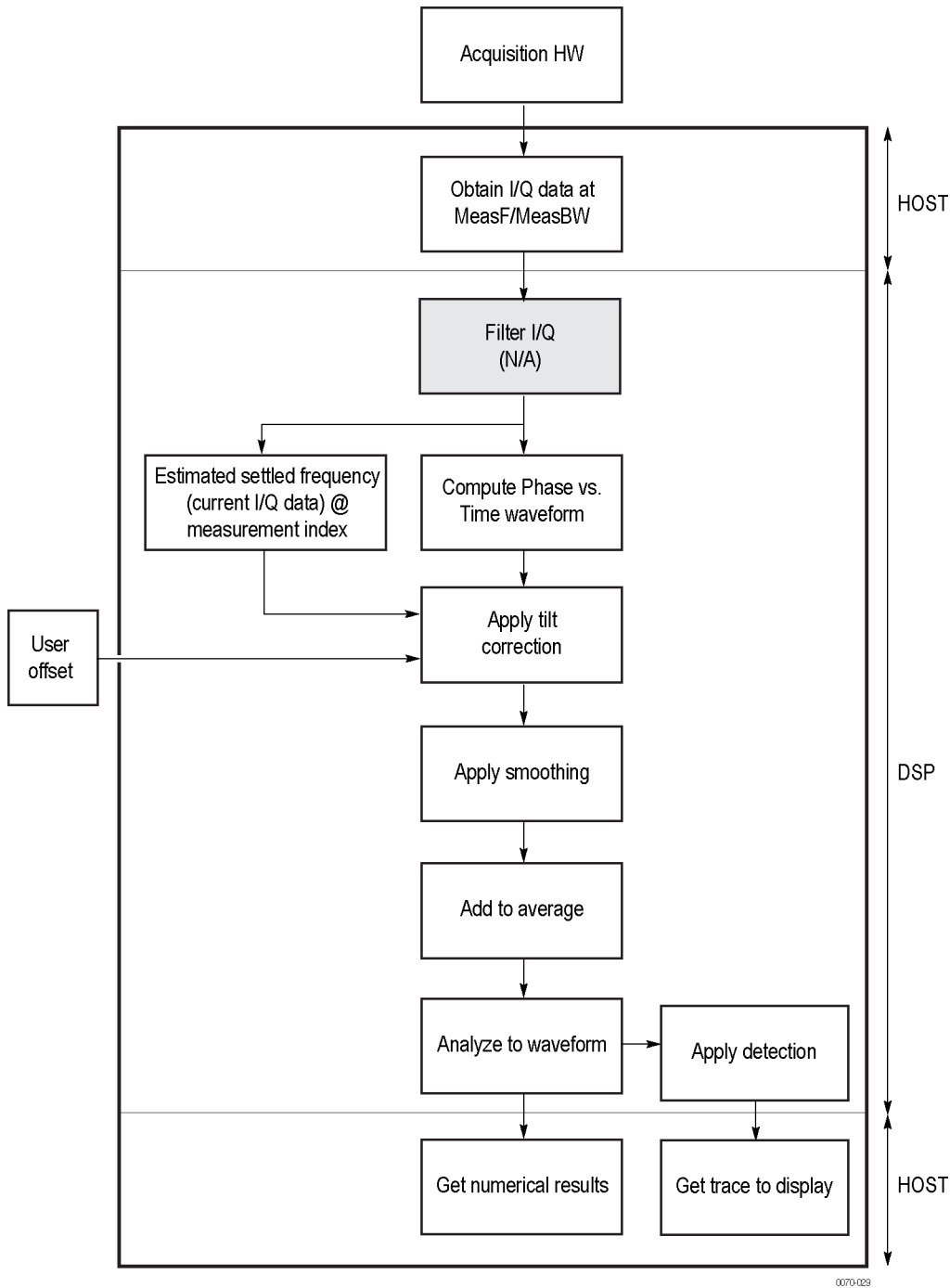

Figure 47: Phase settling time flow diagram

Acquisition hardware collects I and Q samples at the measurement frequency. Sample Rate is based on the measurement bandwidth setting.

The instantaneous phase is computed as:

$$Ph_{(n)} = atan \left(\frac{Q_{(n)}}{I_{(n)}} \right)$$

The instantaneous frequency is the derivative of the phase:

$$Fr_{(n)} = (Ph_{(n-1)} - Ph_{(n+1)}) \times \left(\frac{F_{sampling}}{(2 \times 2PI)} \right)$$

Data smoothing is applied (if selected by the user). This filtering method uses $\pm n$ adjacent samples to produce an average value that is used to replace the values of the original $2n$ samples. An example is shown below.

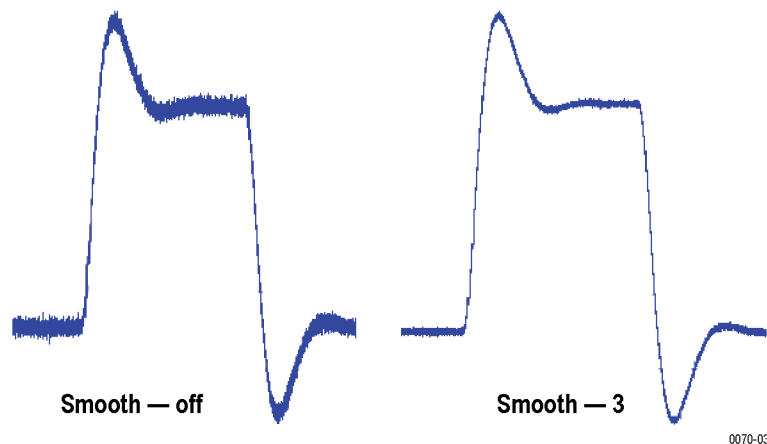

If averaging is turned on, the smoothed data array is averaged with data arrays of previous acquisitions on a point-by-point basis. Smoothing has the advantage of reducing noise-like variations in the measurement, but carries the risk of masking real measurement data. The amount of smoothing applied must be determined by evaluating the waveform you see for artifacts that result from the process.

Next, Settled Frequency is calculated. Settled frequency is the average frequency determined by looking back in time from the point set by the Measurement Length control over a minimum of 256 samples. This value is used to determine the frequency level about which to center the Tolerance range. The measurement then searches backward through the data until it finds the first point that exceeds the tolerance range. A maximum of 20 million acquisition data samples can be processed by the measurement.

Settling Time is measured as the time from the start reference to the point where the frequency remains within the tolerance band. The start reference can be any of three points:

- The trigger point
- The beginning of the analysis period. This result can only be computed when the instrument can find a previous settled state within the measurement period
- The point at the end of the previous frequency hop where the frequency first leaves the tolerance band. This result can only be computed when the instrument can find a previous settled state within the measurement period.

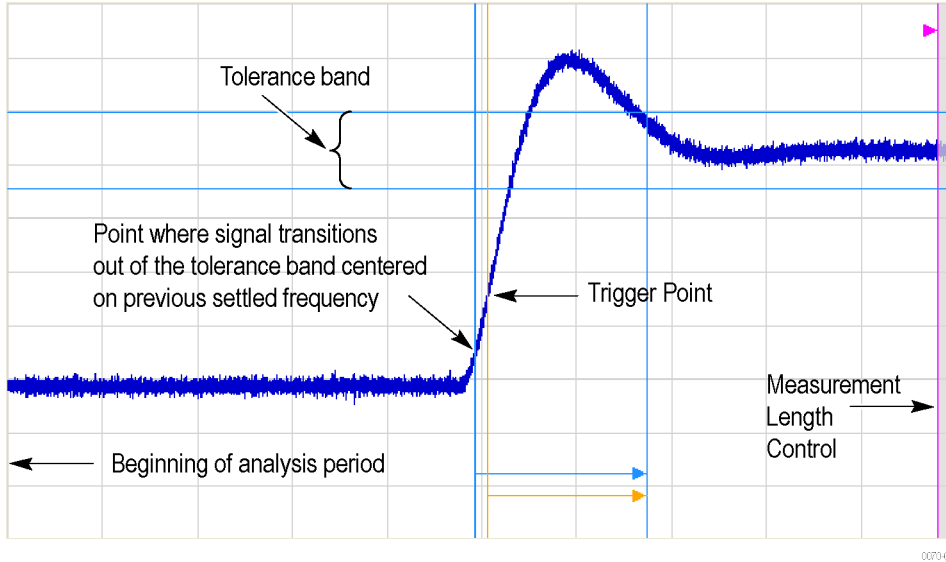

Figure 48: Settling time start reference points

All measurements are now complete and the numeric settling time values can be sent to the display. However, no result traces have been produced yet. Detection is used to reduce the measured points (which can number up to 10 million) to a number more easily processed by the display processor. +/- Peak detection is always used, preserving the maximum positive and negative excursions for display. Reducing the number of points in the result reduces the time resolution of the markers. If averaging is on, the measurement results are computed on the average of the undecimated results.

Phase Settling Time Overview

Phase settling time is determined, as described previously, with the addition of tilt correction.

The instrument estimates tilt (or slope of the phase) using linear least square fitting over (at least) 256 samples of the phase vs. time waveform, looking backwards from the point set by the Measurement Length. The instrument adjusts the phase waveform so that its phase is of zero value at the point set by the Measurement Length.

Settling Time Displays

The Frequency Settling Time measurement is used to measure the frequency settling time of frequency-agile oscillators and subsystems. The Phase Settling Time measurement is used to measure the phase settling time of phase-agile oscillators and subsystems. Automated measurements can reduce user-to-user measurement variations, improving repeatability and measurement confidence and saving time in gathering results. To measure phase settling, a phase reference is required. This means that the measurement tool must be frequency-referenced to the device under test, or must act as the frequency reference to the device under test. To lock the reference to an external source, go to Setup > Configure In/Out > Frequency Reference and choose **External**. Values from 1 MHz to 25 MHz in 1 MHz steps can be used as an external reference.

To show a Settling Time display:

1. Recall an appropriate acquisition data file.
2. Click the **Displays** button or select **Setup > Displays**.
3. From the Measurements box, select **RF Measurements**.
4. Double-click the **Freq Settling** icon or the **Phase Settling** icon in the **Available displays** box. This adds the selected display to the **Selected displays** box (and removes it from the Available displays box).
5. Click the **OK** button.
6. Press the **Replay** button to take measurements on the recalled acquisition data file.

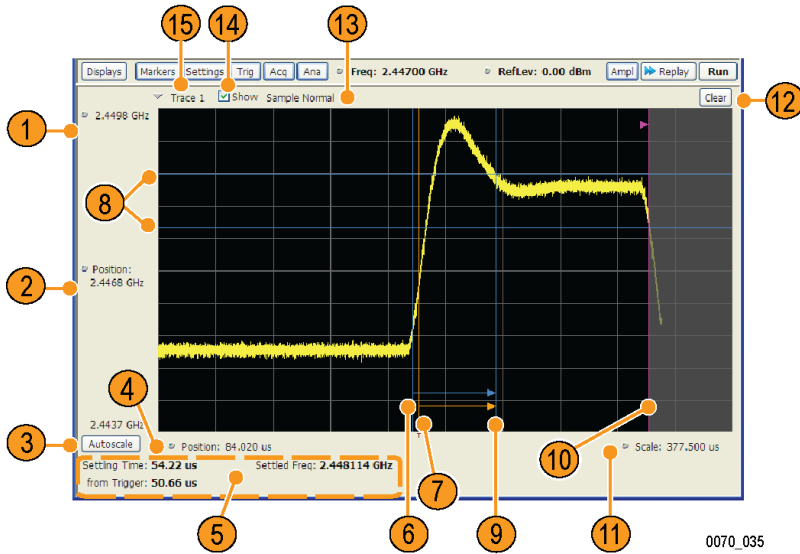

Figure 49: Frequency settling time display

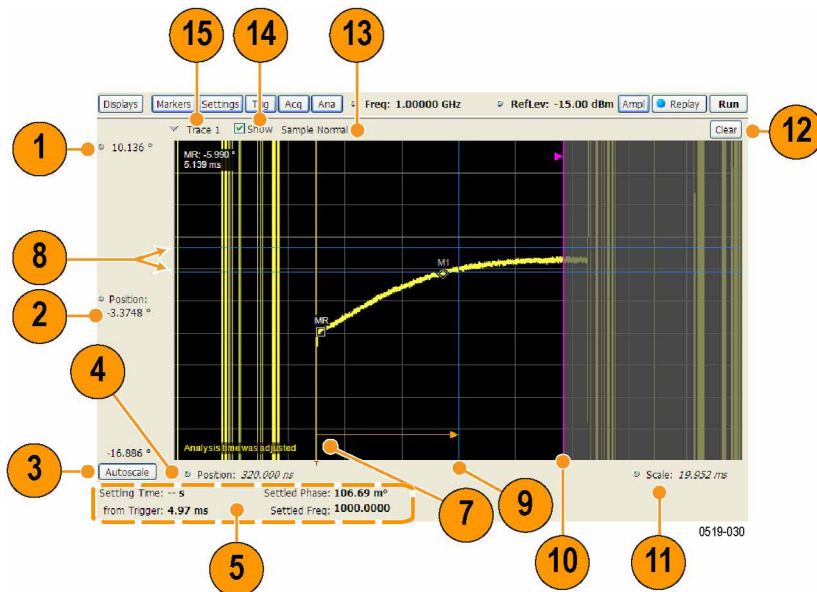

Figure 50: Phase settling time display

Elements of the Display

Item	Display element	Description
1	Top of graph	Sets the frequency/phase that appears at the top of the graph. However, note that the top of graph setting, vertical scale setting (Settings > Scale tab), and Vertical Position settings interact. Adjusting this value changes the frequency/phase at the top of the graph by adjusting the scale setting. Phase Settling Time: Sets

Table continued...

Item	Display element	Description
2	Vertical Position	Sets the frequency/phase value at the vertical center of the graph.
3	Autoscale	Adjusts the Vertical and Horizontal scaling to display the entire trace on screen.
4	Horizontal Position	Sets the horizontal position of the trace on the graph.
5	Measurement readouts	Displays measurement results. See <i>Measurement Readout Text Color</i> below.
6	Signal transition start indicator	A blue vertical line that indicates the starting point of the Settling Time measurement that is based on the signal transition away from the previous settled state, if a previous settled state is found within the measurement period.
7	Trigger point indicator	An orange line and "T" (which appears below the graph) that indicates the location of the trigger point in time.
8	+/- Tolerance indicators	A pair of blue horizontal lines that show the tolerance range.
9	Settled time indicator	A blue vertical bar that shows the point on the trace at which the measurement has determined the signal frequency or phase to be settled.
10	Measurement length indicator	A magenta vertical line that specifies the end of the allowed measurement period. This is a control, not a result.
11	Scale	Adjusts the horizontal (time) scale of the graph.
12	Clear	Restarts multi-trace functions (Avg, Hold) and erases the trace.
13	Function	Displays the Detection and Function selections for the selected trace. (Detection is always +/-Peak for Settling Time measurements.)
14	Show	Controls whether the selected Trace is visible or not. When trace is Off, the box is not checked.
15	Trace	Selects a trace. Touching here displays a menu that shows the available traces and whether they are enabled or not. If you select a trace that is not currently enabled, it will be enabled.

Measurement Readout Text Color

The measurement readouts can appear in either black text or red text. Measurement results that appear in black text indicate:

- the signal is settled AND
- the signal is settled longer than the minimum settled duration AND
- the settling time is valid OR the settling time from trigger is valid

If any of the conditions listed are not met, the measurement results text is red.

Elements of the Frequency Settling Time Graph

The following illustration shows the various indicators that appear in the Frequency Settling Time graph.

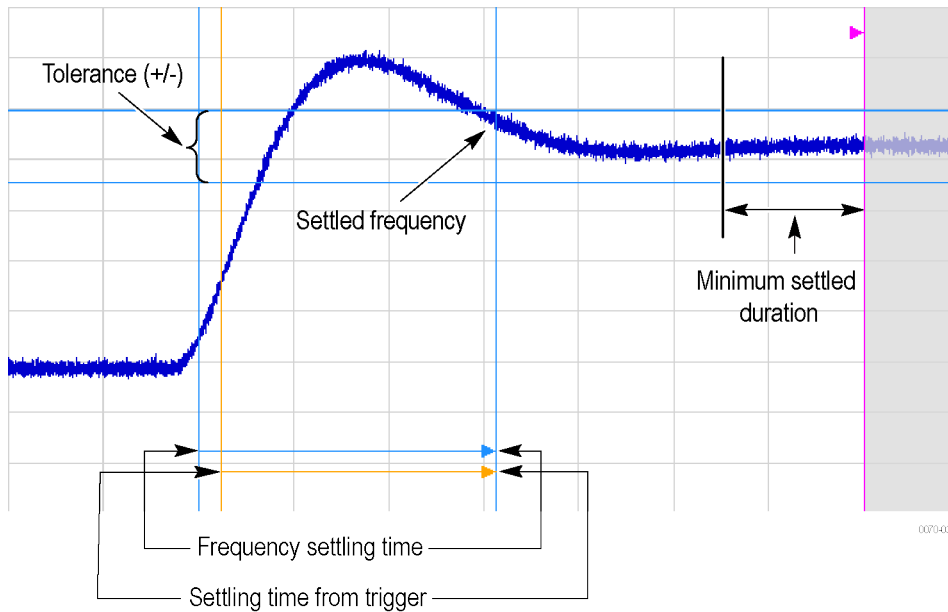

Note: The blue vertical bar that indicates the end of the previous settled state may not always appear. For frequency settling time, this can happen because the starting frequency is outside the measurement bandwidth.

Elements of the Phase Settling Time Graph

The following illustration shows the various indicators that appear in the Phase Settling Time graph. For most phase settling time measurements, there is not a previous settled state within the measurement period, making it impossible to measure the settling time from the previous settled value. However, the settling time from trigger is typically available.

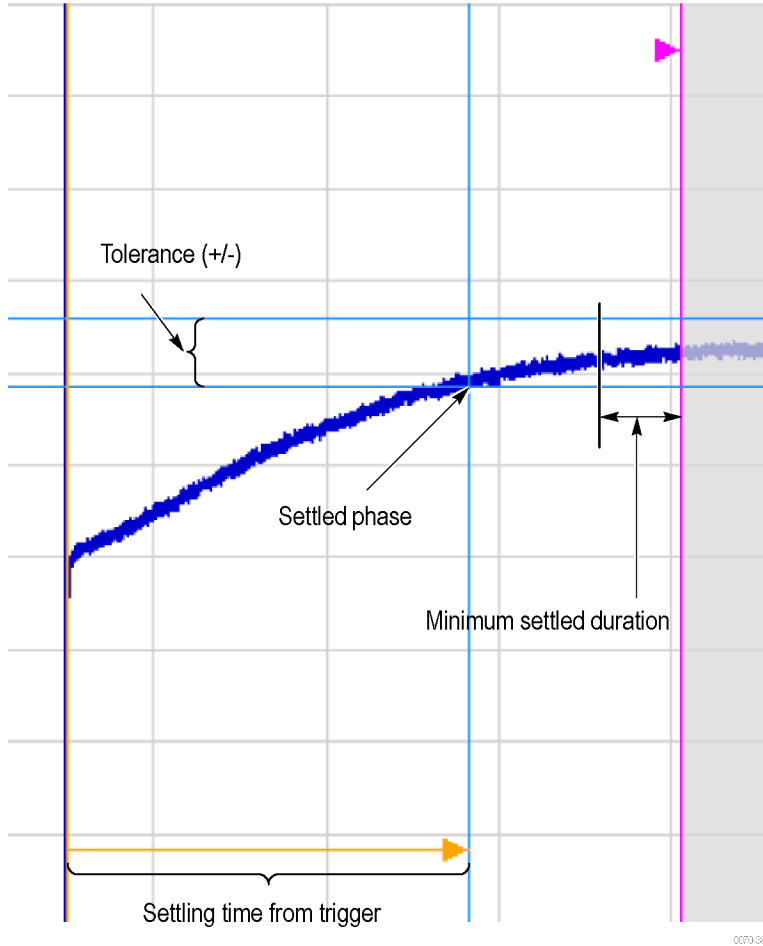

0070-38



Note: The blue vertical bar indicating the measurement start time may not appear. Zero phase is referenced to the measured hop, as the phase will not typically have a settled value during the previous hop.

Measuring Settling Time

1. Select the **Displays** button.
2. Select **RF Measurements** from the **Measurements** box.
3. Double-click the **Freq Settling** icon or **Phase Settling** icon in the Available displays box. Click **OK** to complete your selection.
4. Select **General Signal Viewing** from the **Measurements** box.
5. Double-click the **Time Overview** icon in the Available displays box. Click **OK** to complete your selection.
6. Press the front-panel **Freq** button and use the front-panel keypad or knob to adjust the frequency to that of the signal you want to measure.
7. Select the Trig button.
8. In the Trigger control panel, select Triggered. Configure the trigger settings as needed to achieve a triggered signal.
For the next step in measuring settling time, you must set the starting point of the measurement. To do this, you will use the Time Overview display.
9. Select the Time Overview display.

10. At the left edge of the graph, drag across the graph to adjust the analysis offset. Adjust the Analysis Offset to locate the start of the settling time measurement just ahead of the signal transition where you want to measure the settling time. Any portion of the signal in the gray area will be excluded from the settling time measurement.

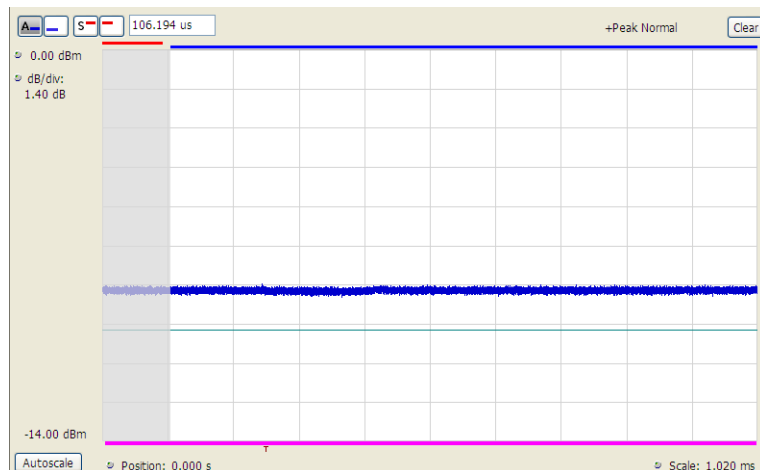

Figure 51: Setting the starting point of the settling time measurement

Even if the signal transition is difficult to see on the Time Overview display, you can set the starting point based on the location of the Trigger indicator below the graph. Or open the Frequency vs. Time graph to see the frequency transition.

11. Click in the Settling Time display to select it.
12. Select the **Settings** button to display the **Settling Time Settings** control panel.
13. On the **Define** tab, adjust the **Meas BW** to improve the signal-to-noise ratio as appropriate. Make sure the bandwidth covers the settled frequency, particularly when the instrument Measurement Frequency is not locked to the spectrum Center Frequency (Analysis control panel > Frequency tab).
14. Set the **Target Reference** on page 216 to Auto or Meas freq as appropriate. If you select Meas freq, also set Offset to fine-tune the measurement frequency if necessary.
15. Set the **Tolerance** as required for your measurement.

If your signal must be settled for a period of time before it is considered settled, you can specify a minimum settled duration for the settling time measurement.

16. Select the Time Params tab. Adjust the **Min Settled Duration** on page 217 as required.

To get the measurement made in the correct location on the signal, you must adjust the measurement length. You do this by dragging the magenta line in the Settling Time graph.

17. Drag the measurement length indicator (magenta line) to the correct location on the signal. Choose a point at which the signal appears to be well settled. The measurement will then find the exact time at which the signal actually settled to within the specified tolerance.

Note the difference in the settling time in the two illustrations that follow. In both examples, the Target reference is set to Auto. The only difference is the measurement length, as shown by the magenta line.

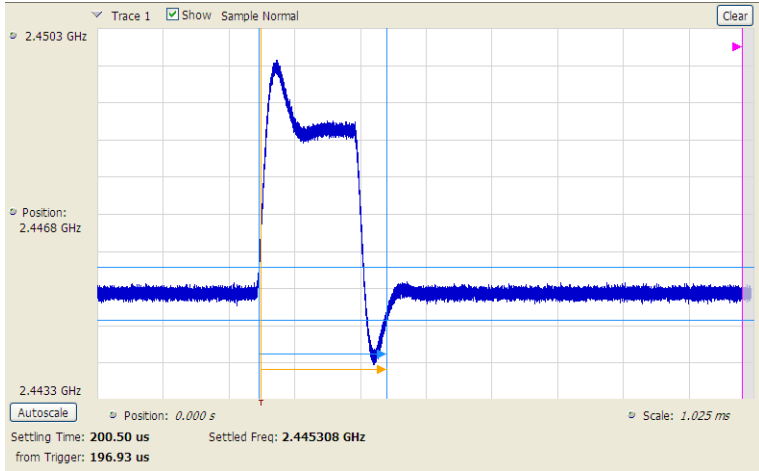

Figure 52: Frequency settling time display before setting the measurement length

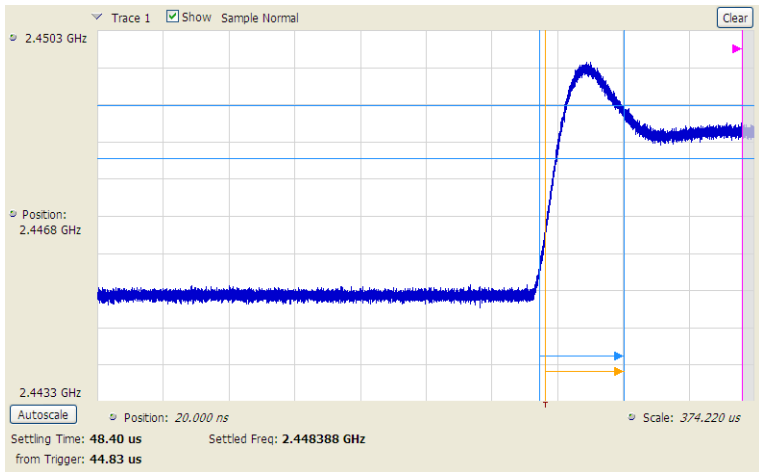

Figure 53: Frequency settling time display after setting the measurement length

Settling Time Settings

Main menu bar: Setup > Settings



The settings for the Frequency and Phase Settling Time displays are shown in the following table.

Settings tab	Description
Define	Sets the measurement parameters that characterize the settling time measurement.
Time Params	Sets measurement end-time and minimum settled duration parameters.
Mask	Enable or disables mask testing and sets the parameters that specify the three zones used for mask testing.

Table continued...

Settings tab	Description
Trace	Specifies trace display characteristics and which traces are displayed.
Scale	Sets vertical and horizontal scale and position parameters.
Prefs	Specifies whether or not to show certain display elements, the maximum number of points in the exported trace, and the displayed precision of the settling time measurement.

Common Controls Settling Time Displays Shared Measurement Settings

The control panel tabs in this section are shared by the Frequency and Phase Settling Time displays. These control panel tabs are not shared with other RF Measurement displays. With few exceptions, each display shares values for each of the controls on these tabs. For example, Vertical Scale values are independent for each of the displays (degrees for Phase Settling Time and Hertz for Frequency Settling Time).

Table 15: Common controls for settling time measurement displays

Settings tab	Description
Define	Specifies the parameters that characterize the settling time measurement.
Time Params	Specifies the Measurement length and minimum settled duration for the settling time measurement.
Mask	Specifies the parameters used for Mask testing.
Trace	Specify which traces to show and how they are computed.
Scale	Specifies the vertical and horizontal scale settings.
Prefs	Specifies display parameters of the Settling Time displays.

Define Tab for Settling Time Displays

The Define tab for the Frequency Settling Time measurement controls several parameters that affect how the measurement is made.

Define | Time Params | Mask | Trace | Scale | Prefs

Meas Freq: 2.44700 GHz Target reference: Auto Offset: 0.0000 Hz

Meas BW: 40.00 MHz Tolerance (+/-): 500.0 kHz
actual: 40.00 MHz

Meas Freq

Select the frequency of the signal to be measured. Measurement Frequency can be selected as the target frequency (see *Target Reference*).



Note: If Lock Center Frequency of Spectrum Display to Measurement Frequency is unchecked, then Measurement Frequency is independent of Center Frequency) Range: Entire input frequency of the instrument

Meas BW

This control limits the bandwidth of the Settling Time measurement. You use the measurement bandwidth setting to improve the signal-to-noise ratio of the measurement, resulting in lower measurement uncertainty. However, if the measurement bandwidth is set too low, resulting in fewer samples per second, it can reduce the number of points within the measurement length below the 256 stable samples required, thus causing the analysis to fail. The measurement bandwidth depends on the oscilloscope on which the recalled file was acquired. To see the effect of measurement bandwidth on measurement uncertainty, see the *RSA6100B Series Specifications and Performance Verification Reference*, Tektronix part number 077-0647-XX. This manual can be downloaded from www.tek.com/manuals.

Target Reference

The target reference is a calculated or user-specified value of final settled frequency within the measurement period. When set to **Auto**, the instrument determines this value by averaging at least the last 256 samples at the end of the measurement period. When set to **Meas freq**, the Target Reference is set to the Measurement Frequency of the instrument. You can enter a manual offset from the target frequency to fine-tune the Target Reference when **Meas freq** is selected.

Tolerance(+/-)

The Tolerance is the frequency or phase range within which the signal must remain to be considered settled. This is set as a \pm value by the user. In the frequency settling time measurement, the tolerance band is centered about the target value. In the phase settling time measurement, the tolerance band is centered about the settled phase value.

The target frequency depends on the Target reference value setting:

- If Target Reference is set to **AUTO**, then the target value is the settled value (the frequency at which the signal is considered settled).
- If Target Reference is set to MeasFreq, then the Target value = **Meas Frequency + Offset**.

Offset

Offset is used for fine-tuning the Target Reference when **Meas freq** is selected. The value for Offset is entered manually.

Time Params Tab for Settling Time Displays

The Time Params tab is used to set the Measurement length and minimum settled duration parameters.

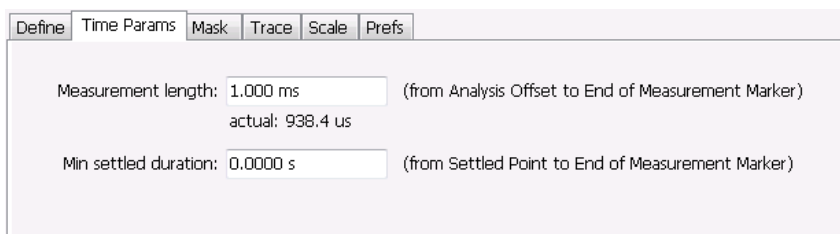

Measurement Length

Measurement length locates the end of the measurement period for settling time. This value is set independently of the analysis period for other measurements in the analyzer. This allows other measurements to display multiple frequency hops during an analysis, while focusing the settling time analysis on a single hop. You can set the measurement length either by entering a value in the entry box, or by dragging the magenta bar to the desired location in the graph. Traces and the display to the right of the measurement time are shown in grey to indicate that this section of the waveform is not being used in the measurement. If your signal does not settle to within your tolerance band, make sure that the measurement time ends during the settled portion of the waveform. The beginning of the settling time measurement is set with the analysis offset control, the same as other measurements in the instrument. Use analysis offset to exclude earlier hops from the measurement. See [Analysis Time](#) for setting the analysis offset control.

If there is more than one phase or frequency hop in the signal to be analyzed, use the Measurement Length control to instruct the analyzer which hop to measure. First, adjust the main Analysis Offset control to a point in time slightly earlier than the transition you wish to measure. Do this in the Time Overview display or the Analysis Settings control panel. Then adjust the Measurement Length so the end of the Settling Time measurement falls within the apparent settled period after the signal transition. The reason it is important for the user to set this control is that the Settling Time measurements start at this point and look backwards in time (towards the signal transition) to find the latest trace point that is not inside the tolerance band.



Note: If your signal does not settle to within your tolerance bands, make sure that the measurement time ends during the settled portion of the waveform.

Min Settled Duration

The minimum settled duration is the amount of time the signal must remain within the tolerance band to be considered settled. Some user specifications require that the signal be settled for a minimum period. If this is not required in your application, set this value to the default of 0 seconds.

Mask Tab for Settling Time Displays

The Mask tab is used to specify the parameters used for Mask testing.

Define	Time Params	Mask	Trace	Scale	Prefs
<input type="checkbox"/> Enable mask test		Mask time reference <input checked="" type="radio"/> Trigger <input type="radio"/> Signal transition	Time Start 1: 0.0000 s Start 2: 100.0 us Start 3: 1.000 ms Stop: 13.18 ms	Limit (+/-) 500.0 kHz 500.0 kHz 500.0 kHz	

Enable Mask Test

Enables or disables mask testing.

Start 1, 2, 3

Sets the starting point for the time zone of interest. If you don't want to use all three zones, set the Start Time for the unneeded zones to a time after the end of the Measurement Length.

Stop

Sets the end point for the final time zone of interest.

Limit (+/-)

Sets the mask violation limits for each time zone.

Mask Time Reference

When mask testing is enabled, the Mask time reference selection specifies the starting point of the mask. You can choose to start the mask test at the trigger point or at the point on the trace where the signal began its transition from its previous settled frequency or phase level to the level you intend to measure.

This capability is useful because some applications do not have a trigger signal available. For those situations where a trigger signal is available, the specification for the device-under-test may require that measurements be referenced to that signal.

Trace Tab for Settling Time Displays

The Traces Tab allows you to set the display characteristics of displayed traces.

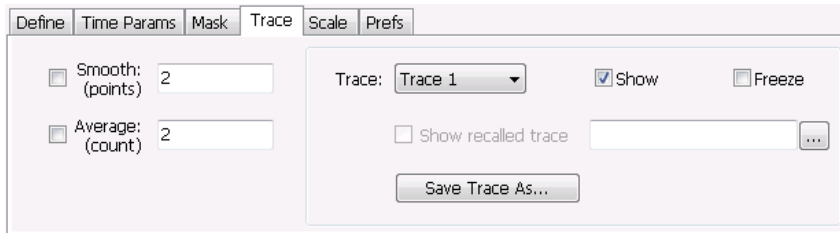

Smooth

Smooth is a low-pass filter function that uses n points in the trace to determine the smoothed value. For example, in the case of n=3, 3 consecutive points are averaged to determine the result of the smoothed output. This is very useful for single-shot signals that contain significant noise where multiple trace averages cannot be used. However, smoothing does have limits, and the user should visually determine whether smoothing is removing noise from the measurement, or if it is affecting the signal. The following illustration shows the effect smoothing has on the displayed trace.

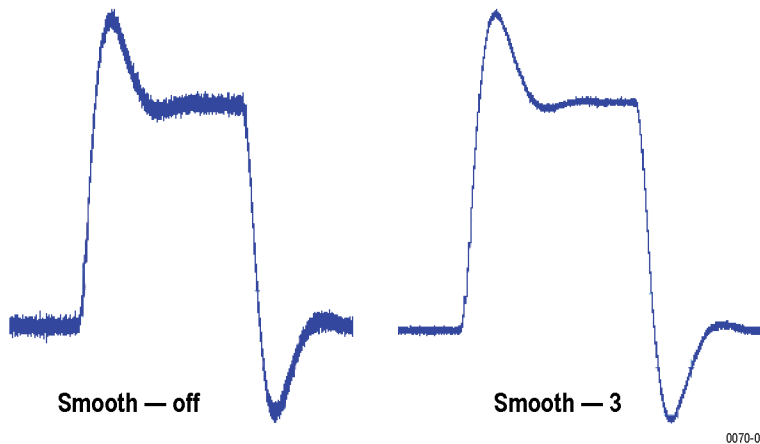

The range for the Smooth function is 2–1000. The setting resolution is 1. arrow keys increment it in steps of 1, 2, 5, 10. When smoothing is enabled, it applies to both traces. Smooth is turned off by default.

Average

This sets the number of acquisitions to be averaged together to produce the result. Averaging reduces random variations but maintains the correct waveshape for repeating signal aberrations. To use averaging, the signal must be repetitive. For example, the tuning direction must always be same for each measurement to be averaged. Signals that vary in tuning direction will tend to average positive-going effects with negative-going effects and the settling time characteristics will cancel out.

The range for the Average function is 2–10000. The setting resolution is 1. Arrow keys increment it in steps of 1, 2, 5, 10. When smoothing is enabled, it applies to both traces. Smooth is turned off by default.

Trace

Selects a trace for display. Choices are Trace 1 and 2. Either trace can be a recalled trace.

Saving Traces

To save a trace for later analysis:

1. Select the **Save Trace As** button. This displays the Save As dialog box.
2. Navigate to the desired folder or use the default.
3. Type a name for the saved trace and click **Save**.

Recalling Traces

You can recall a previously saved trace for analysis or comparison to a live trace.

To select a trace for recall:

1. Select the trace into which the recalled trace will be loaded, from the Trace drop-down list.
2. Check the **Show** check box.
3. Click the ... button to display the Open dialog box.

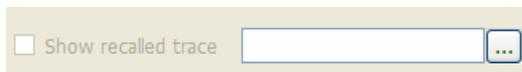

4. Navigate to the desired file and click **Open**.
5. Check the **Show Recalled Trace** check box.
6. Verify that the trace's **Show** check box is selected (either on this tab or next to the drop-down list located at the top-left corner of the graph).

Scale Tab for Settling Time Displays

The Scale tab allows you to change the vertical and horizontal scale settings. Changing the scale settings changes how the trace appears on the display but does not change control settings such as Measurement Frequency. In effect, these controls operate like pan and zoom controls.

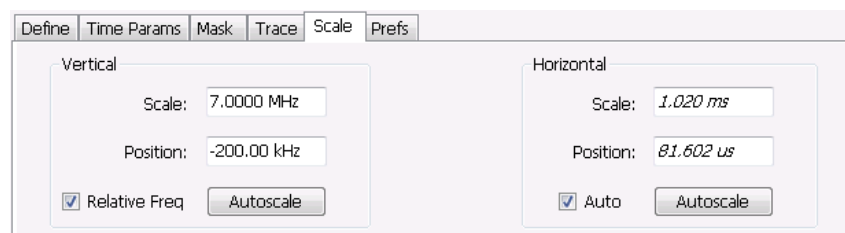

Setting	Description
Vertical	
Scale	Changes the vertical scale or span of the graph.
Position	Sets the frequency (or phase) at the vertical center of the graph.
Relative Freq	Sets the vertical (position) display readouts to show frequency values relative to the center frequency or as absolute values.
Autoscale	Resets the Scale and Position to center the trace in the graph.
Horizontal	
Scale	Sets the range of time shown in the graph.
Position	Allows you to pan the graph left and right.
Autoscale	Resets Scale and Position to the automatically determined settings.

Prefs Tab for Settling Time Displays

The Prefs tab allows you to change display parameters of the Settling Time displays.

The following table explains the controls that can appear on the Prefs tab.

Setting	Description
Max trace points	Sets the number of trace points used for marker measurements and for results export.
Show graticule	Select to display or hide the graticule.
Show Marker readout in graph (selected marker)	Shows or hides the readout for the selected marker in the graph area.
Settling Time decimal places	Specifies the precision of the settling time measurement readout that appears below the graph. This setting does not affect the precision of internal calculations.

SEM Display

The SEM (Spectrum Emission Mask) display measures out-of-band emissions immediately outside the channel bandwidth that result from the modulation process and non-linearity in the transmitter. The Spectrum Emission Mask display allows you to define up to six pair of masks, or offsets, that specify the limits for out-of-band emissions and performs a pass/fail tests of the signal against the defined offsets and limits.

To show the Spectrum Emission Mask display:

1. Recall an appropriate acquisition data file.
2. Select **Displays** or select **Setup > Displays**.
3. In the **Select Displays** dialog, select **RF Measurements** or **WLAN Analysis** in the Measurements box.
4. In the Available displays box, double-click the **SEM** icon or select the icon and click **Add**. The SEM icon will appear in the Selected displays box and will no longer appear under Available displays.
5. Click **OK** to show the Spectrum Emission Mask display.
6. Press the **Replay** button to take measurements on the recalled acquisition data file.

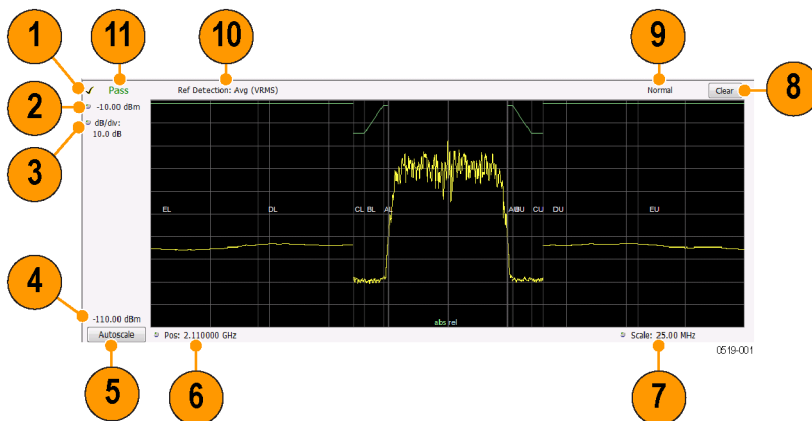

Elements of the Display

Item	Display element	Description
1	Check mark indicator	Indicates the display for which the acquisition hardware is optimized. <div style="display: flex; align-items: center;"> <p>Note: When <i>Best for multiple windows</i> is selected in the Amplitude control panel's RF & IF Optimization control, none of the measurement displays shows a checkmark, as there is not a single optimized measurement.</p> </div>
2	Top-of-graph setting	Sets the level that appears at the top of the graph.
(not shown)	Units	Sets the global amplitude units for all the views in the analysis window. This will change the amplitude selection in the Units tab of the Amplitude control panel.
3	dB/div	Sets the vertical scale value. The maximum value is 20.00 dB/division.
4	Bottom-of-graph readout	Indicates the amplitude at the bottom of the graph. This value changes with the dB/div and Vertical Position settings.

Table continued...

Item	Display element	Description
5	Autoscale	Properly offsets the peak of the display from the top of the screen. If the screen has been enlarged through a manual vertical (dB/div) setting entry, the view is not vertically rescaled when Autoscale is used.
6	CF / Pos	Default function is CF - center frequency (equivalent to the Measurement Freq setting). If Horizontal scaling has been manually adjusted in Setup > Settings > Scale, then Pos replaces CF as the setting at the bottom-left corner of the screen. Adjusting Pos shifts the trace left or right in the graph, but does not change the measurement frequency.
7	Span / Scale	Default function is Span - frequency difference between the left edge of the display and the right edge. If Horizontal scaling has been manually adjusted in Settings > Scale, then Scale will replace Span as the setting at the bottom-right corner of the screen.
8	Clear	Erases the current results from the display.
9	Function readout	Readout of the Function selection for the Reference channel (Setup > Processing > Function). Spurious
10	Detection readout	Readout of the Detection selection for the Reference channel (Setup > Processing > Detection).
11	Pass / Fail readout	Readout indicating whether any part of the trace has exceeded the any of the limits defined in the Offsets & Limits table (Setup > Settings > Offsets & Limits Table).

Pass / Fail Readout

This readout displays either **Pass** or **Fail XX%**. When the signal exceeds the mask in any offset, it is considered a mask violation, and results in **Fail XX%** being displayed. If there are no mask violations, **Pass** is displayed.

How the fail percentage is determined. Each offset has two sides, one lower and one upper. For example, Offset A has two sides: AL (lower side) and AU (upper side). In the SEM display, there is a maximum of six offsets (A-F) and each offset can have a maximum of two sides (if Both is selected for Side in the Offsets & Limits table). This results in a total of six offsets multiplied by two sides per offset, which results in 12 offsets. Mask violations can occur in any of these offsets. The failure percentage is calculated as follows:

$$\text{Fail percentage} = \text{Number of offsets with mask violations} \times 100 / \text{Total number of enabled offsets}$$

For example: Assume there are three enabled offsets: A, B, C, and all these offsets have both lower and upper sides. Thus, the total number of enabled offsets is equal to six. Suppose there are mask violations in the offsets AL and CU, then the number of offsets having mask violations is equal to 2. Therefore, Fail percentage = $2 \times 100 / 6 = 33\%$.

Results Display

The Results Display shows the measurement results for the SEM display.

Row	Offset	Start Freq	Stop Freq	Peak Abs (dBm)	Margin Abs (dB)	Peak Rel (dB)	Margin Rel (dB)	@Freq	Integ Abs (dBm)
1	EL	-12.500 MHz	-8.000 MHz	-73.83	-62.33	-91.81	--	-8.010000 MHz	-68.44
2	DL	-8.000 MHz	-4.000 MHz	-73.17	-61.67	-91.16	--	-7.460000 MHz	-67.61
3	CL	-4.000 MHz	-3.515 MHz	-87.63	-63.13	-105.62	--	-3.965444 MHz	-77.11
4	BL	-3.515 MHz	-2.715 MHz	-87.77	-75.17	-105.76	--	-2.722000 MHz	-75.14
5	AL	-2.715 MHz	-2.515 MHz	-70.18	-57.68	-88.16	--	-2.515000 MHz	-70.74
6	AU	2.515 MHz	2.715 MHz	-70.73	-58.23	-87.67	--	2.515000 MHz	-70.54
7	BU	2.715 MHz	3.515 MHz	-87.66	-67.24	-104.59	--	3.243000 MHz	-74.72
8	CU	3.515 MHz	4.000 MHz	-88.01	-63.51	-106	--	3.976356 MHz	-77.04

Readout	Description
Ref:	A two-part readout to the left of the table that displays information about the Reference Channel. The first part of the readout displays the Measurement Type selected on the Parameters tab. The second part of the readout displays the measurement result for the Reference channel.
Row	A sequence number for ordering the offsets. Click to organize by row number, resort rows from high to low or low to high.
Offset	The Offset name. A combination of the offset (A-F) and the location (U for upper and L for Lower).
Start Freq	The start frequency of the offset (relative to the Measurement Freq).
Stop Freq	The stop frequency of the offset (relative to the Measurement Freq).
Peak Abs	Absolute power peak power at worst case margin of the offset
Margin Abs	The worst case difference between the trace and the absolute limit line. Note that an offset can have different start and stop levels, thus, the margin can vary if the offset start and stop levels are different.
Peak Rel	Relative peak power of worst case margin of the offset. Relative with respect to the reference power level.
Margin Rel	The worst-case difference between the trace and the relative limit line. Because an offset can have different start and stop levels, the margin can vary if the offset start and stop levels are different.
@Freq	The frequency at which the worst margin occurs.
Integ Abs	The absolute integrated power of the offset.
Integ Rel	The relative integrated power of the offset (with respect to the reference power).

Reordering results in the results table. You can sort the results in the Results table by clicking the column heading containing the values you want to sort on. You can sort results for the following columns: Row, Offset, Start Frequency, Stop Frequency, Peak Abs, and Peak Rel.

Rearranging columns in the results table. You can rearrange the order of the columns and their size. To rearrange columns, select the column heading you want to move and drag it to the new position; the new location is indicated by a dark blue bar that appears between column headings.

You can resize the columns by selecting the divider between columns and dragging it to a new position.

Spectrum Emission Mask Settings

Main menu bar: Setup > Settings

Favorites toolbar: 

The settings for the Spectrum Emission Mask display are visible when SEM is the selected display. To display the SEM Settings, select Setup > Settings.

Settings tab	Description
Parameters Tab	Specifies several characteristics that control how the measurement is made.
Processing Tab	Specifies settings for detection on the Reference channel and the offsets. Specifies the function setting.
Ref Channel Tab	Specifies how the measurements on the reference channel are performed.
Offsets & Limits Table	Specifies characteristics of offsets and mask limits.
Scale Tab	Specifies the vertical and horizontal scale settings.
Prefs Tab	Specifies the appearance features of the graph area and the maximum trace points.
Standards Presets button	Click this button to access the Standards Presets options dialog window. You can select the standard and bandwidth to apply to the standard you select. Click on the link to the left for information about standards presets.

Parameters Tab - SEM

The Parameters tab specifies several characteristics that control how the Spectrum Emission Mask measurements are made.

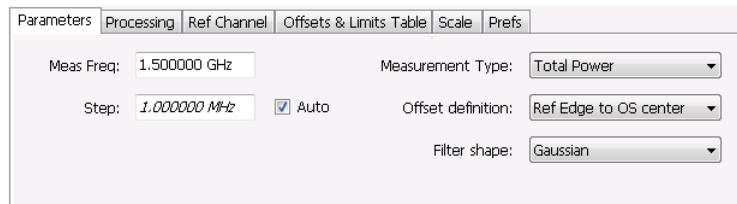

Setting	Description
Meas Freq	Specify the frequency of the signal to be measured.
Step	Sets the increment size when changing the Frequency using the knob or mouse wheel.
Auto	When Auto is enabled, the step size is adjusted automatically based on the span setting.
Real-Time	When Real-Time mode is enabled, the entire SEM span is measured using a real-time/contiguous acquisition. Not all described parameters are available in Real-Time mode.

Table continued...

Setting	Description
Measure Noise floor (Only available when SignalVu-PC is connected to an MDO4000B/C instrument.)	Takes preliminary acquisitions to measure the instrument noise floor. This initiates a noise correction. A noise correction signal is created by switching off the RF input to the MDO4000B/C and performing acquisitions of the instrument's internal noise. Fifty acquisitions are averaged to create the noise reference signal. The noise reference signal is measured for the Reference channel and each Offset is defined by the measurement settings.
Apply noise correction (Only available when SignalVu-PC is connected to an MDO4000B/C instrument.)	<p>This item is enabled and the check box automatically checked after the noise reference signal is taken when the Measure Noise floor button is clicked. This initiates noise reference subtraction from the incoming signal power for each region to create the corrected result. All calculations are performed in Watts and then converted to the desired units.</p> <p>The amount of noise correction is limited to 20 dB to avoid the possibility of a negative power measurement. This is a rare condition that could occur if the subtraction of the reference power from the channel power results in a negative value (or "infinite" dBm). The noise reference for a region is subtracted from each trace point in the channel, rather than offsetting the entire region by a single amount. This produces a smooth trace with no discontinuities at the region edges.</p> <p>Note: If any relevant settings (such as reference level, frequency, span, RBW) are changed once the noise reference is measured, the following warning message will be displayed to notify you that Noise Correction was not applied:</p> <p> Noise correction not applied - select Measure Noise Floor for new noise correction.</p>
Measurement Type	Specifies the type of measurement for the reference channel; used as a reference for the offsets.
Total Power	Sets the reference to the integrated power of the reference channel within the reference's integration bandwidth.
PSD	Sets the reference to the mean of the power spectral density (dBm/Hz) of the reference channel. The trace and the absolute and relative limits line are also in dBm/Hz
Peak	Sets the reference to the Peak power of the reference channel.
Offset definition	Defines the relative position of the start/stop frequency of an offset. Choose the offset definition based on the standard.
Ref center to OS center	Specifies that the start/stop frequencies are defined from the center frequency of the reference channel to the center of the filter BW.
Ref center to OS edge	Specifies that the start/stop frequencies are defined from the center frequency of the reference channel to the center of the (inner) edge of the filter BW of the offset.
Ref Edge to OS center	Specifies that the start/stop frequencies are defined from the edge of the reference channel to the center of the filter BW of the offset.
Ref Edge to OS edge	Specifies that the start/stop frequencies are defined from the edge of the reference channel to the (inner) edge of the filter BW of the offset.

Table continued...

Setting	Description
Filter Shape	Specifies the shape of the filter determined by the window that is applied to the data record, in the spectrum analysis, to reduce spectral leakage. 3GPP specifies a Gaussian window shape be applied to the reference channel measurements.
Gaussian	This filter shape provides optimal localization in the frequency domain.
Rectangular	This filter shape provides the best frequency, worst magnitude resolution. This is essentially the same as no window.

Processing Tab - SEM

The Processing tab controls the Detection settings for the Reference Channel and Offsets, as well as selecting the Function.

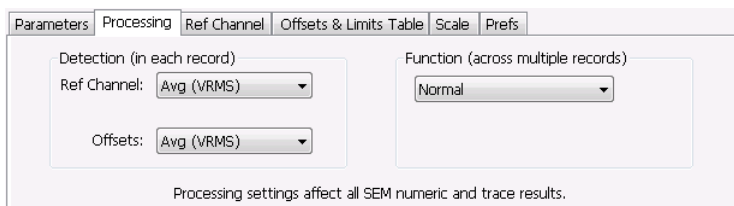

Settings tab	Description
Detection (in each sweep)	
Ref Channel	Specifies the Detection method used for the Reference Channel. Detection is used to produce the desired measurement result (peak or average) and to reduce the results of a measurement to the desired number of trace points.
Avg (VRMS)	For each sweep, each point of the trace is the result of determining the RMS voltage value for the last 'n counts' of the collected traces for the same point. When 'n count' has not been reached, partial averaging results are displayed.
+Peak	Selects the +Peak detection method. With this method, the highest value is selected from the results to be compressed into a trace point.
Offsets	
Avg (VRMS)	Selects the Average Vrms detection method. With this method, each point on the trace in each offset is the result of determining the RMS Voltage value for all of the results values it includes.
+Peak	Selects the +Peak detection method. With this method, the highest value in each offset is selected from the results to be compressed into a trace point.
Function (across multiple sweeps)	
Function	Selects the trace processing method. Available settings are: Normal, Avg (VRMS), and Hold.

Table continued...

Settings tab	Description
Normal	When a new trace has been computed, it replaces the previous trace.
Max Hold	With each sweep, each trace point in the new trace is compared to the point's value in the old trace and the greater value is retained for display and subsequent comparisons.
Avg (VRMS)	For each sweep, each point on the trace is the result of determining the RMS Voltage value for all of the collected traces' values for the same point.

Ref Channel Tab

The Ref Channel tab controls how the measurement of the Reference channel is performed.

Settings tab	Description
Power Reference	The value used to calculate relative measurements.
Auto	When Auto is unchecked, you can enter a value for the reference power, and the measured reference power is not used or displayed
RBW	Sets the RBW for the Reference Channel.
VBW	Enables/disables the Video Bandwidth filter. VBW is used in traditional swept analyzers to reduce the effect of noise on the displayed signal. The VBW algorithm in the analyzer emulates the VBW filters of traditional swept analyzers. When the checkbox next to VBW is not checked, the VBW filter is not applied. SEM standards specify what value of VBW should be applied, if any.
Channel width	Specifies the width of the reference channel.
Integration BW	Specifies the integration bandwidth used to compute the total power in the reference channel.
Channel Filter	Specifies the measurement filter used in the Reference Channel. Choices are None and Root-raised Cosine.
Filter param	Specifies the alpha value (or roll-off factor) of the Root-raised cosine filter. Present only when Channel Filter is set to Root-raised Cosine.
Chip rate	Specifies the chip rate used for the Root-raised Cosine filter. Present only when Channel Filter is set to Root-raised Cosine.

Offsets & Limits Table Tab - SEM

The Offsets & Limits Table tab is used to specify parameters that define Offsets and masks.



Figure 54: Expanded display of Offsets & Limits Table

Setting	Description
Buttons	
Expand	Displays the Offsets & Limits Table in a new, resizable window.
Reset Layout	You can reorder columns in the Offsets & Limits Table by dragging the columns to a new position. Clicking Reset Layout returns the column order to the factory default order.
Load	Click to load a saved Offsets & Limits table from a file.
Save As	Click to save the current Offsets & Limits table to a file.
Done	When the table is expanded, click Done when you have finished editing the table to save your changes and close the expanded table display.
Table columns	
On	Specifies whether or not measurements are taken in the specified offset.
Start (Hz)	Start Frequency of the selected offset.
Stop (Hz)	Stop Frequency of the selected offset.
Side	Specifies whether the specified range appears on both side of the carrier frequency or just one side (left or right).
RBW (Hz)	Specifies the RBW for the selected range.
n (RBWS)	An integer value that specifies how many times to multiply the RBW to set the Filter bandwidth.
Filter BW (n x RBW)	Displays the Filter BW. Filter BW is the equivalent BW of each point in the offset. When n > 1, an integration technique is used to achieve the Filter BW using narrower RBWs. For most SEM measurements, this value is set to 1. The 3GPP standard suggests n greater than 1.
VBW (Hz)	Adjusts the VBW (Video Bandwidth) value. VBW Maximum: RBW current value; VBW Minimum: 1/10,000 RBW setting.
Table continued...	

Setting	Description
VBW On	Specifies whether the VBW filter is applied.
Mask	Select the type of limits used for Pass/Fail testing. Signal excursions that exceed the mask settings are considered violations. The available choices are shown below.
Abs Start (dBm)	Specifies the mask level at the inner edge of the selected offset.
Abs Stop (dBm)	Specifies the mask level at the outer edge of the selected offset.
Abs Same	Specifies whether the value for the inner and outer edges of the offset must be the same value. When enabled, the Abs Stop cell is grayed-out and set to the value of the Abs Start cell.
Rel Start (dBm)	Specifies the mask level for the Relative mask at the inner edge of the selected offset.
Rel Stop (dBm)	Specifies the mask level for the Relative mask at the outer edge of the selected offset.
Rel Same	Specifies whether the inner and outer edges of the offset must be the same value. When enabled, the Rel Stop cell is grayed-out and its value is set to the value of the Rel Start cell.

Scale Tab - SEM

Use the Scale tab to change the vertical and horizontal scale settings. Changing the scale settings changes how the trace appears on the display. In effect, these controls operate like pan and zoom controls.

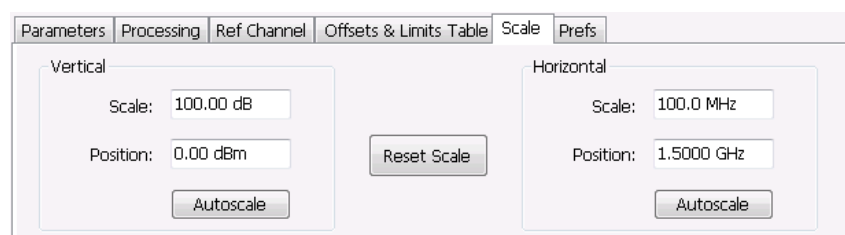

Setting	Description
Vertical	Controls the vertical position and scale of the trace display.
Scale	Changes the vertical scale units.
Position	Adjusts the reference level away from top of the graph.
Autoscale	Resets the scale of the vertical axis to contain the complete trace.
Horizontal	Controls the span of the trace display and position of the trace.
Scale	Specifies the frequency range displayed in the graph

Table continued...

Setting	Description
Position	Specifies the frequency shown at the center of the graph.
Autoscale	Resets the scale of the horizontal axis to optimize the display of the trace.
Reset Scale	Resets all settings to their default values.

Prefs Tab - SEM

The Prefs tab enables you to change parameters of the measurement display. The parameters available on the Prefs tab vary depending on the selected display, but include such items as enabling/disabling Marker Readout and switching the Graticule display on/off. Some parameters appear with most displays while others appear with only one display.

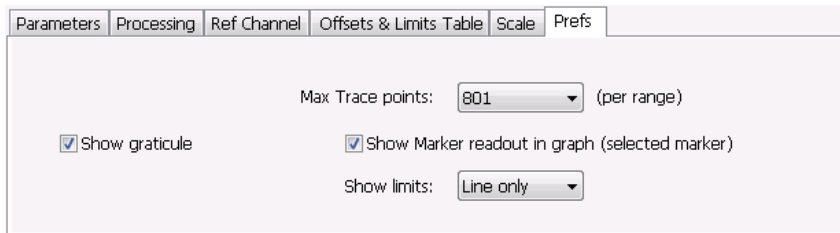

Setting	Description
Show graticule	Controls the vertical position and scale of the trace display.
Max Trace points (per range)	When the spectrum analysis produces more than the selected maximum number of points, the method specified in Detection control is used to decimate the result. This setting applies to both the Reference channel and offsets.
Show Marker readout in graph	Adjusts the reference level away from top of the graph.
Show limits	Controls the appearance of mask limits in the graph.
Shaded	Shows limits using a shaded area. Green shading is used to identify Absolute limits. Blue shading is used to indicate Relative limits.
Line only	Shows limits using only a line. A green line is used to identify Absolute limits. A blue line is used to indicate Relative limits.
None	No lines or shading are used to indicate limits in the graph. Violations of the mask are still identified by red shading.

Common Controls RF Measurements Shared Measurement Settings

The control panel tabs in this section are shared by multiple displays in the RF Measurement folder (Setup > Displays). With few exceptions, each display maintains separate values for each of the controls on these tabs. For example, Scale values are independent for each of the displays.

Table 16: Common controls for RF measurement displays

Settings tab	Description
Freq & RBW	Allows you to specify the Center Frequency, Step size and RBW.
Traces	Specifies trace parameters such as detection method and whether smoothing is enabled. Traces can also be saved and loaded for reference from this tab.
Scale	Specify vertical and horizontal scale settings.
Prefs	Specify appearance features of the graph area.

Freq & RBW Tab

The Freq & RBW tab specifies frequency parameters for some of the RF Measurements displays.

Setting	Description
Meas Freq	Specifies the measurement frequency.
Step	The Step control sets the increment/decrement size for the adjustment of the center frequency. If Auto is enabled, the analyzer will adjust the Step size as required.
RBW	Select Auto or Manual. Adjusts the RBW for the entire measurement. This setting is Independent of the Spectrum view's RBW setting.
VBW	Adjusts the VBW (Video Bandwidth) value.



Note: While the measurement frequency and step settings on this control tab are shared between ACPR, MCPR and Occupied Bandwidth, the RBW setting is not shared. The RBW setting is unique for each measurement.

VBW

The VBW setting enables/disables the Video Bandwidth filter. VBW is used in traditional swept analyzers to reduce the effect of noise on the displayed signal. The VBW algorithm in the analyzer emulates the VBW filters of traditional swept analyzers.

The maximum VBW value is 10 times the current RBW setting. The minimum VBW value is 1/10,000 of the RBW setting.

Traces Tab

The Traces tab enables you to select traces for display. You can choose to display live traces and/or recalled traces. The [Trace tab](#) for Settling Time displays is described in the Settling Time controls section.



Note: Not all RF Measurements support multiple traces and/or save and recall of traces.

Parameters Reference Ranges and Limits **Traces** Scale Prefs

Trace: Show Freeze

Function: Count Show recalled trace

Setting	Description
Trace	Selects a trace for display. CCDF display: Choices are Trace 1, 2, and Gaussian. Trace 1 and 2 can be recalled. Spurious display: Choices are Trace 1, 2, 3, 4, and Math trace. All traces can be recalled. Math trace is computed for all ranges.
Show	Shows / hides the selected trace.
Freeze	Halts updates to the selected trace.
Save Trace As	Saves the selected trace to a file for later recall and analysis.
Show recalled trace	Used to select a saved trace for display. When a trace is recalled, controls such as show, freeze, and function will be disabled.
Function	Selects the trace processing method (Spurious display only). Possible settings are: Normal, Average (VRMS), Avg (of logs), and Max Hold.
Smooth: (points)	Available for Phase and Frequency Settling Time displays only.
Average: (count)	Smooth is a low-pass filter function that uses n points in the trace to determine the smoothed value. Average sets the number of acquisitions to be averaged together to produce the result. See Trace Tab for Settling Time Displays on page 218 for complete details.

Detection

Trace Detection occurs when the trace is being decimated by the measurement. For example, if the maximum number of trace points is 100,000, and the selected analysis region is 200,000 samples, the measurement must decimate the 200,000 resulting trace points by 2 to prevent exceeding the 100,000 trace point limit. Since only one value can be selected for each trace point, an algorithm must be used to select (detect) the appropriate value to use.

The IQ samples in a data acquisition can be detected in a variety of ways. The number of IQ samples available to each trace point varies with both analysis length and trace length. For example, with Spectrum Length set to 'Auto' in the Analysis menu, the instrument analyzes just enough samples to produce one IQ sample pair per trace point. In this case, the detection method chosen has very little effect, as the

+Peak, -Peak, Avg (VRMS) and Sample values are all equal. Changing the Spectrum Length causes the available detection methods to differ in value because they have a larger set of samples for the various detection methods to process.

The available detection methods (depending on the display) are:

- **+/-Peak** – Selects the highest and lowest values of all the samples contained in an acquisition interval.
- **Avg (VRMS)** [Average V_{RMS}] – Each point on the trace is the result of determining the RMS Voltage value for all of the IQ samples available to the trace point. When displayed in either linear (Volts, Watts) or Log (dB, dBm), the correct RMS value results. When the averaging function is applied to a trace, the averaging is performed on the linear (Voltage) values, resulting in the correct average for RMS values.

Trace processing (Function)

The trace can be processed to display in different ways. The Function setting controls trace processing.

- **Max Hold** - Displays the maximum value in the trace record for each display point. Each new trace display point is compared to the previous maximum value and the greater value is retained for display and subsequent comparisons.
- **Normal** - Displays the trace record for each display point without additional processing.
- **Avg (VRMS)** [Average V_{RMS}] – Multiple traces are averaged together to generate the displayed trace, which will contain just one vertical value for each underlying frequency data point. Once the specified number of traces have been acquired and averaged to generate the displayed trace, additional traces contribute to the running average, except in Single Sequence run mode. In the case of Single Sequence, the instrument stops running after the specified number of traces have been averaged together. The Number of Traces setting specifies how many traces are averaged. The averaging is performed on the linear (Voltage) values, resulting in the correct RMS average).
- **Avg (of logs)** – This is a trace function used to emulate legacy spectrum analyzer results and for the specification of displayed average noise level. In older swept analyzers, a voltage envelope detector is used in the process of measuring signal level, and the result is then converted to Watts and then to dBm. Averaging is then applied to the resultant traces.

For CW signals, this method results in an accurate power measurement. However, with random noise and digitally modulated carriers, errors result from this 'average of logs' method. For random noise, the average of logs methods results in power levels -2.51 dB lower than that measured with a power meter, or with a spectrum analyzer that measures the rms value of a signal, and performs averaging on the calculated power in Watts and not dBm or other log-power units.

This detector should be used when following a measurement procedure that specifies it, or when checking the Displayed Averaged Noise Level (DANL) of the instrument. The 'average of logs' detection and trace function is used for DANL specification to provide similar results to other spectrum/signal analyzers for comparison purposes. Use of the Average of Logs method of measurement is not recommended for digitally modulated carriers, as power measurement errors will occur.



Note: The Detection setting does not affect the trace until the spectrum length is longer than the Auto setting.

Saving Traces

To save a trace for later analysis:

1. Select the **Save Trace As** button. This displays the Save As dialog box.
2. Navigate to the desired folder or use the default.
3. Type a name for the saved trace and click **Save**.

Recalling Traces

You can recall a previously saved trace for analysis or comparison to a live trace.

To select a trace for recall:

1. Select the trace into which the recalled trace will be loaded, from the Trace drop-down list.
2. Check the **Show** check box.

3. Click the ... button to display the Open dialog box.

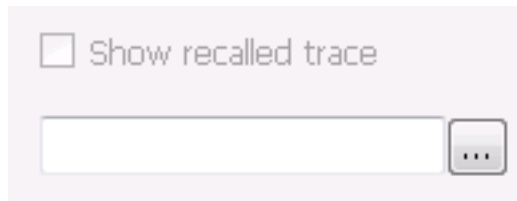

1. Navigate to the desired file and click **Open**.
2. Check the **Show Recalled Trace** check box.
3. Verify that the trace's **Show** check box is selected (either on this tab or next to the drop-down list located at the top-left corner of the graph).

Gaussian Trace (applies only to CCDF)

The Gaussian trace is a reference trace that you can compare your trace against. Because the Gaussian trace is for reference, there are no settings for the trace other than whether or not it is shown.

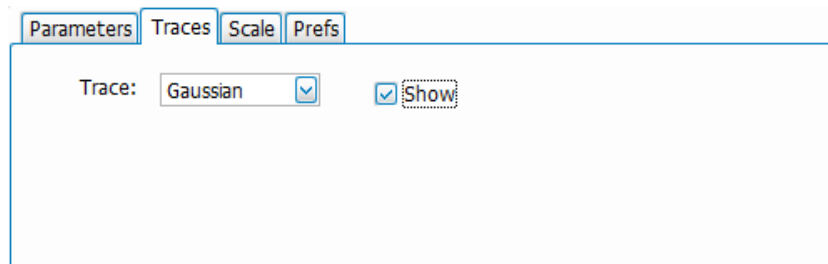

Scale Tab

The Scale tab allows you to change the vertical and horizontal scale settings. Changing the scale settings changes how the trace appears on the display but does not change control settings such as Center Frequency. Parameters on this tab may vary depending on the selected display.

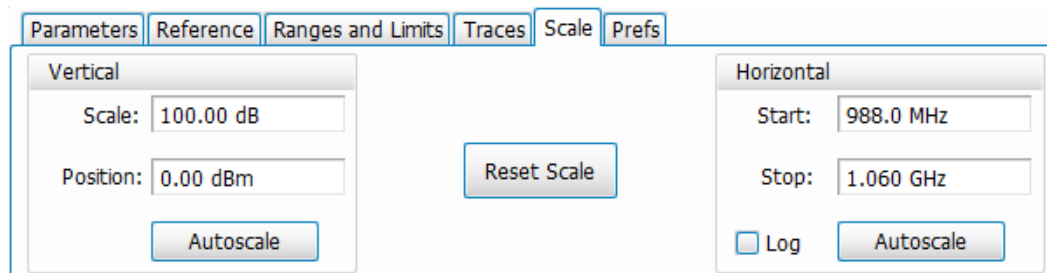

Setting	Description
Vertical	Controls the vertical position and scale of the trace display.
Scale	Changes the vertical scale units. This is only accessible when the vertical units are set to dBm.
Position	Adjusts the level shown at the center of the graph.

Table continued...

Setting	Description
Autoscale	Resets the scale of the vertical axis to contain the complete trace.
Rest Scale	Resets all settings to their default values.
Horizontal	Controls the span of the trace display and position of the trace.
Scale (Start)	Allows you to, in effect, change the span.
Position (Stop)	Adjusts the position of the acquisition record shown at the left edge of the graph.
Autoscale	Resets the scale of the horizontal axis to contain the complete trace.
Log (Spurious only)	Resets the display to show the frequency axis in a logarithmic scale.

Prefs Tab

The Prefs tab enables you to change parameters of the measurement display. The parameters available on the Prefs tab vary depending on the selected display, but include such items as enabling/disabling Marker Readout and switching the Graticule display on/off. Some parameters appear with most displays while others appear with only one display.

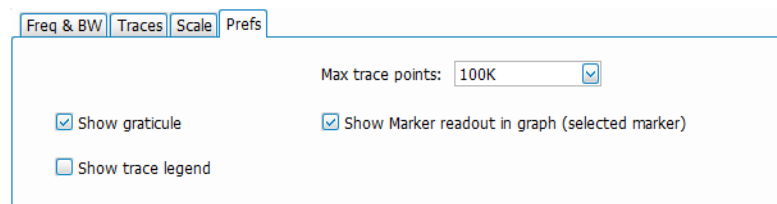

Setting	Description
Show graticule	Shows or hides the graticule.
Show Marker readout in graph (selected marker)	Shows or hides the readout for the selected marker in the graph area.
Max trace points	In general, time-domain traces can include up to 100K points and frequency-domain traces can include up to 10K points. When the analysis produces a results array longer than the selected trace length, the trace is decimated (using the method specified with the Detection control) to be equal to or less than the Max trace points setting (except when Max trace points is set to Never Decimate). This decimated (or undecimated) trace is what is used for marker measurements and for results export.
Settling Time decimal places (Frequency and Phase Settling Time displays only)	Specifies the number of decimal places shown in the results readout below the graph. This setting does not affect the precision of internal calculations.

Table continued...

Setting	Description
Show trace legend (CCDF (Complementary Cumulative Distribution Function) display only)	Displays or hides the trace legend.

Tracking Generator

Overview

The tracking generator feature (Option 04) enables the Transmission Gain measurement and allows you to use the internal signal generator to measure the gain and response of filters, amplifiers, attenuators, and other such devices. The Transmission Gain display shows the frequency on the horizontal axis and the gain or loss on the vertical axis. You may also use this display to tune responses to needed specifications. When used for gain and loss, the tracking generator trace can be normalized using the calibrate function. You may select important operating parameters, including number of measurement points, output power, and measurement resolution bandwidth. Transmission gain measurements are not supported above 7.5 GHz.

The [Return Loss](#) measurements (Option SV60-SVPC) provide return loss, VSWR, cable loss, and distance to fault (DTF) measurements. The Return Loss option requires the tracking generator option (Option 04). These measurements use a vector calibration, which requires the use of an open, short, and load calibration kit. Calibration kits are available from Tektronix, or you can use your own.



Note: Options 04 and SV60-SVPC are not available for the RSA7100 or RSA306B.



Tip: See the [Features by product](#) topic for more information about which features are available with which connected analyzers.

How to use the Transmission Gain display

Perform the following procedures in the order presented to perform a transmission gain measurement.

Access the Settings panel

1. Select Setup > Displays.
2. In the Measurements panel, select Tracking Generator.
3. Double click the Transmission Gain icon in the Available displays panel to select that display.
4. Click **OK**.
5. Click  on the Favorites bar to open the Transmission Gain Settings panel.

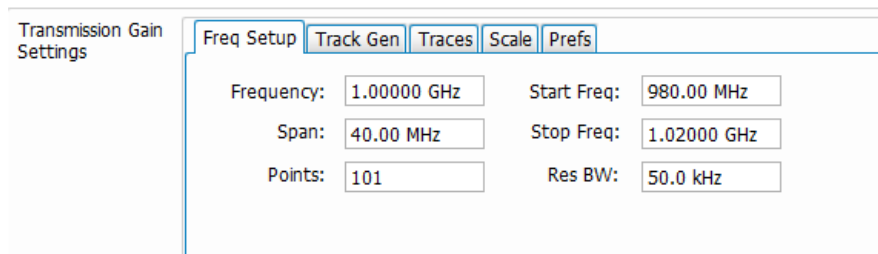

Transmission Gain Settings			
Frequency:	1.00000 GHz	Start Freq:	980.00 MHz
Span:	40.00 MHz	Stop Freq:	1.02000 GHz
Points:	101	Res BW:	50.0 kHz

Set parameters before running normalization

1. Connect your test setup without the DUT (filter) to the RF Out and RF In connectors.
2. Set the Start and Stop frequencies and the RBW in the Freq Setup tab of the Settings panel.
Entering the Start and Stop frequencies sets the measurement span.
3. If desired, select how you want the display to appear in the Prefs tab.

Run a normalization

1. Click the **Normalize** button on the Transmission Gain Settings panel. The following dialog will appear. The first column shows the conditions of the most recent normalization. The second column shows the current settings.

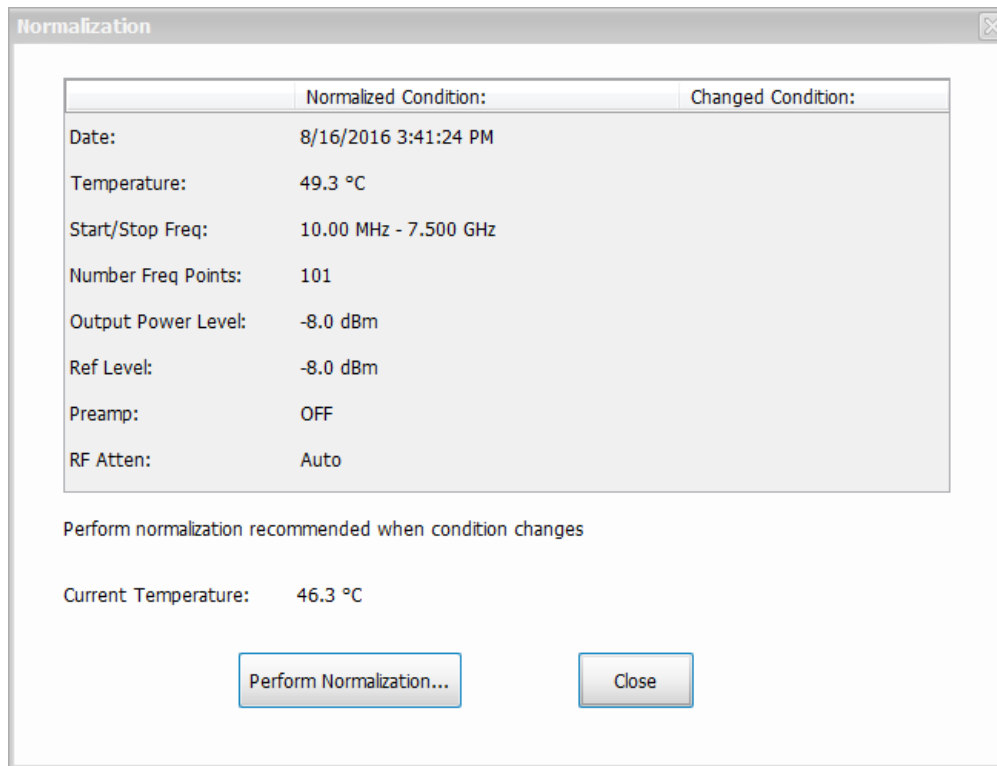

2. Click the **Perform Normalization...** button. The following dialog will appear with a connection diagram.

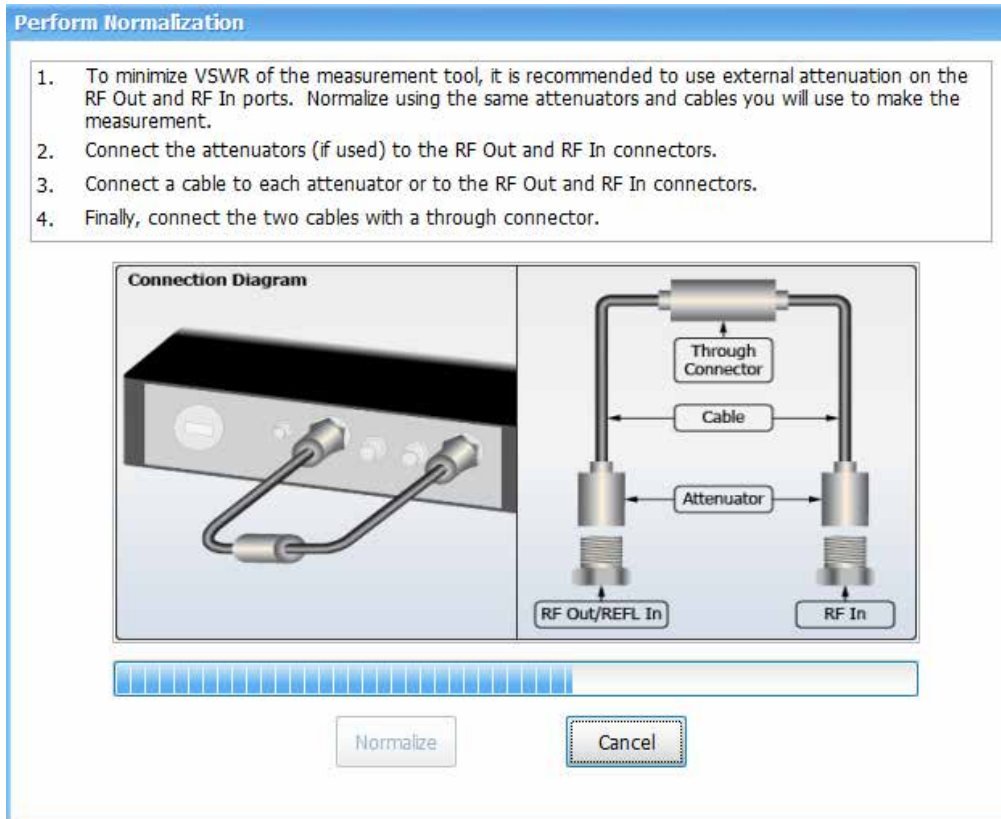

3. Set the amplitude, connect the test setup (without the DUT) between the RF Out/REFL In and RF In ports.
4. Click the **Normalize** button. Progress is shown in yellow text on the display as percent complete.
5. When the process is complete, the normalization conditions will show in the dialog.
6. Click **Close**.
7. The normalization status will show as Norm: On in the top left portion of the display.

Taking a measurement

1. Once the normalization is complete, connect the DUT into the test setup and the measurement will begin.
2. Select **Setup > Amplitude** to open the Amplitude control panel.
3. In the Internal Settings tab, set Internal Attenuator to 0 dB. This will reduce the noise floor. You may want to set this to something else depending on your measurement environment, but this is typical for a 3 GHz loss filter.
4. Click  to return to the Transmission Gain Settings control panel and select the Tracking Gen tab.
5. Set the Output Power Level. You should set this and the Ref Level to the same value. In the following example (see below image), both are set to -8 dB.
6. If you change settings after the initial normalization, run another normalization with the new settings and then rerun the measurement.



Note: Using the Cable Loss, RL/DTF, or Transmission Gain displays at the same time as the Spectrum display can cause the sweep speed in Spectrum to be reduced. Closing the non-Spectrum display will return the sweep speed to the correct speed.

Reading the display

The following image shows a measurement performed on a low pass filter from 10 MHz to 7.5 GHz. A reference marker (MR) is placed at 3.006 GHz. A marker (M1) is placed at the minimum gain value.

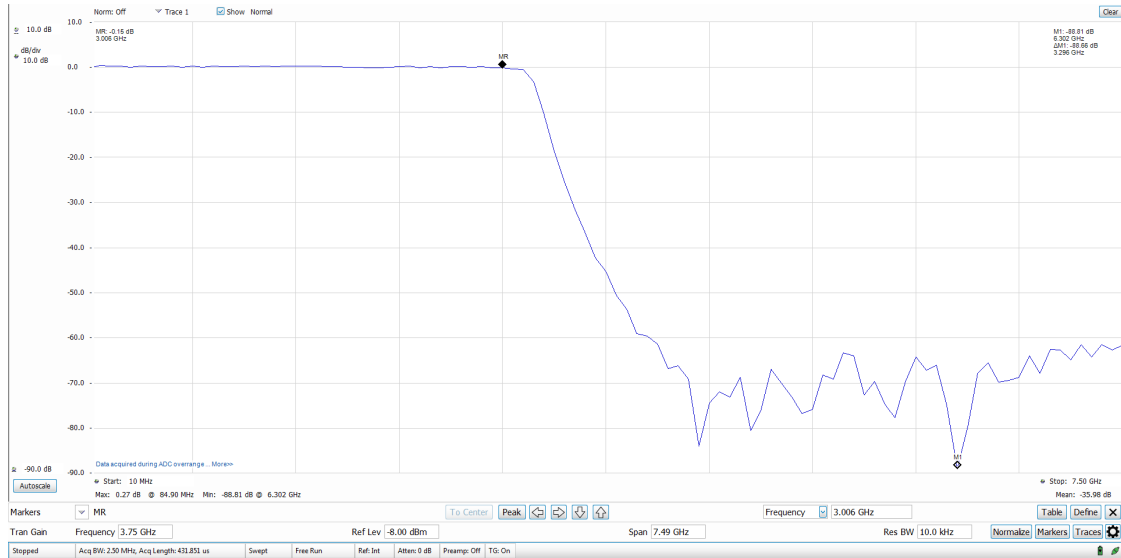

1. Norm: Shows the normalization status at the top of the Transmission Gain display. This can be one of the following:
 - **On**: The unit has been normalized and is making measurements at the same frequencies at which it was normalized.
 - **On: Interp**: The unit has been normalized, but is making measurements at frequencies other than the normalized points and is interpolating the normalization between points.
 - **Off**: The unit has not been normalized or one or more of the operating conditions has changed. Operating conditions are Frequency Range (outside normalized frequency range), Tracking Generator Output Power, Reference Level, Preamp On/Off, RF Attenuation, or Temperature (>5° C from the normalized temperature).
2. Start: Shows the start frequency of the measurement, which is set in the Freq Setup tab of the Settings control panel.
3. Stop: Shows the stop frequency of the measurement, which is set in the Freq Setup tab of the Settings control panel.

Transmission Gain Display Settings



The Settings control panel tabs allow you to change various parameters and settings for the Transmission Gain display.

Freq Setup - Tracking generator

The Freq Setup tab provides access to frequency settings for the Transmission Gain display.

Freq Setup
Track Gen
Traces
Scale
Prefs

Frequency: <input style="width: 80%;" type="text" value="3.75 GHz"/>	Start Freq: <input style="width: 80%;" type="text" value="10 MHz"/>
Span: <input style="width: 80%;" type="text" value="7.49 GHz"/>	Stop Freq: <input style="width: 80%;" type="text" value="7.50 GHz"/>
Points: <input style="width: 80%;" type="text" value="101"/>	Res BW: <input style="width: 80%;" type="text" value="10.0 kHz"/>

Setting	Description
Frequency	The frequency at the center of the selected Span.
Span	The difference between the start and stop frequencies.
Points	The number of frequency points in the measurement range.
Res BW	The resolution bandwidth of the measurement.
Start Freq	The lowest frequency in the span.
Stop Freq	The highest frequency in the span.

Center, Start, Stop, and Span Frequencies Are Correlated

Changing the values for the Frequency, Start frequency, Stop frequency or Span will change the values for the other settings, depending on the setting you change. For example, if you change the Frequency, the Start and Stop frequencies will be adjusted automatically to maintain the same Span.

If the Start and Stop frequencies are changed so that they are closer than the minimum span setting, the Start and Stop frequencies will be adjusted to maintain the minimum Span setting.

Setting Changed Manually	Settings Changed Automatically As a Result	Setting Not Automatically Changed
Start	Frequency, Span	Stop
Stop	Frequency, Span	Start
Frequency	Start, Stop	Span
Span	Start, Stop	Frequency

Track Gen tab - Tracking generator

The Track Gen tab allows you to adjust the output power level from 0 dBm to -43 dBm.

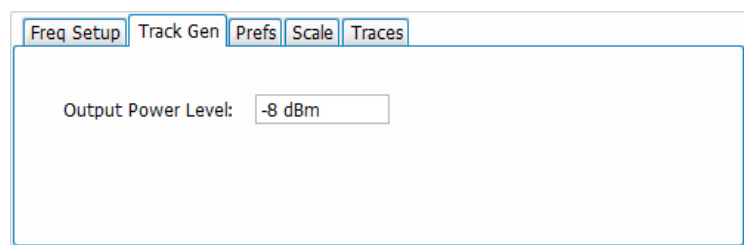

Prefs tab - Tracking generator

The Prefs tab enables you to change parameters of the measurement display.

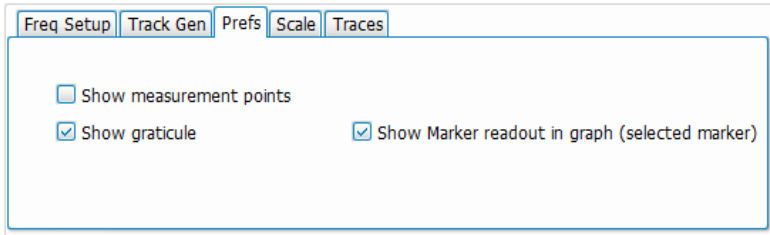

Setting	Description
Show measurement points	Marks each measurement point on the trace.
Show graticule	Displays or hides the graticule in the display.
Show Marker readout in graph	When a marker is enabled, this setting displays or hides the marker readout, but not the marker itself, on the graph area.

Scale tab - Tracking generator

The Scale tab allows you to change the vertical and horizontal scale settings. Changing the scale settings changes how the trace appears on the display but does not change control settings such as Center Frequency.

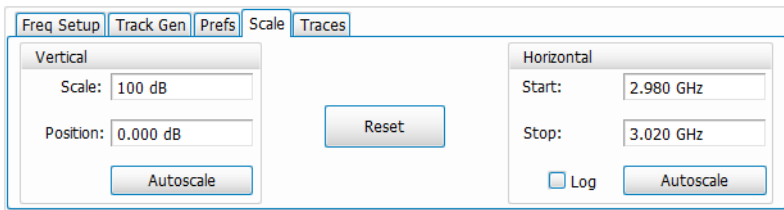

Setting	Description
Vertical	Controls the vertical position and scale of the trace display.
Scale	Changes the vertical scale units.
Position	Set the position in the middle of the vertical axis.
Autoscale	Resets the scale of the vertical axis to contain the complete trace.
Reset	Resets both vertical and horizontal scales.
Horizontal	Controls the span of the trace display and position of the trace.
Start	Set the Zoom Start frequency. This only affects the start frequency shown on the graph.
Stop	Set the Zoom Stop frequency. This only affects the start frequency shown on the graph.
Autoscale	Resets the scale of the horizontal axis to contain the complete trace.

Table continued...

Setting	Description
Log	Resets the display to show the frequency axis in a logarithmic scale.

Traces tab - Tracking generator

The Traces tab allows you to set the display characteristics of displayed traces.

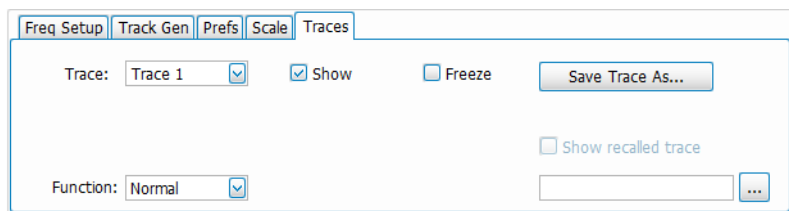

Setting	Description
Trace	Selects a trace.
Show	Shows / hides the selected trace.
Function	Selects the trace processing method. Available settings are: Normal, Average (VRMS), Max Hold, Min Hold and Average (of logs).
Count	Sets the number of traces averaged to generate the displayed trace. (Present only when Function is set to anything but Normal.)
Freeze	Halts updates to the selected trace.
Save Trace As	Saves the selected trace to a file for later recall and analysis.
Show recalled trace	Displays a saved trace instead of a live trace.

Trace

Available traces for Transmission Gain are: Trace 1, Trace 2, and Trace 3. These traces are based on the input signal and enable you to display the input signal using different processing (Function). For example, you could display Trace 1 with Function set to Normal, Trace 2 with Function set to Max Hold and Trace 3 with Function set to Min Hold.

Function (trace processing)

The Function setting controls how traces are processed to display.

- **Normal** - Each new trace is displayed and then replaced by the next trace. Each data point contains a single vertical value.
- **Avg (VRMS)** [Average V_{RMS}] – Each point on the trace is the result of determining the RMS Voltage value for all of the IQ samples available to the trace point. When the averaging function is applied to a trace, the averaging is performed on the linear (Voltage) values, resulting in the correct average for RMS values.
- **Max Hold** - Displays the maximum value in the trace record for each display point. Each new trace's display point is compared to the previous maximum value and the greater value is retained for display and subsequent comparisons.

- **Min Hold** - Displays the minimum value in the trace record for each display point. Each new trace's display point is compared to the previous minimum value and the lesser value is retained for display and subsequent comparisons.
- **Avg (of logs)** – In the process of measuring signal level, the result is converted to Watts and then to dBm. Averaging is then applied to the resultant traces.

Saving Traces

To save a trace for later analysis:

1. Select the **Save Trace As** button. This displays the Save As dialog box.
2. Navigate to the desired folder or use the default.
3. Type a name for the saved trace and click **Save**.

Recalling Traces

You can recall a previously saved trace for analysis or comparison to a live trace.

To select a trace for recall:

1. Select the trace into which the recalled trace will be loaded, from the Trace drop-down list.
2. Click the ... button to display the Open dialog box.
3. Navigate to the desired file and click **Open**.
4. Check the **Show Recalled Trace** check box.

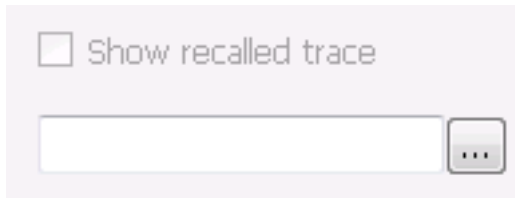

5. Verify that the **Show** check box is selected for the trace (either on this tab or next to the drop-down list located at the top-left corner of the graph).

Calibration for Cable Loss, Return Loss, and DTF measurements

Overview

The instrument uses the vector values of the transmitted and reflected signals when making a cable loss, return loss, and distance to fault (DTF) measurement. These vector values can change with operating conditions, particularly over temperature, making recalibration sometimes necessary for best results.



Note: Option SV60-SVPC (Cable Loss, Return Loss, and DTF) available for the RSA500A series and RSA600A series only.



Tip: See the [Features by product](#) on page 33 topic for more information about which features are available with which connected analyzers.

You can perform a new calibration or load an existing calibration. Select one of the following topics to view the related procedure.

- [How to perform a new calibration](#) on page 246
- [How to save a calibration](#) on page 250
- [How to load a User calibration](#) on page 249
- [How to load a Factory calibration](#) on page 249

You can also view the following calibration topics in this section:

- [Calibration types](#) on page 245
- [Calibration status messages](#) on page 254

Calibration types

The instrument can be used with three different types of calibrations.

Factory

This calibration set is generated during initial factory adjustment or whenever the instrument is returned for service for NIST calibration, and is stored in the instrument hardware. The factory calibration can be recalled at any time, and cannot be changed by the user. The calibration is done at high and low level power settings over the entire frequency range of the instrument. This calibration provides good measurement accuracy without requiring the use of a calibration kit.

This calibration is good to the PORT of the instrument and does not include any additional cabling (jumpers) used in your measurement.

Full

This calibration set is generated by the user at a single power level, over the full frequency range of the instrument. The number of calibration points used in this calibration is fixed. This was selected as a trade off between interpolation accuracy versus calibration time. This calibration can be named and stored by users, and multiple Full calibrations can be saved.

Custom

This calibration is generated by the user and it is user-controlled with regards to power level, start and stop frequency, and number of calibration points. You can name and store this calibration, and multiple Custom calibrations can be saved. Because the frequency range of the calibration is limited by your specified settings, it is recommended only for when you need to optimize measurement speed by specifying a limited operation range with a defined number of points.

How to perform a new calibration

Before performing a calibration, disconnect any signal from the RF In port. To perform a new calibration for a cable loss, return loss, or distance to fault measurement, perform the following procedure.

1. Click the **Calibrate** button located at the bottom right of the display window. The following dialog will appear. This dialog allows you to select the calibration type.

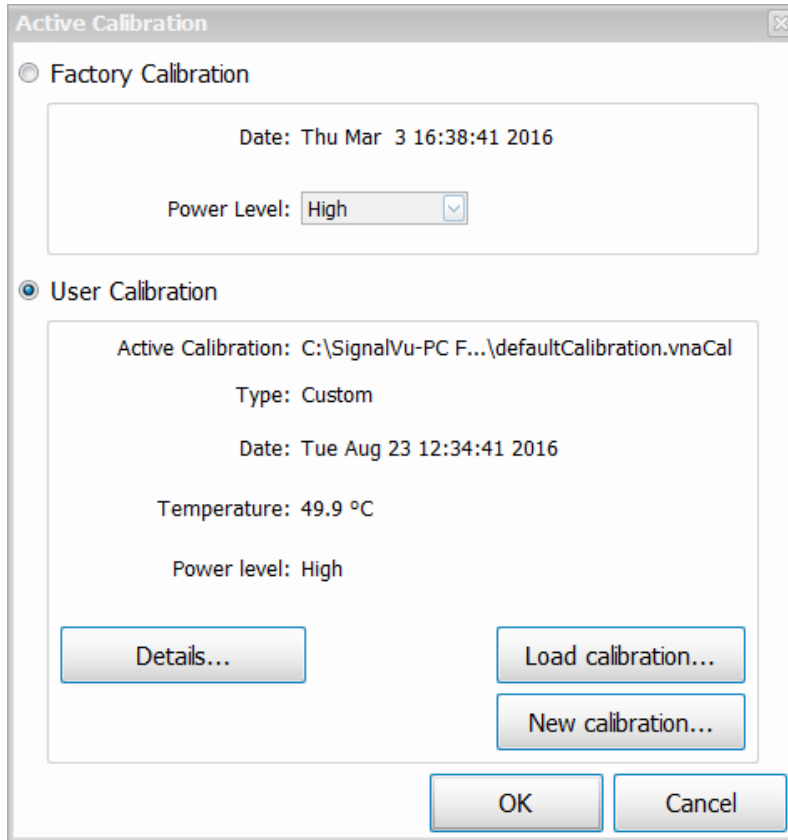

2. Click the **New Calibration** button to open the New Calibration window, and then select a calibration type.
 - If you select **Full**, then you will need to set the Power Level for a calibration covering the full frequency range of the instrument.

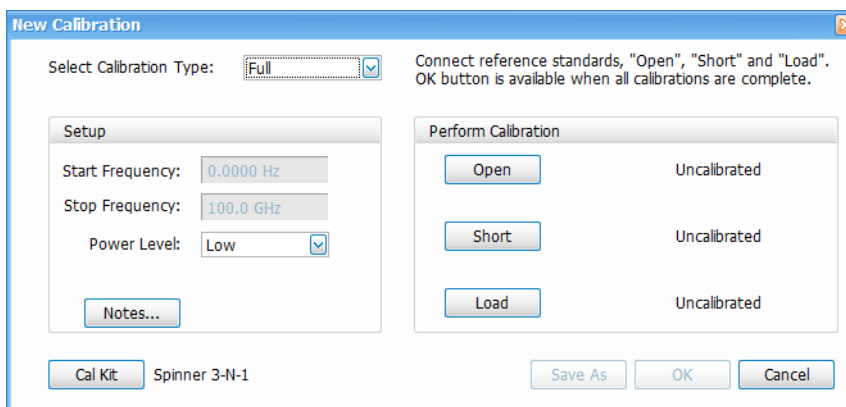

- If you select **Custom**, then you will need to enter frequency, power level, and number of points.

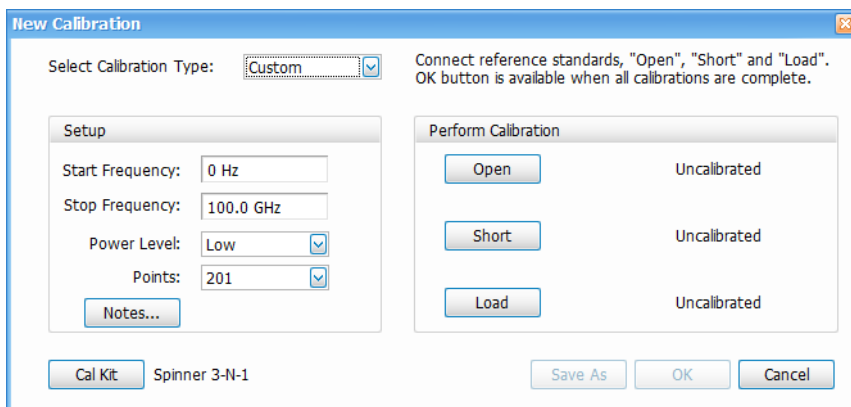

3. If desired, click the **Notes...** button and enter notes for this specific calibration. Click **OK** to save and close the window.

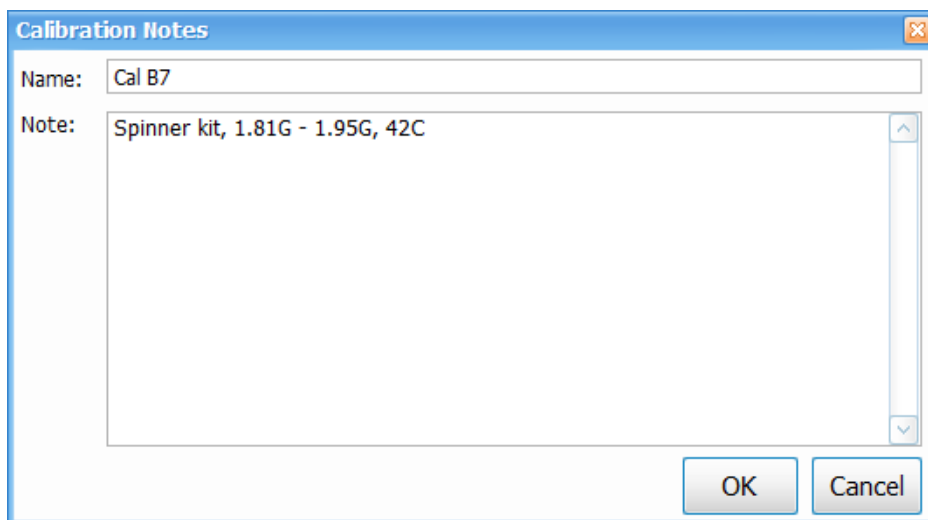

4. If you want to change the calibration kit details or load an existing calkit file, click on the **Cal Kit Info** button. Enter the calkit information and then do one of the following:

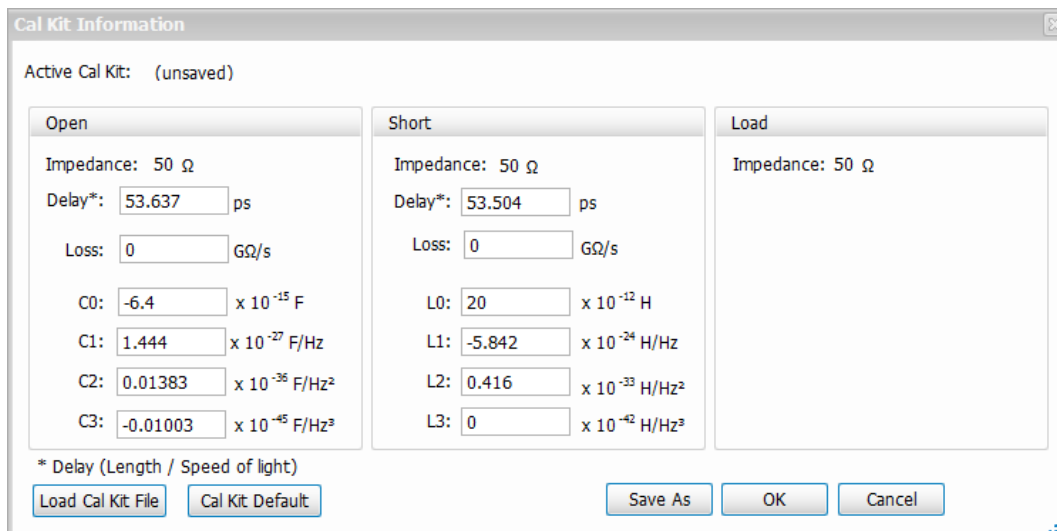

- Click **Save As** to save the calkit file.
- Click **OK** to close the Calkit Information window and use the information one time without saving a calkit file.

- Click **Load Cal Kit File** to load your own file.
 - Click **Cal Kit Default** to load the Spinner 3-N-1 default calkit file.
5. Connect one end of the cable to the REFL In port of the instrument. Ideally, you should use the cable for the calibration with which you will perform the measurement, effectively removing its influence from the measurement.
 6. Terminate the other end of the cable with an open termination (from the calibration kit).

Later in the procedure, you will switch out the open for the short and then the short for the load. However, you can do this in any order.

7. Click the **Open** button to run the Open calibration.

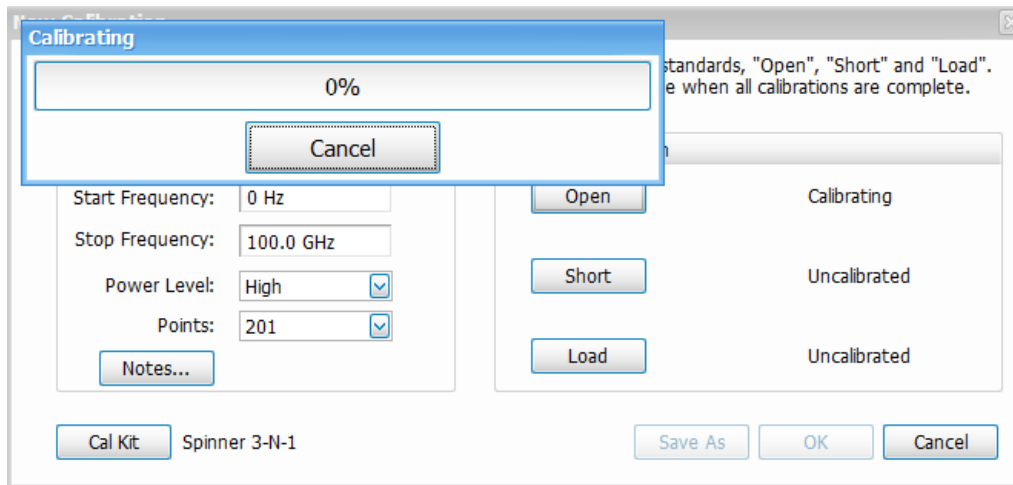

8. Verify a check mark and the "Complete" message has appeared next to the **Open** button. This means that the Open calibration is complete.
9. Remove the open termination from the cable and attach the short termination.
10. Click the **Short** button to run the Short calibration.
11. Verify a check mark and the "Complete" message has appeared next to the **Short** button. This means that the Short calibration is complete.
12. Remove the short termination from the cable and attach the load termination.
13. Click the **Load** button to run the Load calibration.
14. Verify a check mark and the "Complete" message has appeared next to the **Load** button. This means that the Load calibration is complete.
15. The **Save As** and **OK** buttons will become available once all calibrations are complete. Select **OK** to accept the calibration but not save the file for future use. Select **Save As** to [save the calibration](#) as a file.
16. Click on the **Details** button in the Active Calibration window to view the calibration details.
17. Remove the calibration kit from the test setup before starting a measurement.

You are now ready to take a measurement:

[Make a cable loss measurement](#)

[Make a return loss measurement](#)

[Make a distance to fault measurement](#)

How to load a User calibration

Before performing a calibration, disconnect any signal from the RF In port. If you want to load and use an existing calibration, click the **Load calibration** button in the Active calibration window. You will then need to navigate to the stored calibration file and select it. Click **OK** to load the calibration.

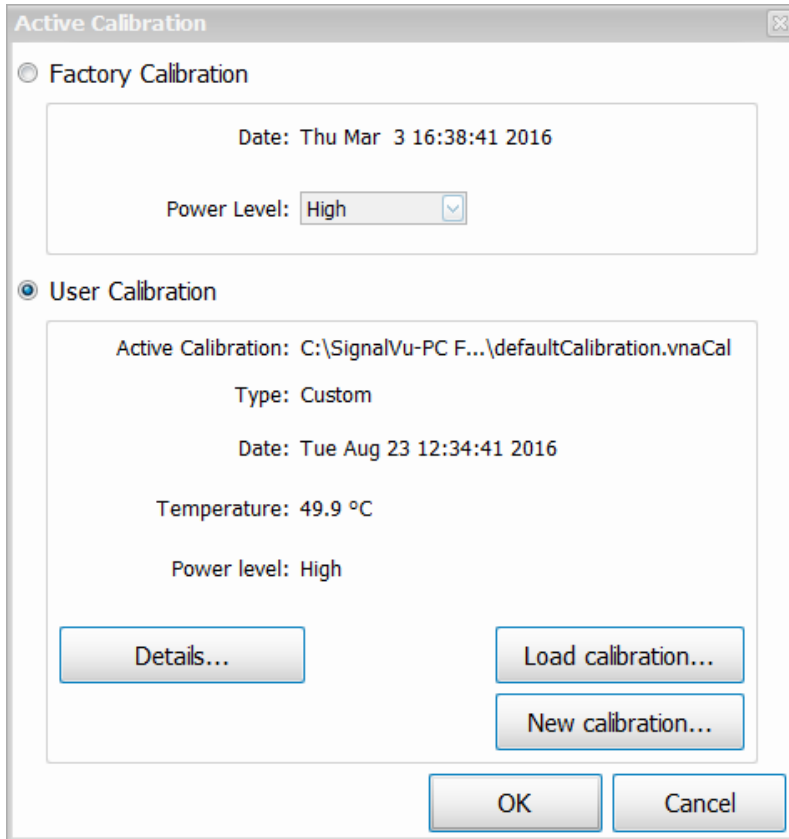

You are now ready to take a measurement:

[How to make a cable loss measurement](#)

[How to make a return loss measurement](#)

[How to make a distance to fault measurement](#)

How to load a Factory calibration

Before performing a calibration, disconnect any signal from the RF In port. If you want to load Factory calibration, click the **Factory calibration** button in the Active calibration window.

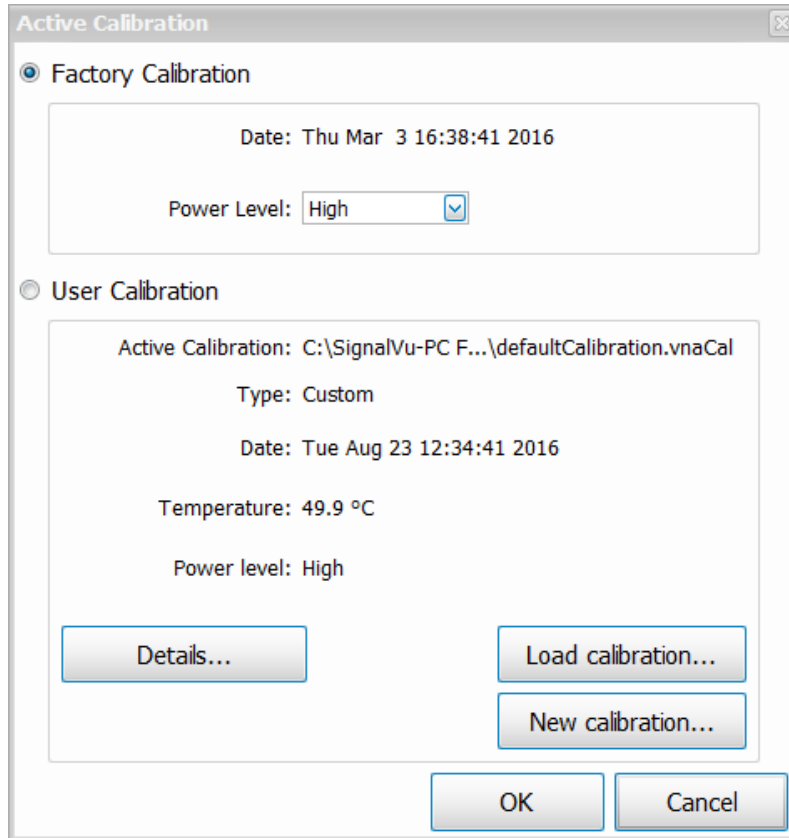

Choose the Power Output Level

The High Power Level output is -10 dBm. High power measurements are the default setting and are recommended for measurements of all passive circuits such as cables and filters.

The Low Power Level output is -30 dBm. Low power measurements may be needed for testing circuits that have gain and may be compressed if there are high powers input to them.

Load calibration

Click **OK** to load the calibration. The Active Calibration window will close.

You are now ready to take a measurement:

[How to make a cable loss measurement](#)

[How to make a return loss measurement](#)

[How to make a distance to fault measurement](#)

How to save a calibration

Before performing a calibration, disconnect any signal from the RF In port. To save a new calibration, do the following:

1. Click the **Calibrate** button located at the bottom right of the display window. The following dialog will appear. This dialog allows you to select the calibration type.

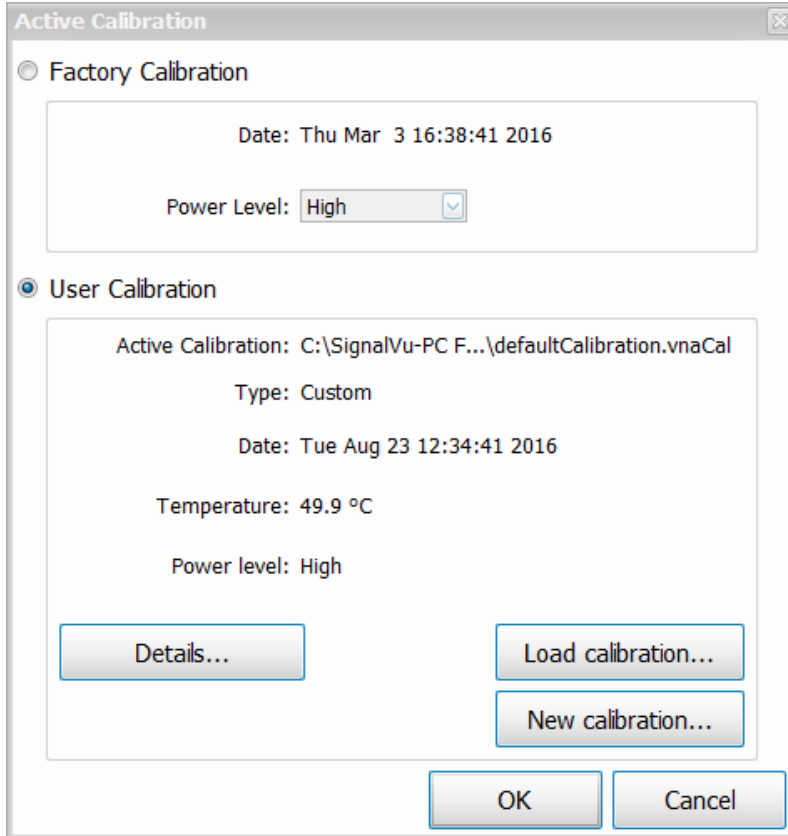

2. Click the **New Calibration** button to open the New Calibration window, and then select a calibration type.
 - If you select **Full**, then you will need to set the Power Level for a calibration covering the full frequency range of the instrument. The High Power Level output is -10 dBm. High power measurements are the default setting and are recommended for measurements of all passive circuits such as cables and filters. The Low Power Level output is -30 dBm. Low power measurements may be needed for testing circuits that have gain and may be compressed if there are high powers input to them.

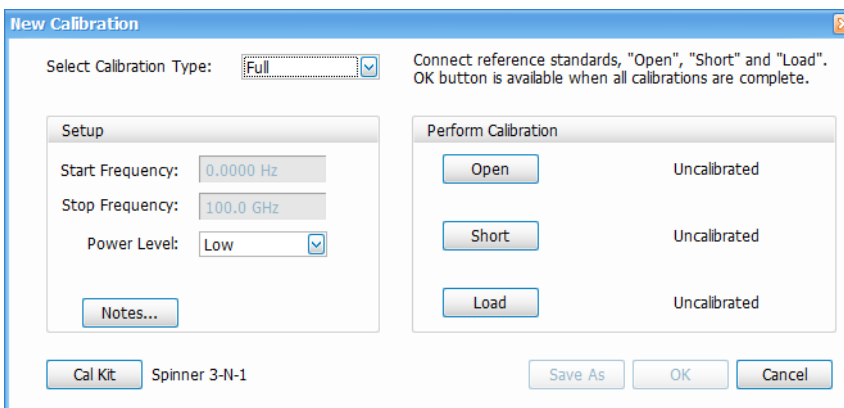

- If you select **Custom**, then you will need to enter frequency, power level, and number of points. The High Power Level output is -10 dBm. High power measurements are the default setting and are recommended for measurements of all passive circuits such as cables and filters.

The Low Power Level output is -30 dBm. Low power measurements may be needed for testing circuits that have gain and may be compressed if there are high powers input to them.

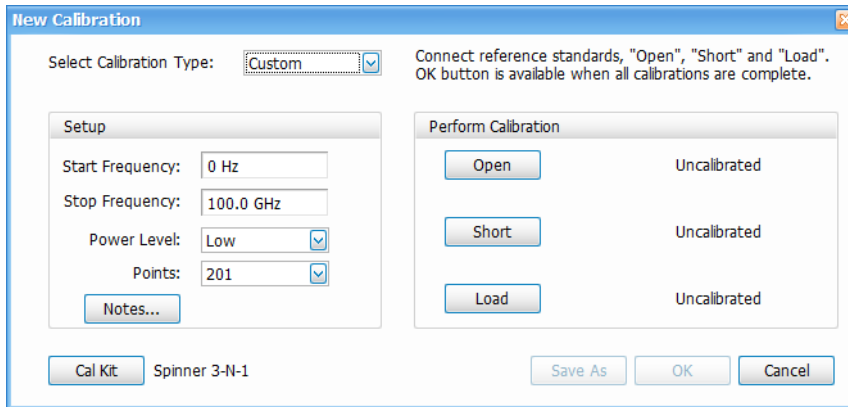

3. If desired, click the **Notes...** button and enter notes for this specific calibration. Click **OK** to save and close the window.

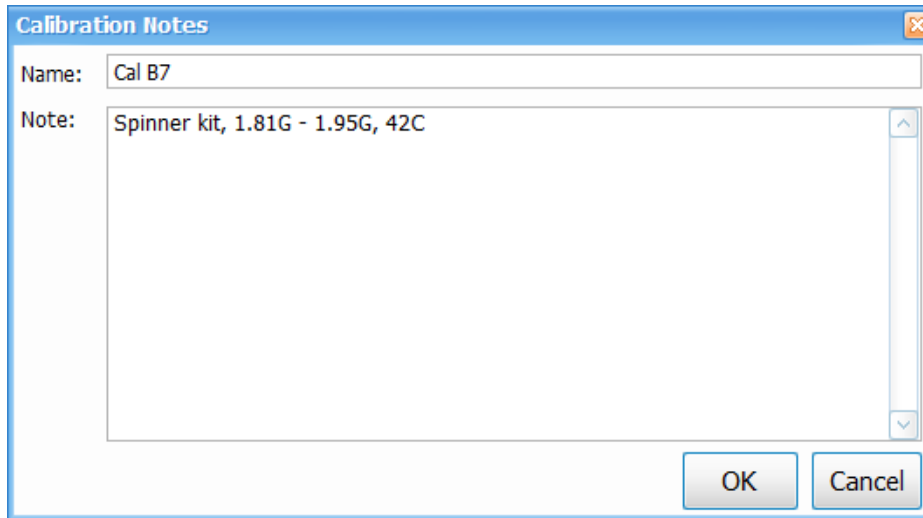

4. If you want to change the calibration kit details or load an existing calkit file, click on the **Cal Kit Info** button. Enter the calkit information and then do one of the following:

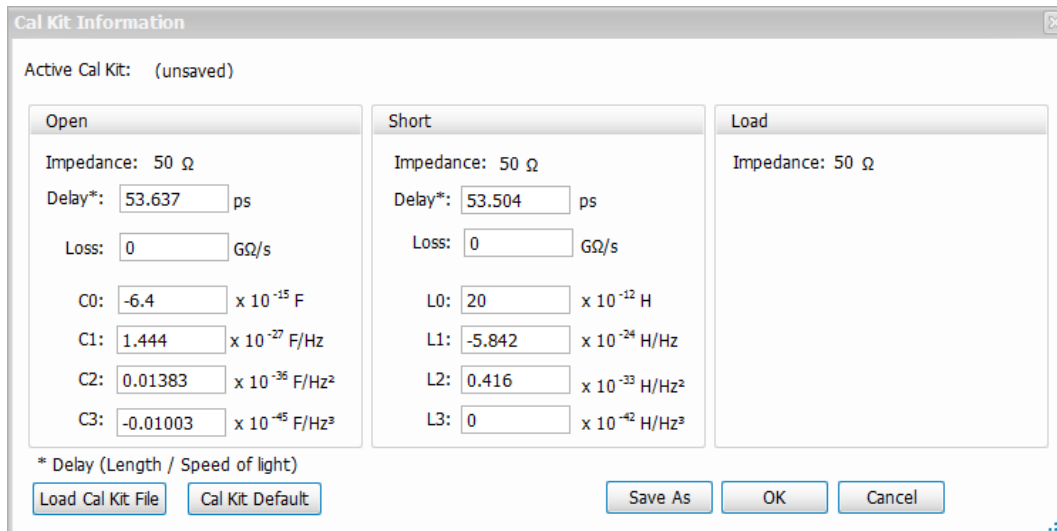

- Click **Save As** to save the calkit file.
 - Click **OK** to close the Calkit Information window and use the information one time without saving a calkit file.
 - Click **Load Cal Kit File** to load your own file.
 - Click **Cal Kit Default** to load the Spinner 3-N-1 default calkit file.
5. Connect one end of the cable to the REFL In port of the instrument. Ideally, you should use the cable for the calibration with which you will perform the measurement, effectively removing its influence from the measurement.
 6. Terminate the other end of the cable with an open termination (from the calibration kit).
Later in the procedure, you will switch out the open for the short and then the short for the load. However, you can do this in any order.
 7. Click the **Open** button to run the Open calibration.

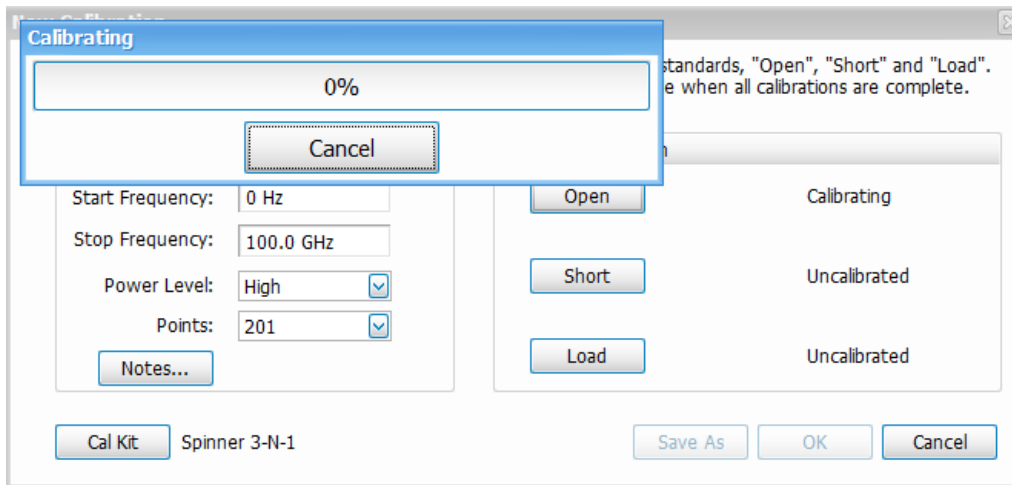

8. Verify a check mark and the "Complete" message has appeared next to the **Open** button. This means that the Open calibration is complete.
9. Remove the open termination from the cable and attach the short termination.
10. Click the **Short** button to run the Short calibration.
11. Verify a check mark and the "Complete" message has appeared next to the **Short** button. This means that the Short calibration is complete.
12. Remove the short termination from the cable and attach the load termination.
13. Click the **Load** button to run the Load calibration.
14. Verify a check mark and the "Complete" message has appeared next to the **Load** button. This means that the Load calibration is complete.
15. Click the **Save As** button, which will become available once all calibrations are complete. Enter the file name and save the file.
16. Click on the **Details** button in the Active Calibration window to view the calibration details.
17. Remove the calibration kit from the test setup before starting a measurement.

You are now ready to take a measurement:

[How to make a cable loss measurement](#)

[Make a return loss measurement](#)

[Make a distance to fault measurement](#)

Calibration status messages

The calibration status of a measurement will show as one of the following at the top right of the display.

- **Uncalibrated:** The measurement is not calibrated. This may be because the measurement parameters have changed versus the loaded calibration set, or the instrument temperature has changed more than 5 degrees from the loaded calibration set.
- **Factory:** The measurement is using the Factory calibration set.
- **User:** The measurement is performed at the same frequency range, power level, and temperature at which it was calibrated.
- **Interpolated:** The measurement is calibrated. Calibration data used during the measurement is interpolated to match the measurement frequency's points (if the measurement frequency range is less than the calibration set frequency range).

Tooltips

Hovering over the calibration status with the mouse will show you one of the following calibration messages.

- **Calibration is uncalibrated:** This indicates that the original calibration conditions have changed and so the calibration is not valid for the current conditions. We recommend you set the User Calibration to maximize possible measurement accuracy.
- **Temperature outside calibration spec:** This indicates that the temperature of the calibration is out of range. We recommend you set the User Calibration to maximize possible measurement accuracy.
- **Factory calibration:** This message indicates that a Factory Calibration was performed.
- **Calibration data interpolated. May reduce accuracy of measurement:** This indicates that the calibration data used during the measurement is interpolated to match the measurement frequency's points. We recommend you set the User Calibration to maximize possible measurement accuracy.

Return Loss Measurements

Return Loss measurements overview

The Return Loss measurement suite (Option SV60-SVPC) provides return loss, VSWR, cable loss, Distance to Fault (DTF) Return Loss, and DTF VSWR measurements. These measurements are vector calibrated. The vector calibration is performed using three known mismatches: open, short, and load, and they are part of a calibration kit. Calibration kits are available from Tektronix, or you can use your own.

This option also requires the tracking generator option (Option 04).



Note: Option SV60-SVPC (Cable Loss, Return Loss, and DTF) available for the RSA500A series and RSA600A series only.



Tip: See the [Features by product](#) on page 33 topic for more information about which features are available with which connected analyzers.

The following displays are available in the Return Loss suite:

- [Cable Loss display](#)
- [RL/DTF \(Return Loss / Distance to Fault\) display](#)

The following topics about Return Loss measurements are available:

- [How to make a Cable Loss measurement](#) on page 255
- [How to make a Return Loss measurement](#) on page 258
- [How to make a Distance to Fault measurement](#) on page 260

How to make a Cable Loss measurement

Disconnect any signal from the RF In port before performing a measurement. Perform the following procedures in the order presented to use the Cable Loss display to perform a cable loss measurement. You can also read more about the elements of the Cable Loss display in the [Elements of the display](#) on page 256 topic.



Note: Option SV60-SVPC (Cable Loss, Return Loss, and DTF) available for the RSA500A series and RSA600A series only.



Tip: See the [Features by product](#) on page 33 topic for more information about which features are available with which connected analyzers.

1. [Select display and set parameters](#) on page 255
2. [Perform or load a calibration](#) on page 256
3. [Take a measurement](#) on page 256

Select display and set parameters

1. Select **Setup > Displays**.
2. In the Measurements panel, select Return Loss.
3. Double click the Cable Loss icon in the Available displays panel to select that display, and then click OK.
4. Click  on the Favorites bar to open the Cable Loss Settings control panel.

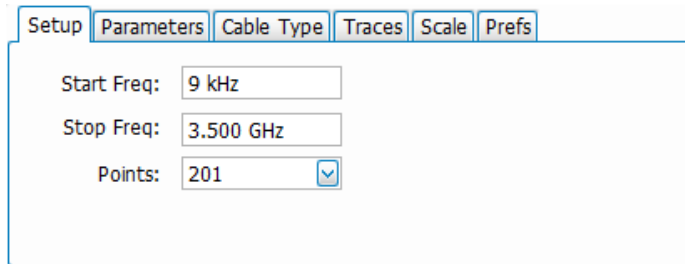

5. In the Setup tab, set the start and stop frequencies and the number of desired measurement points for the frequency sweep. Use the Parameters tab to set the Output Power Level. Use the Traces, Scale, and Prefs tabs to set various trace and display preferences.



Note: Using the Cable Loss, RL/DTF, or Transmission Gain displays at the same time as the Spectrum display can cause the sweep speed in Spectrum to be reduced. Closing the non-Spectrum display will return the sweep speed to the correct speed.

Perform or load a calibration

Before you can take a measurement you must perform or load a calibration. View one of the following topics and follow those procedures before going to the next section.

- [Perform a new calibration](#)
- [Load a Factory calibration](#)
- [Load a User calibration](#)

Take a measurement

1. Connect your DUT and the measurement will start.

Elements of the display

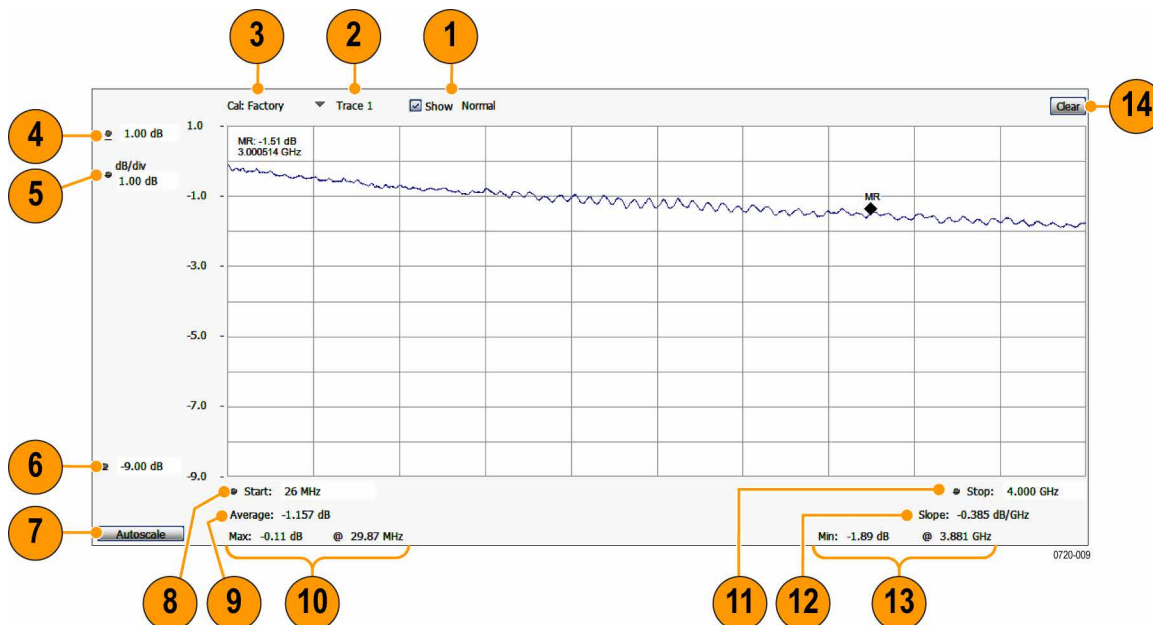

Item	Display element	Description
1	Show	Indicates whether the trace is Off (unchecked box) or if the trace is showing (checked box) and which method that trace is processed (Normal, Avg, Min, or Max). Set trace processing using the Function menu in the Traces tab of the Cable Loss Settings control panel.
2	Trace	Indicates the selected trace. The trace is only displayed if the Show box is checked.
3	Calibration status	Indicates which calibration set the analyzer is using. See the Calibration status messages on page 254 topic for details.
4	dB (upper limit)	Vertical scale position (top of display range).
5	dB/div	Bottom of the vertical display range.
6	dB (lower limit)	Lower limit of cable loss.
7	Autoscale	Properly offsets the peak of the display from the top of the screen. If the screen has been enlarged through a manual vertical (dB/div) setting entry, the view is not vertically rescaled when Autoscale is used.
8	Start	Shows the start frequency of the frequency sweep. Set in the Setup tab of the Cable Loss Settings control panel.
9	Average	Average cable loss over the frequency range measured from the selected trace.
10	Maximum	The maximum value of the selected trace and the frequency at which that value occurs.
11	Stop	Shows the stop frequency of the frequency sweep. Set in the Setup tab of the Cable Loss Settings control panel.
12	Slope	Shows the rate of change of the cable loss over the frequency range for the selected trace.
13	Minimum	The minimum value of the selected trace and the frequency at which that value occurs.
14	Clear	Erases the current results from the display.

Cable Loss display Settings control panel

Main menu: Setup > Settings



The Settings control panel tabs for the Cable Loss display are shown in the following table. Click on a link to view the parameters and settings associated with a tab.

Settings tab	Description
Setup	Specifies the start and stop frequencies and the number of measurement (display) points in the frequency sweep.
Parameters	Specifies output power level.
Cable Type on page 268	Specifies the cable type and allows you to add a new cable type.
Traces	Specifies the display characteristics of displayed traces and allows you to save and recall trace.
Scale	Specifies the vertical and horizontal scale settings.
Prefs	Specifies whether or not certain display elements are shown.

How to make a Return Loss measurement

Disconnect any signal from the RF In port before performing a measurement. Perform the following procedures in the order presented to make a return loss measurement. You can also read more about the elements of the RL/DTF display in the [Elements of the display](#) topic.



Note: Option SV60-SVPC (Cable Loss, Return Loss, and DTF) available for the RSA500A series and RSA600A series only.



Tip: See the [Features by product](#) on page 33 topic for more information about which features are available with which connected analyzers.

1. [Select display and set parameters](#) on page 258
2. [Perform or load a calibration](#) on page 259
3. [Take a measurement](#) on page 259

Select display and set parameters

1. Select Setup > Displays.
2. In the Measurements panel, select Return Loss.
3. Double click the RL/DTF icon in the Available displays panel to select that display, and then click **OK**.
4. Click on the Favorites bar to open the RL/DTF Settings control panel.
5. Click on the **Displays** tab, select **Return Loss** for Display 1, and then select **Display 1** in the **Show Displays** panel to view the Return Loss display only.

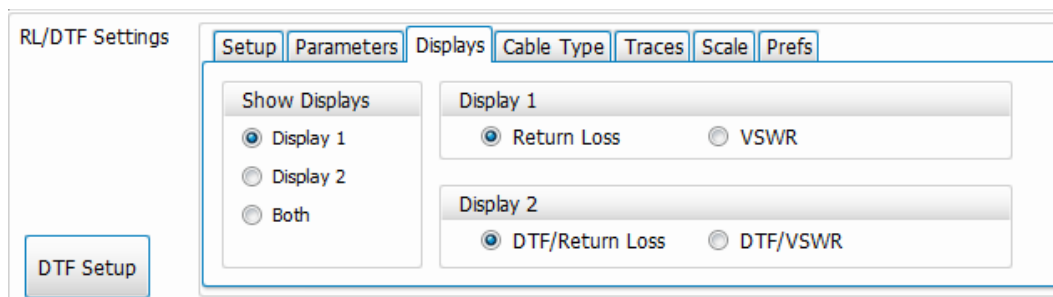

6. In the Setup tab, set the start and stop frequencies and the Points value. Use the Parameters tab to set the Output Power Level. Use the Traces, Scale, and Prefs tabs to set various trace and display preferences.



Note: Using the Cable Loss, RL/DTF, or Transmission Gain displays at the same time as the Spectrum display can cause the sweep speed in Spectrum to be reduced. Closing the non-Spectrum display will return the sweep speed to the correct speed.



Tip: The Factory Calibration will be used if you change the power level to a value that is different from your calibration, or if you change the start and/or stop frequency to be outside of the range that you calibrated.

Perform or load a calibration

Before you can take a measurement you must perform or load a calibration. View one of the following topics and follow those procedures before going to the next section.

- [Perform or load a calibration](#)
- [Load a Factory calibration](#)
- [Load a User calibration](#)

Take a measurement

1. Connect your DUT and the measurement will start.

Elements of the Return Loss display

The following image and table show the elements of the RL/DTF display.

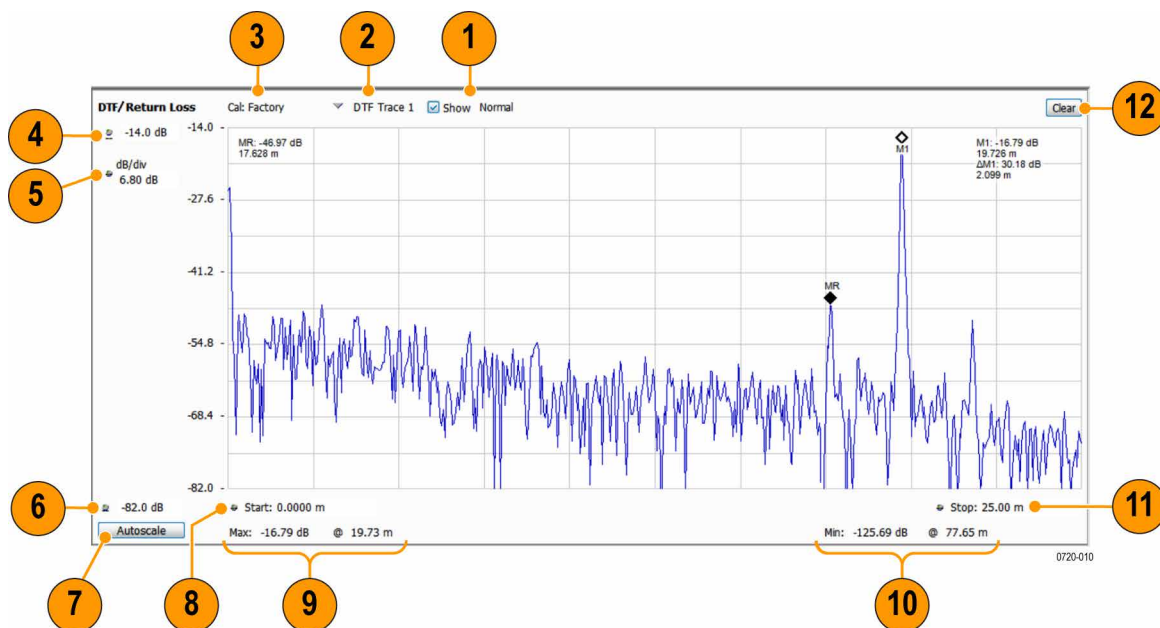

Item	Display element	Description
1	Show	Indicates whether the trace is Off (unchecked box) or if the trace is showing (checked box) and which method that trace is processed (Normal, Avg (VRMS), Min Hold, or Max Hold).
2	Trace	Indicates the selected trace. Note that the selected trace will only be visible if the "show" box is checked identifies if the selected trace is on the RL or DTF display view.
3	Calibration status	Indicates which calibration set the analyzer is using. See the Overview on page 245 topic for details.

Table continued...

Item	Display element	Description
4	dB (upper limit)	Vertical scale position (top of display range)
5	dB/div	Sets the vertical scale value. The maximum value is 20.00 dB/division.
6	dB (lower limit)	Bottom of vertical display range (vertical position - vertical scale)
7	Autoscale	Properly offsets the peak of the display from the top of the screen. If the screen has been enlarged through a manual vertical (dB/div) setting entry, the view is not vertically rescaled when Autoscale is used.
8	Start	Shows the start frequency set of the measurement. Set in the Setup Tab with the Start Freq control in the Settings control panel.
9	Maximum	The maximum value of the selected trace and the distance at which that occurs.
10	Minimum	The minimum value of the selected trace and the distance at which that occurs.
11	Stop	Shows the stop frequency of the measurement. Set in the Setup Tab with the Start Freq control in the Settings control panel.
12	Clear	Erases the current measurement results and active trace(s) from the display.

How to make a Distance to Fault measurement

Disconnect any signal from the RF In port before performing a measurement. Perform the following procedures in the order presented to make a Distance to Fault measurement. You can also read more about the elements of the RL/DTF display in the [Elements of the display](#) topic.



Note: Option SV60-SVPC (Cable Loss, Return Loss, and DTF) available for the RSA500A series and RSA600A series only.



Tip: See the [Features by product](#) on page 33 topic for more information about which features are available with which connected analyzers.

1. [Select display and set parameters](#) on page 260
2. [Perform or load a calibration](#) on page 262
3. [Take a measurement](#) on page 262

Learn more about DTF parameters in the following topics:

- [How to change the vertical scale units](#) on page 263
- [How to limit the bandwidth for a bandpass filter](#)
- [How to improve the display of distance to fault measurements](#) on page 263
- [How to improve the resolution of distance to fault measurements](#) on page 264

Select display and set parameters

1. Select **Setup > Displays**.
2. In the Measurements panel, select Return Loss.

- Double click the RL/DTF icon in the Available displays panel to select that display, and then click OK.
- Click  to open the RL/DTF Settings control panel.

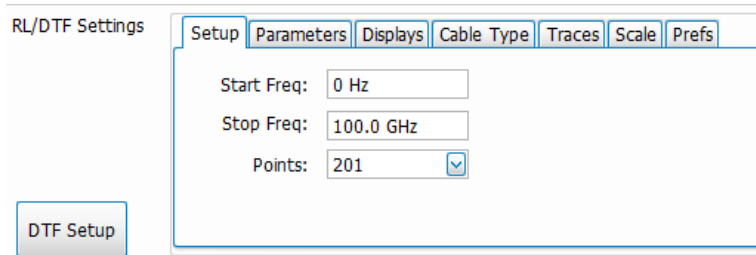

RL/DTF Settings

Setup Parameters Displays Cable Type Traces Scale Prefs

Start Freq: 0 Hz

Stop Freq: 100.0 GHz

Points: 201

DTF Setup

- Click on the **Displays** tab, select **DTF/Return Loss** for Display 2, and then select **Display 2** in the **Show Displays** panel to view the DTF/Return Loss display only.

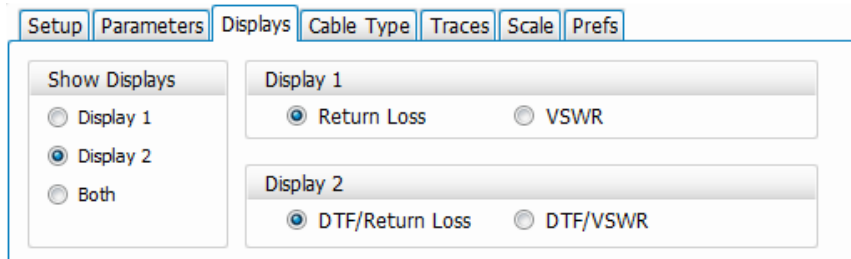

Setup Parameters Displays Cable Type Traces Scale Prefs

Show Displays

Display 1

Return Loss VSWR

Display 2

DTF/Return Loss DTF/VSWR

- Use the Parameters tab to set the Output Power Level and the DTF Window view. Use the Traces, Scale, and Prefs tabs to set various trace and display preferences.

You can read about the DTF Window settings in the [How to improve the display of distance to fault measurements](#) on page 263 topic.

- Select the Cable Type tab and specify the cable type. If the cable type is not listed, you can add a cable by clicking the New Cable button. This provides access to the New Cable panel where you can add a name, velocity, and loss for the cable.

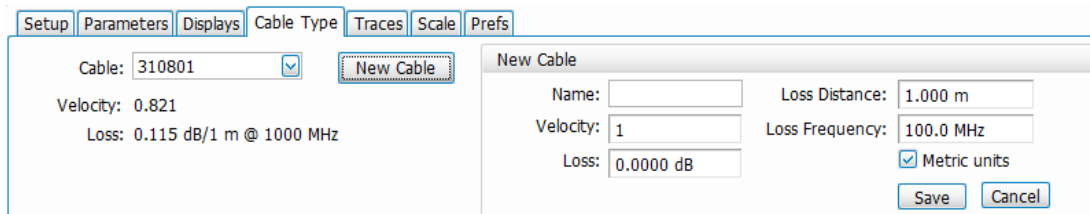

Setup Parameters Displays Cable Type Traces Scale Prefs

Cable: 310801

Velocity: 0.821

Loss: 0.115 dB/1 m @ 1000 MHz

New Cable

Name:

Loss Distance: 1.000 m

Velocity: 1

Loss Frequency: 100.0 MHz

Loss: 0.0000 dB

Metric units

Save Cancel

- Click on the **DTF Setup** button to open the DTF Setup window.
- Set the **Cover Distance**. Specify the length of the cable or the distance to the DUT (for example, an antenna). This setup is recommended when there are no frequency limitations on the signal path between the analyzer and the system under test. However, you can reduce the cover distance to just include the fault (for example, if your cable is 100 m long, but there is one fault at 30 m, you can reduce the distance to 35 m).

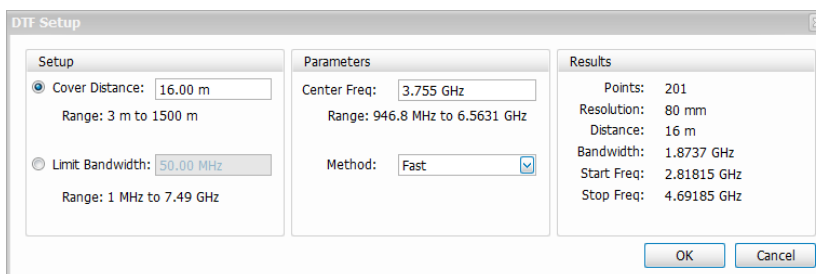

DTF Setup

Setup

Cover Distance: 16.00 m

Range: 3 m to 1500 m

Limit Bandwidth: 50.00 MHz

Range: 1 MHz to 7.49 GHz

Parameters

Center Freq: 3.755 GHz

Range: 946.8 MHz to 6.5631 GHz

Method: Fast

Results

Points: 201

Resolution: 80 mm

Distance: 16 m

Bandwidth: 1.8737 GHz

Start Freq: 2.81815 GHz

Stop Freq: 4.69185 GHz

OK Cancel

- If you want to set a bandwidth limit for the system instead of using distance, select Limit Bandwidth. Otherwise, go to step [11](#) on page 262

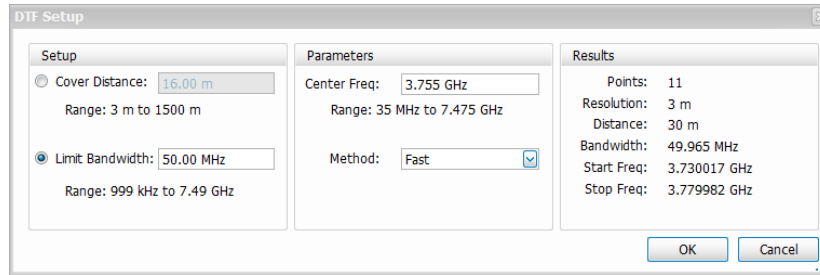

This setup is recommended when frequency-limited devices, such as filters, are in the signal path between the analyzer and the system under test.

11. In the Parameters column of the DTF Setup window, change the Center Freq, if needed. A range of values for the center frequency is provided as an aid. The center frequency depends on the system or DUT.
12. Select the Method: Fast, Normal, Long Distance (if Limit Bandwidth is selected), or High Resolution (if Cover Distance is selected). Each method provides a range of number of points for the frequency sweep. The Fast method has the smallest range of points, and the Long Distance and High Resolution methods have the largest range of points. If you select Limit Bandwidth, increasing the number of points will result in a longer measurable distance.
13. In the Results column, inspect the results. They show the parameters for the frequency sweep and the distance values that will be used for the DTF measurement. If these results do not suit your measurement needs, you will need to adjust the measurement parameters (Setup, Center Freq. and Method) to achieve your desired measurement settings results.
14. Click **OK** to accept the settings and close the DTF Setup window.



Note: Using the Cable Loss, RL/DTF, or Transmission Gain displays at the same time as the Spectrum display can cause the sweep speed in Spectrum to be reduced. Closing the non-Spectrum display will return the sweep speed to the correct speed.

Perform or load a calibration

Before you can take a measurement you must perform or load a calibration. View one of the following topics and follow those procedures before going to the next section.

- [Perform a new calibration](#)
- [Load a Factory calibration](#)
- [Load a User calibration](#)

Take a measurement

1. Connect your DUT and the measurement will start.

Read about the display in the [Elements of the display](#) on page 264 topic.

Explore these topics related to DTF measurements

[How to change the vertical scale units](#) on page 263

[How to limit the bandwidth for a bandpass filter](#)

[How to improve the display of DTF measurements](#)

[How to improve the resolution of DTF measurements](#)

[About the RL/DTF display](#)

How to change the vertical scale units

The default setting for vertical scale units for the Return Loss and DTF measurements is dB. You can also display faults using VSWR as the vertical scale unit. Use the Displays tab in the DTF/Return Loss Settings control panel to change the vertical scale unit to VSWR. Select VSWR for the desired display.

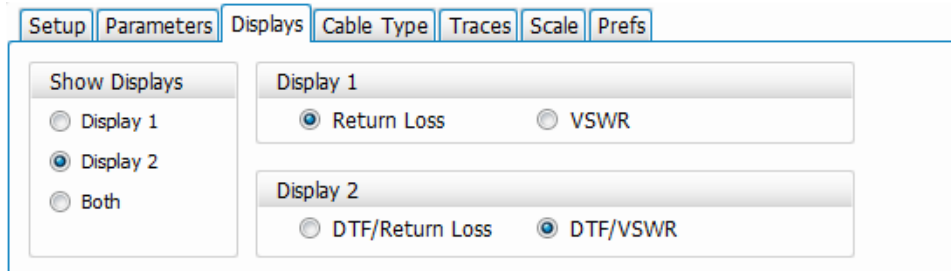

How to select the appropriate settings for DTF Setup

The analyzer automatically adjusts the frequencies it uses to make the distance to fault measurement depending on the user selected Method and Cover Distance settings in the [DTF Setup window](#). The Cover Distance setting is recommended when there is low or no restriction on the frequency of the system and provides the most flexibility in selections of method (number of points) and desired measurement distance. However, if your antenna uses a filter to minimize interference from other sources, you will need to limit the measurement bandwidth used by the analyzer so that its measurement signal can pass through the filter.

The distance resolution of the DTF waveform is inversely proportional to the frequency range of the sweep. By constraining the bandwidth of the sweep (frequency range of the sweep), the resolution of the DTF waveform is decreased.

The analyzer automatically computes the results for the available methods in this setup. Each Method has a range of number of points, with Fast having the smallest range of measurement points and Long Distance (High Resolution) having the largest range. By increasing the number of points, more points are added inside the limited bandwidth of the sweep. This decreases the frequency step in the sweep (the frequency points in the sweep will be closer), resulting in longer measurable distance in the DTF waveform.

In the Method drop-down menu, only the methods that can yield to the Limit Bandwidth (or less) will be available. If a desired method is not available, try changing the limit bandwidth or the center frequency.

Values in the Results column will change as you change values for the Setup, cover distance, Method, Limit Bandwidth or the Center Frequency. If the DTF setup results don't meet your measurement requirements, adjust these parameters to achieve your desired measurement setup.

How to improve the display of distance to fault measurements

The DTF display will show a large main lobe at a fault location, surrounded by series of side lobes of decreasing amplitude. The analyzer provides a choice of windowing functions that enable you to make a tradeoff between resolution of the fault location and suppression of waveform “noise” (side lobe magnitude). This setting is in the Parameters tab of the DTF/Return Loss Settings control panel.

The Rectangular window produces a display with a narrow main lobe and relatively higher side lobes, resulting in better distance resolution but a “noisier” waveform. Nominal, Low, and Minimum Side Lobes windows produce a display with lower size lobes and wider main lobes, respectively. The lower side lobes make the fault easier to identify as the noise around the main lobe is reduced. On the other hand, the wider main lobe reduces the distance resolution.

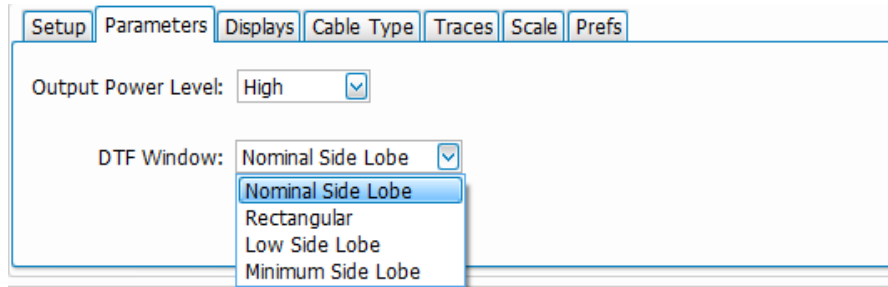

How to improve the resolution of distance to fault measurements

The resolution (distance between data points) shown in the DTF display is based on several interacting factors. Resolution is important because it limits how accurately you can locate a fault. The distance resolution is inversely proportional to the frequency range of the sweep: the wider the frequency range, the smaller the distance resolution. The maximum distance of the DTF waveform depends on the frequency step of the sweep. Therefore, when setting the DTF by Cover Distance, the frequency step size of the sweep is also set.

The analyzer automatically computes the results for the methods in this setup. Each method has a range of number of points, with Fast having the smallest range and Long Distance having the largest range. By increasing the number of points, more points are added inside the limited bandwidth of the sweep. This increases the frequency step in the sweep, resulting in better distance resolution. Distance resolution is inversely proportional to the frequency bandwidth (span) of the sweep.

Increase the bandwidth to get better distance resolution. The number of points only affects the max cover distance (for a fixed bandwidth).

Values in the Results column of the DTF Setup window will change as you change the Cover Distance or the Center Frequency.

Normally, the only settings you need to adjust are the maximum distance and the method. However, if your antenna has a bandpass filter installed, you will need to limit the bandwidth on the analyzer to make correct distance to fault measurements. Limiting the bandwidth used by the analyzer may limit the distance and resolution of the measurement. Refer to the [How to select the appropriate settings for DTF Setup](#) on page 263 section for additional information.

RL/DTF display overview

You can perform Return Loss (RL) and Distance to Fault (DTF) measurements using the RL/DTF display. Return loss, as a function of frequency, measures the ratio in dB of the signal reflected by the DUT to the signal sent to the DUT. A larger (absolute) value of return loss indicates less signal is reflected by the DUT. DTF is the return loss measured as a function of distance along the cable connected to the DUT. It is used to locate faults when the return loss as a function of frequency indicates a problem.

This display allows you to view the RL and DTF/Return Loss (DTF/VSWR) displays together or one at a time. Return Loss or VSWR are different views of ratio of the signal reflected from the DUT and the signal sent to the DUT.

Read the [How to make a Return Loss measurement](#) on page 258 topic to help you perform a return loss measurement. Read the [How to make a Distance to Fault measurement](#) on page 260 topic to help you perform a DTF measurement.

Elements of the display

The following image shows the DTF view of the RL/DTF display. However, the elements of the display are the same for the Return Loss display view, so the table that follows applies to both display views.

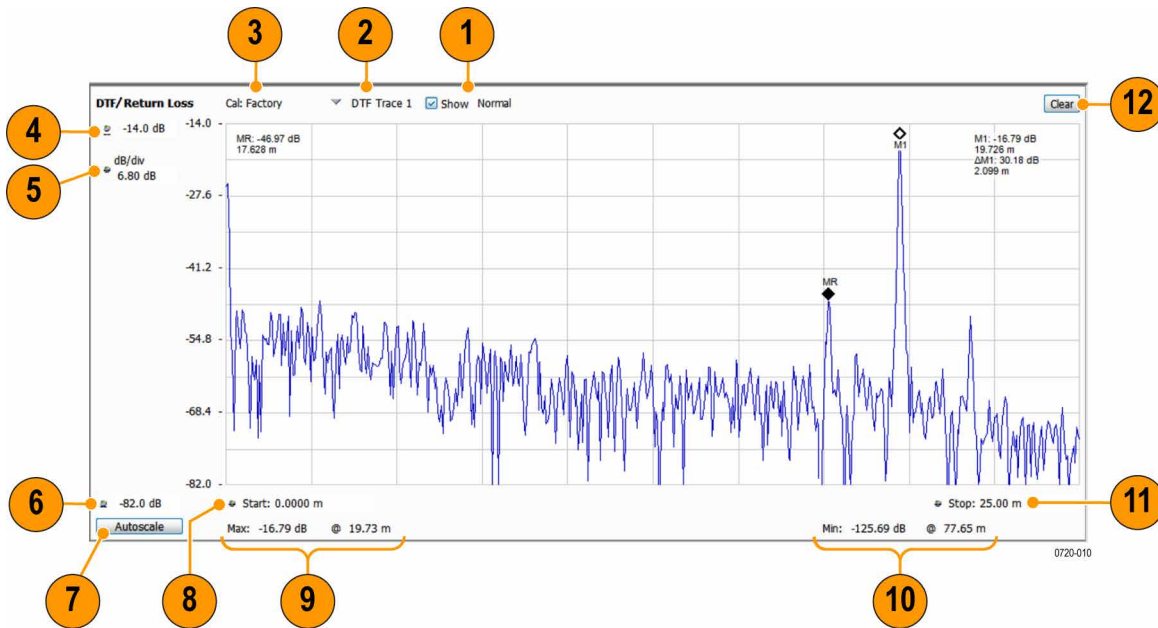

Item	Display element	Description
1	Show	Indicates whether the selected trace is Off (unchecked box) or if the trace is showing (checked box) and which method that trace is processed (Normal, Avg, Min, or Max). Set this using the Function menu in the Traces tab of the settings control panel.
2	Trace	Indicates the selected trace and identifies if the selected trace is on the RL or DTF display view (trace is only visible if the "show" box is checked).
3	Calibration status	Indicates which calibration set the analyzer is using. See the Calibration status messages on page 254 topic for details.
4	dB (upper limit)	Vertical scale position (top of display range).
5	dB/div	Sets the vertical scale value in dB/div (when not in VSWR mode).
6	dB (lower limit)	Bottom of vertical display range (vertical position - vertical scale).
7	Autoscale	Properly offsets the peak of the display from the top of the screen. If the screen has been enlarged through a manual vertical (dB/div) setting entry, the view is not vertically rescaled when Autoscale is used.
8	Start	Shows the start frequency of the frequency sweep. Set in the Setup Tab Start Freq control of the Settings control panel.
9	Maximum	The maximum value of the selected trace and the frequency at which that occurs.
10	Minimum	The minimum value of the selected trace and the frequency at which that occurs.
11	Stop	Shows the stop frequency of the frequency sweep. Set in the Setup Tab Start Freq control of the Settings control panel.

Table continued...

Item	Display element	Description
12	Clear	Erases the current measurement results and active traces from the display.

RL/DTF display Settings control panel

Main menu: Setup > Settings



The following table shows the contents of the Settings control panel for this display. Click on a link to view detailed information about the parameters accessible from each tab.

Settings tab	Description
Setup	Specifies the type of modulation used for the input signal and other parameters.
Parameters	Specifies parameters used by the instrument to analyze the input signal.
Cable Type on page 274	Specifies the cable type and allows you to add a new cable type.
Displays	Specifies to display the RL measurement, the DTF measurement, or both. You can also select VSWR view in either measurement.
Traces	Specifies the display characteristics of displayed traces and allows you to save and recall a trace.
Scale	Specifies the vertical and horizontal scale settings.
Prefs	Specifies whether or not certain display elements are shown.
DTF Setup button (Only available in the DTF/Return Loss view)	Configure distance to fault measurement by Cover Distance or Limit Bandwidth settings.

Cable Loss and RL DTF Display Settings

Cable Loss Display Settings



The Settings control panel tabs allow you to change various parameters and settings for the Cable Loss display.

Setup - Cable Loss

The Setup tab provides access to frequency settings for the Cable Loss display.

Setup Parameters Cable Type Traces Scale Prefs

Start Freq:

Stop Freq:

Points:

Setting	Description
Start Freq	The lowest frequency used for the measurement.
Stop Freq	The highest frequency used for the measurement.
Points	The number of measurement points from start frequency to stop frequency.

Parameters tab - Cable Loss

The Parameters tab allows you to adjust the output power level to High or Low.

Setup Parameters Cable Type Traces Scale Prefs

Output Power Level:

Setting	Description
Output Power Level	Select from High and Low output power levels.

Cable Type

Setup Parameters Displays **Cable Type** Traces Scale Prefs

Cable: 310801 New Cable

Velocity: 0.821
Loss: 0.115 dB/1 m @ 1000 MHz

New Cable

Name: Loss Distance:

Velocity: Loss Frequency:

Loss: Metric units

Save Cancel



Setting	Description
Cable	<p>Select a cable from the drop-down list. You can also click in the Cable field and search for the cable name by typing in the name.</p>  <p>The  icon at the bottom of the drop-down list allows you to clear search results and view the full list again.</p>
Velocity	The velocity factor of the cable.
Loss	The loss per meter at the loss frequency.
New Cable button	Click this button to access the New Cable panel where you can enter and save cable information.
Name	Enter the cable name.
Velocity	Enter the velocity factor of the cable.
Loss	Enter the power. This dB value will be divided by the Loss Distance value to provide the loss per meter at the loss frequency.
Loss Distance	Enter the loss distance in meters or feet.
Loss Frequency	Enter the loss frequency.
Metric Units	Check this box to use metric units for distance.
Save	Click to save the cable. Once saved, the cable name will appear in the Cable drop-down list.

Table continued...

Setting	Description
Cancel	Click to cancel a New Cable entry and close the New Cable panel.

Traces tab - Cable Loss

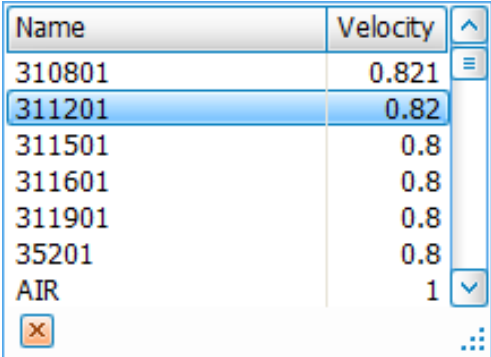
The Traces tab allows you to set the display characteristics of displayed traces.

Setting	Description
Trace	Selects a trace. The selected trace is the source for the displayed measurements (max, min, freq, etc).
Function	Selects the trace processing method. Available settings are: Normal, Average (VRMS), Max Hold, and Min Hold.
Show	Shows / hides the selected trace.
Count	Sets the number of traces averaged to generate the displayed trace. (Present only when Function is not set to Normal.)
Freeze	Halts updates to the selected trace.
Save Trace As	Saves the selected trace to a file for later recall and analysis.
Show recalled trace	Displays a saved trace instead of a live trace.

Trace

Available traces for Cable Loss are: Trace 1, Trace 2, and Trace 3. These traces are based on the input signal and enable you to display the input signal using different processing (Function). For example, you could display Trace 1 with Function set to Normal, Trace 2 with Function set to Max Hold and Trace 3 with Function set to Min Hold.

Function (trace processing)

The Function setting controls how traces are processed to display.

- **Normal** - Each new trace is displayed and then replaced by the next trace. Each data point contains a single vertical value.
- **Avg (VRMS)** [Average V_{RMS}] – Displays the average of measured value of each trace point.
- **Max Hold** - Displays the maximum value in the trace record for each display point. Each new trace's display point is compared to the previous maximum value and the greater value is retained for display and subsequent comparisons.

- **Min Hold** - Displays the minimum value in the trace record for each display point. Each new trace's display point is compared to the previous minimum value and the lesser value is retained for display and subsequent comparisons.

Saving Traces

To save a trace for later analysis:

1. Select the **Save Trace As** button. This displays the Save As dialog box.
2. Navigate to the desired folder or use the default.
3. Type a name for the saved trace and click **Save**.

Recalling Traces

You can recall a previously saved trace for analysis or comparison to a live trace.

To select a trace for recall:

1. Select the trace into which the recalled trace will be loaded, from the Trace drop-down list.
2. Check the **Show** check box in the display.
3. Click the ... button in the Traces tab to display the Open dialog box.

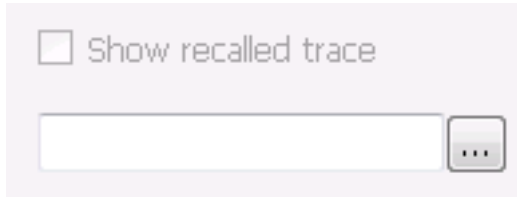

4. Navigate to the desired file and click **Open**.
5. Check the **Show recalled trace** check box in the Traces tab.
6. Verify that the **Show** check box in the display is selected for the trace (either on this tab or next to the drop-down list located at the top-left corner of the graph).

Scale tab - Cable Loss

The Scale tab allows you to change the vertical and horizontal scale settings. Changing the scale settings changes how the trace appears on the display but does not change control settings such as center frequency.

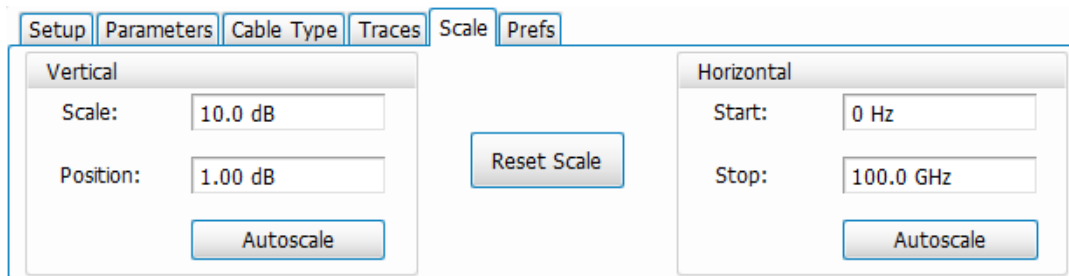

Setting	Description
Vertical	Controls the vertical position and scale of the trace display.
Scale	Sets the vertical scale (overall vertical display range).

Table continued...

Setting	Description
Position	Set the position in the middle of the vertical axis.
Autoscale	Resets the scale of the vertical axis to contain the complete trace.
Reset Scale	Resets both vertical and horizontal scales.
Horizontal	Controls the span of the trace display and position of the trace.
Start	Set the Start frequency. This affects the Start frequency of the measurement.
Stop	Set the Stop frequency. This affects the Stop frequency of the measurement.
Autoscale	Resets the scale of the horizontal axis to contain the complete trace.

Prefs tab - Cable Loss

The Prefs tab enables you to change parameters of the measurement display.

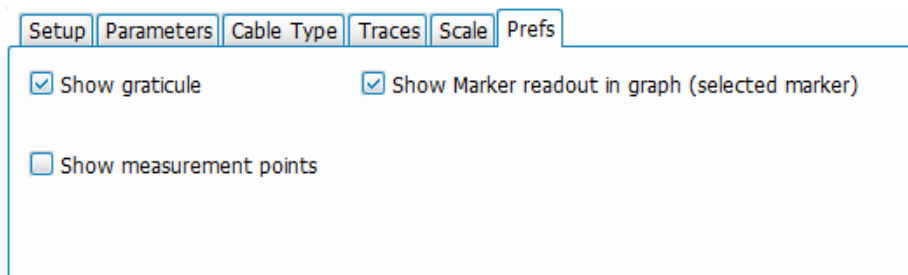

Setup Parameters Cable Type Traces Scale Prefs

Show graticule Show Marker readout in graph (selected marker)

Show measurement points

Setting	Description
Show graticule	Displays or hides the graticule in the display.
Show measurement points	Marks each measurement point on the trace.
Show Marker readout in graph (selected marker)	When a marker is enabled, this setting displays or hides the marker readout, but not the marker itself, on the graph area.

RL/DTF Display Settings



The Settings control panel tabs allow you to change various parameters and settings for the RL/DTF display.

DTF Setup button – RL/DTF

The DTF Setup button allows you to access DTF measurement specific parameters and results information.

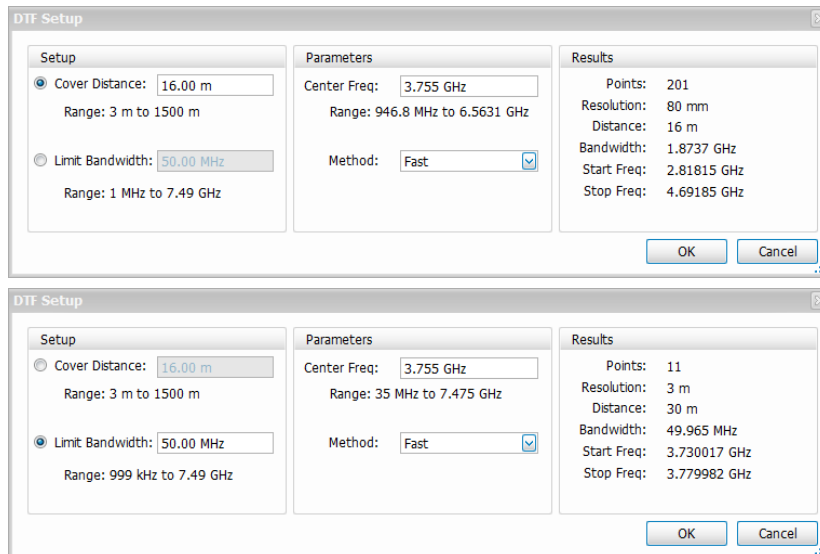

Setting	Description
Cover Distance	Select and specify the length of the cable or the distance to the device under test. This selection is recommended when there are no frequency limitations on the signal path between the analyzer and the system under test.
Range	Shows the possible cable length range in meters as 3 m to 1500 m. Changing the Cover Distance value changes this range. A cable distance of greater than 1500 m would result in attenuation of the signal below the noise floor.
Limit Bandwidth	Select and specify the maximum bandwidth for the measurement. This selection is recommended when frequency-limited devices, such as filters, are in the signal path between the analyzer and the system under test.
Range	Shows the possible bandwidth range when Limit Bandwidth is selected. This range is based on the limits of the analyzer.
Center Freq	Specify the desired center frequency for the measurement.
Range	Shows the possible center frequency range for the measurement.
Method	Select Fast or Normal. If Limit Bandwidth is selected, then you can also choose Long Distance if the measurement points value is below 1500 m. If Cover Distance is selected, then you can also choose High Resolution.
Results	Panel shows the DTF setup values.

Setup - RL/DTF

The Freq Setup tab provides access to frequency settings for the RL/DTF display.

Setup Parameters Cable Type Traces Scale Prefs

Start Freq: 9 kHz

Stop Freq: 3.500 GHz

Points: 201

Setting	Description
Start Freq	The lowest frequency in the measurement.
Stop Freq	The highest frequency in the measurement.
Points	The number of measurement points from start frequency to stop frequency.

Parameters tab - RL/DTF

The Parameters tab allows you to set the output power level and DTF Window view.

Setup Parameters Displays Cable Type Traces Scale Prefs

Output Power Level: High

DTF Window: Nominal Side Lobe

- Nominal Side Lobe
- Rectangular
- Low Side Lobe
- Minimum Side Lobe

Setting	Description
Output Power Level	Select from High and Low output power levels. The High Power Level output is -10 dBm. High power measurements are the default setting and are recommended for measurements of all passive circuits such as cables and filters. The Low Power Level output is -30 dBm. Low power measurements may be needed for testing circuits that have gain and may be compressed if there are high powers input to them.
DTF Window	Select a setting to improve the display of DTF measurements. You can read more about this feature in the How to improve display topic.

Cable Type

Setup Parameters Displays **Cable Type** Traces Scale Prefs

Cable: 310801 New Cable

Velocity: 0.821
Loss: 0.115 dB/1 m @ 1000 MHz

New Cable

Name: Loss Distance: 1.000 m
Velocity: 1 Loss Frequency: 100.0 MHz
Loss: 0.0000 dB Metric units

Save Cancel



Setting	Description
Cable	<p>Select a cable from the drop-down list. You can also click in the Cable field and search for the cable name by typing in the name.</p>  <p>The  icon at the bottom of the drop-down list allows you to clear search results and view the full list again.</p>
Velocity	The velocity factor of the cable.
Loss	The loss per meter at the loss frequency.
New Cable button	Click this button to access the New Cable panel where you can enter and save cable information.
Name	Enter the cable name.
Velocity	Enter the velocity factor of the cable.
Loss	Enter the power. This dB value will be divided by the Loss Distance value to provide the loss per meter at the loss frequency.
Loss Distance	Enter the loss distance in meters or feet.
Loss Frequency	Enter the loss frequency.
Metric Units	Check this box to use metric units for distance.
Save	Click to save the cable. Once saved, the cable name will appear in the Cable drop-down list.

Table continued...

Setting	Description
Cancel	Click to cancel a New Cable entry and close the New Cable panel.

Displays tab - RL/DTF

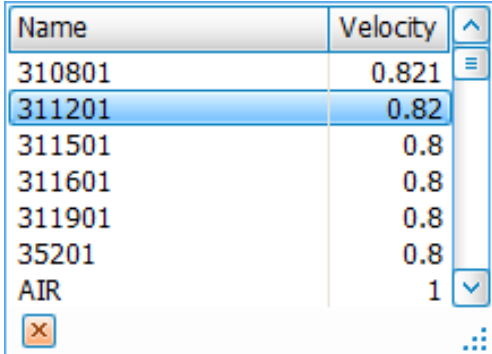
Setting	Description
Show Displays	Select to show Display 1 only, Display 2 only, or both displays simultaneously.
Display 1	Select which display type you want to appear in Display 1. You can select Return Loss or VSWR.
Display 2	Select which display type you want to appear in Display 2. You can select DTF/Return Loss or DTF/VSWR.

Traces tab - RL/DTF

The Traces tab allows you to set the display characteristics of displayed traces.

Setting	Description
Trace	Selects a trace.
Show	Shows / hides the selected trace.

Table continued...

Setting	Description
Function	Selects the trace processing method. Available settings are: Normal, Average (VRMS), Max Hold, and Min Hold.
Count	Sets the number of traces averaged to generate the displayed trace. (Present only when Function is set to anything but Normal.)
Freeze	Halts updates to the selected trace.
Save Trace As	Saves the selected trace to a file for later recall and analysis.
Show recalled trace	Displays a saved trace instead of a live trace.

Trace

Available traces for the RL/DTF display are: DTF Trace 1, DTF Trace 2, and DTF Trace 3. These traces are based on the input signal and enable you to display the input signal using different processing (Function). For example, you could display DTF Trace 1 with Function set to Normal, DTF Trace 2 with Function set to Max Hold and DTF Trace 3 with Function set to Min Hold.

Function (trace processing)

The Function setting controls how traces are processed to display.

- **Normal** - Each new trace is displayed and then replaced by the next trace. Each data point contains a single vertical value.
- **Avg (VRMS)** [Average V_{RMS}] – Each point on the trace is the result of determining the RMS Voltage value for all of the IQ samples available to the trace point. When the averaging function is applied to a trace, the averaging is performed on the linear (Voltage) values, resulting in the correct average for RMS values.
- **Max Hold** - Displays the maximum value in the trace record for each display point. Each new trace's display point is compared to the previous maximum value and the greater value is retained for display and subsequent comparisons.
- **Min Hold** - Displays the minimum value in the trace record for each display point. Each new trace's display point is compared to the previous minimum value and the lesser value is retained for display and subsequent comparisons.
- **Avg (of logs)** – In the process of measuring signal level, the result is converted to Watts and then to dBm. Averaging is then applied to the resultant traces.

Saving Traces

To save a trace for later analysis:

1. Select the **Save Trace As** button. This displays the Save As dialog box.
2. Navigate to the desired folder or use the default.
3. Type a name for the saved trace and click **Save**.

Recalling Traces

You can recall a previously saved trace for analysis or comparison to a live trace.

To select a trace for recall:

1. Select the trace into which the recalled trace will be loaded, from the Trace drop-down list
2. Click the ... button in the Traces tab to display the Open dialog box.
3. Navigate to the desired file and click **Open**.
4. Check the **Show recalled trace** check box in the Traces tab.

- Verify that the **Show** check box in the display is selected for the trace (either on this tab or next to the drop-down list located at the top-left corner of the graph).

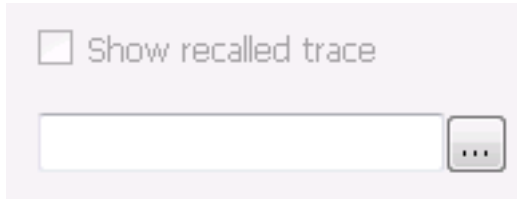

Scale tab - RL/DTF

The Scale tab allows you to change the vertical and horizontal scale settings. The content on this tab changes depending on which displays are active. Changing the scale settings changes the measurement parameters. This is different than Spectrum displays, for example, where the scale controls allow you to zoom without changing the underlying measurement. Also note that you may still right click in the measurement window and zoom the horizontal display without impacting the underlying RL/DTF measurement settings.

The following image shows the Scale tab when Return Loss is selected for Display 1 and viewing is set to Display 1 only.

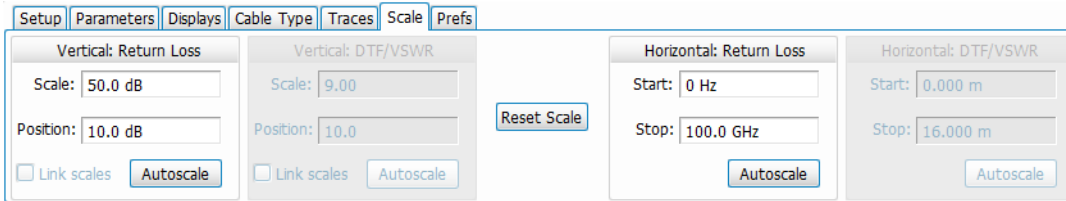

The following image shows the Scale tab when VSWR is selected for both displays and viewing is set to both displays.

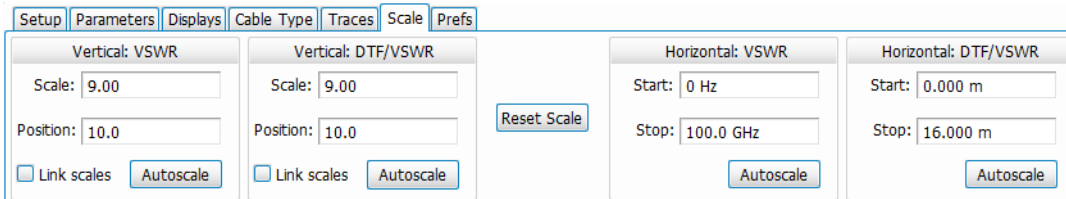

The following image shows the Scale tab when both VSWR is selected for Display 1 and Return Loss is selected for Display 2.

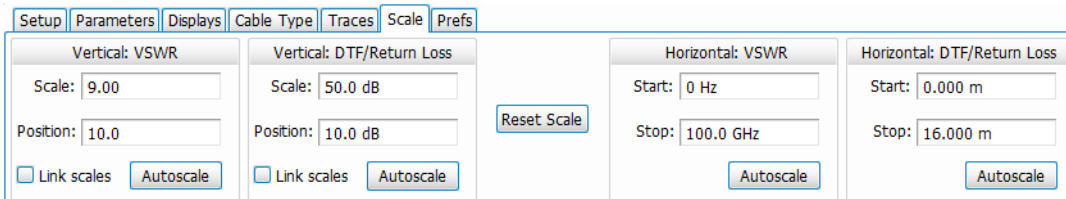

Setting	Description
Vertical	Controls the vertical position and scale of the trace display.
Scale	Sets the vertical scale (overall vertical display range).
Position	Set the vertical position (top of measurement scale for vertical display).

Table continued...

Setting	Description
Autoscale	Resets the scale of the vertical axis to contain the complete trace.
Link scales	Check this box to link vertical scale in both displays. This selection works when Both is the display view selection and both displays are set to either Return Loss or VSWR.
Reset Scale	Resets both vertical and horizontal scales.
Horizontal	Controls the span of the trace display and position of the trace.
Start	Set the measurement Start frequency.
Stop	Set the measurement Stop frequency.
Autoscale	Resets the scale of the horizontal axis to contain the complete trace.

Prefs tab - RL/DTF

The Prefs tab enables you to change parameters of the measurement display.

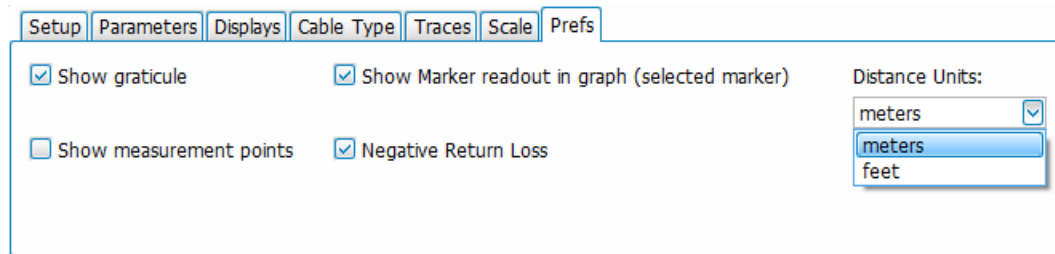

Setting	Description
Show measurement points	Marks each measurement point on the trace.
Show graticule	Displays or hides the graticule in the display.
Show Marker readout in graph (selected marker)	When a marker is enabled, this setting displays or hides the marker readout, but not the marker itself, on the graph area.
Distance Units	Sets units to meters or feet.

WLAN Measurements

WLAN Measurements Overview

The WLAN Analysis option allows you to evaluate WLAN signals, performing standards based transmitter measurements in the time, frequency, and modulation domains. WLAN measurements can be made on signals defined by 802.11a/b/g/j/n/p (standard IEEE 802.11-2012) and 802.11ac (draft IEEE P802.11ac-D4.0 or later). User controls allow you to modify signal parameters for analysis of signals. The analysis results give multiple views of WLAN signal characteristics to allow the diagnosis of signal imperfections and impairments quickly and easily. Display controls allow you to selectively display the analysis results to help locate trouble-spots in the signal.

WLAN Standards

The following options support the given standards:

- **Option SV23:** Supports IEEE 802.11a, g, j, and p OFDM signals and 802.11b DSSS/CCK signals
- **Option SV24:** Supports IEEE 802.11n signals with bandwidths of 20 MHz and 40 MHz
- **Option SV25:** Supports IEEE 802.11ac signals with bandwidths of 20, 40, 80, and 160 MHz

WLAN Standards Presets

The **Standards Presets** button located on the WLAN Settings Control Panel allows you to recall preconfigured displays for the standards and bandwidths that you select. You can also access these presets from **Presets** on the display menu bar. You can read more information about the [Standards Presets](#).

The following table shows the center frequency and displays that are automatically loaded for each of the listed standards and bandwidths. SEM masks are also loaded and are explained [here](#).

Table 17: WLAN presets standards, bandwidths, center frequencies, and displays

Standard	Bandwidth (MHz)	Center frequency (GHz)	Displays loaded
802.11a	20	5.18	SEM, Time Overview, WLAN Constellation, WLAN Summary
802.11g	20	2.412	
802.11j	10	5.18	
	20		
802.11p	5	5.8	
	10		
	20		
802.11n	20	2.412	
	40		
802.11ac	20	5.18	
	40	5.19	
	80	5.21	
	160	5.25	
802.11b		2.412	

SEM mask parameters. The SEM wireless standard masks that are applied to the WLAN signal depend on the standard you select when you configure the preset. Once you select a standard and bandwidth, the application will automatically load the mask that best fits the signal for which the standard applies. All mask parameters are derived from IEEE standards and loaded for you. This provides you the assurance that you are evaluating the signal with the most appropriate mask.

WLAN Displays

The displays in WLAN Analysis (Setup > Displays > Measurements) are:

- [SEM](#)
- [WLAN Channel Response](#)
- [WLAN Constellation](#)
- [WLAN EVM](#)
- [WLAN Magnitude Error](#)
- [WLAN Phase Error](#)
- [WLAN Power versus Time](#)
- [WLAN Spectral Flatness](#)

- [WLAN Summary](#)

WLAN Channel Response Display

The WLAN Channel Response display plots the channel response (magnitude and phase) versus the subcarrier or frequency. Here, the channel refers to all sources of signal frequency response impairment up to the analyzer input, including the transmitter itself, as well as any transmission medium through which the signal travels between the transmitter and the analyzer.



Note: WLAN Channel Response is only available for OFDM (non-802.11b) signals.

To show the WLAN Channel Response display:

1. If you are analyzing a stored data file, recall the data file now. Otherwise, go to the next step.
2. Press the **Displays** button or select **Setup > Displays**.
3. In the **Select Displays** dialog, select **WLAN Analysis** in the **Measurements** box.
4. In the Available displays box, double-click the **WLAN Chan Response** icon or select the icon and click **Add**. The WLAN Chan Response icon will appear in the **Selected displays** box and will no longer appear under Available displays.
5. Click **OK** to show the WLAN Chan Response display.
6. Set the Frequency appropriate for the signal.
7. Select **Setup > Settings** to display the control panel.
8. Select the Modulation Params tab. Set the Standard, Guard Interval, Subcarrier Spacing, and Bandwidth controls as appropriate for the input signal.
9. If you are analyzing a data file, press the **Replay** button to take measurements on the recalled acquisition data file.

Elements of the Display

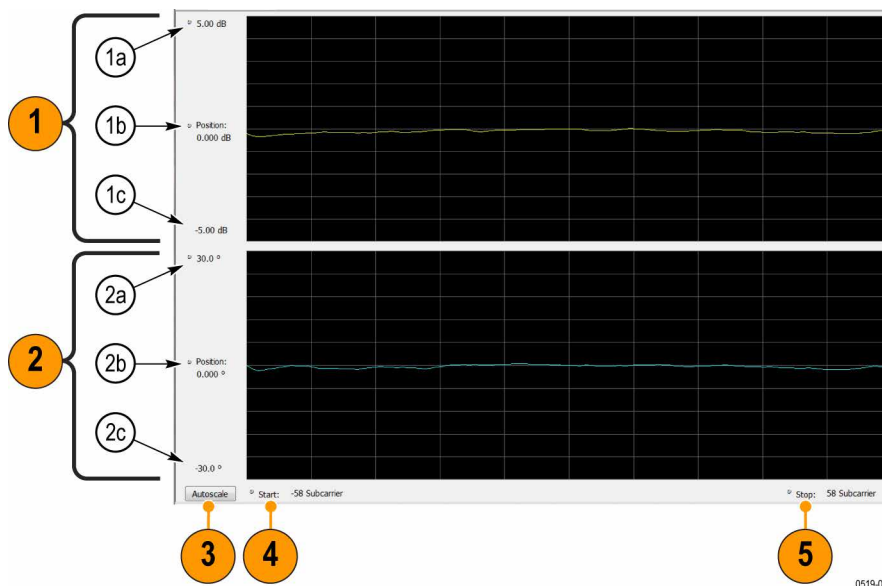

Item	Display element	Description
1	Magnitude graph (top graph)	

Table continued...

Item	Display element	Description
1a	Top of graph	Sets the level that appears at the top of the magnitude graph. This is only a visual control for panning the graph. The Reference Level is adjusted in the Toolbar and the Ampl control panel. By default, Vert Position = Ref Level.
1b	Position (dB)	Sets the vertical position value. The maximum value is 20.00 dB. The readout indicates the subcarrier (for non-b standards only) or frequency shown at the bottom of the display.
1c	Bottom of graph readout	Indicates the magnitude at the bottom of the top graph. This value changes with the dB and vertical Position settings.
2	Phase graph (bottom graph)	
2a	Top of graph	Sets the phase value indicated at the top of the graph. Since the Position value at the vertical center of this graph remains constant as the Top of Graph value is adjusted, the Vertical Scale increases as the Top of Graph value increases, which also affects the bottom of graph readout.
2b	Position (°)	Specifies the phase shown at the center of the graph display. Changing this value moves the trace up and down in the graph, which affects the Top of Graph and Bottom of Graph values as well.
2c	Bottom of bottom graph readout	Indicates the phase at the bottom of the bottom graph. This value changes with the Position setting.
3	Autoscale	Adjusts the Vertical and Horizontal scaling to optimize the trace display on screen.
4	Start (Position)	Shifts the trace left or right in the graph. The readout indicates the subcarrier (for non-b standards only) or frequency shown at the left edge of the display.
5	Stop (Scale)	Specifies the number of subcarriers (for non-b standards only) shown in the graph.

WLAN Channel Response Settings

The WLAN Channel Response Settings control panel provides access to settings that control parameters of the Channel Response Display.

Settings tab	Description
Modulation Params	Specifies the input signal standard and additional user-settable signal parameters.
Analysis Params	Specifies parameters used by the instrument to analyze the input signal.
Data Range Tab	Specifies which symbols and subcarriers of the signal to display.
Table continued...	

Settings tab	Description
Analysis Time Tab	Specifies parameters that define the portion of the acquisition record that is used for analysis. Also allows you to specify the time units (Symbols or Seconds) for WLAN Analysis displays.
Traces Tab	Enables you to select from magnitude or phase trace, save a trace, and recall an trace
Scale Tab	Specifies the Zoom scale, and vertical and horizontal positions of the display.
Prefs Tab	Specifies the units of the display and whether elements of the graphs are displayed.

WLAN Constellation Display

The WLAN Constellation Display shows the WLAN signal modulation amplitude and phase in I (horizontal) versus Q (vertical) form. For multicarrier WLAN OFDM signals, the points show all data symbol subcarriers' modulation. For single-carrier 802.11b, each point corresponds to a single modulated chip.

To show the WLAN Constellation display:

1. If you are analyzing a stored data file, recall the data file now. Otherwise, go to the next step.
2. Press the **Displays** button or select **Setup > Displays**.
3. In the **Select Displays** dialog, select **WLAN Constellation** in the **Measurements** box.
4. In the Available displays box, double-click the **WLAN Constellation** icon or select the icon and click **Add**. The WLAN Constellation icon will appear in the **Selected displays** box and will no longer appear under Available displays.
5. Click **OK** to show the WLAN Constellation display.
6. Set the **Frequency** appropriate for the signal.
7. Select **Setup > Settings** to display the control panel.
8. Select the **Modulation Params** tab. Set the Standard, Guard Interval, Channel Bandwidth, and Subcarrier Spacing controls as appropriate for the input signal.
9. If you are analyzing a data file, press the **Replay** button to take measurements on the recalled acquisition data file.

Elements of the Display

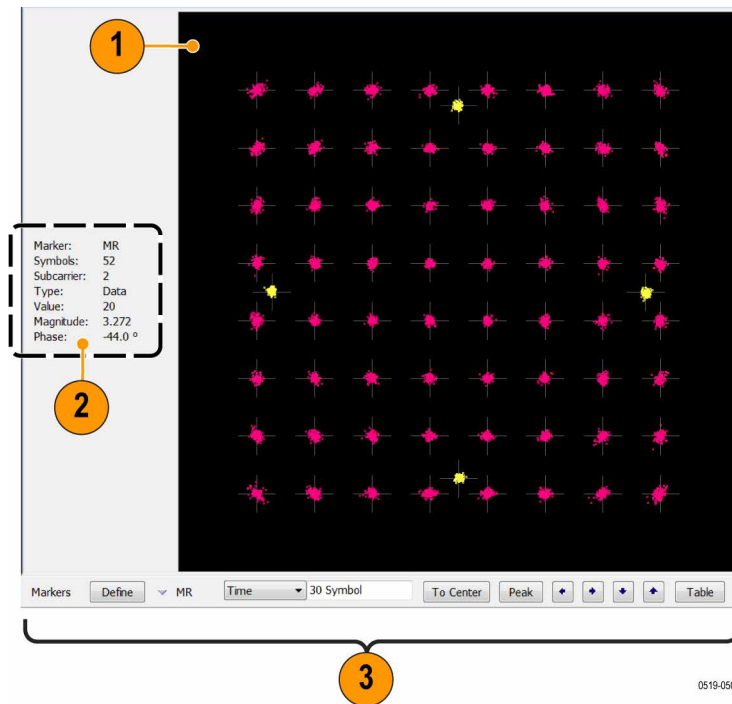

Item	Display element	Description
1	Plot	Constellation graph.
2	Marker readout	If markers are enabled, the marker readout shows the selected Marker, Symbol, Subcarrier, Type, Value, Magnitude, and Phase for the symbol at the marker location. Located to the left of the constellation plot or below it, depending on the size of the window.
3	Marker controls	Define and position markers.

WLAN Constellation Settings

Main menu bar: Setup > Settings

Favorites toolbar: 

The WLAN Constellation Settings control panel provides access to settings that control parameters of the Constellation Display.

Settings tab	Description
Modulation Params	Specifies the input signal standard and additional user-settable signal parameters.
Analysis Params	Specifies parameters used by the instrument to analyze the input signal.

Table continued...

Settings tab	Description
Data Range	Specifies which symbols and subcarriers of the signal to display.
Analysis Time Tab	Specifies parameters that define the portion of the acquisition record that is used for analysis. Also allows you to specify the Units (Symbols or Seconds) for WLAN Analysis displays.
Trace Tab	Enables you to freeze the display or hide the measurement or average trace.
Scale Tab	Specifies the Zoom scale, and vertical and horizontal positions of the display.
Prefs Tab	Specifies the units of the display and whether elements of the graphs are displayed.

WLAN EVM Display

The WLAN EVM display shows the data symbols' individual subcarrier Error Vector Magnitude values versus symbol interval (time) and subcarrier (frequency).



Note: For 802.11b analysis, the subcarrier graph is not displayed.

To show the WLAN EVM display:

1. If you are analyzing a stored data file, recall the data file now. Otherwise, go to the next step.
2. Press the **Displays** button or select **Setup > Displays**.
3. In the **Select Displays** dialog, select **WLAN EVM** in the **Measurements** box.
4. In the Available displays box, double-click the **WLAN EVM** icon or select the icon and click **Add**. The WLAN EVM icon will appear in the **Selected displays** box and will no longer appear under Available displays.
5. Click **OK** to show the WLAN EVM display.
6. Set the **Frequency** appropriate for the signal.
7. Select **Setup > Settings** to display the control panel.
8. Select the **Modulation Params** tab. Set the Standard as appropriate. Set the Standard, Guard Interval, Channel Bandwidth, and Subcarrier Spacing controls as appropriate for the input signal.
9. If you are analyzing a data file, press the **Replay** button to take measurements on the recalled acquisition data file.

Elements of the Display

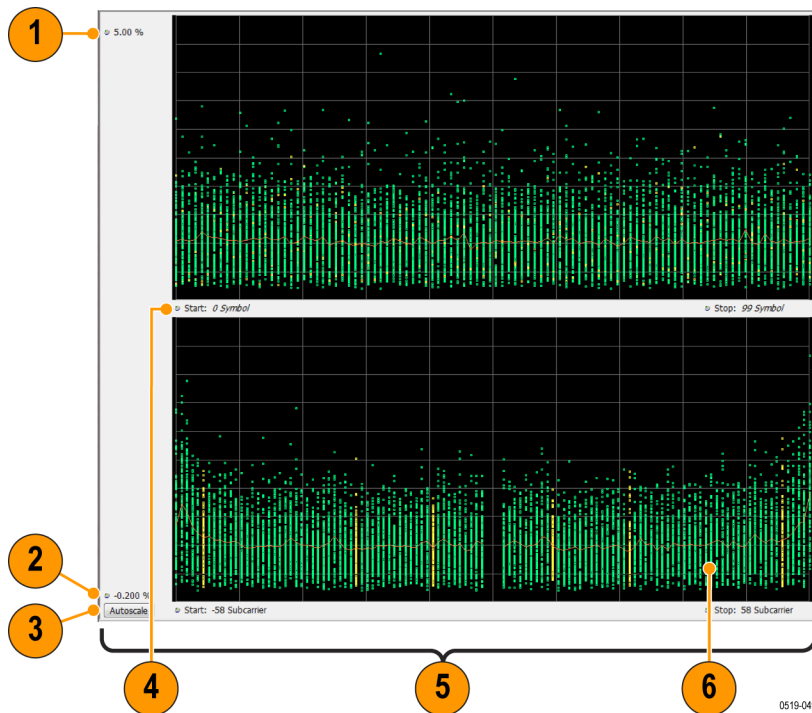

Item	Display element	Description
1	Top of graph	Sets the EVM value that appears at the top of the graph. This is only a visual control for panning the graph.
2	Bottom of graph	Sets the EVM value that appears at the bottom of the graph. This is only a visual control for panning the graph.
3	Autoscale	Adjusts the vertical and horizontal settings to provide the best display.
4	Start (Position)	Specifies the horizontal position of the trace on the graph display.
5	Stop (Scale)	Adjusts the horizontal range of the graph. By decreasing the scale, the graph essentially becomes a window that you can move over the analysis results by adjusting the position.

WLAN EVM Settings

Main menu bar: Setup > Settings

Favorites toolbar: 

The settings for the WLAN EVM display are shown in the following table.

Settings tab	Description
Modulation Params	Specifies the type of modulation used for the input signal and other parameters.
Analysis Params	Specifies parameters used by the instrument to analyze the input signal.
Data Range	Specifies which symbols and subcarriers of the signal to display.
Analysis Time	Specifies parameters that define the portion of the acquisition record that is used for analysis. Also allows you to specify the Units (Symbols or Seconds) for WLAN Analysis displays.
Trace	Enables you to freeze the display or hide the measurement or average trace.
Scale	Specifies the vertical, subcarrier (for non-b standards only) and symbols scale and position settings.
Prefs	Specifies the units of the display and whether elements of the graphs are displayed.

WLAN Magnitude Error Display

The WLAN Magnitude Error display shows the data symbols' individual subcarrier Magnitude Error values versus symbol interval (time) and subcarrier (frequency).



Note: For 802.11b analysis, the subcarrier graph is not displayed.

To show the WLAN Magnitude Error display:

1. If you are analyzing a stored data file, recall the data file now. Otherwise, go to the next step.
2. Press the **Displays** button or select **Setup > Displays**.
3. In the **Select Displays** dialog, select **WLAN Analysis** in the **Measurements** box.
4. In the Available displays box, double-click the **WLAN Mag Error** icon or select the icon and click **Add**. The WLAN Mag Error icon will appear in the **Selected displays** box and will no longer appear under Available displays.
5. Click **OK** to show the WLAN Mag Error display.
6. Set the **Frequency** appropriate for the signal.
7. Select **Setup > Settings** to display the control panel.
8. Select the **Modulation Params** tab. Set the Standard, Guard Interval and Spacing and Bandwidth controls as appropriate for the input signal.
9. If you are analyzing a data file, press the **Replay** button to take measurements on the recalled acquisition data file.

Elements of the Display

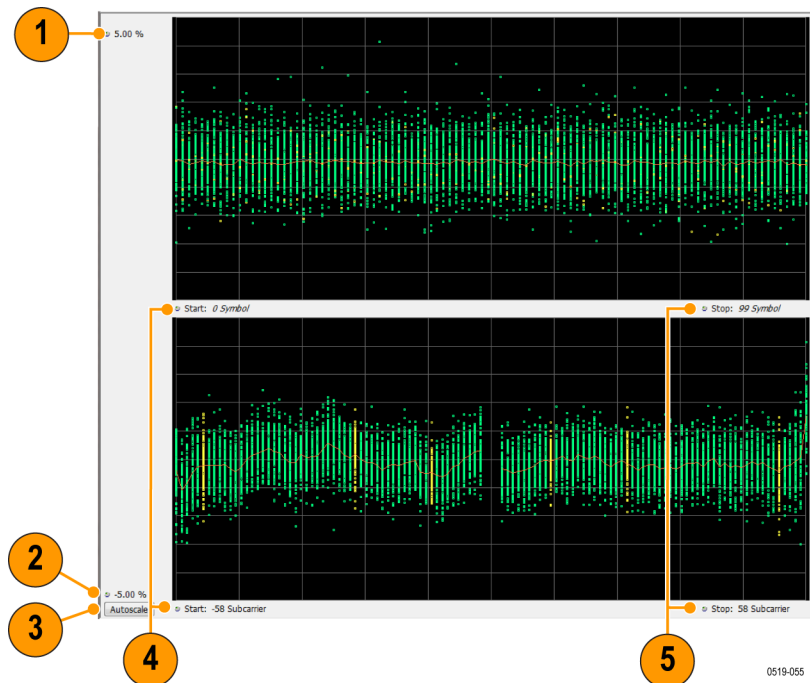

Item	Display element	Description
1	Top of graph	Sets the Magnitude Error value that appears at the top of the graph. This is only a visual control for panning the graph.
2	Bottom of graph	Sets the Magnitude Error value that appears at the bottom of the graph. This is only a visual control for panning the graph.
3	Autoscale	Adjusts the vertical and horizontal settings to provide the best display.
4	Pos	Specifies the horizontal position of the trace on the graph display.
5	Scale	Adjusts the horizontal range of the graph. By decreasing the scale, the graph essentially becomes a window that you can move over the analysis results by adjusting the position.

WLAN Magnitude Error Settings

Main menu bar: Setup > Settings



The settings for the WLAN Mag Error display are shown in the following table.

Settings tab	Description
Modulation Params	Specifies the type of modulation used for the input signal and other parameters.
Analysis Params	Specifies parameters used by the instrument to analyze the input signal.
Data Range	Specifies which symbols and subcarriers of the signal to display.
Analysis Time Tab	Specifies parameters that define the portion of the acquisition record that is used for analysis. Also allows you to specify the Units (Symbols or Seconds) for WLAN Analysis displays.
Trace	Enables you to display or hide the measurement or average trace.
Scale Tab	Specifies the vertical, subcarrier (for non-b standards only), and symbols scale and position settings.
Prefs Tab	Specifies the units of the display and whether elements of the graphs are displayed.

WLAN Phase Error Display

The WLAN Phase Error display shows the data symbols' individual subcarrier Phase Error values versus symbol interval (time) and subcarrier (frequency).



Note: For 802.11b analysis, the subcarrier graph is not displayed.

To show the WLAN Phase Error display:

1. If you are analyzing a stored data file, recall the data file now. Otherwise, go to the next step.
2. Press the **Displays** button or select **Setup > Displays**.
3. In the **Select Displays** dialog, select **WLAN Analysis** in the **Measurements** box.
4. In the Available displays box, double-click the **WLAN Phase Error** icon or select the icon and click **Add**. The WLAN Phase Error icon will appear in the **Selected displays** box and will no longer appear under Available displays.
5. Click **OK** to show the WLAN Phase Error display.
6. Set the **Frequency** appropriate for the signal.
7. Select **Setup > Settings** to display the control panel.
8. Select the **Modulation Params** tab. Set the Standard, Guard Interval and Spacing and Bandwidth controls as appropriate for the input signal.
9. If you are analyzing a data file, press the **Replay** button to take measurements on the recalled acquisition data file.

Elements of the Display

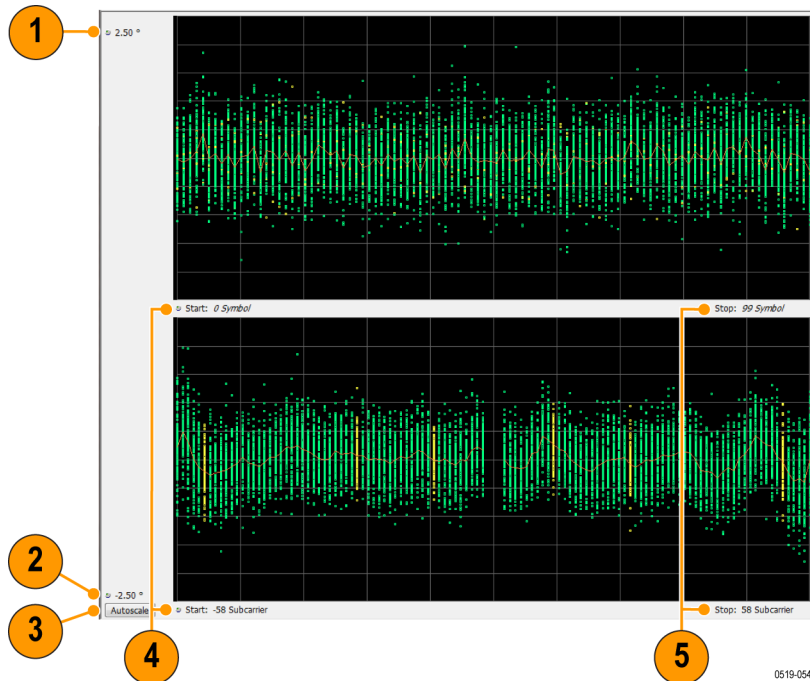

Item	Display element	Description
1	Top of graph	Sets the Phase Error value that appears at the top of the graph. This is only a visual control for panning the graph.
2	Bottom of graph	Sets the Phase Error value that appears at the bottom of the graph. This is only a visual control for panning the graph.
3	Autoscale	Adjusts the vertical and horizontal settings to provide the best display.
4	Pos	Specifies the horizontal position of the trace on the graph display.
5	Scale	Adjusts the horizontal range of the graph. By decreasing the scale, the graph essentially becomes a window that you can move over the analysis results by adjusting the position.

WLAN Phase Error Settings

Main menu bar: Setup > Settings



The settings for the WLAN Phase Error display are shown in the following table.

Settings tab	Description
Modulation Params	Specifies the type of modulation used for the input signal and other parameters.
Analysis Params	Specifies parameters used by the instrument to analyze the input signal.
Data Range	Specifies which symbols and subcarriers of the signal to display.
Analysis Time Tab	Specifies parameters that define the portion of the acquisition record that is used for analysis. Also allows you to specify the Units (Symbols or Seconds) for WLAN Analysis displays.
Trace	Enables you to display or hide the measurement or average trace.
Scale Tab	Specifies the vertical, subcarrier (for non-b standards only), and symbols scale and position settings.
Prefs Tab	Specifies the units of the display and whether elements of the graphs are displayed.

WLAN Power vs Time Display

The WLAN Power vs Time display shows the signal power amplitude versus time. For 802.11b signals, the packet Power-On and Power-Down ramp times are also measured.

To show the WLAN Power vs Time display:

1. If you are analyzing a stored data file, recall the data file now. Otherwise, go to the next step.
2. Press the **Displays** button or select **Setup > Displays**.
3. In the **Select Displays** dialog, select **WLAN Analysis** in the **Measurements** box.
4. In the Available displays box, double-click the **WLAN Power vs Time** icon or select the icon and click **Add**. The WLAN Power vs Time icon will appear in the **Selected displays** box and will no longer appear under Available displays.
5. Click **OK** to show the WLAN Power vs Time display.
6. Set the **Frequency** appropriate for the signal.
7. Select **Setup > Settings** to display the control panel.
8. Select the **Modulation Params** tab. Set the Standard, Guard Interval and Spacing and Bandwidth controls as appropriate for the input signal.
9. If you are analyzing a data file, press the **Replay** button to take measurements on the recalled acquisition data file.

Elements of the Display



Item	Display element	Description
1	Top of graph, first setting	Sets the Power level that appears at the top of the graph, in dBm. This is only a visual control for panning the graph.
(not shown)	Units	Sets the global amplitude units for all the views in the analysis window. This will change the amplitude selection in the Units tab of the Amplitude control panel.
2	Top of graph, second setting	Sets the vertical Scale of the graphs, in dB/div. This is only a visual control for panning the graph.
3	View	Selects the specific view of the packet burst within the display: <ul style="list-style-type: none"> - Full Burst displays the entire packet, with vertical lines indicating length of the packet - Rising Edge zooms the display into the interval around the packet rising edge, with vertical lines indicating the 10% to 90% Power-On Ramp time - Falling Edge zooms the display into the interval around the packet falling edge, with vertical lines indicating the 90% to 10% Power-Down Ramp time
4	Bottom of graph readout	Shows the Power level at the bottom of the graph in dBm.
5	Autoscale	Adjusts the vertical and horizontal settings to provide the best display.
6	Bottom of graph, left side	Sets the starting time of the graph in seconds
7	Bottom of graph, right side	Sets the scale (width) of the graph in seconds

Table continued...

Item	Display element	Description
8	Table below graph	<ul style="list-style-type: none"> - Burst Power: Average power of the burst packet, in dBm - Burst Width: Measured time width of the burst packet from Power-On to Power-Down (or end of waveform, if that occurs before Power-Down), in seconds <p> Note: Power-On Ramp Time and Power-Down Ramp Time values are only available for 802.11b analysis.</p> <ul style="list-style-type: none"> - Power-On Ramp Time: Time interval for signal level to increase from 10% to 90% of maximum packet power, in seconds - Power-Down Ramp Time: Time interval for signal level to decrease from 90% to 10% of maximum packet power, in seconds. This value is not available if the analysis record does not include the packet power-down portion.

WLAN Power vs Time Settings

Main menu bar: Setup > Settings



The settings for the WLAN Power vs Time display are shown in the following table.

Settings tab	Description
Modulation Params	Specifies the type of modulation used for the input signal and other parameters.
Analysis Params	Specifies parameters used by the instrument to analyze the input signal.
Data Range	Specifies which symbols and subcarriers of the signal to display.
Analysis Time	Specifies parameters that define the portion of the acquisition record that is used for analysis. Also allows you to specify the Units (Symbols or Seconds) for WLAN Analysis displays.
Scale	Specifies the vertical, subcarrier (for non-b standards only), and symbols scale and position settings.
Prefs	Specifies the units of the display and whether elements of the graphs are displayed.

WLAN Spectral Flatness Display

The WLAN Spectral Flatness display shows the average power levels of subcarriers across the signal bandwidth and indicates if they remain within the limits defined for a particular standard.

The averaged subcarrier level is shown as a line on the display, while the individual subcarrier levels are shown as points. The Pass or Fail result indicates whether the average line remains between the upper and lower limit mask boundaries.



Note: WLAN Spectral Flatness is only available for OFDM (non-802.11b) signals.

To show the WLAN Spectral Flatness display:

1. If you are analyzing a stored data file, recall the data file now. Otherwise, go to the next step.
2. Press the **Displays** button or select **Setup > Displays**.
3. In the **Select Displays** dialog, select **WLAN Analysis** in the **Measurements** box.
4. In the Available displays box, double-click the **WLAN Flatness** icon or select the icon and click **Add**. The WLAN Flatness icon will appear in the **Selected displays** box and will no longer appear under Available displays.
5. Click **OK** to show the WLAN Flatness display.
6. Set the **Frequency** appropriate for the signal.
7. Select **Setup > Settings** to display the control panel.
8. Select the **Modulation Params** tab. Set the Standard, Guard Interval, Subcarrier Spacing, and Channel Bandwidth controls as appropriate for the input signal.
9. If you are analyzing a data file, press the **Replay** button to take measurements on the recalled acquisition data file.

Elements of the Display

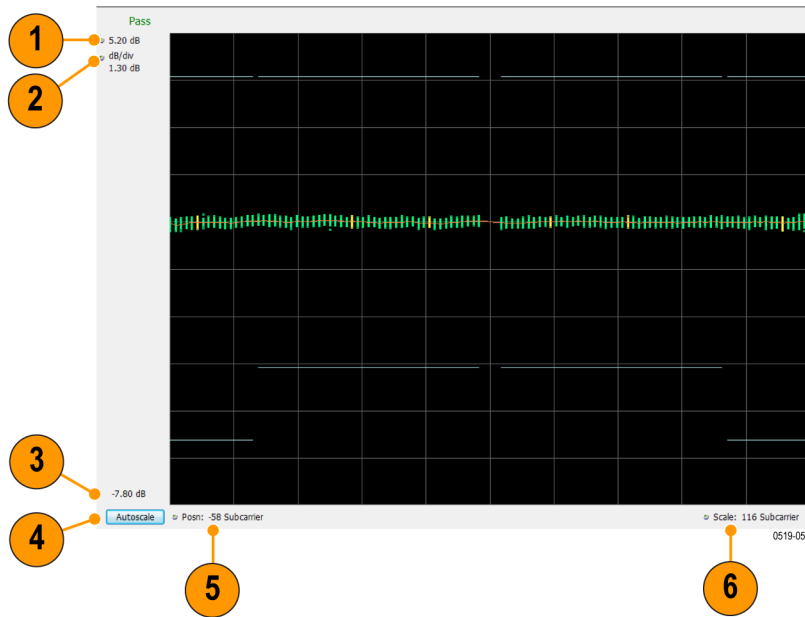

Item	Display element	Description
1	Top of graph, first setting	Sets the Flatness value that appears at the top of the graph in dB. This is only a visual control for panning the graph.
2	Top of graph, second setting	Sets the lower range of the Flatness value that appears at the top of the graph in dB/div. This is only a visual control for panning the graph.
3	Bottom of graph	Shows the Flatness value set at the bottom of the graph.
4	Autoscale	Adjusts the vertical and horizontal settings to provide the best display.
5	Posn	Specifies the horizontal position of the trace on the graph display.

Table continued...

Item	Display element	Description
6	Scale	Adjusts the horizontal range of the graph. By decreasing the scale, the graph essentially becomes a window that you can move over the analysis results by adjusting the position.

WLAN Spectral Flatness Settings

Main menu bar: **Setup > Settings**

Favorites toolbar: 

The settings for the WLAN Spectral Flatness display are shown in the following table.

Settings tab	Description
<i>Modulation Params</i>	Specifies the type of modulation used for the input signal and other parameters.
<i>Analysis Params</i>	Specifies parameters used by the instrument to analyze the input signal.
<i>Data Range</i>	Specifies which symbols and subcarriers of the signal to display.
<i>Analysis Time Tab</i>	Specifies parameters that define the portion of the acquisition record that is used for analysis.  Note: The Units control on this tab only affects the Analysis Length (AFAIK). Use the Units control in the Prefs tab to affect the displays.
<i>Trace</i>	Enables you to display or hide the measurement or average trace.
<i>Scale Tab</i>	Specifies the vertical, subcarrier (for non-b standards only), and symbols scale and position settings.
<i>Prefs Tab</i>	Specifies the units of the display and whether elements of the graphs are displayed.

WLAN Summary Display

The WLAN Summary display shows several measurements of WLAN signal quality. The summary display and its contents will vary by standard selected. Not all of the display contents are provided in this section.

To show the WLAN Summary display:

1. If you are analyzing a stored data file, recall the data file now. Otherwise, go to the next step.
2. Press the **Displays** button or select **Setup > Displays**.
3. In the **Select Displays** dialog, select **WLAN Analysis** in the **Measurements** box.
4. In the Available displays box, double-click the **WLAN Summary** icon or select the icon and click **Add**. The WLAN Summary icon will appear in the **Selected displays** box and will no longer appear under Available displays.
5. Click **OK** to show the WLAN Summary display.
6. Set the **Frequency** appropriate for the signal.
7. Select **Setup > Settings** to display the control panel.

8. Select the **Modulation Params** tab. Set the Standard, Guard Interval and Spacing and Bandwidth controls as appropriate for the input signal.
9. If you are analyzing a data file, press the **Replay** button to take measurements on the recalled acquisition data file.

WLAN Summary Display for 802.11a/g/j/p/n/ac Signals

Standard: 802.11n Bandwidth: 40 MHz Guard Interval: Auto from SIG Clear

Burst Power: -0.01 dBm	Peak-to-Average: 9.80 dB	L-SIG Data	Parity: Pass
Burst Index: 1	IQ Origin Offset: -82.25 dB	Rate: 13	Reserved: 0
Frequency Error: -140.27 mHz	Common Pilot Error: 0.337 %	Length: 312	Parity: 1
Symbol Clk Error: -0.070 ppm		Tail: 0	

EVM			
	All	Pilots	Data
RMS	-39.91 dB	-40.40 dB	-39.89 dB
Peak	-27.33 dB	-31.09 dB	-27.33 dB
Pk@Sym/Sub	32 / 58	85 / 53	32 / 58
Avg RMS	-39.91 dB		
	1 of 1 Bursts		
Max RMS	-39.91 dB		

HT-SIG Data			
	MCS	CBW	CRC: Pass
Length	672	Smoothing	0
Not Sound	0	Reserved	1
Aggregation	0	STBC	0
FEC Coding	0	Short GI	0
Ness	0	CRC	1
Tail	0		

Packet Format: HT_MF		Data Modulation: BPSK	
		Guard Interval: 1/4	
	Symbols	EVM	Avg Power
L-STF	2	-44.57 dB	0.00 dBm
L-LTF	2	-40.02 dB	-0.01 dBm
L-SIG	1	-40.43 dB	-0.26 dBm
HT-SIG	2	-40.34 dB	-0.47 dBm
HT-STF	1	-44.08 dB	-0.01 dBm
HT-LTF	1	-42.43 dB	0.00 dBm
Data	100	-39.91 dB	0.01 dBm

Elements of the Display for 802.11a/g/j/p/n/ac Signals

Table 18:

Measurement	Description
Standard	Display of the standard selected on the Setup > Settings > Modulation Params tab.
Bandwidth	Display of the channel bandwidth selected on Setup > Settings > Modulation Parameters tab.
Burst Power	The average power of all symbols in the packet, including Preamble and Data segments.
Peak-to-Average	The ratio of the highest instantaneous signal power level to the average signal power.
Burst Index	The index of the analyzed packet within the analysis record.
IQ Origin Offset	The average magnitude of the DC subcarrier level relative to total signal power. It indicates the level of carrier feedthrough detected at the center (DC) subcarrier.
Frequency Error	The frequency difference between the measured carrier frequency of the signal and the measurement frequency setting.
Common Pilot Error	The RMS magnitude error of the pilots over all data symbols.
Symbol Clk Error	The symbol clock error in parts per million.

Table continued...

Measurement	Description
EVM	<p>The RMS and Peak values of the normalized subcarrier Error Vector Magnitude values. The normalized subcarrier EVM values are calculated as the difference between the detected received signal subcarrier constellation points and ideal reference points estimated by the instrument from the received signal. Values are reported in units of percent or dB. Peak values include the symbol and subcarrier location.</p> <p>RMS and Peak values are displayed for groupings of all subcarriers, Pilots only and Data only. Results are calculated over all Data symbols in the packet.</p> <p>Average RMS and Peak RMS values are accumulated over multiple packet analysis cycles. The Clear button on the display resets these values by clearing the result memory.</p>
Packet Format	Displays the packet format: AG, HT_MF, HT_GF, VHT.
Data Modulation	Displays the modulation used in the Data symbols: BPSK, QPSK, 16QAM, 64QAM, 256QAM.
Guard Interval	Displays the Guard Interval used by the Data symbols: 1/4, 1/8.
Symbols, EVM, Avg Power	Displays the type and number of symbols, EVM-RMS and average power of the Preamble and Data portions of the packet.
SIG Data L-SIG Data HT-SIG Data VHT-SIG Data	Displays the decimal values of the received packet SIGNAL, HT-SIGNAL and VHT-SIGNAL symbols' fields. The Pass/Fail result in each heading line indicates whether the calculated Parity or CRC value matches the received Parity or CRC value of the corresponding SIGNAL symbol grouping.

WLAN Summary Display for 802.11b Signals

Standard: 802.11b **Packet Format:** Auto Detect

Burst Power: -1.22 dBm	Peak-to-Average: 1.50 dB	Header Data	CRC: Pass
Burst Index: 1	IQ Origin Offset: -39.12 dB	Signal 20	Service 0
Frequency Error: -2.34 Hz		Length 400	CRC 17735

EVM		All	1k Chips
RMS		-39.12 dB	-39.02 dB
Peak		-30.29 dB	-30.32 dB
Pk @ Chip		2992	66
Avg RMS	-39.12 dB		
1 of 1 Bursts			
Max RMS	-39.12 dB		

Packet Format: DSSS 2M		Data Modulation: DSSS 2M	
	Chips	EVM	Avg Power
Preamble:	1584	-38.96 dB	-1.72 dBm
Header:	528	-39.06 dB	-1.23 dBm
Data:	4400	-39.19 dB	-1.23 dBm

Elements of the Display for 802.11b Signals

Table 19:

Measurement	Description
Standard	Display of the standard selected on the Setup > Settings > Modulation Parameters tab.
Burst Power	The average power of the entire packet.
Peak-to-Average	The ratio of the highest instantaneous packet signal power level to the average signal power.
Burst Index	The index of the analyzed packet within the analysis record.
IQ Origin Offset	The amount of power at the signal carrier frequency relative to the total power of the signal.
Frequency Error	The frequency difference between the measured carrier frequency of the signal and the measurement frequency setting.
EVM	<p>The RMS and Peak values of the normalized Error Vector Magnitudes taken at signal chip intervals. The normalized EVM values are calculated as the difference between the detected received signal constellation points and ideal reference points estimated by the instrument from the received signal. Values are reported in units of percent or dB. Peak values indicate the associated chip locations.</p> <p>RMS and Peak values are displayed for groupings of All chips, and the first 1000 (1k) chips.</p> <p>Average RMS and Peak RMS values are accumulated over multiple packet analysis cycles. The Clear button on the display resets these values by clearing the result memory.</p>
Packet Format	Displays the packet format: DSSS 1M, DSSS 2M, CCK 5.5M or CCK 11M.
Data Modulation	Displays the modulation used in the PSDU/Data packet segment.
Chips, EVM, Avg Power	Displays the number of chips, EVM-RMS and average power of the Preamble, Header and Data portions of the packet.
Header Data	Displays the decimal values of the received packet Header's Signal, Service, Length, and CRC fields. The CRC Pass/Fail result indicates if the received CRC value is equal to the CRC value computed from the received Signal, Service and Length values.

WLAN Summary Settings

Main menu bar: Setup > Settings

Favorites toolbar: 

The settings for the WLAN Summary display are shown in the following table.

Settings tab	Description
Modulation Params	Specifies the type of modulation used for the input signal and other parameters.
Analysis Params	Specifies parameters used by the instrument to analyze the input signal.
Data Range	Specifies which symbols and subcarriers of the signal to display.
Analysis Time	Specifies parameters that define the portion of the acquisition record that is used for analysis. Also allows you to specify the Units (Symbols or Seconds) for WLAN Analysis displays.
EVM	Specifies the EVM units (dB or %) and Max Bursts to Avg. The EVM is generally measured on symbol or chip instants and is usually measured after best-fit estimates of the frequency error and a fixed phase offset have been removed.
Prefs	Specifies the units of the display and whether elements of the graphs are displayed.

WLAN Symbol Table Display

The WLAN Symbol Table display shows decoded data values for each data symbol in the analyzed signal packet. For OFDM signals (all standards except 802.11b), results are presented with subcarrier (frequency) indices in the horizontal dimension and symbol (time) intervals in the vertical dimension. For 802.11b signals, the Preamble, Header, and Data (PSDU) symbol values are presented sequentially, with symbol indices in the left column.

To show the WLAN Symbol Table display:

1. If you are analyzing a stored data file, recall the data file now. Otherwise, go to the next step.
2. Press the **Displays** button or select **Setup > Displays**.
3. In the **Select Displays** dialog, select **WLAN Analysis** in the **Measurements** box.
4. In the Available displays box, double-click the **WLAN Symb Table** icon or select the icon and click **Add**. The WLAN Symbol icon will appear in the **Selected displays** box and will no longer appear under Available displays.
5. Click **OK** to show the WLAN Symbol Table display.
6. Set the **Frequency** appropriate for the signal.
7. Select **Setup > Settings** to display the control panel.
8. Select the **Modulation Params** tab. Set the Standard, Guard Interval and Spacing and Bandwidth controls as appropriate for the input signal.
9. If you are analyzing a data file, press the **Replay** button to take measurements on the recalled acquisition data file.

WLAN Symbol Table for OFDM signals

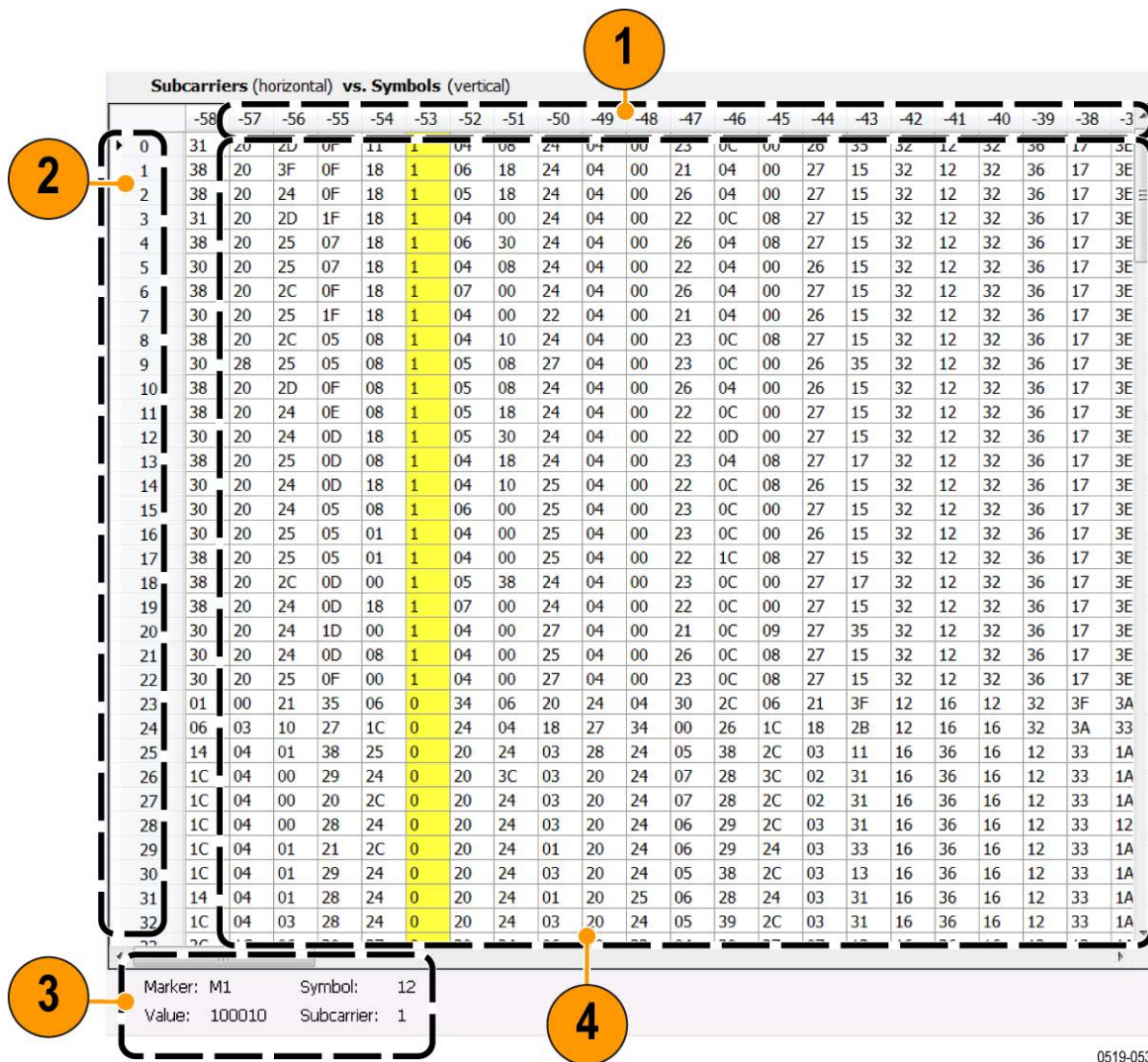

0519-053

Item	Description
1	Subcarrier identifiers (OFDM only). Yellow column indicates Pilot subcarrier locations.
2	Symbol identifiers
3	Subcarrier data values.
4	Marker readout when markers are enabled.

WLAN Symbol Table for 802.11b signals

Symbol	(Preamble, Header, Data)												
130	0	0	0	1	0	1	1	1	0	0	1	1	1
143	1												
144	0	0	1	0	1	0	0	0	0	0	0	0	0
157	0	0	0	0	0	0	0	1	0	0	1	1	0
170	0	0	0	0	0	0	1	1	1	0	0	0	1
183	0	1	0	1	0	0	0	1	0				
192	0	2	0	2	1	3	1	1	1	0	1	1	1
205	3	0	0	0	3	0	2	3	3	3	2	0	1
218	0	1	3	0	0	3	3	1	3	0	0	1	3
231	0	2	1	1	1	2	1	1	2	2	2	2	2
244	2	2	3	0	1	2	3	2	2	1	3	0	3
257	0	0	2	3	1	2	2	0	3	3	3	1	1
270	3	0	1	0	3	3	2	0	0	3	3	1	3
283	2	3	0	3	2	0	0	3	1	1	2	2	3
296	0	0	2	1	2	2	3	2	0	2	2	2	1
309	3	3	3	2	0	1	0	0	1	2	1	3	2
322	3	1	0	1	2	1	2	0	0	0	2	1	0
335	1	0	0	0	0	1	1	1	2	0	1	2	1
348	2	1	2	3	1	1	2	1	3	3	1	1	2
361	0	3	1	3	3	1	2	3	1	1	3	2	1
374	1	2	3	2	3	2	2	0	2	2	1	2	0
387	3	2	2	1	3	3	2	0	0	0	2	3	2

Item	Description
1	Symbol number index (from beginning of packet or segment) of first Symbol data value on the line.
2	Symbol values, with the value in column 2 of each row corresponding to the symbol number index in column 1, and then the symbol value in column 3 corresponding to the next symbol number index, etc., to the end of each row. For example: The symbol number index 130 = 0 in column 2. The symbol number index for column 3 is 131, which equals 0. The symbol number index for column 4 is 132, which equals 1. This pattern continues to the end of the row.

WLAN Symbol Table Settings

Main menu bar: Setup > Settings

Favorites toolbar: 

The settings for the WLAN Symbol Table display are shown in the following table.

Settings tab	Description
Modulation Params	Specifies the type of modulation used for the input signal and other parameters.
Analysis Params	Specifies parameters used by the instrument to analyze the input signal.
Data Range	Specifies which symbols and subcarriers of the signal to display.
Analysis Time	Specifies parameters that define the portion of the acquisition record that is used for analysis. Also allows you to specify the Units (Symbols or Seconds) for WLAN Analysis displays.
Prefs	Specifies the units of the display and whether elements of the graphs are displayed.

WLAN Analysis Shared Measurement Settings

Main menu bar: Setup > Settings

Favorites toolbar: 

The control panel tabs in this section are shared between the displays in the WLAN Analysis folder (**Setup > Displays**). Some tabs are shared by all the displays, some tabs are shared by only a subset of displays. The settings available on some tabs change depending on the selected display.

Table 20: Common controls for WLAN analysis displays

Settings tab	Description
Modulation Params	Specifies the type of modulation used for the input signal and other parameters.
Analysis Params	Specifies parameters used by the instrument to analyze the input signal.
Data Range	Specifies which symbols and subcarriers of the signal to display.
Analysis Time	Specifies parameters that define the portion of the acquisition record that is used for analysis. Also allows you to specify the Units (Symbols or Seconds) for WLAN Analysis displays.
Trace	Enables you to display or hide the measurement or average trace.
Scale	Specifies the vertical, subcarrier (for non-b standards only), and symbols scale and position settings.
EVM	Specifies the EVM units and max burst averages.
Prefs	Specifies the units of the display and whether elements of the graphs are displayed.

Modulation Params Tab - WLAN

The Modulation Params tab specifies the type of modulation used by the input signal and other parameters that define the signal format.

Settings	Description
Standard	Specifies the standard used for the input signal. Choices are 802.11a/b/g/j/n/p/ac.
Guard Interval	Specifies the guard interval used in the input signal. You can select the following: <ul style="list-style-type: none"> – Auto from SIG uses the Guard Interval value extracted from the signal – 1/8 allows setting the value manually – 1/4 allows setting the value manually
Channel Bandwidth	Specifies the nominal channel bandwidth. This setting affects the Subcarrier Spacing value when the Subcarrier Spacing Auto box is checked.

Table continued...

Settings	Description
Subcarrier Spacing	Specifies the spacing between subcarriers. When Auto is selected, this setting is automatically calculated according to the Channel Bandwidth value. If Auto is unchecked, a custom subcarrier spacing value can be entered for nonstandard signal definition.
FFT Sample Rate	Indicates the FFT sample rate, based on the bandwidth or subcarrier setting.
FFT Length	Indicates the fixed FFT length.

Analysis Params Tab - WLAN

The Analysis Params tab contains parameters that control the analysis of the input signal.

Modulation Params | **Analysis Params** | Data Range | Analysis Time | Traces | Scale | Prefs

Burst Selection Index: Equalizer Training:

Frequency Error: Auto Data Modulation:

Symbol Analysis Offset: Enable 1024QAM Detection

Swap I & Q:

Pilot Tracking

Phase Amplitude Timing

Settings	Description
Burst Selection Index	Allows specifying the burst you want to measure when multiple bursts are present in an acquisition. Index number of the first burst is 1, second burst is 2, etc.
Frequency Error	When the Auto box is checked, the analysis determines the Frequency Error and the measured Frequency Error is displayed. When the Auto box is unchecked, the entered value is used by the analysis as a fixed frequency offset. This is useful when the exact frequency offset of the signal is known.
Symbol Analysis Offset	Specifies the analysis offset in the symbol interval. This value is a percentage of the Guard Interval. The allowable range is -100% to 0%. -100% positions the FFT to start at the beginning of the Guard Interval, 0% positions it to start at the end of the Guard Interval. Default value is -50% which usually gives the best measurement results.
Swap I & Q	Select the checkbox to swap the I and Q components of a signal. This compensates the input signal for spectral inversion.
Equalizer Training	Specifies the method used to estimate channel frequency response and equalization. This control can be used to diagnose changes in frequency response over the signal packet.
Preamble	The instrument uses only the Preamble to estimate channel frequency response. This response is then used to equalize the entire signal packet.

Table continued...

Settings	Description
Preamble + Data	The instrument makes an initial channel frequency response estimate from the Preamble. It then estimates the channel response for each data symbol using the decoded data content to derive equalization for each symbol individually. This allows compensation for time-varying channel response over the packet.
Data Modulation	Allows choice of automatic or manual method of data symbol modulation identification, as follows: <ul style="list-style-type: none"> – Auto Detect estimates the modulation from the data symbol IQ content. – Auto from SIG sets the modulation as indicated by the embedded SIG preamble symbol format data. – Manual allows specifying the modulation type regardless of the signal content.
Enable 1024QAM detection	Check box to enable auto-detection of 1024QAM.
Pilot tracking	Specifies if pilot subcarriers should be used to correct amplitude, phase, and symbol timing variations over the packet. The choices available are Phase, Amplitude, and Timing. The default setting is Phase correction enabled, Amplitude and Timing correction disabled..
Subcarrier derotation	Allows some displays to show subcarriers with or without Gamma subcarrier phase rotation removed. Gamma phase rotation is applied to 802.11n and 802.11ac subcarriers in defined subranges depending on the selected Channel Bandwidth >40 MHz. Only Constellation and Symbol Table results are affected by this control. <p>When the box is unchecked, the rotation is not removed, which provides a direct view of the physical modulation on the channel.</p> <p>When the box is checked, the rotation is removed, allowing easier decoding of the underlying data content.</p>

Data Range Tab - WLAN

The Data Range tab enables you to control how much signal is analyzed, as well as specify the range of results that are displayed for the WLAN Constellation, EVM, Flatness, Magnitude Error, Phase Error, and Symbol Table graphs. The tab contents vary by standard.

Data Range tab for non-b standards.

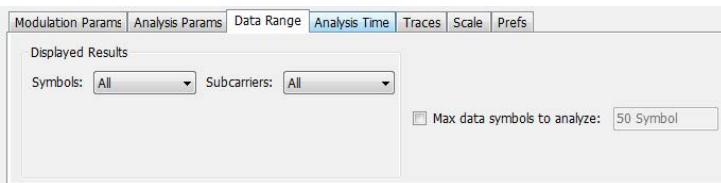

Settings	Description
Symbols	Specifies which symbols are displayed in the graphs.
All	Select All to display all symbols.
Table continued...	

Settings	Description
Range	Select Range to specify a subset of symbols for display.
Start	Specifies the first symbol to include in the display.
Stop	Specifies the last symbol to include in the display.
Single	Select Single to display a single symbol.
Index	Use Index to specify the symbol you want to display.
Subcarriers	Specifies which subcarriers are displayed.
All	Select All to display all subcarriers in the signal.
Pilots	Select Pilot to display only pilot subcarriers.
Data	Select Data to display only data subcarriers.
Single	Specifies a specific subcarrier for display.
Index	Specifies the specific subcarrier to be displayed.
Range	Specifies a range of subcarriers to be displayed.
Start	Specifies the start value of the range to be displayed.
Stop	Specifies the ending value of the range to be displayed.
Max symbols to analyze	Specifies how many symbols are analyzed. You can use this setting to speed analysis by limiting the number of symbols being analyzed.

Data Range tab for 802.11b standards.

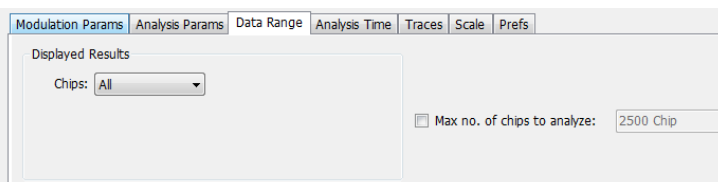

Settings	Description
Chips	Specifies which symbols are displayed in the graphs.
All	Select All to display all chips.
Preamble Only	Select to include only the Preamble in the display.
Header Only	Select to include only the Header in the display.
Data Only	Select to include only the Data in the display.
Max number of chips to analyze	Specifies how many chips are analyzed. You can use this setting to speed analysis by limiting the number of chips being analyzed. Check this box and then enter the maximum number of chips to analyze.

Analysis Time Tab - WLAN

The Analysis Time tab contains parameters that define how the signal is analyzed in the WLAN Analysis displays.

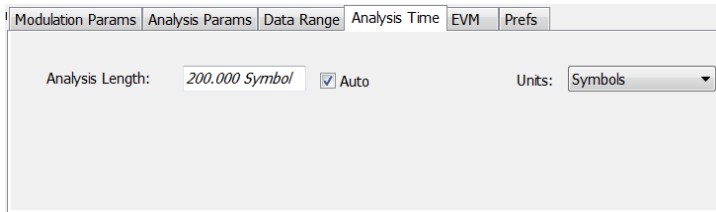

Settings	Description
Analysis Length	Specifies the length of the analysis period to use in measurements. Length is specified in either symbols or seconds, depending on the Units setting. Use this to specify how long a period of time is analyzed. – Range: minimum value depends on modulation type – Resolution: 1 symbol
Auto	When enabled, causes the instrument to set the Analysis Length value based on the requirements of the selected display.
Units	Specifies the units of the Analysis Length in either Symbols or Seconds.

Trace Tab - WLAN

The Trace tab allows you to set the trace display characteristics of the selected display. This tab is not available for all WLAN displays.

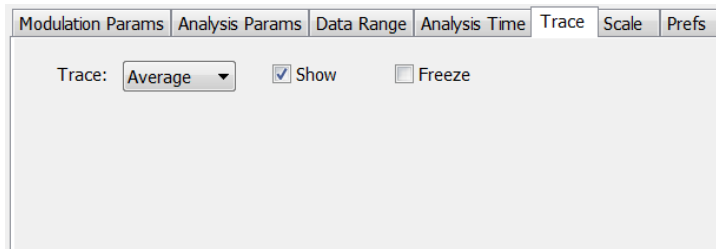

Settings	Description
Trace	Use this drop-down list to select whether or not the Average trace or the measurement trace is displayed. The measurement trace depends on the selected display.
Show Symbols	Select or deselect this checkbox to show or hide symbols.
Freeze	Selecting Freeze halts updates to the symbols.

Traces Tab - WLAN Channel Response

The Traces tab allows you to set the trace display characteristics of the WLAN Channel Reponse display.

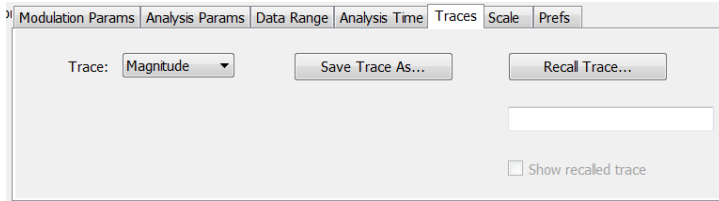

Settings	Description
Trace	Selects the Magnitude or Phase trace for saving or recalling.
Save Trace As . . .	Select to save a trace.
Recall Trace . . .	Select to recall a trace.

Scale Tab - WLAN

The Scale tab allows you to change the scale settings that control how the trace appears on the display but does not change control settings such as Measurement Frequency. There are four versions of the Scale tab for WLAN displays. One version is used for the Constellation display, one for the Spectral Flatness display, one for the Power vs Time display, and one for the EVM, Magnitude Error, Phase Error, and Channel Response displays.

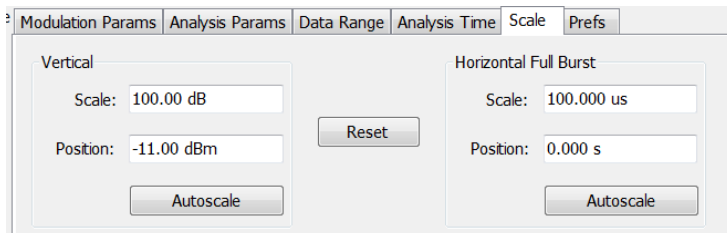

Figure 55: Scale tab for the WLAN Power vs Time display

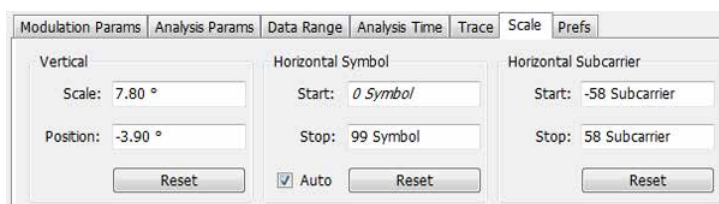

Figure 56: Scale tab for WLAN EVM, Magnitude Error, Phase Error, and Channel Response displays

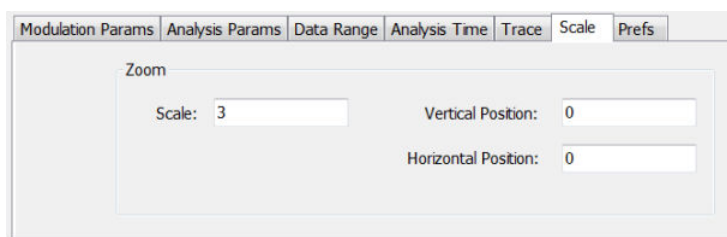

Figure 57: Scale tab for WLAN Constellation display

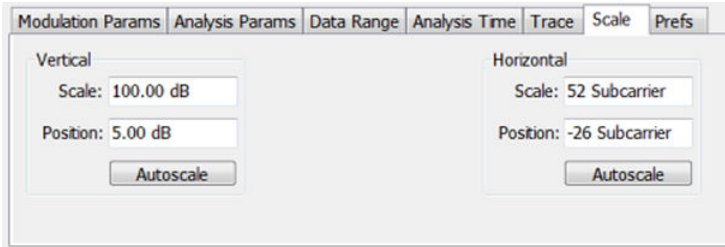

Figure 58: Scale tab for WLAN Spectral Flatness display

Settings	Description
Vertical	Controls the vertical position and scale of the trace display.
Scale	Changes the vertical scale of the graph.
Position	Adjusts the reference level away from top of the graph.
Autoscale	Resets the scale of the vertical axis to contain the complete trace.
Subcarrier	Controls the scale of the subcarrier graph and position of the trace.
Scale	Specifies how many subcarriers are displayed horizontally.
Position	Specifies the subcarrier that appears at the left edge of the subcarrier graph.
Autoscale	Resets the scale of the horizontal axis to contain the complete trace.
Symbols	Controls the scale of the Symbols graph.
Scale	Specifies the number of symbols that appear in the symbols graph.
Position	Specifies the symbol that appears at the left edge of the Symbols graph.
Autoscale	Resets the scale and position settings to optimize the display.
Auto	When Auto is checked, the scale and position values for the Symbols graph are automatically adjusted to maintain the optimal display.
Zoom	Sets the Constellation display size and position.
Scale	Sets the magnification value for the Constellation display.
Vertical Position	Sets the vertical location of the Constellation display within the graph. Range is -3.7 to +3.7.
Horizontal Position	Sets the horizontal location of the Constellation display within the graph. Range is -3.7 to +3.7.

EVM Tab - WLAN

The EVM Tab enables you to choose between dB and percent for the EVM units and to select to set the maximum bursts to average. The EVM Tab is only available for the WLAN Summary display.

Settings	Description
EVM units	Specifies whether the displayed EVM units are dB or percent.
Max Bursts to Avg	Specifies the maximum number of bursts to average when Count is selected.
Count	Enables the Max Bursts to Avg function.

Prefs Tab - WLAN

The Prefs tab enables you to change appearance characteristics of the WLAN Analysis displays. Not all settings on the Prefs tab shown below appear for every WLAN display.

Settings	Description
Time units	Specifies whether the displayed time units are seconds or symbols.
Freq units	Specifies whether the displayed frequency units are frequency (Hz) or subcarrier channel.
Radix	Specifies whether symbol values are displayed in binary or hex format (for example, in the Symbol Table or markers readouts).
Show graphs	Specifies which graphs are displayed. Select from Symbols, Subcarriers or Both, Magnitude, Phase, or Both. Disabled (no masks), Shaded Region, or Line Only. These selections are only available for OFDM signals.
Show graticule	Specifies to show the graticule on the display when checked.

Table continued...

Settings	Description
Show marker readout	Specifies to show the marker readout when checked.

802.11ad and 802.11ay Analysis

Overview of 802.11ad and 802.11ay

The optional Tektronix 802.11ad solution provides repeatable signal quality measurement (such as EVM) for the single carrier 802.11ad Transmitter PHY at RF (up to 70 GHz) for offline analysis.

The IEEE 802.11ad standard was approved in December 2012 and amended in December 2016. The IEEE 802.11ay is an evolving standard that is in draft stage and planned for approval in March 2020. These standards allow wireless communication of devices at multi-gigabit speeds and enable high performance wireless data, display, and audio applications that supplement the capabilities of previous wireless LAN devices. They operate in the 60 GHz band and deliver data transfer rates up to 20 Gbit/s, while maintaining compatibility with existing Wi-Fi devices. The 60 GHz signal cannot typically penetrate walls, but can propagate off reflections from walls, ceilings, floors, and objects using beamforming built into an 802.11ad system. When roaming away from the main room, the protocol can switch to make use of the other 802.11 lower bands at a much lower rate, but which can propagate through walls.

ITU-T mandates the use of the following four channels at the 60 GHz band for 802.11ad.

Channel	Center (GHz)	Min (GHz)	Max (GHz)	BW (GHz)
1	58.32	57.24	59.4	2.16
2	60.48	59.4	61.56	2.16
3	62.64	61.56	63.72	2.16
4	64.8	63.72	65.88	2.16

ITU-T mandates the use of the following channels at the 60 GHz band for 802.11ay.

2.16 GHz BW channels

Channel	Center (GHz)	Min (GHz)	Max (GHz)
1	58.32	57.24	59.40
2	60.48	59.4	61.56
3	62.64	61.56	63.72
4	64.80	63.72	65.88
5	66.96	65.88	68.04
6	69.12	68.04	70.2

4.32 GHz BW channels

Channel	Center (GHz)	Min (GHz)	Max (GHz)
7/8	59.40	57.24	61.56
9/10	61.56	59.4	63.72
11/12	63.72	61.56	65.88
13/14	65.88	63.72	68.04
15/16	68.04	65.88	70.2

802.11ay 4.32 GHz BW Packet Measurements

For a 802.11ay 4.32 GHz BW packet, the results of analysis are shown for 3 regions separately: EDMG, PreEDMG1, and PreEDMG2. This is because of the different chip rate of these regions and to allow you to perform detailed analysis of any specific region with marker support. The region can be selected from the Modulation Params drop-down list. A replay or run will be required to see the updated results after changing the selection in drop-down. Also, when a non-EDMG duplicate mode is detected, the lower band (2GUID-A88BD14F-0A29-4276-A887-CB84AB2B2A94U) or upper band (2GUID-A88BD14F-0A29-4276-A887-CB84AB2B2A94L) can be selected from the drop-down.





802.11ad/11ay Standards Preset

Select **Presets > Standards** in the menu to open the window to select the 802.11ad preset. You can then select to recall preconfigured displays for the Single Carrier or Control PHY standards. The preset displays are Spectrum, Time Overview, 802.11ad/11ay Summary, and 802.11ad/11ay Constellation. The preset sets the measurement filter is to Root Raised Cosine, the filter parameter to 0.25, and the default data length to analyze at 1000 for Single Carrier and 512 for Control PHY in EVM test setup. You can read more about [Standards Presets](#).

Select Presets > Standards in the menu to open the 802.11ad/11ay preset. You can then select to recall preconfigured displays for Single Carrier or Control PHY standards with an EVM or SEM test setup. The preset displays are Spectrum, Time Overview, 802.11ad/11ay Summary, 802.11ad/11ay Constellation for EVM test setup, and SEM and Time Overview for SEM test setup. The preset sets the measurement filter EVM test setup, and SEM and Time Overview for SEM test setup. The preset sets the measurement filter to Root Raised Cosine, the filter parameter to 0.25, and the default data length to Analyze as 1000 for Single Carrier and 512 for Control PHY.

Preset:

Preset displays:

 Spectrum  Time Overview  802.11ad Summary  802.11ad Constellation

Standard:

Test Setup:

Retain current Center Frequency setting

Retain current Ref Level setting

To go directly to a preset in the future, use Presets->Preset Options->Presets->Preset action

Preset:

Preset displays:



SEM



Time Overview

Standard:

Test Setup:

Retain current Center Frequency setting

Retain current Ref Level setting

To go directly to a preset in the future, use Presets->Preset Options->Presets->Preset action



Note: The default resolution bandwidth for the SEM display is 1 MHz.

Settings	Description
Standard	Allows you to choose between Single Carrier and Control PHY.
Test Setup	Allows you to choose between EVM and SEM.
Retain current center frequency setting	Allows you to retain the previous center frequency. It is disabled by default. To enable or disable this setting, select the checkbox.
Retain current reference level setting	Allows you to retain the previous reference level. It is enabled by default. To enable or disable this setting, select the checkbox.

802.11ad/11ay topics in this Help

The following information about the 802.11ad/11ay Analysis option is available:

- [802.11ad/11ay measurements](#) on page 315
- [802.11ad/11ay displays](#) on page 316
- [802.11ad/11ay Control Panel Settings](#) on page 326

802.11ad/11ay measurements

The 802.11ad/11ay option supports analysis of 802.11ad Control PHY, 802.11ad Single Carrier PHY, and 802.11ay Single Carrier PHY standards. Information about the 802.11ad packet is given in Section 20 of the 802.11ad-2016 standard. Information about the 802.11ay packet is given in the draft versions of the 802.11ay standard.

These measurements are only supported for Windows oscilloscopes of bandwidth > 3 GHz. ATI oscilloscopes support real time data analysis at RF, without any downconverters. The 802.11ad/11ay option allows you to do the following:

- Automatically detect the packet start, if it is included in the analysis region
- Synchronize to preamble start using the Golay codes in STF (Short training field) region
- Demodulate Preamble, Header, and Payload regions separately and measure EVM in each of these sections.

The input data is filtered with a RRC filter, corrected for frequency, phase and symbol timing errors, IQ DC offset errors and Equalization is done based on Channel estimated using the Channel Estimation Field (CEF) data.

- Decode packet information in header (like MCS, length etc.)
- Measure the following:
 - EVM
 - RF power and Received Power Indicator (RCPI)
 - Estimated SNR
 - Frequency error
 - IQ DC origin offset
 - IQ Gain imbalance is calculated with the equation

$$\text{Gain Error in dB} = 20 \log \left[\frac{1+e_A}{1-e_A} \right]$$
 Where, $2\epsilon_A$ is the amplitude difference between the signal paths.
 - IQ phase imbalance or quadrature error
 - Signal quality
- Perform Transmit Mask measurement with the set up file given under Example Files. The Mask (Offset frequencies and Start and Stop limits) is developed as per standard recommendations. After loading set up file, you can set the Center Frequency manually to that of the signal.

The following features are also available:

- Analyze EVM result with and without equalization.
- Analyze EVM result with and without IQ DC offset correction.
- View the constellation color coded for the preamble, header, guard, and payload regions. You can also view the $\pi/2$ rotated constellation against the final de-rotated constellation.
- View the demodulated symbols in tabular form with different color codes and with an option to traverse to the start of each region.
- View the EVM spread across the analyzed packet with color codes differentiating regions.
- View of scalar results in the Summary display.
- EVM numbers can be seen in percentage or in dB.
- EVM and Frequency Error limits for the transmitter can be set in the Limits tab of the Settings control panel. If the measured EVM is greater than the limits, or if the measured Frequency Error is greater than the limit, then a FAIL status will appear against the respective measurement.
- Save the Channel Impulse response coefficients as a .txt or .csv file.

802.11ad/11ay displays

The displays in 802.11ad/11ay Analysis (Setup > Displays > Measurements) are:

- [802.11ad/11ay Constellation Display](#) on page 316
- [802.11ad/11ay EVM vs Time display](#)
- [802.11ad/11ay Symbol Table Display](#) on page 322
- [802.11ad/11ay Summary Display](#) on page 323

802.11ad/11ay Constellation Display

This display shows a digitally-modulated signal in constellation form.

To show the 802.11ad/11ay Constellation display:

1. Recall the data file.
2. Press the **Displays** button or select **Setup > Displays**.
3. In the **Select Displays** dialog, select **802.11ad/11ay Analysis** in the **Measurements** box.
4. In the Available displays box, double-click the **802.11ad/11ay Constellation** icon or select the icon and click **Add**. The 802.11ad/11ay Constellation icon will appear in the **Selected displays** box and will no longer appear under Available displays.
5. Click **OK** to show the 802.11ad/11ay Constellation display.
6. Press the **Replay** button to take measurements on the recalled acquisition data file.

Elements of the display



Item	Display element	Description
A	Scalar results	Gives results of Data EVM (Average EVM over the data region and the Peak Error in the data region), Freq Error, and IQ Origin Offset.
B	Marker readout	Specifies the Marker readout values.
C	Graph	Displays the input signal.

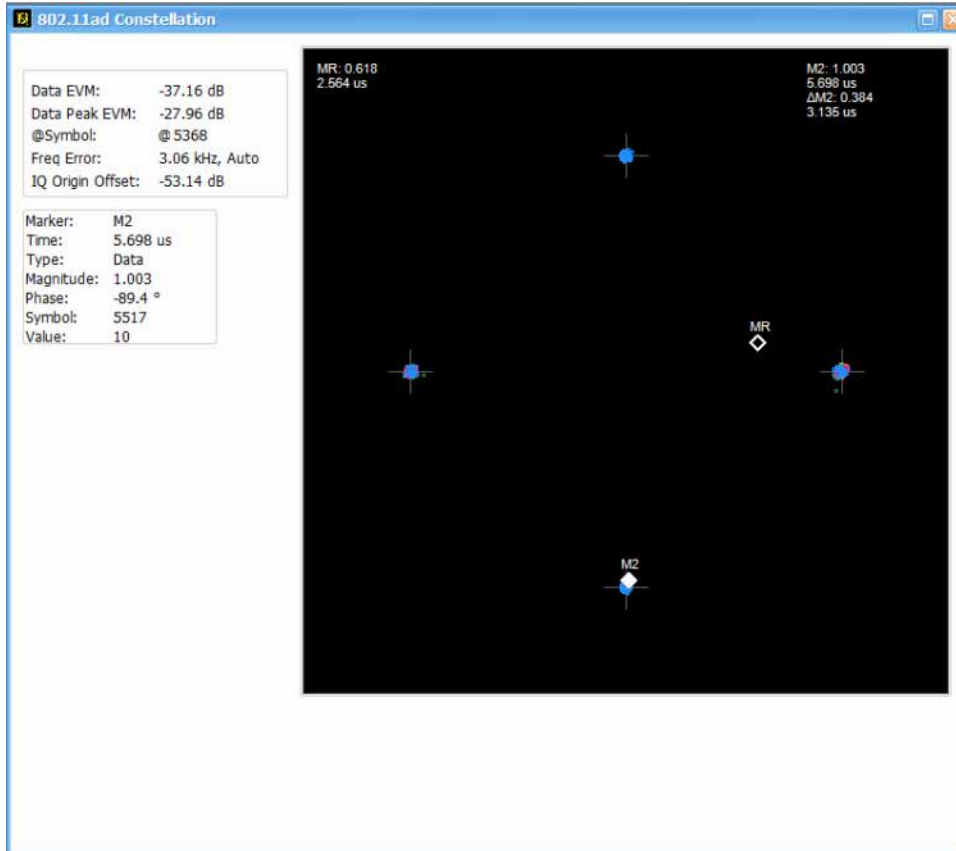

Figure 59: The above image shows an 802.11ad signal with QPSK data region

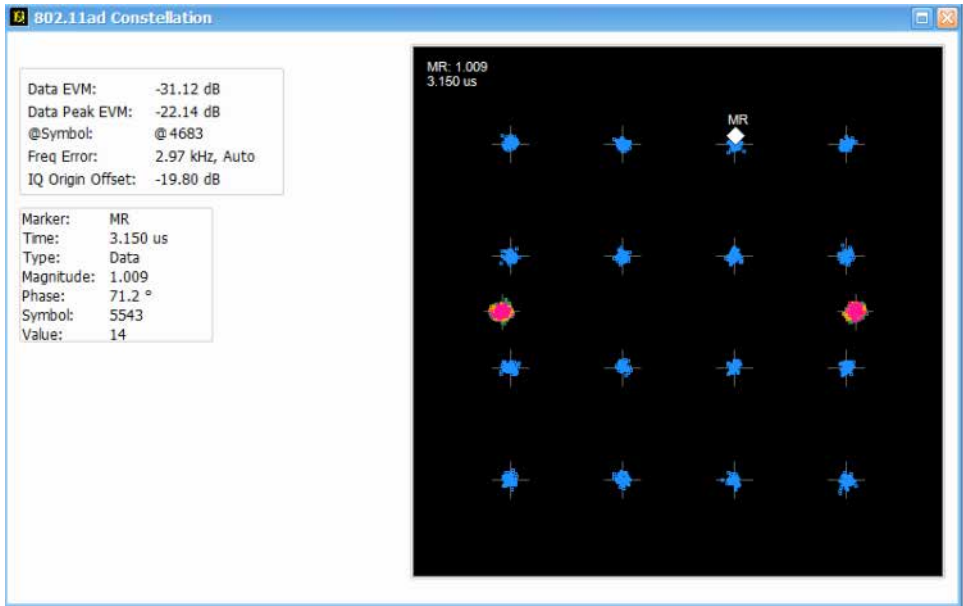

Figure 60: The above image shows an 802.11ad signal with 16QAM data region

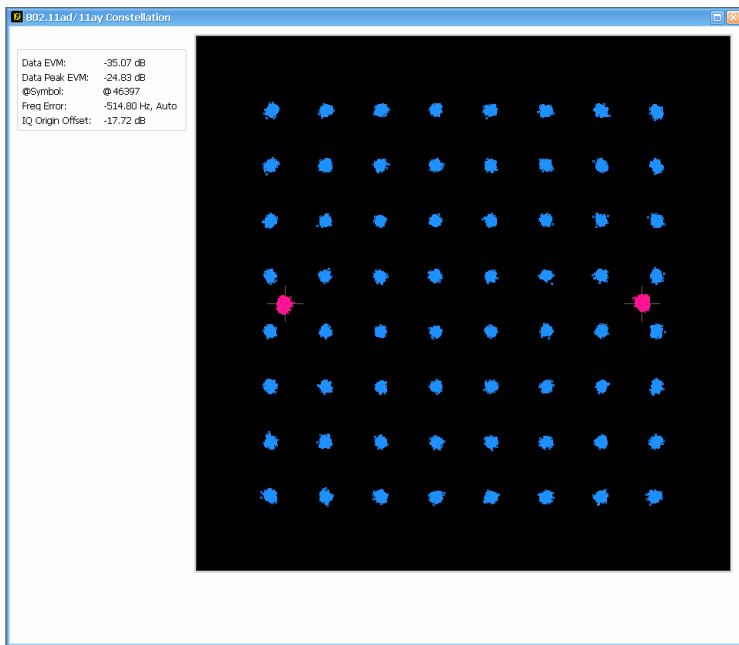

Figure 61: The above image shows an 802.11ad signal with 64QAM data region

Constellation display settings

Settings tab	Description
Modulation Params	Specifies the input signal standard, measurement filters and filter parameters.
Analysis Params	Specifies parameters used by the instrument and software to analyze the input signal.

Table continued...

Settings tab	Description
Advanced Params	Specifies additional parameters used by the instrument and software to analyze the input signal.
Analysis Time	Specifies parameters that define the portion of the acquisition record that is used for analysis. Also allows you to specify the Units (Symbols or Seconds) and Time Zero Reference (Trigger or Acquisition Start) for 802.11ad/11ay Analysis displays.
EVM	Specifies the EVM units, start and length of data symbols to be analyzed for EVM, and the number of acquisitions used for averaging. For Control PHY, the Start and Length of data symbols is specified in terms of de-spread symbols and also the number of Bursts to Avg by enabling the count.
Traces	Specifies the trace type and the result content. Select either rotated or de-rotated constellation. De-rotated constellation is shown by default.
Prefs	Specifies the radix of the data symbols and the option to see the marker readout.
Scale	Defines the vertical and horizontal axes.

802.11ad/11ay EVM vs Time

This display shows the EVM plotted against time in seconds or symbols. The analysis region in which EVM measurement done is indicated by a purple line in the Time Overview to indicate the region of analysis.

To show the 802.11ad/11ay EVM vs Time Display:

1. Recall the data file.
2. Press the **Displays** button or select **Setup > Displays**.
3. In the **Select Displays** dialog, select **802.11ad/11ay Analysis** in the **Measurements** box.
4. In the Available displays box, double-click the **802.11ad/11ay EVM vs Time** icon or select the icon and click **Add**. The 802.11ad/11ay EVM vs Time icon will appear in the **Selected displays** box and will no longer appear under Available displays.
5. Click **OK** to show the 802.11ad/11ay EVM vs Time display.
6. Press the **Replay** button to take measurements on the recalled acquisition data file.

Elements of the display

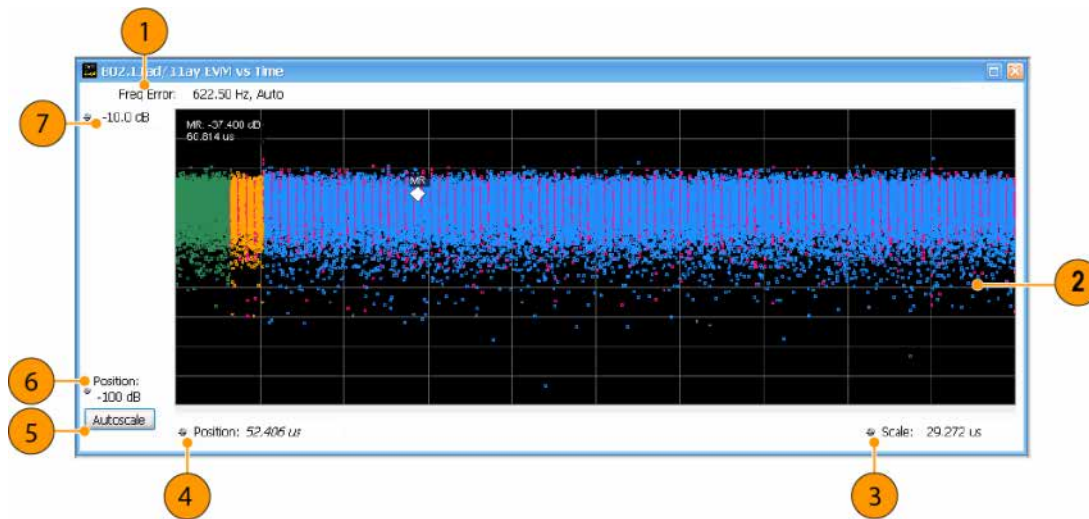

Item	Display element	Description
1	Freq error	Displays the frequency error which has been corrected after which the EVM is calculated. The displayed frequency error is followed by either Auto or Manual. This indicates the error calculation mode which is set under Settings >Analysis Params.
2	Graph	Displays the input signal. Different color codes are used in the 802.11ad EVM vs Time to indicate different regions of the packet. Check legend at the bottom of the symbol table for color codes
3	Scale	Adjusts the span of the graph in seconds or symbols.
4	Position	Displays the horizontal position of the trace on the graph display.
5	Autoscale	Adjusts the vertical and horizontal settings to provide the best display.
6	Position	The error at the bottom of the graph in dB or percent.
7	Top of graph	The error at the top of the graph in dB or percent.

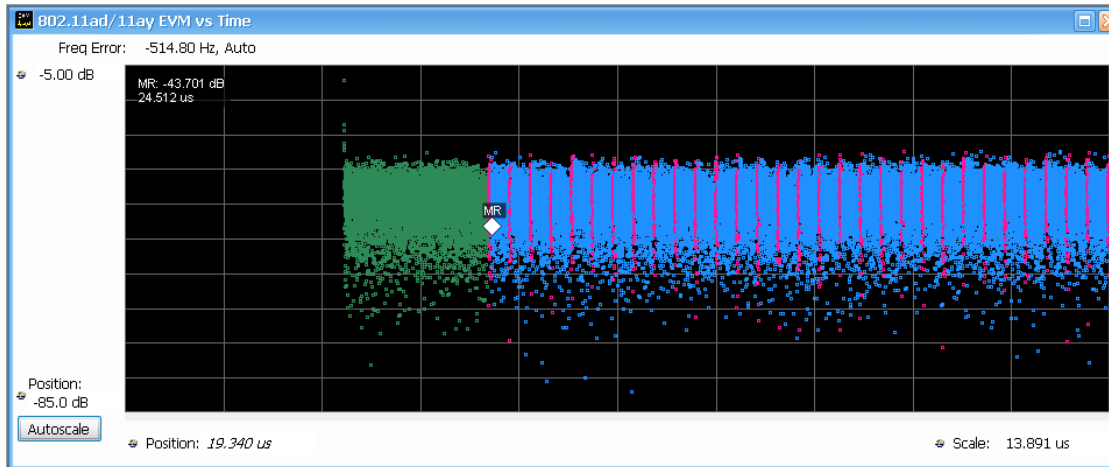

Figure 62: The above image shows a 802.11ay 4.32 GHz pre-EDMG region. The initial empty portion is for the pre-EDMG region.

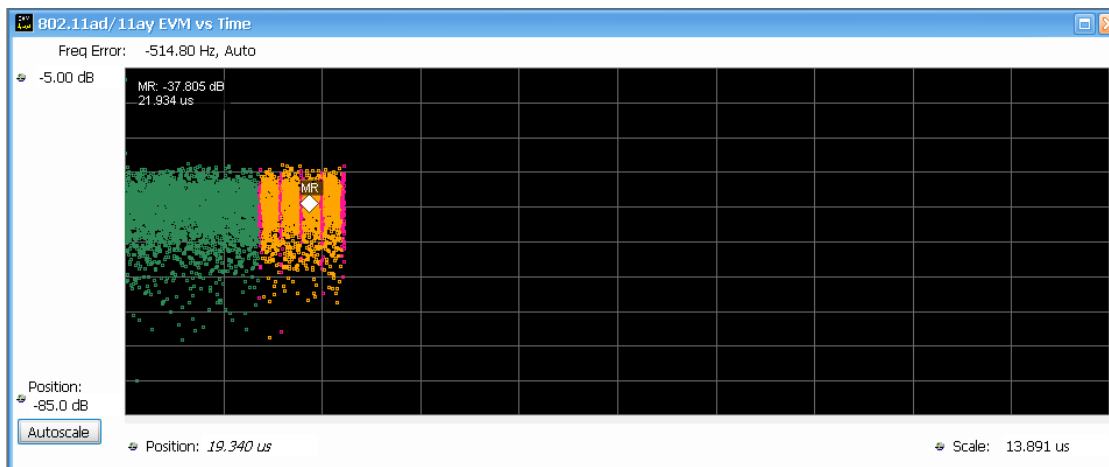

Figure 63: The above image shows a 802.11ay 4.32 GHz EDMG1 region. The trailing empty portion is for the EDMG region.

EVM vs Time display settings

Settings tab	Description
Modulation Params	Specifies the input signal standard, measurement filters, and filter parameters.
Analysis Params	Specifies parameters used by the instrument to analyze the input signal.
Advanced Params	Specifies parameters used by the instrument to analyze the input signal, with options to enable the Equalizer and IQ DC Offset correction.
Analysis Time	Specifies parameters that define the portion of the acquisition record that is used for analysis. Also allows you to specify the Units (Symbols or Seconds) and Time Zero Reference (Trigger or Acquisition Start) for 802.11ad/11ay Analysis displays.
EVM	Specifies the number of data symbols to be analyzed for EVM. For Control PHY, the Start and Length of data symbols is specified in terms of de-spread symbols.

Table continued...

Settings tab	Description
Prefs	Specifies the radix of the marker readout and whether elements of the graphs are displayed.
Scale	Defines the vertical and horizontal axes.

802.11ad/11ay Symbol Table Display

This display shows a digitally-modulated signal. It is similar to the Constellation display except that a text table is used to display data bits as symbols rather than a graph.

1. Recall the data file.
2. Press the **Displays** button or select **Setup > Displays**.
3. In the **Select Displays** dialog, select **802.11ad/11ay Analysis** in the **Measurements** box.
4. In the Available displays box, double-click the **802.11ad/11ay Symbol Table** icon or select the icon and click **Add**. The 802.11ad/11ay Symbol Table icon will appear in the **Selected displays** box and will no longer appear under Available displays.
5. Click **OK** to show the 802.11ad/11ay Symbol Table display.
6. Press the **Replay** button to take measurements on the recalled acquisition data file.

Elements of the display

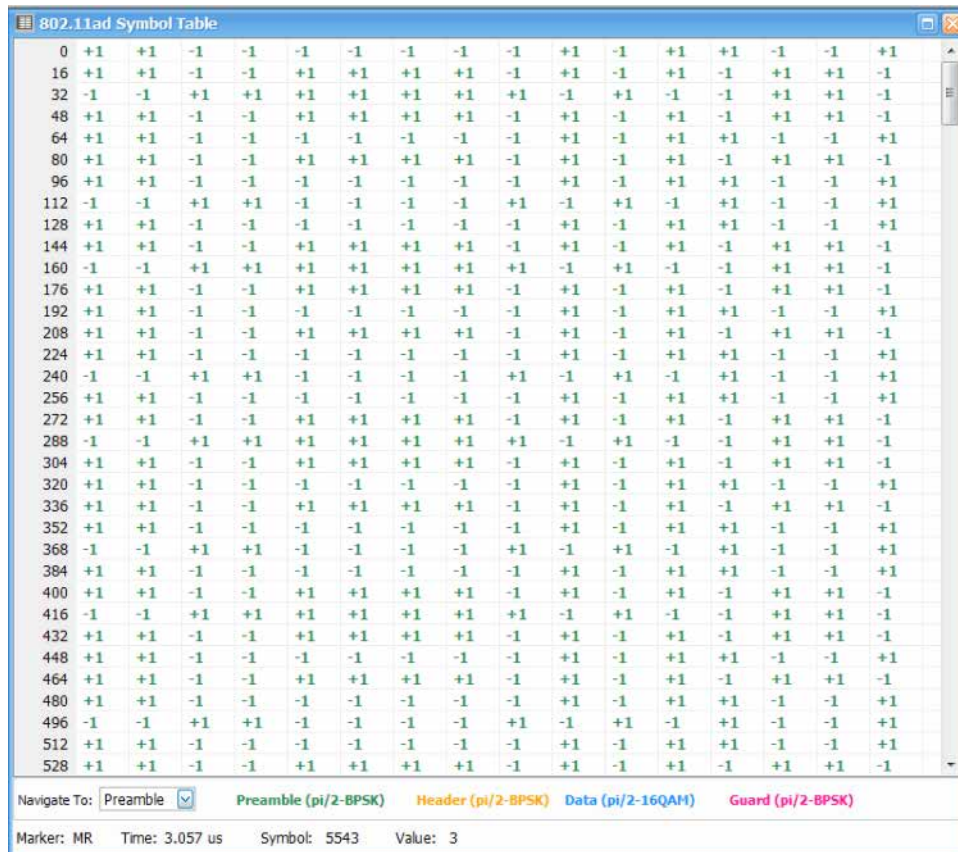

Different Color codes are used in the table to indicate different regions of the packet. The legend at the bottom of the table indicates which color represents which packet component. The bit colors in the table match the packet colors. The packet will have the following regions:

- Preamble (pi/2-BPSK)
- Header (pi/2-BPSK)
- Data (pi/2 BPSK, pi/2 QPSK, pi/2 16QAM, or pi/2 64QAM)
- Guard (pi/2-BPSK)

Using markers

Markers are indicators in the display that you can position on a trace to measure values such as frequency, power, and time. A Marker always displays its position and, if the Delta readout is enabled, will display the difference between its position and that of the Marker Reference. Within the Symbol Table, colored cells indicate the location of markers. The selected Marker is highlighted with a light green background. All other markers are highlighted with a light gray background. In the Symbol Table, the marker readout below the table shows the marker location in time, symbol numbers and symbol value.

Symbol Table display settings

Settings tab	Description
<i>Modulation Params</i>	Specifies the type of modulation used for the input signal and other parameters.
<i>Analysis Params</i>	Specifies parameters used by the instrument to analyze the input signal.
<i>Advanced Params</i>	Specifies additional parameters used by the instrument to analyze the input signal.
<i>Analysis Time</i>	Specifies parameters that define the portion of the acquisition record that is used for analysis. Also allows you to specify the Units (Symbols or Seconds) and Time Zero Reference (Trigger or Acquisition Start) for 802.11ad/11ay Analysis displays.
<i>Prefs</i>	Specifies the radix of the symbols and the option to see the marker readout.

802.11ad/11ay Summary Display

The 802.11ad/11ay Summary display shows a summary of all scalar measurements done on the acquired test pattern. Pass/Fail information is also provided in this display for all enabled scalar measurements. You can set limits and choose which measurement to compare for Pass/Fail from the Limits tab in the 802.11ad/11ay Summary Settings control panel. The default limits come from the performance recommendation limits given by the Standards document. The default limits can be reloaded by selecting the 802.11ad/11ay as the preset in the Standards Preset window.

1. Recall the data file.
2. Press the **Displays** button or select **Setup > Displays**.
3. In the **Select Displays** dialog, select **802.11ad/11ay Analysis** in the **Measurements** box.
4. In the Available displays box, double-click the **802.11ad/11ay Summary** icon or select the icon and click **Add**. The 802.11ad/11ay Summary icon will appear in the **Selected displays** box and will no longer appear under Available displays.
5. Click **OK** to show the 802.11ad/11ay Summary display.
6. Press the **Replay** button to take measurements on the recalled acquisition data file.

Elements of the display

The results presented in the display include scalar results of modulation characteristics, shown in the following areas of the display: EVM - Packet, Average results over multiple Acquisitions (One Bust per Acquisition), and Packet Information. These scalar results are averaged over the previously acquired packets. The packet number to be analyzed is set in the EVM tab of the Settings control panel.

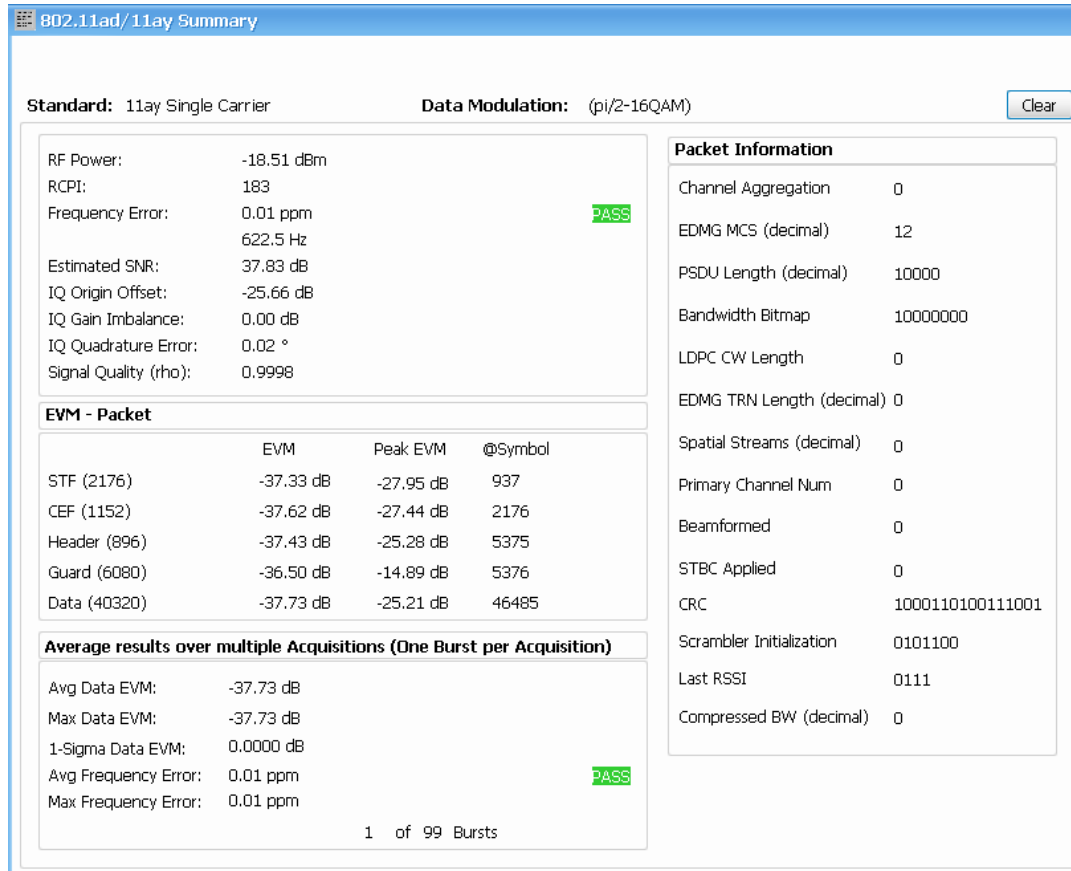

Figure 64: The above image shows an 802.11ad Single Carrier signal with pi/2 16QAM data modulation

Display element	Description
Standard	Display of the standard selected on the Setup > Settings > Standard Params tab.
Data Modulation	Indicates data modulation. Data modulation types are as follows: Single Carrier: pi/2 BPSK, pi/2 QPSK, pi/2 16QAM, pi/2 64QAM Control PHY: pi/2 DBPSK
Clear	Click to reset the scale measurements.
RF Power	Measures the RF power in the signal.
RCPI	Calculates the Received Channel Power Indicator from RF power.
Frequency error	The frequency difference between the measured carrier frequency of the signal and the measurement frequency setting in ppm and Hz.
Estimated SNR	Measures the estimated SNR in the measurement setup.

Table continued...

Display element	Description
IQ Origin Offset	The average magnitude of the DC subcarrier level relative to total signal power. It indicates the level of carrier feedthrough detected at the center (DC) carrier.
IQ Gain Imbalance	Measures the Gain mismatch of the signal (sinusoid) in dB. It indicates the mismatch between I and Q signal paths.
IQ Quadrature Error	Measures the phase part of the imbalance in degrees. It indicates the mismatch between I and Q signal paths.
Signal Quality	Measure the signal quality of the packet based on the preamble region.
EVM – Packet	<p>Gives EVM results for each packet region. The number of symbols analyzed in each region is given alongside the packet region labels.</p> <p>802.11ad Single Carrier: STF, CEF, Header, Guard, and Data</p> <p>802.11ad Control PHY: STF, CEF and Data + Header in despread symbols</p> <p>802.11ay Single Carrier 2.16 GHz BW: LSTF, LCEF, L Header, EDMG Header-A, EDMG STF, EDMG CEF Guard and Data</p> <p>802.11ay Single Carrier 4.32 GHz BW: LSTF, LCEF, L Header, EDMG Header-A, EDMG STF, EDMG CEF Guard and Data</p>
EVM	Gives Average EVM in the region of the packet.
Peak EVM	Gives the Peak error/EVM in the corresponding region of the packet.
@ Symbol	Gives the symbol index at which the peak error occurred out of the entire set of symbols in the packet (it is not an index just within the region). The symbol index shown here can be used to place a marker in the Symbol Table or EVM vs Time displays to observe the exact symbol position at which the peak error occurred.
Average results over multiple acquisitions (one burst per acquisition) Avg Data EVM Max Data EVM 1-sigma Data EVM Avg Frequency Error Max Frequency Error	<p>Gives data EVM and Frequency error results over multiple acquisitions. Gives both the Average and Max over multiple acquisitions. Also shows how many acquisitions have been used for these results below. For Data EVM, the 1-sigma variation is shown in addition to average. When the EVM unit is in %, this value is equivalent to the standard deviation statistic. When the EVM unit is in dB, this value is the standard deviation after converting EVM values to dB scale. The number of acquisitions to be used for these measurements can be selected from the EVM tab of the Settings Control panel using the Max Bursts to Avg selection.</p>
Packet Information	<p>The packet header information includes the Scrambler initialization, MCS, Length, Packet type, Training Length, Turnaround and HCS. MCS, Length and Training length are shown in decimal.</p> <p>PDDU, Aggregation, Beam Tracking Request, and Last RSSI are shown only for 802.11ad Single Carrier.</p> <p>For 802.11ay Single Carrier, EDMG MCS, BW Bitmap, Channel Aggregation, PSDU Length are shown. The Guard Length type info can be derived from the Last RSSI bits. The 2 MSB bits of Last RSSI bit convey the Guard type information (00 – Short, 01 – Normal, 10 – Long).</p>

Summary Table display settings

Settings tab	Description
Modulation Params	Specifies the input signal standard and other signal parameters.
Analysis Params	Specifies parameters used by the instrument to analyze the input signal.
Advanced Params	Specifies additional parameters used by the instrument to analyze the input signal.
Analysis Time	Specifies parameters that define the portion of the acquisition record that is used for analysis. Also allows you to specify the Units (Symbols or Seconds) and Time Zero Reference (Trigger or Acquisition Start) for 802.11ad/11ay Analysis displays.
EVM	Specifies the EVM units and number of data symbols to be analyzed for EVM. For Control PHY, the Start and Length of data symbols is specified in terms of de-spread symbols and also the number of Bursts to Avg by enabling the count.
Limits	Load and define 802.11ad measurement limits for Pass/Fail comparison. You can save defined limits as a .csv file and also load previously saved .csv files.

802.11ad/11ay Control Panel Settings



The control panel tabs in this section are shared between the displays in the 802.11ad/11ay Analysis folder (Setup > Displays). Some tabs are shared by all the displays, some tabs are shared by only a couple of displays. The settings available on some tabs change depending on the selected display.

Settings tab	Description
Modulation Params	Specifies the type of modulation used for the input signal and other parameters.
Analysis Params	Specifies parameters used by the instrument to analyze the input signal.
Advanced Params	Specifies parameters used by the instrument to analyze the input signal.
Analysis Time	Specifies parameters that define the portion of the acquisition record that is used for analysis. Also allows you to specify the Units (Symbols or Seconds) and Time Zero Reference (Trigger or Acquisition Start) for 802.11ad/11ay Analysis displays.
EVM	Specifies the EVM units and number of data symbols to be analyzed for EVM.
Limits	Load and define 802.11ad/11ay measurement limits for Pass/Fail comparison. You can save defined limits as a .csv file and also load previously saved .csv files.
Traces	Specifies the trace type and the result content. Select either rotated or de-rotated constellation. De-rotated constellation is shown by default.

Table continued...

Settings tab	Description
Prefs	Specifies the radix of the symbols, the option to see the marker readout, and whether elements of the graphs are displayed.
Scale	Defines the vertical and horizontal axes.

Modulation Params tab – 802.11ad/11ay

The Modulation Params tab specifies the type of modulation used by the input signal and other parameters that define the signal format. This tab is available for the 802.11ad/11ay EVM vs Time, Constellation, Symbol Table, and Summary displays.

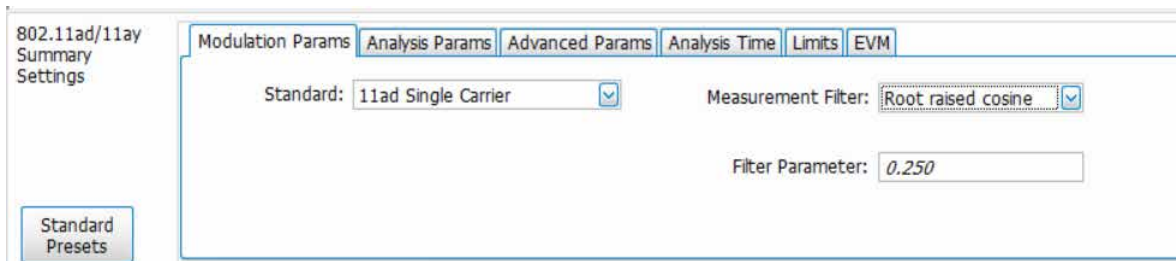

Settings	Description
Standard	Specifies the standard used for the input signal. Choices are 802.11ad Control PHY, 802.11ad Single Carrier, and 802.11ay Single Carrier.
Measurement filter	Specify whether a filter is used to limit the bandwidth of the input signal. Options are None and Root Raised Cosine.
Filter parameter	Enter a value used for defining the alpha parameter for Root Raised Cosine filter. (Not present when Measurement filter is None.)
Channel BW	Specifies whether channel bandwidth configuration for 802.11ay is 2.16 GHz or 4.32 GHz. Option visible only for 802.11ay Single Carrier modulation.
Region	Specifies the region to show in the Constellation, EVM and Symbol Table Displays when 11ay Single Carrier 4.32GHz Channel BW is chosen. Options are preEDMG1, preEDMG2 and EDMG. Replay is required if this option is changed.
Band	When a non EDMG duplicate mode is detected, a lower band (2GUID-A88BD14F-0A29-4276-A887-CB84AB2B2A94L) or upper band (2GUID-A88BD14F-0A29-4276-A887-CB84AB2B2A94U) can be selected using the drop-down list.

Analysis Params tab – 802.11ad/11ay

This tab contains parameters to control the analysis of the input signal. This tab is available for the 802.11ad/11ay EVM vs Time, Constellation, Symbol Table, and Summary displays.

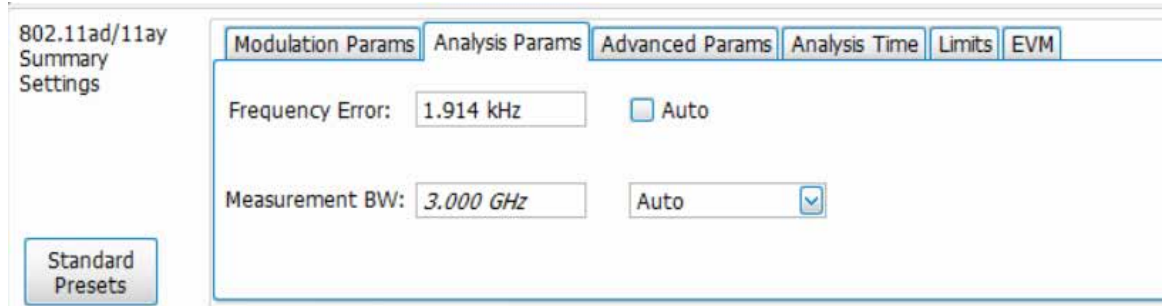

Settings	Description
Frequency Error	When Auto is checked, the analysis determines the Frequency Error and the measured Frequency Error is displayed. When unchecked, the entered value is used by the analysis as fixed frequency offset. This is useful when the exact frequency offset of the signal is known.
Measurement BW	Specifies the bandwidth about the center frequency at which measurements are made. Select Manual, Auto, or Link to Span.

Advanced Params tab – 802.11ad/11ay

This tab specifies additional parameters that control the demodulation of the signal. This tab is available for the 802.11ad/11ay EVM vs Time, Constellation, Symbol Table, and Summary displays. Not all settings appear for every display.



Settings	Description
Enable DC Offset Correction	Enables DC offset correction before EVM results are calculated.
Blockwise Correction	Enables impairments correction in a blockwise approach. This selection allows you to see if impairments like frequency error vary within the packet. Disabled by default.
SFO Tracker	Enables tracking and correction of Symbol Timing (Tc) errors and offsets. When disabled, the symbol timing offset is computed based on STF region (EDMG STF region in 802.11ay 4.23 GHz) and corrected for the entire packet. When enabled, it estimates and corrects for Symbol Timing errors for each data block and preamble/header regions. This option should be enabled when the reference clock of the oscilloscope is not synchronized to the transmitter.
Tracking Equalizer	In addition to the Preamble based equalizer, the Tracking Equalizer helps to correct for residual channel errors across each data block in the packet. The Tracking Equalizer coefficients are updated for each data block based on the initial set of data symbols, and applied for the full data/guard block. The coefficients are updated according to a Least Mean Square algorithm.

Table continued...

Settings	Description
Save Chan Imp Resp As...	<p>Opens a file dialogue box that allows you to save the Estimated Channel Impulse response (128 coefficients). You can save it as a .txt or .csv file.</p> <p>The saved file will have two columns. The first and the second columns give the 128 real and imaginary coefficients, respectively.</p> <p>The generated coefficients are that of the last analyzed acquisition.</p> <p>The impulse response will show an early and a late multipath propagation.</p> <p>When channel response coefficients are plotted, the horizontal axis represents symbols.</p>
OFF	The EVM measurement is done with the equalizer switched off.
Non Adaptive (CEF)	The EVM measurement is done with an equalizer that is non-adaptive and the equalization is done based on the data in Channel Estimation Field (CEF).
Adaptive (STF and CEF)	The EVM measurement is done with the equalizer that adapts its coefficients from acquisition to acquisition. Equalization in this case is done based on the data in the Short Training Field (STF) and Channel Estimation Field (CEF) regions.
Mode	Specifies whether the equalizer is in learning (Train) mode or analysis (Hold) mode.
Convergence	Specifies the update rate.
Taps/Symbol	The number of filter coefficients per symbol used by the filter
Taps	The number of filter coefficients. Range: 3 to 100 (you can set a higher number, but 100 is the practical limit).
Length	Specifies the number of symbols analyzed (or filter length).
Reset Equalization	<p>Resets the equalizer.</p> <p>You can read more about how to use the equalizer in the topic here.</p>
Swap I & Q	Enables swapping of I & Q when there are multiple up converter stages.

Analysis Time tab – 802.11ad/11ay

This tab contains parameters that define how the signal is analyzed in the 802.11ad/11ay EVM vs Time, Constellation, Symbol Table, and Summary displays.

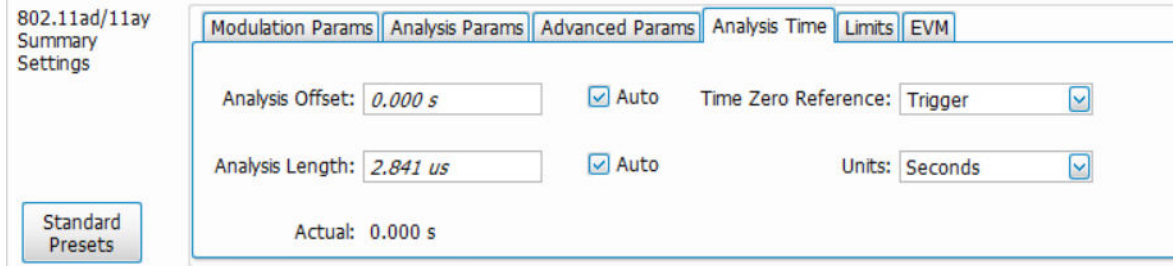

Settings	Description
Analysis Offset	Specifies the location of the first time sample to use in measurements.
Auto	When enabled, causes the instrument to set the Analysis Offset value based on the requirements of the selected display.
Analysis Length	Specifies the length of the analysis period to use in measurements. Length is specified in either symbols or seconds, depending on the Units.
Auto	When enabled, causes the instrument to set the Analysis Length value based on the requirements of the selected display.
Actual	This readout displays the analysis length (time or symbols) used by the analyzer. This value may not match the Analysis Length requested in manual mode.
Time Zero Reference	Specifies the zero point for the analysis time.
Units	Specifies the units of the analysis length to either Symbols or Seconds.

Analysis offset

Use analysis offset to specify where measurements begin. Be aware that you cannot set the Analysis Offset outside the range of time covered by the current acquisition data (all time values are relative to the Time Zero Reference).

You can set the Analysis Length so that the requested analysis period falls partly or entirely outside the current range of acquisition data settings. When the next acquisition is taken, its Acquisition Length will be increased to cover the new Analysis Length, as long as the Sampling controls are set to Auto. If the Sampling parameters are set to manual, or if the instrument is analyzing saved data, the actual analysis length will be constrained by the available data length, but in most cases, measurements are able to be made anyway. The instrument will display a notification when measurement results are computed from less data than requested. Range: 0 to [(end of acquisition) - Analysis Length]. Resolution: 1 effective sample (or symbol).

Analysis length

Use the analysis length to specify how long a period of time is analyzed. As you adjust this value, the actual amount of time for Analysis Length, in Symbol or Seconds units, is shown below the control in the "Actual" readout. This setting is not available when Auto is checked. Range: minimum value depends on modulation type. Resolution: 1 symbol.

Time zero reference

All time values are measured from this point (such as marker position or horizontal position (in Y vs Time displays). Choices are: Acquisition Start or Trigger.

Acquisition Start sets the analyzer to measure the offset from the starting point of the acquisition.

Trigger sets the analyzer to measure the offset from the trigger point of the acquisition.

EVM tab – 802.11ad/11ay

This tab enables you to set the EVM Units, Data Start, and Data Length. Not all settings appear for every display.

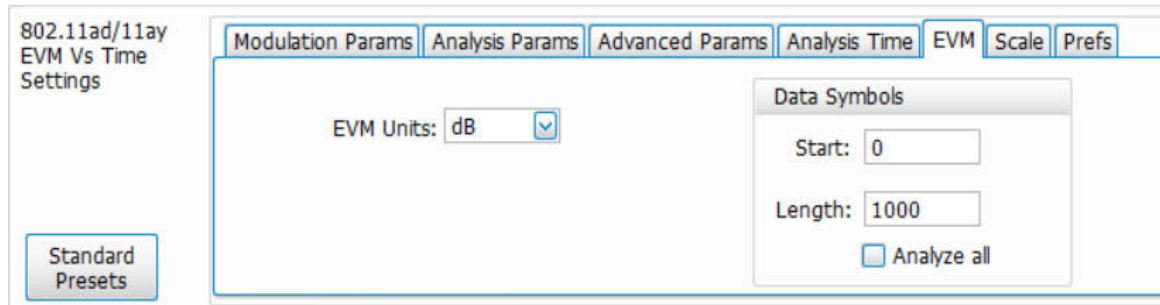

Figure 65: The above image is the EVM tab for the 802.11ad/11ay EVM vs Time and Constellation displays for 802.11ad Single Carrier and 802.11ay Single Carrier

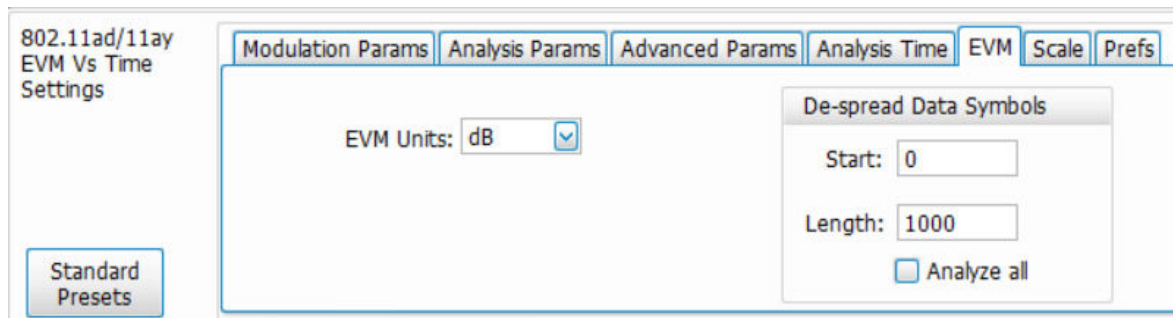

Figure 66: The above image is the EVM tab for the 802.11ad/11ay EVM vs Time and Constellation displays for 802.11ad Control PHY

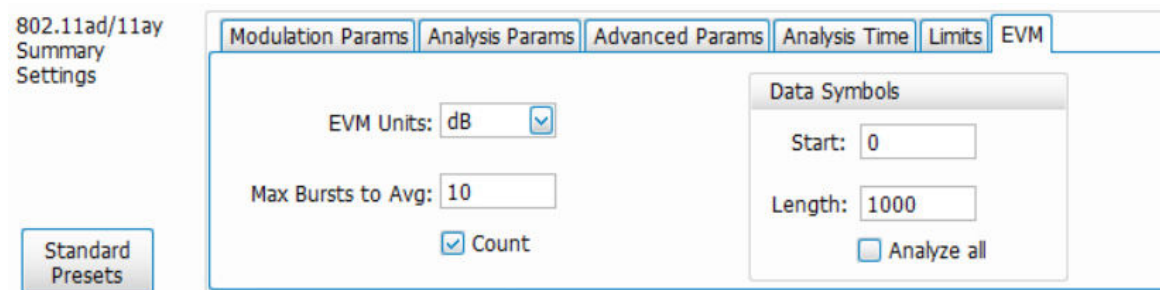

Figure 67: The above image is the EVM tab for the 802.11ad/11ay Summary display for 802.11ad Single Carrier

Settings	Description
EVM Units	Specifies whether the displayed EVM units are dB or percent.
Max Bursts to Avg	Specifies the maximum number of acquisitions to average when Count is selected.
Count	Enables the Avg function. Multiple acquisitions are averaged when this is enabled.

Table continued...

Settings	Description
Data Symbols (for Single Carrier) De-spread Data Symbols (for Control PHY)	
Start	Specified the EVM measurement start data symbol.
Length	Specifies the length in terms of Data Symbols to analyze the EVM in data region starting from Start.
Analyze all	Check to analyze all data symbols in the packet. When checked, Start and Length options will be disabled. However, Length will be automatically updated to the number of data symbols analyzed when this option is selected.

Scale tab – 802.11ad/11ay

This tab allows you to change the scale settings that control how the trace appears on the display but does not change control settings such as Measurement Frequency. There are two versions of the Scale tab for 802.11ad/11ay displays. One version is used for Constellation display, and one for EVM vs Time. Not all settings appear for every display.

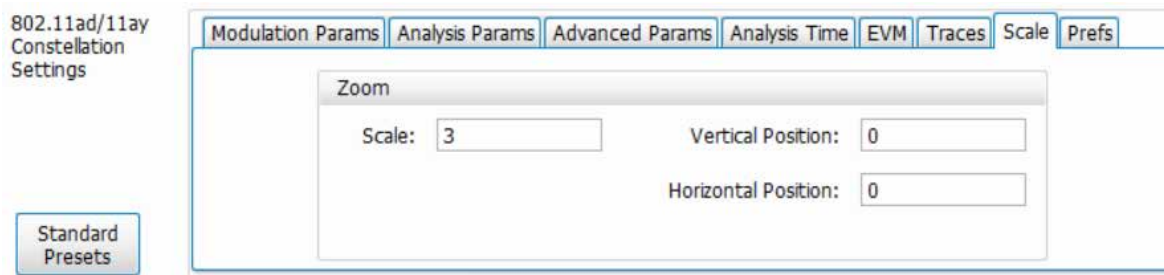

Figure 68: The above image is the Scale tab for the 802.11ad/11ay Constellation display

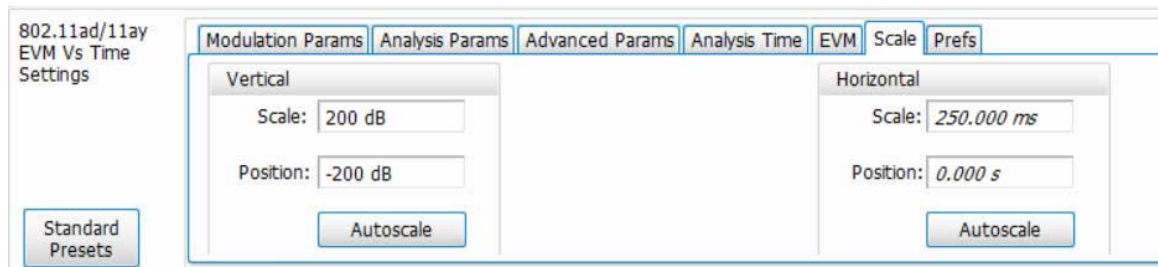

Figure 69: The above image is the Scale tab for the 802.11ad/11ay EVM vs Time display

Settings	Description
Vertical	
Scale	Changes the vertical scale.
Position	Adjusts the reference level away from top of the graph.

Table continued...

Settings	Description
Autoscale	Resets the scale of the vertical axis to contain the complete trace.
Horizontal	
Scale	Changes the horizontal scale.
Position	Adjusts the reference level away from top of the graph.
Autoscale	Resets the scale of the vertical axis to contain the complete trace.
Zoom	
Scale	Sets the magnification value for the Constellation display.
Vertical position	Sets the vertical location of the Constellation display within the graph.
Horizontal position	Sets the horizontal location of the Constellation display within the graph.

Prefs tab – 802.11ad/11ay

This tab enables you to change appearance characteristics of the 802.11ad/11ay Analysis displays. Not all settings appear for every display.

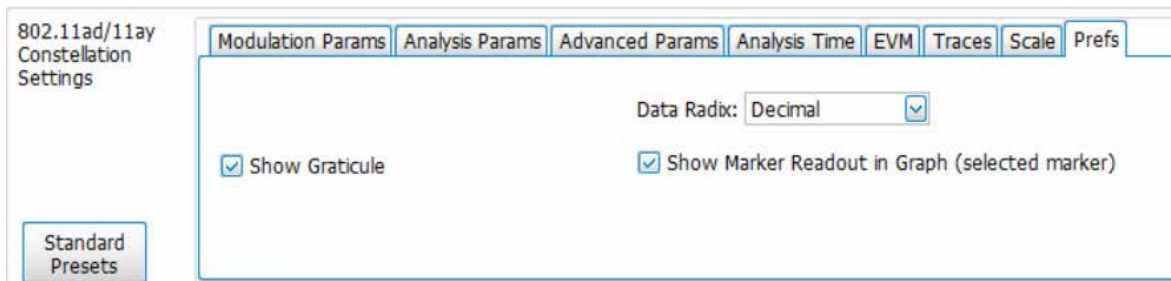

Figure 70: The above image is the Prefs tab for the 802.11ad/11ay Constellation display

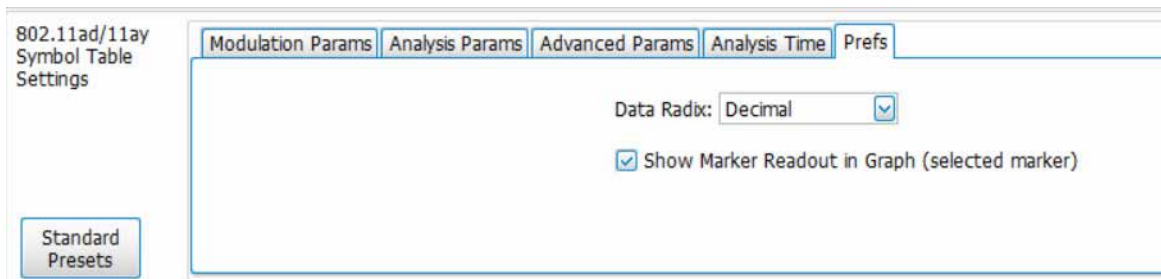

Figure 71: The above image is the Prefs tab for the 802.11ad/11ay Symbol Table display

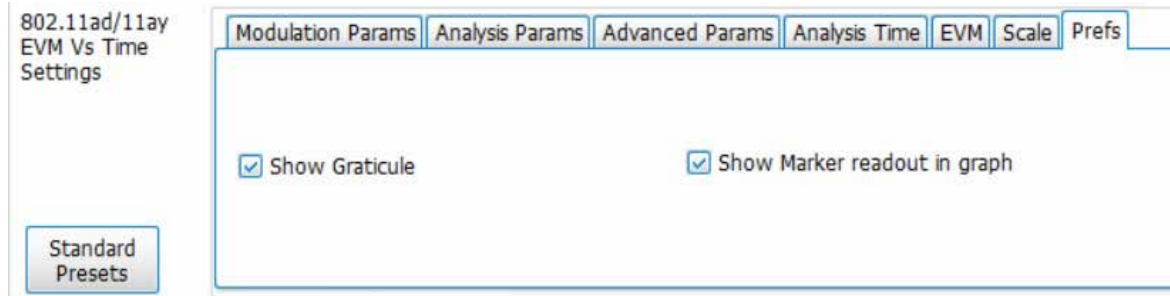
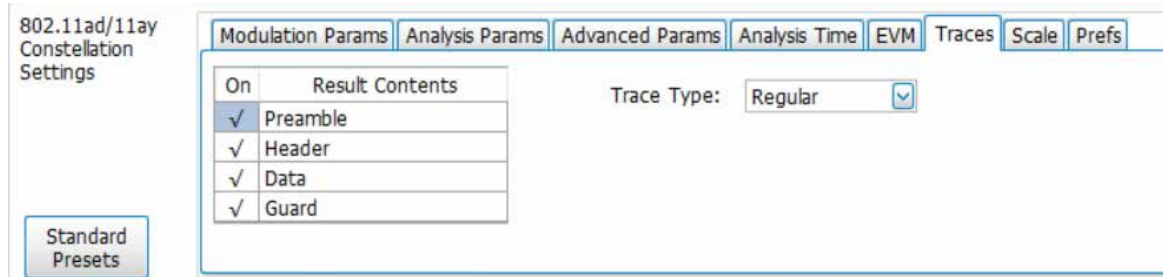

Figure 72: The above image is the Prefs tab for the 802.11ad/11ay EVM vs Time display

Settings	Description
Data radix	Specifies whether symbol values are displayed in binary or decimal format (for example, in the Symbol Table or markers readouts).
Show graticule	Specifies to show the graticule on the display when checked.
Show Marker readout in graph (selected marker)	Specifies to show the marker readout when checked.

Traces tab – 802.11ad/11ay

This tab allows you to set the trace display characteristics of the selected display.



Settings	Description
Trace Type	Specifies the trace type is regular or pi/2 rotated.
Result Contents	Selects which regions of the packet to show in constellation display. You can choose from Preamble, Header, Guard, and Data for Single Carrier. You can choose from Preamble, Header, and Data for Control PHY.

Limits tab – 802.11ad/11ay

This tab allows you to load an existing limits table, save a limits table, or edit limits values. By default, FreqErrorLimit is turned on and EVMLimit is turned off. This tab is available for the 802.11ad/11ay Summary display only.

802.11ad/11ay
Summary
Settings

Standard Presets

Modulation Params Analysis Params Advanced Params Analysis Time Limits EVM

	On	Measurement Name	Limit
	<input type="checkbox"/>	EVMLimit	-6 dB
	<input checked="" type="checkbox"/>	FreqErrorLimit	20.0 ppm

Load...

Save...

Settings	Description
On	Click on a cell in the On column next to the measurement name to specify whether or not measurements are selected for limit comparison to indicate Pass or Fail. EVMLimit is off by default and FreqErrorLimit is on by default.
Measurement Name	Specifies the name of the measurement related to the limit (not editable).
Limit	Specifies the value of the limit to the related measurement. When the cell is selected, the value is shown along with the units. This is editable.
Load	Click to load a saved Limits table from a .csv file.
Save	Click to save the current Limits table to a .csv file.

Edit Limits

To directly edit measurement limits in the table, click on the value in the Limit column that you want to change.

OFDM Analysis

OFDM Analysis Overview

The OFDM Analysis option provides measurements for OFDM signals specified by 802.11a/g/j (Wifi) and 802.16 (2004) (commonly known as Fixed WiMAX) standards. User controls allow you to modify signal parameters for analysis of non-standard signals. The analysis results give multiple views of OFDM signal characteristics to allow diagnosing signal imperfections and impairments quickly and easily. Display controls provide the ability to selectively display the analysis results to help locate trouble-spots in the signal.

The displays in OFDM Measurements (Displays > Measurements > OFDM Measurements) are:

- [OFDM Channel Response](#)
- [OFDM Constellation](#)
- [OFDM EVM](#)
- [OFDM Spectral Flatness](#)
- [OFDM Mag Error](#)
- [OFDM Phase Error](#)
- [OFDM Power](#)
- [OFDM Summary](#)
- [OFDM Symbol Table](#)

OFDM Channel Response Display

The OFDM Channel Response display plots the channel response (magnitude or phase) versus the subcarrier or frequency. Here, the channel refers to all sources of signal frequency response impairment up to the analyzer input, including the transmitter itself, as well as any transmission medium through which the signal travels between the transmitter and the analyzer.

To show the OFDM Channel Response display:

1. If you are analyzing a stored data file, recall the data file now. Otherwise, go to the next step.
2. Press the **Displays** button or select **Setup > Displays**.
3. In the **Select Displays** dialog, select **OFDM Analysis** in the **Measurements** box.
4. In the Available displays box, double-click the **OFDM Chan Response** icon or select the icon and click **Add**. The OFDM Chan Response icon will appear in the **Selected displays** box and will no longer appear under Available displays.
5. Click **OK** to show the OFDM Chan Response display.
6. Set the Frequency appropriate for the signal.
7. Select **Setup > Settings** to display the control panel.
8. Select the Modulation Params tab. Set the Standard, Guard Interval and Spacing and Bandwidth controls as appropriate for the input signal.
9. If you are analyzing a stored data file, press the **Replay** button to take measurements on the recalled acquisition data file.

Elements of the Display

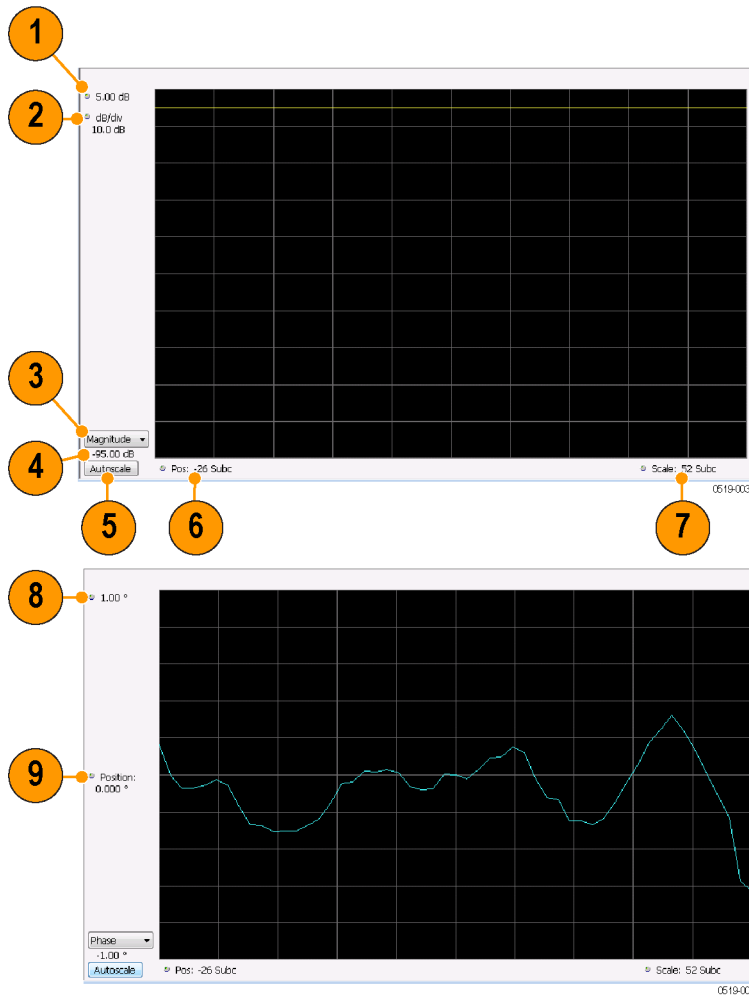

Item	Display element	Description
1	Top-of-graph (magnitude)	Sets the level that appears at the top of the magnitude graph. This is only a visual control for panning the graph. The Reference Level is adjusted in the Toolbar and the Ampl control panel. By default, Vert Position = Ref Level.
2	dB/div (magnitude)	Sets the vertical scale value. The maximum value is 20.00 dB/division.
3	Display selector	Selects the display type. Channel Response Magnitude or Phase can be displayed as a Magnitude or Phase graph.
4	Bottom-of-graph readout (magnitude)	Indicates the amplitude at the bottom of the graph. This value changes with the dB/div and Vertical Position settings.
5	Autoscale	Adjusts the Vertical and Horizontal scaling to display the optimize the trace display on screen.

Table continued...

Item	Display element	Description
6	Pos	Shifts the trace left or right in the graph. The readout indicates the subcarrier or frequency shown at the left edge of the display.
7	Scale	Specifies the number of subcarriers shown in the graph.
8	Top-of-graph (phase)	Sets the phase value indicated at the top of the graph. Since the Position value at the vertical center of this graph remains constant as the Top of Graph value is adjusted, the Vertical Scale increases as the Top of Graph value increases, which also affects the bottom of graph readout.
9	Position (phase)	Specifies the phase shown at the center of the graph display. Changing this value moves the trace up and down in the graph, which affects the Top of Graph and Bottom of Graph values as well.
10	Bottom-of-graph (phase)	Indicates the phase at the bottom of the graph. This value changes with the Position setting.

OFDM Channel Response Settings

The OFDM Channel Response Settings control panel provides access to settings that control parameters of the Channel Response Display.

Settings tab	Description
Modulation Params	Specifies the input signal standard and additional user-settable signal parameters.
Advanced Params	Specifies parameters used by the instrument to analyze the input signal.
Data Range Tab	Specifies which symbols and subcarriers of the signal to display.
Analysis Time Tab	Specifies parameters that define the portion of the acquisition record that is used for analysis. Also allows you to specify the time units (Symbols or Seconds) for OFDM Analysis displays.
Prefs Tab	Specifies the units of the display and whether elements of the graphs are displayed.

OFDM Constellation Display

Display shows the OFDM signal subcarriers' amplitude and phase in IQ constellation form.

To show the OFDM Constellation display:

1. If you are analyzing a stored data file, recall the data file now. Otherwise, go to the next step.
2. Press the **Displays** button or select **Setup > Displays**.
3. In the **Select Displays** dialog, select **OFDM Constellation** in the **Measurements** box.
4. In the Available displays box, double-click the **OFDM Constellation** icon or select the icon and click **Add**. The OFDM Constellation icon will appear in the **Selected displays** box and will no longer appear under Available displays.

5. Click **OK** to show the OFDM Constellation display.
6. Set the **Frequency** appropriate for the signal.
7. Select **Setup > Settings** to display the control panel.
8. Select the **Modulation Params** tab. Set the Standard, Guard Interval and Spacing and Bandwidth controls as appropriate for the input signal.
9. If you are analyzing a stored data file, press the **Replay** button to take measurements on the recalled acquisition data file.

Elements of the Display

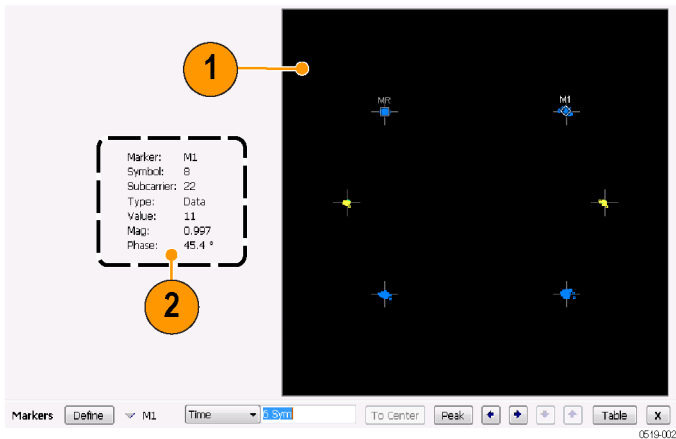

Item	Display element	Description
1	Plot	Constellation graph.
2	Marker Readout	If markers are enabled, the marker readout shows the selected Marker, Symbol, Subcarrier, Type, Value, Magnitude, and Phase for the symbol at the marker location. Located to the left of the constellation plot or below it, depending on the size of the window.

OFDM Constellation Settings

Main menu bar: **Setup > Settings**

Favorites toolbar: 

The OFDM Constellation Settings control panel provides access to settings that control parameters of the Constellation Display.

Settings tab	Description
Modulation Params	Specifies the input signal standard and additional user-settable signal parameters.
Advanced Params	Specifies parameters used by the instrument to analyze the input signal.
Data Range	Specifies which symbols and subcarriers of the signal to display.

Table continued...

Settings tab	Description
Analysis Time Tab	Specifies parameters that define the portion of the acquisition record that is used for analysis. Also allows you to specify the Units (Symbols or Seconds) for OFDM Analysis displays.
Trace	Enables you to freeze the display or hide the measurement or average trace.
Scale Tab	Specifies the Zoom scale, and vertical and horizontal positions of the display.
Prefs Tab	Specifies the units of the display and whether elements of the graphs are displayed.

OFDM EVM Display

The OFDM EVM display shows the data symbols' individual subcarrier Error Vector Magnitude values versus symbol interval (time) and subcarrier (frequency).

To show the OFDM EVM display:

1. If you are analyzing a stored data file, recall the data file now. Otherwise, go to the next step.
2. Press the **Displays** button or select **Setup > Displays**.
3. In the **Select Displays** dialog, select **OFDM EVM** in the **Measurements** box.
4. In the Available displays box, double-click the **OFDM EVM** icon or select the icon and click **Add**. The OFDM EVM icon will appear in the **Selected displays** box and will no longer appear under Available displays.
5. Click **OK** to show the OFDM EVM display.
6. Set the **Frequency** appropriate for the signal.
7. Select **Setup > Settings** to display the control panel.
8. Select the **Modulation Params** tab. Set the Standard as appropriate. Set the Standard, Guard Interval and Spacing and Bandwidth controls as appropriate for the input signal.
9. If you are analyzing a stored data file, press the **Replay** button to take measurements on the recalled acquisition data file.

Elements of the Display

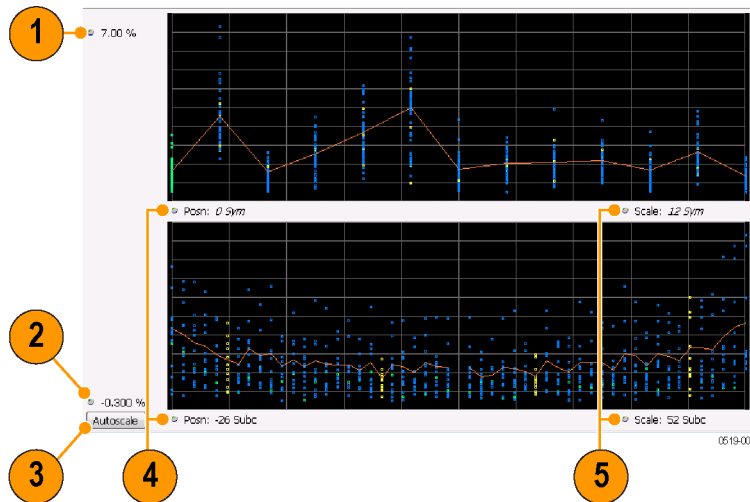



Note: There is no carrier assigned to DC.

Item	Display element	Description
1	Top of graph	Sets the EVM value that appears at the top of the graph. This is only a visual control for panning the graph.
2	Bottom of graph	Sets the EVM value that appears at the bottom of the graph. This is only a visual control for panning the graph.
3	Autoscale	Adjusts the vertical and horizontal settings to provide the best display.
4	Pos	Specifies the horizontal position of the trace on the graph display.
5	Scale	Adjusts the horizontal range of the graph. By decreasing the scale, the graph essentially becomes a window that you can move over the analysis results by adjusting the position.

OFDM EVM Settings

Main menu bar: Setup > Settings

Favorites toolbar:

The settings for the OFDM EVM display are shown in the following table.

Settings tab	Description
Modulation Params	Specifies the type of modulation used for the input signal and other parameters.
Advanced Params	Specifies parameters used by the instrument to analyze the input signal.
Data Range	Specifies which symbols and subcarriers of the signal to display.
Analysis Time	Specifies parameters that define the portion of the acquisition record that is used for analysis. Also allows you to specify the Units (Symbols or Seconds) for OFDM Analysis displays.
Trace	Enables you to freeze the display or hide the measurement or average trace.
Scale	Specifies the vertical, subcarrier, and symbols scale and position settings.
Prefs	Specifies the units of the display and whether elements of the graphs are displayed.

OFDM Spectral Flatness Display

The OFDM Spectral Flatness display shows the average power levels of subcarriers across the signal bandwidth and indicates if they remain within the limits defined for a particular standard.

The averaged subcarrier level is shown as a line on the display, while the individual subcarrier levels are shown as points. The Pass or Fail result indicates whether the average line remains between the upper and lower limit mask boundaries.

To show the OFDM Spectral Flatness display:

1. If you are analyzing a stored data file, recall the data file now. Otherwise, go to the next step.
2. Press the **Displays** button or select **Setup > Displays**.
3. In the **Select Displays** dialog, select **OFDM Analysis** in the **Measurements** box.

4. In the Available displays box, double-click the **OFDM Flatness** icon or select the icon and click **Add**. The OFDM Flatness icon will appear in the **Selected displays** box and will no longer appear under Available displays.
5. Click **OK** to show the OFDM Flatness display.
6. Set the **Frequency** appropriate for the signal.
7. Select **Setup > Settings** to display the control panel.
8. Select the **Modulation Params** tab. Set the Standard, Guard Interval, Subcarrier Spacing and Channel Bandwidth controls as appropriate for the input signal.
9. If you are analyzing a stored data file, press the **Replay** button to take measurements on the recalled acquisition data file.

Elements of the Display

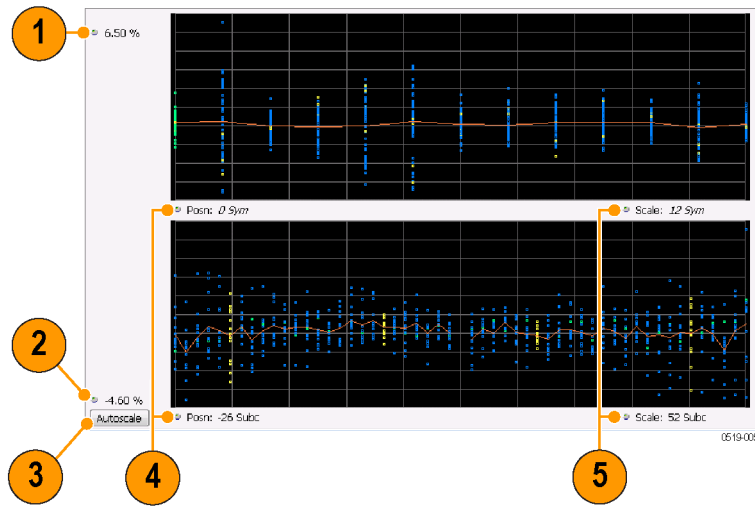

Item	Display element	Description
1	Top of graph	Sets the Flatness value that appears at the bottom of the graph in dB. This is only a visual control for panning the graph.
2	Bottom of graph	Shows the Flatness value set at the top of the graph.
3	Autoscale	Adjusts the vertical and horizontal settings to provide the best display.
4	Pos	Specifies the horizontal position of the trace on the graph display.
5	Scale	Adjusts the horizontal range of the graph. By decreasing the scale, the graph essentially becomes a window that you can move over the analysis results by adjusting the position.

OFDM Spectral Flatness Settings

Main menu bar: **Setup > Settings**

Favorites toolbar: 

The settings for the OFDM Spectral Flatness display are shown in the following table.

Settings tab	Description
Modulation Params	Specifies the type of modulation used for the input signal and other parameters.

Table continued...

Settings tab	Description
Advanced Params	Specifies parameters used by the instrument to analyze the input signal.
Data Range	Specifies which symbols and subcarriers of the signal to display.
Analysis Time	Specifies parameters that define the portion of the acquisition record that is used for analysis. Also allows you to specify the Units (Symbols or Seconds) for WLAN Analysis displays.
Trace	Enables you to display or hide the measurement or average trace.
Scale Tab	Specifies the vertical, subcarrier, and symbols scale and position settings.
Prefs Tab	Specifies the units of the display and whether elements of the graphs are displayed.

OFDM Magnitude Error Display

The OFDM Mag Error display shows the data symbols' individual subcarrier Magnitude Error values versus symbol interval (time) and subcarrier (frequency).

To show the OFDM Magnitude Error display:

1. If you are analyzing a stored data file, recall the data file now. Otherwise, go to the next step.
2. Press the **Displays** button or select **Setup > Displays**.
3. In the **Select Displays** dialog, select **OFDM Analysis** in the **Measurements** box.
4. In the Available displays box, double-click the **OFDM Mag Error** icon or select the icon and click **Add**. The OFDM Mag Error icon will appear in the **Selected displays** box and will no longer appear under Available displays.
5. Click **OK** to show the OFDM Mag Error display.
6. Set the **Frequency** appropriate for the signal.
7. Select **Setup > Settings** to display the control panel.
8. Select the **Modulation Params** tab. Set the Standard, Guard Interval and Spacing and Bandwidth controls as appropriate for the input signal.
9. If you are analyzing a stored data file, press the **Replay** button to take measurements on the recalled acquisition data file.

Elements of the Display

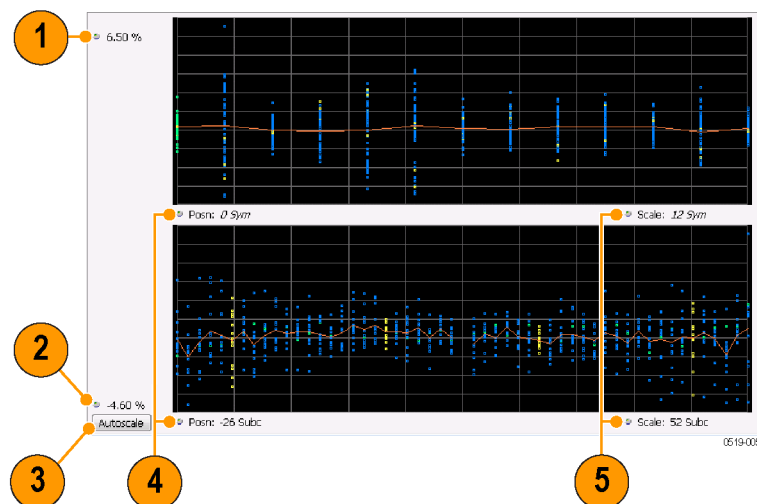

Item	Display element	Description
1	Top of graph	Sets the Magnitude Error value that appears at the top of the graph. This is only a visual control for panning the graph.
2	Bottom of graph	Sets the Magnitude Error value that appears at the bottom of the graph. This is only a visual control for panning the graph.
3	Autoscale	Adjusts the vertical and horizontal settings to provide the best display.
4	Pos	Specifies the horizontal position of the trace on the graph display.
5	Scale	Adjusts the horizontal range of the graph. By decreasing the scale, the graph essentially becomes a window that you can move over the analysis results by adjusting the position.

OFDM Magnitude Error Settings

Main menu bar: Setup > Settings

Favorites toolbar: 

The settings for the OFDM Mag Error display are shown in the following table.

Settings tab	Description
Modulation Params	Specifies the type of modulation used for the input signal and other parameters.
Advanced Params	Specifies parameters used by the instrument to analyze the input signal.
Data Range	Specifies which symbols and subcarriers of the signal to display.
Analysis Time Tab	Specifies parameters that define the portion of the acquisition record that is used for analysis. Also allows you to specify the Units (Symbols or Seconds) for OFDM Analysis displays.
Trace	Enables you to display or hide the measurement or average trace.
Scale Tab	Specifies the vertical, subcarrier, and symbols scale and position settings.
Prefs Tab	Specifies the units of the display and whether elements of the graphs are displayed.

OFDM Phase Error Display

The OFDM Phase Error display shows the data symbols' individual subcarrier Phase Error values versus symbol interval (time) and subcarrier (frequency).

To show the OFDM Phase Error display:

1. If you are analyzing a stored data file, recall the data file now. Otherwise, go to the next step.
2. Press the **Displays** button or select **Setup > Displays**.
3. In the **Select Displays** dialog, select **OFDM Analysis** in the **Measurements** box.
4. In the Available displays box, double-click the **OFDM Phase Error** icon or select the icon and click **Add**. The OFDM Phase Error icon will appear in the **Selected displays** box and will no longer appear under Available displays.
5. Click **OK** to show the OFDM Phase Error display.
6. Set the **Frequency** appropriate for the signal.
7. Select **Setup > Settings** to display the control panel.

8. Select the **Modulation Params** tab. Set the Standard, Guard Interval and Spacing and Bandwidth controls as appropriate for the input signal.
9. If you are analyzing a stored data file, press the **Replay** button to take measurements on the recalled acquisition data file.

Elements of the Display

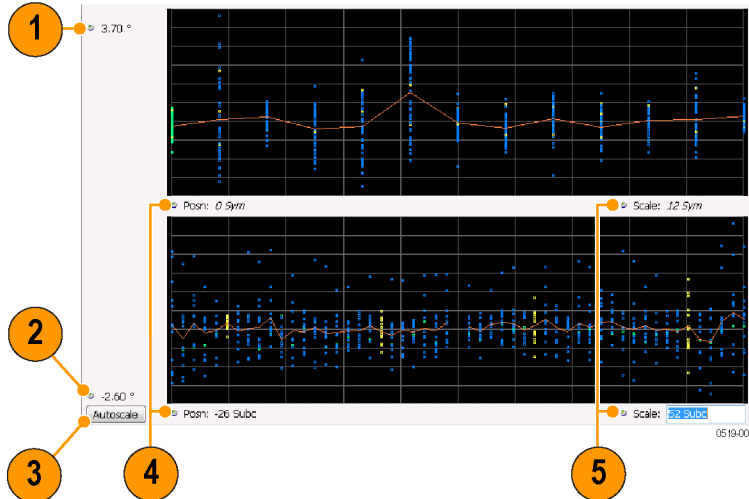

Item	Display element	Description
1	Top of graph	Sets the Phase Error value that appears at the top of the graph. This is only a visual control for panning the graph.
2	Bottom of graph	Sets the Phase Error value that appears at the bottom of the graph. This is only a visual control for panning the graph.
3	Autoscale	Adjusts the vertical and horizontal settings to provide the best display.
4	Pos	Specifies the horizontal position of the trace on the graph display.
5	Scale	Adjusts the horizontal range of the graph. By decreasing the scale, the graph essentially becomes a window that you can move over the analysis results by adjusting the position.

OFDM Phase Error Settings

Main menu bar: **Setup > Settings**

Favorites toolbar:

The settings for the OFDM Phase Error display are shown in the following table.

Settings tab	Description
Modulation Params	Specifies the type of modulation used for the input signal and other parameters.
Advanced Params	Specifies parameters used by the instrument to analyze the input signal.
Data Range	Specifies which symbols and subcarriers of the signal to display.
Analysis Time Tab	Specifies parameters that define the portion of the acquisition record that is used for analysis. Also allows you to specify the Units (Symbols or Seconds) for OFDM Analysis displays.

Table continued...

Settings tab	Description
Trace	Enables you to display or hide the measurement or average trace.
Scale Tab	Specifies the vertical, subcarrier, and symbols scale and position settings.
Prefs Tab - OFDM on page 356	Specifies the units of the display and whether elements of the graphs are displayed.

OFDM Power Display

The OFDM Power display shows the data symbols' individual subcarrier Power values versus symbol interval (time) and subcarrier (frequency).

To show the OFDM Power display:

1. If you are analyzing a stored data file, recall the data file now. Otherwise, go to the next step.
2. Press the **Displays** button or select **Setup > Displays**.
3. In the **Select Displays** dialog, select **OFDM Analysis** in the **Measurements** box.
4. In the Available displays box, double-click the **OFDM Power** icon or select the icon and click **Add**. The OFDM Power icon will appear in the **Selected displays** box and will no longer appear under Available displays.
5. Click **OK** to show the OFDM Power display.
6. Set the **Frequency** appropriate for the signal.
7. Select **Setup > Settings** to display the control panel.
8. Select the **Modulation Params** tab. Set the Standard, Guard Interval and Spacing and Bandwidth controls as appropriate for the input signal.
9. If you are analyzing a stored data file, press the **Replay** button to take measurements on the recalled acquisition data file.

Elements of the Display

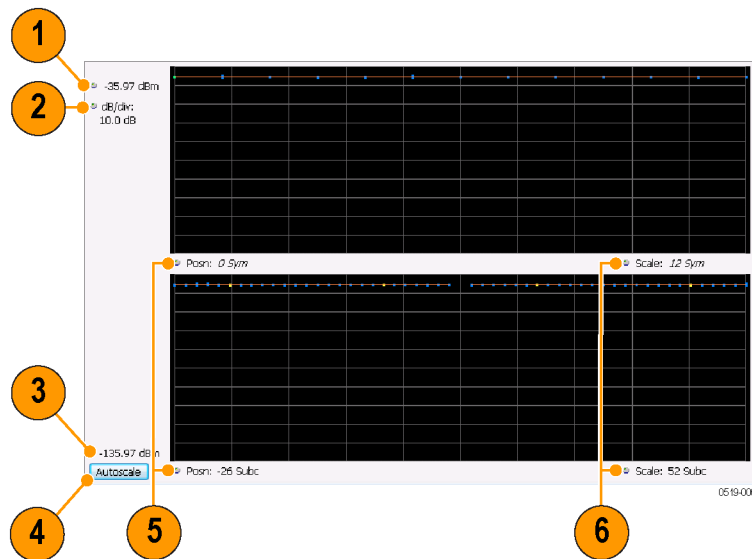

Item	Display element	Description
1	Vertical Position	Sets the top of graph value. This is only a visual control for panning the graph. The Reference Level is adjusted in the Toolbar and the Ampl control panel. By default, Vert Position = Ref Level.
2	dB/div	Sets the vertical scale value. The maximum value is 20.00 dB/division.
(not shown)	Units	Sets the global amplitude units for all the views in the analysis window. This will change the amplitude selection in the Units tab of the Amplitude control panel.
2	Bottom of graph readout	Indicates the amplitude at the bottom of the graph. This value changes with the dB/div and Vertical Position settings.
3	Autoscale	Adjusts the vertical and horizontal settings to provide the best display.
4	Pos	Specifies the horizontal position of the trace on the graph display.
5	Scale	Adjusts the horizontal range of the graph. By decreasing the scale, the graph essentially becomes a window that you can move over the analysis results by adjusting the position.

OFDM Power Settings

Main menu bar: **Setup > Settings**

Favorites toolbar: 

The settings for the OFDM Power display are shown in the following table.

Settings tab	Description
Modulation Params	Specifies the type of modulation used for the input signal and other parameters.
Advanced Params	Specifies parameters used by the instrument to analyze the input signal.
Data Range	Specifies which symbols and subcarriers of the signal to display.
Analysis Time	Specifies parameters that define the portion of the acquisition record that is used for analysis. Also allows you to specify the Units (Symbols or Seconds) for OFDM Analysis displays.
Trace	Enables you to display or hide the measurement or average trace.
Scale	Specifies the vertical, subcarrier, and symbols scale and position settings.
Prefs	Specifies the units of the display and whether elements of the graphs are displayed.

OFDM Summary Display

The OFDM Summary display shows several measurements of OFDM signal quality.

To show the OFDM Summary display:

1. If you are analyzing a stored data file, recall the data file now. Otherwise, go to the next step.
2. Press the **Displays** button or select **Setup > Displays**.
3. In the **Select Displays** dialog, select **OFDM Analysis** in the **Measurements** box.
4. In the Available displays box, double-click the **OFDM Summary** icon or select the icon and click **Add**. The OFDM Summary icon will appear in the **Selected displays** box and will no longer appear under Available displays.
5. Click **OK** to show the OFDM Summary display.

6. Set the **Frequency** appropriate for the signal.
7. Select **Setup > Settings** to display the control panel.
8. Select the **Modulation Params** tab. Set the Standard, Guard Interval and Spacing and Bandwidth controls as appropriate for the input signal.
9. If you are analyzing a stored data file, press the **Replay** button to take measurements on the recalled acquisition data file.

Elements of the Display

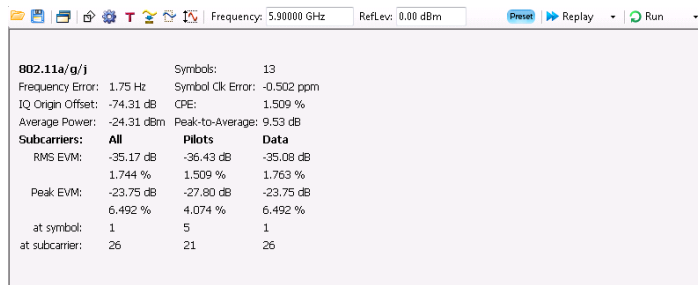

Measurement	Description
Standard	Display of the standard selected on the Setup > Settings > Modulation Params tab.
Frequency Error	The frequency difference between the measured carrier frequency of the signal and the measurement frequency setting.
IQ Origin Offset	The average magnitude of the DC subcarrier level relative to total signal power. It indicates the level of carrier feedthrough detected at the center (DC) subcarrier.
Average Power	The average power of all symbols in the analysis. Calculated over only the data symbols in the packet.
Symbols	How many symbols were analyzed.
Symbol Clk Error	The symbol clock error in parts per million.
CPE	CPE, Common Pilot Error, is the RMS magnitude error of the pilots over all analyzed symbols.
Peak-to-Average	The ratio of the highest instantaneous signal power level to the average signal power. Calculated over only the data symbols in the packet.
EVM	<p>The RMS and Peak values of the normalized subcarrier Error Vector Magnitude values. The normalized subcarrier EVM values are calculated as the difference between the detected received signal subcarrier constellation points and ideal reference points estimated by the instrument from the received signal. Values are reported in units of percent and dB. Peak values include the symbol and subcarrier location.</p> <p>RMS and Peak values are displayed for groupings of all subcarriers, Pilots only and Data only. Results are calculated over the entire signal packet analyzed, covering the number of Symbols indicated in the Summary display.</p>

OFDM Summary Settings

Main menu bar: **Setup > Settings**

Favorites toolbar: 

The settings for the OFDM Summary display are shown in the following table.

Settings tab	Description
Modulation Params	Specifies the type of modulation used for the input signal and other parameters.
Advanced Params	Specifies parameters used by the instrument to analyze the input signal.
Data Range	Specifies which symbols and subcarriers of the signal to display.
Analysis Time	Specifies parameters that define the portion of the acquisition record that is used for analysis. Also allows you to specify the Units (Symbols or Seconds) for OFDM Analysis displays.
Prefs	Specifies the units of the display and whether elements of the graphs are displayed.

OFDM Symbol Table Display

The OFDM Symbol Table display shows decoded data bits for each subcarrier in each symbol in the analyzed signal packet. Results are presented with subcarrier (frequency) indices in the horizontal dimension and symbol (time) intervals in the vertical dimension.

To show the OFDM Symbol Table display:

1. If you are analyzing a stored data file, recall the data file now. Otherwise, go to the next step.
2. Press the **Displays** button or select **Setup > Displays**.
3. In the **Select Displays** dialog, select **OFDM Analysis** in the **Measurements** box.
4. In the Available displays box, double-click the **OFDM Symb Table** icon or select the icon and click **Add**. The OFDM Symbol icon will appear in the **Selected displays** box and will no longer appear under Available displays.
5. Click **OK** to show the OFDM Symbol Table display.
6. Set the **Frequency** appropriate for the signal.
7. Select **Setup > Settings** to display the control panel.
8. Select the **Modulation Params** tab. Set the Standard, Guard Interval and Spacing and Bandwidth controls as appropriate for the input signal.
9. If you are analyzing a stored data file, press the **Replay** button to take measurements on the recalled acquisition data file.

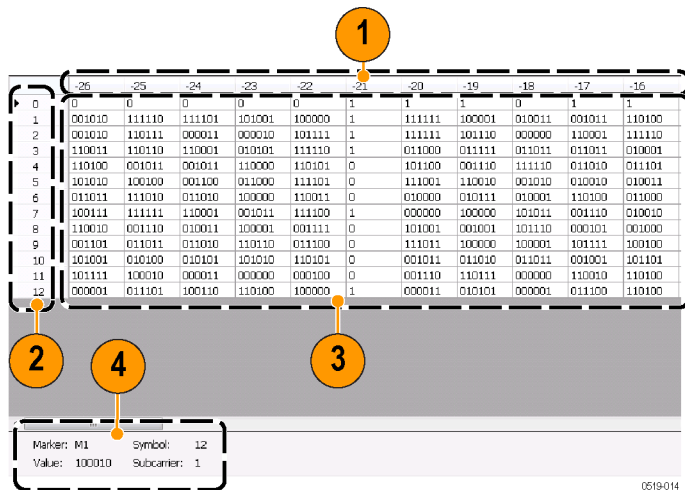

Item	Description
1	Subcarrier identifiers.

Table continued...

Item	Description
2	Symbol identifiers.
3	Subcarrier data values.
4	Marker readout when markers are enabled.

OFDM Symbol Table Settings

Main menu bar: Setup > Settings

Favorites toolbar: 

The settings for the OFDM Symbol Table display are shown in the following table.

Settings tab	Description
Modulation Params	Specifies the type of modulation used for the input signal and other parameters.
Advanced Params	Specifies parameters used by the instrument to analyze the input signal.
Data Range	Specifies which symbols and subcarriers of the signal to display.
Analysis Time	Specifies parameters that define the portion of the acquisition record that is used for analysis. Also allows you to specify the Units (Symbols or Seconds) for OFDM Analysis displays.
Prefs	Specifies the units of the display and whether elements of the graphs are displayed.

OFDM Analysis Shared Measurement Settings

Main menu bar: Setup > Settings

Favorites toolbar: 

The control panel tabs in this section are shared between the displays in the OFDM Analysis folder (Setup > Displays). Some tabs are shared by all the displays, some tabs are shared by only a couple of displays. The settings available on some tabs change depending on the selected display.

Table 21: Common controls for OFDM analysis displays

Settings tab	Description
Modulation Params	Specifies the type of modulation used for the input signal and other parameters.
Advanced Params	Specifies parameters used by the instrument to analyze the input signal.
Data Range	Specifies which symbols and subcarriers of the signal to display.
Analysis Time	Specifies parameters that define the portion of the acquisition record that is used for analysis. Also allows you to specify the Units (Symbols or Seconds) for OFDM Analysis displays.
Trace	Enables you to display or hide the measurement or average trace.
Scale	Specifies the vertical, subcarrier, and symbols scale and position settings.
Prefs	Specifies the units of the display and whether elements of the graphs are displayed.

Modulation Params Tab - OFDM

The Modulation Params tab specifies the type of modulation used by the input signal and other parameters that control the demodulation of the input signal.

Settings	Description
Standard	Specifies the standard used for the input signal. Choices are 802.11a/g/j and 802.16 (2004).
Guard Interval	Specifies the guard interval used in the input signal. Choices are 1/4, 1/8, 1/16/, 1/32, and User. When you select User, you can enter a percentage value to specify the size of the guard interval as a percentage of the useful symbol interval. The Guard Interval range is 0–100%.
Spacing and Bandwidth	Specifies the spacing between subcarriers and the nominal channel bandwidth. Only one of these settings can be set at a time, the other setting is automatically calculated.
Sample Rate	Indicates the FFT sample rate, based on the bandwidth or subcarrier setting.

Advanced Params Tab - OFDM

The Advanced Params tab contains parameters that control the analysis of the input signal.

Settings	Description
Constellation determination	Specifies the method used to detect the constellation. Auto Detect analyzes the signal to determine the appropriate constellation, Manual allows you to specify the constellation type. Manual choices are: BPSK, QPSK, 16QAM, and 64QAM.
Symbol analysis offset	Specifies the analysis offset in the symbol interval. This value is a percentage of the Guard Interval. The allowable range is -100% to 0%. -100% positions the FFT to start at the beginning of the Guard Interval, 0% positions it to start at the end of the Guard Interval. Default value is -50% which usually gives the best measurement results.

Table continued...

Settings	Description
Channel Estimation	Specifies the method used to estimate channel frequency response and equalization. This control can be used to diagnose changes in frequency response over the signal packet.
Preamble	When you select Preamble, the instrument uses only the Preamble to estimate channel frequency response. This response is then used to equalize the entire signal packet.
Preamble + Data	When you select Preamble + Data, the instrument makes an initial channel frequency response estimate from the Preamble. Then estimates the channel response for each data symbol using the decoded data content to derive equalization for each symbol individually. This allows compensation for time-varying channel response over the packet.
Pilot tracking	Specifies if pilot subcarriers should be used to correct amplitude, phase, and symbol timing variations over the packet. The choices available are Phase, Amplitude, and Timing. The default setting is Phase.
Swap I & Q	Select the checkbox to swap the I and Q components of a signal. This compensates the input signal for spectral inversion.

Data Range Tab - OFDM

The Data Range tab enables you to control how much signal is analyzed, as well as specify the range of results that are displayed in the Constellation, EVM, Magnitude Error, Phase Error, Power and Symbol Table graphs.

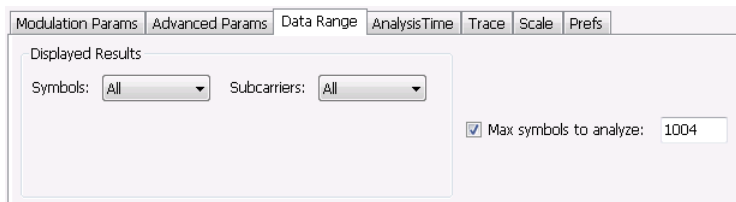

Settings	Description
Symbols	Specifies which symbols are displayed in the graphs.
All	Select All to display all symbols.
Range	Select Range to specify a subset of symbols for display.
Start	Specifies the first symbol to include in the display.
Number	Specifies how many symbols to display in the graphs.
Single	Select Single to display a single symbol.
Index	Use Index to specify the symbol you want to display.

Table continued...

Settings	Description
Subcarriers	Specifies which subcarriers are displayed.
All	Select All to display all subcarriers in the signal.
Pilots Only	Select Pilot to display only pilot subcarriers.
Data Only	Select Data to display only data subcarriers.
Single	Specifies a specific subcarrier for display.
Index	Specifies the specific subcarrier to be displayed.
Range	Specifies a range to subcarriers to be displayed.
Start	Specifies the start value of the range to be displayed.
Stop	Specifies the ending value of the range to be displayed.
Max symbols to analyze	Specifies how many symbols are analyzed. You can use this setting to speed analysis by limiting the number of symbols being analyzed.

Analysis Time Tab - OFDM

The Analysis Time tab contains parameters that define how the signal is analyzed in the OFDM Analysis displays.

Modulation Params | Advanced Params | Data Range | **AnalysisTime** | Trace | Scale | Prefs

Analysis Offset: Auto Time Zero Reference:

Analysis Length: Auto Units:

Actual: 66.000 Sym

Settings	Description
Analysis Offset	Specifies the location of the first time sample to use in measurements.
Auto	When enabled, causes the instrument to set the Analysis Offset value based on the requirements of the selected display.
Analysis Length	Specifies the length of the analysis period to use in measurements. Length is specified in either symbols or seconds, depending on the Units setting.
Auto	When enabled, causes the instrument to set the Analysis Length value based on the requirements of the selected display.

Table continued...

Settings	Description
Actual	This is a displayed value, not a setting. It is the Analysis Length (time or symbols) being used by the analyzer, this value may not match the Analysis Length requested (in manual mode).
Time Zero Reference	Specifies the zero point for the analysis time.
Units	Specifies the units of the Analysis Length to either Symbols or Seconds.

Analysis Offset

Use analysis offset to specify where measurements begin. Be aware that you cannot set the Analysis Offset outside the range of time covered by the current acquisition data. (all time values are relative to the Time Zero Reference).

You can set the Analysis Length so that the requested analysis period falls partly or entirely outside the current range of acquisition data settings. When the next acquisition is taken, its Acquisition Length will be increased to cover the new Analysis Length, as long as the Sampling controls are set to Auto. If the Sampling parameters are set to manual, or if the instrument is analyzing saved data, the actual analysis length will be constrained by the available data length, but in most cases, measurements are able to be made anyway. The instrument will display a notification when measurement results are computed from less data than requested. Range: 0 to [(end of acquisition) - Analysis Length]. Resolution: 1 effective sample (or symbol).

Analysis Length

Use the analysis length to specify how long a period of time is analyzed. As you adjust this value, the actual amount of time for Analysis Length, in Symbol or Seconds units, is shown below the control in the "Actual" readout. This setting is not available when Auto is checked. Range: minimum value depends on modulation type. Resolution: 1 symbol.

Time Zero Reference

All time values are measured from this point (such as marker position or horizontal position (in Y vs Time displays). Choices are: Acquisition Start or Trigger.

Parameter	Description
Acquisition Start	Offset is measured from the point at which acquisition begins.
Trigger	Offset is measured from the trigger point.

Trace Tab - OFDM

The Trace tab allows you to set the trace display characteristics of the selected display. This tab is not available for all OFDM displays.

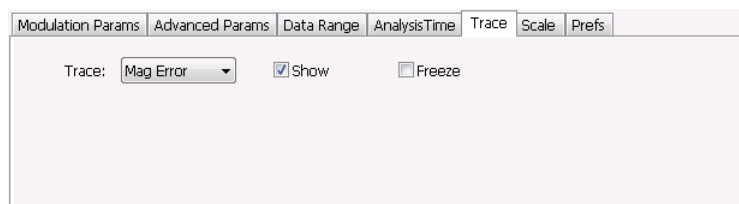

Settings	Description
Trace	Use this drop-down list to select whether or not the Average trace or the measurement trace is displayed. The measurement trace depends on the selected display.
Show	Select or deselect this checkbox to show or hide the trace selected in the Trace drop-down list.
Freeze	Selecting Freeze halts updates to the trace.

Scale Tab - OFDM

The Scale tab allows you to change the scale settings that control how the trace appears on the display but does not change control settings such as Measurement Frequency. There are two versions of the Scale tab for OFDM displays. One version is used only for the Constellation display and the other version is used for the OFDM EVM, OFDM Magnitude Error, OFDM Phase Error, and OFDM Power displays.

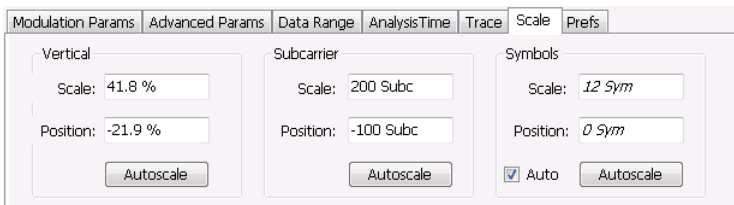

Figure 73: Scale tab for OFDM EVM, OFDM Mag Error, OFDM Phase Error, and OFDM Power displays

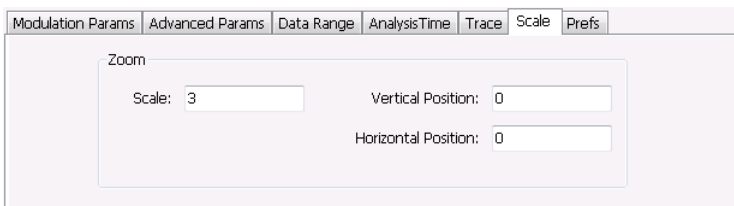

Figure 74: Scale tab for OFDM Constellation display

Settings	Description
Vertical	Controls the vertical position and scale of the trace display.
Scale	Changes the vertical scale of the graph.
Position	Adjusts the reference level away from top of the graph.
Autoscale	Resets the scale of the vertical axis to contain the complete trace.
Subcarrier	Controls the scale of the subcarrier graph and position of the trace.
Scale	Specifies how many subcarriers are displayed horizontally.
Position	Specifies the subcarrier that appears at the left edge of the subcarrier graph.

Table continued...

Settings	Description
Autoscale	Resets the scale of the horizontal axis to contain the complete trace.
Symbols	Controls the scale of the Symbols graph.
Scale	Specifies the number of symbols that appear in the symbols graph.
Position	Specifies the symbol that appears at the left edge of the Symbols graph.
Autoscale	Resets the scale and position settings to optimize the display.
Auto	When Auto is checked, the scale and position values for the Symbols graph are automatically adjusted to maintain the optimal display.
Zoom	Sets the Constellation display size and position.
Scale	Sets the magnification value for the Constellation display.
Vertical Position	Sets the vertical location of the Constellation display within the graph. Range is -3.7 to +3.7.
Horizontal Position	Sets the horizontal location of the Constellation display within the graph. Range is -3.7 to +3.7.

Prefs Tab - OFDM

The Prefs tab enables you to change appearance characteristics of the OFDM Analysis displays. Not all settings on the Prefs tab shown below appear for every OFDM display.

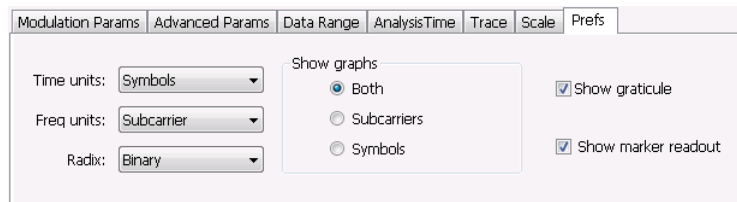

Settings	Description
Time units	Specifies whether the displayed time units are seconds or symbols.
Freq units	Specifies whether the displayed frequency units are frequency (Hz) or subcarrier channel.
Radix	Specifies whether symbol values are displayed in binary or hex format (for example, in the Symbol Table or markers readouts).
Show graphs	Specifies which graph types are displayed.
Both	Displays both the Subcarrier and Symbol graphs.

Table continued...

Settings	Description
Subcarriers	Displays only the subcarrier graph.
Symbols	Displays only the symbol graph.
Show graticule	Displays or hides the graticule in the graphs.
Show marker readout	Displays or hides the marker readouts in the graphs.

Pulsed RF

Pulsed RF Overview

The Pulsed RF option (SVPH-SVPC) allows you to take measurements that provide deep insight into pulse train behavior. You can define and analyze unique pulse characteristics in the time and frequency domains and gain additional insight into the performance of Radar or EW subsystems. The Pulse Cumulative Histogram and Pulse Cumulative Statistics Table accumulate results over multiple acquisitions. The remaining Pulse displays show results for the current acquisition. You can use cross-correlated markers to pinpoint events in one display and debug in other displays.

When connected to MSO/LPD, multiple incoming signals from different sources (RF / IQ / Differential IQ) can be acquired, analyzed and the results can be viewed at same time in multiple displays.

The displays in Pulsed RF (**Setup > Displays > Source > Pulsed RF**) are:

- [Cumulative Histogram](#)
- [Cumulative Statistics](#)
- [Pulse-Ogram™](#)
- [Pulse Statistics](#)
- [Pulse Table](#)
- [Pulse Trace](#)

Pulse Measurements

The analyzer takes the following pulse measurements.

Measurement	Description
Average ON Power	The average power transmitted during pulse on.
Peak Power	Maximum power during pulse on.
Average Transmitted Power	The average power transmitted, including both the time the pulse is on and the time it is off, and all transition times.
Pulse Width	The time from the rising edge to the falling edge at the -3 dB / -6 dB level (50%) of the user selected 100% level. Level is user selectable for Volts or Watts.
Rise Time	The time required for a signal to rise from 10% to 90% (or 20% to 80%) of the user selected 100% level.
Fall Time	The time required for a signal to fall from 90% to 10% (or 80% to 20%) of the user selected 100% level.
Repetition Interval	The time from a pulse rising edge to the next pulse rising edge.
Repetition Rate	The inverse of repetition interval.
Duty Factor (%)	The ratio of the width to the pulse period, expressed as a percentage.
Duty Factor (Ratio)	The ratio of the pulse width to the pulse period.

Table continued...

Measurement	Description
Ripple	<p>Ripple is the peak-to-peak ripple on the pulse top. It does not include any preshoot, overshoot, or undershoot. By default, the first 25% and the last 25% of the pulse top is excluded from this measurement to eliminate distortions caused by these portions of the pulse.</p> <p>If the Amplitude units selected in the Amplitude panel (affects all amplitude measurements for the analyzer) are linear, the Ripple results will be in %Volts. For log units, the Ripple results will be in %Watts. The default for the general Units control is dBm, so the Ripple results default is %Watts.</p> <p>See also Ripple on page 880.</p>
Ripple dB	The Ripple measurement expressed in dB.
Droop	Droop is the power difference between the beginning and the end of the pulse on time. A straight-line best fit is used to represent the top of the pulse. The result is a percentage referenced to the Average ON Power.
Droop dB	The Droop measurement expressed in dB.
Overshoot	The amount by which the signal exceeds the 100% level on the pulse rising edge. Units are %Watts or %Volts.
Overshoot dB	The Overshoot measurement expressed in dB.
Pulse-ref-Phase Difference	The phase difference between the current pulse and the first pulse in the analysis window. The instantaneous phase is measured at a user-adjustable time following the rising edge of each pulse.
Phase Difference	The time interval by which one wave leads or lags another.
Pulse-ref Freq Difference	The difference between the frequency of the current pulse and frequency of the previous pulse. The instantaneous frequency is measured at a user-adjustable time following the rising edge of each pulse.
RMS Freq Error	The RMS Frequency Error measurement is the RMS average of the Freq Error vs. Time trace, computed over the Measurement Time.
Max Freq Error	The maximum frequency error is the difference between the measured carrier frequency of the signal and the user-selected center frequency of the analyzer.
RMS Phase Error	The RMS Phase Error measurement is the RMS average of the Phase vs Time trace, computed over the Measurement Time.
Max Phase Error	The phase is measured at each point during the pulse on time. The phase error for each point is the difference between the measured phase value and the calculated ideal phase value. After the phase error is calculated for all points in the acquisition record, the largest error in the positive direction and the largest in the negative direction are determined. Whichever of these two values has the greater absolute value is designated the Max Phase Error.
Freq Deviation	The Frequency Deviation measurement is the difference between the maximum and minimum measured values of the signal frequency during the Measurement Time.
Phase Deviation	The Phase Deviation is the difference between the maximum and minimum Phase values measured during the on time of a pulse.
Impulse Response Amplitude	The difference in dB between the levels of the main lobe and highest side lobe.
Impulse Response Time	The difference in time between the main lobe and highest side lobe.
Time	This is the time in seconds relative to the time reference point in the first acquisition record in the data set.

Table continued...

Measurement	Description
Absolute Frequency	The absolute pulse frequency measured at a point specified by the user. The measurement includes carrier frequency as well. The measurement point should be within the pulse width, starting from the 50% point.
Pulse-Pulse Frequency Difference	The difference between the frequency of the current pulse and frequency of the previous pulse. The instantaneous frequency is measured at a user-adjustable time following the rising edge of each pulse.
Pulse-Pulse Phase Difference	The phase difference between the selected pulse and the first pulse in the analysis window. The instantaneous phase is measured at a user-adjustable time following the rising edge of each pulse.
Delta Frequency (Non-chirped pulse)	<p>The Delta Frequency measurement is the difference from the measurement frequency to each pulse frequency. Pulse frequency is calculated across the time defined by the Frequency Domain Linearity setting in the Define tab.</p> <p>The measurement is available for modulation types CW (Constant Phase), CW (Changing phase), and Other (manual) setting in the Freq Estimation tab.</p> <p>The measurement is not specified for chirp or other signals and no answer is returned when frequency estimation is set to Chirp.</p> <p>If frequency estimation is set to Other, then Frequency Offset must be set to 0 Hz and the Range can be set to $\pm 40\%$ of the acquisition bandwidth.</p> <p>A least-square fit of slope of phase vs. time over the measurement period is used for the measurement of the individual pulse frequency. Frequency difference is calculated as the difference between the reference frequency and the calculated frequency of the pulse.</p>

Cumulative Histogram Display

This histogram display shows the numerical distribution of the various pulse measurement results accumulated over multiple frames (in Fast Frame mode) and acquisitions. You can see the pulse count in a chosen bin by choosing the bin number or the X value (of the chosen result). Pulses that do not lie within the chosen Min/Max are shown as outliers.

When Connected to MSO/LPD, multiple incoming signals from different sources (RF / IQ / Differential IQ) can be acquired, analyzed and the results can be viewed at same time in multiple displays.

To show the Cumulative Histogram display:

1. If you are analyzing a stored data file, recall the data file now. Otherwise, go to the next step.
2. Select the **Source(s)** from drop-down list.
3. In the **Select Displays** dialog, select **Pulsed RF** in the **Measurements** box.
4. In the Available displays box, double-click the **Cumulative Histogram** icon or select the icon and click **Add**. The icon will appear in the **Selected displays** box and will no longer appear under Available displays.
5. Click **OK** to show the Cumulative Histogram display.
6. If you are analyzing a stored data file, press the **Replay** button to take measurements on the acquisition data file.

Elements of the display

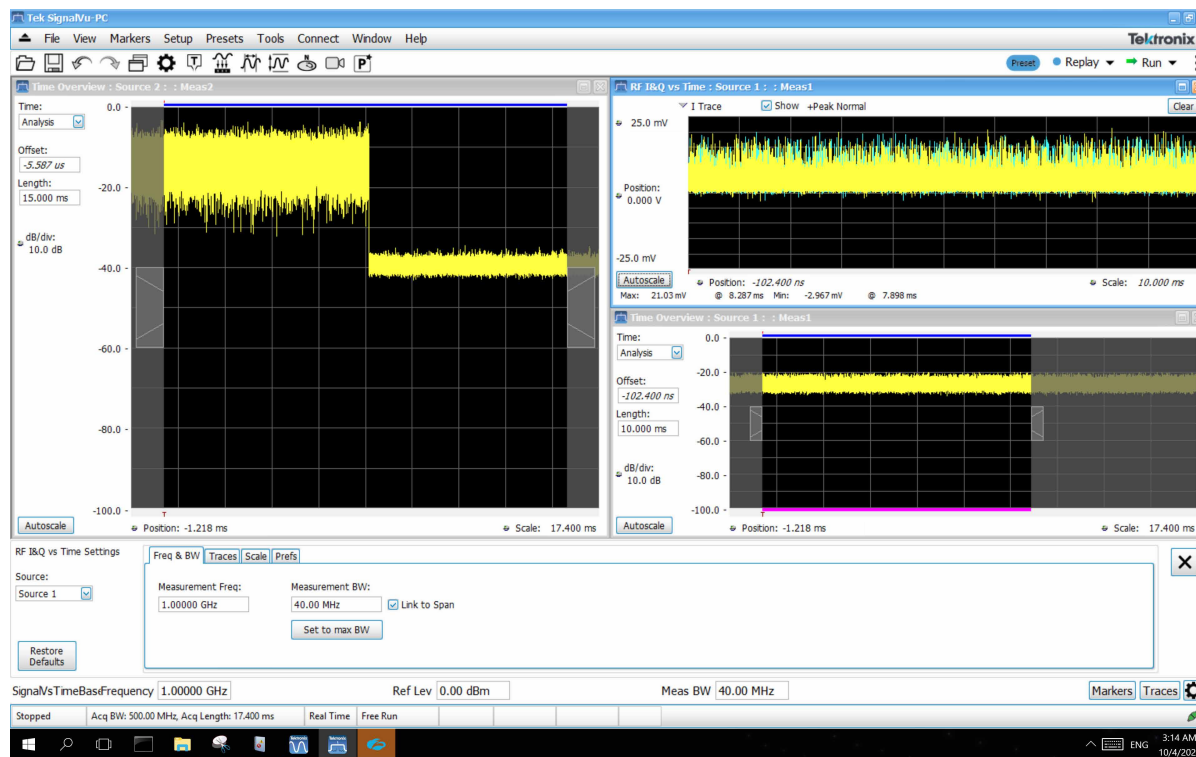

The above figure is shown when connected to MSO/LPD.

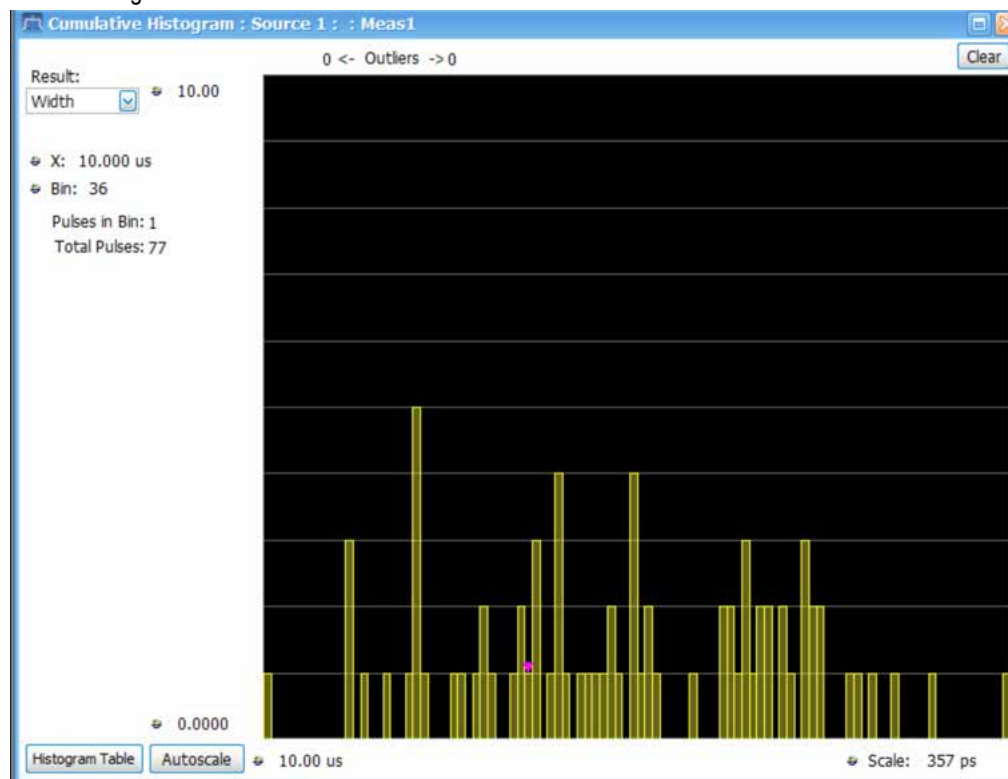

The above figure is shown when connected to MSO/LPD.

Item	Display element	Description																																																
1	Result	Drop down list of measurements. The results of the selected measurement in this Cumulative Histogram display will also show in the Pulse Statistics display and be highlighted in the Pulse Table display. All results will be available for view when Auto mode is enabled in the Cumulative Histogram display settings on page 362 window. Only selected results will be available for view when Manual mode is enabled in the Histogram Settings window.																																																
2	X	A value of the selected result where the pulse indicator is positioned. Changing X will automatically change the bin number to the one that contains the X value.																																																
3	Bin	Bin number where the indicator is positioned. Changing this number will change the value of X to the middle of the selected bin.																																																
4	Pulses in Bin	Number of pulses in the selected bin.																																																
5	Total Pulses	Total number of pulses analyzed in the current acquisition.																																																
6	Vertical	Sets the vertical range.																																																
7	Autoscale	Sets the axes to values for clear visibility of trace points.																																																
8	Horizontal offset and scale	Controls that specify the offset and scale on the horizontal axis.																																																
9	Clear button	Clears results from the display and starts a new measurement.																																																
10	Outliers	Number of pulses that have measurement values outside of the maximum and minimum values indicates the outliers below the lower limit and those exceeding the upper limit.																																																
11	Histogram Table button	Contains the Bin number, Bin Range, and Pulses in bin for the chosen measurement. <table border="1" data-bbox="602 968 1200 1413"> <thead> <tr> <th>Bin Number</th> <th>Bin Range</th> <th>Pulses in Bin</th> </tr> </thead> <tbody> <tr><td>1</td><td>196.00 MHz - 198.42 MHz</td><td>2</td></tr> <tr><td>2</td><td>198.42 MHz - 200.84 MHz</td><td>1</td></tr> <tr><td>3</td><td>200.84 MHz - 203.26 MHz</td><td>0</td></tr> <tr><td>4</td><td>203.26 MHz - 205.68 MHz</td><td>0</td></tr> <tr><td>5</td><td>205.68 MHz - 208.10 MHz</td><td>0</td></tr> <tr><td>6</td><td>208.10 MHz - 210.52 MHz</td><td>0</td></tr> <tr><td>7</td><td>210.52 MHz - 212.94 MHz</td><td>1</td></tr> <tr><td>8</td><td>212.94 MHz - 215.36 MHz</td><td>0</td></tr> <tr><td>9</td><td>215.36 MHz - 217.77 MHz</td><td>0</td></tr> <tr><td>10</td><td>217.77 MHz - 220.19 MHz</td><td>0</td></tr> <tr><td>11</td><td>220.19 MHz - 222.61 MHz</td><td>0</td></tr> <tr><td>12</td><td>222.61 MHz - 225.03 MHz</td><td>0</td></tr> <tr><td>13</td><td>225.03 MHz - 227.45 MHz</td><td>0</td></tr> <tr><td>14</td><td>227.45 MHz - 229.87 MHz</td><td>0</td></tr> <tr><td>15</td><td>229.87 MHz - 232.29 MHz</td><td>0</td></tr> </tbody> </table>	Bin Number	Bin Range	Pulses in Bin	1	196.00 MHz - 198.42 MHz	2	2	198.42 MHz - 200.84 MHz	1	3	200.84 MHz - 203.26 MHz	0	4	203.26 MHz - 205.68 MHz	0	5	205.68 MHz - 208.10 MHz	0	6	208.10 MHz - 210.52 MHz	0	7	210.52 MHz - 212.94 MHz	1	8	212.94 MHz - 215.36 MHz	0	9	215.36 MHz - 217.77 MHz	0	10	217.77 MHz - 220.19 MHz	0	11	220.19 MHz - 222.61 MHz	0	12	222.61 MHz - 225.03 MHz	0	13	225.03 MHz - 227.45 MHz	0	14	227.45 MHz - 229.87 MHz	0	15	229.87 MHz - 232.29 MHz	0
Bin Number	Bin Range	Pulses in Bin																																																
1	196.00 MHz - 198.42 MHz	2																																																
2	198.42 MHz - 200.84 MHz	1																																																
3	200.84 MHz - 203.26 MHz	0																																																
4	203.26 MHz - 205.68 MHz	0																																																
5	205.68 MHz - 208.10 MHz	0																																																
6	208.10 MHz - 210.52 MHz	0																																																
7	210.52 MHz - 212.94 MHz	1																																																
8	212.94 MHz - 215.36 MHz	0																																																
9	215.36 MHz - 217.77 MHz	0																																																
10	217.77 MHz - 220.19 MHz	0																																																
11	220.19 MHz - 222.61 MHz	0																																																
12	222.61 MHz - 225.03 MHz	0																																																
13	225.03 MHz - 227.45 MHz	0																																																
14	227.45 MHz - 229.87 MHz	0																																																
15	229.87 MHz - 232.29 MHz	0																																																
When connected to MSO/LPD																																																		
12	Source	Source corresponds to selected display.																																																
13	Measurement Instance number	Represents the instance of measurement display created.																																																

Cumulative Histogram display settings

Main menu: Setup > Settings

Favorites Toolbar: 

The Settings control panel tabs for the Cumulative Histogram display are shown in the following table.

Settings tab	Description
Params	Specifies several parameters that control how pulses are counted and defined.
Define	Specifies parameters that control where measurements are taken on a pulse.
Levels	Specifies parameters that control the method and levels used to calculate some pulse values.
Freq Estimation	Specifies the reference used for computing frequency error.
Scale	Specifies the vertical and horizontal scale settings.
Prefs	Specifies whether or not certain display elements are shown.

Histogram Settings button

This button is located on the Pulse Cumulative Histogram Settings control panel. Click this button to open a window where you can select which measurement results will be available in the Result drop down menu. You can select to use Auto or Manual mode.

Manual mode for histogram settings. In **Manual** mode, the histogram computation is done for the selected measurement results. You set the maximum and minimum values. The **Bin** field represents the total number of bins used in the histogram.

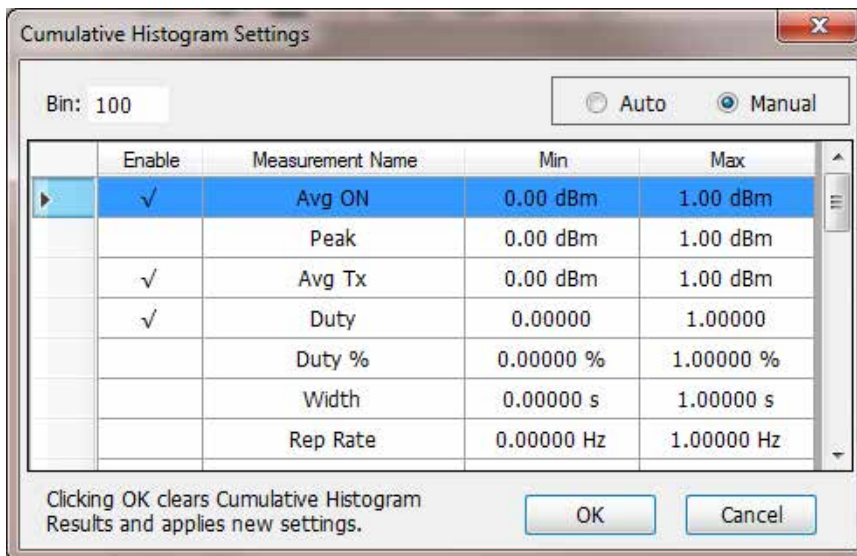

Auto mode for histogram settings. In **Auto** mode, the histogram computation is done for all measurement results. Minimum and maximum limits are chosen automatically based on the first 10,000 pulses. The **Bin** field represents the total number of bins used in the histogram.

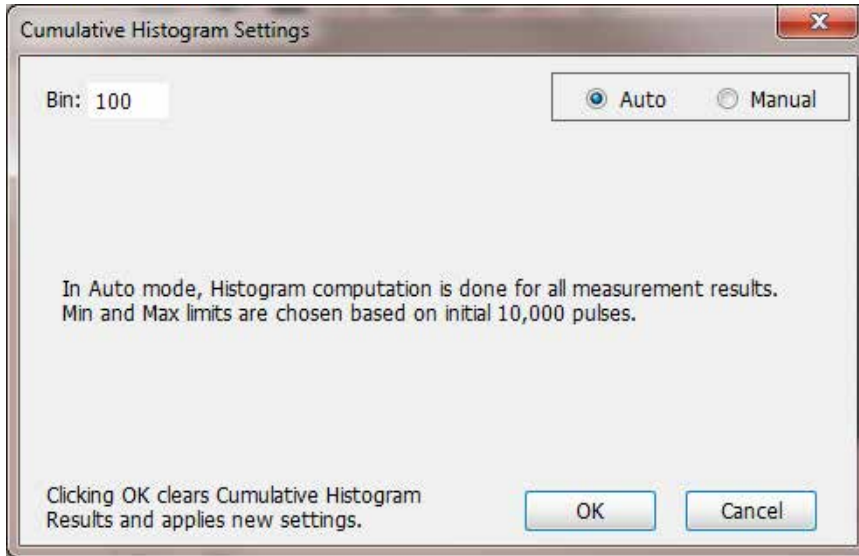

Restore Defaults button

This button is located on the Pulse Cumulative Histogram Settings control panel. Click this button to set the Cumulative Histogram parameters to their default values.

Cumulative Statistics Table display

This display is a statistics table that provides information on Pulse Count, Max, Max TimeStamp, Min, Min TimeStamp, Peak to Peak, Average, and Standard Deviation over different acquisitions.

When Connected to MSO/LPD, multiple incoming signals from different sources (RF / IQ / Differential IQ) can be acquired, analyzed and the results can be viewed at same time in multiple displays

1. If you are analyzing a stored data file, recall the data file now. Otherwise, go to the next step.
2. Press the **Displays** button or select **Setup > Displays**.
3. Select **Source(s)** from drop-down list.
4. In the **Select Displays** dialog, select **Pulsed RF** in the **Measurements** box.
5. In the Available displays box, double-click the **Cumulative Statistics** icon or select the icon and click **Add**. The icon will appear in the **Selected displays** box and will no longer appear under Available displays.
6. Click **OK** to show the Cumulative Statistics display.
7. If you are analyzing a data file, press the **Replay** button to take measurements on the recalled acquisition data file.

Elements of the display



Pulse Cumulative Statistics Table

Statistics	Avg ON	Width	Rep Int
Pulse Count	16	16	15
Max	-1.36 dBm	100.00345 ns	4.90990 us
Max TimeStamp	8/27/2008 7:20:52.87	8/27/2008 7:20:52.87	8/27/2008 7:20:52.87
Min	-1.41 dBm	99.37347 ns	2.90983 us
Min TimeStamp	8/27/2008 7:20:52.87	8/27/2008 7:20:52.87	8/27/2008 7:20:52.87
Peak to Peak	-46.74 dBm	629.97429 ps	2.00008 us
Avg	-1.38 dBm	99.63989 ns	3.31002 us
Std Dev	-55.91 dBm	168.95610 ps	799.79884 ns

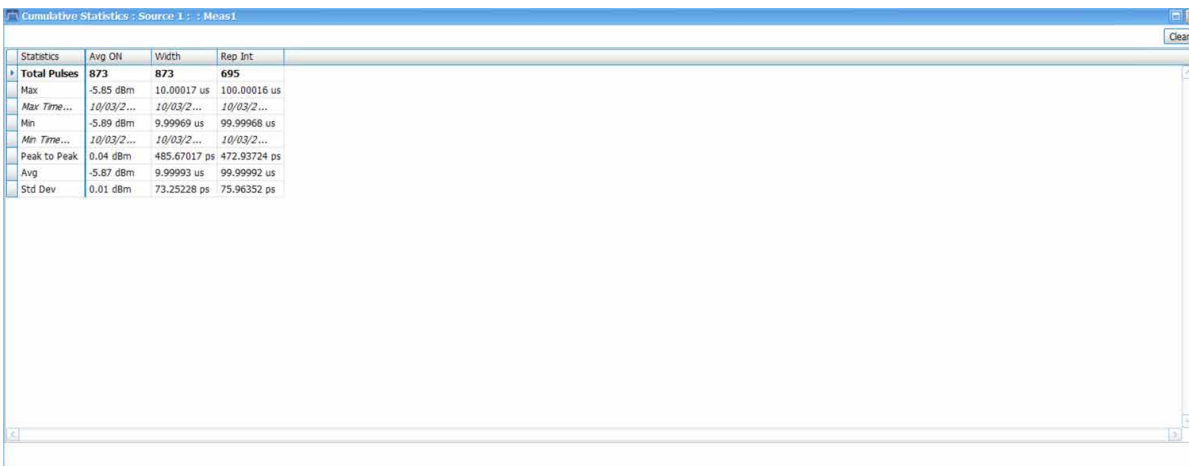

Cumulative Statistics: Source 1: Meas1

Statistics	Avg ON	Width	Rep Int
Total Pulses	873	873	695
Max	-5.85 dBm	10.00017 us	100.00016 us
Max Time...	10/03/2...	10/03/2...	10/03/2...
Min	-5.89 dBm	9.99969 us	99.99968 us
Min Time...	10/03/2...	10/03/2...	10/03/2...
Peak to Peak	0.04 dBm	485.67017 ps	472.93724 ps
Avg	-5.87 dBm	9.99993 us	99.99992 us
Std Dev	0.01 dBm	73.25228 ps	75.96352 ps

The above figure shows when connected to MSO/LPD.

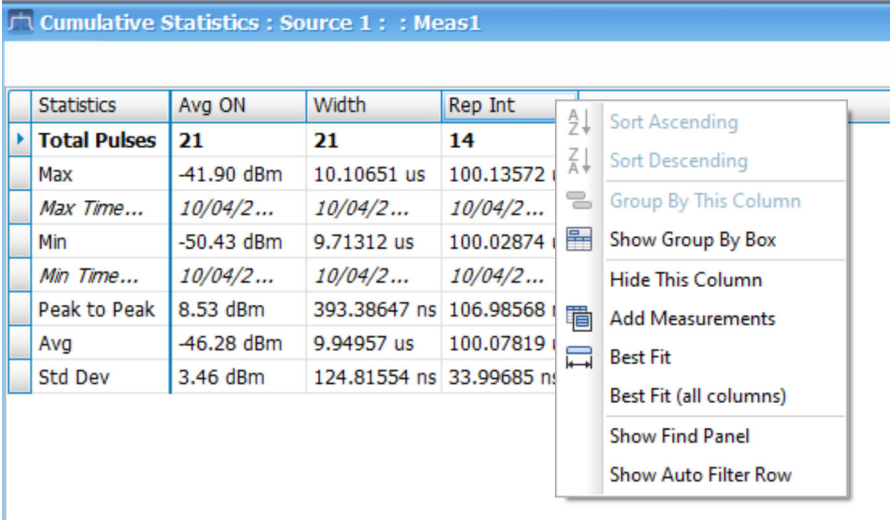
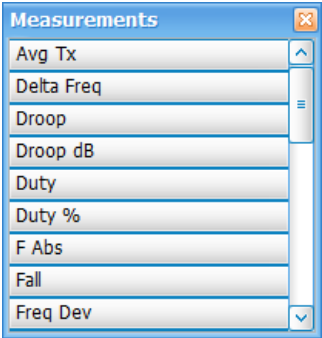
Display element	Description
Measurement	<p>The row across the top of the table shows the selected measurement.</p> <p>You can right click on this row to access this menu to edit the table:</p>  <p>Select Add Measurements to open this window to select measurements:</p> 
Maximum	Maximum value of the measurement across acquisitions with a time stamp.
Maximum TimeStamp	This time stamp denotes the time the maximum value of the measurement occurred across acquisitions.
Minimum	Minimum value of the measurement across acquisitions with a time stamp.
Minimum TimeStamp	This time stamp denotes the time the minimum value of the measurement occurred across acquisitions.
Average	Average value of the measurement values accumulated over multiple acquisitions until the current acquisition.
Peak to peak	This is the difference between Maximum and Minimum value of the measurement
Standard deviation	Standard deviation of the measurement that has a population equal to the Pulse Count value.
Clear button	Clear the results and starts a new measurement.
When connected to MSO/LPD	
Source	Source corresponds to selected display.
Table continued...	

Display element	Description
Measurement Instance number	Represents the instance of measurement display created.



Note: When analysis is done on only one pulse, the Standard Deviation is zero. Log10 (0) is not defined and thus is represented by a “-” when the unit is dB.

Cumulative Statistics Table display settings

Main menu: **Setup > Settings**

Favorites Toolbar: 

The Settings control panel tabs for the Cumulative Statistics Table display are shown in the following table.

Settings tab	Description
<i>Measurements</i>	Specifies which measurements to show in the table. Click the box(es) next to the measurement(s) you want to show. You can also click the Select All and Clear All buttons.
<i>Params</i>	Specifies how pulses are counted and defined.
<i>Define</i>	Specifies parameters that control where measurements are taken on a pulse.
<i>Levels</i>	Specifies parameters that control the method and levels used to calculate some pulse values.
<i>Freq Estimation</i>	Specifies the reference used for computing frequency error.
<i>Prefs</i>	Specifies whether or not certain display elements are shown.

Restore defaults button

This button is located on the Cumulative Statistics Table Settings control panel. Sets the Cumulative Statistics Table parameters to their default values.

Pulse-Ogram display

The Pulse-Ogram™ display shows a stacked view of radar pulses when the analyzer is using fast-frame mode. The fast-frame captures IQ samples around a pulse when triggered. Each fast frame is configured to capture few IQ samples before rise-time, and after fall-time of a single pulse, and a timestamp associated with that pulse. With this information, the different fast-frame captures are stacked one after the other and displayed as Time v/s Time, and the corresponding spectrum information as Frequency v/s Time. The stacking allows for overlap of adjacent frames. The user can also select the range of frames for viewing in the display. This enables the user to study various aspects of pulse such as pulse width, reflections, rise-time, fall-time, etc.

When Connected to MSO/LPD, multiple incoming signals from different sources (RF / IQ / Differential IQ) can be acquired, analyzed and the results can be viewed at same time in multiple displays

Marker correlation in Pulse-Ogram

At the end of an acquisition, the TOV and Spectrum show the last frame acquired. When we place a marker in Pulse-Ogram, the marker would not move in TOV and Spectrum unless you bring the marker to the last frame in Pulse-Ogram. Similarly, if marker is moved in TOV and Spectrum, then the marker in Pulse-Ogram will move to the last frame automatically.

If you want the marker movement in Pulse-Ogram to change the pulse indicator in the Pulse Table or Pulse Trace display, then you must add the Pulse Statistics display in Time trend mode. Movement of the marker now in the Pulse Statistics display or Pulse-Ogram display will change the pulse indicator position too, and therefore the appropriate pulse will be shown in the Pulse Trace display.

1. If you are analyzing a stored data file, recall the data file now. Otherwise, go to the next step.
2. Press the **Displays** button or select **Setup > Displays**.
3. Select **Source(s)** from drop-down list.
4. In the **Select Displays** dialog, select **Pulsed RF** in the **Measurements** box.
5. In the Available displays box, double-click the **Pulse-O-gram** icon or select the icon and click **Add**. The icon will appear in the **Selected displays** box and will no longer appear under Available displays.
6. Click **OK** to show the Pulse-O-gram display.
7. If you are analyzing a data file, press the **Replay** button to take measurements on the recalled acquisition data file.

Elements of the display

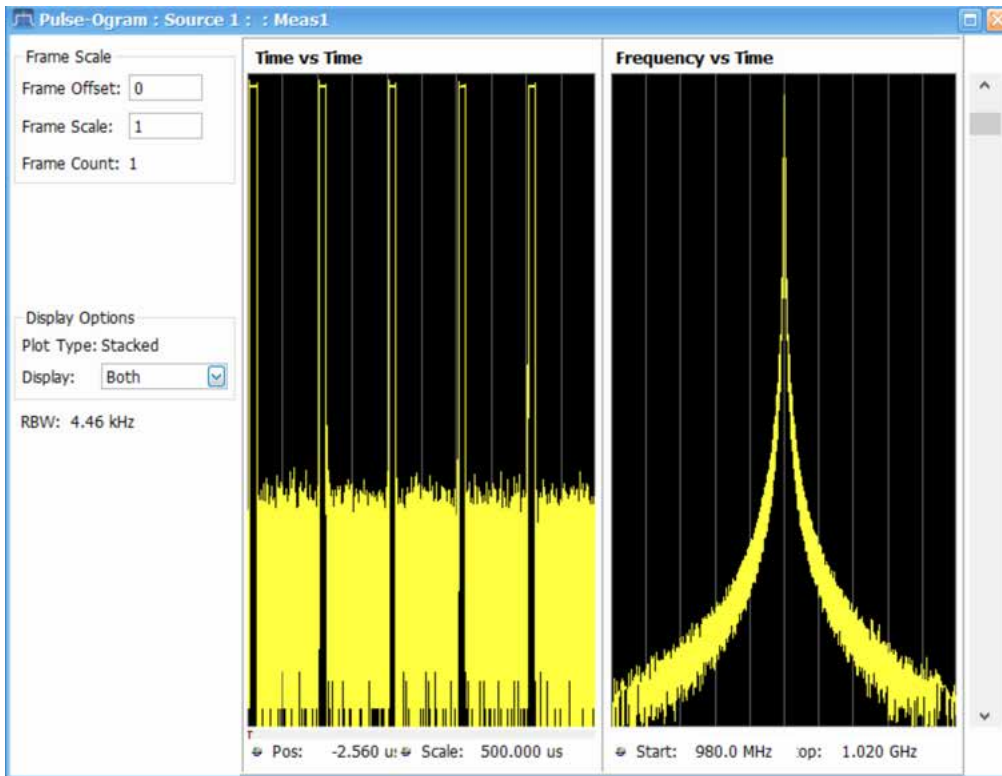
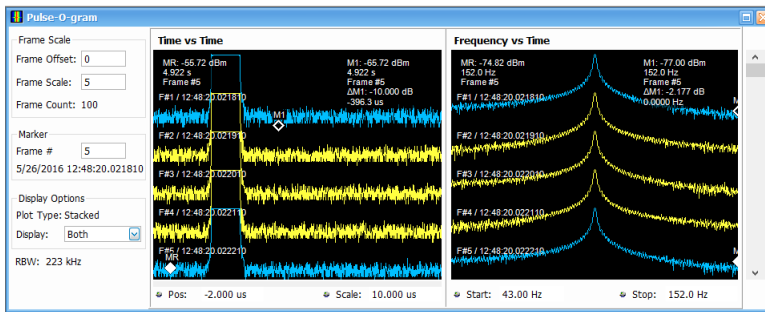

The above figure is shown when connected to MSO/LPD

Display element	Description
Time vs Time	This view has the IQ data captured in the fast frames in a stacked view (with overlap).
Table continued...	

Display element	Description
Frequency vs Time	This view has the corresponding spectrum of the signal captured.
Frame offset	Controls the number of frames that are offset in the display. The starting frame will be frame offset + 1.
Frame scale	Controls the number of frames that can be seen in the display.
Frame count	Total number of fast frames in the acquisition.
Frame #	Indicates the frame number in which the marker is present. This option will only appear when the marker is added.
Plot type	Shows Stacked and is not selectable.
Display	Select to view Time vs Time or Frequency vs Time or Both.
RBW	Shows the resolution bandwidth for the Frequency vs Time view.
When connected to MSO/LPD	
Source	Source corresponds to selected display.
Measurement Instance number	Represents the instance of measurement display created.

Pulse-Ogram display settings

Main menu: Setup > Settings

Favorites Toolbar: 

The Settings control panel tabs for the Pulse-Ogram display are shown in the following table.

Settings tab	Description
Analysis	Specifies settings related to analysis of the signal.
Traces	Specifies the display characteristics of displayed traces.
Scale	Specifies the parameters related to fast frame.
Prefs	Specifies marker readout options.

Pulse Table display

The Pulse Table lists selected measurements in a spreadsheet format, showing the pulse numbers and all the results for each measurement on all the detected pulses. Pulses are numbered from one.

When Connected to MSO/LPD, multiple incoming signals from different sources (RF / IQ / Differential IQ) can be acquired, analyzed and the results can be viewed at same time in multiple displays

Freq Error: -4.208 kHz (Auto) Freq: 999.9957918 MHz

Pulse #	Avg ON	Width	Rise	Rep Int	RMS Ø Err	Peak	Avg Tx
1	-1.40 dBm	100.00345 ns	7.99554 ns	4.90948 us	802.20618 °	-0.85 dBm	-18.32 dBm
2	-1.38 dBm	99.52590 ns	7.83859 ns	2.91027 us	278.82507 °	-0.84 dBm	-16.10 dBm
3	-1.37 dBm	99.73721 ns	7.80641 ns	2.91002 us	280.49780 °	-0.70 dBm	-16.10 dBm
4	-1.36 dBm	99.85104 ns	7.68201 ns	2.91014 us	284.17639 °	-0.62 dBm	-16.08 dBm
5	-1.37 dBm	99.50647 ns	7.98586 ns	2.91022 us	287.90259 °	-0.64 dBm	-16.08 dBm
6	-1.40 dBm	99.67329 ns	8.03208 ns	4.90946 us	806.15570 °	-0.73 dBm	-18.32 dBm
7	-1.36 dBm	99.91533 ns	7.84547 ns	2.91045 us	272.54922 °	-0.62 dBm	-16.08 dBm
8	-1.36 dBm	99.55097 ns	7.48575 ns	2.90986 us	276.32895 °	-0.78 dBm	-16.08 dBm
9	-1.39 dBm	99.41364 ns	7.65567 ns	2.91011 us	280.42859 °	-0.87 dBm	-16.11 dBm
10	-1.36 dBm	99.56028 ns	7.80557 ns	2.91018 us	284.14838 °	-0.74 dBm	-16.07 dBm
11	-1.40 dBm	99.63683 ns	8.02328 ns	4.90990 us	810.08453 °	-0.86 dBm	-18.31 dBm
12	-1.38 dBm	99.55033 ns	7.95047 ns	2.91008 us	268.64148 °	-0.74 dBm	-16.10 dBm
13	-1.37 dBm	99.37347 ns	7.73742 ns	2.90983 us	272.31412 °	-0.68 dBm	-16.09 dBm
14	-1.36 dBm	99.58830 ns	7.79934 ns	2.91000 us	275.92587 °	-0.77 dBm	-16.08 dBm
15	-1.37 dBm	99.59512 ns	7.74599 ns	2.91024 us	279.55917 °	-0.53 dBm	-16.08 dBm
16	-1.41 dBm	99.75660 ns	8.28168 ns	-- s	814.49548 °	-0.90 dBm	-- dBm

Measurement Instance
number

Source

Pulse Table : Source 1 : Meas1

Freq Error: 254.2 Hz (Auto) Freq: 1.000000254 GHz

Pulse #	Avg ON	Width	Rep Int	Peak	Rise	Oshoot
1	-49.21 dBm	9.86936 us	99.87310 us	-43.60 dBm	965.62502 ps	302.63 %W
2	-41.81 dBm	10.09317 us	100.04464 us	-35.34 dBm	62.02313 ns	493.97 %W
3	-43.36 dBm	10.00571 us	100.00204 us	-37.30 dBm	11.26937 ns	398.28 %W
4	-44.40 dBm	10.04999 us	100.01209 us	-38.35 dBm	26.79687 ns	387.39 %W
5	-42.48 dBm	10.05260 us	99.99634 us	-36.18 dBm	10.90125 ns	422.85 %W
6	-42.72 dBm	10.03592 us	120.01098 us	-36.53 dBm	5.48875 ns	407.89 %W
7	-44.32 dBm	10.00287 us	99.99937 us	-38.32 dBm	2.91500 ns	366.24 %W
8	-42.47 dBm	10.00598 us	99.95879 us	-35.98 dBm	9.50187 ns	393.59 %W
9	-42.70 dBm	10.07355 us	100.12354 us	-36.45 dBm	34.70312 ns	440.43 %W
10	-48.59 dBm	9.83317 us	-- s	-43.06 dBm	8.27625 ns	316.36 %W

The above figure is shown when connected to MSO/LPD

Element	Description
When connected to MSO/LPD	
Source	Source corresponds to selected display.
Measurement Instance number	Represents the instance of measurement display created.

Displaying the Pulse Table

1. Press the **Displays** button or select **Setup > Displays**.
2. Select **Source(s)** from drop-down list.
3. Select **Pulsed RF** in the Measurements box.
4. **Double-click Pulse Table** in the **Available displays** box to add the display to the Selected displays box.
5. Click **OK**.

Selecting the Measurements to Show

1. With the Pulse Table selected, press the **Settings** button.
2. In the Pulse Table Settings control panel, select the **Measurements** tab.

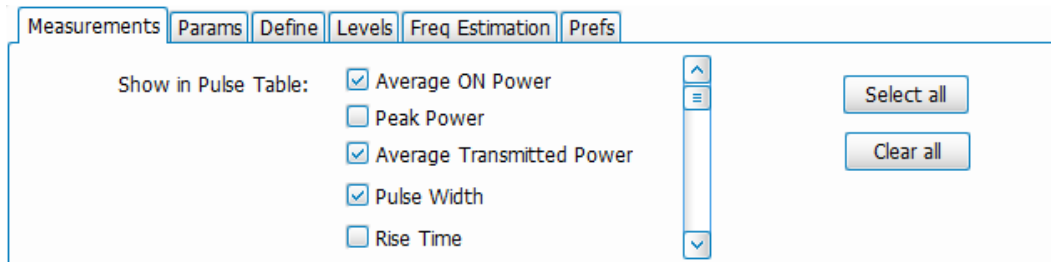

3. Select the measurements you wish to take from the list of measurements or click **Select all** to choose all measurements.
4. Click the close box () to remove the Settings control panel.

[Changing the Pulse Table Display Settings](#)

Pulse Table display settings

Main menu bar: **Setup > Settings**

Favorites Toolbar: 

The Settings control panel tabs for the Pulse Table Display are shown in the following table.

Settings tab	Description
Measurements	Selects the measurements to be show in the Pulse Table.
Params	Specifies several parameters that control how pulses are counted and defined.
Define	Specifies parameters that control where measurements are taken on a pulse.
Levels	Specifies parameters that control the method and levels used to calculate some pulse values.
Freq Estimation	Specifies the reference used for computing frequency errors.

Restore defaults button

This button is located on the Pulse Table Settings control panel. Sets the Pulse Table parameters to their default values.

Clearing results

If you want to clear the Pulse Table results for a new acquisition, open the Time Overview window and select Autoscale. This causes the Pulse Table to refresh.

Pulse Trace display

The Pulse Trace display shows one measurement result and a trace graph illustrating that measurement for a selected pulse number. You can also choose to display arrows and lines in the graph that illustrate where on the pulse the measurement is being taken.

When Connected to MSO/LPD, multiple incoming signals from different sources (RF / IQ / Differential IQ) can be acquired, analyzed and the results can be viewed at same time in multiple displays.

Elements of the Pulse Trace Display

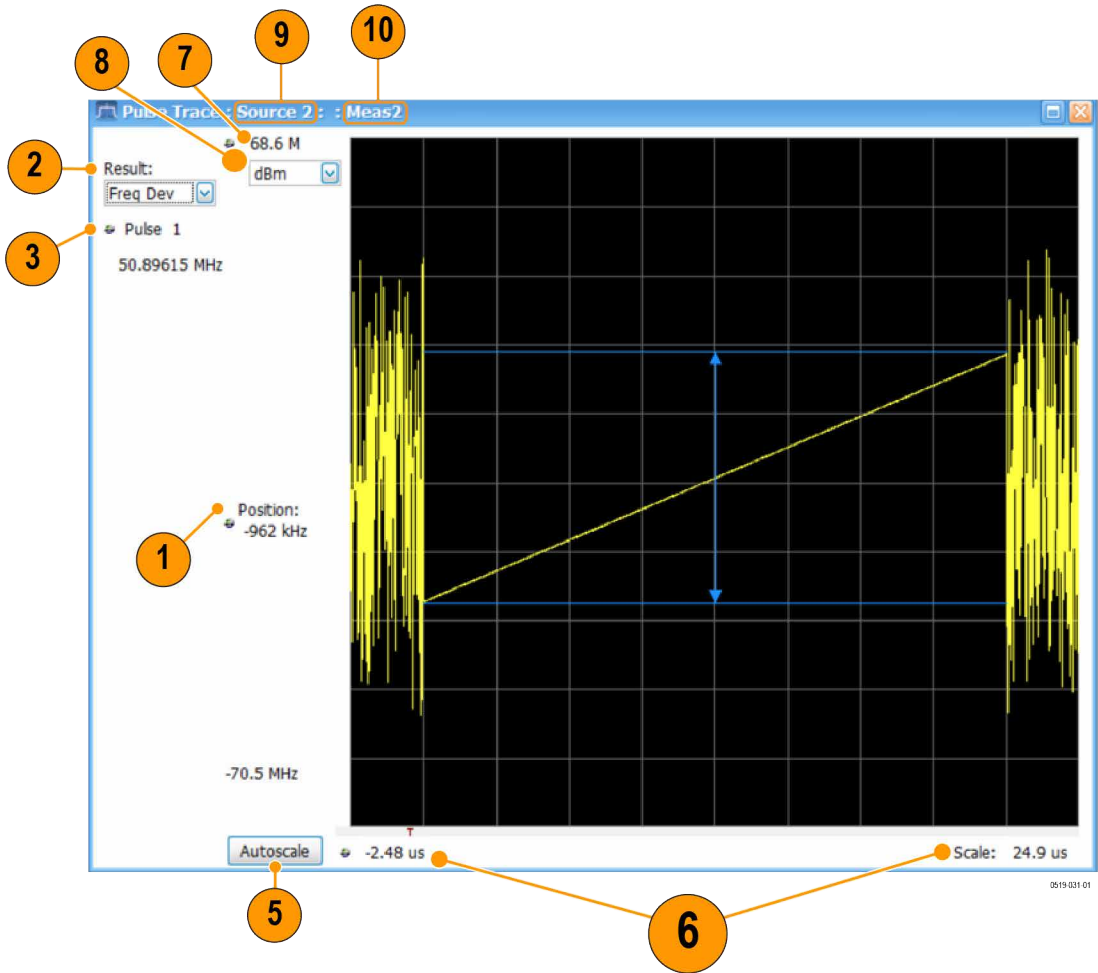
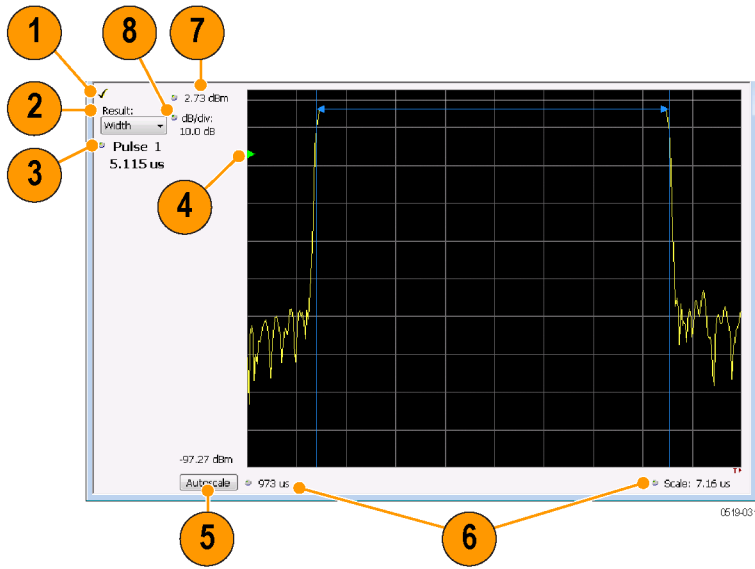

The above figure is shown when connected to MSO/LPD.

Item	Display element	Description
1	Check mark indicator	<p>The check mark indicator in the upper, left-hand corner of the display shows when the Pulse Trace display is the optimized display.</p> <p> Note: When Best for multiple windows is selected in the Amplitude control panel's RF & IF Optimization control, none of the measurement displays shows a check-mark, as there is not a single optimized measurement</p>
2	Result	Use this list to select the measurement to show. The measurement chosen here selects the same result to be displayed in the Statistics view and highlighted in the Table view. Selecting a result in any of these views causes the same result to be selected in all of them.
3	Pulse	Selects which pulse result is shown. Like the Result, this selection is shared with the Statistics and Table views. The maximum number of pulses that can be measured is limited to 10000.
4	Pulse threshold indicator	This green triangle indicates the power threshold used to detect pulses. See Settings > Params > Power threshold to detect pulses.
5	Autoscale	Set the axes to values that show all trace points.
6	Horizontal offset and scale	Located along the bottom edge of the trace display, these controls specify the offset and scale on the horizontal axis.
7	Top of graph adjustment	Sets the power level shown at the top of the graph. If the number is greater than the Ref Level, a white line will appear in the graph to indicate the Ref Level.
(not shown)	Units	Sets the global amplitude units for all the views in the analysis window. This will change the amplitude selection in the Units tab of the Amplitude control panel.
8	Vertical scale	Sets the vertical scale value.
When connected to MSO/LPD		
9	Source	Source corresponds to selected display.
10	Measurement Instance number	Represents the instance of measurement display created.

Changing the Pulse Trace Display Settings

Pulse Trace display settings

Main menu: Setup > Settings

Favorites Toolbar: 

The Setup settings for the Pulse Trace display are shown in the following table.

Settings tab	Description
Params	Specifies several parameters that control how pulses are counted and defined.
Table continued...	

Settings tab	Description
Define	Specifies parameters that control where measurements are taken on a pulse.
Levels	Specifies parameters that control the method and levels used to calculate some pulse values.
Freq Estimation	Specifies the reference used for computing frequency error.
Scale	Specifies the vertical and horizontal scale settings.
Prefs	Specifies whether on not certain display elements are shown.

Restore defaults button

This button is located on the Pulse Trace Settings control panel. Sets the Pulse Trace display parameters to their default values.

Pulse Statistics display

The Pulse Statistics view displays a plot of a pulse measurement's values for every pulse in the analysis period. For example, the Pulse Statistics display will show the Rise Time measurement for each of 30 pulses, with rise time on the Y axis and pulse number on the X axis. Alternatively, the Statistics Display can show an FFT trace for the values of a measurement over all the pulses analyzed. Numeric readouts of Pulse Count, Max, Min, Peak to Peak, Average, and Standard Deviation in this display summarize results for the selected pulse measurement.

When Connected to MSO/LPD, multiple incoming signals from different sources (RF / IQ / Differential IQ) can be acquired, analyzed and the results can be viewed at same time in multiple displays.

Elements of the Pulse Statistics Display

The following images show the display when different plot types are selected. The table following these images explains the elements of these displays.

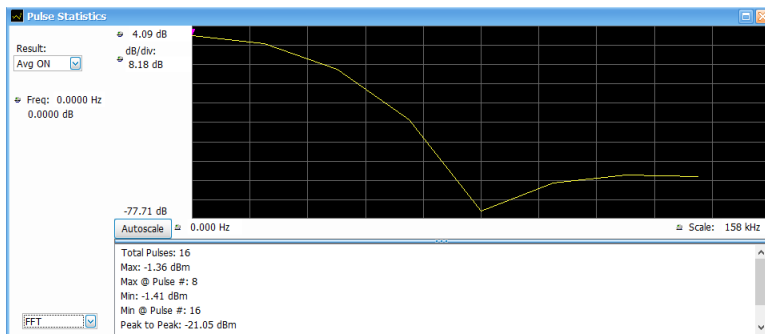

Figure 75: The image shows an FFT plot.

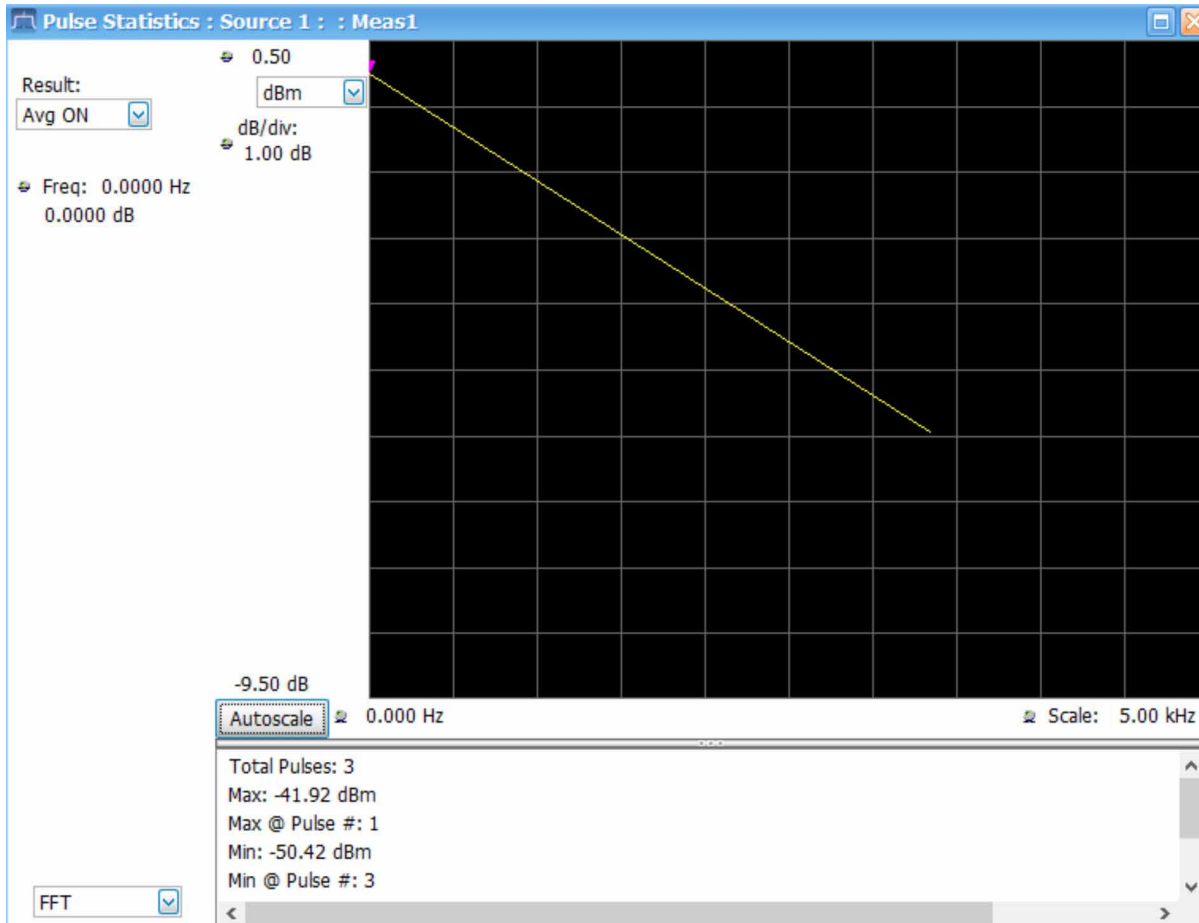

Figure 76: The image shows a FFT plot.

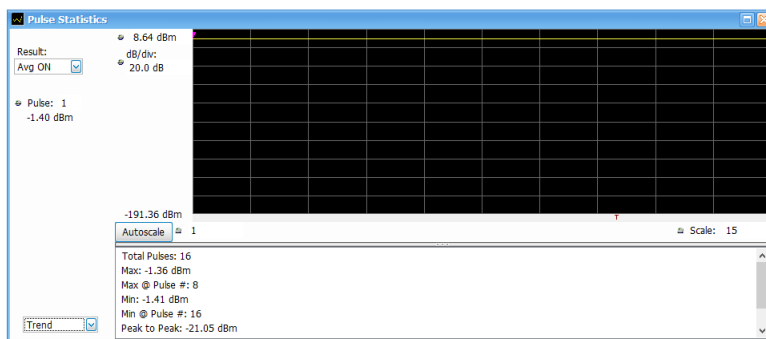

Figure 77: The image shows a Trend plot.

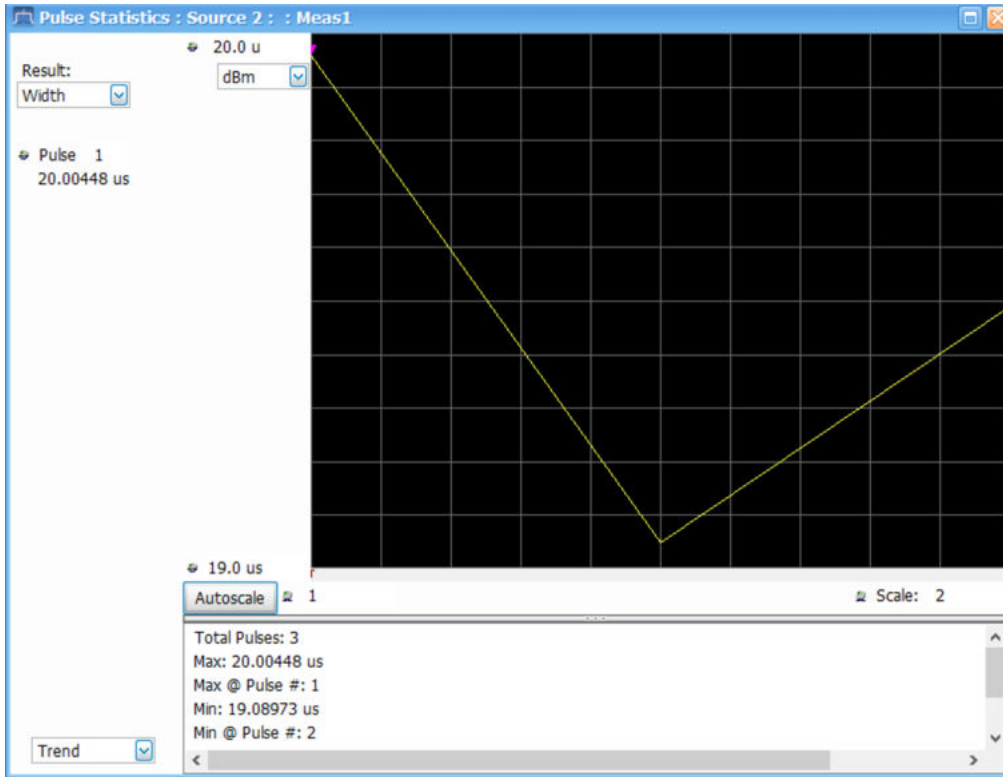

Figure 78: The image shows a Trend plot (Multichannel).

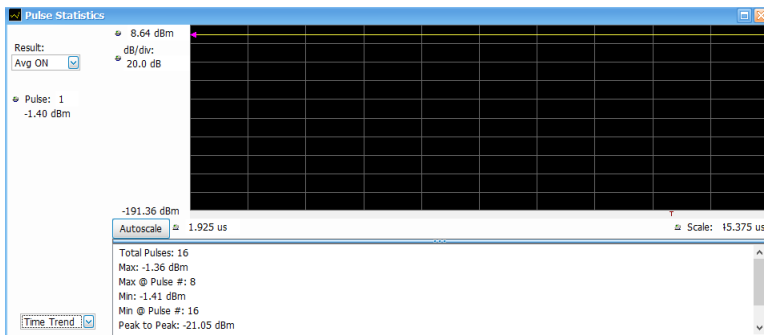

Figure 79: The image shows a Time Trend plot.

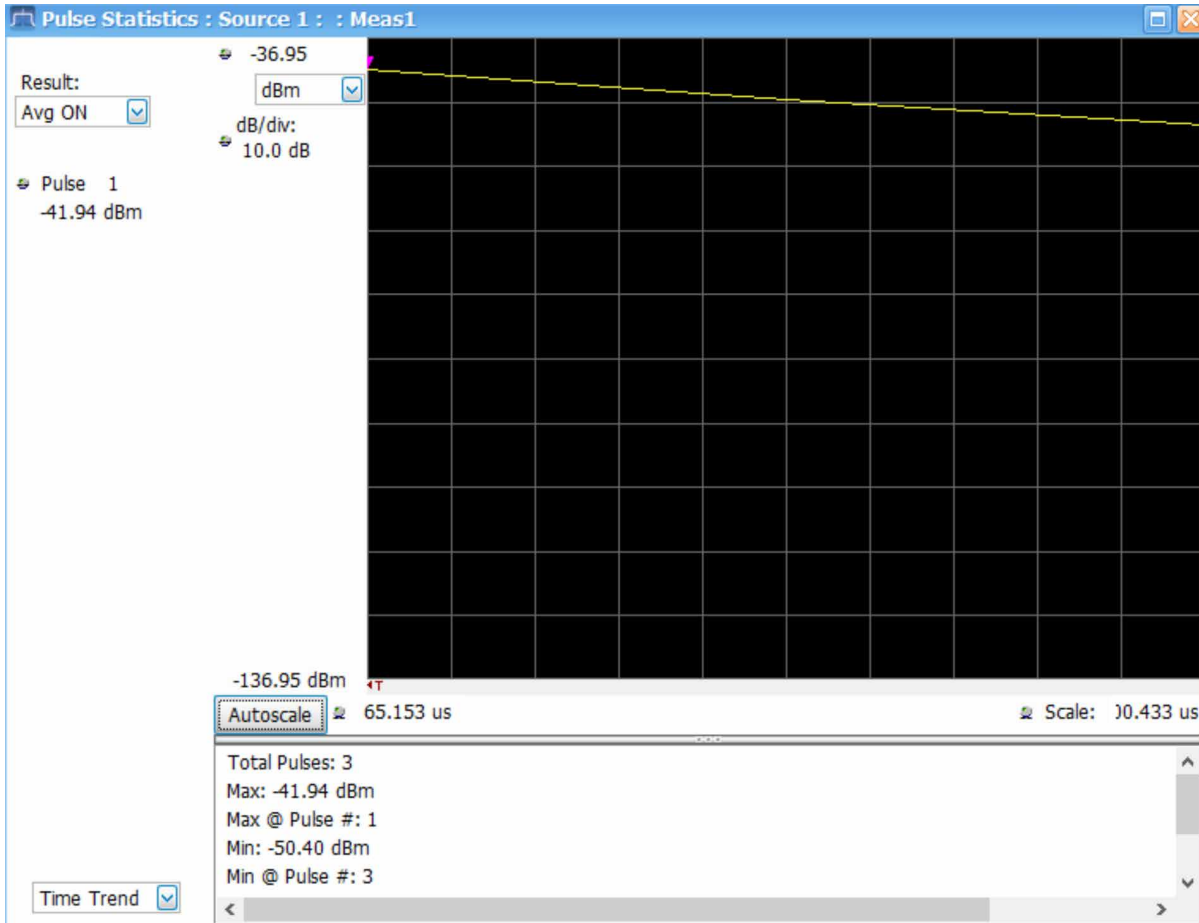

Figure 80: The image shows a Time Trend plot (Multichannel).

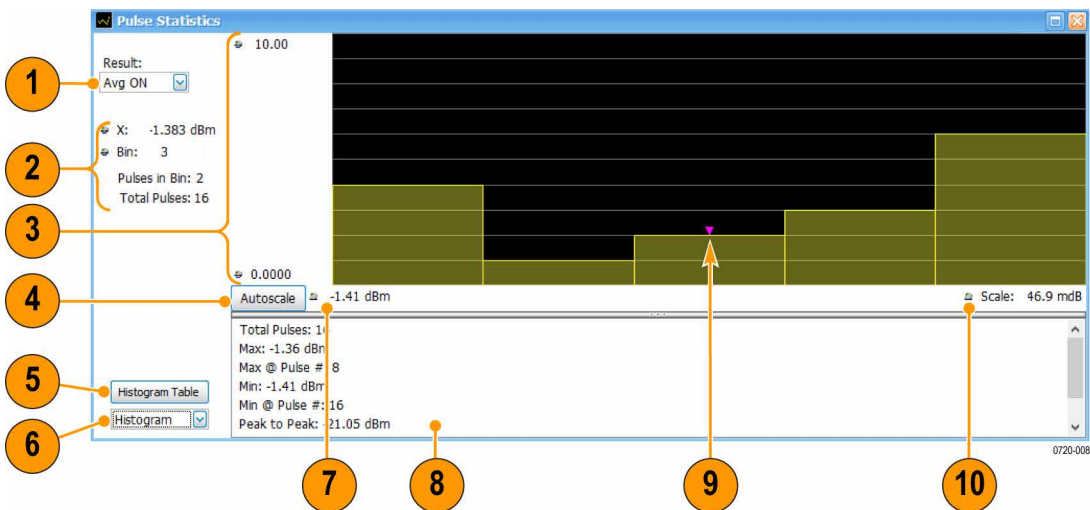
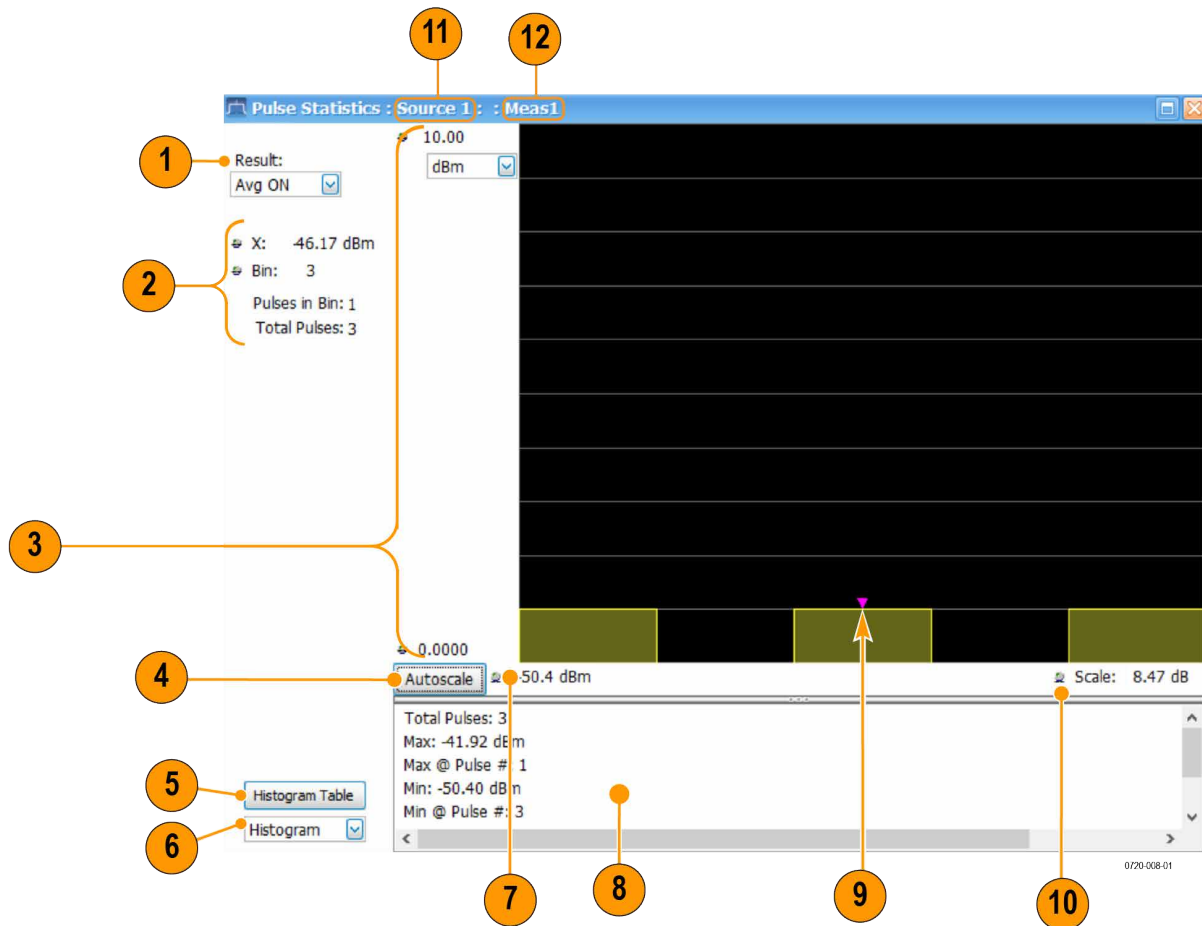

Figure 81: The image shows a Histogram plot.



The above figure is shown when connected to MSO/LPD.

Item	Display element	Description
1	Result	Use this list to select which measurement statistics to display. The measurement chosen here selects the same result to be displayed in the Pulse Trace display and the Pulse Table display. Selecting a result in any of these views causes the same result to be selected in all of them.
2	Results indicators (The indicators shown depend on the plot type selection. The values shown are plot indicator (Item 9) values.)	
	Pulse	Pulse indicator for Trend or Time Trend plots that indicates the pulse selected by the Pulse setting.
	Freq	Pulse indicator for FFT plots that marks the trace point at the selected frequency.
	X	For Histogram plots: A value of the selected result where the pulse indicator is positioned. Changing X will automatically change the bin number to the one that contains the X value.

Table continued...

Item	Display element	Description																																																
	Bin	For Histogram plots: Bin number where the indicator is positioned. Changing this number will change the value of X to the middle of the selected bin.																																																
	Pulses in Bin	For Histogram plots: Number of pulses in the selected bin.																																																
	Total Pulses	For Histogram plots: Total number of pulses analyzed in the current acquisition.																																																
3	Vertical	Sets the vertical range.																																																
4	Autoscale	Sets the axes to values for clear visibility of trace points.																																																
5	Histogram Table button	Contains the Bin number, Bin range, and Pulses in bin for the chosen measurement. <div data-bbox="599 674 1198 1123" data-label="Table"> <table border="1"> <thead> <tr> <th>Bin Number</th> <th>Bin Range</th> <th>Pulses in Bin</th> </tr> </thead> <tbody> <tr><td>1</td><td>196.00 MHz - 198.42 MHz</td><td>2</td></tr> <tr><td>2</td><td>198.42 MHz - 200.84 MHz</td><td>1</td></tr> <tr><td>3</td><td>200.84 MHz - 203.26 MHz</td><td>0</td></tr> <tr><td>4</td><td>203.26 MHz - 205.68 MHz</td><td>0</td></tr> <tr><td>5</td><td>205.68 MHz - 208.10 MHz</td><td>0</td></tr> <tr><td>6</td><td>208.10 MHz - 210.52 MHz</td><td>0</td></tr> <tr><td>7</td><td>210.52 MHz - 212.94 MHz</td><td>1</td></tr> <tr><td>8</td><td>212.94 MHz - 215.36 MHz</td><td>0</td></tr> <tr><td>9</td><td>215.36 MHz - 217.77 MHz</td><td>0</td></tr> <tr><td>10</td><td>217.77 MHz - 220.19 MHz</td><td>0</td></tr> <tr><td>11</td><td>220.19 MHz - 222.61 MHz</td><td>0</td></tr> <tr><td>12</td><td>222.61 MHz - 225.03 MHz</td><td>0</td></tr> <tr><td>13</td><td>225.03 MHz - 227.45 MHz</td><td>0</td></tr> <tr><td>14</td><td>227.45 MHz - 229.87 MHz</td><td>0</td></tr> <tr><td>15</td><td>229.87 MHz - 232.29 MHz</td><td>0</td></tr> </tbody> </table> </div>	Bin Number	Bin Range	Pulses in Bin	1	196.00 MHz - 198.42 MHz	2	2	198.42 MHz - 200.84 MHz	1	3	200.84 MHz - 203.26 MHz	0	4	203.26 MHz - 205.68 MHz	0	5	205.68 MHz - 208.10 MHz	0	6	208.10 MHz - 210.52 MHz	0	7	210.52 MHz - 212.94 MHz	1	8	212.94 MHz - 215.36 MHz	0	9	215.36 MHz - 217.77 MHz	0	10	217.77 MHz - 220.19 MHz	0	11	220.19 MHz - 222.61 MHz	0	12	222.61 MHz - 225.03 MHz	0	13	225.03 MHz - 227.45 MHz	0	14	227.45 MHz - 229.87 MHz	0	15	229.87 MHz - 232.29 MHz	0
Bin Number	Bin Range	Pulses in Bin																																																
1	196.00 MHz - 198.42 MHz	2																																																
2	198.42 MHz - 200.84 MHz	1																																																
3	200.84 MHz - 203.26 MHz	0																																																
4	203.26 MHz - 205.68 MHz	0																																																
5	205.68 MHz - 208.10 MHz	0																																																
6	208.10 MHz - 210.52 MHz	0																																																
7	210.52 MHz - 212.94 MHz	1																																																
8	212.94 MHz - 215.36 MHz	0																																																
9	215.36 MHz - 217.77 MHz	0																																																
10	217.77 MHz - 220.19 MHz	0																																																
11	220.19 MHz - 222.61 MHz	0																																																
12	222.61 MHz - 225.03 MHz	0																																																
13	225.03 MHz - 227.45 MHz	0																																																
14	227.45 MHz - 229.87 MHz	0																																																
15	229.87 MHz - 232.29 MHz	0																																																
6	Plot type selector	Select Trend, Time Trend, FFT, or Histogram as plot type.																																																
7	Horizontal offset	Adjusts the horizontal offset.																																																
8	Statistics summary	Display of measurement statistics for the selected result.																																																
9	Pulse indicator	For Trend and Time Trend plot types, this indicates the pulse selected by the Pulse setting. For the FFT plot type, this indicator marks the trace point at the selected frequency. For Histogram plot types, this indicator marks the selected results bin.																																																
10	Scale	Adjusts the horizontal scale.																																																
When connected to MSO/LPD																																																		
11	Source	Source corresponds to selected display.																																																
12	Measurement Instance number	Represents the instance of measurement display created.																																																

[Changing the Pulse Statistics Display Settings](#)

Pulse Statistics settings

Main menu bar: Setup > Settings

Favorites Toolbar: 

The settings for the Pulse Statistics display are shown in the following table.

Settings tab	Description
Params	Specifies several parameters that control how pulses are counted and defined.
Define	Specifies parameters that control where measurements are taken on a pulse.
Levels	Specifies parameters that control the method and levels used to calculate some pulse values.
Freq Estimation	Specifies the reference used for computing frequency errors.
Scale	Specifies the vertical and horizontal scale settings.
Prefs	Specifies whether or not certain elements of the display are shown.

Restore defaults button

This button is located on the Pulse Statistics Settings control panel. Sets the Pulse Statistics display parameters to their default values.

Pulsed RF measurement settings

Source Selection

Source can be changed for selected measurements from Settings control panel using Source drop-down.

The number of sources are depends on the number of sources connected to the instrument.



Note: The measurement source cannot be changed to the source which is available for other measurement. Acquisition must be stopped in order to change source.

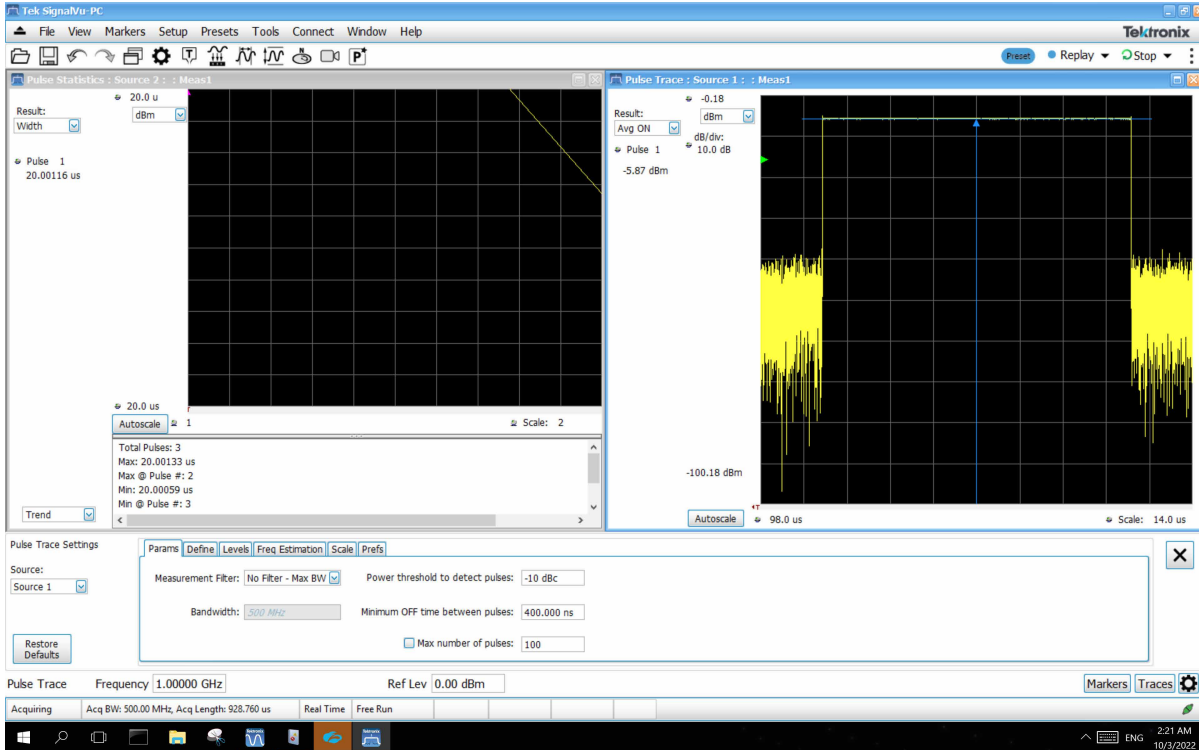

Figure 82: Pulse Trace with Source 1

The above figure is shown when connected to MSO/LPD

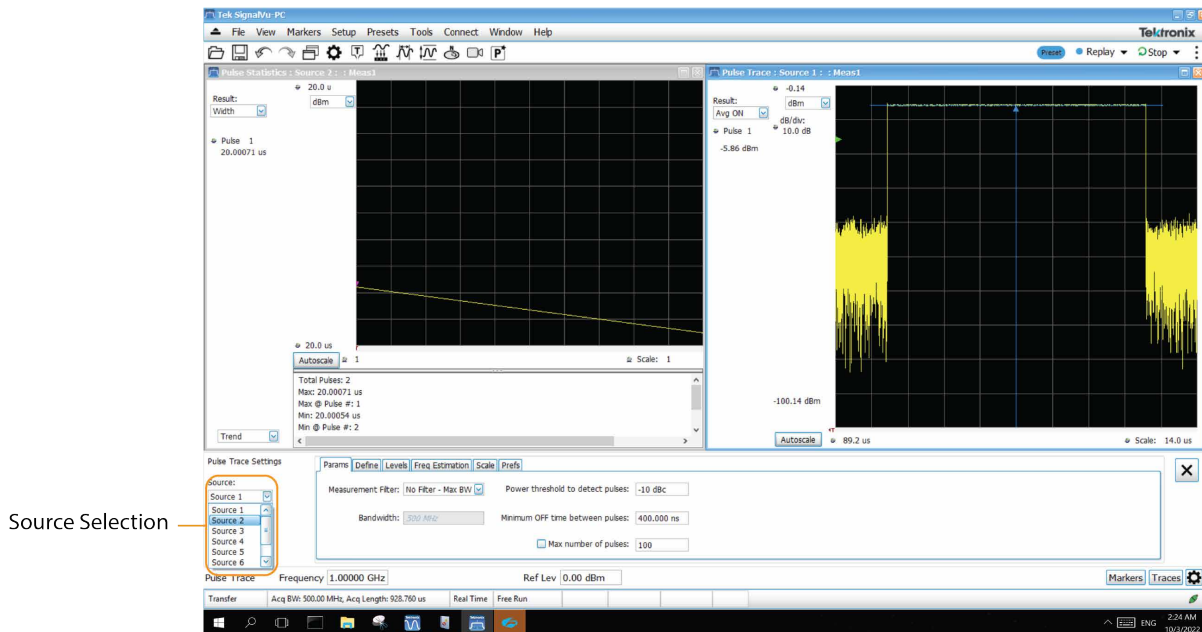

Figure 83: Source selection

The above figure is shown when connected to MSO/LPD

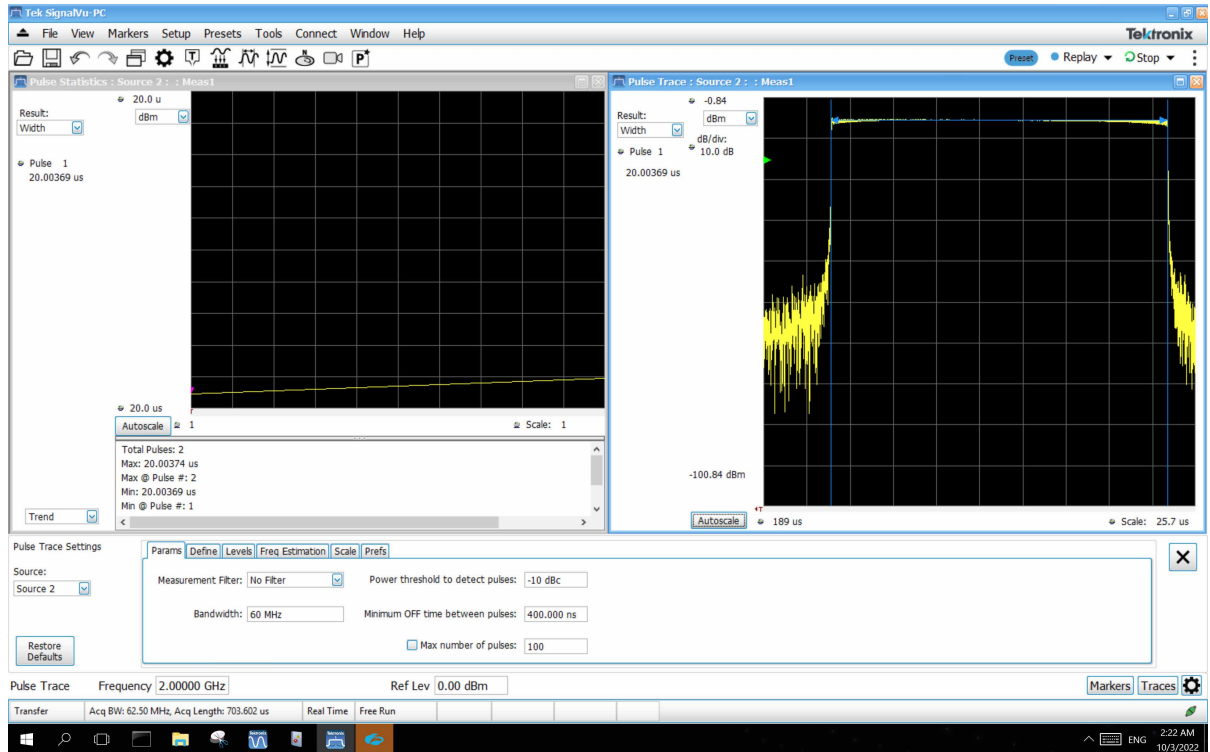

Figure 84: Pulse Trace with Source 2

The above figure is shown when connected to MSO/LPD

Some of the control panel tabs are shared by the Pulsed RF displays (Setup > Displays). Changing a setting in a shared tab changes that setting for all the Pulsed RF displays. The other control panel tabs are unique for each display. The following information explains both types.

Table 22: Common controls for pulsed RF displays

Settings tab	Description
Measurements	Specifies which measurement results appear in the Cumulative Statistics Table and Pulse Table displays.
Params	Specifies several parameters that control how pulses are counted and defined.
Define	Specifies parameters that control where measurements are taken on a pulse.
Analysis (Only Available for the Pulse-Ogram display)	Specifies parameters related to analysis of the signal.
Levels	Specifies parameters that control the method and levels used to calculate some pulse values.
Freq Estimation	Specifies the reference used for computing frequency errors.

Table continued...

Settings tab	Description
Traces (Only available for the Pulse-Ogram display)	Specifies the smooth points for the Time vs Time view and the detection method for the Frequency vs Time view.
Scale	Specifies the vertical and horizontal scale settings.
Prefs	Specifies whether or not certain elements of the display are shown.

Measurements Tab

The Measurements tab is used to specify the measurements that appear in the Cumulative Statistics Table display and the Pulse Table display.

Measurements Params Define Levels Freq Estimation Prefs

Show in Pulse Table:

- Average ON Power
- Peak Power
- Average Transmitted Power
- Pulse Width
- Rise Time

Select all

Clear all

Show in Cumulative Statistics Table

Checked measurements appear in the table.

Select all

Click **Select all** to choose all measurements for display in the table.

Clear all

Click **Clear all** to remove all measurements from the table display.

Params Tab

The Params tab enables you to adjust several measurement parameters for Pulsed RF displays. Not all parameters show for all displays.

Params Define Levels Freq Estimation Scale Prefs

Measurement Filter: Gaussian

Power threshold to detect pulses: -10 dBc

Bandwidth: 10 MHz

Minimum OFF time between pulses: 100.000 ms

Max number of pulses: 100

Setting	Description
Measurement Filter	Specify whether a filter is used to limit the bandwidth of the input signal.
Bandwidth	Sets the bandwidth of the measurement filter.
Power threshold to detect pulses	Specifies the level used for locating pulses in the data.
Minimum OFF time between pulses	Specifies the time the signal must fall below the power threshold for two pulses to be considered separate pulses.
Max number of pulses	Specifies the number of pulses to measure within the analysis time. <i>(Only available for the Pulse Statistics, Pulse Trace, and Pulse Table displays.)</i>

Measurement Filter

Three choices are available for the measurement filter:

- **No Filter - Max BW:** The widest acquisition bandwidth available is used. The **Bandwidth** setting is disabled, but shows the value in use.
- **No Filter:** - This is the default. The Bandwidth control is enabled to specify an acquisition bandwidth.
- **Gaussian** - The Bandwidth control is enabled for you to specify a value. The instrument uses an acquisition bandwidth two times wider than the entered value.

Power Threshold to Detect Pulses

Specifies the minimum power level the trace must exceed to be detected as a pulse. The range for this setting is: -3 to -70 dBc. The setting resolution is 1 dB. The default value is -10 dB.

Minimum OFF time between pulses

Specifies the time the signal must fall below the power threshold for two pulses to be considered separate pulses. The minimum value for this setting is 1.000 ns.

Max Number of Pulses

Only available for the Pulse Statistics, Pulse Trace, and Pulse Table displays.

If the Analysis Time contains fewer pulses than specified, the analyzer will measure all the pulse within the analysis time. If there are more pulses in the Analysis Time, than the specified number, the analyzer measures the specified number of pulses and ignores the rest. The setting resolution is: 1. If this setting is not checked, the analyzer will measure all pulses within the Analysis Time.

To determine the maximum number of pulses that can be analyzed, use the following equation:

$$\text{Max number of pulses that can analyzed} = \text{PulseRate} \times \text{capacity}$$

where:

- Pulse rate is the number of pulses per second (frequency).
- Capacity is a length of time which is displayed on the **Acquire > Sampling Parameters** tab.

Note that the maximum number of pulses is affected by several parameters. For example, measurement bandwidth affects the sample rate. The measurement algorithm also can reduce the maximum number of pulses that can be analyzed (by increasing the sample rate) based on the characteristics of the signal.

Additionally, when FastFrame is enabled, determining the maximum number of pulses is even more challenging. In FastFrame mode, the signal analyzer samples the signal around events of interest and ignores the signal between events of interest. Thus, if the instrument is only looking at pulses and ignoring the signal between pulses, the number of pulses that can be analyzed depends strongly on the characteristics of the pulse itself (for example, fewer wide pulses can be analyzed than narrow pulses, all other things being equal).

The Pulse Cumulative Statistics display provides statistics of pulses like Average, Standard Deviation, and Peak to Peak. Pulse Count does not have an upper limit for Pulse Cumulative Statistics. The Pulse Cumulative Histogram display provides information about the trend of the Pulse characteristics and outliers. This display does not support any upper limit or lower limit.

Note: In Fast Save mode, Pulse /Frame Count can go up to 200,000. This count also depends on the hard disk drive (HDD) capacity to store acquisitions.



The asterisk (*) around a pulse number indicates that it is a Fast Frame.

All Pulse Analysis displays except the Pulse-Ogram update results only after analysis of all fast frames.

Define Tab

The Define tab enables you to specify parameters that control where measurements are made on a pulse. The settings available depend on the measurement selected. This tab is not available for the Pulse-Ogram display.

The screenshot shows the 'Define' tab for 'Impulse Response' measurement. The 'Time method' is set to 'Absolute'. The 'Ref (R)' is 100%, 'Start (S)' is 0.000 s, and 'Length (L)' is 1.00 us. A diagram shows a pulse with a rise time 'x%' and measurement points R, S, and L. A small inset shows a waveform with a pulse and measurement points.

The settings that appear on the Define tab are described below. They may vary according to the Measurement(s) selection.

Freq-Domain Linearity

The screenshot shows the 'Define' tab for 'Freq-domain Linearity' measurement. The 'Time method' is set to 'Absolute'. The 'Ref (R)' is 100%, 'Start (S)' is 0.000 s, and 'Length (L)' is 1.00 us. A diagram shows a pulse with a rise time 'x%' and measurement points R, S, and L. A small inset shows a waveform with a pulse and measurement points.

Setting	Description
Time method	Specifies how the measurement's duration is determined. The choices are Absolute and Relative.
Absolute time method	

Table continued...

Setting	Description
Ref (R)	Ref specifies the level along the pulse rising edge that is defined as the point from which Start time is counted. Choices: 50%, 60%, 70%, 80%, 90% 100%; Default: 100%
Start (S)	Start specifies the time the instrument waits after the rising-edge reference before starting to measure the pulse. The Start time is measured from the point along the pulse rising edge specified by the Ref setting. Start Range: ± 100 ms; Resolution: 3 digits; inc/dec small: 1 ns, large: 1,2,5,10...; Default: 0
Length (L)	Length specifies the period of time that is used for pulse measurements The measurement time begins at the Start point and continues for the amount of time specified by Length.
Relative time method	
Length	In the Relative time method, Length specifies the percentage of the top of the pulse that is used for measurements. The instrument automatically determines the pulse top. The measurement length is centered within the pulse ON time.

Impulse Response

Measurements Params Define Levels Freq Estimation

Measurement(s):
 Impulse Response
 Apply ampl corrections
 Keep-out time (+/-): 0.000 s

Time method: Absolute
 Ref (R): 100 %
 Start (S): 0.000 s
 Length (L): 1.00 us

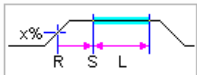

Setting	Description
Apply ampl corrections	Enable/disable corrections that remove errors due to the window function and to the time offset of the side lobe.
Keep-out time (+/-)	The Keep-out time specifies a region that is ignored when the trace is analyzed for side lobes. The setting defines a region to the left and to the right of the center of the main lobe. Lobes that fall within this time region are not eligible to be the "highest side lobe".
Time method	Specifies how measurement parameters are determined. The choices are Absolute and Relative.
Absolute time method	
Ref (R)	Ref specifies the level along the pulse rising edge that is defined as the point from which Start time is counted. Choices: 50%, 60%, 70%, 80%, 90% 100%; Default: 100%

Table continued...

Setting	Description
Start (S)	Start specifies the time the instrument waits after the rising-edge reference before starting to measure the pulse. The Start time is measured from the point along the pulse rising edge specified by the Ref setting. Start Range: ± 100 ms; Resolution: 3 digits; inc/dec small: 1 ns, large: 1,2,5,10...; Default: 0
Length (L)	Amount of time that should be included in the measurement. The measurement time begins at the Start point and continues for the amount of time specified by Length.
Relative time method	In the Absolute time method, Length specifies the period of time that is used for pulse measurements.
Length	In the Relative time method, Length specifies the percentage of the top of the pulse that is used for measurements. The instrument automatically determines the pulse top. The measurement length is centered within the pulse ON time.

P-R F Diff, P-P F Diff, F Abs, P-R \emptyset Diff, P-P \emptyset Diff

Params Define Levels Freq Estimation Scale Prefs

Measurement(s):
P-R F Diff, P-P F Diff, F Abs, P...  Measurement point: 500.000 ns

Setting	Description
Measurement point	Specifies the period in time after the 50% rising edge at which frequency and phase difference measurements are made.

Ripple

Measurements Params Define Levels Freq Estimation

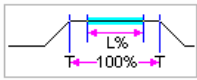
Measurement(s):
Ripple  Time method: Relative Ref (R): 100 %
Start (S): 0.000 s Length (L): 50.0 %

Setting	Description
Length	Length specifies the percentage of the top of the pulse that is used for measurements. The instrument automatically determines the pulse top. The measurement length is centered within the pulse ON time. Only the Relative Time method is available for Ripple.

Overshoot

Measurements Params Define Levels Freq Estimation

Measurement(s):
 Overshoot Time method: Absolute Ref (R): 100 %
 Start (S): 0.000 s
 Length (L): 1.00 us

Setting	Description
Time method	Specifies how measurement parameters are determined. The choices are Absolute and Relative.
Absolute time method	
Ref (R)	Ref specifies the level along the pulse rising edge that is defined as the point from which Start time is counted. Choices: 50%, 60%, 70%, 80%, 90% 100%; Default: 100%
Start (S)	Start specifies the time the instrument waits after the rising-edge reference before starting to measure the pulse. The Start time is measured from the point along the pulse rising edge specified by the Ref setting. Start Range: ± 100 ms; Resolution: 3 digits; inc/dec small: 1 ns, large: 1,2,5,10...; Default: 0
Length (L)	Amount of time that should be included in the measurement. The measurement time begins at the Start point and continues for the amount of time specified by Length.
Relative time method	
Ref	Ref specifies the level along the pulse rising edge that is defined as the point from which Start time is counted. Choices: 50%, 60%, 70%, 80%, 90% 100%; Default: 100%
Start	Start specifies the time the instrument waits after the rising-edge reference before starting to measure the pulse. The Start time is measured from the point along the pulse rising edge specified by the Ref setting. Start Range: ± 100 ms; Resolution: 3 digits; inc/dec small: 1 ns, large: 1,2,5,10...; Default: 0
Length	In the Relative time method, Length specifies the percentage of the top of the pulse that is used for measurements. The instrument automatically determines the pulse top. The measurement length is centered within the pulse ON time.

Levels Tab

Use the Levels tab to set parameters that control the method and levels used to calculate some pulse values.

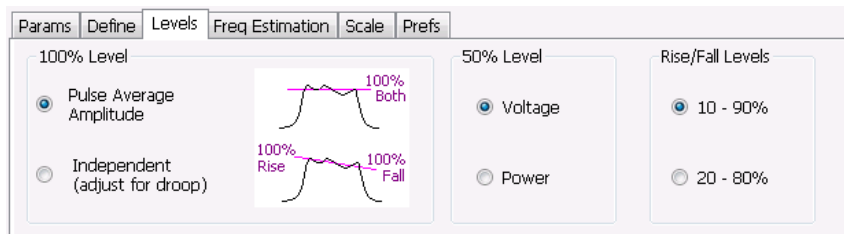

Setting	Description
100% Level	Specifies the method used to determine the 100% level(s).
50% Level	Specifies the method used to determine the 50% level on the pulse.
Rise/Fall Levels	Select whether to use the 10% to 90% or 20% to 80% points (based on voltage level) to define the rise and fall times.

100% Level

Use the 100% Level settings to select the method used to determine the 100% level(s) used for calculating pulse parameters, for example, Rise, Fall, and Width.

The Pulse Average Amplitude defines the pulse top as the average of the values of all the points along the pulse top. This average is used as the 100% level, from which the 10, 20, 50, 80 and 90% levels are calculated. Pulse measurements are referenced against these various levels. For example, Rise is the time between the 10 and 90% (or 20 and 80%) levels on the rising edge of the pulse. When the Pulse Average Amplitude method is selected, the same 100% level is used for both rising and falling edges.

Because some RF pulse types have droop (a height difference between the beginning and ending points of the pulse top), the 100% percent level on the rising edge may not be equal to the 100% level on the falling edge. The Independent method of pulse point location is designed for pulses with different 100% levels at their rising and falling edges. The Independent method calculates the 100% level for the rising edge separately from the 100% level of the falling edge. As a result, the 10, 20, 50, 80 and 90% levels are also different for the rising and falling edges, allowing for more accurate measurements on pulses with droop.

50% Level

Select Voltage to use -6 dB as the 50% point. Select Power to use -3 dB as the 50% level.

Freq Estimation Tab

Use the Freq Estimation tab to specify parameters used for determining frequency offset. This tab is not available for the Pulse-Ogram display.

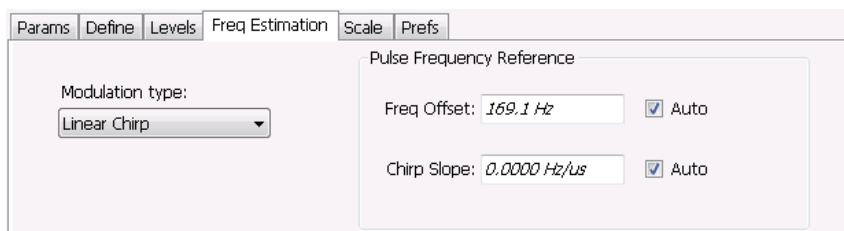

Setting	Description
Modulation type	Specifies which algorithm to use for estimating frequency error.
Pulse Frequency Reference	Specifies the method used to determine the pulse frequency error and if applicable, the chirp slope.
Auto	Selecting Auto causes the instrument to calculate the frequency offset and if applicable, the chirp slope.
Freq Offset	If Auto is not enabled, specify the value for frequency offset here. If Auto is enabled, the offset is set to zero and this readout displays the calculated frequency error.
Chirp BW	If Auto is not enabled, specify the value for Chirp Slope here. If Auto is enabled, this readout displays the calculated Chirp slope. This setting is used only when the modulation type is set to Linear Chirp.

Modulation Type

Frequency estimation is performed by the instrument using selectable methods, depending on signal type. The selections for modulation type are CW (constant phase), CW (changing phase), Linear Chirp and Other. Select the method of frequency method based upon a best match to your signal based on the following descriptions:

- CW (constant phase): The signal is not designed to change in either frequency or phase during the measured pulse train.
- CW (changing phase): The signal does not change the carrier phase within each pulse, although it could change the phase from one pulse to another pulse. The signal is not designed to make frequency changes.
- Linear Chirp: The signal changes frequency in a linear manner during each pulse. The signal has the same carrier phase at the same time offset from the rising edge of the pulse.
- Other: The signal is not one of the listed types. You must manually enter the Frequency Offset value.

The following table maps the appropriate signal type selection with the signal characteristics.

Signature	Phase offset from one pulse to another	
	Zero	Any (unknown)
CW	CW Constant Phase	CW Changing Phase
LFM	Linear Chirp	N/A

Analysis Tab

The Analysis tab is only available for the Pulse-Ogram display. It allows you to set parameters related to analysis of the signal. The settings vary depending on which spectrum analysis region you select.

Analysis Traces Scale Prefs

Measurement Bandwidth
40 MHz

Frequency vs Time

Filter Shape: Kaiser (RBW)

Spectrum Analysis Region:

- Use Analysis Time settings
- Pulse ON Time
- Independent

Analysis Traces Scale Prefs

Measurement Bandwidth
40 MHz

Frequency vs Time

Filter Shape: Kaiser (RBW)

Spectrum Analysis Region:

- Use Analysis Time settings
- Pulse ON Time
- Independent

Length: 100 %

Power threshold to detect pulses: -10 dBc

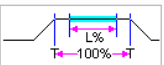

Analysis Traces Scale Prefs

Measurement Bandwidth
40 MHz

Frequency vs Time

Filter Shape: Kaiser (RBW)

Spectrum Analysis Region:

- Use Analysis Time settings
- Pulse ON Time
- Independent

Start: 0.000 s

Length: 89.143 us

Setting	Description
Measurement bandwidth	Specifies the frequency range used by the measurement. This control is linked to the Bandwidth control of other Pulsed RF Displays. If No Filter – Max BW is selected in other displays, the control setting is disabled, but shows the maximum value possible. If No Filter or Gaussian is selected in other displays, then the Bandwidth control is also enabled in the Pulse-Ogram display.
Filter shape	Spectrum of the signal is windowed by the desired filter shape.
Use analysis time settings	Provides the complete analysis length as displayed in Time Overview.
Pulse on time	Analysis is done in the ON period of the data.
Length	Specifies the analysis length.
Power threshold to detect pulses	Specifies the level used for locating pulses in the data.
Independent	In Manual option, you can choose the analysis length of the desired type for the Freq vs Time view in the display.
Start	Specify the analysis offset. The default value is the offset in Time Overview.
Length	Specify the analysis length. The default value is the length in Time Overview.

Traces Tab

The Traces tab is only available for the Pulse-Ogram display. It allows you to set the trace characteristics for the display.

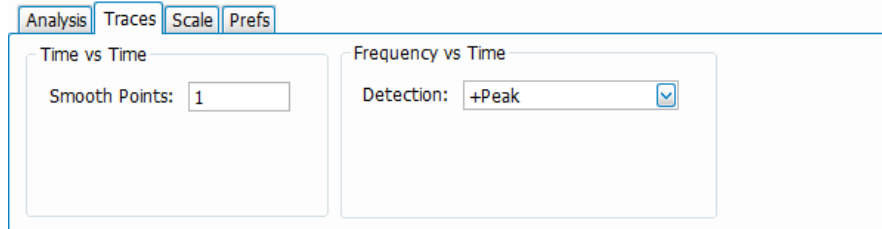

Setting	Description
Smooth points	Shows the number of filter coefficients used for smoothening the noisy region for visual clarity.
Detection	Trace Detection is used to reduce the results of a measurement to the desired number of trace points.

Detection

Trace Detection is used to reduce the results of a measurement to the desired number of trace points. For example, if the maximum number of trace points is 100,000 and a measurement over the selected analysis length yields 200,000 points, the measurement must decimate these 200,000 trace points by 2 to prevent exceeding the 100,000 trace point limit. Since only one value can be represented for each trace point, an algorithm must be used to select (detect) the appropriate value to use.

The results array from an analysis can be detected (or “decimated”) in a variety of ways. The number of results points produced for each trace point varies with both analysis length and trace length. For example, the frequency transform used for the Spectrum display produces just one output value for each desired trace point. In this case, the detection method chosen has no effect, as no decimation is required.

Increasing the Analysis Length (or for the Spectrum display, the Spectrum Length), causes the available detection method's output traces to differ from each other because they have a larger set of samples for the various detection methods to process.

The available detection methods are:

- **+Peak:** The highest value is selected from the results to be compressed into a trace point.
- **-Peak:** The lowest value is selected from the results to be compressed into a trace point.
- **Avg (VRMS):** Each point on the trace is the result of determining the RMS Voltage value for all of the results values it includes. When displayed in either linear (Volts, Watts) or Log (dB,dBm), the correct RMS value results.
- **Sample:** The first value is selected from the set of results to be compressed into a trace point.

Scale Tab

The Scale tab is only available for trace displays. It allows you to change the vertical and horizontal scale settings. Changing the scale settings changes how the trace appears on the display but does not change control settings such as Measurement Frequency. In effect, these controls operate like pan and zoom controls. Each display has different settings, as shown below.

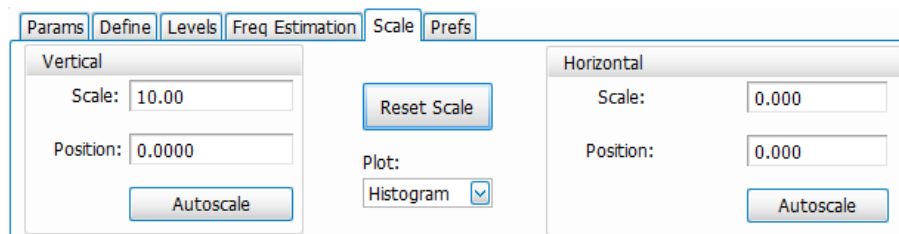

Figure 85: The above image shows the Scale tab for the Pulse Statistics display.

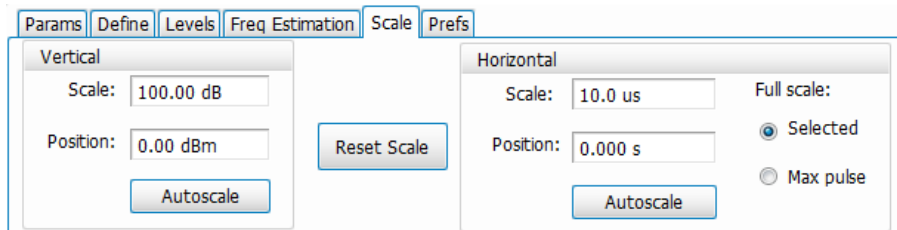

Figure 86: The above image shows the Scale tab for the Pulse Trace display.

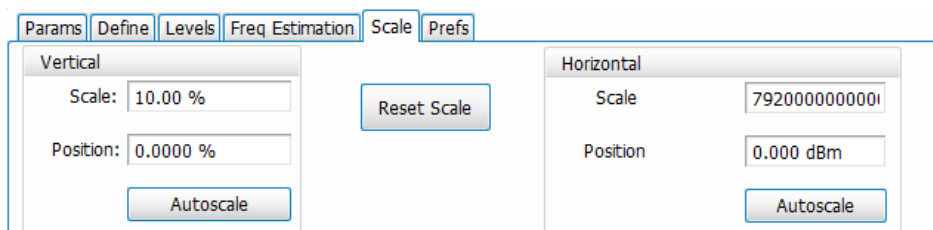

Figure 87: The above image shows the Scale tab for the Pulse Cumulative Statistics display.

Setting	Description
Vertical	Controls the vertical position and scale of the trace display.
Scale	Changes the vertical scale. The units for this setting depend on the statistic selected from the Result drop-down list in the Pulse Statistics display.
Position	Adjusts the Reference Level away from the top of the trace display. The units for this setting depend on the statistic selected from the Result drop-down list in the Pulse Statistics display.
Autoscale	Resets the scale of the vertical axis to contain the complete trace.
Horizontal	Controls the span of the trace display and position of the trace.
Scale	Allows you to change the span.
Position	Allows you to pan a zoomed trace.
Full Scale (Pulse Trace display only)	Specifies the Horizontal scale default.
Selected	Sets the horizontal scale default to be based on the result value for the currently-select pulse.
Max Pulse	Sets the horizontal scale default to be based on the largest value for the selected pulse measurement.
Autoscale	Resets the scale of the horizontal axis to contain the complete trace.
Plot (Pulse Statistics display only)	Specifies the FFT, Trend, Time Trend, or Histogram plot.
Reset Scale	Restores all settings to their default values.

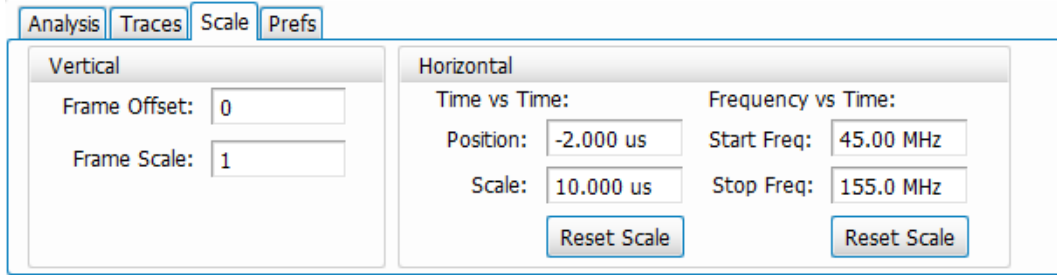

Figure 88: The above image shows the Scale tab for the Pulse-Ogram display.

Setting	Description
Vertical	Controls the vertical position and scale of the trace display.
Frame Offset	Display will start after the indicated frame number.
Frame Scale	Shows how many frames are displayed in both Time vs Time and Frequency vs Time views.
Horizontal (Time vs Time view)	Controls the span of the Time vs Time trace display and position of the trace.
Position	Allows you to pan a zoomed trace. The default value matches the offset of the acquisition.
Scale	Allows you to change the span. The default value matches the length of the acquisition.
Reset Scale	Restores the position and scale settings to default value.
Horizontal (Frequency vs Time view)	Controls the span of the Frequency vs Time trace display and position of the trace.
Start Freq	Allows you to set the starting frequency shown in the graph without changing analysis. The default value matches the highest frequency of the span.
Stop Freq	Allows you to set the stop frequency shown in the graph without changing analysis. The default value matches the highest frequency of the span.
Reset Scale	Restores the start frequency and stop frequency to default values.

Prefs Tab

The Prefs tab is only available for Pulsed RF trace displays. It is not available for the table displays. It enables you to change parameters of the measurement display. Available parameters vary depending on the selected display.

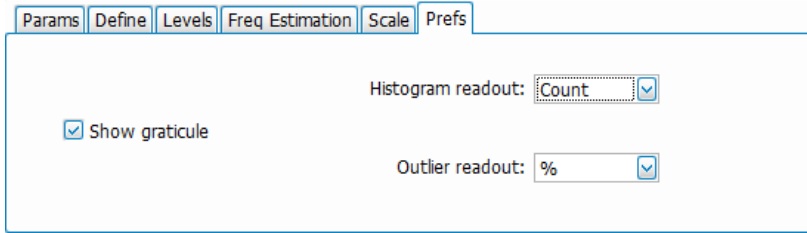

Figure 89: The above image shows the Prefs tab for the Pulse Cumulative Histogram display.

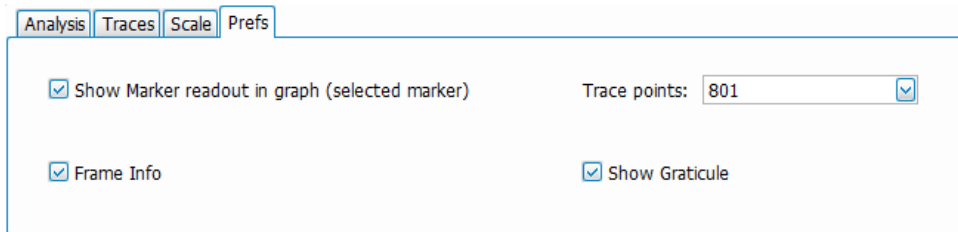

Figure 90: The above image shows the Prefs tab for the Pulse-Ogram display.

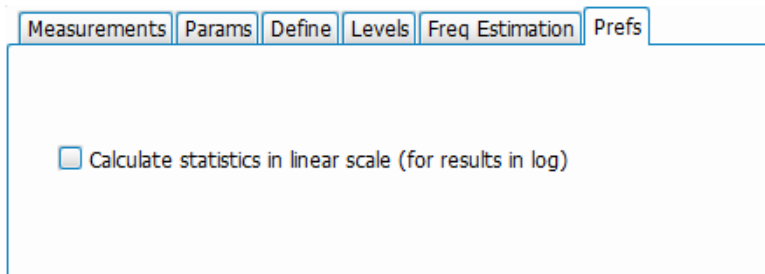

Figure 91: The above image shows the Prefs tab for the Pulse Cumulative Statistics display.

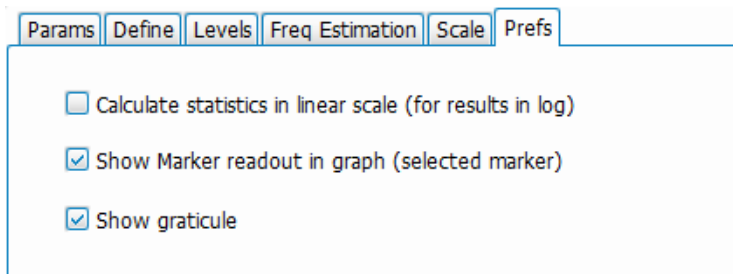

Figure 92: The above image shows the Prefs tab for the Pulse Statistics display when Time Trend is the selected plot type. Trend and FFT plot types do not show the Show Marker readout selection.

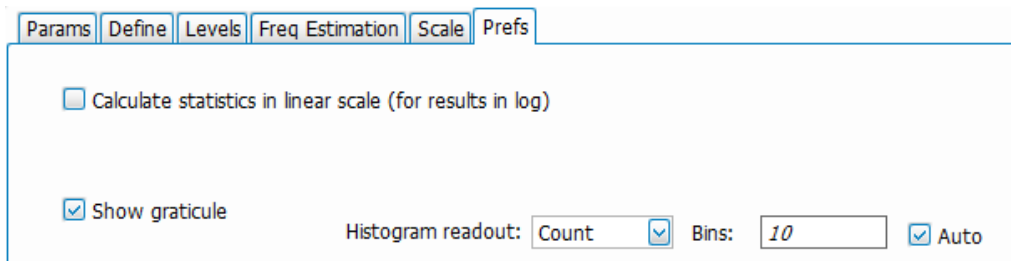

Figure 93: The above image shows the Prefs tab for the Pulse Statistics display when Histogram is the selected plot type.

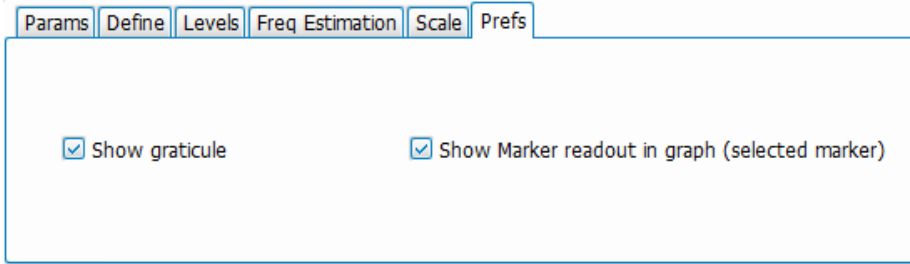

Figure 94: The above image shows the Prefs tab for the Pulse Trace display.

Setting	Description
Show graticule	Displays or hides the graticule in the trace display.
Show Marker readout in graph <i>(Only available for Pulse Trace and Pulse-Ogram displays.)</i>	When a marker is enabled, this setting displays or hides the maker readout, but not the maker itself, on Time Trend plots.
Histogram readout <i>(Only available for Cumulative Histogram display and the Pulse Statistics display when Histogram is the plot type.)</i>	Controls the parameters Histogram readout and Bins. Histogram readout can be set to either Count or %. Count indicates the number of hits that fell into each bin. % indicates percentage of the total count (for the acquisition) that fell into each bin.
Calculate statistics in linear scale (for results in log) <i>(Only available for Pulse Statistics display.)</i>	Checking this box allows for calculation of statistics in the linear domain (for example, the Power values in dB are converted to Watts (linear scale) and statistics are computed in Watts and then converted back to dB scale). This measurement will be observed only when this box is selected. This selection only appears in the Pulse Statistics display for these measurements: Average ON Power, Average Transmitted Power, Peak Power, Impulse Response Amplitude, Droop dB, Overshoot dB, and Ripple dB.
Bins <i>(Only available for Pulse Statistics display when Histogram is the plot type.)</i>	Specifies how many "bins" or histogram bars the results are distributed into.
Auto <i>(Only available for Pulse Statistics display when Histogram is the plot type.)</i>	Sets the bin number to automatic default, which is 10.
Outlier readout <i>(Only available for Cumulative Histogram display)</i>	Controls the parameters Outlier readout and Bins. Outlier readout can be set to either Count or %. Count indicates the number of hits that fell into each bin. % indicates percentage of the total count (for the acquisition) that fell into each bin.
Trace points <i>(Only available for the Pulse-Ogram display.)</i>	Sets the number of trace points used for marker measurements and for results export.

Table continued...

Setting	Description
Frame Info	Displays or hides the frame information in the display. <i>(Only available for the Pulse-Ogram display.)</i>

The statistics can be calculated in the linear domain as well the log

Average ON Power, Average Transmitted Power, Peak Power, Impulse Response Amplitude, Droop dB, Overshoot dB, Ripple dB, the statistics can be calculated in linear domain as well, i.e. the Power values in dB are converted to watts (linear scale) and statistics are computed in watts and then converted back to dB scale. This measurement will be observed only when the Calculate statistics in linear scale (for results in log) is selected.

EMC Accessories

Overview

Tektronix has accessories for EMC pre-compliance testing available to you. The following topics are presented to assist you with using these accessories to perform tests.

- [Radiated tests introduction](#)
- Antennas and radiated test accessories
 - [EMI-BICON-ANT biconical antenna](#)
 - [EMI-CLP-ANT Log Periodic Dipole Array antenna](#)
 - [EMI-PREAMP preamplifier](#)
 - [EMI-TRIPOD antenna tripod](#)
- How to set up a radiated pre-compliance test for
 - [30 MHz to 300 MHz](#)
 - [300 MHz to 1 GHz](#)
- [Conducted tests introduction](#)
- Conducted test accessories
 - [EMI-LISN50UH-US](#)
 - [EMI-LISN50UH-GB](#)
 - [EMI-LISN50UH-EU](#)
- [How to set up a conducted pre-compliance test with LISN](#)
- Other accessories
 - [CABLE-1M, CABLE-3M, CABLE-5M](#)
 - [EMI-LISN5UH](#)
 - [EMI-NF-AMP](#)
 - [EMI-NF-PROBE](#)
 - [EMI-TRANS-LIMIT](#)
- [Accounting for accessories contributions in the EMCVu software](#)



Tip: View the topics in the [EMC Analysis](#) section of this Help for information about using the EMC Analysis software.

Radiated tests introduction

Radiated emissions testing is about measuring the electromagnetic field strength of the emissions that are unintentionally generated by your product. Emissions are integral to the switching voltages and currents within any digital circuit; however, it is important that they comply emission limits.

The actual setup for Compliance tests is clearly specified in the standard document as applicable to the different types of products. You should refer to these standards for details about the actual setup. There are several challenges in the actual Radiated test setup. The electromagnetic waves don't extend out from your product in a nice spherical pattern. The emissions tend to be directional, so a test lab would typically vary the height of the receiving antenna between 1 and 4 meters as well as rotate a turntable. The receiving antenna picks up both the signal direct from the EUT, as well as a bounce off the ground. To increase measurement accuracy, the ground is covered with an electromagnetically reflective surface (aluminum, steel, wire mesh etc..) and this ground plane must be relatively flat. The EUT will be scanned in the frequency band of interest and you will look for emissions that are close to the limits.

Pre-compliance can help you find out emission issues early or troubleshoot emissions issues reported by a test house. A Radiated Emission Pre-Compliance test setup diagram is shown below with the equipment under test (EUT), ground plane, antenna mounted on a tripod, a pre-amplifier, and a spectrum analyzer. The picture that follows the diagram is provided to show the antenna connected to pre-amplifier to spectrum analyzer (without the ground plane). The radiation from the EUT is picked up by the antenna, the output of which is amplified by a pre-amplifier for better sensitivity. The output of the pre-amplifier is connected to the input of the analyzer that acquires the signal and analyzes it with the help of the software (EMCVu).

Radiated Emissions Test Setup

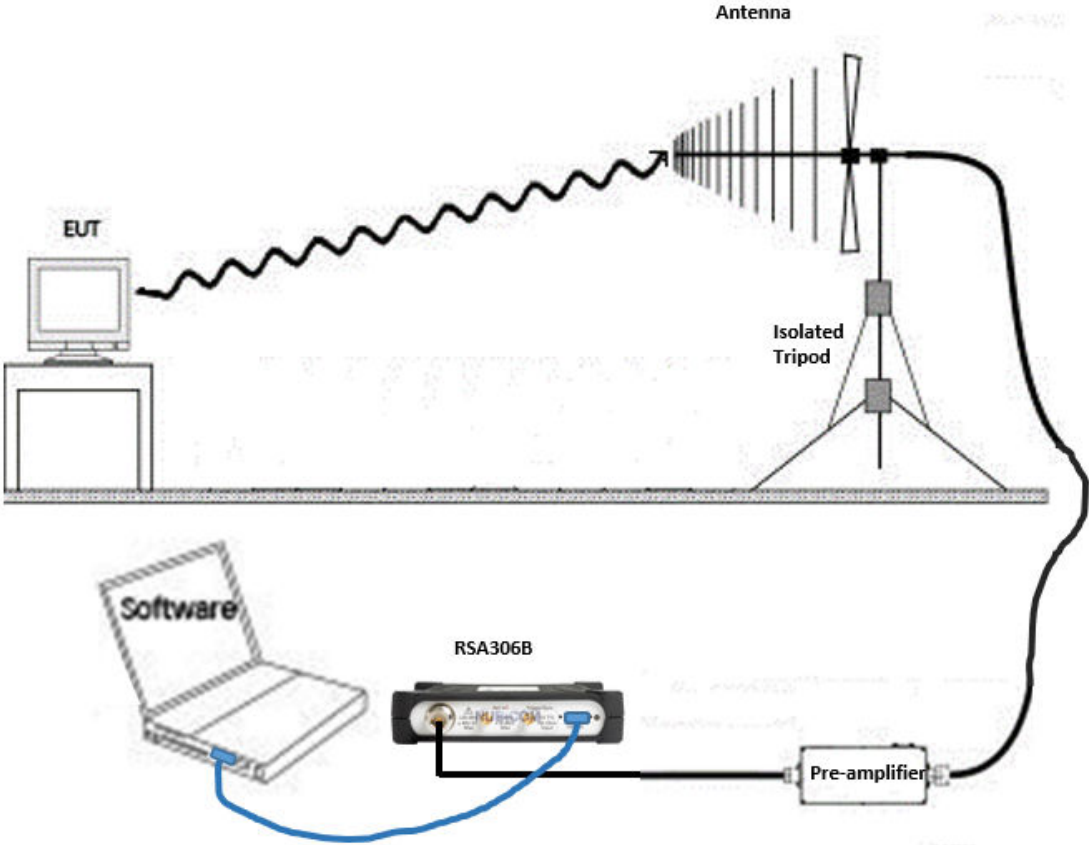



EMI-BICON-ANT (ABF-900A biconical antenna)

The EMI-BICON-ANT (Com-Power ABF-900A) is a broadband, linearly polarized Biconical Dipole Antenna with collapsible elements, operating over the frequency range of 25 MHz to 300 MHz. Each full-size biconical element (54 cm cage diameter) collapses to a maximum diameter of 5 cm for easy transport/storage.

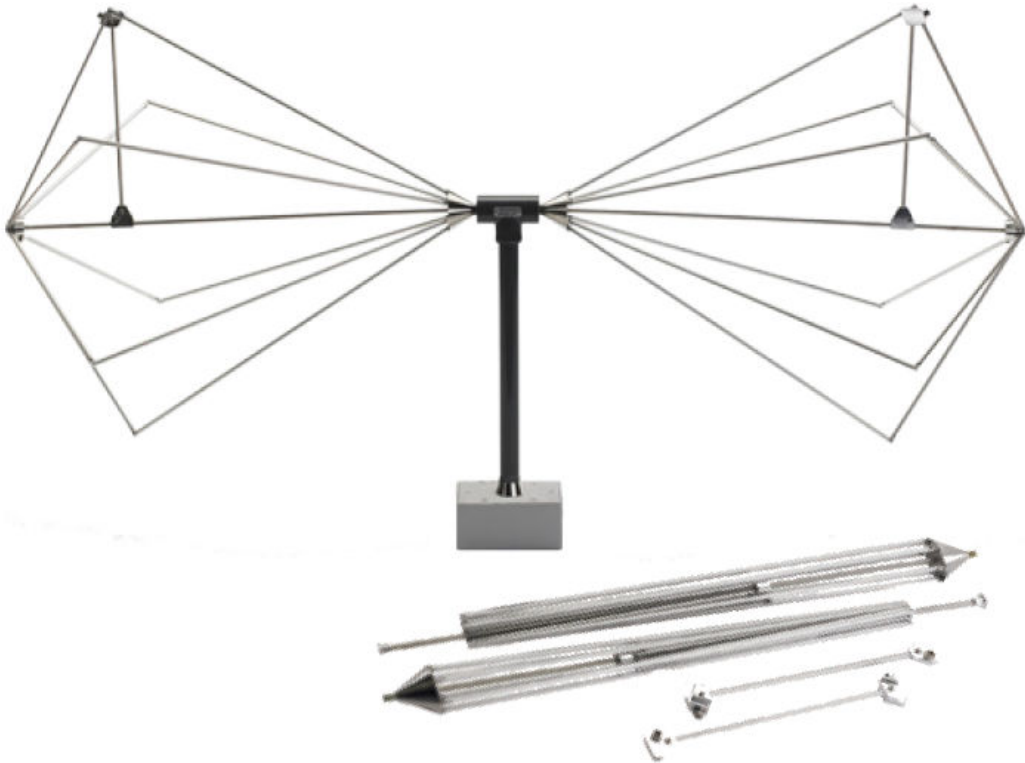

The ABF-900A biconical antenna is intended for use as an EMI test antenna for qualification-level regulatory compliance measurements (FCC, CE, Mil-Std, RTCA DO-160, FDA, SAE Automotive, etc.).

ABF 900 has the following characteristics (Antenna factor).

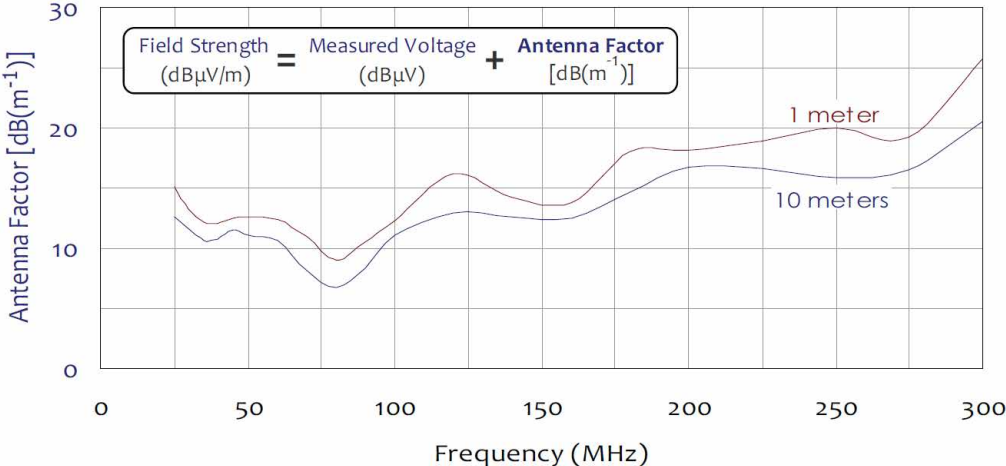

These factors can be loaded into the EMCVu Accessories tab (located in the EMC Settings control panel or the EMC Project Setup Wizard). The file will be available to you in C:\SignalVu-PCFiles\EMC_Accessories.

 **Tip:** See the [Radiated tests introduction](#) topic for more information and to view a connections diagram.

EMI-TRIPOD (AT-812 antenna tripod)

The recommended support structure for the Com-Power ABF-900A is the Com-Power AT-812 Antenna Tripod. One of the standard AT-812 accessories is the Com-Power ATHP-812 Antenna Pipe Holder, which clamps securely around the one-inch diameter feed tube of the ABF-900A. The ATHP-812 is then secured to a tripod or mast via its 1/4" x 20 thread mounting hole.



Figure 95: The above image shows the tripod.



Figure 96: The above image shows the mounted antenna with the pipe holder.



Tip: See the [Radiated test introduction](#) topic for more information and to view a connections diagram.

EMI-CLP-ANT (ALC-100 Log Periodic Dipole Array (antenna))

The Com-Power ALC-100 is a broadband, linearly polarized Log Periodic Dipole Array (LPDA) antenna, operating over the frequency range of 200 MHz to 1 GHz and with excellent efficiency between 300 MHz and 1 GHz.

The ALC-100 Compact Log Periodic Antenna is intended for use as an EMI test antenna for qualification-level regulatory compliance measurements (FCC, CE, RTCA DO-160, FDA, SAE Automotive, etc.).



The ALC-100 can also be mounted using the AT-812 tripod (which is a part of the accessories given by Tektronix).

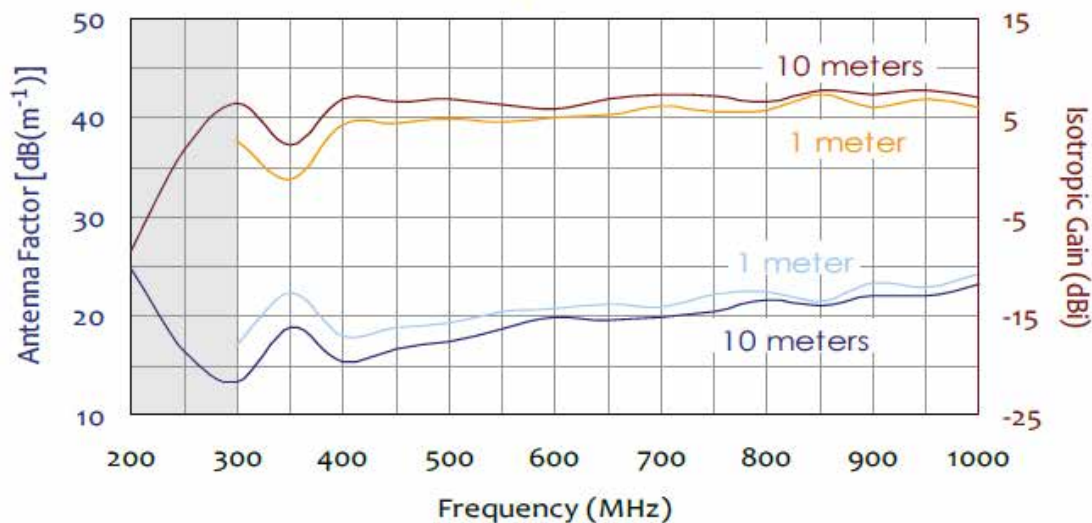

Tip: See the [Radiated tests introduction](#) topic for more information and to view a connections diagram.

EMI-PREAMP (PAM-103 preamplifier)

The Com-Power PAM-103 is a broadband, high gain, low-noise preamplifier operating over the frequency range of 1 MHz to 1 GHz. Its high gain (33 dB \pm 3 dB) and low noise figure (<3.3 dB) make the PAM-103 preamplifier the ideal choice for optimizing your EMI measurement system, whether it be a test chamber, open area test site, or tem-cell.

The PAM-103 can be powered by its internal, rechargeable battery packs, or by its AC to DC power adapter/battery charger. On a full charge, the preamp will operate on battery power for over 13 hours. The battery low indicator light will let you know when it is time to plug it in and the charging indicator light will let you know that it is charging. If you are unable to plug it in, you can feel confident in continuing your test, because the PAM-103 will turn itself off before the battery voltage reaches the point at which the gain could become unstable.

Whether it is operating on battery power or external power, if the amp is on, the output should be stable and the gain should remain constant.



Nearly all measurement systems for radiated EMI tests require preamplification to achieve the necessary sensitivity.

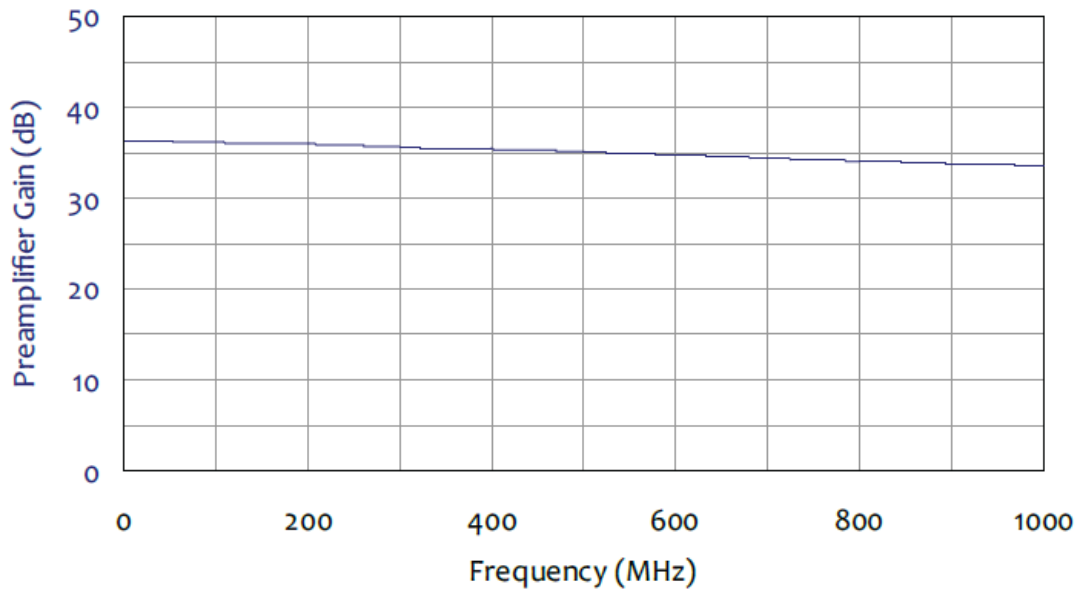

Tip: See the [Radiated tests introduction](#) topic for more information and to view a connections diagram.

Radiated pre-compliance test setup (30 MHz to 300 MHz)

A simple pre-compliance setup is shown below using a ABF-900 antenna, a preamplifier, and an RSA306B real-time spectrum analyzer.

1. Mount the antenna pipe holder ATHP-812 on the top support (ATTS-812) of the tripod (AT-812).



2. Mount the antenna pipe AB-900A on the antenna pipe holder (ATHP-812).



3. Fix the biconical antenna (ABF-900) to the antenna pipe (AB-900A).





4. Connect the output of the antenna pipe to a pre-amplifier through a Tektronix [cable](#).
5. Connect the output of the pre-amplifier to a Tektronix USB spectrum analyzer or a RSA5100B series spectrum analyzer.



Tip: See the [Radiated tests introduction](#) on page 398 topic for more information and to view a connections diagram.

Radiated pre-compliance test setup (300 MHz to 1 GHz)

A pre-compliance setup is shown below using the ALC-100 antenna, a preamplifier, and an RSA306B real-time spectrum analyzer.

1. Clamp the accessory to the top support (ATTS-812) of the tripod (AT-812).



2. Mount the antenna (ALC-100) to the accessory connected in the previous step.



3. Connect the output of the antenna to a pre-amplifier through a Tektronix [cable](#).
4. Connect the output of the pre-amplifier to a Tektronix USB spectrum analyzer or an RSA5100B series spectrum analyzer.



Tip: See the [Radiated tests introduction](#) on page 398 topic for more information and to view a connections diagram.

Conducted tests introduction

Conducted emission tests are about testing the portion of electromagnetic energy created by your device that is conducted onto the power supply cord. To restrict the amount of interference your device can couple back onto a power supply, test labs measure these emissions (usually from 150 kHz - 30 MHz) and verify that they comply with specified limits.

This helps to ensure that the local power supply remains relatively clean and nearby devices will not be affected by your device. Conducted emissions testing is usually performed on devices that connect to an AC power supply. For some standards, there are also limits placed on devices that operate from a DC power supply.

Conducted Emissions Test Setup

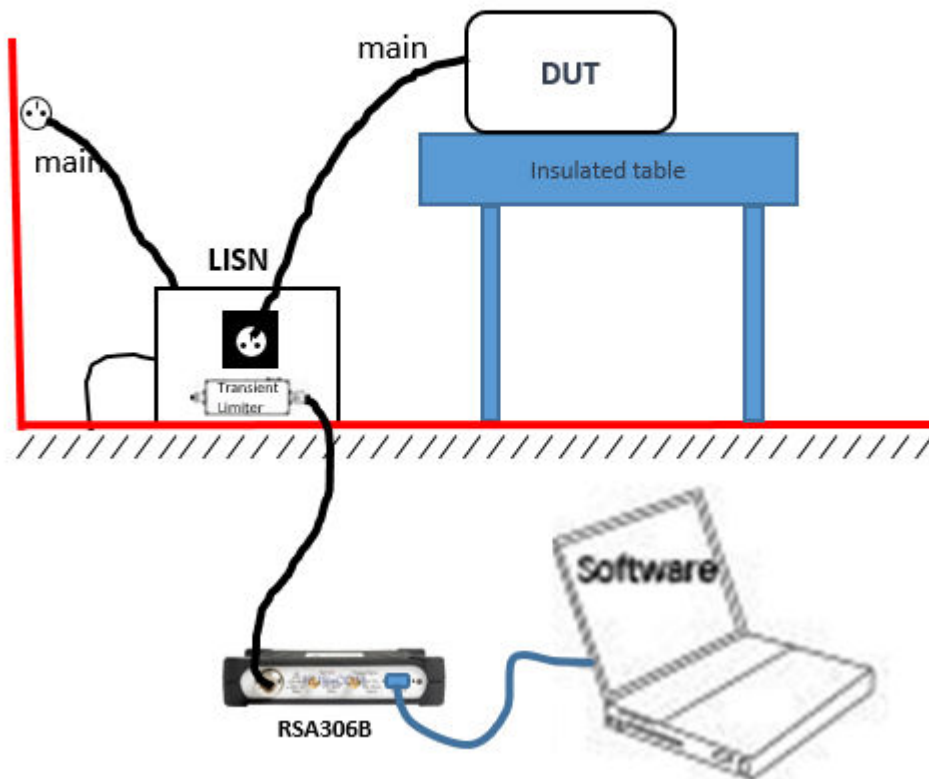

LISN is one of the key accessories required for doing a conducted test.



EMI-LISN50UH (TBLC08 Line Impedance Stabilization Network)

The following models are available:

- EMI-LISN50UH-US: This model supports DUT devices with US main power.
- EMI-LISN50UH-GB: This model supports DUT devices with GB main power.
- EMI-LISN50UH-EU: This model supports DUT devices with EU main power.

The 50 μ h AC line Tekbox TBLC08 is a Line Impedance Stabilization Network (LISN) for the measurement of line-conducted interference within the range of 9 kHz to 30 MHz, as per the CISPR16 standard. The device is designed for testing single phase, AC-powered equipment with supply voltages up to maximum 260 V. Conducted noise can be measured on the phase and on the neutral conductor. The TBLC08 is equipped with a switchable limiter/attenuator.



The LISN provides for stabilization and lets you measure what amount of energy is fed back to the power line. The LISN is powered and the front-end power socket lets you power your equipment under test (EUT). The emissions that is fed back to the power line is available at RF out for a receiver or spectrum analyzer to measure.

The LISN is connected to the AC power supply and provides power to the EUT. The spectrum analyzer is connected to the RF out of the LISN. TBLC08 has an built-in limiter that can be switched ON to avoid transients. The emission that is usually fed back to the power line is made available at RF OUT by the stabilization network.



Tip: See the [Conducted tests introduction](#) topic for more information and to view a connections diagram.

CABLE (coaxial Type N to Type N)

The following cables for EMI testing are available from Tektronix:

- CABLE-1M: 1 meter RF coaxial Type N to Type N cable
- CABLE-3M: 3 meter RF coaxial Type N to Type N cable
- CABLE-5M: 5 meter RF coaxial Type N to Type N cable

EMI-LISN5UH (TBOH01 Line Impedance Stabilization Network)

The 5 μ H DC line Tekbox TBOH01 is a Line Impedance Stabilization Network (LISN) for the measurement of line-conducted interference within the range of 150 kHz to 110 MHz. It is inserted into the supply line of the DUT.



Tip: See the [Conducted tests introduction](#) on page 409 topic for more information and to view a connections diagram.

EMI-TRANS-LIMIT (LIT-153A transient limiter)

The Com-Power LIT-153A is a transient limiter that protects the EMI receiver input via the LISN from any short transients (a few microseconds or less) on the power supply lines.



 **Tip:** See the [Conducted tests introduction](#) on page 409 topic for more information and to view a connections diagram.

EMI-NF-AMP (TBWA2 amplifier)

The TekBox TBWA2 is a 20 dB or 40 dB wideband amplifier for use with the TBPS01 probes.



 **Tip:** See the [EMI-NF-PROBE](#) accessory topic.

See the [Radiated tests introduction](#) topic for more information and to view a connections diagram.

EMI-NF-PROBE (TBPS01 near field probe set)

The TekBox TBPS01 is a near field probe set.



Tip: See the [EMI-NF-AMP](#) accessory topic.

See the [Radiated tests introduction](#) on page 398 topic for more information and to view a connections diagram.

Accounting for accessories contributions in EMCVu software

Each accessory has its own Gain/Loss (antenna factor in the case of antennas) that must be accounted for to get an accurate emission measurement. The measured reading must be corrected for the Gain/Loss/ Factor contribution due to the accessories.

The EMCVu software allows you to correct for the accessory contributions. You can either use the Setup Wizard – Accessories tab or the Accessories tab in the Settings control panel to account for these contributions. You can view the Combined Impact of all the accessories in a graph, too.

The typical values of Gains/Losses/Factors of each of the Tektronix provided accessories is available for you to easy load. You can either use the “Load Tektronix provided Accessories Gains/Losses” from the Setup Wizard or you can load individual accessory files using “Configure Accessories > Edit > Load”. The individual .csv files are available in *C:\SignalVu-PC Files\EMC Accessories*.



Tip: See the [How to perform an EMC pre-compliance test](#) on page 418 topic for more information of how you can perform an emission measurement. See the [Combined impact of gains/losses](#) on page 460 to read more about contributions.

EMC Analysis

Introduction to EMC Analysis

The Electro Magnetic Compatibility (EMC) Analysis option (Option EMCVUNL-SVPC and EMCVUFL-SVPC) allows you to perform pre-compliance emissions tests for your devices and troubleshoot emission issues. A separate EMCVu icon is loaded to your Desktop for quick access to the EMC displays, setups, and standards. These same displays, setups, and standards can also be accessed from the SignalVu-PC application.

EMC is a measure of the capability of a device to operate as expected in its operating environment. A device should not affect the capability of other equipment in a certain proximity to operate as expected. EMI can be defined as electromagnetic energy that affects the functioning of an electronic device. Sources of EMI are predominantly from electronic devices or electrical systems. While EMI can be generated from any electronic device, certain equipment and components, such as cell phones, welders, motors, and LED screens, are more likely to create disturbances than others. Measuring the amount of EMI generated by the internal systems of devices is a process known as emissions testing. The RF range is generally split into a Conducted range and a Radiated range.

Several consequences, including safety risks and product failures, can result if you fail to properly anticipate the EMC of a device. Tektronix's EMC solution helps you find the emission problems in your device and troubleshoot them.

EMC standards

The EMC standards bring a common approach to every member state to EMC/EMI testing. It is important to purchase the standards document to do these tests because it lays out a clear procedure for test setup and methodologies. The CISPR standards usually define test procedures for commercial products.

The various standards set down limits for conducted and radiated EMI emissions. Typically, limit lines are defined separately for residential areas and industrial areas. These two areas are represented by two classes of limits: class A represents the industrial environment; class B defines the limits for residential areas.

The following are standards for which limit lines can be easily loaded in this application. Complete information about setup and testing can be found in the standard document.

Available standards under Europe are:

- EN55011: Industrial, scientific and medical (ISM) equipment containing a radio-frequency generator
- EN55012: Vehicles, motor boats and internal combustion engines - protection of off-board receivers
- EN55013: Sound / television broadcast receivers and associated equipment
- EN55014: Household appliances, portable electrical tools and similar apparatus, parts
- EN55015: Electrical lighting and similar equipment, for example fluorescent lamps
- EN55025: Vehicles, motor boats and internal combustion engines- protection of on-board receivers
- EN55032: Multimedia equipment (replaces CISPR 13 and CISPR 22 from 2017)
- EN60601: Medical Electrical equipment
- DEF STAN: Defense Standard for equipment and sub systems

Available standards under US are:

- FCC Part 15
- FCC Part 18
- MIL-STD 4161G



Note: The MDO4000B/C Series instruments do not support CISPR detectors. Dwell Time limitations are instrument dependent.

Key features

EMC testing with Tektronix provides you the following suite of pre-compliance and troubleshooting tools and displays to help you debug problems faster.

Pre-compliance on page 418

- *EMC Project Setup Wizard* on page 422: Use the EMC Project Setup Wizard to include contributions due to accessories, load ranges and limits based on standards recommendations, choose between measurement types, and include information for reports.
- *Measure ambient* on page 433: Measure emission not contributed by the Equipment under Test (EUT) and compare it with results obtained when the EUT is turned on.
- *Re-measure spot* on page 434: Identify emission results from a scan and re-measure on the selected spot (frequencies that have failed Threshold/Limit lines) with detectors recommended by the standard or detectors defined by you.
- *Reports* on page 432: Include measurement results and settings in a report. Include multiple measurement results in a report.

Troubleshooting

- *Harmonic Markers* on page 440: Allows you to place markers at selected harmonic factors of a known fundamental frequency to find if the emissions are caused by known design issues.
- *Inspect Suspect Frequencies*: Inspect a set of suspect frequencies in discrete mode or a set of harmonics of as many as 3 fundamental frequencies. You can use this tool with a near field probe set to see from where the suspect emission frequencies come.
- *Level Target* on page 443: Place a level target in the display and compare scans against the target visually.
- *Compare Traces* on page 444: Compare different scan traces, save traces, recall traces, and compare against limit lines. Compare Ambient traces and use the Math function (the difference of two traces) to create a Math trace.
- *Persistence Display* on page 446: Troubleshoot intermittently occurring emissions using the persistence tool with the DPX display.

Displays

- *EMC-EMI*
- *DPX*
- *Spectrogram*
- *Spectrum Display* on page 109

How to open EMCVu

You can start the EMC Analysis tool one of the following ways:



1. Double click  on the Desktop. This EMCVu icon will open the SignalVu-PC application defaulted to the EMC Analysis display with the Setup Wizard open.



Tip: EMCVu is best viewed in 1920x1080 or 1920x1200 resolution.



2. Double click **SignalVu-PC** on the Desktop. This SignalVu-PC icon will open the SignalVu-PC application.
 - a. Select **Setup** from the Main menu bar and select EMC. This allows you to access various EMC functions. To get started with an EMC pre-compliance test, select **Setup Wizard**. You can read more about the EMC Project Setup Wizard [here](#).

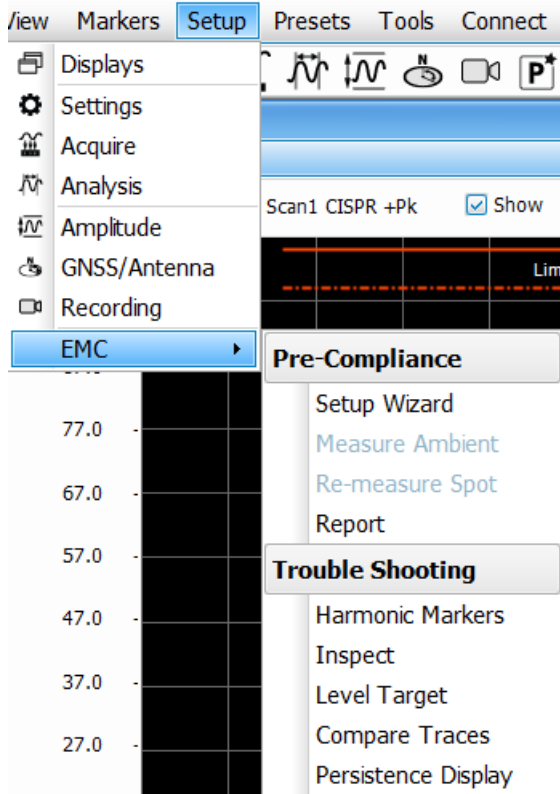

- b. Click the icon  on the *Favorites bar* and check the box next to EMC. This will place the EMC menu options on the Favorites bar for quick access.

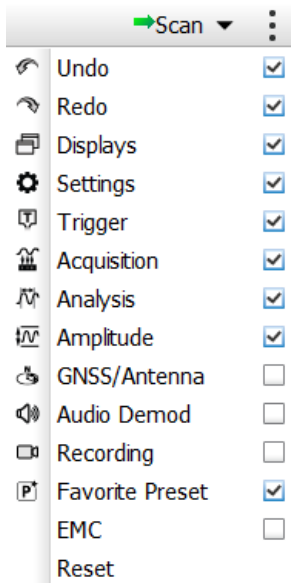

Elements of the EMC Analysis window

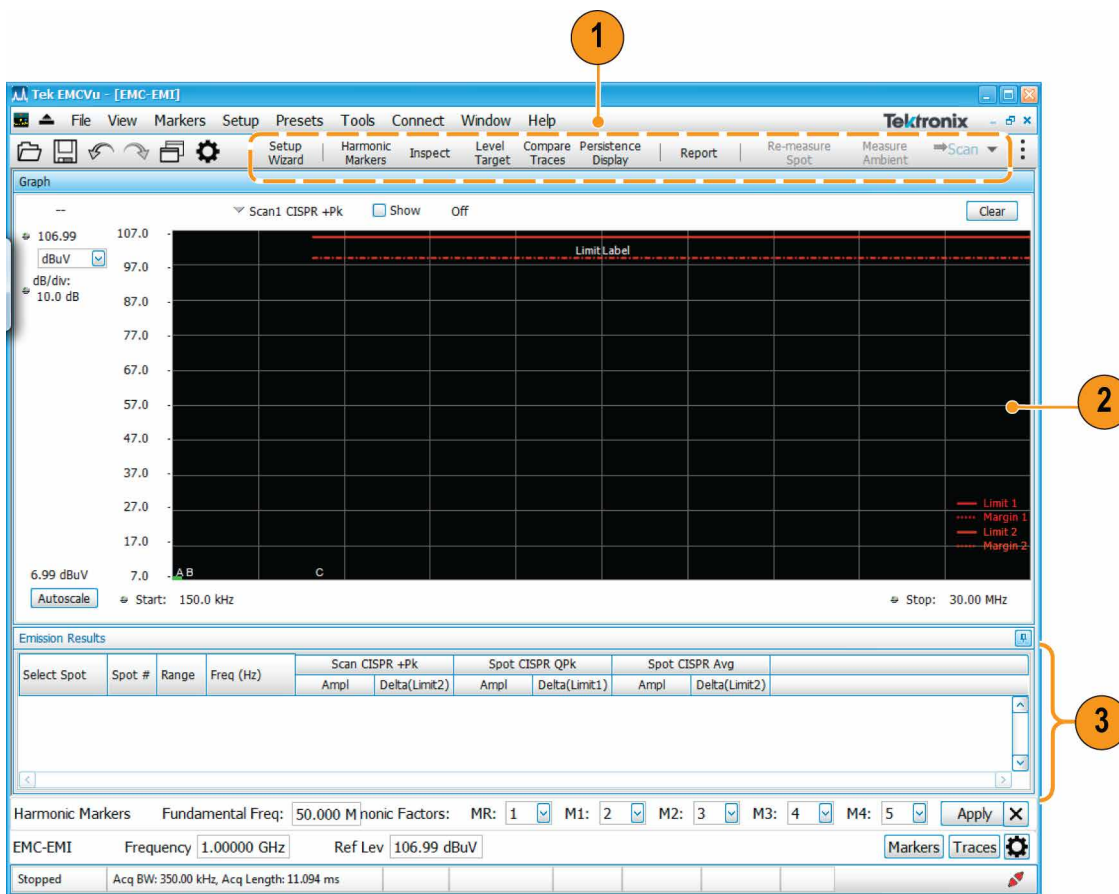

0720-016

Element	Description
1	These menu items on the Favorites bar are EMC Analysis specific. You can add or remove these items from the Favorites bar by clicking the  icon (located at the far right end of the bar) and then checking or unchecking the box next to EMC .
2	The graph of the currently selected display appears here.
3	Emissions results will appear here.

Pre-compliance

The Tektronix EMC analysis option allows you to perform pre-compliance testing of your equipment to detect possible emissions at an early stage, reducing the chances of failure at the test house. The EMC software can be accessed through the analyzer application interface or through the EMCVu icon on your Desktop. This analysis option provides the following four key features to perform pre-compliance testing.

1. [Quick start](#) guide on how to perform a pre-compliance test.
2. [Setup Wizard](#)
 - [Accessories tab](#)
 - [Ranges & Limits tab](#)
3. [Measure ambient](#) on page 433
4. [Re-measure spot](#) on page 434
5. [Reports](#) on page 432

CISPR (International Special Committee on Radio Interference) detectors are needed when performing EMC testing of electronic devices. Specifically, levels of EMI need to be under a reference while being measured with a specified CISPR detector. These detectors are defined in Publication 16 of CISPR. Option SVQPNL-PC and SVPQFL-PC adds these CISPR detectors and filters so you can perform the required EMI measurements needed for your DUT (Device Under Test). These detectors can be invoked in the Spectrum display or in the EMC-EMI display. Note that these detectors process the signal over a long period of time (2 seconds), so it is expected that the user interface may seem less responsive during that time.



Tip: Click here to see [How to open EMCVu](#) on page 415 (EMC Analysis).



Tip: The EMC Project Setup Wizard contains a subset of available EMC settings. See the [EMC-EMI settings](#) on page 452 topic for information about those additional settings.

How to perform an EMC pre-compliance test



1. Double click  on the Desktop. This EMCVu icon will open the analyzer application defaulted to the EMC Analysis view with the Setup Wizard open on the Getting Started tab.

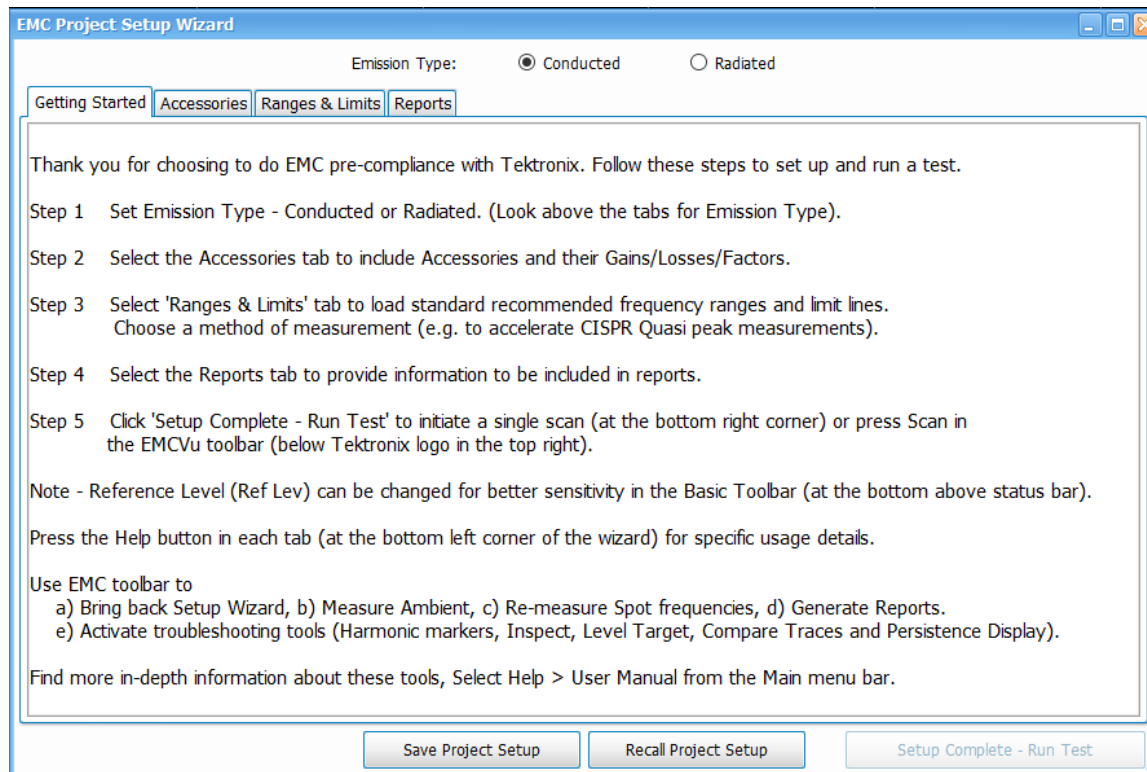

- Select **Conducted** or **Radiated** as the Emission Type. This selection is located at the top of the Setup Wizard window.
- Select the Accessories tab.

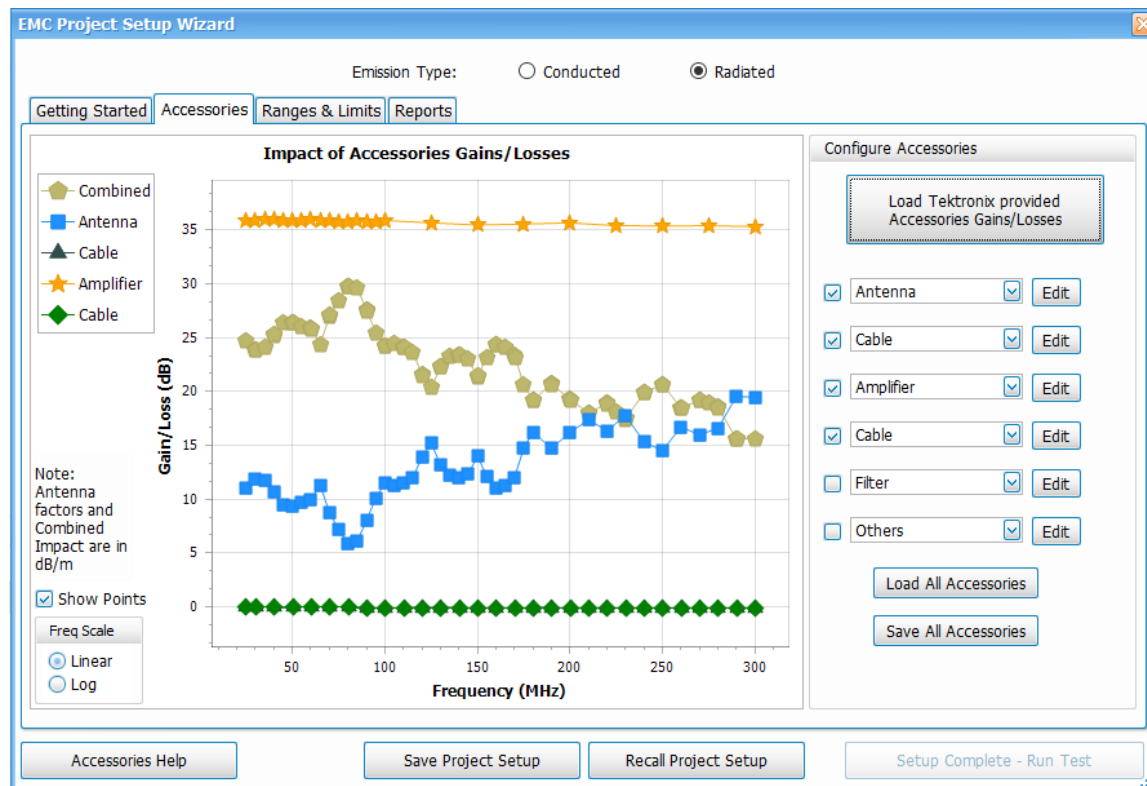

- Click the **Load Tektronix Provided Accessories Gains/Losses** button.

5. If you selected **Conducted** emissions, a window will appear prompting you to turn on the limiter in LISN. When you have done this, click **OK** to continue.



LISN and cable will be loaded for the conducted pre-compliance setup. If you need to add other accessories, do so now. View the [Add/edit individual accessories](#) or [Load accessories from a saved file](#) on page 427 topics for detailed instructions.

6. If you selected **Radiated** emissions, a window will appear prompting you to select the frequency range of the antenna. When you have done this, click **OK** to continue.

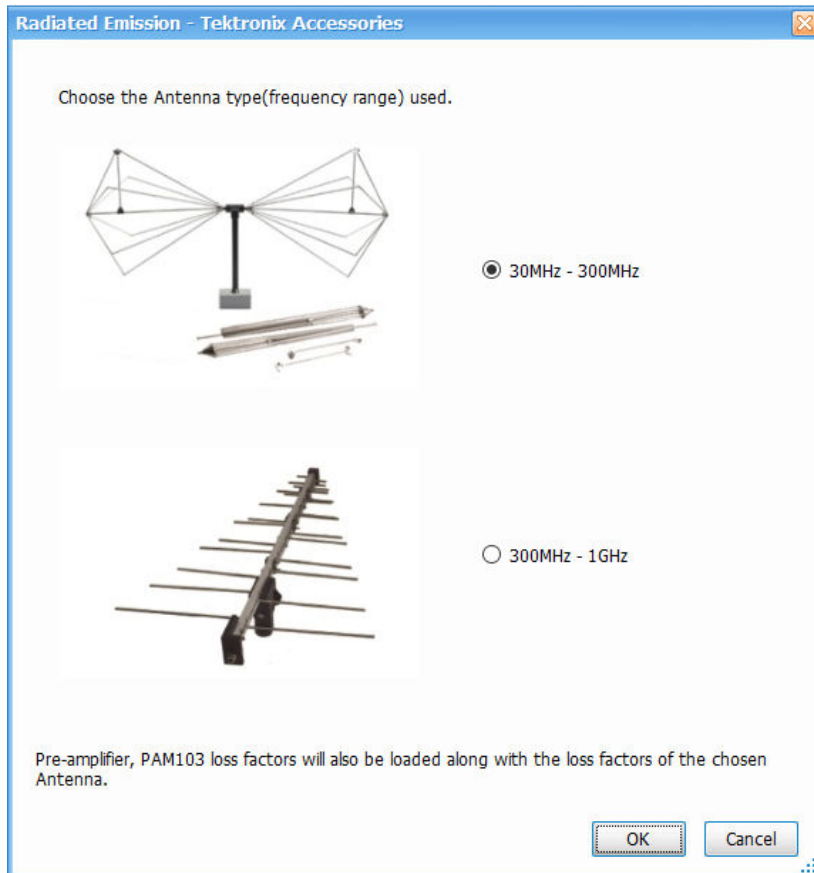

Antenna, Cable, Pre-Amplifier, and Cable will be loaded for the radiated pre-compliance setup. If you need to add other accessories, do so now. View the [Add and/or edit individual accessories](#) on page 425 or [Load accessories from a saved file](#) on page 427 topics for detailed instructions.

7. Select the **Ranges & Limits** tab. View the [Load from Standard](#) on page 428 and [Choose a measurement method](#) on page 429 topics to read about how to use this tab.
8. Select the **Reports** tab and select the information to be contained in the report. View the [Reports](#) on page 432 topic for details about how to do this.
9. Click the **Setup Complete– Run Test** button to initiate a single scan.
10. If desired, you can change the Reference Level for better sensitivity. In general, you can set the reference level based on the largest signal of interest.

For example, for a 50 dBuV reference level, the maximum emission level that can be measured is 55 dBuV (5 dB over-scale). If the signal of interest is lower, then the reference level can be adjusted accordingly. Emission levels that are approximately 10 dB higher than the noise level can be measured accurately.

The noise level can be easily measured by terminating the input to the LISN/Antenna or removing the EUT and other sources of EMI from the test setup. The noise floor has to be measured with the same RBW that is used to measure emission level (recommended by the standard). For example, if the noise floor is measured at -5 dBuV for 120 kHz RBW, then emission levels at 5 dBuV or higher can be accurately measured.



Tip: Read about troubleshooting tools and displays in the [Troubleshooting](#) topic.



Tip: To access more [EMC settings](#), click the  icon or select **Setup > Settings** from the Main menu bar when the [EMC-EMI display](#) on page 447 is selected.



Tip: The EMC Project Setup Wizard contains a subset of available EMC settings. See the [EMC-EMI settings](#) on page 452 topic for information about those additional settings.

EMC Project Setup Wizard

The EMC Project Setup Wizard opens on the Getting Started tab. The content on the Getting Started tab leads you through a series of well-defined steps to set up and perform an EMC pre-compliance test. The other tabs, buttons, and settings of the Setup Wizard allow you to select accessories, set ranges and limits, create reports, and perform other tasks, as shown in the following table.

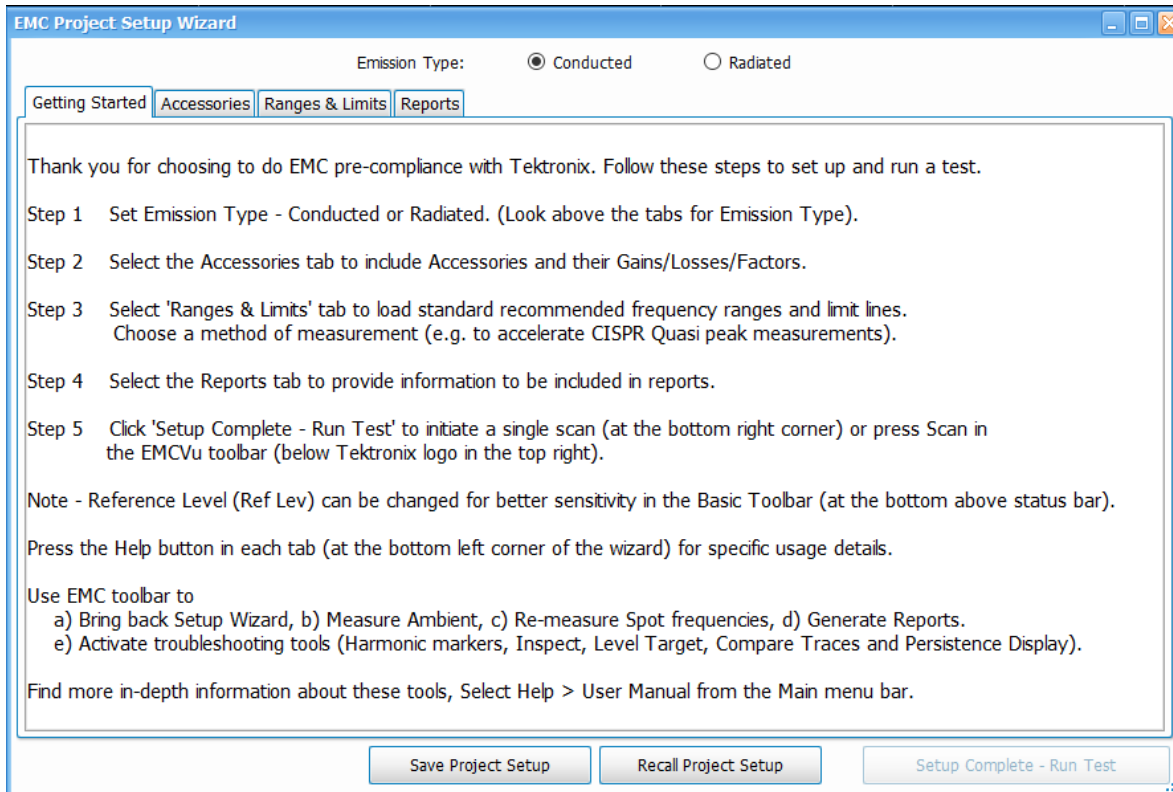

Tip: EMCVu is best viewed in 1920x1080 or 1920x1200 resolution.



Tip: The EMC Project Setup Wizard contains a subset of available EMC settings. See the [EMC-EMI display settings](#) topic for information about those additional settings.

Setting/Tab	Description
Emission Type	Allows you to select the emission type: Conducted or Radiated.
Getting Started	Guides you through a pre-compliance test.
Accessories	Allows you to specify accessory related settings.
Ranges and Limits tab on page 427	Allows you to specify range and limit related settings for comparison, choose measurement modes, and load standard recommended values.

Table continued...

Setting/Tab	Description
Reports on page 432	Allows you to specify the details to be included in the test report.
Help	All of the Setup Wizard tabs, except Getting Started, have a Help button. Clicking this button opens a Help file with information related to the currently active tab. For more in-depth information about the EMC Analysis displays, settings, and functionality, select Help > User Manual from the Main menu bar in the analyzer application.
Setup Complete — Run Test	Allows you to begin a scan, initiating the test run.
Save Project Setup	Allows you to save all of the Setup Wizard settings as an EMC project setup file.
Recall Project Setup	Allows you to recall a saved EMC project setup.



Tip: The Setup Wizard will open every time the EMC-EMI display is launched. This behavior can be suppressed from the Prefs tab in the EMC Settings control panel by disabling **Show Setup Wizard on EMC-EMI display startup**.

Accessories tab

This tab in the EMC Project Setup Wizard lists, and allows you to set up, the accessories required for the test. You can also view a graph showing the combined impact of accessories gains and losses. The final measurement reading is corrected based on these accessory contributions before it is shown in the display. The correction is calculated by negating the combined impact of all of the accessory gains/losses you entered.

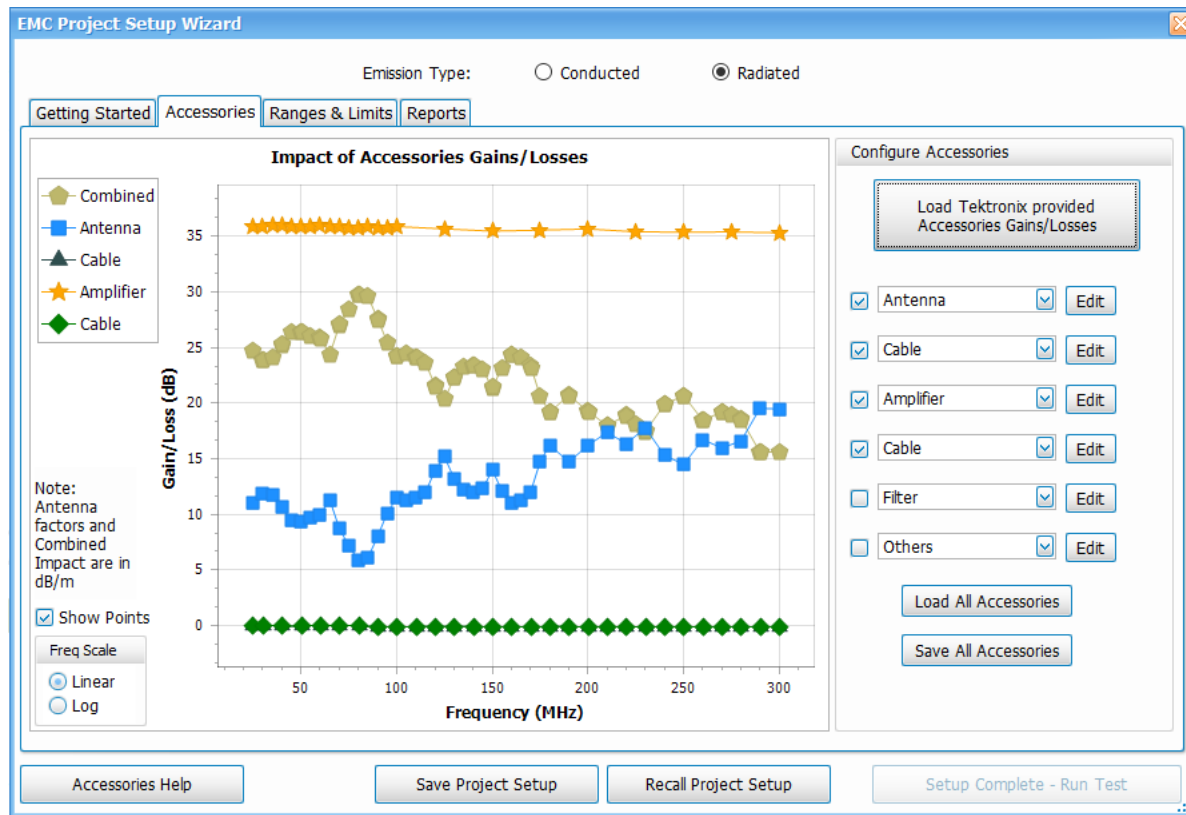



Tip: The EMC Project Setup Wizard contains a subset of available EMC settings. See the [EMC-EMI settings](#) on page 452 topic for information about those additional settings.



Tip: Read more about the plot on this tab in the [Combined impact of gains/losses \(view in plot\)](#) topic.

You can load accessories one of the following ways:

- Use the [Load Tektronix provided Accessories Gains/Losses](#) button.
- Manually [Add and/or edit individual accessory details](#).
- Use the [Load All Accessories](#) button.

More topics about setting up accessories and related information:

- [Accessories setup](#)
- [Combined impact of gains/losses](#) on page 460
- [Calculation of combined impact of accessories gains/losses](#) on page 462
- [Edit accessory contributions](#)
- [External correction in DPX](#)
- [Loading accessories from a file](#)
- [Available accessories in the drop-down lists](#)
- [Two types of mismatch issues when recalling the csv file](#)
- [Changing accessory details](#)

Load Tektronix provided accessories gains/losses

1. Select either **Conducted** or **Radiated** as the Emission Type (top of window, above the tab headings).
2. Click the **Load Tektronix Provided Accessories Gains/Losses** button.

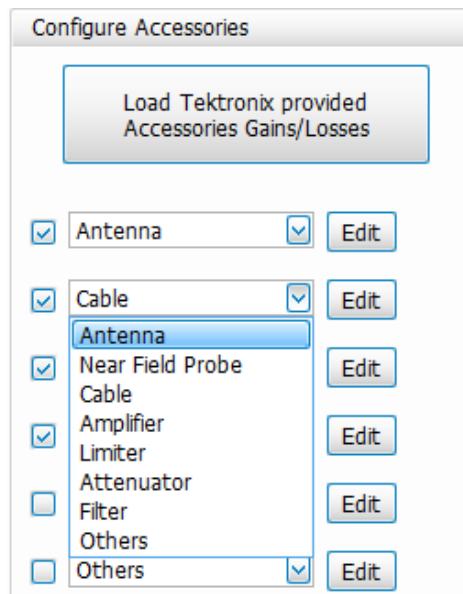

3. For Conducted emissions:

You will be prompted to turn on the limiter in LISN. The default contributions loaded for the conducted pre-compliance setup are LISN and cable. However, you can add any other accessories as needed.

4. For Radiated emissions:

The default contributions loaded for the radiated pre-compliance setup are Antenna, Cable, Pre-Amplifier, and Cable. However, you can add any other accessories as needed.

You will also be prompted to choose the antenna that is being used for the test. The biconical antenna is used for tests between 30 MHz and 300 MHz. The log periodic antenna is used for tests between 300 MHz and 1 GHz. Depending on the range of the test, you can make the choice and the contribution due to those set of accessories will be loaded.

The parameters loaded for Cable are those of the **CABLE-1M** (1 meter) cable. If you are using a 3 m or 5 m cable, please load the appropriate file from the `C:\SignalVu-PC Files\EMC Accessories` folder.

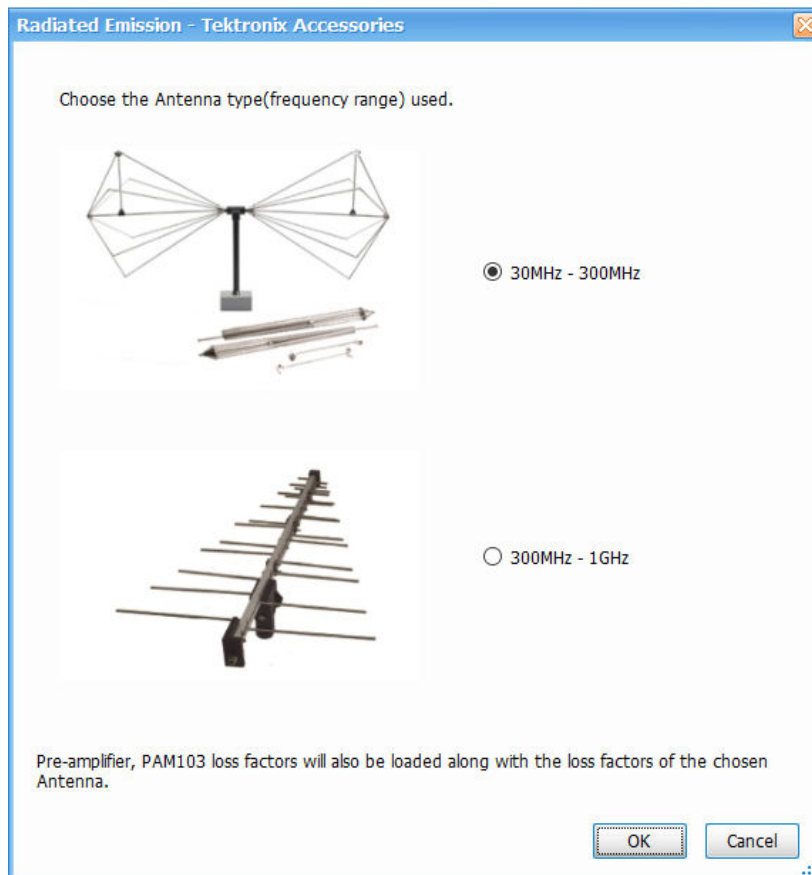

Tip: Read more about editing accessories in the [Accessories tab](#) and [Accessories setup](#) topics.

Add and/or edit individual accessories

1. To add an accessory, click on the arrow next to an accessory field and select from the drop down list. The list is dependent on the selected emission type (Conducted or Radiated).

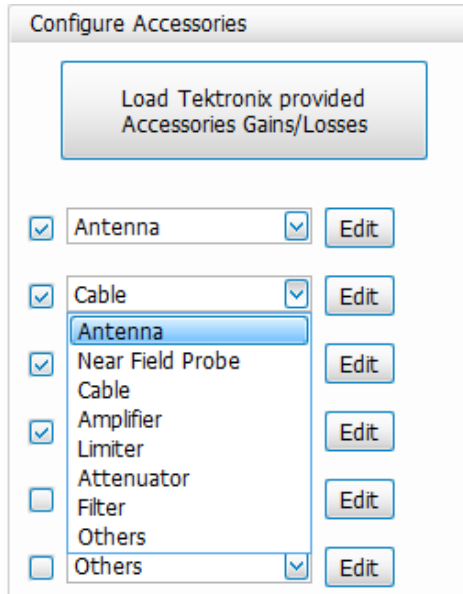

- To edit the details of an accessory, click the **Edit** button next the accessory you want to edit. A window will appear containing the parameters of the accessory.

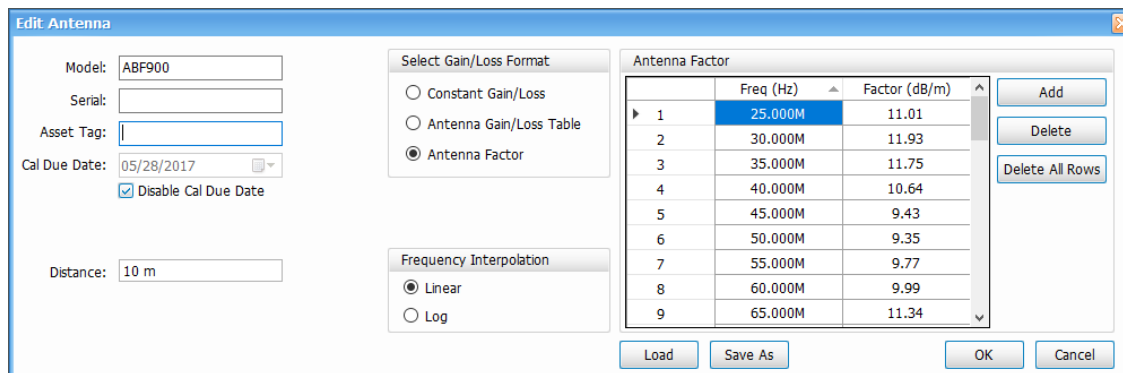

- Edit the desired parameters. You can edit the following:
 - Model number
 - Serial number
 - Asset tag
 - Calibration due date
 - Distance (for Antenna)
 - Gain/Loss format
 - Constant gain/loss³
 - Antenna gain/loss table³
 - Antenna factor
 - Frequency interpolation (Linear or Log)
- Click the **OK** button to close the edit window and go to another accessory.
- Edit any other accessories, if needed.

³ Values are entered in dB with gain represented as positive values and loss as negative. For antennas, either isotropic gain information is entered in dBi or antenna factors in dB/m.

6. Click the **Save All Accessories** button to save the updated details of all edited accessories to a file.
7. Click the **Load All Accessories** button to load the updated accessories to the current setup.



Tip: Read more about editing accessories in the [Accessories tab](#) and [Accessories setup](#) on page 455 topics.

Load accessories from a saved file

1. Click the **Load All Accessories** button to load accessories from a saved setup file.



Note: The parameters loaded for Cable are those of the [CABLE-1M](#) (1 meter) cable. If you are using a 3 m or 5 m cable, please load the appropriate file from the C:\SignalVu-PC Files\EMC Accessories folder.



Tip: Read about the combined impact of accessories and accessories setup information in the [Accessories setup](#) on page 455 topic.

Ranges and Limits tab

The Ranges and Limits tab of the EMC Project Setup Wizard allows you to specify the parameters that control the EMC-EMI measurement. You can:

- [Load from Standard](#)
- [View Ranges and Limits plot and edit label](#)
- [Edit Ranges and Limits](#) on page 428
- [Choose a measurement method](#) on page 429
- [Edit Scan and Spot Setup](#) on page 431



Tip: The EMC Project Setup Wizard contains a subset of available EMC settings. See the [EMC-EMI settings](#) on page 452 topic for information about those additional settings.

Load from Standard

Click the **Load from Standard** button on the Ranges and Limits tab in the EMC Project Setup Wizard to load from a standard based on the region selected. The following window will appear from which you can make selections.

- This window allows you to choose the region for which your product is intended and then a standard from a list of standards in that region. You will need a copy of the standard document (the version number of the standard is mentioned as you make a choice of the standard from the drop down).
- The various frequency ranges / limit line tables provided from the standard will be listed in a drop down for selection.
- Once the appropriate standard is loaded, you will see the ranges and limits recommended by the standard in a plot. The detector choice recommended by the standard is also shown in the Scan Definition and Spot Setup below the plot. The limit line against which the detector results will be compared is also shown as a mapping against each detector choice.
- A margin also can be set (shown by the dotted line) and this is applicable to all limit lines. The Margin setting is located to the left of the plot.
- Some tables in standards recommend separate limit lines for each detector choice and all of them will be loaded.

View Ranges and Limits plot and edit label

- The Ranges and Limits loaded from standard can be seen in the plot in the Ranges & Limits tab of the EMC Project Setup Wizard.
- When loaded from standard, the limit label is set appropriately based on the standard and limit table choice. However, this can be edited by clicking  (Edit Label button).
- The Limits are shown in different colors when more than one limit line is selected. This is indicated in the Limit legends.
- Margin for every limit line is shown in dotted form for every limit in the respective color.
- Frequency scale can be viewed in Linear or Log.

Edit Ranges and Limits

Ranges and limits can be customized from the Ranges & Limits tab of the EMC Project Setup Wizard. If you want to customize the limit lines loaded from a standard or you want to create your own limit lines, do as follows.

1. Click the **Edit Ranges and Limits** button to left of the plot. The following expanded table will appear.

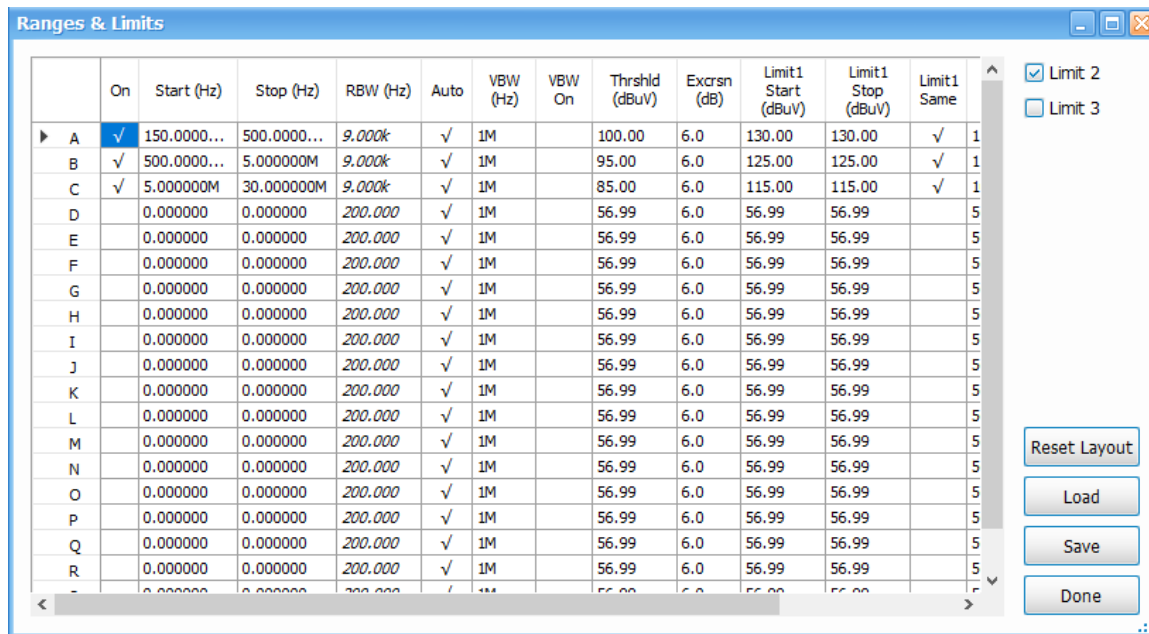

2. Edit the start and stop frequencies, RBW and VBW settings, and limit values.

As many as 3 limit lines can be included. The limit lines will be shown with individual color codes and the corresponding margin lines shown in same color but in dotted form. The margin control is only one control applied in common to all limit lines.

3. Check to see that the customized limit lines appear in the plot.
4. Save frequency ranges and limit lines by clicking the **Save** button. You can also load from these saved files later.

Choose a measurement method

Once the desired ranges and limits are loaded, you can decide to do the measurement in one of the following three measurement methods, which are available for most standards.

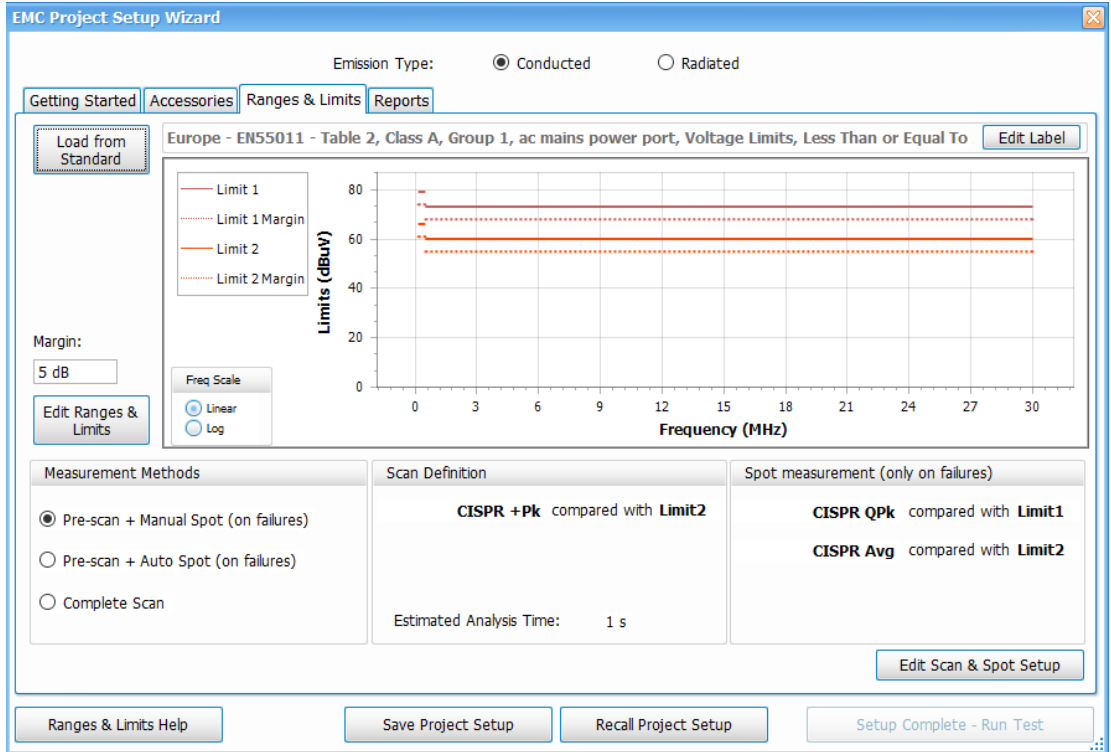

- **Pre-scan + Manual Spot:** A quick pre-scan followed by choosing spots from results table and re-measuring them with detectors recommended by the standard (or that of your choice).
- **Pre-scan + Auto Spot:** A pre-scan followed by an Automated re-measurement for a chosen number of spots.
- **Complete Scan:** A complete scan with detectors recommended by the standard - could be time consuming if detectors such as CISPR Quasi Peak or CISPR Avg are chosen.

 **Tip:** You can read more about measurement methods and how they can be set from the Ranges & Limits tab in the EMC Settings control panel in the [Measurements](#) on page 469 topic.

The mapping of limit lines to the detectors is also shown under Scan Definition and Spot measurement. This tells you which detector will be used for Scan and Spot measurements and which limit line will the Scan or Spot results be compared against.

The Estimated Analysis Time is shown to give an idea of how much time the Scan is expected to take for the detectors chosen. This Estimated time is based out of the choice of detectors and the span of the actual scan measurement and is calculated under ideal conditions for a machine with 16 GB RAM. Actual time taken for measurement could vary.

This estimated analysis time could be higher if detectors such as CISPR Quasi Peak are used for a larger span range.

The following three images show how the Scan Definition and Spot Measurement information may vary depending on the selected measurement method.

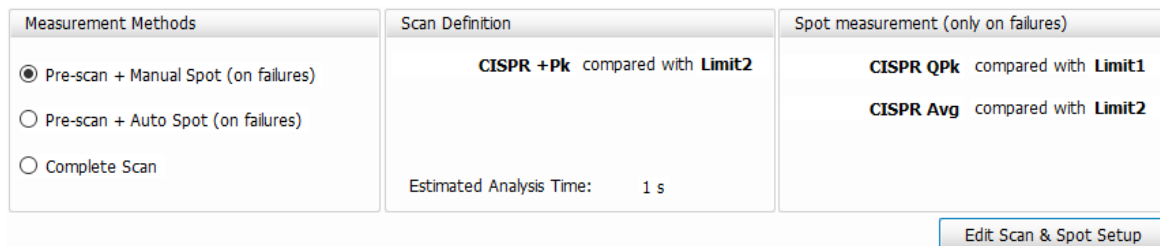

Measurement Methods <input type="radio"/> Pre-scan + Manual Spot (on failures) <input checked="" type="radio"/> Pre-scan + Auto Spot (on failures) <input type="radio"/> Complete Scan	Scan Definition <p style="text-align: center;">CISPR +Pk compared with Limit2</p> <p>Estimated Analysis Time: 1 s</p>	Spot measurement (only on failures) <p style="text-align: center;">CISPR QPk compared with Limit1</p> <p style="text-align: center;">CISPR Avg compared with Limit2</p> <p>Max Spots: <input type="text" value="2"/> <input type="checkbox"/> All</p>
--	---	---

[Edit Scan & Spot Setup](#)

Measurement Methods <input type="radio"/> Pre-scan + Manual Spot (on failures) <input type="radio"/> Pre-scan + Auto Spot (on failures) <input checked="" type="radio"/> Complete Scan	Scan Definition <p style="text-align: center;">CISPR QPk compared with Limit1</p> <p>Estimated Analysis Time: 1011 s</p>
--	--

[Edit Scan & Spot Setup](#)

The three measurement methods might not be shown for some standards if they do not recommend detectors such as CISPR Quasi Peak (for example, Mil/Gov 461G and DEF STAN). This is because the scan itself is done with CISPR Peak detector which can be done faster and there is no need for a Pre-scan followed by spot measurements in such a case.

EMC Project Setup Wizard

Emission Type: Conducted Radiated

Getting Started Accessories **Ranges & Limits** Reports

Load from Standard

US - MIL-STD 461G - CE101-1, Submarine, DC, Greater Than or Equal to 185 A (dBuA) [Edit Label](#)

Limit 1
Limit 1 Margin

Margin: 5 dB

Edit Ranges & Limits

Freq Scale
 Linear Log

Limits (dBuA)

Frequency (MHz)

Scan Definition

MIL +Peak compared with **Limit1**

Estimated Analysis Time: 1 s

[Edit Scan & Spot Setup](#)

[Ranges & Limits Help](#) [Save Project Setup](#) [Recall Project Setup](#) [Setup Complete - Run Test](#)

Edit Scan and Spot Setup

Edit Scan and Spot Setup allows you to modify any detector choice or dwell time. You can also do the limit mapping appropriately.

- Choose the appropriate detector for scan and spot re-measurement
- Set dwell time

- Choose the limit line mapping

By default, the standard recommended limit line is mapped to appropriate detectors.

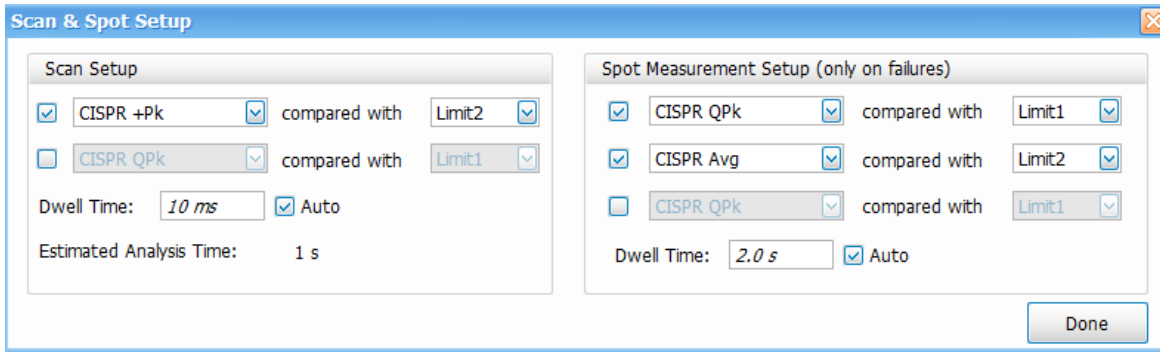

 **Tip:** You can read more about scan and spot setup in the [Edit Scan and Spot Setup](#) on page 431 topic.

Reports

The Reports tab in the EMC Project Setup Wizard allows you to select the information you want to include in a report.

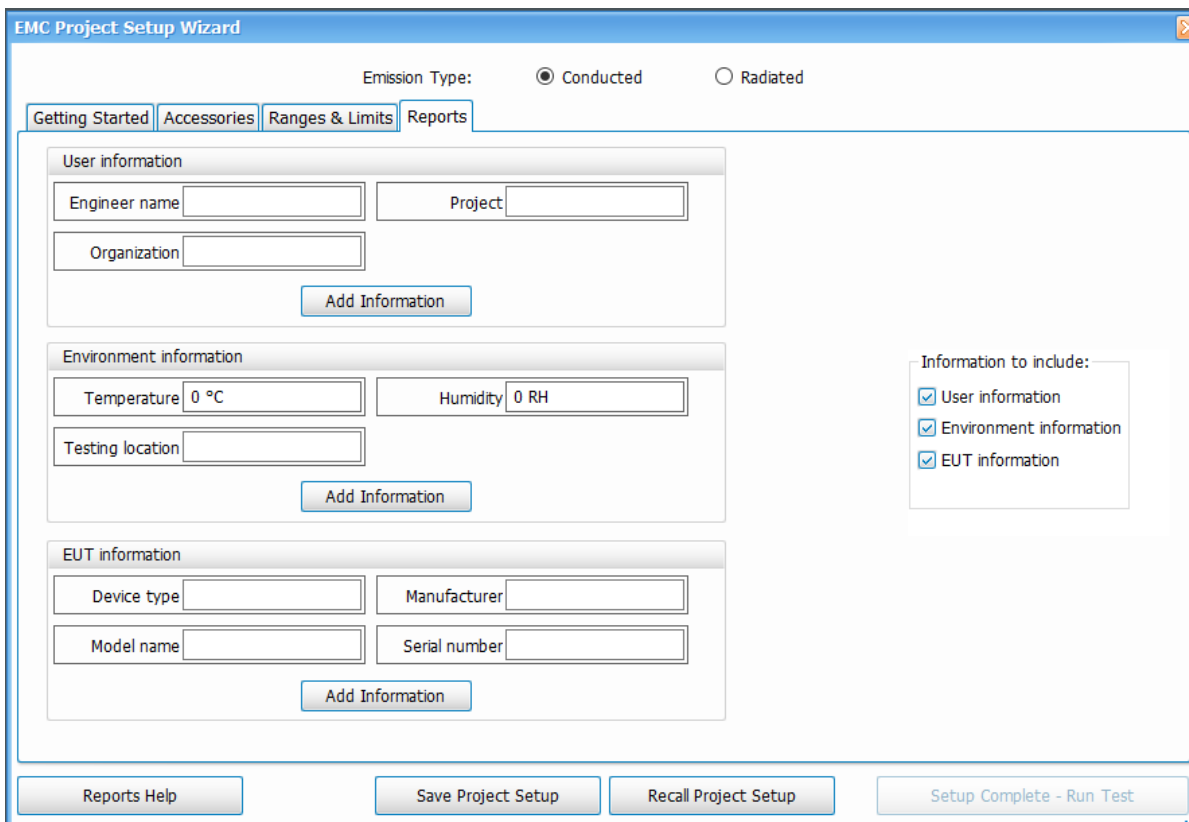

Item	Description
User information	Includes user information in the report: Engineer name, Project name, and Organization name. Empty fields will not be included in the report. If you do not want to include a default field, you can leave it empty.
Environment information	Includes environment information in the report: Temperature, Humidity, and Testing location. Empty fields will not be included in the report. If you do not want to include a default field, you can leave it empty.
EUT information	Includes equipment under test (EUT) information in the report: Device type, Model Name, Manufacturer name, and Serial number. Empty fields will not be included in the report. If you do not want to include a default field, you can leave it empty.
Add Information	New information details can be added to any of the three information areas by clicking an Add Information button in the associated area. You can then providing details such as title and value of the new item in the Add Information window.
Information to include	Select which information areas to include in a report from this list. Check a box to include the associated information. Uncheck a box to leave out the associated information.

1. Check the boxes in the **Information to include:** area of the Reports tab that are next to the information you want included in the report.
2. Edit the information fields in the User, Environment, and EUT (equipment under test) areas, as needed.
3. If needed, click the **Add Information** button in the desired information area to add an additional field to the selected information area.



Tip: Read the [Generating and saving reports](#) on page 435 topic for detailed information about saving, generating, viewing, and exporting reports.



Tip: The Setup Wizard will open every time the EMC-EMI display is launched. This behavior can be suppressed from the [Prefs tab](#) in the EMC Settings control panel by disabling **Show Setup Wizard on EMC-EMI display startup**.

Measure ambient

An Ambient scan analysis can be done to quickly check if the Spots (emission at specific frequencies) obtained are due to ambient emissions or the actual equipment. Perform this ambient scan analysis procedure to quickly check if the listed Spots are due to ambient interference or the equipment.

1. Select **Setup > EMC > Measure Ambient** or click **Measure Ambient** from the EMC related items on the [Favorites toolbar](#). Alternatively, you can recall a trace saved from the Ambient tab in the EMC Settings control panel.

- Follow the prompt that appears and turn off the Equipment under Test (EUT) or completely remove it from the setup.

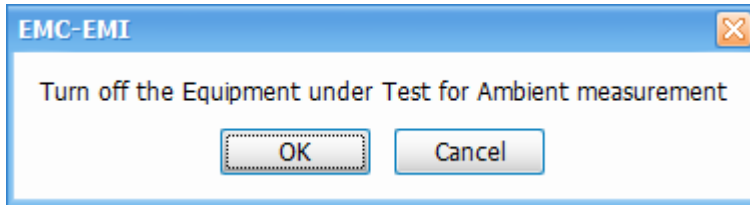

- Click the Ambient tab in the EMC Settings control panel and set Detector, Dwell Time, and Delta Threshold appropriately.
- Return the EUT to the setup, if removed, and turn it on.
- Perform a scan with the same detector set in the Measurement Type tab.
- View the Ambient trace in the graph.



Tip: Read about comparing ambient scan results in the [Comparing ambient scan results](#) on page 434 topic.



Tip: See the [Ambient tab](#) topic for more information about ambient settings.

Comparing ambient scan results

If you performed an ambient scan with the EUT turned on and the results table is populated with Spots (frequencies that have failed the threshold or limit line), then comparison of those results with an ambient scan with the EUT off can be done. The comparison between the Ambient trace (the scan with the EUT off) and Scan trace (the scan with the EUT on) is done at each failing frequency (Spot) in the Emission Results table.

- Comparison of results is done only at all failing frequencies. The Delta difference between the Ambient trace and the Scan trace is shown.
- The comparison of results is done only if the detector type for Scan and Ambient match.
- This Delta difference is compared against the Delta threshold setting made in from the Ambient tab in the EMC Settings control panel.
- If the absolute difference between the Ambient trace and Scan trace is less than the delta threshold, then those cells are shown shaded in blue in the Emission Results table, as shown below. This means that the emission could be the result of the environment and not the EUT.

Spot ...	Spot #	Range	Freq (Hz)	Scan CISPR +Pk		Ambient CISPR +Pk	
				Ampl	Delta(Limit1)	Ampl	Delta(Scan)
<input checked="" type="checkbox"/>	1	A	99.725 MHz	23.1 dBuV...	3.07 dBuV...	7.64 dBu...	15.4 dBu...
<input checked="" type="checkbox"/>	2	B	560.041 MHz	21.0 dBuV...	1.02 dBuV...	10.6 dBu...	10.4 dBu...
<input checked="" type="checkbox"/>	3	B	922.037 MHz	18.8 dBuV...	-1.20 dBu...	19.3 dBu...	-0.486 dB...
<input checked="" type="checkbox"/>	4	B	945.907 MHz	16.2 dBuV...	-3.85 dBu...	15.9 dBu...	0.269 dB...



Note: The Measure Ambient item in the Favorites toolbar will not be active if no instrument is connected or if no playback is selected.

Re-measure spot

Click **Setup > EMC > Re-measure Spot** or click **Re-measure Spot** from the from the EMC related items on the [Favorites toolbar](#), to perform the spot re-measurement.

Spot re-measurement is performed on the selected spot (frequencies that have failed Threshold/Limit lines) from the Emission Results table with detectors recommended by the standard or detectors defined by you. These detectors could typically be detectors that require larger measurement/dwell time like CISPR Quasi peak.

Spot re-measurement is useful when you want to do a quick pre-scan with peak detectors and then apply detectors with larger dwell time only on those frequencies that have failed the Threshold or Limit line settings. It is also useful when the selected measurement method is Pre-scan + Manual Spot or Pre-scan + Auto Spot.

Emission Results									
Spot ...	Spot #	Range	Freq (Hz)	Scan CISPR +Pk		Spot CISPR QPk		Spot CISPR Avg	
				Ampl	Delta(Limit1)	Ampl	Delta(Limit1)	Ampl	Delta(Limit1)
<input checked="" type="checkbox"/>	1	A	99.725 MHz	23.1 dBuV...	3.07 dBuV...	15.1 dBuV...	-4.93 dBu...	7.86 dBuV...	-12.1 dBu...
<input checked="" type="checkbox"/>	2	B	560.041 MHz	21.0 dBuV...	1.02 dBuV...	14.2 dBuV...	-5.77 dBu...	9.39 dBuV...	-10.6 dBu...
<input checked="" type="checkbox"/>	3	B	922.037 MHz	18.8 dBuV...	-1.20 dBu...	5.15 dBuV...	-14.8 dBu...	-2.20 dBu...	-22.2 dBu...
<input checked="" type="checkbox"/>	4	B	945.907 MHz	16.2 dBuV...	-3.85 dBu...	12.1 dBuV...	-7.91 dBu...	4.44 dBuV...	-15.6 dBu...

- Once the scan is done for the trace, failing frequencies are listed in the Emission Results table and you can choose the spot(s) which should be re-measured.
- You can choose the Spot(s) for performing spot measurements either from the plot or from the Emission Results table.
- The RBW for Spot measurement will be the same as that used by the pre-scan. This is because it would only be correct to compare scan and spot results when they are done with the same RBW.
- The detector choice, limit line for comparison and dwell time for spot measurement are based on the choices you made while using the Setup Wizard.
- You can also change the choice of detector(s) from the *Measurement Type* tab in the EMC Settings control panel. You can also choose up to 3 detectors to analyze these spots.
- The Limit lines for comparison and the dwell time also can be edited.
- The re-measured spot results are then shown in the Emission Results table and also compared with appropriate limit lines.

If the Measurement method chosen is Pre-scan + Auto Spot, then the Re-measure Spot step is automatically performed. You can set the maximum number spots to be automatically re-measured in the Measurement Type tab of the EMC Settings control panel. This option is visible only when the measurement method is Pre-scan + Auto Spot.



Note: The Re-measure Spot item on the Favorites toolbar will not be active when no device is connected or when no playback is selected.

Generating and saving reports

The Results and Reports window can be opened by selecting the  (Report) icon from the EMC related items on the *Favorites toolbar*. This window has two tabs that allow you to save results, select what to include in a report, generate a report, export a report, and view a report.

Save Results tab

The screenshot shows the 'Results and Reports' dialog box with the 'Save Results' tab active. The 'Measurement Heading' field contains 'RunHeading'. The 'Time Stamp' is '11-15-2017 10:52:48 AM'. The 'User Notes' field contains 'User Notes'. The 'Settings' section has 'Include Control Settings' checked. The 'Measurement Results' section has 'Include Graph', 'Include Emission Results', and 'Include Inspect Freq Results' all checked. There are three empty text boxes for 'Include Images' with browse buttons (...). A 'Save' button is at the bottom right.

1. Fill in the Measurement Heading field.
2. Add any additional information related to the test in the User Notes field.
3. Check the **Include Control Settings** box to include the EMC Settings control panel settings in the report.
4. Check the **Include Graph** check box and the **Include Emission Results** check box to include plot results and emission results in the test report.
5. If available, check the **Include Inspect Freq Result** box to include Inspect results in the test report. This option is only available if an Inspect measurement is chosen.
6. Select and browse to include any images in the report. Select the image file and click **OK**.
7. Click **Save** in the Save Results tab. The view will then change to the Generate Report tab where you can proceed to generate the report.

Generate Report tab

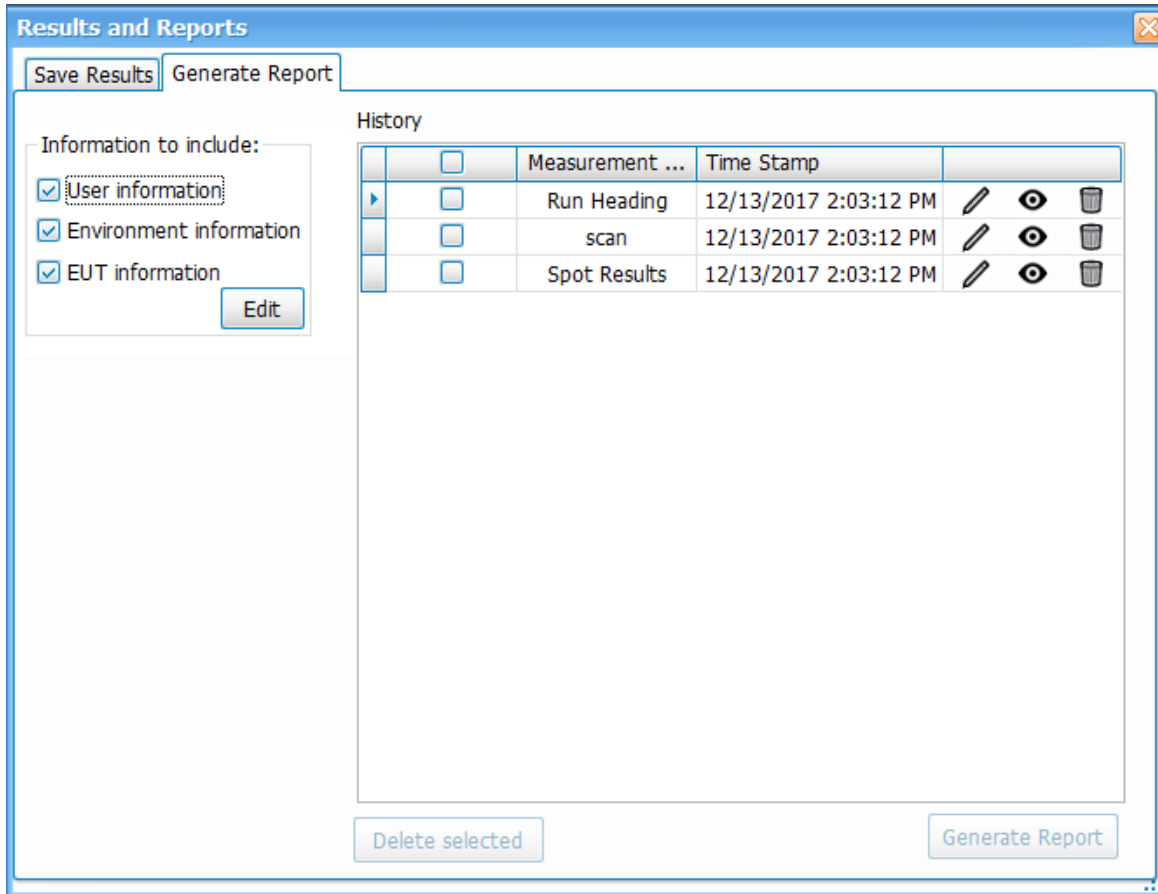

1. Select the details to be included in the report by checking or unchecking User Information, Environment information, and EUT information.
2. Click the **Edit** button to edit the information, as needed. The following window will appear.

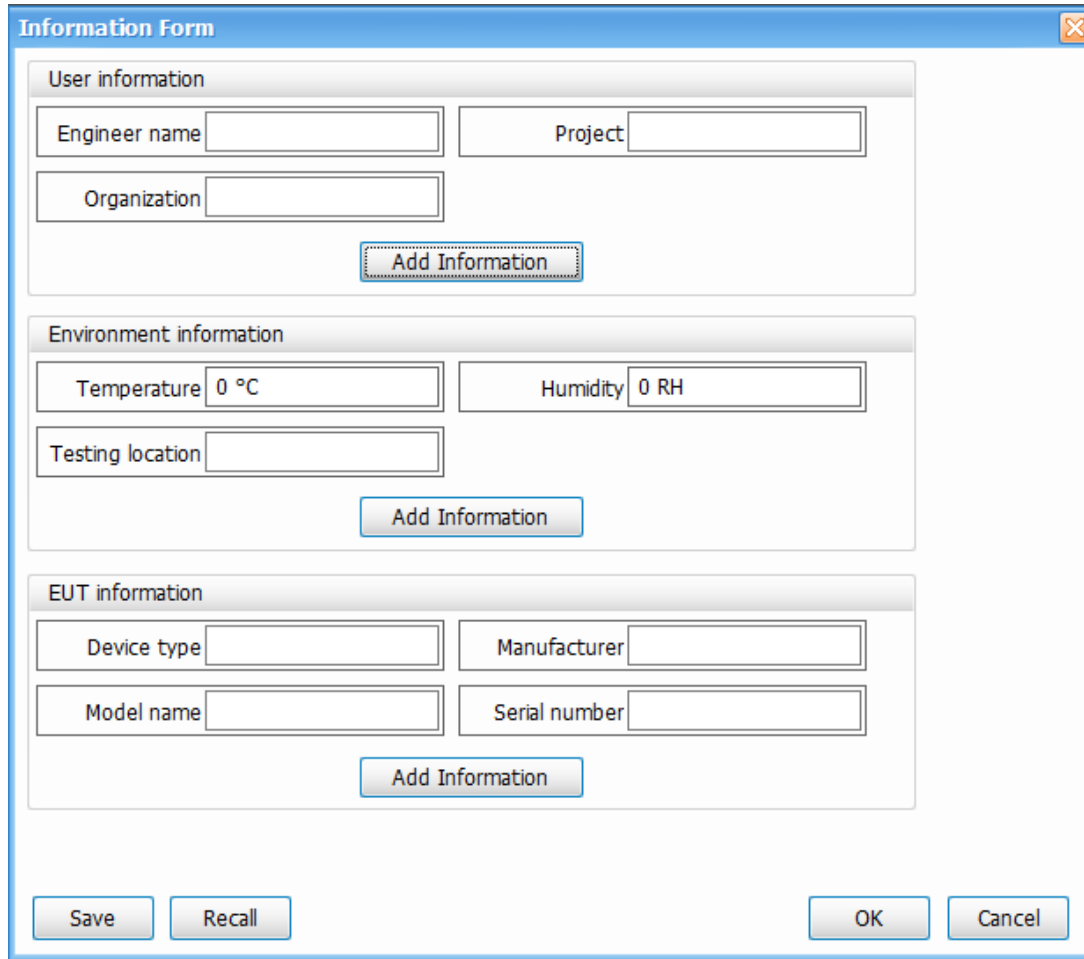

The image shows a software dialog box titled "Information Form" with a close button in the top right corner. It is divided into three sections: "User information", "Environment information", and "EUT information".

- User information:** Contains input fields for "Engineer name", "Project", and "Organization". Below these fields is a button labeled "Add Information".
- Environment information:** Contains input fields for "Temperature" (with a default value of "0 °C"), "Humidity" (with a default value of "0 RH"), and "Testing location". Below these fields is a button labeled "Add Information".
- EUT information:** Contains input fields for "Device type", "Manufacturer", "Model name", and "Serial number". Below these fields is a button labeled "Add Information".

At the bottom of the dialog box, there are four buttons: "Save", "Recall", "OK", and "Cancel".

3. Click the **Add Information** button in the desired information area to add an extra field or a parameter.
4. Click the **Save** button to save the information to a file for later recall. Or you can simply click the **OK** button to save the information for this report. The Information Form will close and you can then select your results.
5. Check the box next to the result(s) for which you want to generate a report. You can select more than one result if you want to include multiple measurement results in a single report.

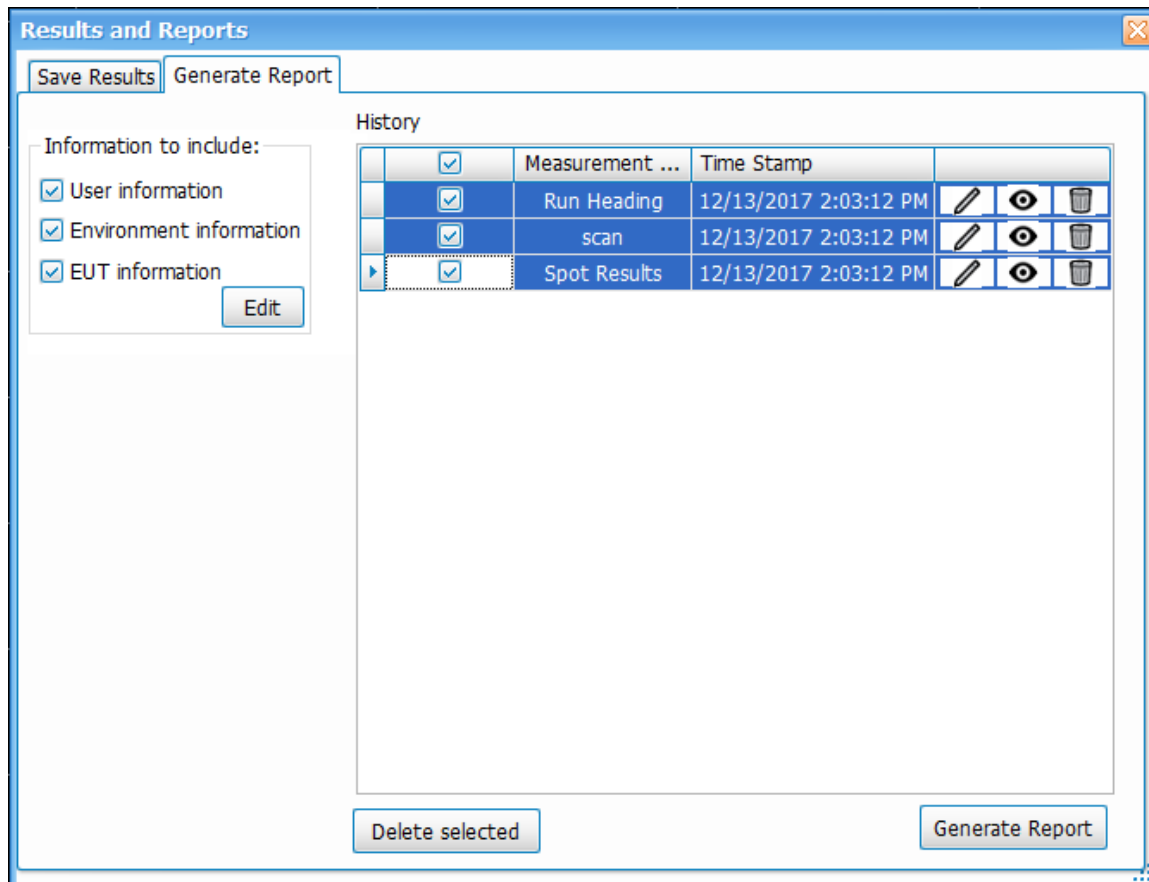

6. Click the **Generate Report** button to generate a report.
7. A preview window of the generated report will open. This window allows you to navigate, print, bookmark, email, and export the report. A report can be exported in the preferred format (.pdf, .rtf, .xlsx, etc.) and saved locally for future use. Recommended file types are .pdf and .rtf.
8. To delete existing results from the History panel of the Generate Report tab, check the boxes next to the items you want to delete, and then click the **Delete selected** button. You can also use the edit, view, and delete icons next to a result to perform the related task.

EMC Troubleshooting

EMC testing with Tektronix provides you the following suite of troubleshooting tools and displays to help you debug problems faster.

Tools

- [Harmonic Markers](#) on page 440
- [Inspect](#) on page 440 (suspect frequencies)
- [Level Target](#) on page 443
- [Compare Traces](#) on page 444
- [Persistence Display](#) on page 446

Displays

- [EMC-EMI](#)
- [DPX](#)
- [Spectrogram](#)
- [Spectrum](#)

Harmonic Markers

Harmonic markers tool allows you to place the markers at selected harmonic factors of a chosen fundamental frequency. It will be helpful for you to see if certain emissions that result out of a scan are caused due to the harmonics of a known fundamental frequency. The harmonic marker toolbar is used to define the fundamental frequency and harmonic factors.

1. Click **Setup > EMC > Harmonic Markers** from the Main menu bar, or click  **Inspect** (Harmonic Markers) on the Favorites bar to open the Harmonic Markers toolbar.

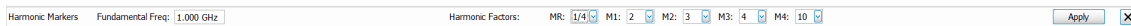

2. Enter the Fundamental frequency in the Harmonic Markers toolbar. This is the base frequency on which harmonics are calculated.
3. Choose the harmonic factors from the drop down for the 5 markers (MR, M1, M2, M3, M4). The harmonic factors in the drop down can be 1/8, 1/4, 1/2, 1, 2, 3, 4, 5, 6, 7, 8, 9 or 10.
4. Click **Apply** to place the markers at the appropriate harmonics.
5. Clicking **Apply** will also open the Marker table which will give information about the frequency at which these markers are placed and the amplitude values can be seen under the respective display column (for example, in the EMC-EMI if that is the active display).

Marker	Frequency	Δ Frequency	Time	Δ Time	Amplitude	Δ Amplitude	Phase	Δ Phase	Distance	Δ Distance	EMC-EMI	Δ EMC-EMI
MR	0.000 Hz		-5.086 ms		106.99 dBm		0.0000 °		0.000 m		---	
M1	0.000 Hz	0.000 Hz	-5.086 ms	0.0000 s	106.99 dBm	0.00 dBm	0.0000 °	0.0000 °	0.000 m	0.000 m	---	---
M2	0.000 Hz	0.000 Hz	-5.086 ms	0.0000 s	106.99 dBm	0.00 dBm	0.0000 °	0.0000 °	0.000 m	0.000 m	---	---
M3	0.000 Hz	0.000 Hz	-5.086 ms	0.0000 s	106.99 dBm	0.00 dBm	0.0000 °	0.0000 °	0.000 m	0.000 m	---	---
M4	0.000 Hz	0.000 Hz	-5.086 ms	0.0000 s	106.99 dBm	0.00 dBm	0.0000 °	0.0000 °	0.000 m	0.000 m	---	---

When the chosen harmonic factors are not in the range of the scan results then the markers could be aligned with the left or right edges to indicate that the chosen factors are outside the range of the scan. For example, if the stop frequency is 6.2 GHz and if we attempt to place a marker at the 10th harmonic of a fundamental frequency that is 1 GHz, then the marker will be placed at 6.2 GHz itself.



Tip: Harmonic markers can be used for other spectral displays; that is, displays having Amplitude vs Freq, such as Spectrum and DPX). Even if EMC-EMI display is not open, this toolbar can be invoked from **View > Harmonic Markers**.

Inspect

Inspect is a troubleshooting tool you can use to analyze a set of suspect frequencies in more detail. As many as 3 detectors can be selected and the detector results will be shown in a table format for each of the suspect frequencies. The result can also be compared with a comparison level and the entire set of results can be reported out.

Click **Setup > EMC > Inspect** from the Main menu bar, or click  **Inspect** (Inspect) on the Favorites bar to open the Results table, which shows the Inspect results.

On Selecting Inspect from EMC Toolbar or from Setup > EMC > Inspect, the results table and the Settings Control will open.

The measurement can be triggered by clicking Single or Continuous (located at the top of the Results table). The results can also be brought into the Report using the Report tool from EMC Toolbar.

The Inspect display has the following two modes of harmonics measurement:

Harmonic mode

- In Harmonic mode, the suspect frequencies are built as harmonics of fundamental frequencies.

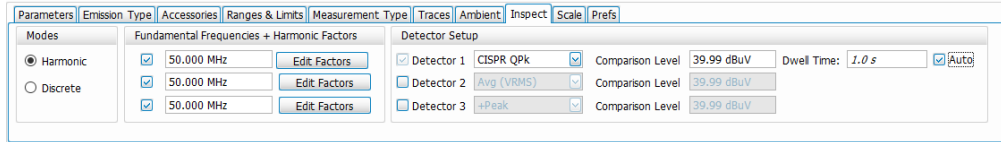

- The detectors can be chosen from the drop down in the Detectors Setup. As many as 3 detectors can be chosen. Comparison level can also be chosen for each detector too. Dwell time can be controlled too.
- Harmonic factors can be entered for each of the fundamental frequency by clicking on Edit factors (see snapshots below). Final frequency is calculated as Fundamental Frequency * Harmonic factor. The Edit Harmonic Factors/RBW table will allow you to edit RBW settings for the frequency that is being analyzed. Auto RBW flag will set RBW based on the chosen detector and frequency band in which the final frequency falls.

The 'Edit Harmonic Factors / RBW' dialog box shows the following table:

	On	Harmonic Factor	Final Frequency (Hz)	RBW (Hz)	Auto RBW All <input checked="" type="checkbox"/>
▶	<input checked="" type="checkbox"/>	1/4	12.500M	9.000k	<input checked="" type="checkbox"/>
	<input checked="" type="checkbox"/>	1/2	25.000M	9.000k	<input checked="" type="checkbox"/>
	<input checked="" type="checkbox"/>	2	100.000M	120.000k	<input checked="" type="checkbox"/>
	<input checked="" type="checkbox"/>	3	150.000M	120.000k	<input checked="" type="checkbox"/>
	<input type="checkbox"/>	4	200.000M	120.000k	<input checked="" type="checkbox"/>
	<input type="checkbox"/>	5	250.000M	120.000k	<input checked="" type="checkbox"/>
	<input type="checkbox"/>	6	300.000M	120.000k	<input checked="" type="checkbox"/>
	<input type="checkbox"/>	7	350.000M	120.000k	<input checked="" type="checkbox"/>
	<input type="checkbox"/>	8	400.000M	120.000k	<input checked="" type="checkbox"/>
	<input type="checkbox"/>	9	450.000M	120.000k	<input checked="" type="checkbox"/>

A 'Done' button is located at the bottom right of the dialog box.

- After selecting Single or Continuous in the Inspect Suspect Frequencies display, the Inspect results will be shown and they will be compared with the respective Comparison Levels. Failures will be shown in red.
- Inspect Suspect frequencies can be done in Single (Stops after all suspect frequencies are analyzed once) or Continuous mode (will continue updating the results table until stopped).

Inspect Suspect Frequencies

Single Continuous Settings Clear

Index	Fundame... Freq (Hz)	Harmonic Factor	Freq (Hz)	RBW (Hz)	Detector1: CISPR QPk	
					Abs	Delta from 11.0 dBuV/m
1	50.000 MHz	1/4	12.500 MHz	9.000 kHz	16.0 dBuV...	5.02 dBuV...
2	50.000 MHz	1/2	25.000 MHz	9.000 kHz	-6.70 dBu...	-17.7 dBu...
3	50.000 MHz	2	100.000 MHz	120.000 kHz	10.4 dBuV...	-0.575 dB...
4	50.000 MHz	3	150.000 MHz	120.000 kHz	11.7 dBuV...	0.653 dBu...
5	35.000 MHz	1	35.000 MHz	120.000 kHz	10.1 dBuV...	-0.927 dB...
6	35.000 MHz	2	70.000 MHz	120.000 kHz	10.2 dBuV...	-0.836 dB...

Discrete mode

- In Discrete mode, you can develop a list of suspect frequencies by clicking on Edit Frequencies.

EMC Settings

Parameters Emission Type Accessories Ranges & Limits Measurement Type Traces Ambient Inspect Scale Prefs

Modes: Harmonic Discrete

Discrete Table: Edit Frequencies

Detector Setup:

- Detector 1: CISPR QPk, Comparison Level: 11.0 dBuV/m, Dwell Time: 100 ms, Auto
- Detector 2: Avg (VRMS), Comparison Level: 40.0 dBuV/m
- Detector 3: +Peak, Comparison Level: 40.0 dBuV/m

Restore Defaults

- The detectors can be chosen from the drop down in the Detectors Setup. As many as 3 detectors can be chosen. Comparison level can also be chosen for each detector.
- Suspect frequencies can be entered by clicking on Edit Frequencies button.

Edit Frequencies/RBW

Load From Emission results

On	Frequency (Hz)	RBW (Hz)	Auto RBW All <input checked="" type="checkbox"/>
<input checked="" type="checkbox"/>	10.689M	9.000k	<input checked="" type="checkbox"/>
<input checked="" type="checkbox"/>	45.625M	120.000k	<input checked="" type="checkbox"/>
<input checked="" type="checkbox"/>	63.912M	120.000k	<input checked="" type="checkbox"/>
<input checked="" type="checkbox"/>	82.010M	120.000k	<input checked="" type="checkbox"/>
<input type="checkbox"/>	200.000M	120.000k	<input checked="" type="checkbox"/>
<input type="checkbox"/>	250.000M	120.000k	<input checked="" type="checkbox"/>
<input type="checkbox"/>	300.000M	120.000k	<input checked="" type="checkbox"/>
<input type="checkbox"/>	350.000M	120.000k	<input checked="" type="checkbox"/>
<input type="checkbox"/>	400.000M	120.000k	<input checked="" type="checkbox"/>
<input type="checkbox"/>	450.000M	120.000k	<input checked="" type="checkbox"/>
<input type="checkbox"/>	25.000M	9.000k	<input checked="" type="checkbox"/>
<input type="checkbox"/>	25.000M	9.000k	<input checked="" type="checkbox"/>
<input type="checkbox"/>	25.000M	9.000k	<input checked="" type="checkbox"/>
<input type="checkbox"/>	25.000M	9.000k	<input checked="" type="checkbox"/>
<input type="checkbox"/>	25.000M	9.000k	<input checked="" type="checkbox"/>
<input type="checkbox"/>	25.000M	9.000k	<input checked="" type="checkbox"/>

Done

- The suspect list can also be loaded from “Load from Emission results” which will load the top 15 spots recorded in the Emission Results table at the result of a scan.
- If no spots are listed in the Emission Results table, the following warning message is shown when the **Load from Emission results** button is clicked.



- After selecting Single or Continuous in the Inspect Suspect Frequencies display, the Inspect results in Discrete mode will be shown and the results are then compared with the respective Comparison Levels. Failures are shown in red.

Inspect Suspect Frequencies								
Index	Freq (Hz)	RBW (Hz)	Detector1: CISPR QPk		Detector2: Avg (VRMS)		Detector3: +Peak	
			Abs	Delta from 11.0 dBuV/m	Abs	Delta from 40.0 dBuV/m	Abs	Delta from 40.0 dBuV/m
1	10.689 MHz	9.000 kHz	20.1 dBuV...	9.13 dBuV...	20.7 dBuV...	-19.3 dBu...	31.0 dBuV...	-9.00 dBu...
2	45.625 MHz	120.000 kHz	14.6 dBuV...	3.62 dBuV...	12.2 dBuV...	-27.8 dBu...	21.2 dBuV...	-18.7 dBu...
3	63.912 MHz	120.000 kHz	14.4 dBuV...	3.37 dBuV...	12.3 dBuV...	-27.7 dBu...	22.2 dBuV...	-17.7 dBu...
4	82.010 MHz	120.000 kHz	17.3 dBuV...	6.32 dBuV...	14.3 dBuV...	-25.7 dBu...	23.7 dBuV...	-16.3 dBu...

In the Inspect Suspect Frequencies display, all detector results are held between acquisitions, unlike the scan results, which are computed with every scan. When the **Clear** button is clicked, all detectors results will be cleared. This will allow you to set a smaller dwell time, even for detectors such as CISPR Quasi Peak, and build stable results over acquisitions, resulting in faster analysis/updating.

Level Target

Level target is an indicator on the display that can be set by you. You can move it with a mouse. It can also be set at the Peak of the active waveform. This tool is available on four displays (EMC-EMI, Spectrum, DPX, and Spurious). The Level Target will change in other displays when changed in the active display.

You can use Level Target to assign it to the peak of a scan and retain the level for comparison for the next scan and see how it compares with the new scan results.

1. Click **Setup > EMC > Level Target** from the Main menu bar, or click  (Level Target) on the Favorites bar. This will open the Spectrum display and place the Level Target in the display. If the Spectrum display is already open, then hitting Level Target toggles visibility of Level Target.
2. Click the **To Peak** button located on the left side of the Spectrum display to move the Level Target to the peak of the trace. You can also click the **To Peak** button that appears in the Prefs tab of the Spectrum Settings control panel when the **Show Level Target** check box is checked. To hide the Level Target indicator, uncheck the box.

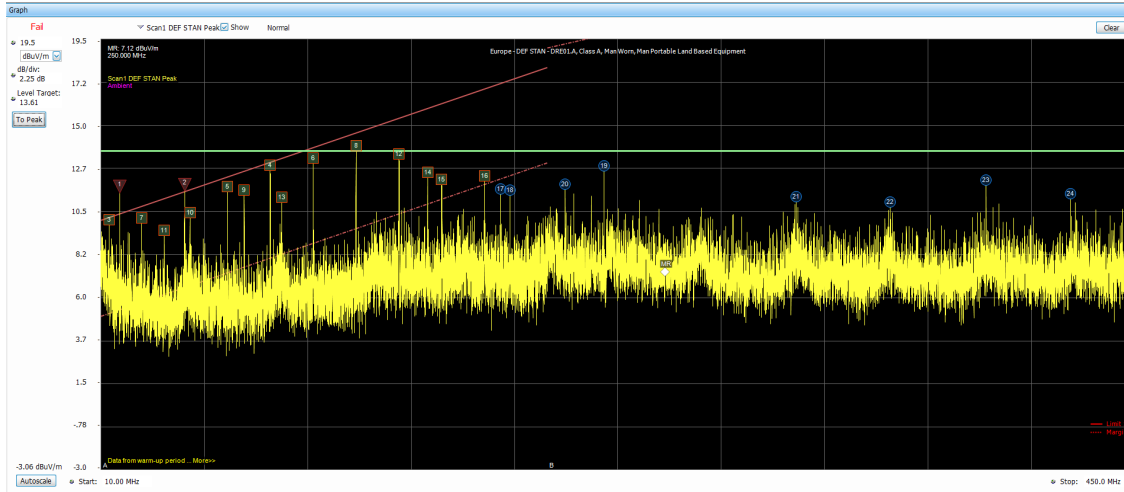

Compare Traces

This troubleshooting tool can be used to compare traces of different scan results. It can be used to compare as many as 2 Live Scan traces, 3 Spot traces, 5 Recalled traces and a Math Trace (which is the result of subtracting any two traces). Legends for these traces will also appear in the graph.

Click **Setup > EMC > Compare Traces** from the Main menu bar or click  (Compare Traces) on the *Favorites toolbar* to open the *Traces tab* in the EMC Settings control panel.

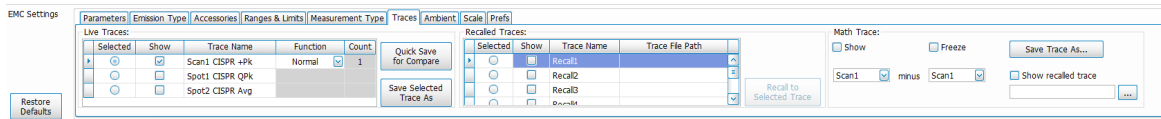

The control panel is divided into the following three areas:

Live traces area

Live Traces:

Selected	Show	Trace Name	Function	Count
<input checked="" type="radio"/>	<input checked="" type="checkbox"/>	Scan1 CISPR +Pk	Normal	1
<input type="radio"/>	<input type="checkbox"/>	Spot1 CISPR QPk		
<input type="radio"/>	<input type="checkbox"/>	Spot2 CISPR Avg		

Quick Save for Compare

Save Selected Trace As

- This area includes the traces that are shown on screen after a Scan or Spot re-measurement.
- Include up to a maximum of 2 scan traces and up to a maximum of 3 spot detector results.
- Function is available for Scan traces. This allows you to select to Max-hold or Average multiple acquisition results.
- The **Save Selected Trace As** button is only available if a live trace is selected. This button is disabled if no Live trace is selected.
- The check boxes in the Show column control the visibility of the trace in the main graph display.

Using Quick Save for Compare button

- You can compare scan results of two or more successive scan tests using this button.
- This button is only visible when one of the Live traces is selected.

- When you click this button, the selected Live trace is saved automatically in your drive and recalled into one of the rows in Recalled Traces. It will be automatically recalled into a row (Recall1 through Recall 5, in that order) depending on which one is free. The following timed pop-up message will appear indicating the Recall Trace in which it is available for comparison.

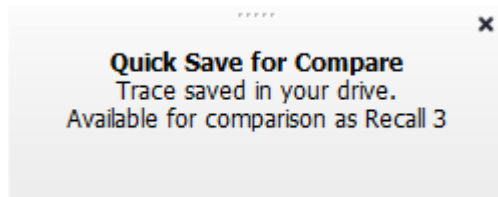

- If none of the Recalled Traces are free, then clicking this button will save the trace in your drive and recall the trace as Recall 1 (replacing the earlier recalled trace in Recall 1). However, the files replaced can be browsed for and recalled using the Recall to Selected Trace control.
- All traces saved with this button are saved in the *C:\SignalVu-PC Files* directory.

Recalled traces area

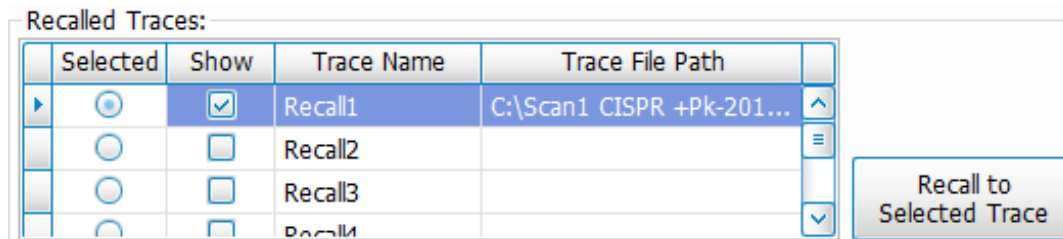

- Select any Recall trace (Recall 1 to Recall 5) to recall a saved trace.
- The **Recall to Selected Trace** button is only available if a Recall trace is selected.
- Once a trace is successfully recalled, the trace will be displayed in the graph for the chosen frequency range (set in the Ranges & Limits tab of the EMC Settings control panel). Here is an example. The recalled trace is green:

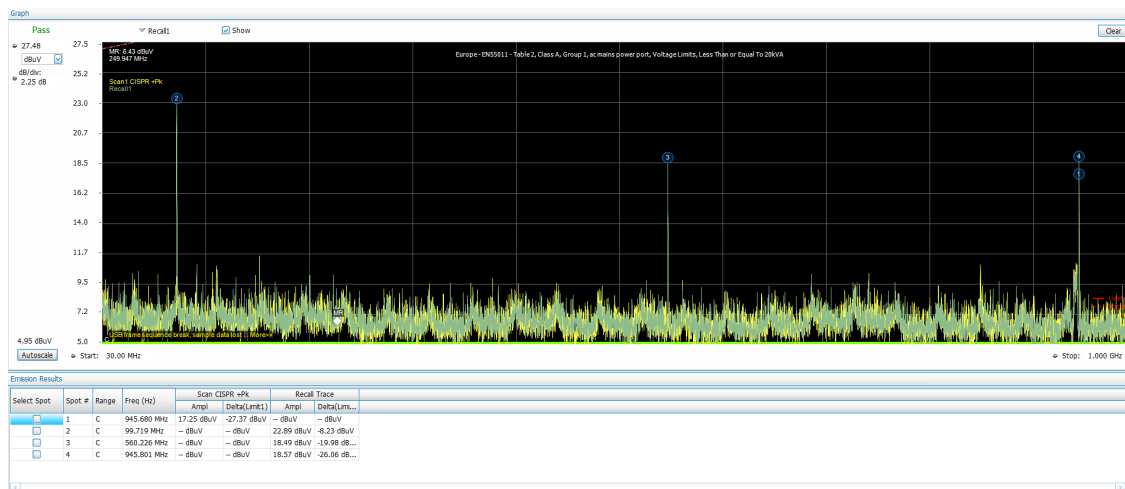

- The recalled trace will be compared with the Limit lines (in the Ranges & Limits control settings) and the Emission results table will be populated. Here is an example:

Select Spot	Spot #	Range	Freq (Hz)	Scan CISPR +Pk		Recall Trace	
				Ampl	Delta(Limit1)	Ampl	Delta(Limit1)
<input type="checkbox"/>	1	C	945.801 MHz	17.10 dBuV	-5.90 dBuV	18.57 dBuV	-4.43 dBuV
<input type="checkbox"/>	2	C	560.226 MHz	-- dBuV	-- dBuV	18.49 dBuV	-4.51 dBuV
<input type="checkbox"/>	3	C	99.719 MHz	-- dBuV	-- dBuV	22.89 dBuV	-0.11 dBuV

Math trace area

Math Trace is a feature that allows you to obtain the subtraction result of any two traces. Two traces must be chosen from the Traces tab and the difference trace will be shown in the graph. The Math trace is done only for log units in Y-axis and the difference trace is calculated by subtraction of the dB values. The Math trace can also be saved (**Save Trace As** button) and recalled (check **Show recalled trace** box).

Math Trace:

Show Freeze

Scan1 minus Recall1 Show recalled trace

Math Trace allows you to check if emission components still exist from one scan trial to another or even to check if a live scan trace has additional emission components as compared to the emission results obtained from *Ambient* (with EUT turned off). The following image shows two traces and a Math trace. You can see that emission components 1 and 2 are emission components that are present in Scan1, but not present in Recall1 (therefore it shows up in Math trace); however, the emission component at the far end is present both in Scan1 and Recall1 (hence cancelled out in the Math trace).

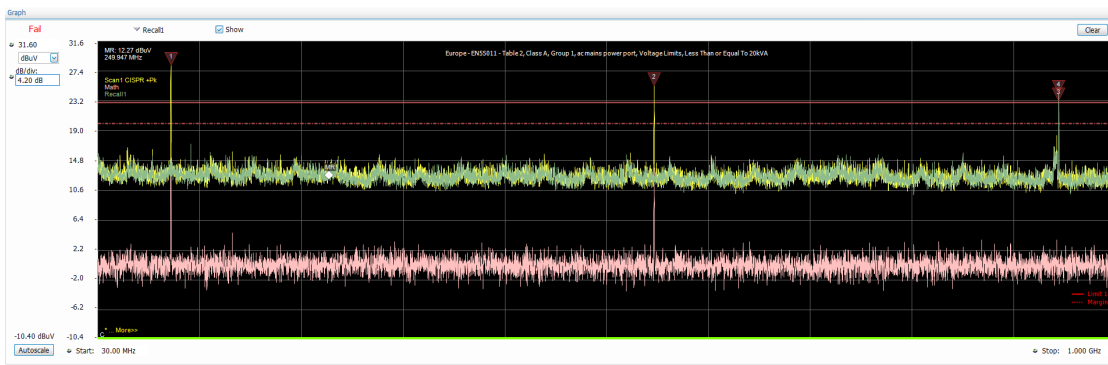

Persistence Display

This troubleshooting tool launches the DPX Spectrum display. This has the capability to show a persistence view over multiple acquisitions. The speed of DPX allows you to select even transient emissions.

Click **Setup > EMC > Persistence Display** from the Main menu bar, or click **Persistence Display** (Persistence Display) on the Favorites bar, to open the DPX Spectrum display.

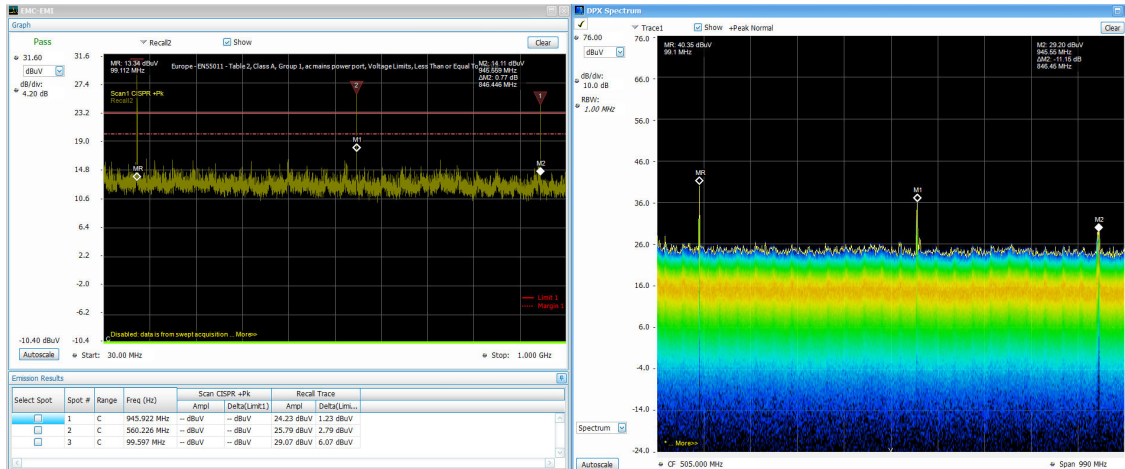

Tip: You can read more about the [DPX Spectrum display](#) here.

EMC-EMI display

To show the EMC-EMI display:



1. Double click the  icon on the Desktop to launch EMCVu. This automatically opens the EMC-EMI display.
2. Alternatively, from the analyzer:
 - a. Click the **Displays** button or select **Setup > Displays**.
 - b. From the Measurements box, select **EMC Analysis**.
 - c. Double-click the **EMC-EMI** icon in the **Available displays** box. This adds the EMC-EMI icon to the **Selected displays** box (and removes it from the Available displays box). Alternatively, you can click the EMC-EMI icon and then click the Add button to select EMC-EMI for display.
 - d. Click the **OK** button.

Elements of the display

The EMC-EMI display window has three main areas:

1. Graph
2. Emission Results table
3. Inspect suspect frequency display



0720-017

Item	Display element	Description
1	dB/ div	Sets the vertical scale value per division. The maximum value is 20.00 dB/division.
2	Units	Sets the global Amplitude units for all the views in the analysis window. This will change the Amplitude selection in the Units tab of the Analysis Settings control panel.
3	Vert Position	Sets the top of graph value. This is only a visual control for panning the graph. The Reference Level is adjusted in the toolbar and the Ampl Settings control panel. By default, Vert Position = Ref Level.
4	Pass / Fail readout	Indicates whether one or more frequencies have exceeded a limit specified on the Settings > Limits tab. The readout will show as Fail even if a single Spot (either from Scan or Spot Re-measurement) exceeds the Limit line. The Fail criteria can be modified to include Margin from the Prefs tab.
5	Selected trace	Indicates the selected or active trace.
6	Show	Controls whether the selected trace is visible or not. When trace is Off, the box is not checked.

Table continued...

Item	Display element	Description
7	Trace function	Indicates the trace processing method. If Average or Max Hold is selected, this readout displays the number of traces being processed (averaged or compared for the Max Hold value).
8	Clear	Restarts multi-trace functions (Average, Max Hold).
9	Stop	Adjusts the graph stop frequency. This setting affects only visual scaling, not measurement parameters.
10	Emission results table	Displays Emission results. See the Emission Results image and table that follow for details.
11	Start	Adjusts the graph start frequency. This setting affects only visual scaling, not measurement parameters.
12	Autoscale	Adjusts the Vertical and Horizontal scaling to display the entire trace on screen. Selects Multi-range display mode.
13	Bottom of graph readout	Indicates the amplitude at the bottom of the graph. This value changes with the dB/div and Vertical Position settings.
14	Green bar	Indicates the range that is selected on the Settings > Ranges and Settings > Limits tabs.
(Not shown)	Inspect suspect frequencies	This portion of the display appears to the right of the EMC-EMI graph when Inspect is selected from the EMC related items on the Favorites toolbar. See the Inspect Suspect Frequencies image and table that follow for more information about this display.

Emission Results table elements

Select Spot	Spot #	Range	Freq (Hz)	Scan CISPR +Pk		Spot CISPR QPk		Spot CISPR Avg	
				Ampl	Delta(Limit1)	Ampl	Delta(Limit1)	Ampl	Delta(Limit1)
<input checked="" type="checkbox"/>	1	A	70.000 MHz	20.8 dBuV...	-0.165 dB...	7.72 dBuV...	-13.3 dBu...	0.452 dBu...	-20.5 dBu...
<input checked="" type="checkbox"/>	2	B	669.862 MHz	13.0 dBuV...	-4.98 dBu...	9.86 dBuV...	-8.14 dBu...	2.51 dBuV...	-15.5 dBu...
<input type="checkbox"/>	3	B	820.012 MHz	4.42 dBuV...	-13.6 dBu...	-- dBuV/m	-- dBuV/m	-- dBuV/m	-- dBuV/m

Column	Description
Select spot	Selects the spot frequency for Re-measurement. Is shown in the graph too with white indicator.
Spot #	A number that identifies a spot in the graph area. The instrument can display a maximum of 999 spots.
Range	The letter representing the frequency range where the spot is located.
Freq (Hz)	The failed frequency at which the spot occurs.

Table continued...

Column	Description
Ampl (Scan)	The amplitude of the spot identified in scan.
Delta (Scan)	Specifies the difference between Amplitude in scan and specified Limit line.
Ampl (Spot)	The amplitude of the spot for chosen detector.
Delta (Spot)	Specifies the difference between Amplitude and specified Limit line for the chosen detector.

- You can rearrange the order of the columns in the Emission Results table. To move a column, click on the column heading and drag it to the desired position.
- You can sort the rows in the Emission Results table by clicking on the column heading. For example, if you click on the Freq, the results in the Emission Results table will be sorted by frequency. If you click on Range, the rows will be sorted by range. Clicking a second time on the same heading reverses the order.
- There can be as many as 2 Scan results (Ampl and Delta for each) and as many as 3 Spot Re-measure results (Ampl and Delta for each) in the Emission results table.
- In addition to that, the Emission results table will also have columns for Recall trace (Amplitude and Delta with Limit 1) and Ambient measurement results (Amplitude and Delta with Scan results).

Elements of Inspect Suspect Frequencies display

This section of EMC-EMI display shows the results of the Inspect Suspect Frequencies troubleshooting tool. This measurement has the following two modes:

- Harmonic

Index	Fundame... Freq (Hz)	Harmonic Factor	Freq (Hz)	RBW (Hz)	Detector1: CISPR QPk	
					Abs	Delta from 11.0 dBuV/m
1	50.000 MHz	1/4	12.500 MHz	9.000 kHz	16.0 dBuV...	5.02 dBuV...
2	50.000 MHz	1/2	25.000 MHz	9.000 kHz	-6.70 dBu...	-17.7 dBu...
3	50.000 MHz	2	100.000 MHz	120.000 kHz	10.4 dBuV...	-0.575 dB...
4	50.000 MHz	3	150.000 MHz	120.000 kHz	11.7 dBuV...	0.653 dBu...
5	35.000 MHz	1	35.000 MHz	120.000 kHz	10.1 dBuV...	-0.927 dB...
6	35.000 MHz	2	70.000 MHz	120.000 kHz	10.2 dBuV...	-0.836 dB...

- Discrete

Inspect Suspect Frequencies								
Single		Continuous		Settings			Clear	
Index	Freq (Hz)	RBW (Hz)	Detector1: CISPR QPk		Detector2: Avg (VRMS)		Detector3: +Peak	
			Abs	Delta from 11.0 dBuV/m	Abs	Delta from 40.0 dBuV/m	Abs	Delta from 40.0 dBuV/m
1	10.689 MHz	9.000 kHz	20.1 dBuV...	9.13 dBuV...	20.7 dBuV...	-19.3 dBu...	31.0 dBuV...	-9.00 dBu...
2	45.625 MHz	120.000 kHz	14.6 dBuV...	3.62 dBuV...	12.2 dBuV...	-27.8 dBu...	21.2 dBuV...	-18.7 dBu...
3	63.912 MHz	120.000 kHz	14.4 dBuV...	3.37 dBuV...	12.3 dBuV...	-27.7 dBu...	22.2 dBuV...	-17.7 dBu...
4	82.010 MHz	120.000 kHz	17.3 dBuV...	6.32 dBuV...	14.3 dBuV...	-25.7 dBu...	23.7 dBuV...	-16.3 dBu...

Setting	Description
Single	Selects the spot frequency for Re-measurement. Is shown in the graph too with white indicator.
Continuous	A number that identifies a spot in the graph area. The instrument can display a maximum of 999 spots.
Settings	The letter representing the frequency range where the spot is located.
Clear	The failed frequency at which the spot occurs.

Column	Description
Index	Suspect frequencies numbered in the order in which they are defined.
Fundamental Frequency (Hz) (Harmonic mode only)	Shows the fundamental frequency (Hz).
Harmonic Factor (Harmonic mode only)	Shows the harmonic factor.
Frequency (Hz)	Shows the frequency (Hz).
RBW	The RBW you set in the Ranges and Limits tab on page 427 of the EMC Settings control panel is shown in here.
Detector	Detector results are shown in two columns (Abs and Delta) from comparison level for each detector.
Abs	
Delta	



Tip: Read the [Inspect](#) on page 440 topic in the Troubleshooting section for more information about this tool.

EMC-EMI settings

Main menu bar: Setup > Settings

Favorites toolbar: 

The following tabs are available for the EMC-EMI display from the EMC Settings control panel.

Table 23: Common controls for RF measurement displays

Settings tab	Description
Parameters	Allows you to specify whether the graph displays one range or multiple ranges. You can also specify whether all Spur/Spot on page 881 are shown or only spurs/spots over specified limits and margins.
Emission Type	Enables you to specify conducted or radiated emissions for the EMI test.
Accessories	Enables you to select, edit, load, and save accessories for conducted and radiated emissions tests.
Ranges & Limits	Allows you to specify the start and stop frequencies for ranges, the parameters that define a spot (for listing in the Emission Results table), and Pass/Fail parameters for limit testing.
Measurement Type	Allows you to define the detectors for scan and spot measurement.
Traces	Provides controls for live traces, recalled traces, and Math trace.
Ambient	settings related to Ambient measurement and Ambient trace control. Ambient measurement can be triggered by selecting Setup > EMC > Measure Ambient or clicking on Measure Ambient in EMC Toolbar. The settings in the Ambient tab of Settings control panel apply only to measurements done by selection of "Measure Ambient" This measurement is useful for capturing emissions caused by environment or the Spectrum analyzer equipment. Before an Ambient scan is done, the EUT must be switched off/or completely removed from the setup. Note - For workflow of this measurement can be done, refer Measure Ambient section in the Pre-compliance section
Scale	Allows you to change the vertical and horizontal scale settings.
Prefs	Allows you to change the parameters of the EMC-EMI display.



Tip: Access to a subset of the above settings is available in the [EMC Project Setup Wizard](#).

Parameters tab - EMC

Favorites toolbar: 

This tab is available for the EMC-EMI display from the EMC Settings control panel. It allows you to specify settings that control the EMC Spurious measurement.

EMC Settings

Parameters | Emission Type | Accessories | Ranges & Limits | Measurement Type | Traces | Ambient | Scale | Prefs

Frequency Ranges

Multi Single

List Spots

All Spots Over Limit Over Limit with Margin

Restore Defaults

Setting	Description
Frequency Ranges	
Multi	Sets the analyzer to display all enabled ranges in the graph.
Single	Limits the graph to display only the first range. Trace is shown only if this range is selected.
List Spots	
All Spots	Displays all frequency peaks that exceed the threshold values set in the Ranges & Limits tab.
Over Limit	Displays frequency peaks that exceed the threshold values and the chosen Limit lines set in the Ranges & Limits tab.
Over limit with margin	Displays frequency peaks that exceed both the threshold values and the margin (corresponding to the chosen limit line).

Emission Type tab - EMC

Favorites toolbar:

This tab is available for the EMC-EMI display from the EMC Settings control panel. It allows you to specify the emission type for the EMI test you want to perform. This selection affects the list of accessories available for selection in the Accessories tabs of the EMC Setup wizard and the EMC Settings control panel.

EMC Settings

Parameters | Emission Type | Accessories | Ranges & Limits | Measurement Type | Traces | Ambient | Scale | Prefs

Emission Type: Conducted Radiated

Restore Defaults

Setting	Description
Conducted	Select when conducted emission tests are to be done. Conducted emission tests measure the radio disturbance voltage at the mains terminal of the equipment under test (EUT) using LISN.

Table continued...

Setting	Description
Radiated	Select when radiated emission tests are to be done. Radiated emission tests measure the radio disturbance field strength emitted by the equipment under test (EUT) using an antenna.

Accessories tab - EMC

Favorites toolbar:

This tab is available for the EMC-EMI display from the EMC Settings control panel. It allows you to select, edit, load, and save accessories. You can also view a gain/loss plot. More accessories settings are available from the [Accessories](#) tab in the [EMC Project Setup Wizard](#).

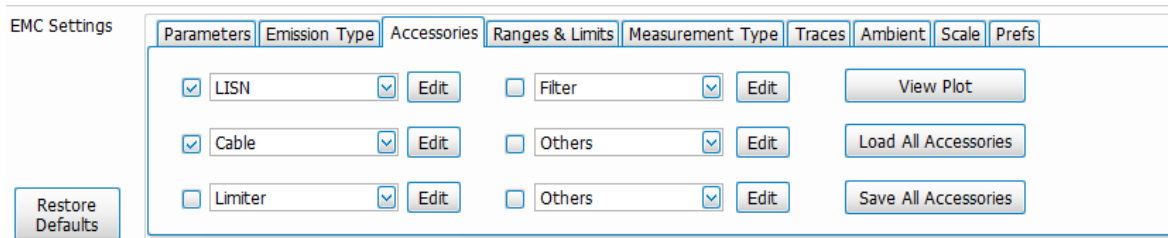

Setting	Description
Accessory name and drop down list	Shows the names of the six selected accessories. You can select from the associated drop down list. The content of the list is determined by the selected emission type. Check the box next to an accessory to select it for a test. You can see a table of all of the available accessories, by emission type, in the Accessories tab topic.
Edit	Click to open a window that allows you to edit the details of the associated accessory. See the Add and/or edit individual accessories on page 425 topic for detailed information about how to use this window.
View Plot	Click to view a gain/loss plot. This will also show the combined gain/loss as a net impact of all the accessories. You can read more about this in the Combined impact of gains/losses on page 460 topic.
Load All Accessories	Click to load a complete accessories setup from a saved file. This is faster than loading accessories one by one if you have many.
Save All Accessories	Click to save a complete accessories setup to a file for reuse. Details about all of the accessories will be saved.



Tip: Read about setting up accessories in the [Accessories setup](#) topic.



Tip: Read about available accessories from Tektronix in the [EMC accessories](#) topic.

Accessories setup

Accessories can be set up for EMI test using the Accessories tab in the EMC Project Setup Wizard and the one in the EMC Settings control panel. These tabs allow you to set up the accessories required for a test and view a graph showing the combined impact of accessories gains and losses. The final measurement reading is corrected based on these accessory contributions before it is shown in the display. The correction is calculated by negating the combined impact of all of the accessory gains/losses you entered.

When any accessory is selected, its contribution will impact the final measurement results shown in the display. “Ext corrections enabled for traces” is the message you will see in the status bar and display. This message can be suppressed from **Tools > Options > Prefs**.



Tip: See the [Accessories tab](#) topic for information about the tab in the EMC Settings control panel.

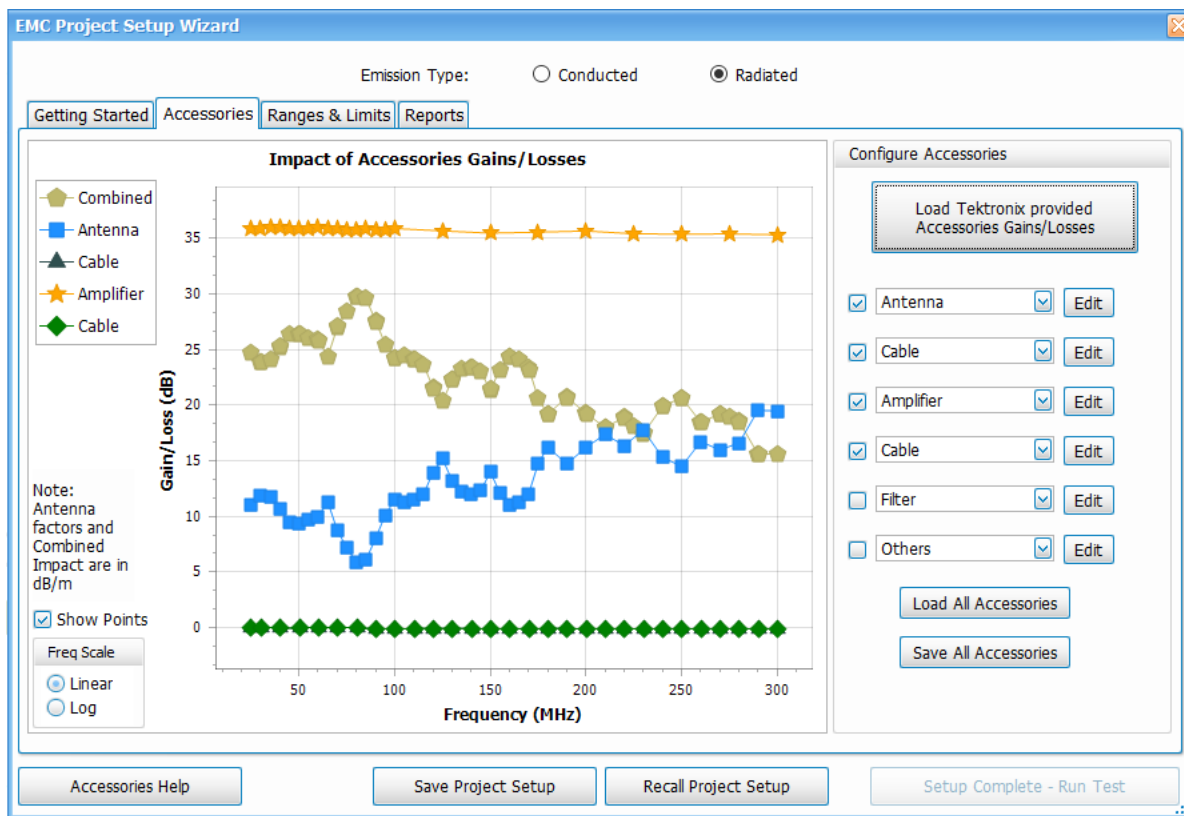

See these topics about accessories setup:

- [Available accessories in the drop-down lists](#)
- [Combined impact of gains/losses](#) on page 460
- [Edit accessory contributions](#) on page 456
- [External correction in DPX](#) on page 465
- [Loading accessories from a file](#) on page 458
- [Two types of mismatch issues when recalling the csv file](#)
- [Changing accessory details](#) on page 458

Available accessories in the drop-down lists

A total of six accessories can be included in the test setup, as shown on the right side of the following image. Accessories can be selected using the drop down lists. The content of these lists depends on the selected emission type, as show in the following table.

Emission type	Available accessories
Conducted	LISN, Cable, Limiter, Amplifier, Attenuator, Filter, Others
Radiated	Antenna, Near field probe, Cable, Amplifier, Limiter, Attenuator, Filter, Others



Tip: Loss factors of Tektronix supported accessories can be quickly loaded by clicking the [Load Tektronix provided accessories gains/losses](#) on page 424 button.

Edit accessory contributions

Accessories specific information and details like Model no, Serial no, Asset tag, calibration due date can be edited using Edit option. A window such as the one shown below will open. The following images show examples for Amplifier and Antennas (Factor and isotropic gain).

Edit Amplifier

Model: PAM103
 Serial:
 Asset Tag:
 Cal Due Date: 05/28/2017 Disable Cal Due Date

Select Gain/Loss Format
 Constant Gain/Loss
 Amplifier Gain/Loss Table

Frequency Interpolation
 Linear
 Log

	Freq (Hz)	Gain/Loss (dB)
1	300.000M	35.32441
2	325.000M	35.25395
3	350.000M	35.12368
4	375.000M	34.93034
5	400.000M	34.80666
6	425.000M	34.68036
7	450.000M	34.49289
8	475.000M	34.75072
9	500.000M	34.74375

Buttons: Load, Save As, OK, Cancel, Add, Delete, Delete All Rows

Edit Antenna

Model: ALC100
 Serial:
 Asset Tag:
 Cal Due Date: 05/28/2017 Disable Cal Due Date

Distance: 10 m

Select Gain/Loss Format
 Constant Gain/Loss
 Antenna Gain/Loss Table
 Antenna Factor

Frequency Interpolation
 Linear
 Log

	Freq (Hz)	Factor (dB/m)
1	300.000M	13.16621255
2	350.000M	21.03568044
3	400.000M	14.86559991
4	450.000M	16.69212514
5	500.000M	17.41470004
6	550.000M	18.34362689
7	600.000M	19.7365125
8	650.000M	19.54413357
9	700.000M	20.1259804

Buttons: Load, Save As, OK, Cancel, Add, Delete, Delete All Rows

Edit Antenna

Model:

Serial:

Asset Tag:

Cal Due Date: Disable Cal Due Date

Distance:

Select Gain/Loss Format

Constant Gain/Loss

Antenna Gain/Loss Table

Antenna Factor

Frequency Interpolation

Linear

Log

	Freq (Hz)	Gain/Loss (dBi)
1	25.000M	-12.82189983
2	30.000M	-12.15827491
3	35.000M	-10.63933911
4	40.000M	-8.369500173
5	45.000M	-6.136449724
6	50.000M	-5.141299913
7	55.000M	-4.73344621
8	60.000M	-4.197674992
9	65.000M	-4.852432867

Buttons: Load, Save As, OK, Cancel

Setting	Description
Model	Specify the Model Name/number of the accessory.
Serial	Specify the Serial Number of the accessory.
Asset Tag	Specify any user-specific Asset tag id for the accessory
Cal Due Date	Specify the Calibration due date of the accessory. It can be disabled by checking the check box if not required.
Distance	Specify the Distance between EUT and Antenna (Applies only when accessory is antenna).
Select Gain/Loss format	Choose between the options available below. A) Constant Gain/Loss, B) Gain/Loss Table. For Antenna, you will have a third selection available C) Antenna Factor
Constant Gain/Loss	Specify the loss value which is constant for the complete frequency range. The Gain/ Loss will be entered in dB. Gain values are entered as positive dB value and Loss as negative.
Gain Loss Table (Corresponds to the accessory selected)	Specify the loss values at specific frequency points. The Gain/ Loss values in these tables will be entered in dB. Gain values are entered as positive dB value and Loss as negative. The values in between the frequency points are interpolated with frequency axis treated as Linear/Log based on the Frequency interpolation selection. Note- For Antenna, this table will be entered in dBi (isotropic Gain values) as shown in the snapshot above
Antenna Factor	Applicable only for Antenna. Antenna factors are given in dB/m. These values are typically available in vendor data sheets. You can also load the typical values from Example Files if you have purchases them from Tektronix.
Frequency Interpolation	Specifies the frequency interpolation method used for interpolating Gain/Loss values or Antenna factors. The frequency axis points are either taken as Linear or Log values based on this choice. Linear interpolation is followed but x axis values can be either in Log or Linear as per this selection.
Load	Click to load a saved Accessory details from a file. This will recall all parameters seen in this window.
Save As	Click to save the Accessory details to a file. (All details shown above)
OK	Click OK to give confirmation of the entered details.

Table continued...

Setting	Description
Cancel	Click Cancel to ignore the edit window and exit. This will discard any changes that you might have made before OK is pressed.

Changing accessory details

To change the accessories details, click on the Edit button present against the antenna which needs to be edited.

1. A dialogue box pop up is displayed which contains the parameters of the accessory to be edited and updated.
2. Parameters to be updated are like Model No, Serial No, Asset Tag, Calibration due date, polarization, Distance, Loss Factor and Frequency Interpolation.
3. Details which are updated can be saved for future analysis by clicking Save all Accessories button which saves the details to a file.
4. Click OK button to load all the updated details of the accessory.

Loading accessories from a file

Tek supported accessories

Tektronix supports some of accessories namely Antenna, Amplifier, Near field probe and LISN with their detailed information embedded in a .csv file which is readily available for the user as a part of the software in *C:\SignalVu-PC Files\EMC Accessories*.

Non-Tek supported accessories

Details of Non - Tek supported accessories can be loaded by preparing a .csv file manually by the user. (You can also build it using the UI by adding a row for each frequency)

The Gain/Loss table values are usually found from the datasheet or graphs and accessory supported documents provided by the vendor when purchased.

You can build a csv file with only two columns (Freq column and Gain/Loss column) without headers and you can load the file into this User interface through Load button. You can also add more frequency rows by editing the csv file. Once you load such a csv file, you can enter the other details like Model, Serial number etc and save the file again and another csv file with all additional details and with appropriate headers would get saved.



Tip: See the [Two types of mismatch issues when recalling the .csv file](#) on page 458 topic.

Two types of mismatch issues when recalling the .csv file

Emission type mismatch (for Load All)

When Load All Accessories is used, the complete setup which is saved for a specific emission type can be recalled only when emission type matches. If the Emission type has been changed and if a recall is attempted, "Emission type mismatch" error is shown.

For example, if the setup saved in conducted emission type mode, it cannot be recalled into radiated emission type mode.

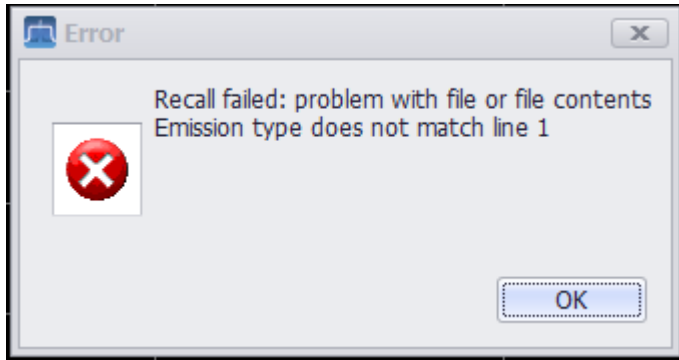

Header type mismatch

If the right type of csv file is not loaded in the Edit Accessory section, then the below error message is shown. For example, if the csv file header line is modified externally, the error message will be shown when an attempt is made to load the csv in the Edit Accessory section.

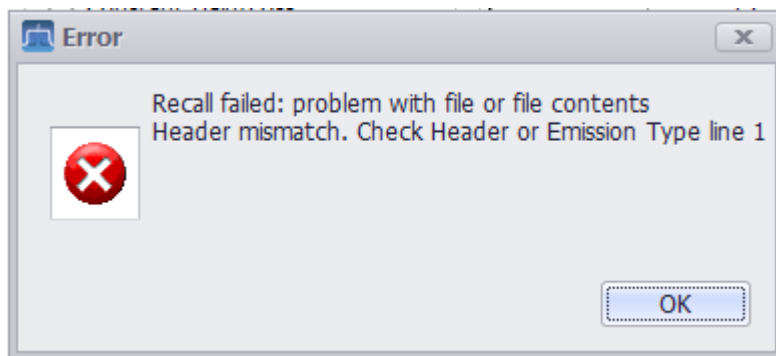

Emission Type mismatch (for individual accessories)

When the accessory is specific to Radiated (Near Field Probe or Antenna) or Conducted (LISN) emission type and an attempt is made to Load the accessory information under a different emission type, the following error message is shown. For example, if the Emission Type is Radiated, the error message will be shown if you attempt to load LISN Accessory information in the Edit Accessory section.

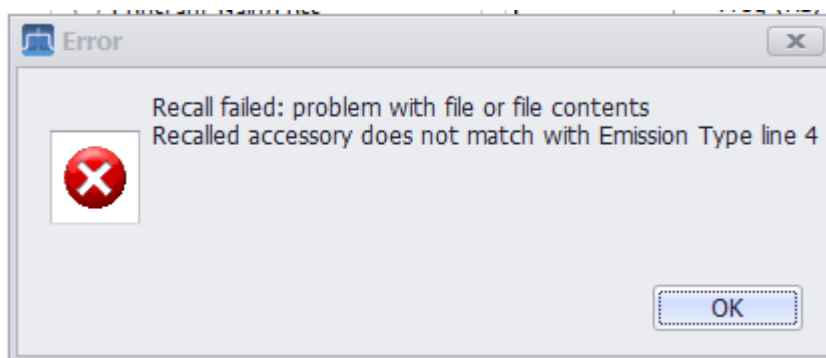

Sorting the Freq column in the Loss Table

- You can sort the Freq column in the Loss table by clicking on the column heading. For example, if you click on the Freq (Hz) header, the results in the loss table will be sorted by frequency. Clicking a second time on the same heading reverses the order.
- When a new row is added, the column is sorted automatically based on the frequency value entered in the new row.
- When an existing frequency value is edited, then the column is sorted automatically based on the frequency value edited.

- When OK is clicked in the edit window of an antenna automatic sorting of loss column is happened.



Note: Duplicate entries of frequency is not allowed either manually or through csv file. Duplicate entry results in an error message stating the row numbers of the duplicate frequencies.

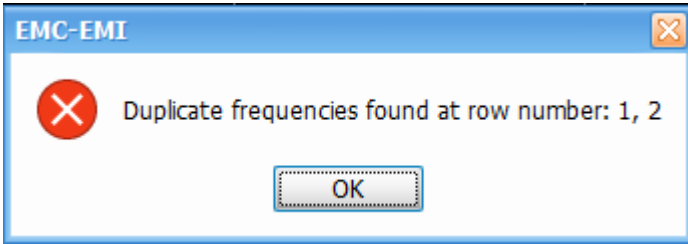

Combined impact of gains/losses

Details of the contribution of each accessory and the combined impact of gains/losses can be viewed in the Impact of Accessories Gains/Losses plot in the Accessories tab. You can select to **Show Points** on the plot and to view the plot in the log or linear frequency scale (shown on the bottom left of the display shown below).

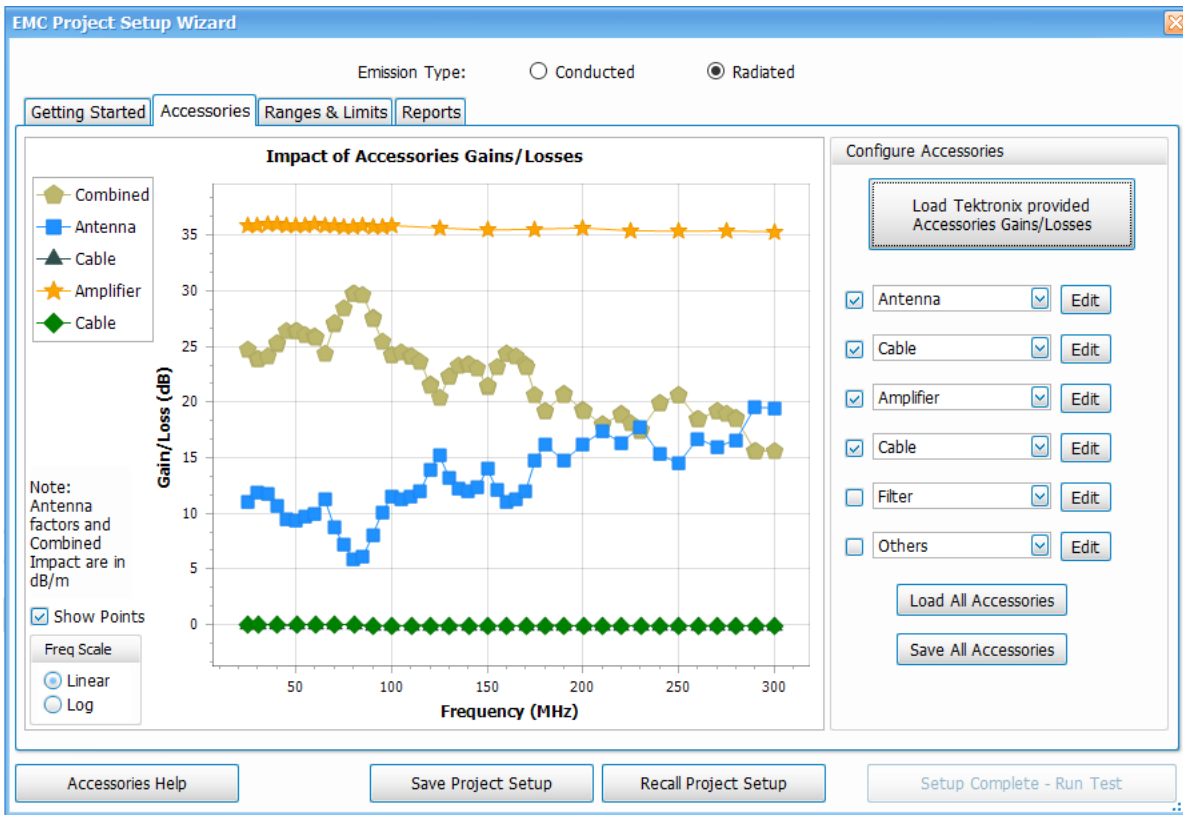

Figure 97: Individual contributions from Antenna, Amplifier, and Cable, and the combined impact, are shown in the above plot.

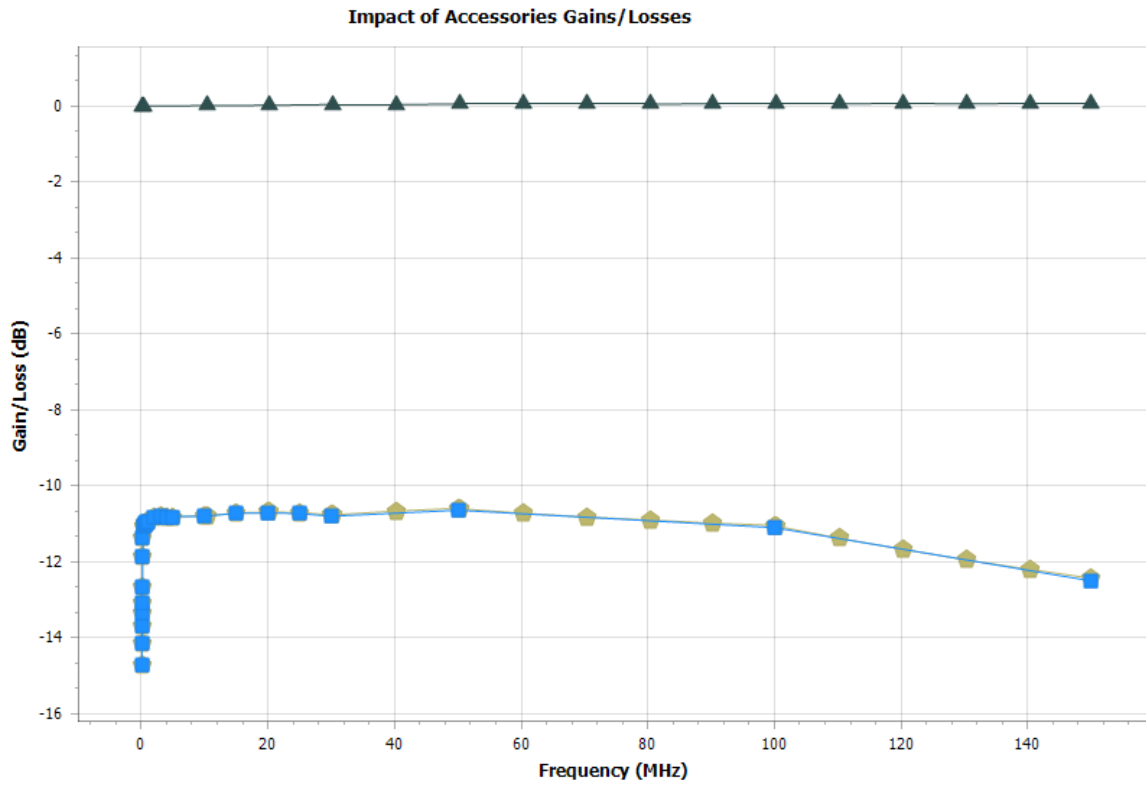
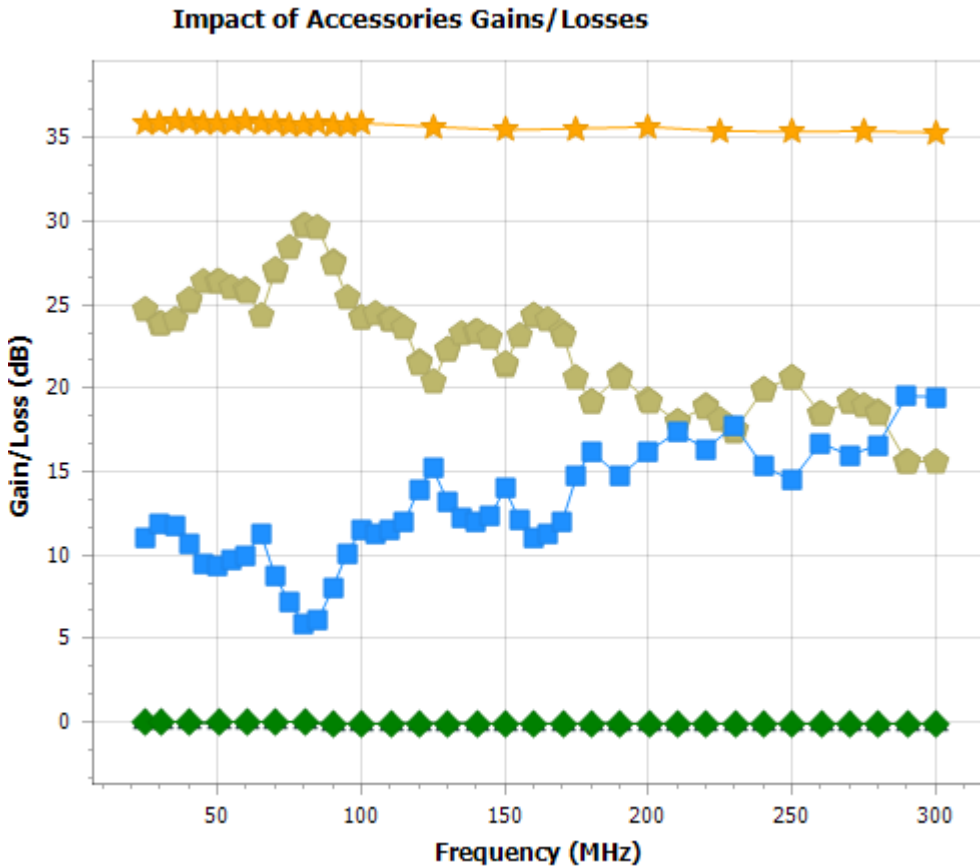

Figure 98: Individual contribution and combined Gain/Loss factors of LISN and a cable (for conducted emission) are shown in the above plot.



Tip: Read more about combined impact in the [Calculation of combined impact of accessories gains/losses](#) on page 462 topic.

Calculation of combined impact of accessories gains/losses

Case 1: non-antenna accessories

Combined gain/loss is calculated by combining the individual gains/losses of individual accessories. Except for Antenna, all accessory gains/losses are in dB (Gain >0, Loss <0). So, the combined gain/loss is calculated by adding all the individual contributions. The plot shows the combined effect in dB.

This combined impact of accessories gains/losses is negated to arrive at the correction factors. Correction factors are applied to the actual spectrum analyzer reading before it is shown in the respective displays.

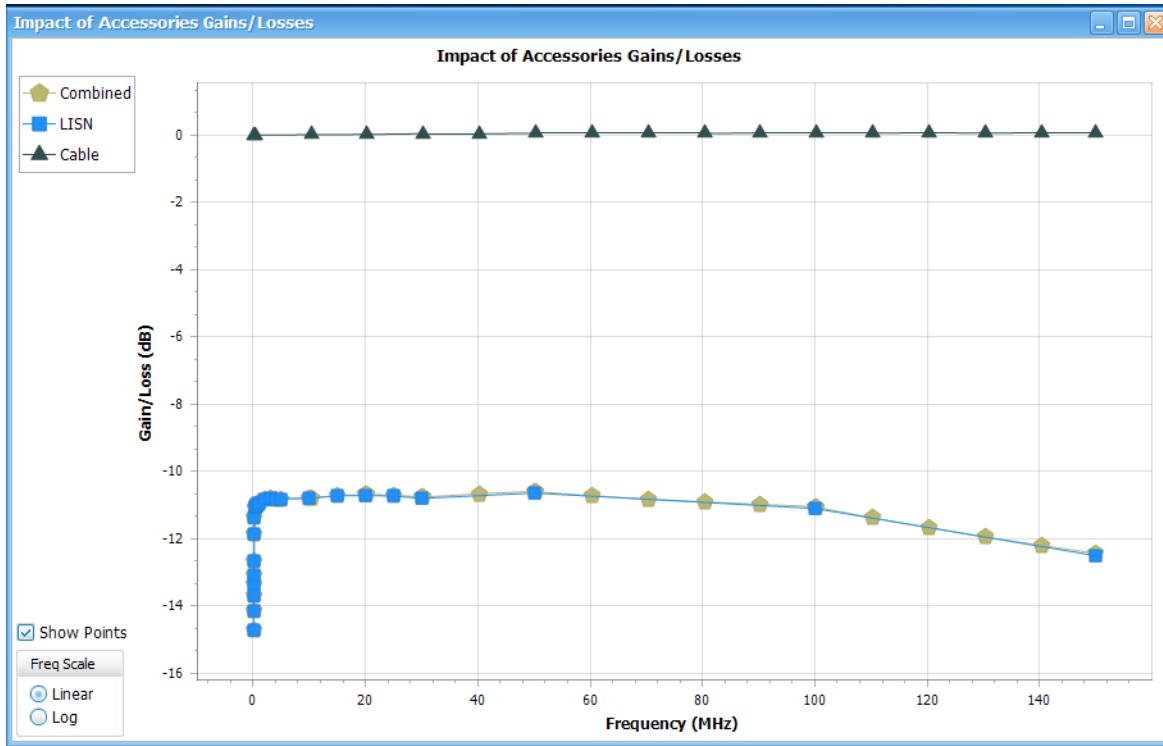

The Combined impact is calculated only for common frequency range. If there are individual accessories that have different frequency ranges, only the common range is chosen for calculation of combined gain/loss. An example is shown below. The combined loss range matches only that of near field probe, although Cable and Amplifier gain/loss information entered for a wider frequency range.

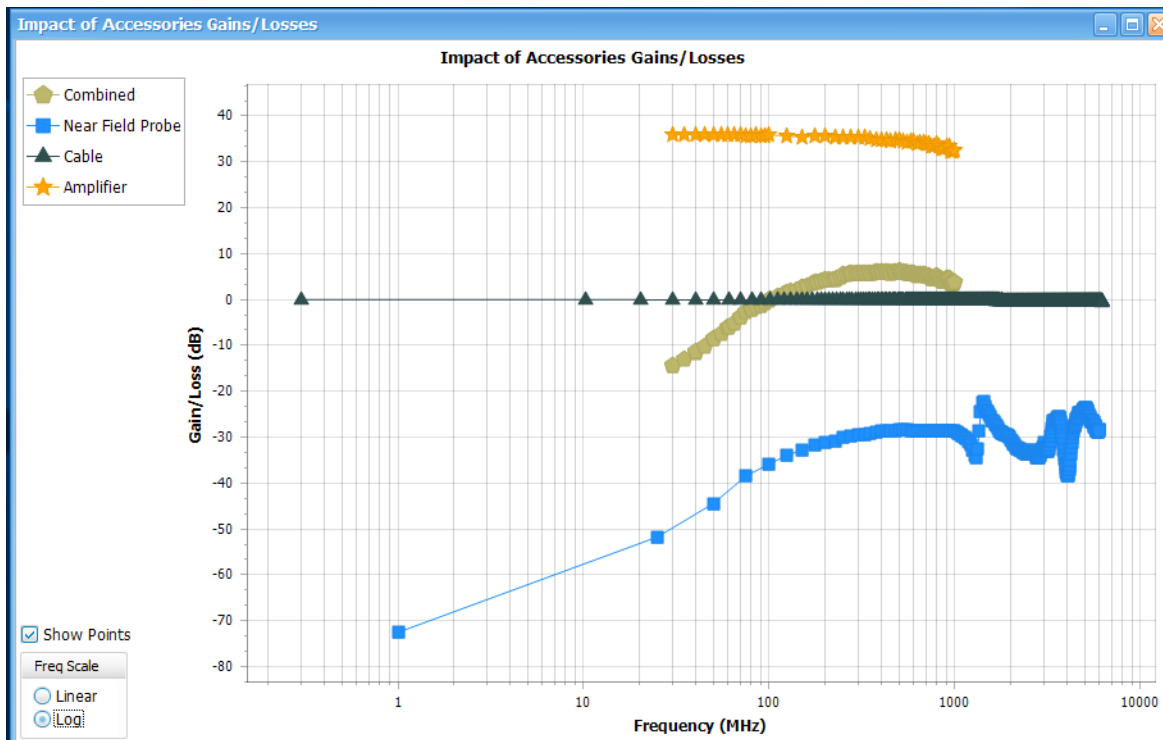

It is this combined impact that is negated to arrive at correction factors which is eventually applied to the measured trace before it is shown in the displays.

Case 2: antenna accessories

In case of Antenna, you can enter the accessory contribution either as isotropic gain values or as Antenna factors (both of which is commonly available in vendor data sheets). Isotropic gain should be entered as any other accessory contribution (Gain >0, Loss <0) and Antenna factors is expected to be entered as you would see the factors in any data sheet in dB/m.

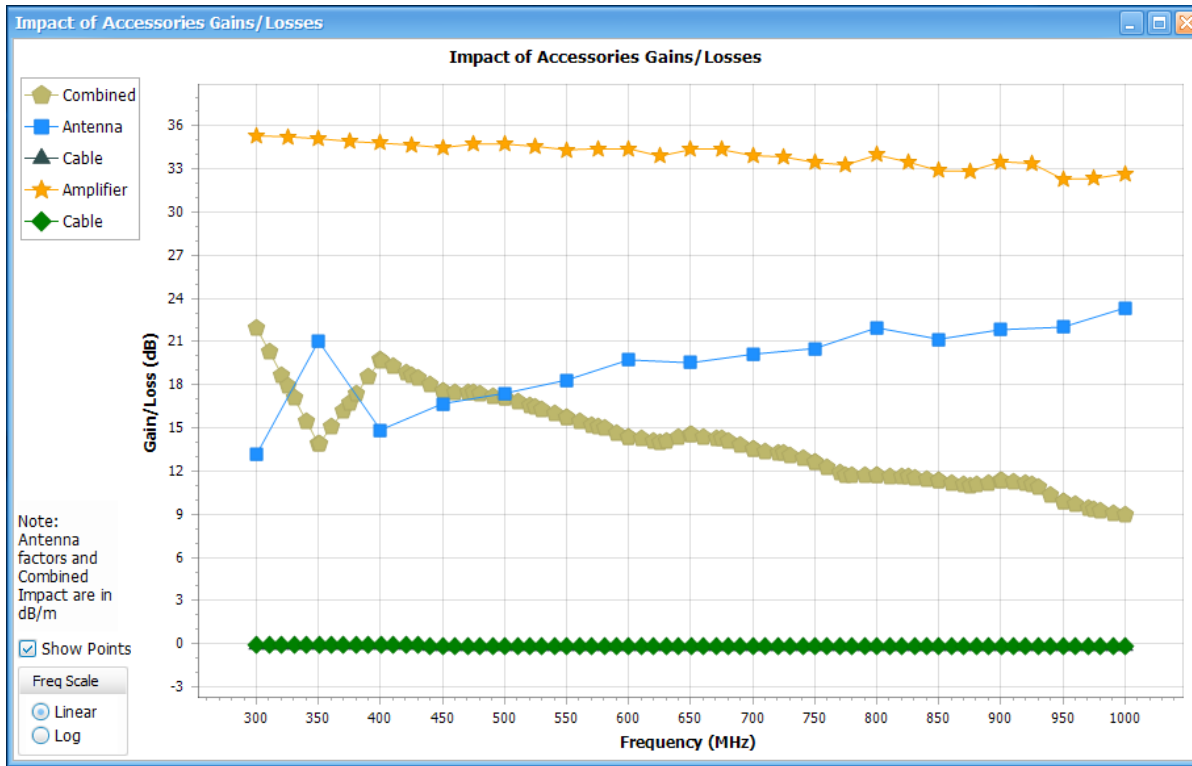

Antenna factors are used to adjust the final reading as follows. $Corrected\ Reading\ (dBuV/m) = Spectrum\ analyzer\ Reading\ (dBuV) + Antenna\ Factor\ (dB/m)$

- When you have an Antenna as one of the accessories, the results are also shown in field strength units dBuV/m. Note that the above image has a note that says Antenna factor and Combined Impact are in dB/m.

As mentioned earlier, the combined impact of all accessories are negated to arrive at correction factors. However, as Antenna factors are used as it is given in data sheet for correction of results, Antenna factors are negated before calculating Combined Impact of all Accessories Gains/Losses in the above plot. That is the reason you would observe the combined impact follows the inverse of Antenna factors in the above figure.

The combined impact in the above case would be as follows. $Combined\ Impact\ (dB/m) = Amplifier\ Gain\ (dB) + Cable\ effect\ (dB) - Antenna\ Factor\ (dB/m)$ (Note that the cable effect is entered as Gain >0 and Loss <0.)

And the combined impact is eventually subtracted from:

$$Corrected\ Reading\ (dBuV/m) = Spectrum\ Analyzer\ reading\ (dBuV) - Combined\ Impact\ (dB/m)$$

Even when the user enters the antenna contribution as isotropic gain, they are converted to antenna factors before presenting in the Combined Impact plot.

$$Antenna\ Factor\ (dB/m) = (20 * \log_{10}(f\ in\ MHz) - 29.7707) - Isotropic\ Gain$$

Therefore, in the plot, you will always see the antenna factor contribution and the combined impact is calculated as explained above before it is finally negated to be employed as correction factors to the measured readings.

Warning when frequency range of scan does not match

A warning message is shown in the plot when the frequency range of the Correction factors (-1*Combined Impact) is smaller than the frequency range of the scan. When a scan is attempted beyond the frequency range of the Correction factors, the following warning message is shown “Scan range exceeds range of Combined accessories. Reduce scan range”

External correction in DPX

If external correction due to these accessories are to be applied on the DPX display then this can be done only by selecting All acquired data (filter method).



Tip: Read more about external gain correction for [DPX](#) here.

Ranges & Limits tab - EMC

Favorites toolbar:

This tab is available for the EMC-EMI display from the EMC Settings control panel. It allows you to specify the start and stop frequencies for ranges, the parameters that define a spot (for listing in the Emission Results table), and Pass/Fail parameters for limit testing.

On	Start (Hz)	Stop (Hz)	RBW (Hz)	Auto	VBW (Hz)	VBW On	Threshold (dBuV)	Excess (dB)	Limit1 Start (dBuV)	Limit1 Stop (dBuV)	Limit1 Same	Limit2 Start (dBuV)	Limit2 Stop (dBuV)	Limit2 Same
<input checked="" type="checkbox"/>	150.0000...	500.0000...	9.000k	<input checked="" type="checkbox"/>	1M		26.00	6.0	66.00	56.00		56.00	46.00	
<input checked="" type="checkbox"/>	500.0000...	5.0000000M	9.000k	<input checked="" type="checkbox"/>	1M		26.00	6.0	56.00	56.00	<input checked="" type="checkbox"/>	46.00	46.00	<input checked="" type="checkbox"/>
<input checked="" type="checkbox"/>	5.0000000M	30.0000000M	9.000k	<input checked="" type="checkbox"/>	1M		30.00	6.0	60.00	60.00	<input checked="" type="checkbox"/>	50.00	50.00	<input checked="" type="checkbox"/>
<input checked="" type="checkbox"/>	0.0000000	0.0000000	200.000	<input checked="" type="checkbox"/>	1M		56.99	6.0	56.99	56.99		56.99	56.99	

Setting	Description
Expand	Displays the Ranges & Limits table in a new, resizable window.
Table	Shows the ranges and limits for the test. You can edit values in the table directly. You may have to scroll the table to access all settings when multiple ranges are selected. You can reorder columns in the table by dragging the columns to a new position. See the Ranges & Limits table topic below this table for more information.
Reset layout	Returns the column order in the Ranges & Limits table to the factory default order.
Load	Click to load a saved Ranges & Limits table from a file. The default directory is the last folder to which you saved a .csv file.
Save	Click to save the current Ranges & Limits table to a file. The default directory is the last folder to which you saved a .csv file.
Limit 2	Check to set and Limit 2.

Table continued...

Setting	Description
Limit 3	Check to set and Limit 3.
Margin	Set the margin value.
Load From Standard	Loads a Ranges & Limits table as defined by a Standard.
Edit Limit Label	Allows you to edit the Limit Label.

Ranges & Limits table elements

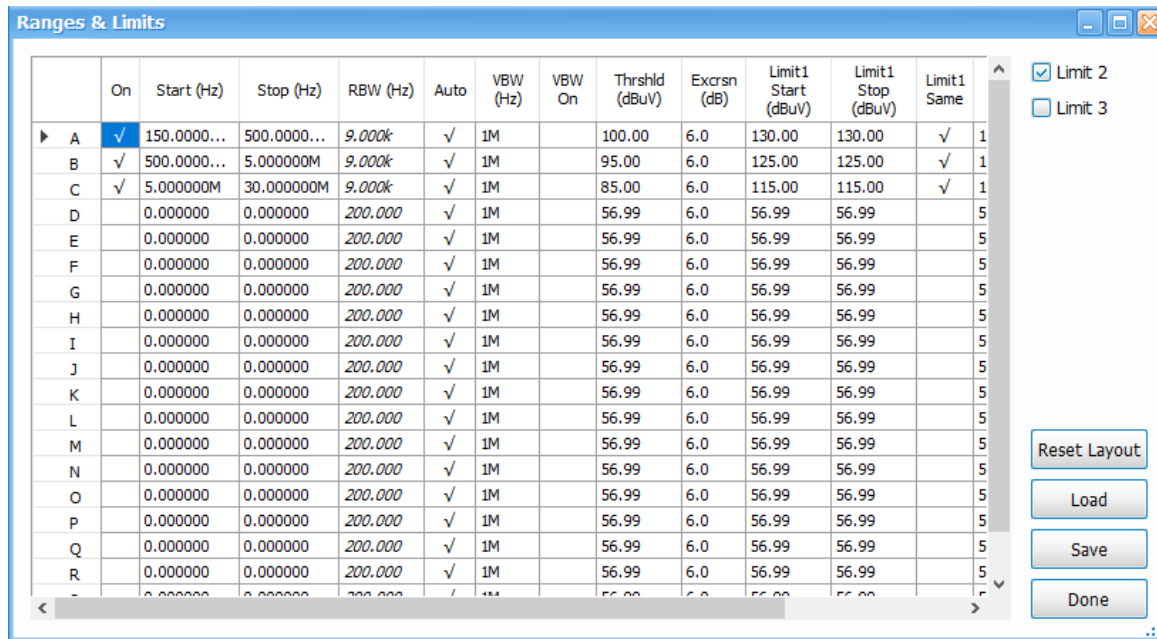

Setting	Description
On	Specifies whether the measurements are taken in the specified range or not.
Start (Hz)	Readout of the start frequency for the selected range.
Stop (Hz)	Readout of the stop frequency for the selected range.
RBW (Hz)	Specifies the Resolution Bandwidth (RBW) used for the selected range.
Auto	Sets the RBW automatically. For CISPR standards, the frequency range determines the RBW.
VBW (Hz)	Adjusts the VBW (Video Bandwidth) value. VBW Maximum: RBW current value VBW Minimum: 1/10,000 RBW setting

Table continued...

Setting	Description
VBW On	Specifies whether the VBW filter is applied or not.
Threshold (dBuV or dBuV/m)	Specifies the level that must be exceeded for a signal peak to be recognized as a Spot. A signal peak must also exceed the excursion setting to be considered a Spot.
Excursion (dB)	Specifies the peak to peak magnitude that must be exceeded for a signal peak to be recognized as a Spot. A signal transition must also exceed the threshold setting to be considered a Spot. A Spot requires the amplitude to drop by the excursion amount between Spots.
Limit 1/2/3 Start (dBuV or dBuV/m)	Specifies the limit at the start frequency. The limit values for the frequency range are calculated by linear interpolating between Limit Start and Limit Stop. The frequency start and stop values are taken in Linear or Log, based on the scale choice.
Limit 1/2/3 Stop (dBuV or dBuV/m)	Specifies the limit at the stop frequency. The limit values for the frequency range are calculated by linear interpolating between Limit Start and Limit Stop. The frequency start and stop values are taken in Linear or Log, based on the scale choice.
Limit 1/2/3 Same	Sets the starting and stopping frequencies for Limit 1, Limit 2, and Limit 3 to the same value.
Limit 2	Set and display Limit 2.
Limit 3	Set and display Limit 3.
Margin	Set the margin value.
Rest layout	Returns the column order in the Ranges & Limits table to the factory default order.
Done	Saves changes and closes the Ranges & Limits table expanded window.
Save	Saves the current Ranges & Limits table to a file.
Load	Loads a saved Ranges & Limits table from a file.

See these related Ranges & Limits topics:

- [Change range Start and Stop frequencies](#) on page 467
- [Specify Spot requirements](#) on page 468
- [Set limits](#) on page 468
- [Perform Pass/Fail testing](#) on page 468
- [Load from Standard](#) on page 428

Change range Start and Stop frequencies

To change the range start and stop frequencies from the Ranges & Limits tab edit the Start and Stop frequencies in the table as follows.

1. Click the **Expand** button on the Ranges & Limits tab. This displays the Ranges and Limits table.
2. Check the On box for the ranges that you want to measure.

3. Click on the Start or Stop frequency setting to change it. Type in a number for the frequency and a letter as a multiplier. You can use k, m, or g to set the frequency multiplier.
4. Click **Done** to save your changes.



Tip: You can read about settings in the [Ranges & Limits tab - EMC](#) on page 465 topic.

Specify Spot requirements

A Spot is a signal peak that exceeds both the Threshold and Excursion settings in the Ranges and Limits table. The Threshold and Excursion settings are specific to the selected range. If you want to use different settings for Spots in different ranges, you must set the values separately for each range. The Excursion control is used to avoid interpreting a single spot as multiple narrower spots by requiring the amplitude to drop by the Excursion amount between spots. Raising the Threshold value means that fewer, larger signals will be identified as spots.

Specify the Spot requirements for a range as follows:

1. Click the **Expand** button on the Ranges & Limits tab. This displays the Ranges and Limits Table.
2. Select the **Range** (A–T) for which you want to specify the Spot requirements.
3. Set the **Thrshld** value
4. Set the **Excrsn** value.

Spot specification is also dependent on the **List Spots** selection in the [Parameters](#) tab. By default, this selection is All Spots, in which case all frequency peaks above the Threshold (subject to Excursion violation) are classified as Spots for listing in the Emission Results table. If this selection is Over Limit, then only those frequency peaks above the limit line classify as a Spot for listing in the Emission Results table. The third selection is **Over Limit with Margin**, which will only classify frequency peak that violate limit lines with margin included in them.



Tip: You can read about settings in the [Ranges & Limits tab](#) topic.

Set limits

Use the Limits settings in the Ranges & Limits table to specify the [pass/fail](#) parameters for the EMC-EMI measurement.

- When the Mask setting is set to any value except off, the analyzer identifies any signal peak that exceeds the specified limits as a violation and displays **Fail** on the screen. If no signal peak exceeds the limits, the analyzer displays **Pass** on the screen.
- The Margin control lets you set the buffer that you want around the limit line.
- The frequency peaks that violate the limit lines are shown in red both in the graph and Emission Results section. If they violate only the limit line, then they are shown in orange.



Tip: You can read about settings in the [Ranges & Limits tab](#) topic.

Perform Pass/Fail testing

Set up Pass/Fail EMI testing using the Ranges & Limits tab and table. All the following parameters can be set manually or loaded from a file or from a specified Standard.

1. Click the **Expand** button on the Ranges & Limits tab. This displays the Ranges and Limits Table.
2. Adjust the Start and Stop frequencies as required for each range you want to test.
3. Verify that the On box is checked for ranges that you want to test.
4. Set the limits in the Start, Stop.

5. Set the required RBW and VBW.
6. Verify that the **Thrshld** and **Excrsn** values are set as required. These are the values that define a Spot.
7. Click **Done** to save your changes and close the Range and Limits table window.
8. Click **Run** to begin testing.



Tip: You can read about setting limits using the Ranges & Limits tab in the [Set limits](#) on page 468 topic.



Tip: You can read about settings in the [Ranges & Limits tab](#) topic.

Measurement Type tab - EMC

Favorites toolbar:



This tab is available for the EMC-EMI display from the EMC Settings control panel. It allows you to define the detectors for scan and spot measurement.

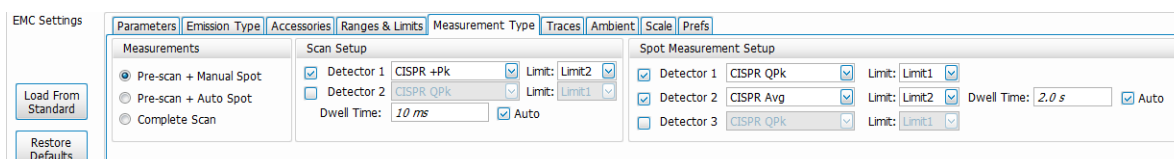

This tab is divided into the following three areas:

- [Measurements](#) on page 469
- [Scan Settings](#) on page 471
- [Spot Measurement Setup](#) on page 471

The results of Scan and Spot re-measurements are tabulated in the Emission Results table (shown below). This table is accessed from the [EMC-EMI display](#).

Emission Results										
Select Spot	Spot #	Range	Freq (Hz)	Scan CISPR +Pk		Spot CISPR QPk		Spot CISPR Avg		
				Ampl	Delta(Limit1)	Ampl	Delta(Limit1)	Ampl	Delta(Limit1)	
<input checked="" type="checkbox"/>	1	A	70.000 MHz	20.8 dBuV...	-0.165 dB...	7.72 dBuV...	-13.3 dBu...	0.452 dBu...	-20.5 dBu...	
<input checked="" type="checkbox"/>	2	B	669.862 MHz	13.0 dBuV...	-4.98 dBu...	9.86 dBuV...	-8.14 dBu...	2.51 dBuV...	-15.5 dBu...	
<input type="checkbox"/>	3	B	820.012 MHz	4.42 dBuV...	-13.6 dBu...	-- dBuV/m	-- dBuV/m	-- dBuV/m	-- dBuV/m	

Measurements

There are three Measurement settings:

Pre-scan + Manual Spot

Select to perform a scan with the chosen detector(s) for the selected ranges. The scan will populate the Emission Results table with Spots (frequency peaks that are above Threshold or Limit lines). The application then waits for you to select Spots from the Emission Results table for Re-measurement.

This measurement type is useful for Standard recommended detectors that require longer measurement/dwell time. A quick Pre-scan with Peak detector can be done in such cases. As a second step, Spots (frequencies that fail Threshold or Limit lines) can be chosen for re-measurement with detectors recommended by the Standard. For example, if the Standard recommends usage of CISPR QP and CISPR Avg detectors, then a pre-scan is performed CISPR +Peak. After the scan, you can choose the Spot(s) for performing Spot Re-measurement using CISPR QP and CISPR Avg detectors (max 3 detectors). The RBW for Spot measurement is chosen based on the ranges and limits set for the scan.

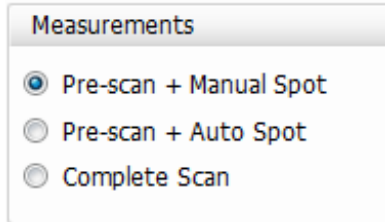

The screenshot shows a dialog box titled "Measurements" with three radio button options. The first option, "Pre-scan + Manual Spot", is selected with a blue dot. The other two options, "Pre-scan + Auto Spot" and "Complete Scan", are unselected.

Pre-scan + Auto Spot

Select to perform a scan with the chosen detector(s) for the selected ranges. The scan will populate the Emission Results table with Spots (frequency peaks that are above Threshold or Limit lines). The application then automatically triggers a Spot re-measurement for the number of Spots chosen by you. You can control the number of spots to be automatically re-measured under Max Spots, which is visible only when Pre-scan + Auto Spot is selected.

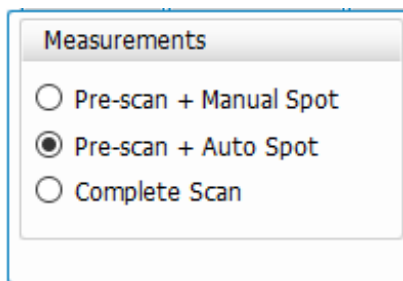

The screenshot shows a dialog box titled "Measurements" with three radio button options. The second option, "Pre-scan + Auto Spot", is selected with a blue dot. The other two options, "Pre-scan + Manual Spot" and "Complete Scan", are unselected.

Complete Scan

Performs a scan using detector(s) specified by you. You can also choose to load the detector choice from a Standard by clicking the **Load from Standard** button located on the far left side of the Ranges & Limits tab (above the Restore Defaults button) in the EMC Settings control panel. You can also access this button on the Ranges & Limits tab in the EMC Project Setup Wizard.

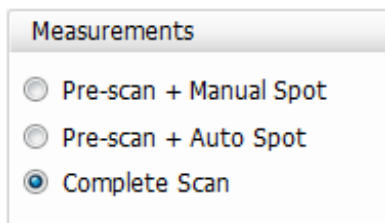

The screenshot shows a dialog box titled "Measurements" with three radio button options. The third option, "Complete Scan", is selected with a blue dot. The other two options, "Pre-scan + Manual Spot" and "Pre-scan + Auto Spot", are unselected.

When the detector choices are loaded from the standard, Complete Scan will show the actual detectors recommended by the standard and the results will be compared against appropriate limit lines. When the Pre-scan measurement type is chosen, a first scan is done with Peak detector and the actual detectors recommended by the standard and the corresponding limit lines are set in the Spot Measurement setup.

Although you are free to change the detector choice after choosing a measurement type (Pre-scan +Manual Spot, Pre-scan + Auto Spot, and Complete Scan), changing the measurement type will re-load the detectors recommended by the standard, and a detector you added will not be remembered. For example, assume the standard recommends only CISPR QPk for Complete Scan and you choose to add an additional detector in CISPR Avg. If you then change to Pre-scan mode, and then change back to Complete Scan mode, the detector choice will be CISPR QPk, because that is the detector recommended by the standard. Your addition of CISPR Avg is not remembered when the measurement mode is changed.

However, when a setup file is saved, or a project file is saved in EMC Project Setup Wizard, only the detector choices of the chosen measurement type are saved.

Scan Settings

The following settings are available in the Scan Settings area of the Measurement Type tab.

Scan Setup

Detector 1 CISPR QPk Limit: Limit1

Detector 2 CISPR Avg Limit: Limit2

Dwell Time: 2.0 s Auto

Setting	Description
Detector	<p>Set the detection method using the drop down list. This will be loaded automatically when Load from Standard is chosen from the Ranges & Limits tab of the EMC Settings control panel or EMC Project Setup Wizard.</p> <p>Available detection methods are:</p> <p>Avg(VRMS), + Peak, MIL +Peak, DEFSTAN Avg, CISPR QPk, CISPR Pk, CISPR Avg, Avg (of logs), and CISPR Avg (of logs).</p>
Limit	<p>Set the limit lines (drop down list shows enabled limit lines) that will be used for comparison for the chosen detector result. As many as 3 limit lines can be defined in the Ranges & Limits tab of the EMC Settings control panel or EMC Project Setup Wizard.</p> <p>When ranges and limits are loaded from a Standard, the Standard typically recommends separate limit lines for each detector type. The limit lines that are loaded as Limit 1/2/3 are mapped to the appropriate detector here.</p> <p>You can also customize your own limit line into one of the three limit lines available and map it to a detector from the drop down for limit lines here.</p>
Dwell Time	Shows the duration of the measurement. When the Auto check box is checked, it sets the Dwell Time automatically based on detector choice.

Spot Measurement Setup

The following settings are available in the Spot Measurement Setup area of the Measurement Type tab.

Spot Measurement Setup

Detector 1 CISPR QPk Limit: Limit1

Detector 2 CISPR Avg Limit: Limit2 Dwell Time: 2.0 s Auto

Detector 3 CISPR QPk Limit: Limit1 Max Spots: 10 All

Setting	Description
Detector	<p>Set the detection method using the drop down list. This will be loaded automatically when Load from Standard is chosen from the Ranges & Limits tab of the EMC Settings control panel or EMC Project Setup Wizard.</p> <p>Available detection methods are:</p> <p>Avg(VRMS), + Peak, MIL +Peak, DEFSTAN Avg, CISPR QPk, CISPR Pk, CISPR Avg, Avg (of logs), and CISPR Avg (of logs).</p>
Limit	<p>This is the same limit as for Scan Setup, but it is used for Spot re-measurement comparison. You can set the limit lines (drop down list shows enabled limit lines) that will be used for comparison for the chosen detector result. As many as 3 limit lines can be defined in the Ranges & Limits tab of the EMC Settings control panel or EMC Project Setup Wizard.</p> <p>When ranges and limits are loaded from a Standard, the Standard typically recommends separate limit lines for each detector type. The limit lines that are loaded as Limit 1/2/3 are mapped to the appropriate detector here.</p> <p>You can also customize your own limit line into one of the three limit lines available and map it to a detector from the drop down for limit lines here.</p>
Dwell Time	Shows the duration of the measurement. When the Auto check box is checked, it sets the Dwell Time automatically based on detector choice.
Max Spots <i>(Only available when Pre-scan + Auto Spot is selected)</i>	<p>Specifies the maximum number of top Spots in the Emission Results table (resulting from a scan) that will be selected for re-measurement.</p> <p>Check the All check box to include all Spots in the Emission Results table for re-measurement.</p>

Traces tab — EMC

Favorites toolbar:

This tab is available for the EMC-EMI display from the EMC Settings control panel. It provides information and controls for the trace results from Scan and Re-measure Spot measurement results. It provides controls for live traces, recalled traces, and Math trace.

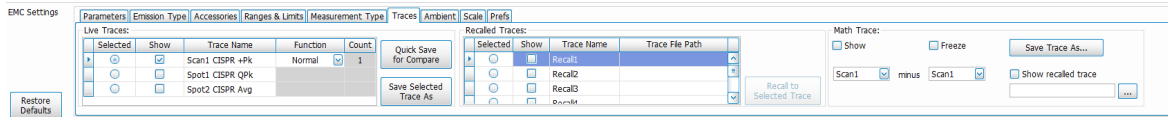

Setting	Description
Live Traces	Traces shown here are the trace results for the last Scan or re-measure Spot measurements.
Selected	Selecting a trace makes it the active trace. The active trace shows on the top of the graph and is useful when there are multiple traces viewed together. You can also select a trace from the top of the EMC-EMI display.

Table continued...

Setting	Description
Show	Shows / hides the selected live trace.
Trace Name	Specifies the name of the trace. For live traces, these names are set by appending the detector choice with the measurement (Scan vs Spot based on whether scan is done or Re-measure Spot is done). The number after Scan or Spot is based on the number of detectors chosen for Scan and Re-measure spot measurements in the Measurement Type tab of the EMC Settings control panel.
Function	Specifies the function performed on the trace. Applicable only for scan trace in Live Traces.
Count	Specifies the count value for Function when Function is not Normal (Max Hold, Average etc.). When Function is Normal, this control is not editable because the Count is 1.
Quick Save for Compare	<p>Click this button to automatically save the selected Live Trace in your drive and recall it into one of the rows in Recalled Traces, depending on which one is free. The search is done from Recall1 through Recall 5, in that order. There will be a timed pop-up message indicating the Recall trace in which it is available for comparison.</p> <p>If none of the Recalled traces are free, then clicking this button will save the trace in your drive and recall the trace as Recall 1 (replacing the earlier recalled trace in Recall 1). However, the files replaced can be browsed for and recalled using the Recall to Selected Trace function. All traces saved with this button are saved in the C:\SignalVu-PC Files directory.</p> <p>See the Compare Traces on page 444 topic for additional information.</p>
Save Selected Trace As	Saves the selected live trace to a file for later recall and analysis. This button is active only when a live trace is selected and saved.
Recalled Traces	
Selected	<p>Selecting a trace makes it the active trace. The active trace shows on the top of the graph and is useful when there are multiple traces viewed together.</p> <p>The Emission Results table will be populated with Spots based on the comparison of the selected recalled trace with Limit 1.</p>
Show	Shows / hides the selected recalled trace.
Trace Name	Shows the name of the saved trace.
Trace File Path	Shows the path of the saved trace file to be recalled.
Recall to Selected Trace	Recalls the trace for analysis into the Recalled Traces table.
Math Trace on page 475	
Show	Shows / hides the selected Math trace.
Freeze	Halts updates to the Math trace.
Save Trace As	Saves the selected trace to a file for later recall and analysis.
Table continued...	

Setting	Description
Show recalled trace	Displays a saved Math trace instead of a live trace. When a Math trace is recalled, controls such as Show, Freeze and selections of traces for Math will be disabled.
Trace selections for Math	The Math trace is the result of subtracting one trace from another. Choose the traces for the difference operation from the two drop down menus. Trace 1 – Trace 2 is performed at every trace point.

Save a live trace

Live Traces:

	Selected	Show	Trace Name	Function	Count
	<input checked="" type="radio"/>	<input checked="" type="checkbox"/>	Scan1 CISPR +Pk	Normal	1
	<input type="radio"/>	<input type="checkbox"/>	Spot1 CISPR QPk		
	<input type="radio"/>	<input type="checkbox"/>	Spot2 CISPR Avg		

Quick Save for Compare

Save Selected Trace As

To save a live trace for later analysis:

1. Select the **Save Selected Trace As** button. This displays the Save As dialog box.
2. Navigate to the desired folder or use the default.
3. Type a name for the saved trace and click **Save**.

Recalling Traces

You can recall a previously saved trace for analysis or comparison to a live trace. To select a trace for recall:

1. Select a trace from the Recalled Traces table in the Traces tab and check the **Show** check box next to it. This will be the trace to which you will recall a previously saved trace.

Recalled Traces:

	Selected	Show	Trace Name	Trace File Path
	<input checked="" type="radio"/>	<input checked="" type="checkbox"/>	Recall1	C:\Scan1 CISPR +Pk-201...
	<input type="radio"/>	<input type="checkbox"/>	Recall2	
	<input type="radio"/>	<input type="checkbox"/>	Recall3	
	<input type="radio"/>	<input type="checkbox"/>	Recall4	

Recall to Selected Trace

2. Click the **Recall to Selected Trace** button to display the Open dialog box.
3. Navigate to the desired file or use the default.
4. Select the appropriate trace to be opened and click **Open**.
5. The recalled trace will be plotted on the graph and comparison with Limit 1 will be done. Results will be shown in the Emission Results table.

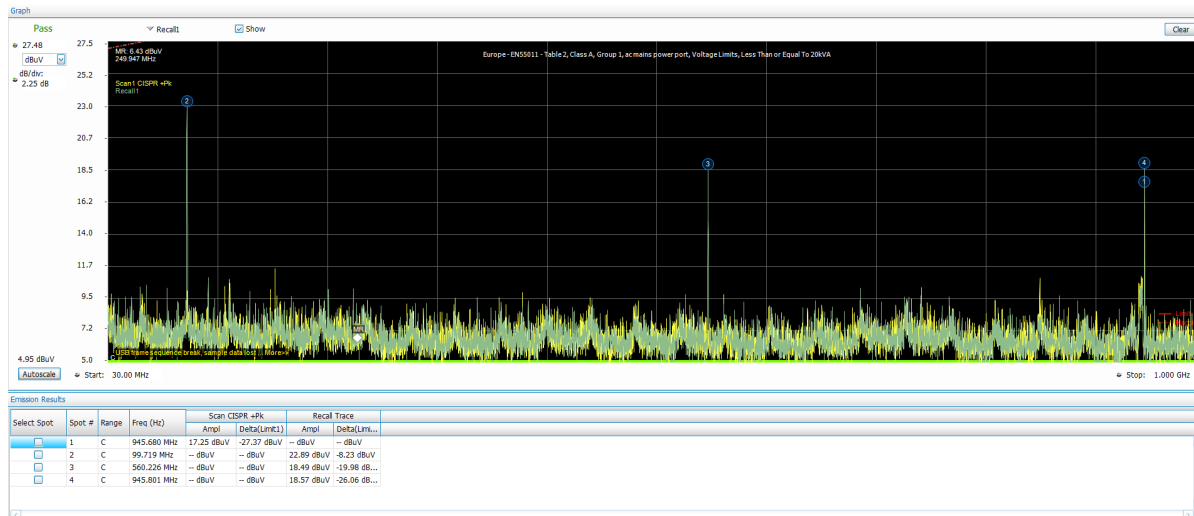

Math Trace

The Math trace is a mathematically-derived trace defined as the difference between two traces. You can select the two traces for the difference calculation from the Live Traces, Recalled Traces, and the Ambient Traces.

1. Select any trace from the two drop-down lists provided. Traces can either be live Scan traces, any of the 5 recalled traces, or an Ambient trace.

The difference between the two traces will be derived from the operation Trace1 minus Trace 2.

Math Trace:

Show Freeze

 Show recalled trace

2. Check the **Show** check box to set the Math trace as the active trace on the graph. You can also check the Freeze check box to halt updates of the trace on the graph.
3. Save the Math trace to a file using the **Save Trace As** button.
4. A saved trace can be recalled for analysis as follows:
 - a. Click the ... button.

Show recalled trace

- b. Navigate to the desired file and click Open. The path will appear in the field next to the
- c. Check the **Show recalled trace** check box to show the recalled trace. When a trace is recalled under Math, controls such as Show, Freeze, and selections of traces for Math will be disabled.

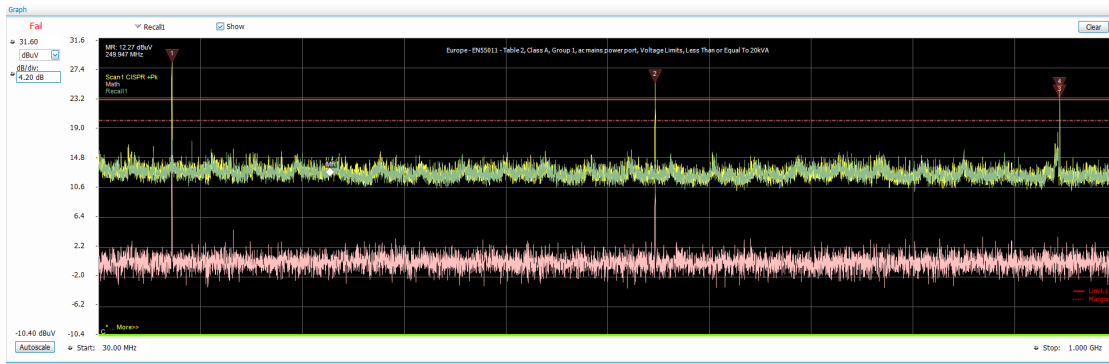

- The Math function is done for each range set in the Ranges & Limits tab of the EMC Settings control panel.
- If the span or trace points for any range does not match, then an error message will appear for Math traces. For example:
 - “No Math trace: Unmatched trace X range”
 - “No Math trace: Unmatched trace lengths”
- The Math trace is done only for log units in Y axis and the difference trace is calculated by mere subtraction of the dB values.

 **Tip:** See the [Compare Traces](#) on page 444 topic for more information about using traces for [EMC Troubleshooting](#) on page 439.

Ambient tab - EMC

Favorites toolbar:

This tab is available for the EMC-EMI display from the EMC Settings control panel. It provides settings related to the Ambient measurement and Ambient trace control. These settings only apply to measurements performed when **Measure Ambient** is clicked from the EMC related items on the Favorites toolbar (or **Setup > EMC > Measure Ambient**). This measurement is useful for capturing emissions caused by the environment or the spectrum analyzer equipment.

EMC Settings

Parameters | Emission Type | Accessories | Ranges & Limits | Measurement Type | Traces | Ambient | Scale | Prefs

Show Freeze Save Trace As... Dwell Time: 10 ms Auto



Detection: CISPR +Pk Show recalled trace Delta Threshold: 5.0 dB

Function: Normal ...

Restore Defaults

Setting	Description
Show	Shows / hides the ambient trace in the graph. Also controls the visibility of the ambient results in the Emission Results table (Amplitude and Delta values). See the Measure ambient on page 433 topic for more information about ambient results and how to perform a scan.
Freeze	Halts updates to the ambient trace.

Table continued...

Setting	Description
Detection	<p>Sets the detection method. Ambient trace comparison results with Scan will not be shown in the Emission Results table if the detector type of Ambient and Scan do not match.</p> <p>Available detection methods are:</p> <p>Avg(VRMS), + Peak, MIL +Peak, CISPR QPk, CISPR Pk, CISPR Avg, Avg (of logs), CISPR Avg (of logs).</p> <p> Note: The MDO4000B/C Series instruments do not support CISPR detectors.</p>
Function	<p>Selects the ambient trace processing method. Available settings are: Normal, Max Hold, Avg (VRMS), and Avg (of logs).</p>
Count	<p>Sets the number of traces averaged to generate the displayed trace. Only available when Function is set to anything other than Normal. When Function is Normal, this control is not editable because the count is 1.</p>
Save Trace As	<p>Saves the selected ambient trace and selected detector to a file for later recall and analysis. Traces are saved along with the selected detector for help in comparing Scan trace with Ambient trace</p> <p>A save performed from the Traces tab saves only the trace. The detector type is not saved.</p>
Show recalled trace	<p>Shows the recalled ambient trace information and the saved selected detector. When this check box is checked, the detection control is loaded with the saved detector result and is not available for selection. Function, Freeze, and Dwell Time controls are also disabled when Show recalled trace is selected.</p> <p>Traces that were saved from the Traces tab can also be recalled into the Ambient tab. However, those recalled traces will not contain saved detector selections. In these cases, you must manually select the detector type before recalling such a trace.</p>
Dwell Time	<p>Shows the duration of the measurement. When the Auto check box is checked, it sets the Dwell Time automatically based on the frequency range set in the Ranges & Limits tab of the EMC Settings control panel.</p> <p> Note: Dwell Time limitations are instrument dependent.</p>
Delta Threshold	<p>Shows the threshold difference. If the absolute difference between a Scan trace and an Ambient trace is less than the Delta Threshold, then those Spot Ambient results are shown in blue. This threshold setting allows you to <i>quickly check</i> if the peaks/spots obtained are due to ambient interference or the equipment.</p>



Tip: See the [Measure ambient](#) on page 433 topic for more information about ambient measurements.

Scale tab — EMC

Favorites toolbar:

This tab is available for the EMC-EMI display from the EMC Settings control panel. It allows you to change the vertical and horizontal scale settings. Changing the scale settings changes how the trace appears on the display but does not change control settings such as Center Frequency. In effect, these controls operate like pan and zoom controls.

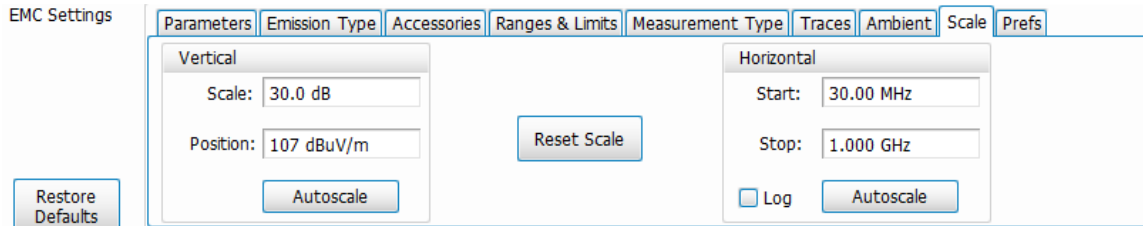

Setting	Description
Vertical	Controls the vertical scale and position of the trace display.
Scale	Changes the vertical scale units. It is 10* dB/div setting on the display.
Position	Sets the value for the top of the display.
Autoscale	Resets the scale of the vertical axis to contain the complete trace.
Horizontal	
Start	Sets the Zoom Start frequency. This only affects the start frequency shown on the graph.
Stop	Sets the Zoom Stop frequency. This only affects the stop frequency shown on the graph.
Log	Sets the display to show the frequency axis in a logarithmic scale. The Limit lines are also interpolated with x-axis in Log scale when this is selected.
Autoscale	Resets the scale of the horizontal axis to contain the complete trace.
Reset Scale	Resets all settings to their default values.

Prefs tab — EMC

Favorites toolbar:

This tab is available for the EMC-EMI display from the EMC Settings control panel. It allows you to change the parameters of the EMC-EMI display.

Parameters	Emission Type	Accessories	Ranges & Limits	Measurement Type	Traces	Ambient	Scale	Prefs
<input checked="" type="checkbox"/> Show Limit Legends and Label	Trace points: 8001 (per Range)	<input checked="" type="checkbox"/> Include Margin (Pass/Fail Status)	<input checked="" type="checkbox"/> Show Setup Wizard on EMC-EMI display startup					
<input checked="" type="checkbox"/> Show graticule	<input checked="" type="checkbox"/> Show Marker readout in graph (selected marker)	<input checked="" type="checkbox"/> Show Spot Indicator						
<input checked="" type="checkbox"/> Show trace legend	Show limits: Line only	<input checked="" type="checkbox"/> Show Level Target	To Peak					

Setting	Description
Show Limit Legends and Label	Shows or hides limit legends and label. Label can be edited in the Ranges & Limits tab.
Show graticule	Shows or hides the graticule in the display.
Show trace legend	Shows or hides the trace legend.
Trace points (per Range)	Sets the number of trace points used for showing scan results. Default value is 8001.
Show Marker readout in graph (selected marker)	Shows or hides the readout for the selected marker in the graph area.
Show Limits	Set how limits are shown: Shaded: Shows limits using a shaded area. Line Only: Shows limits using only a line. Off: No lines or shading are used to indicate limits in the graph.
Include Margin (Pass/Fail Status)	Sets Pass/Fail status to be based on Limit line with margin and not just Limit line.
Show Spot Indicator	Three types of Spot indicators are there (based on whether a Spot violates limit lines, limit lines with margin, or just threshold).
Show Level Target	Shows or hides Level Target in the EMC-EMI display.
To Peak	Sets the Level target at peak of the trace. <i>(Only available when Show Level Target is enabled)</i>
Show Setup Wizard on EMC-EMI display startup	Shows or hides the EMC Project Setup Wizard when launching the EMC-EMI display.

APCO P25 Analysis

P25 Overview

The Association of Public Safety Communication Officials (APCO) P25 Compliance Testing and Analysis option allows you to evaluate radio signals to ensure they meet the standards set for the public safety communications community for interoperable LMR equipment. This complete set of push-button Telecommunication Industry Association TIA-102 standard-based transmitter measurements includes modulation measurements, power measurements, and timing measurements. These measurements are also compared with the limits that best fit the signal for which the standard applies to provide pass/fail results.

The P25 measurements available with this option can be made on signals defined by the Phase 1 (C4FM) and Phase 2 (HCPM, HDQPSK) P25 standards. With this test suite, test engineers can simplify the execution of a number of transmitter tests while still allowing for controls to modify signal parameters for signal analysis. The analysis results give multiple views of P25 signal characteristics to allow the diagnosis of signal imperfections and impairments quickly and easily. Display controls allow you to selectively display the analysis results to help locate trouble-spots in the signal.

P25 Topics

The following information about the P25 Analysis option is available:

- [Reference Table of Supported P25 Measurements](#)
- [P25 Standards Presets](#) on page 481
- [P25 Displays](#) on page 482
- [P25 Settings](#)
- [P25 Measurements](#) on page 482
- [P25 Test Patterns](#) on page 488

Reference Table of Supported P25 Measurements

TIA-102 transmitter measurement	Tektronix measurement display(s) (value name if different from TIA-102 measurement name)	Phase 1	Phase 2
RF output power	P25 Summary P25 Power vs Time	Yes	Yes
Operating frequency accuracy	P25 Summary (Operating Freq Accuracy)	Yes	Yes
Modulation emission spectrum	SEM (The SEM display can be found in Select Displays > RF Measurements)	Yes	Yes
Unwanted emissions: Non spurious adjacent channel power ratio	MCPR (The MCPR display can be found in Select Displays > P25 Analysis)	Yes	Yes
Frequency deviation	P25 Summary (Freq Dev)	Yes	HCPM
Modulation fidelity	P25 Summary P25 Constellation	Yes	Yes
Symbol rate accuracy	P25 Summary	Yes	Yes

Table continued...

TIA-102 transmitter measurement	Tektronix measurement display(s) (value name if different from TIA-102 measurement name)	Phase 1	Phase 2
Transmitter power and encoder attack time	P25 Summary (Phase1 Tx Attack Time) P25 Power vs Time (Power Attack Time and Encoder Attack Time)	Yes	N/A
Transmitter power and encoder attack time with busy/idle operations	P25 Summary (Phase1 Tx Attack Time (Busy/Idle)) P25 Power vs Time (Power Attack Time Busy Idle and Encoder Attack Time Busy Idle)	Yes	N/A
Transmitter throughput delay	P25 Summary (Phase1 Tx Throughput Delay)	Yes	N/A
Transient frequency behavior	P25 Freq Dev vs. Time	Yes	N/A
HCPM transmitter logical channel peak adjacent channel power ratio	P25 Summary (HCPM Tx Logic Ch Pk ACPR)	N/A	HCPM
HCPM Transmitter logical channel off slot power	P25 Power vs Time (Off Slot Power) P25 Summary (HCPM Tx Logic Ch Off Slot)	N/A	HCPM
HCPM Transmitter logical channel power envelope	P25 Power vs Time (Power Info) P25 Summary (HCPM Tx Logic Ch Pwr Env Limits)	N/A	HCPM
HCPM Transmitter logical channel time alignment	P25 Summary (HCPM Tx Logic Ch Time Alignt)	N/A	HCPM

P25 Standards Presets

The P25 standards preset allows you to access displays preconfigured for the P25 standards you select. You can read more about how Presets work [here](#).

The following table shows the bandwidth, modulation type, and displays that are automatically loaded for each of the listed standards. MCPR masks are also loaded and are explained [here](#).

Table 24: P25 standards, modulation type, bandwidth, and displays

Standard	Modulation type	Bandwidth (kHz)	Displays loaded with preset
Phase 1	C4FM	12.5	MCPR, Time Overview, P25 Constellation, P25 Summary
Phase 2	HCPM (inbound)	12.5	MCPR, Time Overview, P25 Constellation, P25 Summary
	HDQPSK (outbound)	12.5	

Retain Current Center Frequency

This setting becomes available when P25 is the selected preset in the Standards Preset window. You can access this window by selecting **Presets > Standards** and then selecting **P25** from the **Preset** drop down menu. To activate the **Retain current Center Frequency Setting**, check the box. This setting allows you to retain the previously used center frequency. By default, the box is unchecked and therefore the four P25 preset displays will load with a center frequency of 850 MHz.

The default adjacent channels table for MCPR is different for RF frequencies in the range of 769 to 806 MHz (called 700 MHz band) and for frequency ranges outside it. The option of retaining center frequency in Standards Preset is therefore useful if you want to load the default table for center frequencies in the 700 MHz band.

MCPR channel and limit parameters. The MCPR (ACPR) standard channel and limit parameters that are applied to the P25 signal depend on the standard you select when you configure the preset. Once you select a standard and center frequency, the application will automatically load the parameters and default limits recommended for best performance comparison by the Standard document. All channel and limit parameters are derived from the TIA-102 standard and loaded for you. This provides you the assurance that you are evaluating the signal with the most appropriate parameters.



Note: Changing analysis and display parameters recalculates the measurement results, but does not affect acquisitions.

P25 Displays

The displays in P25 Analysis (Setup > Displays > Measurements: P25 Analysis) are:

- [MCPR](#)
- [P25 Constellation](#)
- [P25 Power vs Time](#)
- [P25 Eye Diagram Display](#)
- [P25 Frequency Dev Vs Time](#)
- [P25 Symbol Table](#)
- [P25 Summary](#)
- [Time Overview](#)

P25 Measurements

The following topics contain important information you should know about specific P25 measurements.

RF Output Power (Phase 1 and Phase 2)

This is a measure of RF output power when the transmitter is connected to the standard load during defined duty cycle. This measurement is presented as a scalar result in the P25 Summary display. Power variation is shown in the P25 Power vs Time display.

Information of note about this measurement:

- For bursty HCPM (Phase 2 Inbound) signals, the RF Output Power is measured only during the on slot regions centered at the middle of the on slot.
- The result shown in the P25 Summary Display is the average RF Output Power of all the bursts selected in the analysis window.
- If only one on slot region is chosen in the analysis window, then the RF Output Power of only the chosen on slot is reported.
- For non-bursty data, the entire duration of analysis window is considered to obtain RF Output Power.
- The result shown in the P25 Summary display does not account for any attenuation introduced by a user. Ensure that this attenuation is accounted for when you enter limits for comparison.
- The Limits tab in the P25 Summary Settings control panel allows you to compare the results against limits set for Pass/Fail.
- This measurement result is not shown in the P25 Summary display when Trigger Measurements are selected.



Note: Read about important information related to HCPM bursty data measurements [here](#).

Operating Frequency Accuracy (Phase 1 and Phase 2)

The Operating Frequency Accuracy is the ability of the transmitter to operate on its assigned frequency. This measurement is presented as a scalar result in the P25 Summary display.

- For bursty HCPM (Phase 2 Inbound) signals, the operating frequency accuracy is measured only during the on slot regions centered at the middle of the on slot.
- The result shown in the P25 Summary display is the average of all the bursts selected in the analysis window.
- If only one on slot region is chosen in the analysis window, then the operating frequency accuracy of only the chosen on slot is reported.
- For non-bursty data, the entire duration of the analysis window is considered to obtain the operating frequency accuracy.
- The Limits tab in the P25 Summary Settings control panel allows you to compare the results against limits set for Pass/Fail.

In Operating Frequency Error, double sided operating frequency error is converted to one sided error and compared against the Absolute Limit.

- This measurement result is not shown in the P25 Summary display when Trigger Measurements are selected.

Unwanted Emissions (ACPR) (Phase 1 and Phase 2)

This measurement is the ratio of the total power of a transmitter under prescribed conditions and modulation to that of the output power that falls within a prescribed bandwidth centered on the nominal frequency of adjacent channels. This measurement is shown in the MCPR display.

- For HCPM signals, Adjacent Channel Power Ratio analysis is only done on the first on slot region. When the Modulation Type is set to HCPM from any P25 display or from Standards Presets, there will be a search for bursts before ACPR analysis is done. If a burst is found, then analysis is done only on first burst. If a burst is not found, it will show the results of the entire analysis length. The Main Preset will remove the HCPM modulation Type setting, allowing MCPR to work in its regular mode.
- The MCPR display will only have one Main channel for P25 signals in addition to relevant adjacent channels.
- The default adjacent channels table for Unwanted Emissions (ACPR) as suggested by the standard can be loaded by using the P25 Standards Preset option (for which MCPR is one of the four displays).
- The default adjacent channels table for MCPR is different for RF frequencies in the range of 769 to 806 MHz (called 700 MHz band) and for frequency ranges outside it.
- To load the default adjacent channels table of a 700 MHz band, first set the center frequency. Next, select **Presets > Standards** to view the Standards Preset window. Lastly, check the **Retain current Center Frequency Setting** box.
- By default, the Retain Center Frequency box is unchecked and therefore the four P25 preset displays will load with a center frequency of 850 MHz and load the adjacent channels table for non-700 MHz band.
- By default, only six adjacent channels (on either side) will be shown when 700 MHz band is analyzed in P25 (for visual clarity). However, analysis is done for all the ten channels and results will be available in the table just under the display. You can zoom out to see the remaining bands.

Frequency Deviation (Phase 1 (C4FM) and Phase 2 (HCPM))

This measurement shows the amount of frequency deviation that results for a Low Deviation and High Deviation test pattern. This measurement is shown in the P25 Summary display.

- This measurement only applies to HCPM and C4FM signals and High Deviation or Low Deviation test patterns. If this measurement is run for any other test patterns or for HDQPSK signals, comparisons for limits (set in the Limits tab of the control panel) will result in N/A being shown, as the measurement will not be valid.
- This measurement is done using a FM demodulator without any filter. As a result, it will not be exactly the same as the result given in the P25 Frequency Deviation vs Time display. That display shows the frequency deviation after complete demodulation and might use relevant shaping filters.
- The Low pass filter cut off frequency can be set from the Analysis Params tab of the Settings Control panel. The default value of the cut off frequency is 5 kHz.
- Measurement results are only available when High Deviation, Low Deviation, or Symbol Rate test pattern is selected.
- The scalar result in the P25 Summary display will be shown as f1 (Positive Peak) and f2 (Negative Peak) when analyzing the High Deviation test pattern (or the Symbol Rate test pattern for C4FM signals).
- The scalar result in the P25 Summary display will be shown as f3 (Positive Peak) and f4 (Negative Peak) when analyzing the Low Deviation test pattern.
- The scalar results in the P25 Summary display do not have a corresponding graphical view. A closely representative display would be the FM display (Setup > Displays > Analog Modulation).
- The Limits tab in the P25 Summary Settings control panel allows you to compare the results against limits set for Pass/Fail.

Modulation Fidelity (Phase 1 and Phase 2)

This measures the degree of closeness to which the modulation follows the ideal theoretical modulation determined by the rms difference between the actual deviation and the expected deviation for the transmitted symbols. This measurement is shown in the P25 Summary and P25 Constellation displays.

- This measurement is done on the first on slot region in the analysis window for bursty HCPM data. The analysis is done on 160 symbols centered at the burst.
- This measurement is done on all of the data chosen in the analysis window for non-bursty modulation types. A warning message is issued if the data is less than 164 symbols (the standard recommends at least 164 symbols be present for the measurement of non-bursty signals).
- This measurement is done by performing the frequency demodulation after taking the signal through relevant shaping filters and comparing it with expected frequency deviation points.
- The Limits tab in the P25 Summary Settings control panel allows you to compare the results against limits set for Pass/Fail.
- This measurement result is not shown in the P25 Summary display when Trigger measurements are selected.
- HDQPSK-P25 filter attempts to remove the Inter Symbol Interference before symbol detection.



Note: Read about important information related to HCPM bursty data measurements [here](#).

Symbol Rate Accuracy (Phase 1 and Phase 2)

Symbol Rate Accuracy measures the ability of the transmitter to operate at the assigned symbol rate (4.8 kHz for Phase 1, 6 kHz for Phase 2). It is a scalar result shown in the P25 Summary display.

- This measurement result appears in the P25 Summary display and only applies to High Deviation or Low Deviation test patterns. Test patterns are selected in the Test Patterns tab in the Settings control panel.
- The Limits tab in the P25 Summary Settings control panel allows you to compare the results against limits set for Pass/Fail.
- This measurement only applies to High Deviation or Low Deviation test patterns. If this measurement is run for any other test patterns, comparisons for limits will result in N/A being shown, as the measurement will not be valid.

Common Trigger Related Measurements

The measurements covered in this subsection have some common information. These measurements are:

- **Transmitter Power and Encoder Attack Time (Phase 1):** This measurement is the time required for a transmitter to prepare and transmit information on the radio channel after changing state from standby to transmit (applies to conventional mode). This measurement result can be seen in the P25 Summary display. A graphical representation of these results can be seen in the P25 Power vs Time display.
- **Transmitter Power and Encoder Attack Time with Busy/Idle Operations (Phase 1):** This measures the time required for a transmitter to prepare and transmit information on the radio channel after the receiving channel changes state from busy to idle. Transmission is inhibited until a status symbol indicates an idle channel. This measurement result can be seen in the P25 Summary display. A graphical representation of these results can be seen in the P25 Power vs Time display.
- **Transmitter Throughput Delay (Phase 1):** This measures the time it requires for audio changes in the microphone to be encoded and transmitted over the air. A calibrated receiver with a known receiver throughput delay is used to monitor the transmitted signal. The aggregate delay of the transmitter under test and calibrated receiver is measured and the desired transmitter throughput delay is then the aggregate delay less the delay of the calibrated receiver. A calibrated Receiver throughput delay from the UI is needed. This measurement result can be seen in the P25 Summary display.
- **Transient Frequency Behavior (Phase 1):** This is a measure of difference of the actual transmitter frequency and assigned transmitter frequency as a function of time when the RF output power is switched on or off. This measurement appears in the P25 Freq Dev vs Time display.
- **HCPM Tx Logical Channel Time Alignment (Phase 2 HCPM):** This measures the ratio of total transmitter power under prescribed conditions and modulation to the peak power that falls in a prescribed bandwidth centred on the nominal frequency of the adjacent channel during the transmitter power ramping interval. This applies only to inbound signals. This measurement result appears in the P25 Summary display.



Note: The following information is important when trigger measurements are taken with SignalVu-PC interfaced with an RSA306B, RSA500A Series, RSA600A Series, RSA7100, or MDO4000B/C Series instrument: 1) The RF signal should be connected to the RF Input of the instrument. 2) For the MDO, one of the 4 analog channels can be set as Trigger input. (Refer to the Trigger Setup section on how to set a channel as trigger in the MDO manual.) 3) In SignalVu-PC, set Triggered mode in the Setup > Acquisition control panel.

Common information. The following information applies to all of the measurements in the previous list.

- Select the relevant Trigger measurement from the Trig Meas tab of the control panel.
- When this measurement is chosen from the Trig Meas tab of the control panel, only this result will be populated in the P25 Summary display and everything else will have no result.
- The Time Zero Reference under the Analysis Time tab in the control panel is forced to Trigger.
- Align the Trigger to the RSA/MDO4000B/C as described in the measurement methods standard document.
- When a trigger measurement is chosen from the Trig Meas tab of the control panel, the following status message will appear: *P25: Set instrument in Triggered Mode.*
- Use the Acquisition control panel to select enough acquisition length to ensure that sufficient data is available when the acquisition is triggered.
- This measurement operates in Single Acquisition mode as the acquisition is triggered.
- You can select to do the same experiment multiple times and this measurement will produce an average result of the last 10 single acquisitions. Clicking the **Clear** button on the P25 Summary display will clear the results and start a new measurement.

Transmitter Power and Encoder Attack Time and Transmitter Power and Encoder Attack Time with Busy/Idle Operations (Phase 1). The following information is specific to these two measurements.

- The Transmitter Power Attack Time analysis is done by measuring the time taken from the trigger point to the point where the transmitter output power will reach 50% of its maximum value.
- For Encoder Attack Time, the initial frame synchronization word is searched in the demodulated output and the time taken from trigger to the start of the synchronization word is reported as the result.

- When a clear power ramp up is not available, the analysis will report the following error, indicating that no power ramp was received as expected: *Input data too short*. When the synchronization word is not found, the analysis will report the following error: *IQ Processing error*.
- The Limits tab in the P25 Summary Settings control panel allows you to compare the results against limits set for Pass/Fail.
- The P25 Power vs Time display shows marking from trigger point to 50% ramp point and also up to the Synchronization word for Transmitter Power and Encoder Attack Time. Frequency Dev vs Time can also be used to check for the synchronization word. The following image shows this measurement.

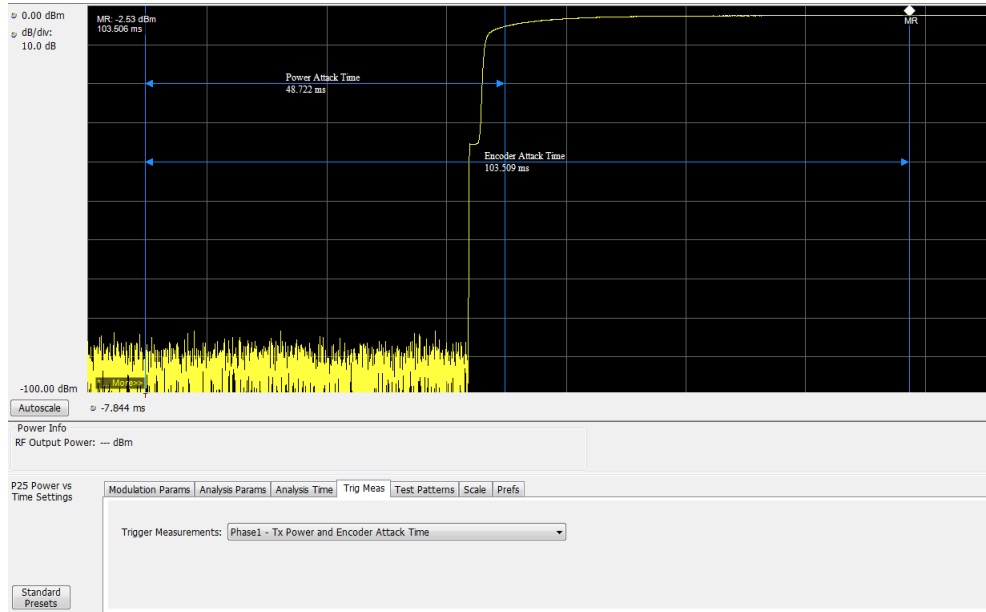

Transmitter Throughput Delay (Phase 1). The following information is specific to this measurement.

- Select Tx Throughput Delay from the Trig Meas tab of the Settings control panel to get this measurement.
- The original noise source is connected as input to this trigger and the acquisition is triggered when the input from the noise source exceeds the trigger level set by the user.
- The actual input to the RSA/MDO4000B/C comes after the noise signal from the source has passed through the DUT and calibrated receiver as shown in the setup for this measurement in the measurement methods standard document.
- The level in the Trigger control panel set by the user is used for analysis to determine that input to the RSA/MDO4000B/C (after it has gone through the DUT and calibrated receiver) has hit the power levels desired.
- The time difference between the trigger point and the point when the input to the RSA/MDO4000B/C has exceeded the level set by the user for triggering is calculated.
- The calibrated receiver throughput delay entered by the user in the Trig Meas tab in the Settings control panel (this option appears when Throughput Delay is selected) is subtracted from the calculated time difference and reported as Throughput Delay.
- A limit comparison can be performed by selecting the appropriate limits from the Limits tab in the Settings control panel.

Transient Frequency Behavior (Phase 1). The following information is specific to this measurement.

- Select Transmitter Frequency Behavior from the Trig Meas tab of the Settings control panel to get this measurement.
- This measurement can be done for On to Off and Off to On behaviors. Select which behavior to measure by selecting the desired behavior from the Transient Frequency drop down list that appears when the Transient Frequency Behavior measurement is selected in the Trig Meas tab of the Settings control panel.
- Select enough acquisition length (from the Acquisition control panel) to ensure that sufficient data is available when the acquisition is triggered. For a transient frequency behavior, there is a need for t_1+t_2 amount of time after t_{on} as defined in the measurement methods standard document. Approximately 100 ms of data after trigger should ensure that all cases are taken care of as suggested by the standard. t_1 , t_2 , and t_3 durations are fetched based on the RF frequency range.

- The identification of t_{on} is done by looking for a significant frequency deviation after a certain power level has been achieved. A manual override for the t_{on} is also provided in the Trigger Meas tab of the Settings control panel when a Transient Frequency Behavior measurement is chosen. This allows you to manually override the t_{on} that is calculated (by releasing the Auto Option) and place it appropriately based on the P25 Freq Dev vs Time display. The same is true for t_{off} when the measurement is being done for the On to Off behavior.
- t_1 and t_2 regions are identified after t_{on} and t_3 before t_{off} (for the On to Off behavior).
- The mean and max frequency deviation is reported in the regions identified.
- A Pass or Fail is also reported by comparing the Mean frequency deviation with the recommended values given in the standard. A red band is shown if a particular region's result is less than the performance recommendation. The following image shows this measurement.

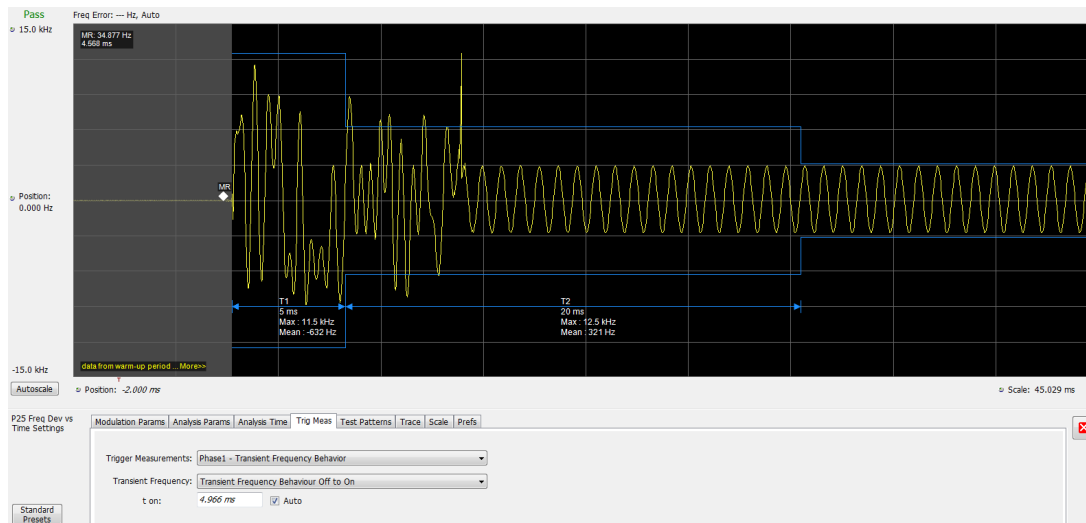

HCPM Tx Logical Channel Time Alignment (Phase 2 HCPM). The following information is specific to this measurement. This result can be viewed in P25 Summary and P25 Power vs Time displays.

- This measurement is done in two steps: First by calculating t_{OB_sync} using HDQPSK data (the ISCH pattern is looked for) and then by using the result to calculate t_{IB_sync} using HCPM data (the SACCH pattern is looked for).
The first step is done by choosing Time Alignment (t_{OB_sync} measurement) in the Trig Meas tab in the Settings control panel.
When the second step, Time Alignment (t_error_0 calculation) or (t_error_1 calculation) is selected in the Trig Meas tab of the control panel, there is an option to override the t_{OB_sync} value calculated in the first step.
- When this measurement is chosen, only this result is provided in the P25 Summary display.
- You must provide the ultraframe boundary to the trigger of the analyzer.
- An autocorrelation of the input RF signal with the reference patterns is performed to get the peak that will determine t_{OB_sync} (measured) and t_error_0 or t_error_1 from the trigger point.

HCPM Tx Logical Channel Peak ACPR (Phase 2 HCPM)

This measures the ratio of total transmitter power under prescribed conditions and modulation to the peak power that falls in a prescribed bandwidth centred on the nominal frequency of the adjacent channel during the transmitter power ramping interval. This applies only to inbound signals. This measurement result appears in the P25 Summary display.

- This measurement is done by calculating power in the adjacent channels for the entire duration of data chosen by the user, including the power ramp up and ramp down portions. The standard recommends 360 ms of data for this measurement, unlike the other ACPR measurements for which the analysis is done only for the on slot region.
- The higher and lower adjacent channel power is reported in the P25 Summary display under Power Measurements.

- The two results are then subtracted from the calculated RF output power and the minimum of the two results is presented as the Min Pk ACPR in the P25 Summary display.
- This measurement is only done for bursty HCPM data and not for High Deviation or Low Deviation test patterns.
- The Limits tab in the P25 Summary Settings control panel allows you to compare the results against limits set for Pass/Fail.
- This measurement result is not shown in the P25 Summary display when trigger measurements are chosen.



Note: Read about important information related to HCPM bursty data measurements [here](#).

HCPM Transmitter Logical Channel Off Slot power (Phase 2 HCPM)

This measures the power of a TDMA transmitter during the off portion of the TDMA pulse. This measurement only applies to inbound signals. This result can be viewed in P25 Summary and P25 Power vs Time displays.

- The measurement is done as suggested by the standard to calculate P_{ONREL} and P_{OFFREL} . P_{ONREL} is the maximum level observed in the interval 1 ms to 29 ms and P_{OFFREL} is the maximum level observed in 30.2 ms to 59.8 ms.
- P_{TX} is the rated carrier power and can be set by the user from the Analysis Params tab in the Settings control panel.
- The absolute level of the off slot power is then calculated as $P_{OFF} = P_{TX} - (P_{ONREL} - P_{OFFREL})$ dBm
- This measurement is only done for bursty HCPM data and not for High Deviation or Low Deviation test patterns.
- The Limits tab in the P25 Summary Settings control panel allows you to compare the results against limits set for Pass/Fail.
- This measurement result is not shown in the P25 Summary display when trigger measurements are chosen.



Note: Read about important information related to HCPM bursty data measurements [here](#).

HCPM Transmitter Logical Channel Power Envelope (Phase 2 HCPM)

This is a measure of how well a portable radio controls the transmitter power as it inserts an inbound HCPM TDMA burst into a frame on a voice channel. This measurement applies to inbound signals only.

- All scalar results relevant to this measurement are shown both in P25 Power vs Time display and the P25 Summary display.
- The measurement results and the duration in which the measurements are made are shown graphically in P25 Power vs Time display. The results are grouped under Power Info and Time Info in the table at the bottom of the display.
- This measurement is only done for bursty HCPM data and not for High Deviation or Low Deviation test patterns.
- The Limits tab in the P25 Summary Settings control panel allows you to compare the results against limits set for Pass/Fail.
- This measurement result is not shown in the P25 Summary display when trigger measurements are chosen.



Note: Read about important information related to HCPM bursty data measurements [here](#).

P25 Test Patterns

A variety of test patterns are specified in the TIA-102 documents for use in performance testing of transmitters. These test patterns allow the software to compare the measurement result to the standards limit. Test engineers can select from the test patterns described in the following tables.



Note: Although this table gives the test patterns for measurements as recommended by the Standard, other measurement results are also provided as additional information for a given test pattern. For example, Modulation Fidelity results can also be provided for High Deviation and Low Deviation test patterns.

Table 25: P25 test patterns, Phase 1 C4FM

TIA-102 Phase 1 C4FM test pattern	Phase 1 (C4FM) measurement
Standard transmitter	RF Output Power
	Operating Frequency Accuracy
	Modulation Emission Spectrum
	Unwanted Emissions (Adjacent Channel Power Ratio)
	Modulation Fidelity
	Transmitter Power and Encoder Attack Time
	Transmitter Power and Encoder Attack Time (With Busy/Idle Operations)
Low Deviation	Operating Frequency Accuracy
	Transient Frequency Behavior
	Frequency Deviation
Standard Idle	Transmitter Power and Encoder Attack Time (With Busy/Idle Operations)
Standard Transmitter Symbol Rate (Same as High Deviation test pattern)	Symbol Rate Accuracy
	Frequency Deviation
C4FM Modulation Fidelity	Modulation Fidelity
Standard Tone	Can be used for measurements such as RF Output Power, Operating Frequency Accuracy, Modulation Fidelity, and ACPR
Other (User created test pattern)	Can be used for measurements such as RF Output Power, Operating Frequency Accuracy, Modulation Fidelity, and ACPR

Table 26: P25 test patterns, Phase 2 Inbound and Outbound

TIA-102 Phase 2 test pattern	Phase 2 measurement
Standard Transmitter (Inbound and Outbound)	RF Output Power
	Operating Frequency Accuracy
	Modulation Emission Spectrum
	Unwanted Emissions (Adjacent Channel Power Ratio)
	Modulation Fidelity
Inbound Standard Tone Ch0	Can be used for measurements such as RF Output Power, Operating Frequency Accuracy, Modulation Fidelity, and ACPR
Inbound Standard Tone Ch1	Can be used for measurements such as RF Output Power, Operating Frequency Accuracy, Modulation Fidelity, and ACPR

Table continued...

TIA-102 Phase 2 test pattern	Phase 2 measurement
Outbound Standard Tone	Operational Frequency Accuracy
Inbound Symmetrical Time Slot	RF Output Power
	Modulation Emission Spectrum
	Modulation Fidelity
	HCPM (Peak ACPR)
	HCPM (Off slot power)
	HCPM (Power envelope)
	Unwanted Emissions (Adjacent Channel Power Ratio)
Low Deviation (Inbound)	Frequency deviation for HCPM
	Symbol Rate Accuracy
Low Deviation (Outbound)	Symbol Rate Accuracy
High Deviation (Inbound and Outbound)	Symbol Rate Accuracy
Other (User created test pattern)	Can be used for measurements such as RF Output Power, Operating Frequency Accuracy, Modulation Fidelity, and ACPR

Analysis of HCPM Bursty Data

It is important to take into account the following information when analyzing HCPM bursty data.

- It is mandatory that at least one complete on slot and off slot region (including the ramp up and ramp down portion) have to be included in the analysis window for HCPM measurement results to be analyzed.
- If HCPM is the chosen standard in Standards Presets, then a minimum length of 94 ms is set for the analysis window. This is to ensure that a full on slot and off slot region is available irrespective of the selected analysis offset.
- Do not use the High Deviation or Low Deviation test patterns for bursty signals. Test patterns are selected in the P25 Settings control panel on the Test Patterns tab. If selected, analysis would look for a bursty pattern. High Deviation and Low Deviation test patterns are not bursty and therefore do not have the above analysis length restriction.

If you try to set the analysis length to less than 94 ms, the following status message will display: *P25:HCPM:Minimum Analysis Length should be ≥ 94 ms.*

- Most measurements that are required to be done on on slot regions are done centered at the on slot region of HCPM bursty data.

HCPM Pilot symbols are not displayed in the P25 Symbol Table.

It is mandatory that at least one complete on slot and off slot region (including the ramp up and ramp down portion) have to be included in the analysis window for HCPM measurement results to be analyzed.

The analysis module does not analyze two active adjacent slots (28 ms each) if they do not have the off slot (power off) region between them.

When HCPM bursty data is analyzed, the following status message will appear on all relevant displays: *P25:HCPM modulation analysis is done only on on slot regions.*



Note: The test patterns, except for High Deviation and Low Deviation, do not impact the HCPM pattern analysis for other selected test patterns, such as Standard Transmitter Test Pattern, Inbound Standard Tone Test Pattern Ch0, Inbound Standard Tone Test Pattern Ch1, Inbound Symmetrical Time Bound Test Pattern, and Others.

P25 Constellation Display

The P25 Constellation Display shows the P25 signal modulation amplitude. For the HCPM and HDQPSK standards, you can view this display as frequency deviation or as I and Q. For the C4FM standard, only the frequency deviation applies.

To show the P25 Constellation display you can select **Presets > Standards > P25** or do the following:

1. If you are analyzing a stored data file, recall the data file now. Otherwise, go to the next step.
2. Press the **Displays** button or select **Setup > Displays**.
3. In the **Select Displays** dialog, select **P25 Analysis** in the **Measurements** box.
4. In the Available displays box, double-click the **P25 Constellation** icon or select the icon and click **Add**. The P25 Constellation icon will appear in the **Selected displays** box and will no longer appear under Available displays.
5. Click **OK** to show the P25 Constellation display.
6. Select **Setup > Settings** to display the control panel.
7. Select the **Modulation Params** tab. Set the Standard, Modulation Type, and Measurement and Reference filters as appropriate for the input signal.
8. For Phase 2 signals, select the **Trace** tab and set the **Trace Type** to Freq Dev or IQ.
9. Select the **Test Patterns** tab and select the desired test pattern as appropriate for the input signal.
10. If you are analyzing a data file, press the **Replay** button to take measurements on the recalled acquisition data file.

Elements of the Display

The following image shows the P25 Constellation display set to IQ for a HDQPSK signal.

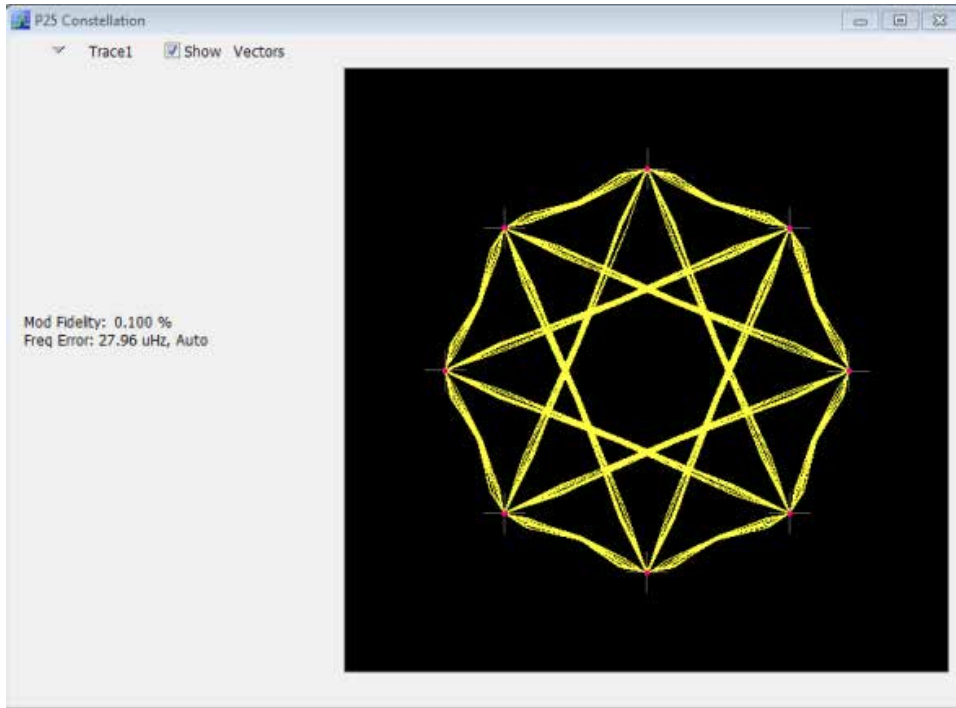

The following image shows the same signal as the previous image, but with the display set to Frequency Deviation.

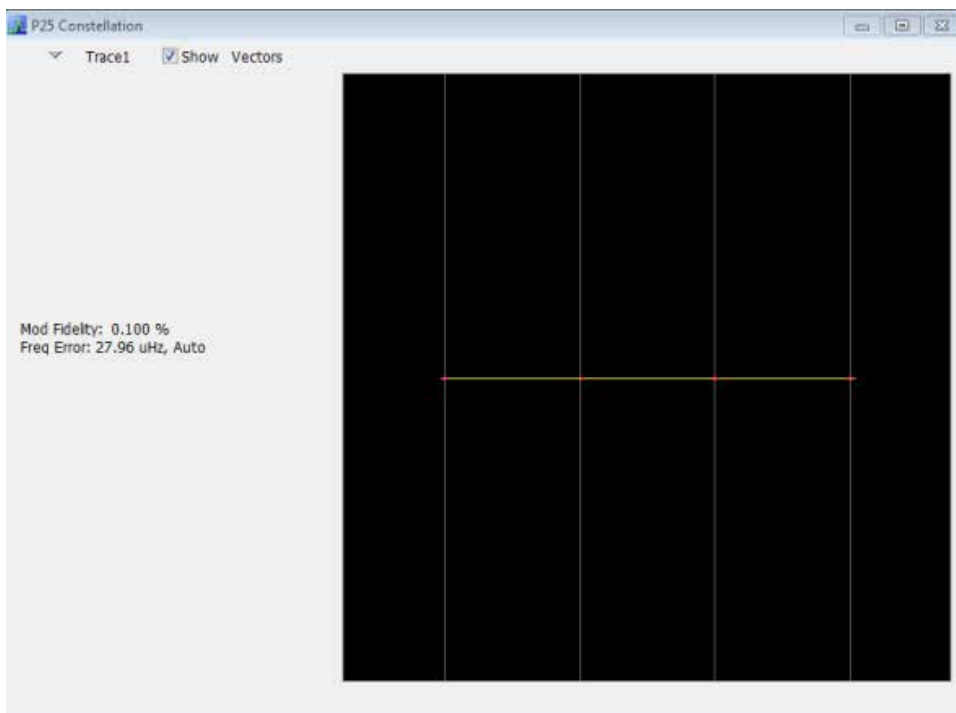

Item	Display element	Description
1	Marker Readout	Located to the left of the constellation plot or below it, depending on the size of the window. If markers are enabled, the marker readout will show frequency deviation results or IQ results (time, mag, phase, symbol marker and symbol value) of the point with the selected marker.
2	Measurement results readout	These readouts are located to the left or below of the Constellation plot, depending on the window size. The readout shows Modulation Fidelity (%) and Frequency Error (Hz). The second readout can either be Freq Error where the result is followed by Auto or it could be Freq Offset where the result is followed by Manual. This choice between Freq Error and Freq Offset is made from the Analysis Params tab in the Settings control panel.
3	Plot	Shown as either I vs Q or as Frequency Deviation. The trace type is controlled from the Settings > Trace tab.

P25 Constellation Settings

Main menu bar: **Setup > Settings**

Front panel: **Settings**

Favorites toolbar: 

The P25 Constellation Settings control panel provides access to settings that control parameters of the Constellation Display.

Settings tab	Description
Modulation Params	Specifies the input signal standard and additional user-settable signal parameters.
Analysis Params	Specifies parameters used by the instrument to analyze the input signal.
Analysis Time	Specifies parameters that define the portion of the acquisition record that is used for analysis. Also allows you to specify the Units (Symbols or Seconds) and Time Zero Reference (Trigger or Acquisition Start) for P25 Analysis displays.
Test Patterns	Specifies the type of test pattern being used. Some analysis differs based on the selected test pattern. Available test patterns vary depending on the selected standard and modulation type.
Trace	Specifies the trace type (Vectors, Points, and Lines), the number of points per symbol when chosen to view as Vectors or Lines, and to control the view as Freq Dev or IQ.
Prefs	Specifies the radix of the marker readout and whether elements of the graphs are displayed.
Trig Meas	Enables you to select from several different trigger measurements.

P25 Eye Diagram Display

The P25 Eye Diagram display shows a digitally modulated signal overlapped on itself to reveal variations in the signal.

To show the P25 Eye Diagram display:

1. If you are analyzing a stored data file, recall the data file now. Otherwise, go to the next step.
2. Press the **Displays** button or select **Setup > Displays**.

3. From the **Measurements** box, select **P25 Analysis**.
4. Double-click the **P25 Eye Diagram** icon in the **Available Displays** box. This adds the P25 Eye Diagram icon to the **Selected displays** box.
5. Click **OK** button. This displays the P25 Eye Diagram view.
6. Select **Setup > Settings** to display the control panel.
7. Select the **Modulation Params** tab. Set the Standard, Modulation Type, and Measurement and Reference filters as appropriate for the input signal.
8. For Phase 2 signals, select the **Trace** tab and set the **Trace Type** to Freq Dev or IQ.
9. Select the **Test Patterns** tab and choose a test pattern appropriate for the input signal.
10. If you are analyzing a data file, press the **Replay** button to take measurements on the recalled acquisition data file.

Elements of the Display

The following image shows the P25 Eye display with Trace Type set to IQ.

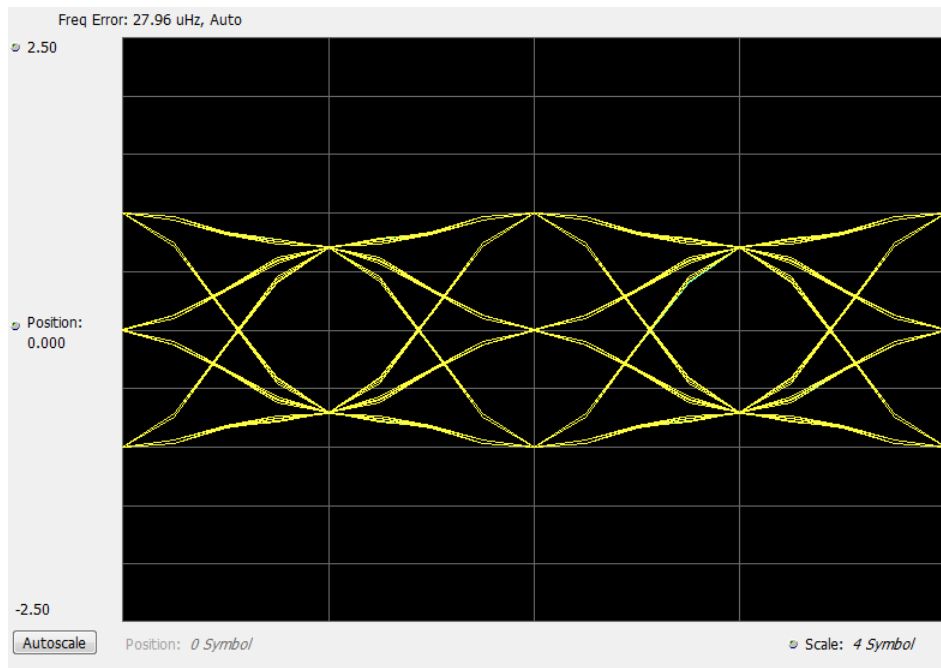

The following image shows the P25 Eye display with Trace Type set to Freq Dev.

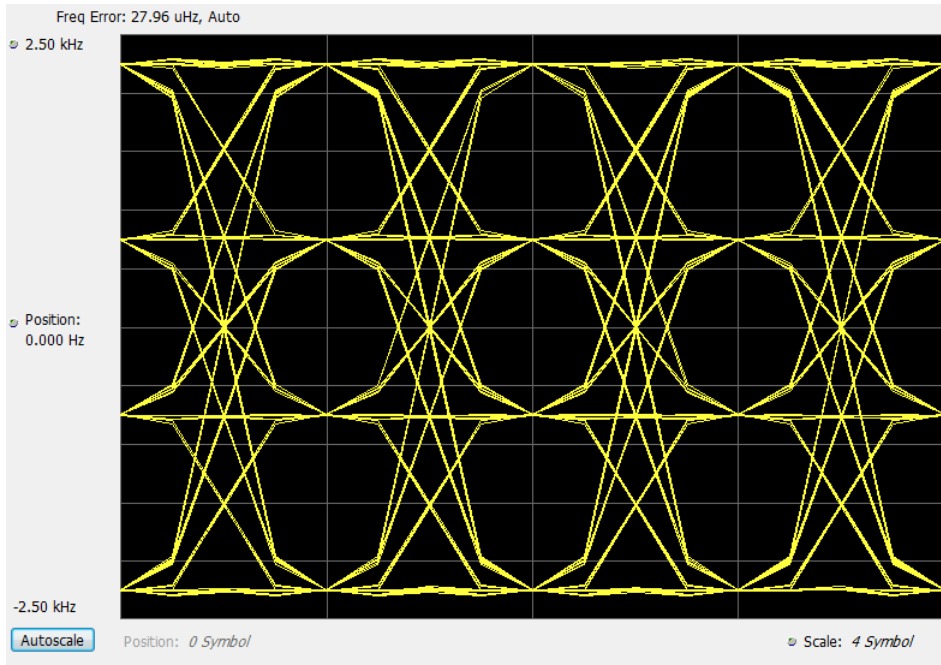

Item	Display element	Description
1	Top of graph	The vertical scale is normalized with no units (for IQ) and with Hz (for Freq dev).
2	Position	Specifies the value shown at the center of the graph display.
3	Bottom Readout	Displays the value indicated by the bottom of graph.
4	Autoscale	Adjusts the vertical and horizontal settings to provide the best display.
5	Position	Displays the horizontal position of the trace on the graph display.
6	Scale	Adjusts the span of the graph in symbols.
7	Freq Error	Displays the difference between the maximum and minimum measured values of the signal frequency during the Measurement Time. The readout can either be Freq Error where the result is followed by Auto or it could be Freq Offset where the result is followed by Manual. This choice between Freq Error and Freq Offset is made from the Analysis Params tab in the Settings control panel.

P25 Eye Diagram Settings

Main menu bar: Setup > Settings

Favorites toolbar: 

The settings for the P25 Eye Diagram display are shown in the following table.

Settings tab	Description
Modulation Params	Specifies the input signal standard and additional user-settable signal parameters.
Analysis Params	Specifies parameters used by the instrument to analyze the input signal.
Analysis Time	Specifies parameters that define the portion of the acquisition record that is used for analysis. Also allows you to specify the Units (Symbols or Seconds) for P25 Analysis displays.
Trig Meas	Enables you to select from various trigger measurements. The trigger selections vary by signal type.
Test Patterns	Specifies the type of test pattern being used. Some analysis differs based on the selected test pattern. Available test patterns vary depending on the selected standard and modulation type.
Trace	Specifies the trace type (Vectors, Points, and Lines), the number of points per symbol when chosen to view as Vectors or Lines, and to control the view as Freq Dev or IQ.
Scale	Defines the vertical and horizontal axes.
Prefs	Specifies the radix of the marker readout and whether elements of the graphs are displayed.

P25 Power vs Time Display

The P25 Power vs Time display shows the signal power amplitude versus time. In HCPM bursty data, the Regions A, B and C are shown based on the middle of the burst and not based on the pilots.

To show the P25 Power vs Time display:

1. If you are analyzing a stored data file, recall the data file now. Otherwise, go to the next step.
2. Press the **Displays** button or select **Setup > Displays**.
3. In the **Select Displays** dialog, select **P25 Analysis** in the **Measurements** box.
4. In the Available displays box, double-click the **P25 Power vs Time** icon or select the icon and click **Add**. The P25 Power vs Time icon will appear in the **Selected displays** box and will no longer appear under Available displays.
5. Click **OK** to show the P25 Power vs Time display.
6. Select **Setup > Settings** to display the control panel.
7. Select the **Modulation Params** tab. Set the Standard, Modulation Type, and Measurement and Reference filters as appropriate for the input signal.
8. Select the **Test Patterns** tab and choose a test pattern appropriate for the input signal.
9. If you are analyzing a data file, press the **Replay** button to take measurements on the recalled acquisition data file.

Elements of the Display

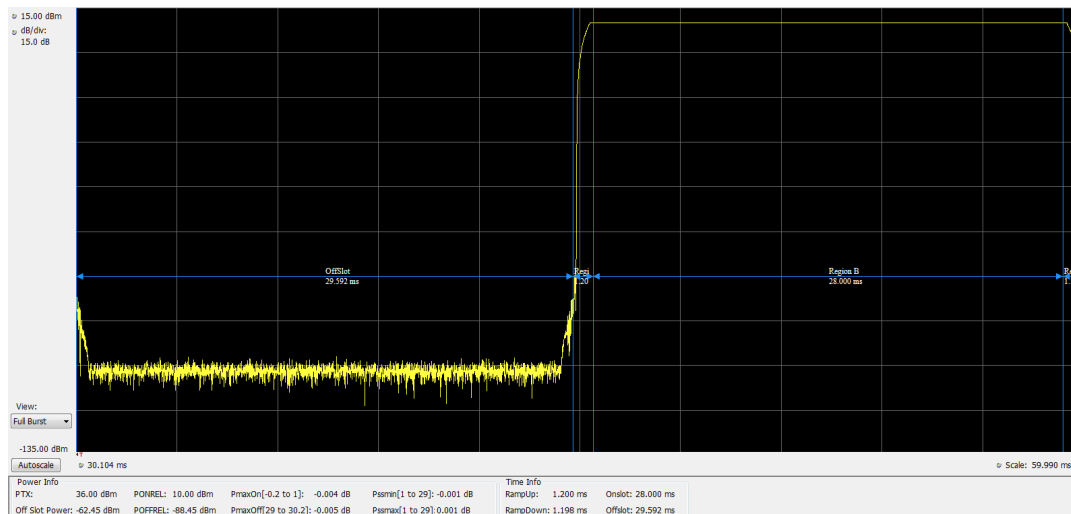

Item	Display element	Description
1	Top of graph, first setting	Sets the Power level that appears at the top of the graph, in dBm. This is only a visual control for panning the graph.
2	Units	Sets the global amplitude units for all the views in the analysis window. This will change the amplitude selection in the Units tab of the Amplitude control panel.
3	Top of graph, second setting	Sets the vertical Scale of the graphs, in dB/div. This is only a visual control for panning the graph.
4	View (Only available for bursty HCPM data.)	<p>Selects the specific view of the packet burst within the display:</p> <p>Full Burst displays the entire packet, with vertical lines indicating Power ramp up, On Slot, Power ramp down, and Off slot regions.</p> <p>Ramp Up zooms the display into the interval around the packet rising edge.</p> <p>Ramp Down zooms the display into the interval around the packet falling edge.</p>
5	Bottom of graph readout	Shows the Power level at the bottom of the graph in dBm.
6	Autoscale	Adjusts the vertical and horizontal settings to provide the best display.
7	Bottom of graph, left side	Sets the starting time of the graph in seconds
8	Bottom of graph, right side	Sets the scale (width) of the graph in seconds
9	Table below graph	<p>This table shows the following results.</p> <p>For non-bursty signals: RF output power</p> <p>For bursty signals: Power Info (Offslot Power and Power Envelope results) and Time Info.</p>

P25 Power vs Time Settings

Main menu bar: Setup > Settings



The settings for the P25 Power vs Time display are shown in the following table.

Settings tab	Description
<i>Modulation Params</i>	Specifies the input signal standard and additional user-settable signal parameters.
<i>Analysis Params</i>	Specifies parameters used by the instrument to analyze the input signal.
<i>Analysis Time</i>	Specifies parameters that define the portion of the acquisition record that is used for analysis. Also allows you to specify the Units (Symbols or Seconds) for P25 Analysis displays.
<i>Trig Meas</i>	Enables you to select from various trigger measurements. The trigger selections vary by signal type.
<i>Test Patterns</i>	Specifies the type of test pattern being used. Some analysis differs based on the selected test pattern. Available test patterns vary depending on the selected standard and modulation type.
<i>Scale</i>	Defines the vertical and horizontal axes.
<i>Prefs</i>	Specifies the radix of the marker readout and whether elements of the graphs are displayed.

P25 Summary Display

The P25 Summary display shows a summary of all the scalar measurements done on the acquired test pattern. The summary display and contents will vary according to the selected standard.

Pass/Fail information is also provided in this display for all enabled scalar measurements. You can set limits and choose which measurement to compare for Pass/Fail from the Limits tab in the P25 Summary Settings control panel. The default limits come from the performance recommendation limits given by the Standard document. The default limits can be reloaded by selecting the P25 Standards Preset option or by loading the default limits table.

To show the P25 Summary display you can select **Presets > Standards > P25** or do the following:

1. If you are analyzing a stored data file, recall the data file now. Otherwise, go to the next step.
2. Press the **Displays** button or select **Setup > Displays**.
3. In the **Select Displays** dialog, select **P25 Analysis** in the **Measurements** box.
4. In the Available displays box, double-click the **P25 Summary** icon or select the icon and click **Add**. The P25 Summary icon will appear in the **Selected displays** box and will no longer appear under Available displays.
5. Click **OK** to show the P25 Summary display.
6. Select **Setup > Settings** to display the control panel.
7. Select the **Modulation Params** tab. Set the Standard, Modulation Type, and Measurement and Reference filters as appropriate for the input signal.
8. Select the **Test Patterns** tab and select a test pattern. The available test patterns in the drop down list depend of the standard and modulation type you have selected.
9. If you are analyzing a data file, press the **Replay** button to take measurements on the recalled acquisition data file.

P25 Summary Display

The Modulation Measurements, Power Measurements, and Trigger Measurements components of this display vary depending on which modulation type is selected.

The following image shows an example of the display for a Phase 1 C4FM signal.

Standard: Phase1		Bandwidth: 12.5 KHz		Modulation Type: C4FM		Clear	
Modulation Measurements							
Modulation Fidelity:	0.465 %			PASS			
Operating Freq Accuracy:	0 ppm			PASS			
Symbol Rate Accuracy:	-- ppm			N/A			
Frequency Deviation							
Positive Peak:	-- Hz			N/A			
Negative Peak:	-- Hz			N/A			
Power Measurements							
RF Output Power:	10.00 dBm			PASS			
Trigger Measurements							
Phase1 Tx Attack Time							
Avg Tx Pwr Attack	--			N/A			
Avg Tx Encoder Attack	--			N/A			
				-- of 10			
Phase1 Tx Attack Time (Busy/Idle)							
Avg Tx Pwr Attack	--						
Avg Tx Encoder Attack	--						
				-- of 10			
Phase1 Tx Throughput Delay: --							
				-- of 10			

The following image shows an example of the display for a Phase 1 C4FM High Deviation signal.

Standard: Phase1		Bandwidth: 12.5 KHz		Modulation Type: C4FM		Clear	
Modulation Measurements							
Modulation Fidelity:	0.030 %			PASS			
Operating Freq Accuracy:	0 ppm			PASS			
Symbol Rate Accuracy:	0.00 ppm			PASS			
Frequency Deviation (Symbol Rate Pattern)							
f1 Positive Peak:	2768.93 Hz			PASS			
f2 Negative Peak:	-2865.77 Hz			PASS			
Power Measurements							
RF Output Power:	10.00 dBm			PASS			
Trigger Measurements							
Phase1 Tx Attack Time							
Avg Tx Pwr Attack	--						
Avg Tx Encoder Attack	--						
				-- of 10			
Phase1 Tx Attack Time (Busy/Idle)							
Avg Tx Pwr Attack	--						
Avg Tx Encoder Attack	--						
				-- of 10			
Phase1 Tx Throughput Delay: --							
				-- of 10			

The following image shows an example of the display for a Phase 2 HCPM (Inbound) signal.

Standard: Phase2 **Bandwidth:** 12.5 KHz **Modulation Type:** HCPM (Inbound)

Modulation Measurements		
Modulation Fidelity:	0.477 %	PASS
Operating Freq Accuracy:	0 ppm	PASS
Symbol Rate Accuracy:	-- ppm	N/A
Frequency Deviation		
Positive Peak:	-- Hz	N/A
Negative Peak:	-- Hz	N/A

Trigger Measurements		
HCPM Tx Logic Ch Time Alignt		
tOB_sync (measured)	--	
	-- of 5	
Avg t_error_0	--	N/A
	-- of 5	
Avg t_error_1	--	
	-- of 5	

Power Measurements		
RF Output Power:	10.00 dBm	PASS
HCPM Tx Logic Ch Off Slot:	-62.45 dBm	PASS
HCPM Tx Logic Ch Pwr Env Limits		
Time (ms)	Power	
Pmax-on	-0.2 to 1.0 -0.004 dB	PASS
Pss-max	1.0 to 29.0 0.001 dB	PASS
Pss-min	1.0 to 29.0 -0.001 dB	PASS
Pmax-off	29.0 to 30.2 -0.005 dB	PASS
HCPM Tx Logic Ch Pk ACPR		
P_ACP_HI	-37.96 dBm	
P_ACP_LOW	-40.13 dBm	
Min Pk ACPR	47.964 dB	PASS

The following image shows an example of the display for a Phase 2 HDQPSK (Outbound) signal.

Standard: Phase2 **Bandwidth:** 12.5 KHz **Modulation Type:** HDQPSK (Outbound)

Modulation Measurements		
Modulation Fidelity:	0.100 %	PASS
Operating Freq Accuracy:	0 ppm	PASS
Symbol Rate Accuracy:	-- ppm	N/A
Power Measurements		
RF Output Power:	7.94 dBm	PASS

For more information about specific measurement results, see the P25 Measurements section [here](#).

Elements of the Display

Element	Description
Standard	Display of the standard selected on the Setup > Settings > Modulation Params tab.
Bandwidth	Display of the channel bandwidth which is set based on the standard and modulation type.
Modulation Type	Display of the modulation type selected on Setup > Settings > Modulation Parameters tab.
Clear	Click button to reset measurement. Clears all values.

Table continued...

Element	Description
Modulation Measurements	Shows the modulation measurements associated with the signal.
Power Measurements	Shows the power measurements associated with the signal.
Trigger Measurements	Shows the trigger measurements associated with the signal.

P25 Summary Settings

Main menu bar: Setup > Settings



The settings for the P25 Summary display are shown in the following table.

Settings tab	Description
Modulation Params	Specifies the input signal standard and additional user-settable signal parameters.
Analysis Params	Specifies parameters used by the instrument to analyze the input signal.
Analysis Time	Specifies parameters that define the portion of the acquisition record that is used for analysis. Also allows you to specify the Units (Symbols or Seconds) for P25 Analysis displays.
Trig Meas	Enables you to select from various trigger measurements. The trigger selections vary by signal type.
Test Patterns	Specifies the type of test pattern being used. Some analysis differs based on the selected test pattern. Available test patterns vary depending on the selected standard and modulation type.
Limits	Load and define P25 measurement limits for Pass/Fail comparison. You can save defined limits as a .csv file and also load previously saved .csv files.

P25 Symbol Table Display

The P25 Symbol Table display shows decoded data values for each data symbol in the analyzed signal packet.

To show the P25 Symbol Table display:

1. If you are analyzing a stored data file, recall the data file now. Otherwise, go to the next step.
2. Press the **Displays** button or select **Setup > Displays**.
3. In the **Select Displays** dialog, select **P25 Analysis** in the **Measurements** box.
4. In the Available displays box, double-click the **P25 Symbol Table** icon or select the icon and click **Add**. The P25 Symbol icon will appear in the **Selected displays** box and will no longer appear under Available displays.
5. Click **OK** to show the P25 Symbol Table display.
6. Select **Setup > Settings** to display the control panel.

7. Select the **Modulation Params** tab. Set the Standard, Modulation Type, and Measurement and Reference filters as appropriate for the input signal.
8. Select the **Test Patterns** tab and select a test pattern. The available test patterns in the drop down list depend on the standard and modulation type you have selected.
9. If you are analyzing a data file, press the **Replay** button to take measurements on the recalled acquisition data file.

P25 Symbol Table

The following image shows the P25 Symbol Table for HCPM (bursty) signals. For this signal type, the symbols are arranged as Bursts vs Symbols. The analysis is done only on the on slot regions of the bursty HCPM data and 160 symbols (centered at the middle of the burst) are reported on the symbol table for every on slot region. You can read more about specific measurements [here](#).

	B1	B2
0	1	3
1	3	1
2	2	1
3	1	0
4	2	3
5	3	3
6	0	0
7	3	1
8	2	3
9	1	2
10	0	3
11	2	2
12	3	0
13	1	3
14	2	2
15	2	2
16	0	1
17	0	3
18	0	2
19	3	3
20	2	3
21	1	0
22	3	0
23	1	0

The following image shows the P25 Symbol Table for C4FM (non-bursty) signals. For this signal type and for HDQPSK, there is no grouping into bursts and all symbols that are analyzed are shown.

0	3	2	0	0	0	2	1	1	3	2	2	3	0	2	2	1
16	1	3	3	1	1	3	0	2	2	0	0	3	0	0	0	3
32	3	2	0	2	0	0	0	3	1	2	0	3	1	0	3	2
48	3	2	3	3	3	1	3	1	3	1	0	0	1	1	2	3
64	2	1	2	3	3	3	3	0	2	1	0	2	3	3	3	1
80	0	1	3	3	0	1	3	1	0	1	2	3	1	1	2	2
96	0	2	0	0	3	0	1	3	2	3	0	0	2	2	0	3
112	3	2	3	3	1	0	3	3	2	0	3	0	2	0	0	2
128	1	2	2	1	2	2	2	0	3	1	1	2	2	2	1	2
144	3	1	3	1	3	2	2	0	2	1	1	1	2	0	0	3
160	3	2	2	0	2	3	1	1	3	0	2	2	0	2	3	0
176	2	1	1	0	0	0	3	2	1	1	3	1	3	3	3	2
192	3	1	0	3	1	2	2	2	1	3	3	0	3	0	3	0
208	2	3	3	2	1	3	0	3	1	2	2	2	0	0	0	1
224	0	2	1	0	1	0	1	3	2	3	2	2	3	1	2	0
240	3	2	2	0	2	3	2	1	0	1	3	3	2	1	2	0
256	1	2	3	2	0	0	2	0	0	0	1	0	1	1	0	3
272	3	2	0	2	1	3	3	0	0	3	2	0	3	0	3	3
288	3	2	3	0	2	1	1	1	2	0	1	1	1	2	1	3
304	1	2	3	0	1	0	1	3	1	2	2	1	1	3	3	2
320	1	1	3	2	3	2	0	0	1	0	0	0	3	3	2	1

Marker: MR Symbol: 152
Time: 39.578 ms Value: 2

Elements of the Display

Element	Description
Marker	Displays the selected marker label.
Time	Displays the time in ms or in Symbols based on the Units chosen in the Analysis Time tab of the Settings Control panel.
Symbol	The value shown here reflects the symbol you have selected (highlighted) in the display.
Value	Displays the value of the selected symbol.

P25 Symbol Table Settings

Main menu bar: Setup > Settings



The settings for the P25 Symbol Table display are shown in the following table.

Settings tab	Description
Modulation Params	Specifies the input signal standard and additional user-settable signal parameters.

Table continued...

Settings tab	Description
Analysis Params	Specifies parameters used by the instrument to analyze the input signal.
Analysis Time	Specifies parameters that define the portion of the acquisition record that is used for analysis. Also allows you to specify the Units (Symbols or Seconds) for P25 Analysis displays.
Trig Meas	Enables you to select from various trigger measurements. The trigger selections vary by signal type.
Test Patterns	Specifies the type of test pattern being used. Some analysis differs based on the selected test pattern. Available test patterns vary depending on the selected standard and modulation type.
Prefs	Specifies the radix of the marker readout.

P25 Frequency Dev vs Time Display

The P25 Frequency Deviation vs. Time Display shows how the signal frequency varies with time.

To display the P25 Frequency Dev vs. Time Display:

1. If you are analyzing a stored data file, recall the data file now. Otherwise, go to the next step.
2. Select the **Displays** button or **Setup > Displays**.
3. In the **Select Displays** dialog, select **P25 Analysis** in the **Measurements** box.
4. In the **Available displays** box, double-click the **P25 Frequency Dev vs. Time** icon or select the icon and click **Add**. The P25 Frequency Dev vs. Time icon will appear in the **Selected displays** box and will no longer appear under Available displays.
5. Click **OK** to display the Freq Dev vs. Time display.
6. Select the **Modulation Params** tab. Set the Standard, Modulation Type, and Measurement and Reference filters as appropriate for the input signal.
7. Select the **Test Patterns** tab and select a test pattern. The available test patterns in the drop down list depend of the standard and modulation type you have selected.
8. If you are analyzing a data file, press the **Replay** button to take measurements on the recalled acquisition data file.

Elements of the Display

The following image shows the P25 Freq Dev vs Time display for Phase 1 C4FM (non-bursty) High Deviation signals.

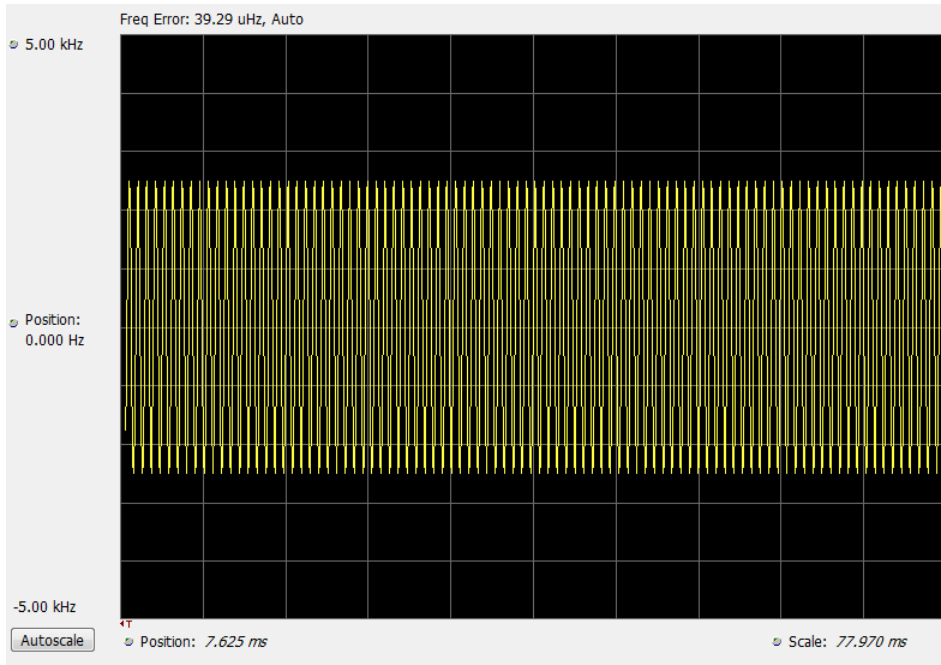

The following image shows the P25 Freq Dev vs Time display for Phase 2 HCPM (bursty) signals.

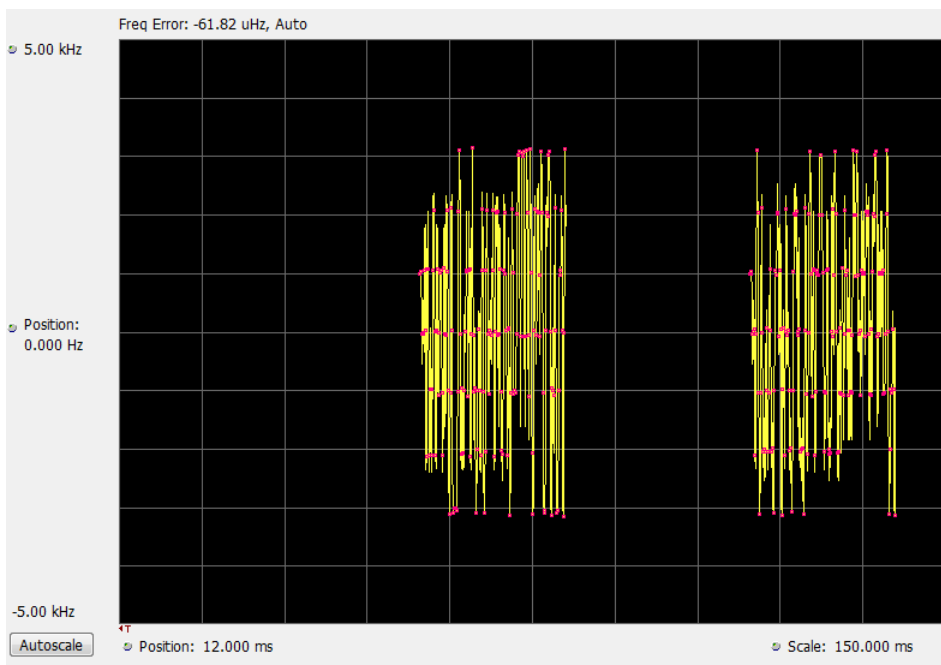

Note: For bursty HCPM signals, frequency deviation analysis is done only on 160 symbols centered at every on slot region in the chosen analysis window and not on off slot regions. That is why there is no information shown during off slot regions. You can read more specific information about P25 measurements [here](#).

Elements of the Display

Item	Display element	Description
1	Top of graph adjustment	Adjust the frequency range displayed on the vertical axis.
2	Position (center)	Adjust the frequency shown at the center of the display.
3	Autoscale button	Adjusts the offset and range for both vertical and horizontal to provide the best display.
4	Position	Displays the horizontal position of the trace on the graph display.
5	Scale	Adjust the horizontal scale (time).

Changing Frequency vs Time Display Settings

P25 Frequency Dev Vs Time Settings

Main menu bar: Setup > Settings



The Setup settings for P25 Frequency Dev vs. Time are shown in the following table.

Settings tab	Description
Modulation Params	Specifies the input signal standard and additional user-settable signal parameters.
Analysis Params	Specifies parameters used by the instrument to analyze the input signal.
Analysis Time	Specifies parameters that define the portion of the acquisition record that is used for analysis. Also allows you to specify the Units (Symbols or Seconds) for P25 Analysis displays.
Trig Meas	Enables you to select from various trigger measurements. The trigger selections vary by signal type.
Test Patterns	Specifies the type of test pattern being used. Some analysis differs based on the selected test pattern. Available test patterns vary depending on the selected standard and modulation type.
Trace	Specifies the trace type (Vectors, Points, and Lines), the number of points per symbol when chosen to view as Vectors or Lines, and to control the view as Freq Dev or IQ.
Scale	Defines the vertical and horizontal axes.
Prefs	Specifies the radix of the marker readout and whether elements of the graphs are displayed.

P25 Analysis Shared Measurement Settings

Main menu bar: Setup > Settings



The control panel tabs in this section are shared between the displays in P25 Analysis (Setup > Displays). Some tabs are shared by all the displays, some tabs are shared by only a subset of displays. The settings available on some tabs change depending on the selected display.

Table 27: Common controls for P25 analysis displays

Settings tab	Description
Modulation Params	Specifies the input signal standard and additional user-settable signal parameters.
Analysis Params	Specifies parameters used by the application to analyze the input signal.
Analysis Time	Specifies parameters that define the portion of the acquisition record that is used for analysis. Also allows you to specify the Units (Symbols or Seconds) for P25 Analysis displays.
Trace	Specifies the trace type (Vectors, Points, and Lines), the number of points per symbol when chosen to view as Vectors or Lines, and to control the view as Freq Dev or IQ.
Scale	Defines the vertical and horizontal axes.
Test Patterns	Enables you to select from eight different test patterns.
Trig Meas	Enables you to select from various trigger measurements. The trigger selections vary by signal type.
Prefs	Specifies the radix of the marker readout and whether elements of the graphs are displayed.

Modulation Params Tab - P25

The Modulation Params tab specifies the type of modulation used by the input signal and other parameters that define the signal format.

Settings	Description
Standard	Specifies the standard used for the input signal: Phase 1, Phase 2.
Channel Bandwidth	This readout shows the nominal channel bandwidth based on the standard.
Modulation Type	Specifies the modulation type of the input signal. Choices vary depending on the selected standard. Modulation types for Phase 2 are HCPM (Inbound) and HDQPSK (Outbound). Phase 1 has only C4FM as the modulation type selection.

Table continued...

Settings	Description
Measurement Filter	Specifies the filter used as a measurement.
Reference Filter	Specifies the filter used as a reference.
Filter Parameter	Enter a value used for defining the Reference Filter. (Not present for some filter types)
Symbol Rate	This is a readout that shows the symbol rate for demodulating digitally modulated signals based on the standard. This rate is always 4.8 kHz for Phase 1 signals and 6 kHz for Phase 2 signals.

Symbol Rate

Specifies the symbol rate for demodulating digitally modulated signals based on the standard. The symbol rate and the bit rate are related as follows:

$$(\text{Symbol rate}) = (\text{Bit rate}) / (\text{Number of bits per symbol})$$

The bit rate used for Phase 1 (C4FM) is 9600 bps. For Phase 2 (HPCM and HDQPSK) it is 12000 bps. There are two bits per symbol for all above mentioned modulation types. Therefore, the symbol rate is 4800 Hz for Phase 1 and 6000 Hz for Phase 2.

Measurement and Reference Filters

The available measurement and reference filters depend on the selected modulation type. The following table shows the recommended filters for the specified modulation types.



CAUTION: Although there are other filter types listed in the drop down menu, if you select any filter other than that which is recommended, the measurement results may not be accurate.

Modulation type	Measurement filters	Reference filters
HDQPSK	HDQPSK-P25	None
HPCM	None	None
C4FM	C4FM-P25	RaisedCosine (Filter parameter 0.2)

The measurement filter is applied before the demodulation bit is detected and the ideal reference is calculated.

The reference filter is applied to the internally generated ideal reference signal before the modulation fidelity is calculated.

How to Select Filters

In a signal transmitter/receiver system, the baseband signal might be filtered for bandwidth limiting or for another kind of necessary shaping that needs to be applied. Normally, a filter in the transmitter (F_t) and a filter in the receiver (F_r) are applied.

The Measurement Filter setting in the analyzer corresponds to the baseband filter in the receiver (F_r): This setting tells the analyzer what filter your receiver uses. When the analyzer is set to the same filter used by the receiver, the analyzer sees the signal as your receiver would. The Measurement Filter setting should be the same as the filter used in the receiver under normal operation (as opposed to testing).

The Reference Filter setting in the analyzer corresponds to the baseband filter in the transmitter-receiver combination ($F_r * F_t$). The baseband filter for the transmitter-receiver combination is often referred to as the *System Filter*. This filter is called the reference filter because it is used to recreate a reference signal that is compared to the received signal. This recreated reference signal is the *ideal signal*.

with $F_r * F_t$ applied; differences between this *ideal signal* and the received signal enables the determination of signal quality, such as modulation fidelity measurements.

Filter Parameter (C4FM only)

The filter parameter specifies the alpha for the Raised Cosine filter when selected as the Reference filter. Some filter types have a fixed parameter value that is specified by industry standard, while other filter types by definition have no filter parameter. For filter types with no filter parameter, there is no filter parameter control present in the control panel. The recommended Reference filter for C4FM is Raised Cosine and the corresponding filter parameter for C4FM is 0.2.

Analysis Params Tab - P25

The Analysis Params tab contains parameters that control the analysis of the input signal.

P25 Summary Settings

Standard Presets

Modulation Params Analysis Params Analysis Time Trig Meas Test Patterns Limits

Frequency Error: Auto PTX:

Measurement BW:

Low pass cut off frequency (only for Frequency Deviation):

Settings	Description
Frequency Error	When the Auto box is checked, the analysis determines the Frequency Error and the measured Frequency Error is displayed. When the Auto box is unchecked, the entered value is used by the analysis as a fixed frequency offset. This is useful when the exact frequency offset of the signal is known.
Measurement BW	Specifies the bandwidth about the center frequency at which measurements are made. Select Manual, Auto, or Link to Span.
PTX	Specifies the RF Output Power as recommended for transmitters. This is only used in the computation of off slot power in HCPM modulated signals.
Low Pass cut off frequency (only for frequency deviation)	Specifies the filter cut off frequency for Frequency deviation measurement. This setting will only affect the scalar results Frequency Deviation (Positive and Negative Peak f1,f2,f3, and f4) in the Summary display. This selection is only visible when High or Low Deviation or Standard Transmitter Symbol Rate Pattern is chosen from the Test Patterns tab of the Settings Control panel.

Analysis Time Tab - P25

The Analysis Time tab contains parameters that define how the signal is analyzed in the P25 Analysis displays.

Modulation Params	Analysis Params	Analysis Time	Test Patterns	Prefs	Trig Meas
Analysis Offset: <input type="text" value="-204.800 us"/> <input checked="" type="checkbox"/> Auto Time Zero Reference: <input type="text" value="Trigger"/>					
Analysis Length: <input type="text" value="94.000 ms"/> <input type="checkbox"/> Auto Units: <input type="text" value="Seconds"/>					
Available: 31.816 ms					

Settings	Description
Analysis Offset	Specifies the location of the first time sample to use in measurements.
Auto	When enabled, causes the instrument to set the Analysis Offset value based on the requirements of the selected display.
Analysis Length	Specifies the length of the analysis period to use in measurements. Length is specified in either symbols or seconds, depending on the Units setting.
Auto	When enabled, causes the instrument to set the Analysis Length value based on the requirements of the selected display.
Actual	This is a displayed value, not a setting. It is the Analysis Length (time or symbols) being used by the analyzer, this value may not match the Analysis Length requested (in manual mode).
Time Zero Reference	Specifies the zero point for the analysis time.
Units	Specifies the units of the Analysis Length to either Symbols or Seconds.

Analysis Offset

Use analysis offset to specify where measurements begin. Be aware that you cannot set the Analysis Offset outside the range of time covered by the current acquisition data. (all time values are relative to the Time Zero Reference).

You can set the Analysis Length so that the requested analysis period falls partly or entirely outside the current range of acquisition data settings. When the next acquisition is taken, its Acquisition Length will be increased to cover the new Analysis Length, as long as the Sampling controls are set to Auto. If the Sampling parameters are set to manual, or if the instrument is analyzing saved data, the actual analysis length will be constrained by the available data length, but in most cases, measurements are able to be made anyway. The instrument will display a notification when measurement results are computed from less data than requested. Range: 0 to [(end of acquisition) - Analysis Length]. Resolution: 1 effective sample (or symbol).

Analysis Length

Use the analysis length to specify how long a period of time is analyzed. As you adjust this value, the actual amount of time for Analysis Length, in Symbol or Seconds units, is shown below the control in the "Actual" readout. This setting is not available when Auto is checked. Range: minimum value depends on modulation type. Resolution: 1 symbol.

Time Zero Reference

All time values are measured from this point (such as marker position or horizontal position (in Y vs Time displays). Choices are: Acquisition Start or Trigger. When a trigger measurement is chosen from the Trig Meas tab of the Settings control panel, Time Zero Reference is forced to Trigger.

Parameter	Description
Acquisition Start	Time zero starts from the point at which acquisition begins.
Trigger	Time zero starts from the trigger point.

Test Patterns Tab - P25

Test patterns allow the software to compare the measurement result to the standards limit. The list of available test patterns varies depending on which standard and modulation type is selected.

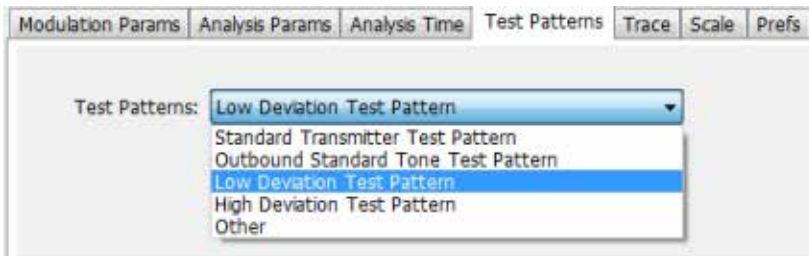

Settings	Description
Test Patterns	Use this drop-down list to select an appropriate test pattern. The list varies depending on which standard and modulation type is selected.

You can read more about test patterns [here](#).

Trace Tab - P25

The Trace tab allows you to set the trace display characteristics of the P25 trace display. The selections vary depending on the selected display.

The following image shows the tab for the Constellation and Eye Diagram displays. For the other trace displays, the Trace Type setting is not available.

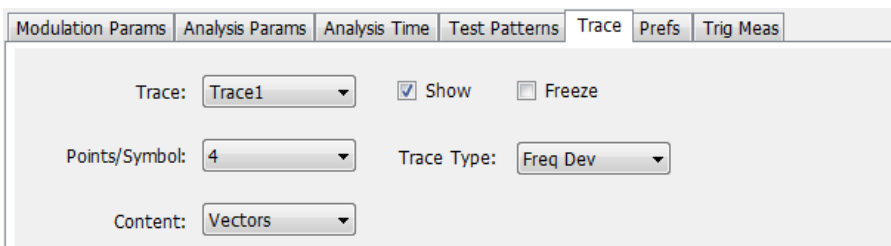

Setting	Description
Trace (P25 Constellation and P25 Eye Diagram displays only)	Select the trace to display. P25 Constellation display only: Select the trace that is hidden or displayed based on whether or not Show is selected.
Show (P25 Constellation and P25 Eye Diagram displays only)	Specifies whether the trace selected by Trace is displayed or hidden.
Freeze (P25 Constellation display only)	Halts updates to the trace selected by the Trace setting. Present for the Constellation display only.
Points/Symbol	Select how many points to use between symbols when connecting the dots. Values: 1, 2, 4, 8.
Content (P25 Constellation and P25 Freq Dev & Time displays only)	Select whether to display the trace as vectors (points connected by lines), points (symbols only without lines), or lines (lines drawn between symbols, but no symbols are displayed). The choices available depend on the display.
Trace Type (P25 Constellation and P25 Eye Diagram displays only)	Select to specify whether the plots in the Constellation and Eye Diagram displays are shown as I vs Q or as Frequency Deviation.

Scale Tab - P25

The Scale tab allows you to change the scale settings that control how the trace appears on the display but does not change control settings such as Measurement Frequency. There are three versions of the Scale tab for P25 displays.

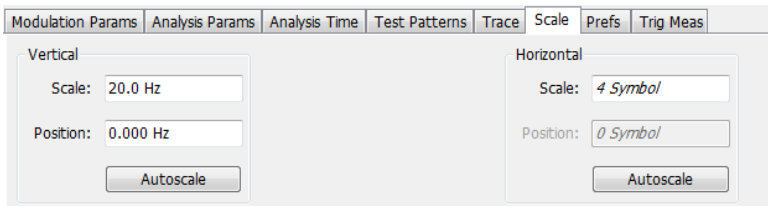

Figure 99: Scale tab for the P25 Eye Diagram display

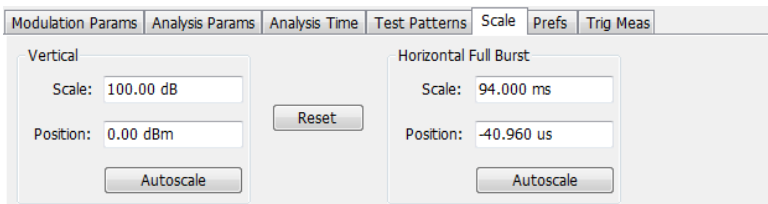

Figure 100: Scale tab for the P25 Power vs Time display

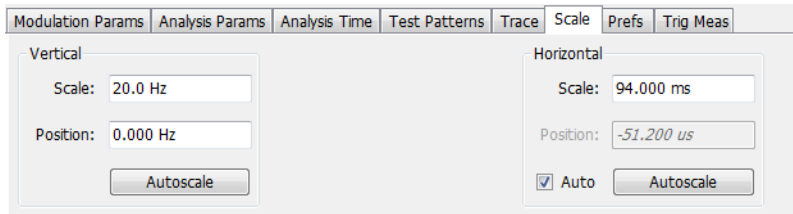

Figure 101: Scale tab for the P25 Freq Dev vs Time display

Settings	Description
Vertical	Controls the vertical position and scale of the trace display.
Scale	Changes the vertical scale of the graph.
Position	Adjusts the reference level away from top of the graph.
Autoscale	Resets the scale of the vertical axis to contain the complete trace.
Horizontal	Controls the span of the trace display and position of the trace.
Horizontal Full Burst	
Scale	Allows you to, in effect, change the span.
Position	Allows you to pan a zoomed trace without changing the Measurement Frequency. Position is only enabled when the span, as specified by Freq/div, is less than the acquisition bandwidth.
Autoscale	Resets the scale of the horizontal axis to contain the complete trace.
Auto	When Auto is checked, the scale and position values for the Symbols graph are automatically adjusted to maintain the optimal display.
Reset	Resets the vertical and horizontal settings.



Note: The Units used for the horizontal scale can be either Seconds or Symbols. To set the units for the horizontal scale, display the Analysis Time tab. On the tab, select the appropriate units from the Units drop-down list.

Trig MeasTab - P25

The Trig Meas tab enables you to choose a trigger measurement. The available measurements in the drop-down menu depend on the standard and modulation type selected in the Modulation Params tab. The Trig Meas tab is not available for Phase 2 HDQPSK (Outbound) signals. You can read more about P25 trigger related measurements [here](#).

The following image shows the tab for Phase 1 (C4FM) signals.

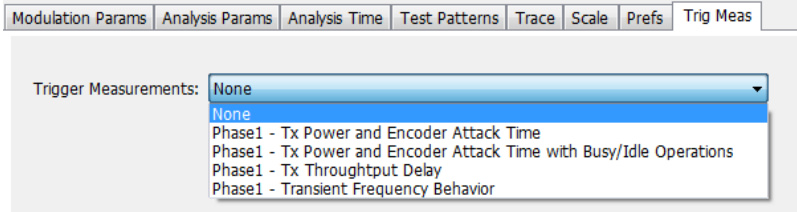

The following image shows the tab for Phase 1 (HCPM Inbound) signals.

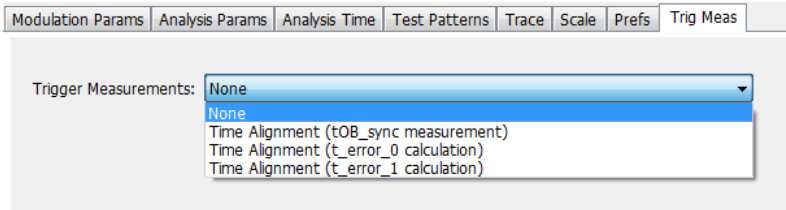

Settings	Description
Trigger Measurements	Select the trigger measurement test.

Prefs Tab - P25

The Prefs tab enables you to change appearance characteristics of the P25 Analysis displays. Not all settings on the Prefs tab shown below appear for every P25 display. The Summary display does not have a Prefs tab.

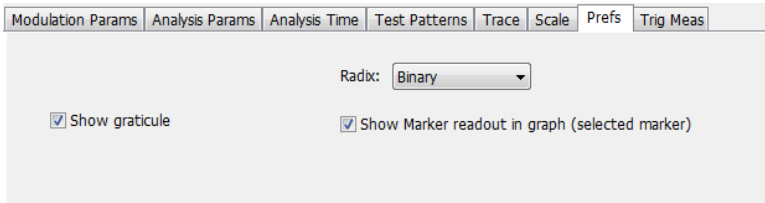

Setting	Description
Show graticule	Shows or hides the graticule.
Show Marker readout in graph (selected marker)	Shows or hides the readout for the selected marker in the graph area.
Radix	Specifies how symbols are displayed in the Symbol Table display and in the Marker readout in the display. There are three choices for Radix: Binary (00,01,10,11), Quaternary (0,1,2,3), and Modulation Symbols (+1,+3,-1,-3).

Limits Tab - P25

The Limits tab is only available for the P25 Summary display. It enables you to load an existing limits table, save a limits table, or edit limits values.

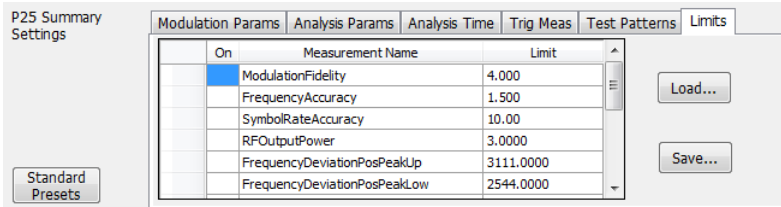

Setting	Description
Load	Click to load a saved Limits table from a .csv file.
Save	Click to save the current Limits table to a .csv file.

Edit Limits

To directly edit measurement limits in the table, click on the value in the Limit column that you want to change.

The following table describes the parameters that are set in the Limits Table.

Table 28: Limits Table Settings

Setting	Description
On	Click on the cell in the On column next to the measurement to specify whether or not measurements are selected for limit comparison to indicate Pass or Fail.. A check mark means the measurement will be taken. An empty box means it will not be taken.
Measurement Name	Specifies the name of the measurement related to the limit. (Not editable.)
Limit	Specifies the value of the limit to the related measurement. When the cell is selected, the value is shown along with the units.

LTE Analysis

LTE Overview

The Long Term Evolution (LTE) Downlink RF Measurements Analysis option allows you to evaluate RF signals to ensure that they meet 3GPP measurements. These are described in the TS 36.104 Base Station (BS) radio transmission and reception and test specifications TS36.141 Base Station (BS) conformance testing documents version 12.5. This analysis option supports both LTE TDD and LTE FDD frame structures. This analysis option supports the following measurements.

- Channel Power
- Occupied Bandwidth
- Adjacent Channel Leakage Ratio (ACLR)
- Spectral Emission Mask (Operating Band Unwanted Emission)
- Cell ID
- For TDD LTE Transmitter Off Power
- Reference Signal Power

These measurements are also compared with the limits provided by the standard to give pass/fail results (except for Channel Power and OBW).

More detailed information about these measurements is available in the [LTE measurements](#) on page 524 section and the supported measurements [table](#).

You can also select these measurements from four LTE preset test setups. The test setups load pre-configured displays and control setting as suggested by the standard to accelerate the test setup of the analyzer. The following four test setups are available for this analysis option.

- Cell ID
- ACLR
- Channel Power and TDD Toff Power
- SEM

More detailed information about these test setups is available [here](#).

With the LTE downlink RF Measurement Analysis test suite, test engineers can simplify the execution of a number of transmitter tests while still enabled to modify signal parameters for in-depth signal analysis. The analysis results give multiple views of LTE signal characteristics to allow the diagnosis of signal imperfections and impairments quickly and easily. Display controls allow you to selectively display the analysis results to help locate trouble spots in the signal.

LTE topics in this Help

The following information about the LTE Analysis option is available:

- [Reference table of supported LTE measurements](#)
- [LTE measurements](#)
- [LTE Standards preset test setups](#) on page 517
- [LTE displays](#) on page 523
- [LTE measurement control settings](#)

Supported LTE measurements

The following table gives a brief description of the available LTE measurements. More detailed information can be found here. [LTE measurements](#) on page 524

LTE measurement	LTE standard(s)	Description
Cell ID detection	TDD FDD	The Cell ID is detected from the input LTE signal.
Adjacent Channel Leakage Ratio (ACLR)	TDD FDD	The Adjacent Channel integrated power is calculated and shown. The relative power compared to the reference signal is also computed. The computed power is compared against limits suggested by the selected standard and pass/fail is reported. The appropriate settings for this measurement are loaded with the ACLR test setup (Presets > Standards > LTE).
Channel Power	TDD FDD	The channel power is calculated in the channel bandwidth.
Occupied Bandwidth	TDD FDD	The Occupied bandwidth is calculated as bandwidth containing 99% of the total integrated power in the selected span around the selected center frequency.
Operating Band Unwanted Emission	TDD FDD	The power in the offset regions is calculated and presented and compared against limits set in the offset and limits table and pass/fail is reported. The appropriate settings for this measurement are loaded with the SEM test setup (Presets > Standards > LTE).
Toff	TDD	The power in off-slot region is computed and compared against selected limits.
Reference Signal Power	TDD FDD	Measures the power of cell specific reference signals.

LTE Standards preset test setups

Presets > Standards

The LTE Standards preset allows you to access displays preconfigured for the test setup you select. The test setups load the displays and control setting options suggested by the LTE standard to perform the measurements. You can read more about how Presets work [here](#).

There are four test setups for LTE:

- Cell ID

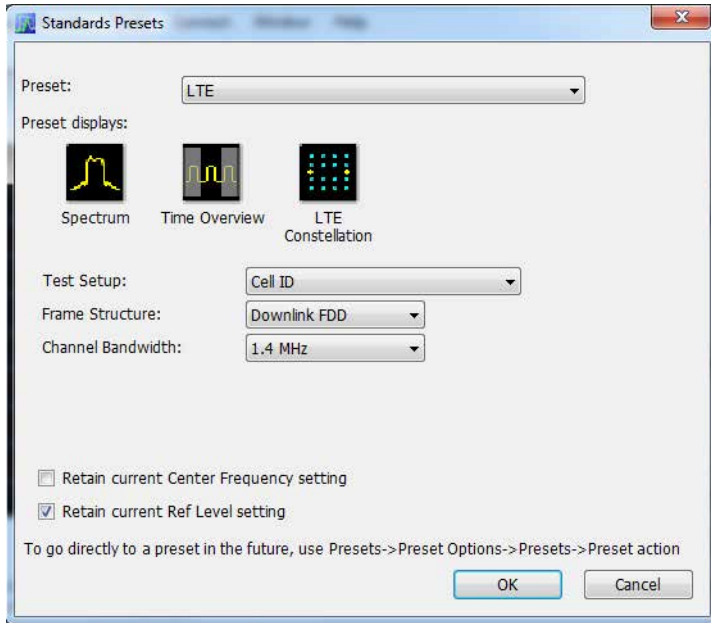

- ACLR

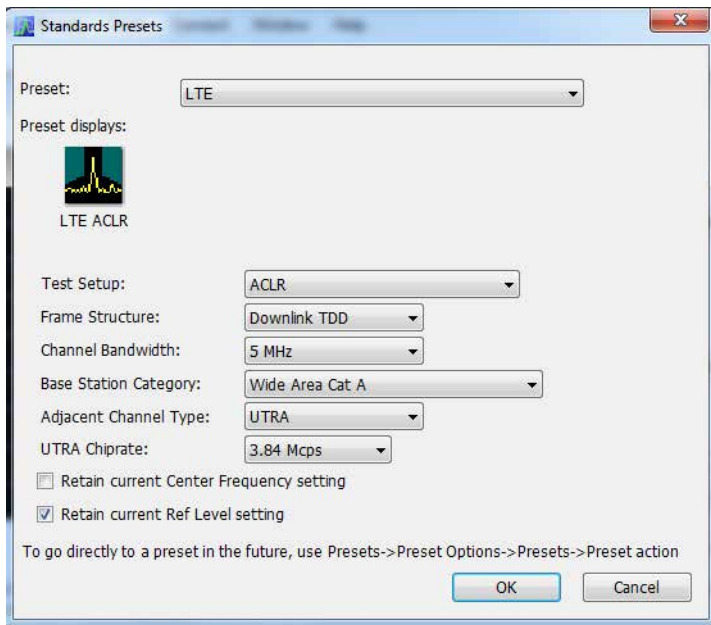

- Channel Power and TDD Toff Power

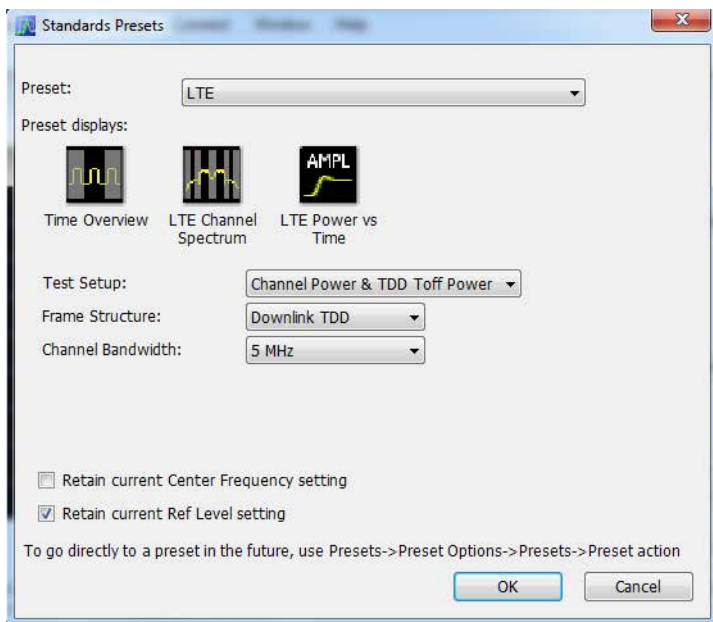

- SEM

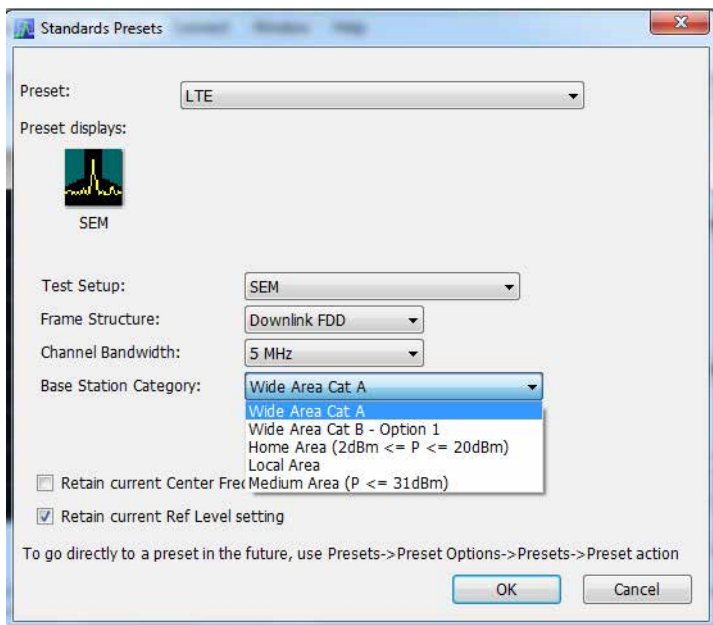

The following table shows what automatically loads with each test setup.

Table 29: LTE preset test setups

Test setup	Displays loaded with preset
<p>Cell ID</p> <p>Frame structure:</p> <ul style="list-style-type: none"> - Downlink FDD - Downlink TDD <p>(Default is Downlink FDD.)</p> <hr/> <p>Channel bandwidth: 1.4, 3, 5, 10, 15, 20 MHz</p> <p>(Default is 1.4 MHz.)</p>	<p>Spectrum, Time Overview, LTE Constellation</p>

Table continued...

Test setup	Displays loaded with preset
ACLR	LTE ACLR
Frame structure:	
- Downlink FDD	
- Downlink TDD	
(Default is Downlink FDD.)	
Channel bandwidth: 1.4, 3, 5, 10, 15, 20 MHz	
(Default is 1.4 MHz.)	
Base station category:	
- Wide Area Cat A	
- Wide Area Cat B — Option 1	
- Home Area (P-rated \leq 20 dBm)	
- Local Area (P-rated \leq 24 dBm)	
- Medium Area (P-rated \leq 38 dBm)	
(Default is Wide Area Cat A.)	
Adjacent channel type:	
- UTRA	
- E-UTRA	
(Default is UTRA.)	
UTRA chip rate.	
1.28 Mcps	
3.84 Mcps	
7.68 Mcps	
Chip rate is only displayed under the following conditions:	
TDD is frame structure	
Adjacent channel type selected is UTRA	
Channel bandwidth is >3 MHz	
(Default chip rate is 3.84 Mpcs.)	

Table continued...

Test setup		Displays loaded with preset
Channel Power and TDD Toff Power	<p>Frame structure:</p> <ul style="list-style-type: none"> - Downlink FDD - Downlink TDD <p>(Default is Downlink FDD.)</p> <hr/> <p>Channel bandwidth: 1.4, 3, 5, 10, 15, 20 MHz</p> <p>(Default is 1.4 MHz.)</p>	<p>Time Overview (TDD only), LTE Channel Spectrum, LTE Power vs Time (TDD only)</p>
SEM	<p>Frame structure:</p> <ul style="list-style-type: none"> - Downlink FDD - Downlink TDD <p>(Default is Downlink FDD.)</p> <hr/> <p>Channel bandwidth: 1.4, 3, 5, 10, 15, 20 MHz</p> <p>(Default is 1.4 MHz.)</p> <hr/> <p>Base station category:</p> <ul style="list-style-type: none"> - Wide Area Cat A - Wide Area Cat B — Option 1 - Home Area (2 dBm ≤ P ≤ 20 dBm) - Local Area - Medium Area (P ≤ 31 dBm) <p>(Default is Wide Area Cat A.)</p>	SEM

Retain current center frequency and reference level settings

The **Retain current Center Frequency setting** appears when the LTE Standards Preset is chosen. This setting allows you to retain the previously used center frequency. By default, the Center Frequency setting box is unchecked and the LTE preset displays will load with 1.96 GHz for FDD and 1.9 GHz for TDD.

The **Retain current Ref Level setting** appears when the LTE Standards Preset is chosen. This setting allows you to retain the previously used reference level. By default, the Ref Level setting box is checked.

To activate these settings, check the box next to the desired setting. The following image shows the **Retain current Ref Level setting** box checked.

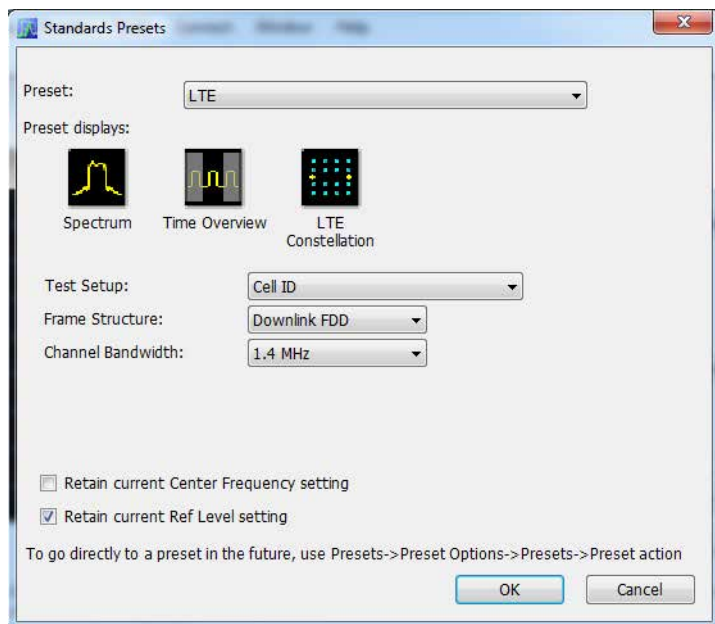

LTE displays

The displays in LTE Analysis (Setup > Displays > Measurements: LTE Analysis) are:

- [LTE Channel Spectrum](#)
- [LTE ACLR](#)
- [LTE Constellation](#)
- [LTE Power vs Time](#)
- [SEM](#) (This display is not an LTE specific display, but is available when RF Measurements is selected from the Select Displays dialog (Setup > Displays) (see the following image).)

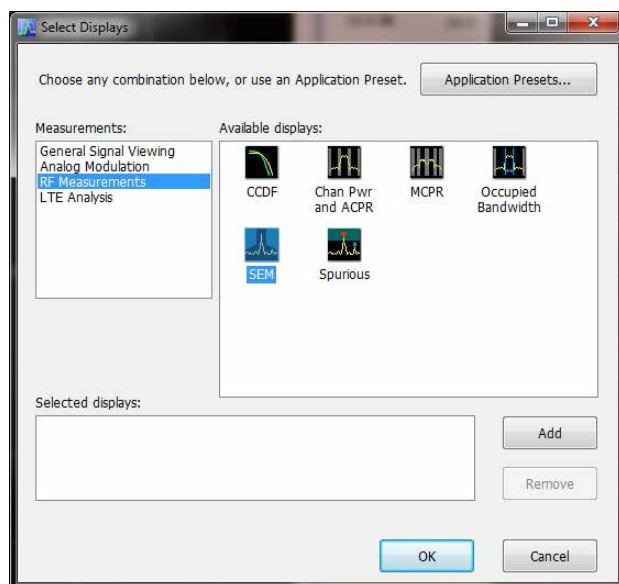

LTE measurements

LTE Analysis enables RF measurements and detection of Cell ID in the transmitted signal for both TDD and FDD frame structure LTE signals. For TDD signals, the analysis will also do the T_{OFF} measurement. The following topics contain important information you should know about specific LTE measurements. You can view a table with all of the available measurements [here](#).

Channel Power and Occupied Bandwidth (TDD and FDD)

The Channel Power measurement is done by calculating the power in the LTE signal based on the selected channel bandwidth option. The Occupied Bandwidth measurement calculates the frequency range over which 99% of the power is contained in the acquired signal. This measurement is done for the selected channel bandwidth option.

More information about this measurement:

- Select the Channel Power and TDD Toff Power test setup from Presets > Standards > LTE to perform the measurement. This will load the displays found in the [LTE preset test setups table](#).
- This test setup allows you to choose the frame structure and the channel bandwidth.
- The Channel Spectrum display will contain the results of Channel Power and Occupied Bandwidth. The result gives the power in the LTE signal (calculated over the channel bandwidth).
- Results are presented as scalar and are located below the display.
- For TDD signals, the channel power and the occupied bandwidth measurement are done on the on-slot region. If the valid on-slot region is not found, the measurement is done in the selected analysis length.

ACLR (FDD and TDD)

The Adjacent Channel specification and limits for comparison are set based on selected frame structure, adjacent channel and base station types from Standards Presets. It calculates the integrated power in the different adjacent regions and also indicates pass/fail based on comparison with absolute and relative limits in LTE ACLR display.

More information about this measurement:

- Select the ACLR test setup from Presets > Standards > LTE to perform the measurement. This will load the displays found in the [LTE preset test setups table](#).
- This test setup allows you to select the frame structure, channel bandwidth, base station type, and adjacent channel type with the following restrictions:
 - Frame Structure can be TDD or FDD
 - Channel Bandwidth can be 1.4, 3, 5, 10, 15, or 20 MHz
 - Base station type can be Wide Area Cat A, Wide Area Cat B- Option 1, Home Area (P-rated ≤ 20 dBm), Local Area (P-rated ≤ 24 dBm), Medium Area (P-rated ≤ 38 dBm)
 - Adjacent Channel type can E-UTRA or UTRA
 - UTRA chip rate can be 1.28, 3.84, or 7.68 Mcps

Default rate is 3.84 Mcps for all UTRA adjacent channels of FDD and when channel bandwidth is 1.4 or 3 MHz.

However, you can choose other rates when the frame structure is TDD and when the bandwidth is more than 3 MHz. Otherwise, the standard recommends use of 3.84 Mcps.

- Based on the settings you select from Standards Preset, the offset and bandwidth of the adjacent channels are set in the Offset and Limits tab of the control panel. The settings are different for paired and unpaired spectrum.
- The settings also include the absolute power limit for comparison based on the base station type. The standard recommends the settings in dBm/MHz for each base station type. The power limits are appropriately scaled with the integration bandwidth and presented in dBm in the Offset and Limits table of the display. The integrated power in each adjacent band is compared with the absolute and relative limits as recommended by the standard. The absolute limits are dependent on this choice of base station type because they apply to different power levels (as the P-rated levels in the drop down menu indicate). The relative limit is also set.

- The results are presented in both tabular and display format. In the tabular display, the reference channel power and the offset, bandwidth, integrated power, and relative power of the adjacent channels are presented. An expanded view format is also available.
- The integrated power in the display is shaded blue in each adjacent channel region.
- Each adjacent channel is clearly shown. Interadjacent channel gaps are shown in gray.
- The limit lines are shown in different colors. Based on the Mask option chosen in the Offset & Limits table, failures in the different bands are shown in red on violation. By default for LTE Standards Presets, the Mask option is Abs & Rel, so the failure is shown only when the calculated power violates both relative and absolute power limits.
- The respective rows that violate both absolute and relative limits are also shown in red. Pass/fail information appears in the top left corner of the display.
- This measurement can be performed in Real Time or Non-Real Time mode. In Real Time mode, a single acquisition required for the entire span needed for this measurement is taken and the measurement is done. In the Non-Real Time mode, a separate acquisition for each adjacent channel region is taken and analyzed.

Non-real time mode is also useful when the bandwidth offered by the instrument does not support the span requirement for this measurement. The span requirement comes from the choice of adjacent channel type and channel bandwidth. In such cases, Non-Real Time mode can be used.

- For UTRA adjacent channels, filtering of the adjacent channels with an RRC filter of the same bandwidth is employed, as suggested by the standard. The chip rate is set to 3.84 Mcps for FDD and when the channel bandwidth is 1.4 or 3 MHz. For TDD, when the channel bandwidth is more than 3 MHz, you can choose the UTRA chip rate from the ACLR test setup (Presets > Standards > LTE). The options are 1.28, 3.84, and 7.68 Mcps.
- The standard recommends this measurement be done on the transmitter ON period when the signal being analyzed is TDD. An on slot detection module in the analysis helps you to do the measurement in the transmitter ON period.
 - If you are doing the measurement in Real Time, you can also load the Time Overview display, which will indicate to you the region in which the measurement is done (a purple line at the bottom). You can see the measurement is done only on the valid transmitter ON period. However, when a bursty data is not available, the measurement is done on the available analysis length.



Note: Real-Time mode can be set from the [Parameters tab](#) of the Settings control panel of the LTE ACLR display. Disabling Real-Time mode is the non-Real-Time setting.

- When the measurement is done in non-Real Time mode, separate acquisitions are obtained for each adjacent channel band. In such cases, it cannot be ensured that all the adjacent channel acquisitions are done on the transmitter ON period. It is recommended that you use either Real time mode or an external trigger from the source (when used with non-Real-Time mode) to do the measurement. An external trigger from the source can ensure that all the acquisitions are done just after the rising edge of the burst. A status message in the display indicates when to use Real-Time mode or external trigger for TDD signals. The status message that is displayed in the LTE ACLR display is "Signal must be triggered or measurement in Real-Time". This message is displayed when TDD is chosen from Standard Presets, when Real-Time is not enabled from the Parameters tab of the control panel, and when the instrument is in Free Run mode.

Operating Band Unwanted Emission (FDD and TDD)

This measurement finds the power in the offset regions recommended by the standard. The offset channel specification and limits for comparison are set based on the selected channel bandwidth, frame structure, and base station types in Standards Preset. It calculates the integrated power in the different offset regions and also indicates pass/fail information based on comparison with absolute and relative limits in the SEM display.

More information about this measurement:

- Select the SEM test setup from Presets . Standards . LTE to perform the measurement. This will load the displays found in the [LTE preset test setups table](#).
- This test setup allows you to select the frame structure, channel bandwidth, and base station type with the following restrictions:
 - Frame Structure can be TDD or FDD
 - Channel Bandwidth can be 1.4, 3, 5, 10, 15, or 20 MHz

- Base station type can be Wide Area Cat A, Wide Area Cat B - Option 1, Home Area ($2 \text{ dBm} \leq P \leq 20 \text{ dBm}$), Local Area, Medium Area ($P \leq 31 \text{ dBm}$)
- Based on the settings chosen by the user from Standards Presets the offset and bandwidth of the offset channels are set in the Offset and Limits tab of the control panel of SEM display.
- The settings also include the absolute power limit for comparison based on the base station type. The standard recommends the settings in dBm/MHz for each base station type. The power limits are appropriately scaled with the integration bandwidth and presented in dBm in the Offset and Limits table of the display. The integrated power in each adjacent band is compared with the absolute and relative limits as suggested by the standard. The absolute limits are dependent on this choice of base station type as they apply to different power levels (as the P-rated levels in the drop down menu indicate). The relative limit is also set.
- The results are presented both in tabular and display form.
- The Pass/ Fail information is also shown in the top left corner of the display.
- For TDD signals, a detection module in the analysis helps you to do the measurement in the transmitter ON period.
 - If you are doing the measurement in Real Time, you can also load the Time Overview display, which will indicate to you the region in which the measurement is done (a purple line at the bottom). You can see the measurement is done only on the valid transmitter ON period. However, when a bursty data is not available, the measurement is done on the available analysis length.



Note: Real-Time mode can be set from the [Parameters tab](#) of the Settings control panel of the SEM display. Disabling Real-Time mode is the non-Real-Time setting.

- When the measurement is done in non-Real Time mode, separate acquisitions are obtained for each adjacent channel band. In such cases, it cannot be ensured that all the adjacent channel acquisitions are done on the transmitter ON period. It is recommended that you use either Real-Time mode or an external trigger from the source (when used with non-Real Time mode) to do the measurement. An external trigger from the source can ensure that all the acquisitions are done just after the rising edge of the burst. A status message in the display indicates when to use Real Time mode or external trigger for TDD signals. The status message that is displayed in the LTE SEM display is "Signal must be triggered or measurement in Real-Time". This message is displayed when TDD is chosen from Standard Presets, when Real-Time is not enabled from the Parameters tab of the control panel, and when the instrument is in Free Run mode.
- Settings for all tables provided in the base station conformance testing document (3GPP TS 36.141 v12.5 – for Release 12) has been incorporated from Standards Presets.
 - Wide Area and Local area settings from standard presets are provided as per the standard document.
 - Home Area base station settings loaded from standard presets correspond to Reference power levels between 2 to 20 dBm.
 - Medium Area base station settings loaded from standard presets correspond to reference power levels less than 31 dBm.
- The following settings are provided in a *.csv file that you can load. These files will be available in the installed directory (Example Files\LTE).
 - Wide Area category B Option 2 (for specific bands specified by the standard). There are three csv files based on operating band and channel bandwidth for Wide Area.
 - LTE_SEM_1.4MHz_CatB_optn2_bands_3_8.csv
 - LTE_SEM_3MHz_CatB_optn2_bands_3_8.csv
 - LTE_SEM_5to20MHz_CatB_optn2_bands_1_3_8_32_33_34.csv
 - Home Area base station for power level less than 2 dBm. There are six csv files based on operating band and channel bandwidth for Home Area.
 - LTE_SEM_1_4MHz_above3GHz_Home2P.csv
 - LTE_SEM_1_4MHz_below3GHz_Home2P.csv
 - LTE_SEM_3MHz_above3GHz_Home2P.csv
 - LTE_SEM_3MHz_below3GHz_Home2P.csv
 - LTE_SEM_5to20MHz_above3GHz_Home2P.csv
 - LTE_SEM_5to20MHz_below3GHz_Home2P.csv

- Medium Area base station for reference power level between 31 to 38 dBm. There are six csv files based on operating band and channel bandwidth for Medium Area.
 - LTE_SEM_1_4MHz_above3GHz_Medium31P38P.csv
 - LTE_SEM_1_4MHz_below3GHz_Medium31P38.csv
 - LTE_SEM_3MHz_above3GHz_Medium31P38.csv
 - LTE_SEM_3MHz_below3GHz_Medium31P38.csv
 - LTE_SEM_5to20MHz_above3GHz_Medium31P38.csv
 - LTE_SEM_5to20MHz_below3GHz_Medium31P38.csv
- Additional requirements given in Section 6.6.3.5.3 in 3GPP TS 36.141 v12.5 standard document. There are 14 csv files based on the requirements in the standard document. The files are named based on the table numbers of Section 6.6.3.5.3 of the standard document (3GPP TS 36.141 V12.5.0 (2014-09)).

Cell ID (TDD and FDD)

The dominant Cell ID in the transmitted LTE signal is detected and presented in the Constellation display. Along with the Cell ID scalar results, the group and sector ID are also presented. The constellation of the Primary and Second Synchronization signals are presented too.

More information about this measurement:

- Select the Cell ID test setup from Presets > Standards > LTE to perform the measurement. This will load the displays found in the [LTE preset test setups table](#).
- This test setup allows you to select the frame structure and channel bandwidth with the following restrictions:
 - Frame Structure can be TDD or FDD
 - Channel Bandwidth can be 1.4, 3, 5, 10, 15, or 20 MHz
- Analysis of the LTE signals is done based on the settings you choose in the Standards Presets.
- The constellation for PSS and SSS (Primary and Secondary Synchronization Signals) are shown. You can optionally select to view only the PSS or SSS constellation (selection is made in the Trace tab).
- Equalization based on PSS (Primary Synchronization Signal) data can be enabled using the "Enable Equalization" option (available in the Analysis Params tab of the Settings Control panel.) This Equalization is based on PSS data and applied on other parts of the OFDM symbol.

Reference Signal Power (TDD and FDD)

Reference Signal Power measures the power of cell specific reference signals. Reference signals are spread across time and frequency. Reference signal position is dependent on the Cell ID, bandwidth, and antenna ports. For Downlink TDD (frame structure type 2), the position of reference signals is also dependent on uplink-downlink and special subframe configurations.

Toff (TDD)

The Toff measurement is done only for the TDD signal. It is a measure of the off slot power in a LTE TDD signal.

More information about this measurement:

- Select the Channel Power and TDD Toff Power test setup from Presets > Standards > LTE to perform the measurement. This will load the displays found in the [LTE preset test setups table](#).
- This test setup allows you to select the frame structure and channel bandwidth with the following restrictions:
 - Frame Structure can be TDD or FDD
 - Channel Bandwidth can be 1.4, 3, 5, 10, 15, or 20 MHz
- Analysis of the LTE signals is done based on the settings you choose in the Standards Presets.

- By default, the Toff measurement is the average of several non-overlapping and adjoining 70 μs windows in the off slot region. This measurement is done only on the 70 μs window in the center of the off slot region, when the **Average over entire offslot region** option is disabled.
- The scalar result is presented in dBm/MHz.
- The result is compared against limits that can be defined using the Limits tab of the control panel. By default, these limits are set based on the Base Station conformance testing document (3GPP TS 36.141 v12.5 – for Release 12). Pass/fail is shown in the top left corner of the LTE Power vs Time display.

LTE Status Messages

The following status messages may appear. Each message indicates the related condition (Description) shown in the following table.

Status message	Description
LTE Analysis: Signal must be triggered or measured in Real Time	<p>Shown in the display and status bar when the user attempts to make the ACLR measurement and SEM measurement for TDD signals in non-Real-Time mode and when the instrument is in free run.</p> <p>Since the standard recommends the ACLR measurement to be done in transmitter ON periods only, either the measurement has to be done in Real-Time mode (in which a detection module ensures the measurement is done on the transmitter ON period) or has to be externally triggered if in non-Real-Time mode.</p>
LTE Analysis: Recovery done on PSS/SSS on the center 62 carriers	<p>Shown in the status bar to indicate that the constellation of PSS and SSS shown in the LTE constellation is done based on analysis of PSS and SSS signals in the center 62 carriers of the corresponding OFDM symbols.</p> <p>Therefore, you may see the correct constellation and Cell ID even when a different channel bandwidth is chosen from the control panel because the analysis for PSS and SSS is done only on the center carriers.</p>
LTE Analysis: Analysis Failure - Synchronization Sequence not found	<p>Shown in the status bar to indicate that a valid Cell ID (from PSS and SSS) is not detected.</p>

LTE ACLR display

The LTE Adjacent Channel Leakage Ratio (ACLR) display shows the ratio of the mean power centered on the assigned channel frequency to the mean power centered on an adjacent channel frequency. In the 3GPP specification, both the main channel and adjacent channels are required to be filtered with RRC (Root Raised Cosine) filters.

To show the LTE ACLR display you can select **Presets > Standards > LTE**.



Note: Loading the LTE ACLR display from the **Presets > Standards > LTE** menu is recommended. This loads the control settings based on the selected options.

You can also load the LTE ACLR display as follows:

1. If you are analyzing a stored data file, recall the data file now. Otherwise, go to the next step.
2. Press the **Displays** button or select **Setup > Displays**.
3. In the **Select Displays** window, select **LTE Analysis** in the **Measurements** box.
4. In the Available displays box, double-click the **LTE ACLR** icon or select the icon and click **Add**. The LTE ACLR icon will appear in the **Selected displays** box and will no longer appear under Available displays.

5. Click the **OK** button to show the display.
6. Select **Setup > Settings** to display the control panel.
7. Select **Replay/Run** to take measurements on the acquired data.
8. If you are analyzing a data file, press the **Replay** button to take measurements on the recalled acquisition data file.

Elements of the Display

The following image shows the LTE ACLR display.

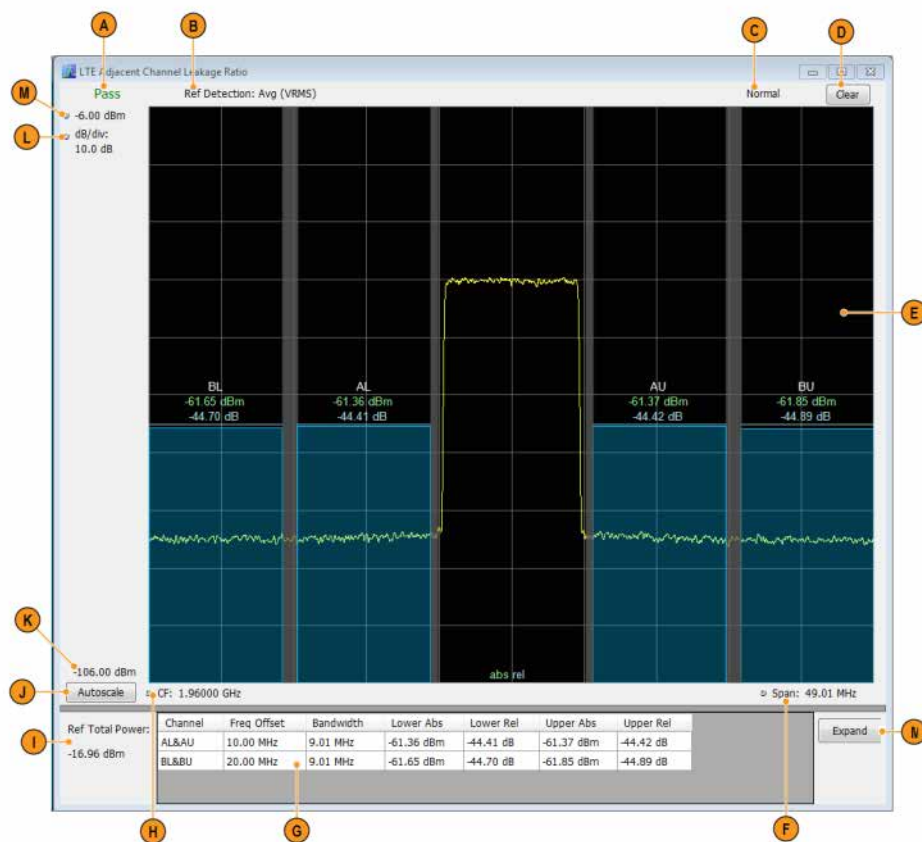

Item	Display element	Description
A	Pass/Fail	Indicates Pass or Fail based on Absolute and Relative limits set by the user. The failure condition is set by Mask in the Offset and Limits Table tab of the Settings control panel. By default, the mask is set to Abs & Rel, meaning failure is reported only when both absolute and relative results fail against the respective limits.
B	Ref Detection	Set to Avg (VRMS) or +Peak based on the choice made in Processing tab of the Settings control panel.
C	Normal	Indicates how the result is presented over multiple sweeps. This selection is made in the Processing tab of the control panel. Displays Average Count if Avg (VRMS) is checked in the Processing tab in the Settings control panel.

Table continued...

Item	Display element	Description
D	Clear	Resets measurement. Clears all values.
E	Plot	Shows the reference channel and adjacent channels and the regions in between them. The Absolute and Relative limit lines are also shown. The integrated power is shown as a band. Scalar results are also shown.
F	Span	Adjust the span of the graph in symbols.
G	Results Table	Tabulates the results in each adjacent band. Table shows the offset, bandwidth, Integrated Absolute and Relative power in the upper and lower adjacent channel regions.
H	CF	Center Frequency at which the measurement is performed.
I	Ref Total Power	Gives the power in the Reference channel.
J	Autoscale	Adjusts the vertical and horizontal settings so that the entire trace fits in the graph.
K	Bottom readout	Displays the value indicated by the bottom of graph.
L	dB / div	Shows the dB per each division in the Y axis of the plot.
(not shown)	Units	Sets the global Amplitude units for all the views in the analysis window. This will change the amplitude selection in the Units tab of the Amplitude control panel.
M	Top of graph	The vertical scale is normalized with appropriate power units.
N	Expand button	Shows the results table in its own window with larger font size.

Clicking on the **Expand** button allows you to view the results table in a separate window, as shown in the following image.

Channel	Freq Offset	Bandwidth	Lower Abs	Lower Rel	Upper Abs	Upper Rel
AL&AU	7.50 MHz	3.84 MHz	-61.53 dBm	-46.95 dB	-61.11 dBm	-46.53 dB
BL&BU	12.50 MHz	3.84 MHz	-61.53 dBm	-46.95 dB	-61.32 dBm	-46.73 dB

LTE ACLR Settings

Main menu bar: Setup > Settings



The LTE ACLR Settings control panel provides access to settings that control parameters of the LTE ACLR display.

Settings tab	Description
Channels	Allows you to control how the measurement is performed. When in Real Time, the RBW and VBW settings apply for all channels (including offset regions) and the other parameters apply only for the reference channel. When Non-Real Time mode is selected, all information in this tab, including RBW and VBW, only applies to the reference channel.
Parameters	Specifies several characteristics that control how the measurement is made. These parameters are used by the instrument to analyze the input signal.
Processing	Specifies settings for detection on the reference channel and the offsets. Specifies the function setting on how calculations are done across multiple sweeps.
Offsets & Limits Table	Allows you to select the characteristics of offsets and mask limits.
Scale	Specifies the vertical and horizontal scale settings.
Prefs	Allows you to select to show or hide the graticule, power level, limits, and marker readouts.

LTE Channel Spectrum display

The LTE Channel Spectrum display shows the spectrum of the input signal across one channel. Channel power measures the average power within the selected bandwidth and is expressed in dBm. Other units can be selected from the Units tab of the Analysis control panel. The measured occupied bandwidth is calculated as the bandwidth containing 99% of the total integrated power within the selected span around the selected center frequency.

To show the LTE Channel Spectrum display:

1. If you are analyzing a stored data file, recall the data file now. Otherwise, go to the next step.
2. Press the **Displays** button or select **Setup > Displays**.
3. From the **Measurements** box, select **LTE Analysis**.
4. Double-click the **LTE Channel Spectrum** icon in the **Available Displays** box. This moves the LTE Channel Spectrum icon to the **Selected displays** box.
5. Click **OK** button to view the display.
6. Select **Setup > Settings** to display the control panel.
7. Select **Replay/Run** to take measurements on the acquired data.
8. If you are analyzing a data file, press the **Replay** button to take measurements on the recalled acquisition data file.

Elements of the Display

The following image shows the LTE Channel Spectrum display.

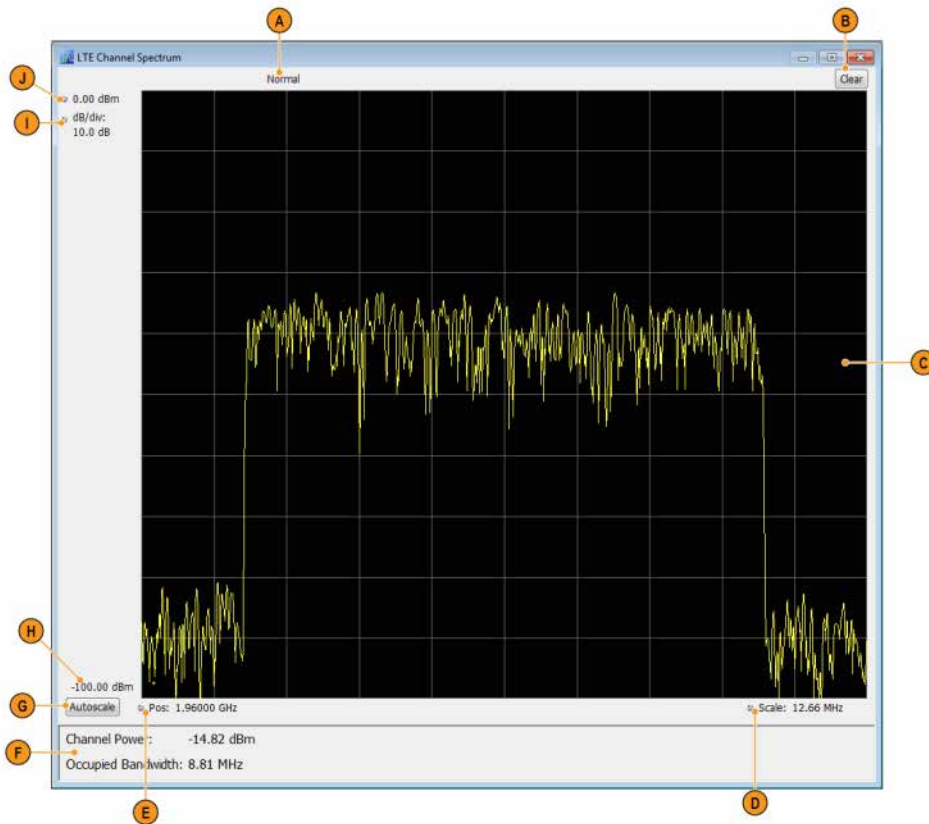

Item	Display element	Description
A	Normal	Displays Average Count if Average is turned on (set to Time Domain or Frequency Domain) from the Measurement Params tab in the Settings control panel.
B	Clear	Resets measurement. Clears all values.
C	Plot	Specifies the value shown at the center of the graph display.
D	Scale	Adjust the span of the graph.
E	Position	Displays the horizontal position of the trace on the graph display.
F	Scalar results	Shows the Channel Power and Occupied Bandwidth measurement results.
G	Autoscale	Adjusts the vertical and horizontal settings so that the entire trace fits in the graph.
H	Bottom readout	Displays the value indicated by the bottom of graph.
I	dB / div	Shows the dB per each division in the Y axis of the plot.
(not shown)	Units	Sets the global Amplitude units for all the views in the analysis window. This will change the amplitude selection in the Units tab of the Amplitude control panel.

Table continued...

Item	Display element	Description
J	Top of graph	The vertical scale is normalized with appropriate power units.

LTE Channel Spectrum Settings

Main menu bar: **Setup > Settings**



The settings for the LTE Channel Spectrum display are shown in the following table.

Settings tab	Description
<i>Freq & RBW</i>	Allows you to specify the frequency and resolution bandwidth used for the measurement.
<i>Measurement Params</i>	Allows you to set averaging (Time Domain, Off, or Frequency Domain) and to set the number value associated with the Average setting.
<i>Channels</i>	Allows you to set the Channel BW for the Channel Power measurement.
<i>Scale</i>	Allows you to specify the horizontal and vertical scale settings.
<i>Prefs</i>	Allows you to select to show or hide certain display elements.

LTE Constellation display

The LTE Constellation display shows the constellation of Primary (PSS) and Secondary (SSS) Synchronization Signals. Scalar results include Cell ID, Group ID, Sector ID, and frequency error.

1. If you are analyzing a stored data file, recall the data file now. Otherwise, go to the next step.
2. Press the **Displays** button or select **Setup > Displays**.
3. In the **Select Displays** dialog, select **LTE Analysis** in the **Measurements** box.
4. In the Available displays box, double-click the **LTE Constellation** icon or select the icon and click **Add**. The LTE Constellation icon will be added to the **Selected displays** box and will no longer appear under Available displays.
5. Click **OK** to show the display.
6. Select **Replay/Run** to take measurements on the acquired data.
7. If you are analyzing a data file, press the **Replay** button to take measurements on the recalled acquisition data file.

Elements of the Display

The following image shows the LTE Constellation display.

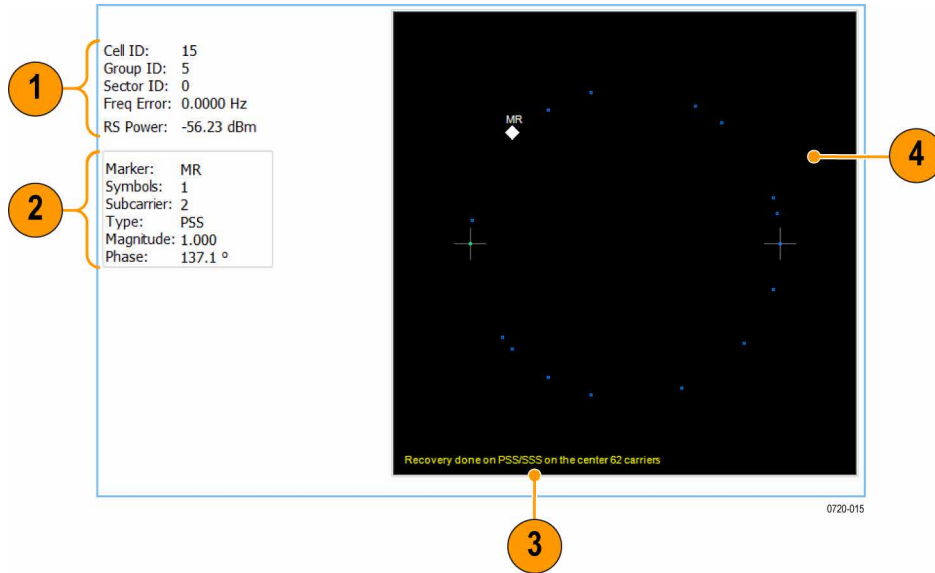

Item	Display element	Description
1	Scalar results	Gives results of Cell ID, Group and Sector ID information along with Frequency error.
2	Marker readout	Shows marker type, magnitude, phase and subcarrier number.
3	Status message	Shows relevant status messages. (You can read about status messages here .)
4	Plot	Displays PSS and SSS (Primary and Second Synchronization Signal) constellation.

LTE Constellation Settings

Main menu bar: Setup > Settings



The settings for the LTE Constellation display are shown in the following table.

Settings tab	Description
Modulation Params	Specifies the frame structure and channel bandwidth.
Analysis Params	Allows you to enable Equalization based on PSS (Primary Synchronization Signal).
Analysis Time	Specifies parameters that define the portion of the acquisition record that is used for analysis. Also allows you to specify the Units (Symbols or Seconds) and Time Zero Reference (Trigger or Acquisition Start) for LTE Analysis displays.
Trace	Allows you to set the display characteristics of the traces.

Table continued...

Settings tab	Description
Scale	Specifies the vertical and horizontal scale settings.

LTE Power vs Time display

The LTE Power vs Time display shows the filtered power of the data and marks where the T_{OFF} measurement is done. The T_{OFF} scalar results are also shown.

You can select **Presets > Standards > LTE** to view the display.



Note: Loading the LTE Power vs Time display from the **Presets > Standards > LTE** menu is recommended. This loads the control settings based on the selected options.

You can also load the LTE Power vs Time display as follows:

1. If you are analyzing a stored data file, recall the data file now. Otherwise, go to the next step.
2. Press the **Displays** button or select **Setup > Displays**.
3. In the **Select Displays** dialog, select **LTE Analysis** in the **Measurements** box.
4. In the Available displays box, double-click the **LTE Power vs Time** icon or select the icon and click **Add**. The LTE Power vs Time icon will be added to the **Selected displays** box and will no longer appear under Available displays.
5. Click **OK** to show the display.
6. Select **Replay/Run** to take measurements on the acquired data.
7. If you are analyzing a data file, press the **Replay** button to take measurements on the recalled acquisition data file.

Elements of the Display

The following image shows the LTE Power vs Time display.

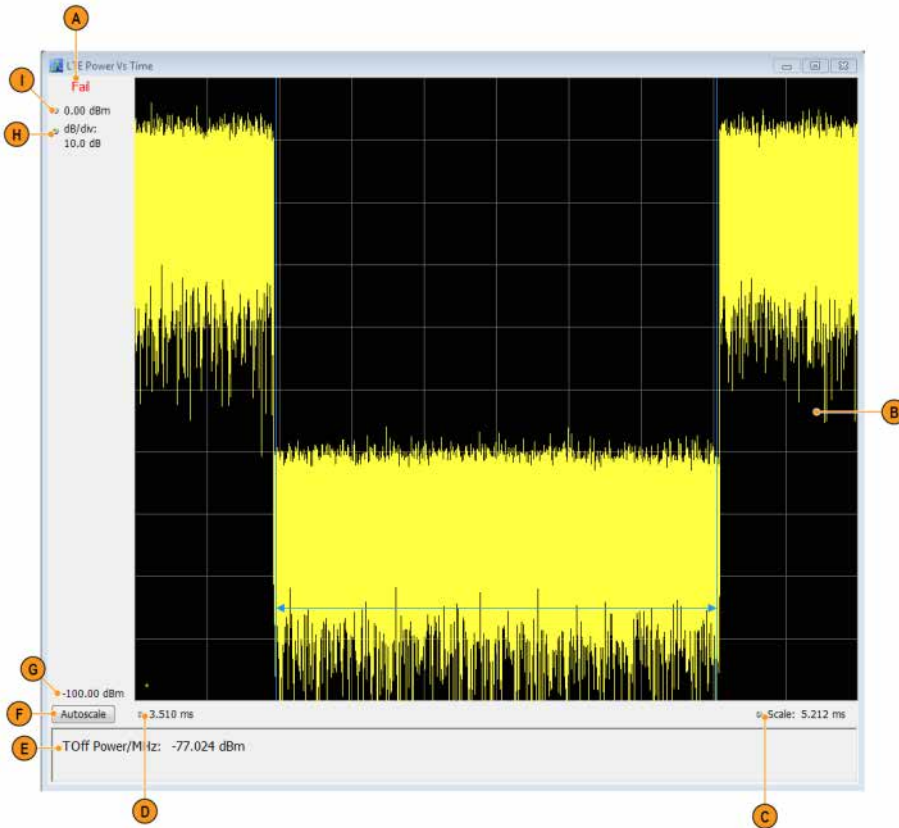

Item	Display element	Description
A	Pass / Fail	Shows Pass or Fail based on whether the T_{OFF} measurement (off slot power) is below the recommended limit set in the Limit tab of the Settings control panel or not. The Pass/Fail information is displayed only when the chosen frame structure is TDD and if a valid off slot is found.
B	Plot	Displays the filtered signal in case of TDD and the region in which the off slot power is measured is graphically shown. When the frame structure is chosen as FDD, the power in the input signal is displayed.
C	Scale	Adjust the span of the graph in symbols.
D	Analysis Start	Gives the start of analysis region.
E	Toff	The T_{OFF} (off slot power) is measured and displayed here when a valid off slot is found for a TDD signal.
F	Autoscale	Adjusts the vertical and horizontal settings so that the entire trace fits in the graph.
G	Bottom readout	Displays the value indicated by the bottom of graph.
H	dB / div	Shows the dB per each division in the Y axis of the plot.

Table continued...

Item	Display element	Description
(not shown)	Units	Sets the global Amplitude units for all the views in the analysis window. This will change the amplitude selection in the Units tab of the Amplitude control panel.
I	Top of graph	The vertical scale is normalized with appropriate power units.

LTE Power vs Time Settings

Main menu bar: Setup > Settings



The settings for the LTE Power vs Time display are shown in the following table.

Settings tab	Description
<i>Modulation Params</i>	Specifies the frame structure and channel bandwidth.
<i>Analysis Time</i>	Specifies parameters that define the portion of the acquisition record that is used for analysis. Also allows you to specify the Units (Symbols or Seconds) and Time Zero Reference (Trigger or Acquisition Start) for LTE Analysis displays.
<i>Prefs</i>	Allows you to select to show or hide the graticule and marker readouts.
<i>Scale</i>	Specifies the vertical and horizontal scale settings.
<i>Limit</i>	Specifies the mask limits.

LTE Analysis Measurement Settings

Main menu bar: Setup > Settings





The control panel tabs in this section are shared between the displays in LTE Analysis (Setup > Displays). Some tabs are shared by all the displays and some tabs are shared by only a subset of displays. The settings available on some tabs change depending on the selected display.

Table 30: Controls for LTE Analysis displays

Settings tab	Description
<i>Modulation Params</i>	Allows you to set the frame structure and channel bandwidth. <i>Available for these displays: LTE Power vs Time, LTE Constellation.</i>

Table continued...

Settings tab	Description
Analysis Params	Allows you to enable Equalization based on PSS (Primary Synchronization Signal).
Analysis Time	Specifies parameters that define the portion of the acquisition record that is used for analysis. Also allows you to specify the Units (Symbols or Seconds) for LTE Analysis displays. <i>Available for these displays: LTE Power vs Time, LTE Constellation.</i>
Trace	Specifies the trace type (Vectors, Points, and Lines), the number of points per symbol when chosen to view as Vectors or Lines, and to control the view as Freq Dev or IQ. <i>Available for the LTE Constellation display only.</i>
Prefs	Allows preferences with Radix display and marker readouts. <i>Available for these displays: LTE Power vs Time, LTE ACLR, LTE Channel Spectrum, SEM.</i>
Scale	Defines the vertical and horizontal axes. <i>Available for all LTE displays.</i>
Offsets & Limits Table	 Note: Available for the LTE ACLR display only.
Freq & RBW	Specifies the frequency and resolution bandwidth used for the measurement.  Note: Available for the LTE Channel Spectrum display only.
Parameters	Specifies several characteristics that control how the measurement is made.
Processing	Specifies settings for detection on the reference channel and the offsets. Specifies the function setting on how calculations are done across multiple sweeps.
Limit	Allows you to define limits for pass/fail comparison with calculated values. The default values are as recommended in the test specification.
Channels	Specifies the Channel BW for the Channel Power measurement. Allows you to set RBW, VBW, power reference, as well. <i>Available for these displays: LTE ACLR, LTE Channel Spectrum.</i>
Measurement Params	Allows you to set averaging (Time Domain, Off, or Frequency Domain) and to set the number value associated with the Average setting.

Channels tab - LTE

The Channels tab allows you to control how the measurement is performed.

The following image shows the Channels tab for the LTE ACLR display. When in Real Time, the RBW and VBW settings apply for all channels (including offset regions) and the other parameters such as Power Reference, Channel Width, and Integrated bandwidth apply

only to the reference channel. When Non-Real Time mode is selected, all information in this tab, including RBW and VBW, only applies to the reference channel.

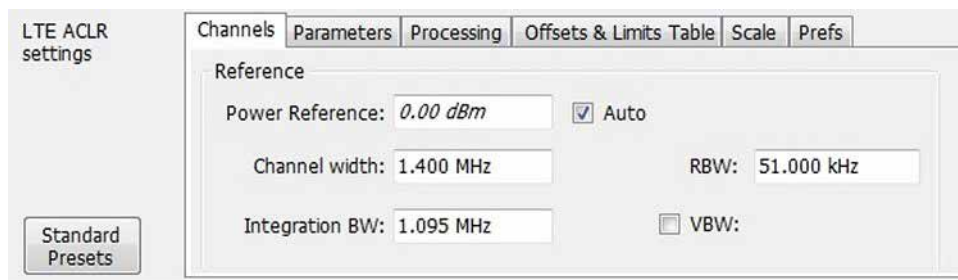

Settings	Description
Reference	
Power Reference	The value used to calculate relative measurements. When Auto is selected, the calculated reference channel power is displayed. When Auto is unchecked, you can enter a value for the reference power, and the measured reference power is not used or displayed.
Channel Width	Specifies the width of the reference channel.
Integration BW	Specifies the integration bandwidth used to compute the total power in the reference channel.
All Channels (displayed for Real-Time mode)	
Reference Channel (displayed for Non-Real Time mode)	
RBW	Sets the RBW
VBW	Enables/disables the Video Bandwidth filter. VBW is used in traditional swept analyzers to reduce the effect of noise on the displayed signal. The VBW algorithm in the analyzer emulates the VBW filters of traditional swept analyzers. When the check box next to VBW is not checked, the VBW filter is not applied. The maximum VBW value is 10 times the current RBW setting. The minimum VBW value is 1/10,000 of the RBW setting.

The following image shows the Channels tab for the LTE Channel Spectrum display. This tab allows you to set the channel bandwidth, which in turn sets the span for LTE Channel Spectrum.

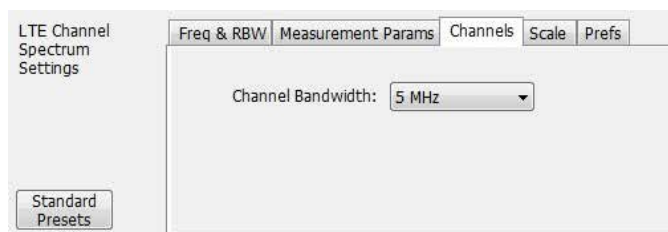

Settings	Description
Channel Bandwidth	Specifies the Channel Bandwidth, which in turn sets the span of the LTE Channel Spectrum.

Parameters tab - LTE

The Parameters tab enables you to specify several parameters that control the LTE ACLR measurements are made.

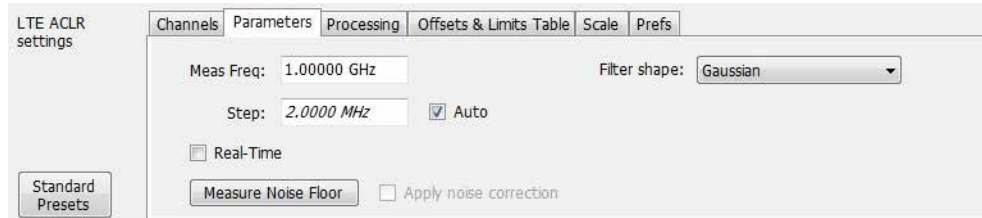

Setting	Description
Meas Freq	Specify the frequency of the signal to be measured.
Step	Sets the increment size when changing the Frequency using the knob or mouse wheel. Auto: When Auto is enabled, the step size is adjusted automatically based on the span setting.
Real-Time	<p>When Real-Time mode is enabled, the entire LTE ACLR span is measured using a real-time/ contiguous acquisition. Not all described parameters are available in Real-Time mode.</p> <p>When Real-Time is disabled (non-Real-Time mode), a separate acquisition for each region is taken and analyzed. Non-Real-Time mode is also useful when the bandwidth offered by the instrument does not support the span requirement for this measurement. The span requirement is guided by the choice of adjacent channel type and channel bandwidth selected in LTE Standards Presets.</p>
Measure Noise Floor	Takes preliminary acquisitions to measures the instrument noise floor. This initiates a noise correction. A noise correction signal is created by switching off the RF input and performing acquisitions of the instrument's internal noise. Fifty acquisitions are averaged to create the noise reference signal. The noise reference signal is measured for the Reference channel and each Offset is defined by the measurement settings.
Apply noise correction	<p>This item is enabled and the check box automatically checked after the noise reference signal is taken when the Measure Noise floor button is clicked. This initiates noise reference subtraction from the incoming signal power for each region to create the corrected result. All calculations are performed in Watts and then converted to the desired units.</p> <p>The amount of noise correction is limited to 20 dB to avoid the possibility of a negative power measurement. This is a rare condition that could occur if the subtraction of the reference power from the channel power results in a negative value (or "infinite" dBm). The noise reference for a region is subtracted from each trace point in the channel, rather than offsetting the entire region by a single amount. This produces a smooth trace with no discontinuities at the region edges.</p> <p> Note: If any relevant settings (such as reference level, frequency, span, RBW) are changed once the noise reference is measured, the following warning message will be displayed to notify you that Noise Correction was not applied: Noise correction not applied - select Measure Noise Floor for new noise correction.</p>

Table continued...

Setting	Description
Filter shape	<p>Specifies the shape of the filter determined by the window that is applied to the data record, in the spectrum analysis, to reduce spectral leakage. 3GPP specifies a Gaussian window shape be applied to the reference channel measurements.</p> <p>Gaussian: This filter shape provides optimal localization in the frequency domain.</p> <p>Rectangular: This filter shape provides the best frequency, worst magnitude resolution. This is essentially the same as no window.</p>

Processing tab - LTE

The Processing tab controls the detection settings for the Reference Channel and Offsets, as well as selecting the function for the LTE ACLR display.

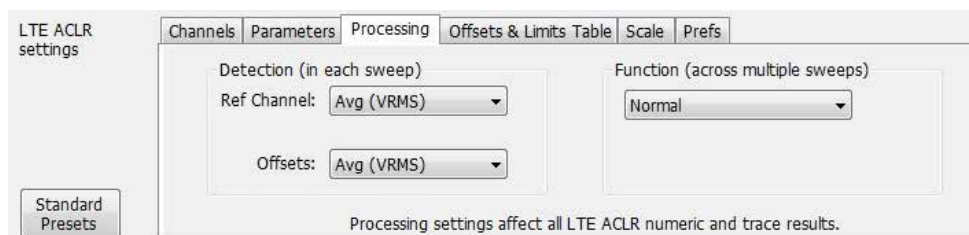

Setting	Description
Detection (in each sweep)	
Reference Channel	Specifies the Detection method used for the Reference Channel. Detection is used to produce the desired measurement result (peak or average) and to reduce the results of a measurement to the desired number of trace points.
Avg (VRMS)	For each sweep, each point of the trace is the result of determining the RMS voltage value for the last 'n counts' of the collected traces for the same point. When 'n count' has not been reached, partial averaging results are displayed.
+Peak	Selects the +Peak detection method. With this method, the highest value is selected from the results to be compressed into a trace point.
Offsets	Specifies the detection method used for the offsets.
Avg (VRMS)	Selects the Average Vrms detection method. With this method, each point on the trace in each offset is the result of determining the RMS Voltage value for all of the results values it includes.
+Peak	Selects the +Peak detection method. With this method, the highest value is selected from the results to be compressed into a trace point.
Function (across multiple sweeps)	
Table continued...	

Setting	Description
Normal	When a new trace has been computed, it replaces the previous trace.
Max Hold	With each sweep, each trace point in the new trace is compared to the point's value in the old trace and the greater value is retained for display and subsequent comparisons.
Avg (VRMS)	For each sweep, each point on the trace is the result of determining the RMS Voltage value for all of the collected traces' values for the same point.
Count	Enter the Avg (VRMS) value. Displayed only when Avg (VRMS) is selected.

Offsets and Limits Table tab - LTE

The Offsets and Limits Table tab is used to specify parameters that define Offsets and masks for the LTE ACLR display. The following images show the tab and expanded view of the tab, respectively.

The following image shows the Offsets and Limits Table tab when Real-Time is selected in the Parameters tab.

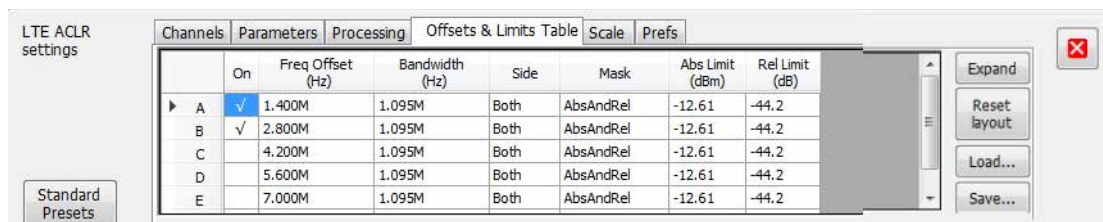

The following image shows the Offsets and Limits Table tab when Real-Time is not selected in the Parameters tab (referred to as non-Real-Time mode).

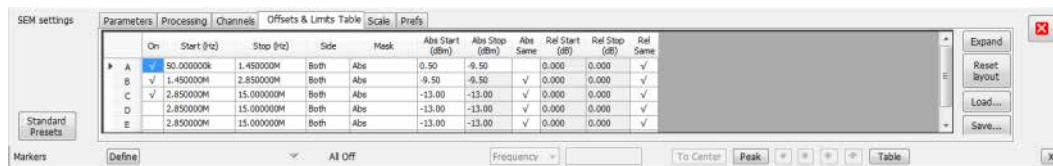

The following image shows the expanded view of the Offsets and Limits Table (click the **Expand** button to view).



Setting	Description
Buttons	
Expand (button)	Displays the Offsets and Limits Table in a new, resizable window.
Reset Layout	Allows you to reorder columns in the Offsets & Limits Table by dragging the columns to a new position. Clicking Reset Layout returns the column order to the factory default order.
Load	Click to load a saved Offsets & Limits table from a file.
Save As	Click to save the current Offsets & Limits table to a file.
Done	When the table is expanded, click Done when you have finished editing the table to save your changes and close the expanded table display.
Table columns	
On	Specifies whether or not measurements are taken in the specified offset.
Freq Offset (Hz)	Specifies the frequency offset for the offset region (adjacent channel region) from the Center frequency of the Reference Channel. This offset is always specified from the center frequency of the Reference Channel to the center frequency of the Offset region.
Start (Hz)	Start Frequency of the selected offset.
Stop (Hz)	Stop Frequency of the selected offset.
Bandwidth (Hz)	Specifies the bandwidth of the Offset region.
Side	Specifies whether the specified range appears on both side of the carrier frequency or just one side (left or right).
RBW (Hz)	Specifies the RBW for the selected range.
n(RBWS)	An integer value that specifies how many times to multiply the RBW to set the Filter bandwidth.
Filter BW (n x RBW)	Displays the Filter BW. Filter BW is the equivalent BW of each point in the offset. When $n > 1$, an integration technique is used to achieve the Filter BW using narrower RBWs.
VBW (Hz)	Adjusts the VBW (Video Bandwidth) value. VBW Maximum: RBW current value; VBW Minimum: 1/10,000 RBW setting.
VBW (On)	Specifies whether the VBW filter is applied.
Mask	Select the type of limits used for Pass/Fail testing. Signal excursions that exceed the mask settings are considered violations. The available choices are Abs, Rel and Abs & Rel.
Abs Limit (dBm)	The offset region integrated power is compared against the Abs Limit value mentioned here.
Table continued...	

Setting	Description
Buttons	
Rel Limit (dB)	The offset region integrated power relative to the reference channel integrated power is compared with this limit.

Scale tab - LTE

The Scale tab allows you to change the scale settings that control how the trace appears on the display but does not change control settings. In effect, these controls operate like pan and zoom controls. The Scale tab values are unique to each display. Also, note that each display uses horizontal and vertical units that are appropriate for that display. There are three versions of the Scale tab for LTE displays.

The following image shows the Scale tab for the LTE Power vs Time display.

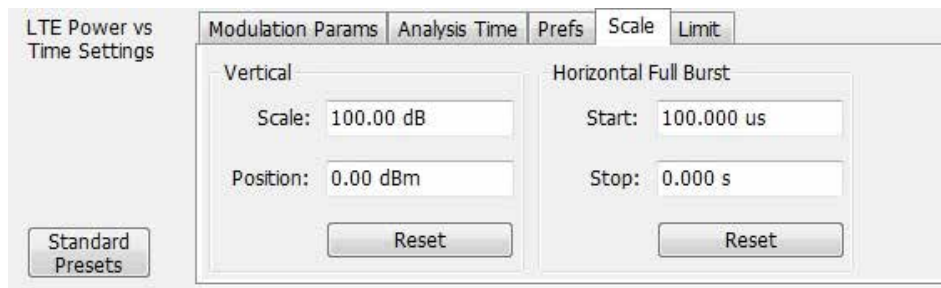

Settings	Description
Vertical	Controls the vertical position and scale of the trace display.
Scale	Changes the vertical scale units.
Position	Adjusts the reference level away from top of the graph.
Reset	Resets the scale of the vertical axis to default values.
Horizontal Full Burst	Controls the horizontal span.
Start	Specifies the horizontal axis start point.
Stop	Specifies the horizontal axis end point.
Reset	Resets the scale of the horizontal axis to default values.

The following image shows the Scale tab for the LTE Channel Spectrum and LTE ACLR displays.

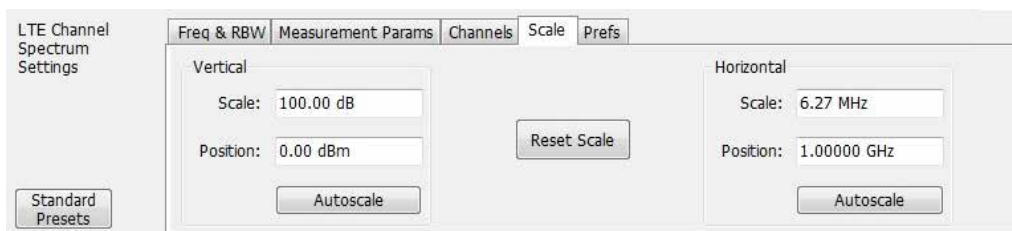

Settings	Description
Vertical	Controls the vertical position and scale of the trace display.
Scale	Changes the vertical scale units.
Position	Adjusts the reference level away from top of the graph.
Autoscale	Resets the scale of the vertical axis to contain the complete trace.
Horizontal	Controls the horizontal span of the trace display and position of the trace.
Scale	Specifies the frequency range displayed in the graph
Position	Specifies the frequency shown at the center of the graph.
Autoscale	Resets the scale of the horizontal axis to optimize the display of the trace.
Reset Scale	Resets all settings to their default values.

The following image shows the Scale tab for the LTE Constellation display.

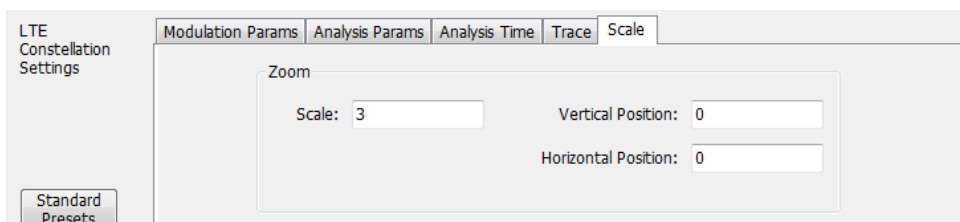

Settings	Description
Zoom	
Scale	Zooms in and out of the constellation. As the scale is increased, it will zoom out.
Vertical Position	Adjusts the vertical position.
Horizontal Position	Adjusts the horizontal position.

Prefs tab - LTE

The Prefs tab enables you to change parameters of the measurement display. The parameters available on the Prefs tab vary depending on the selected display, but include such items as enabling/disabling Marker Readout and switching the graticule display on/off. Some parameters appear with most displays, while others appear with only one display.

The following image shows the Prefs tab for the LTE ACLR display.

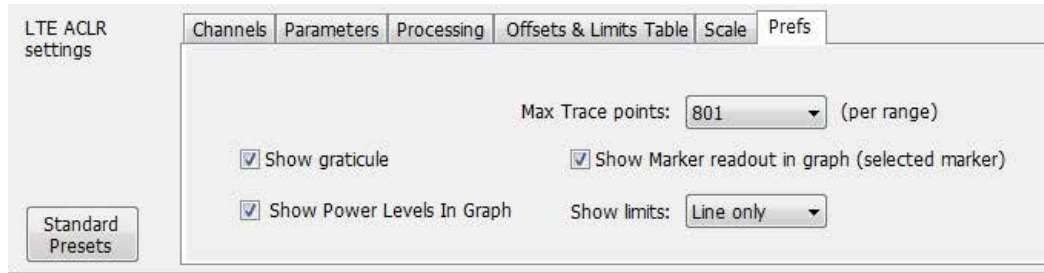

The following image shows the Prefs tab for the LTE Channel Spectrum display.

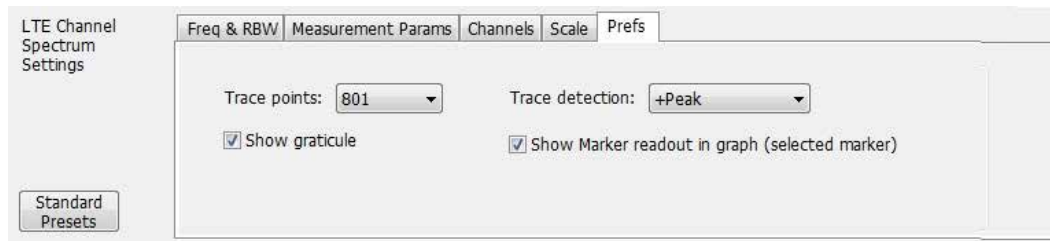

The following image shows the Prefs tab for the LTE Power vs Time display.



Setting	Description
Show graticule	Shows or hides the graticule.
Trace / Max Trace points	When the spectrum analysis produces more than the selected maximum number of points, the method specified in Detection control is used to decimate the result. This setting applies to both the reference channel and offsets.
Show Marker readout in graph (selected marker)	Shows or hides the readout for the selected marker in the graph area.
Show Power Levels In Graph	This display the power level (calculated integrated power in the offset region) in the graph.
Show limits	

Table continued...

Setting	Description
Shaded	Shows limits using a shaded area. Absolute limit and Relative limit shading colors can be set under Presets > Options.
Line only	Shows limits using only a line. Absolute limit and Relative limit line colors can be set under Presets > Options.
None	No lines or shading are used to indicate limits in the graph. Violations of the mask are still identified by red shading.
Average Over Offslot	Enables for averaging of offslot power in non-overlapping 70 μ s windows in the entire offslot region. If this option is disabled, the off slot power is measured only in the center 70 μ s window of the offslot region.

Freq and RBW tab - LTE

The Freq and RBW tab specifies frequency parameters for the Channel Power and ACPR measurements and the MCPR measurement. It is available for the LTE Channel Spectrum display.

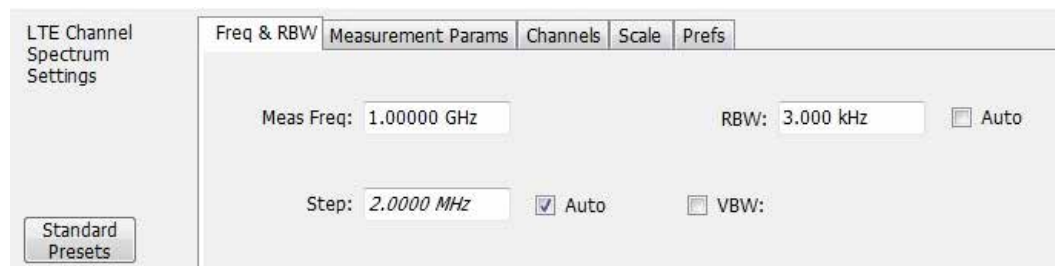

Settings	Description
Meas Freq	Specifies the center/measurement frequency
RBW	Select Auto or Manual. Adjusts the RBW for the entire measurement. This setting is Independent of the Spectrum view's RBW setting. Auto: When Auto is enabled, the step size is adjusted automatically based on the span setting.
Step	The Step control sets the increment/decrement size for the adjustment of the center frequency. If Auto is enabled, the analyzer will adjust the Step size as required. Auto: When Auto is enabled, the step size is adjusted automatically based on the span setting.
VBW	Adjusts the Video Bandwidth value. The maximum VBW value is 10 times the current RBW setting. The minimum VBW value is 1/10,000 of the RBW setting.

Measurement Params tab - LTE

The Measurement Params tab allows you to set parameters that control the ACPR and MCPR measurements. This is available for the LTE Channel Spectrum display.

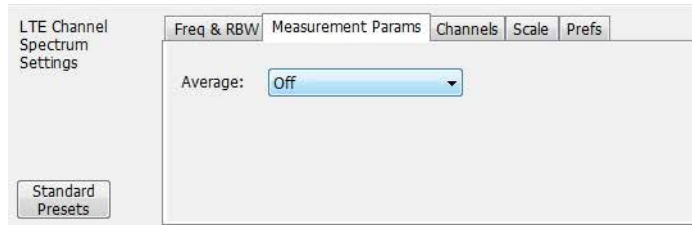

Settings	Description
Average	
Off	
Frequency-domain	This setting takes the average linear value of the traces (so that RMS values are preserved). The number of averages is user-defined. Frequency domain averaging is available in spans larger (or smaller) than the maximum real time bandwidth. This is the mode to use unless you need to extract maximum dynamic range from an ACPR measurement.
Time-domain	This setting takes the average linear value of the traces. It is useful if you need to extract maximum dynamic range from an ACPR measurement. The number of traces is user defined, however, the signals must be triggered and repeating (meaning the signal needs to be exactly the same for each acquisition). When this condition is met, each waveform contains the same signal, but the random noise changes from acquisition to acquisition and the average value of the random noise is lowered, while the signal value remains constant. Time domain averaging is not available in spans wider than the maximum real-time bandwidth.

Modulation Params tab - LTE

The Modulation Params tab specifies the type of modulation used by the input signal and other parameters that define the signal format. This tab is available for the LTE Constellation and Power vs Time displays.

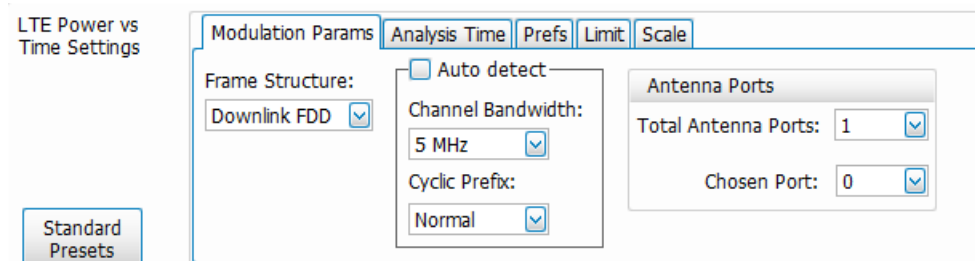

Settings	Description
Frame Structure	Select the frame structure to set how the demodulation is done.
Downlink FDD	Downlink Frequency Division Duplexing
Downlink TDD	Downlink Time Division Duplexing
Auto Detect	If checked, Channel Bandwidth and Cyclic Prefix are automatically detected. It will also detect the TDD Configuration when Downlink TDD is the selected frame structure.
Channel Bandwidth	Select from 6 bandwidths: 1.4, 3, 5, 10, 15, 20 MHz (If Auto Detect is checked, the channel bandwidth is automatically calculated.)
Cyclic Prefix	Select Normal or Extended.
TDD Configuration	
Uplink-Downlink	Select from 0 to 6. The configuration determines the appropriate downlink to uplink switch periodicity.
Special Subframe	Select from 0 to 9. This configuration determines the number of downlink pilots, guard period, and uplink pilots between uplink to downlink switch.
Antenna Ports	
Total Antenna Ports	Select from 1 to 4. This is the total number of antenna ports.
Chosen Port	Select the antenna port from which the signal is captured.

Analysis Params tab - LTE

The Analysis Params tab allows you to enable equalization on the demodulated LTE packet. The equalization is based on PSS (Primary Synchronization Signal). This tab is only available for the LTE Constellation display.

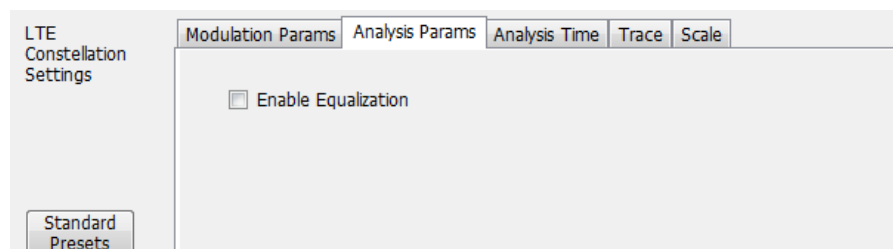

Settings	Description
Enable Equalization	Allows you to enable Equalization based on PSS (Primary Synchronization Signal).

Analysis Time tab - LTE

The Analysis Time tab contains parameters that define how the signal is analyzed in the LTE Analysis displays. This tab is available for the LTE Constellation and Power vs Time displays.

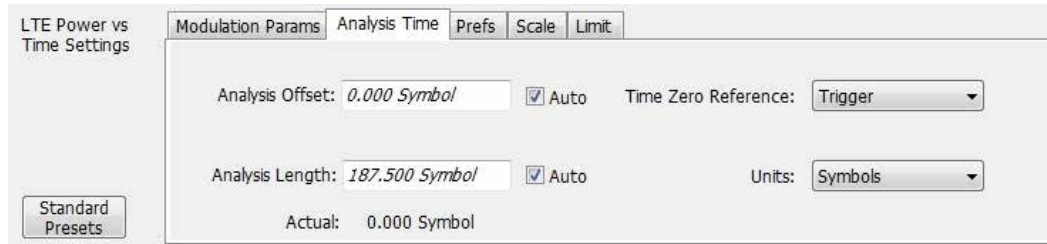

Settings	Description
Analysis Offset	Specifies the location of the first time sample to use in measurements.
Auto	When enabled, causes the instrument to set the Analysis Offset value based on the requirements of the selected display.
Analysis Length	Specifies the length of the analysis period to use in measurements. Length is specified in either symbols or seconds, depending on the Units setting.
Auto	When enabled, causes the instrument to set the Analysis Length value based on the requirements of the selected display.
Actual	This is a displayed value, not a setting. It is the Analysis Length (time or symbols) being used by the analyzer. This value may not match the Analysis Length requested (in manual mode).
Time Zero Reference	Specifies the zero point for the analysis time.
Units	Specifies the units of the Analysis Length to either Symbols or Seconds.

Analysis Offset

Use analysis offset to specify where measurements begin. Be aware that you cannot set the Analysis Offset outside the range of time covered by the current acquisition data. (All time values are relative to the Time Zero Reference.)

You can set the Analysis Length so that the requested analysis period falls partly or entirely outside the current range of acquisition data settings. When the next acquisition is taken, its Acquisition Length will be increased to cover the new Analysis Length, as long as the Sampling controls are set to Auto. If the Sampling parameters are set to manual, or if the instrument is analyzing saved data, the actual analysis length will be constrained by the available data length, but in most cases, measurements are able to be made anyway. The instrument will display a notification when measurement results are computed from less data than requested. Range: 0 to [(end of acquisition) - Analysis Length]. Resolution: 1 effective sample (or symbol).

Analysis Length

Use the analysis length to specify how long a period of time is analyzed. As you adjust this value, the actual amount of time for Analysis Length, in Symbol or Seconds units, is shown below the control in the "Available" readout. This setting is not available when Auto is checked. Range: minimum value depends on the standard. Resolution: 1 symbol.

Time Zero Reference

All time values are measured from this point (such as marker position or horizontal position (in Y vs Time displays). Choices are: Acquisition Start or Trigger.

Parameter	Description
Acquisition Start	Time zero starts from the point at which the acquisition begins.
Trigger	Time zero starts from the trigger point.

Trace tab - LTE

The Trace tab allows you to set the trace display characteristics of the LTE Constellation display.

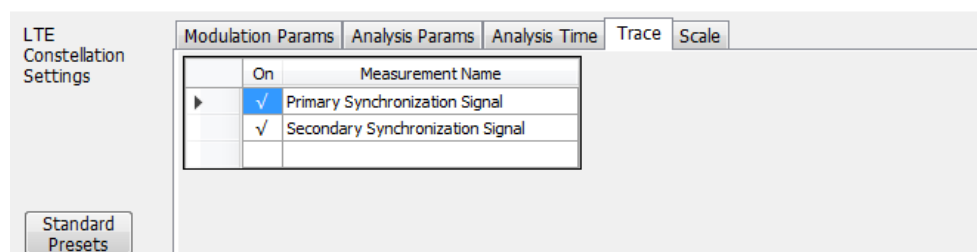

Setting	Description
>	The arrow indicates which measurement name is active so that you can check it (on) or uncheck it (off).
On	Check the box next the measurement name you want to turn on.
Measurement Name	Selections are PSS (Primary Synchronization Signal) or SSS (Secondary Synchronization Signal)

Limit tab - LTE

The Limit tab is only available for the LTE Power vs Time display. It enables you to specify the limit used for comparison against measured values of Toff measurement.

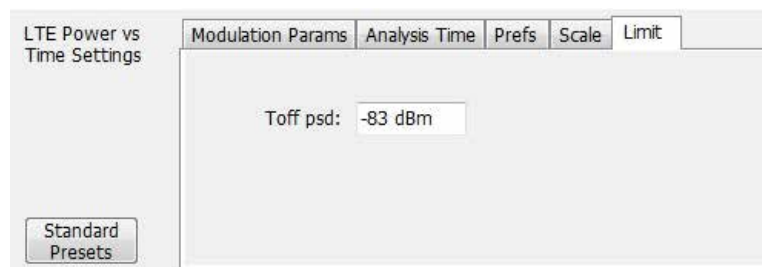

Setting	Description
Toff psd	Specifies the limit that is used for comparison against measured values of Toff measurement. Pass/ Fail is determined with this limit.

5G NR Analysis

Overview

The 5G NR RF Measurement Analysis option allows you to evaluate RF signals to ensure that they meet 3GPP measurement specifications. These are described in the Base Station (BS) radio transmission and reception and test specifications Base Station (BS) conformance testing documents version 15. This analysis option supports both Uplink and Downlink frame structures. This analysis option supports the following measurements:

Modulation Accuracy (ModAcc) - It measures the deviation of the received symbol relative to the ideal transmitted symbol. The IQ data is processed to identify the OFDM Symbol boundaries and FFT is performed using the various settings under the Modulation Accuracy tab. The subcarrier data is equalized and then Data and DMRS are extracted to perform various EVM measurements as per the 3GPP specifications and then used for display in Constellation Display. The Estimation tab provides advanced settings related to IQ Impairments and Frequency Offset estimation and corrections.

Channel Power (CHP) - This measurement is used to verify the maximum carrier output power across the frequency range. It includes the measurement of individual carrier power under carrier aggregation mode. The Integrated Bandwidth type can be selected between Channel and Signal Bandwidth to include or remove the Guard Bands between the carriers respectively.

Adjacent Channel Power (ACP) - It measures the power leakage from the carrier channels into the neighboring frequency channels, commonly referred to as offset channels. The RBW, Sweep time, and Spectral Window can be selected from the measurement options tab. By default, two offset channels are enabled for the measurement.

Spectral Emission Mask (SEM) - It measures the spurious emissions of a transmitter in the immediate frequency bands and compares against the limit chosen in the settings. The RBW settings and the width of the bands can be selected from the measurement options tab. The predefined band settings as per 3GPP are also provided in the options.

Occupied Bandwidth (OBW) - The Occupied Bandwidth measures the bandwidth within which 99% of the power transmitted within the measurement bandwidth falls.

Error Vector Magnitude (EVM) - An EVM will give the variation of an EVM over the OFDM symbols. Trace can be selected between RMS and Peak.

Power vs Time (PVT) - The PVT measurement measures the time domain power dynamics of the NR signal. This measurement is also known as Transmit ON-OFF Time Mask measurement.

You can also select these measurements from seven 5G NR preset test setups. The test setups load pre-configured displays and control setting as suggested by the standard to accelerate the test setup of the analyzer. The following test setups are available for this analysis option.

1. Modulation Accuracy
2. ACP
3. CHP
4. SEM
5. OBW
6. EVM
7. PVT

For more detailed information about these test setups, click [here](#).

With the 5G NR RF measurement analysis test suite, test engineers can simplify the execution of several transmitter tests while still enabled to modify signal parameters for in-depth signal analysis.

The analysis results give multiple views of 5G NR signal characteristics to allow the diagnosis of signal imperfections and impairments quickly and easily. Display controls allow you to selectively display the analysis results to help locate trouble spots in the signal.

5G NR Analysis topics in this Help

The following information about the 5G NR Analysis option is available:

[Supported 5G NR measurements](#)

[5G NR measurements](#)

[5G NR standard preset test setups](#)

[5G NR displays](#)

[5G NR measurement analysis settings](#)

Supported 5G NR Measurements

The following table gives a brief description of the available 5G NR measurements. More detailed information can be found here.

Table 31: 5G NR Measurements

5G NR Measurement	5G NR Standard(s)	Description
Modulation accuracy	Sec 6.5.2 for BS and Sec 6.4.2 for UE.	It measures the deviation of the received symbol relative to the ideal transmitted symbol.
ACP	Sec 6.6.3 for BS and Sec 6.5.2.4 for UE	It measures the power leakage from the carrier channels into the neighboring frequency channels.
CHP	Sec 6.2 for BS and Sec 6.3 for UE	It measures the RMS power within the carrier channel bandwidth.
SEM	Sec 6.6.5 for BS and Sec 6.5 for UE	It measures spurious out-of-band emissions in the immediate neighboring bands of the carrier.
OBW	Sec 6.6.2(38.141) for BS and Sec 6.5.1(38.521) for UE	The Occupied Bandwidth measures the bandwidth within which 99% of the power transmitted within the measurement bandwidth falls.
EVM	Sec 6.5.2 for BS and Sec 6.4.2 for UE	An EVM will give the variation of an EVM over the OFDM symbols. Trace can be selected between RMS and Peak.
PVT	Sec 6.3.3 for UE	It measures the time domain power dynamics of the NR signal. This measurement is also known as Transmit ON-OFF Time Mask measurement.

5G NR Standards Preset Test Setups

Presets > Standards

The 5G NR Standards preset allows you to access displays preconfigured for the selected test setup. The test setups load the displays and control setting options suggested by the 5G NR standard to perform the measurements.

There are seven test setups for 5G NR:

Table 32: Test setup presets

Preset name	Preset image
Modulation Accuracy	
ACP	

Table continued...

Preset name	Preset image
CHP	
SEM	

Table continued...

Preset name	Preset image
OBW	
EVM	

Table continued...

Preset name	Preset image
PVT	 <p>The screenshot shows a 'Standards Presets' dialog box. At the top, the 'Preset:' dropdown is set to '5GNR'. Below this, 'Preset displays:' includes four icons: 'Spectrum', 'Time Overview', 'NR Summary', and 'NR Power vs Time'. The 'Test Setup:' section contains three fields: 'Number of Component Carrier' (1), 'Channel Bandwidth (MHz):' (100), and 'Sub carrier spacing:' (30 kHz). There are two checkboxes: 'Retain current Center Frequency setting' (unchecked) and 'Retain current Ref Level setting' (checked). At the bottom, there is a note: 'To go directly to a preset in the future, use Presets->Preset Options->Presets->Preset action' and 'OK' and 'Cancel' buttons.</p>

The following table lists the default configurations loaded with each test setup.

Table 33: 5GNR Preset test setups

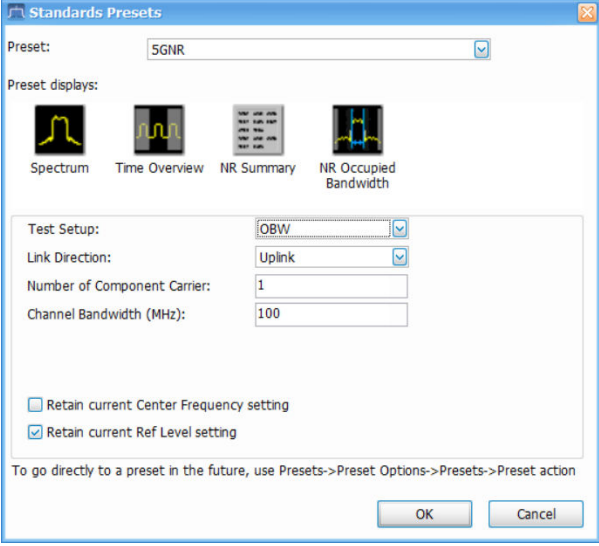
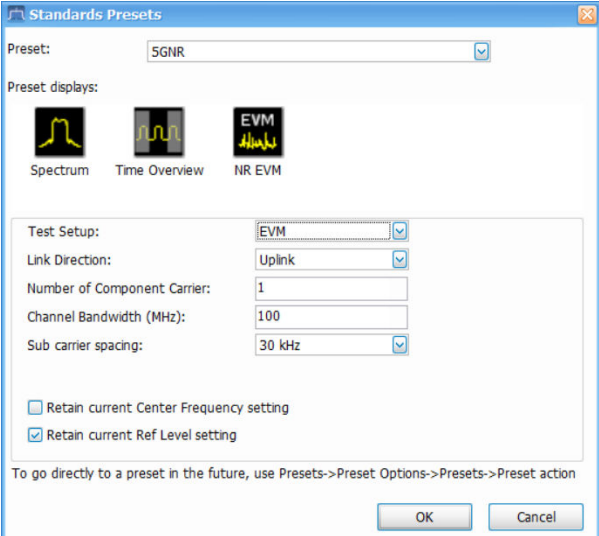
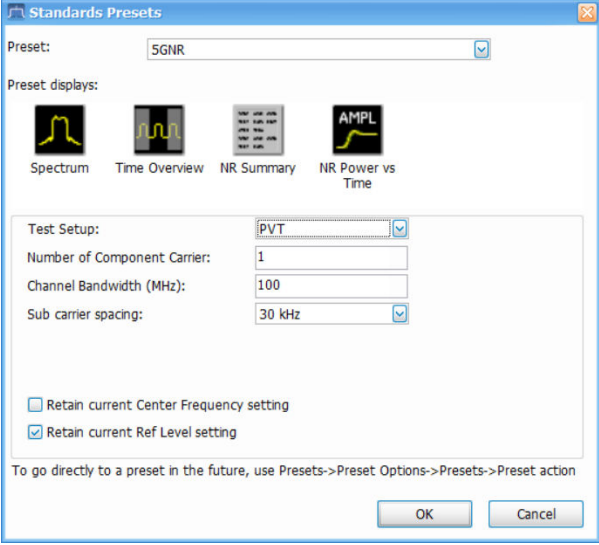
Test setup		Displays loaded with preset
Modulation accuracy	Link Direction: <ul style="list-style-type: none"> • Uplink • Downlink (Default is Uplink)	<ul style="list-style-type: none"> • Spectrum • Time Overview • NR Constellation • NR Summary
	Number of Component Carrier: 1, 2, 3, 4, 5, 6, 7, and 8 (Default is 1)	
	Channel Bandwidth: 5, 10, 15, 20, 25, 30, 40, 50, 60, 70, 80, 90, 100, 200, and 400 MHz (Default is 100 MHz)	
	Sub Carrier Spacing: 15, 30, 60, and 120 kHz (Default is 30 kHz)	
ACP	Link Direction: <ul style="list-style-type: none"> • Uplink • Downlink (Default is Uplink)	<ul style="list-style-type: none"> • Spectrum • Time Overview • NR Summary • NR Adjacent Channel Power
	Number of Component Carrier: 1, 2, 3, 4, 5, 6, 7, and 8 (Default is 1)	
	Channel Bandwidth: 5, 10, 15, 20, 25, 30, 40, 50, 60, 70, 80, 90, 100, 200, and 400 MHz (Default is 100 MHz)	

Table continued...

Test setup		Displays loaded with preset
CHP	Link Direction: <ul style="list-style-type: none"> • Uplink • Downlink (Default is Uplink)	<ul style="list-style-type: none"> • Spectrum • Time Overview • NR Summary • NR Channel Power
	Number of Component Carrier: 1, 2, 3, 4, 5, 6, 7, and 8 (Default is 1)	
	Channel Bandwidth: 5, 10, 15, 20, 25, 30, 40, 50, 60, 70, 80, 90, 100, 200, and 400 MHz (Default is 100 MHz)	
SEM	Link Direction: <ul style="list-style-type: none"> • Uplink • Downlink (Default is Uplink)	<ul style="list-style-type: none"> • Spectrum • Time Overview • NR Summary • NR Spectral Emission Mask
	Number of Component Carrier: 1, 2, 3, 4, 5, 6, 7, and 8 (Default is 1)	
	Channel Bandwidth: 5, 10, 15, 20, 25, 30, 40, 50, 60, 70, 80, 90, 100, 200, and 400 MHz (Default is 100 MHz)	
OBW	Link Direction: <ul style="list-style-type: none"> • Uplink • Downlink (Default is Uplink)	<ul style="list-style-type: none"> • Spectrum • Time Overview • NR Summary • NR Occupied Bandwidth
	Number of Component Carrier: 1, 2, 3, 4, 5, 6, 7, and 8 (Default is 1)	
	Channel Bandwidth: 5, 10, 15, 20, 25, 30, 40, 50, 60, 70, 80, 90, 100, 200, and 400 MHz (Default is 100 MHz)	

Table continued...

Test setup		Displays loaded with preset
EVM	Link Direction: <ul style="list-style-type: none"> • Uplink • Downlink (Default is Uplink)	<ul style="list-style-type: none"> • Spectrum • Time Overview • NR EVM
	Number of Component Carrier: 1, 2, 3, 4, 5, 6, 7, and 8 (Default is 1)	
	Channel Bandwidth: 5, 10, 15, 20, 25, 30, 40, 50, 60, 70, 80, 90, 100, 200, and 400 MHz (Default is 100 MHz)	
	Sub Carrier Spacing: 15, 30, 60, and 120 kHz (Default is 30 kHz)	
PVT	Number of Component Carrier: 1, 2, 3, 4, 5, 6, 7, and 8 (Default is 1)	<ul style="list-style-type: none"> • Spectrum • Time Overview • NR Summary • NR Power Vs Time
	Channel Bandwidth: 5, 10, 15, 20, 25, 30, 40, 50, 60, 70, 80, 90, 100, 200, and 400 MHz (Default is 100 MHz)	
	Sub Carrier Spacing: 15, 30, 60, and 120 kHz (Default is 30 kHz)	

Retain current Center Frequency and Ref Level settings

The **Retain current Center Frequency setting** appears when the 5G NR Standards Preset is selected. Select the check box to retain the previously used center frequency. By default, the Center Frequency settings box is unchecked.

The **Retain current Ref Level setting** appears when the 5G NR Standards Preset is selected. Select the check box to retain the previously used reference level. By default, the Ref Level settings box is checked.

To activate these settings, select the check box next to the desired setting. The following image shows the **Retain current Ref Level setting** box is selected.

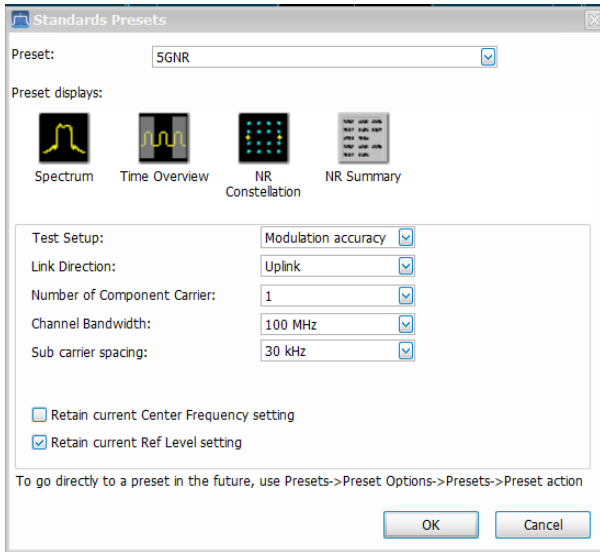

5G NR Displays

The displays in 5G NR Analysis (**Setup > Displays > Measurements: 5G NR Analysis**) are:

1. [NR Adjacent Channel Power](#)
2. [NR Channel Power](#)
3. [NR Constellation](#)
4. [NR Spectral Emission Mask](#)
5. [NR Occupied Bandwidth](#)
6. [NR EVM](#)
7. [NR Power vs Time](#)
8. [NR Summary](#)

5G NR Status Messages

The following status messages may appear. Each message indicates the related condition (Description) shown in the following table.

Status message	Description
Analysis failure	Signal analysis has failed.
Analyzing	Signal analysis is in progress.
Stopped	Acquisition/Analysis stopped.
Acquiring	Signal acquisition is in progress.
Transfer	IQ data is being transferred.
Setup error	Configuration settings error.
Acq BW too small for the current setup	Bandwidth/Span lower than expected.
Analysis length too small for the current setup	Insufficient data.
Trigger position is before the analysis window	The analysis window in the "Time Overview" display does not include the trigger position.

Table continued...

Status message	Description
Insufficient Span or Incorrect Data for Analysis	ACP display expects additional span or the data is incorrect.
Cell ID Detected	Cell ID detected for the Downlink 5GNR waveform in the "Constellation" display.
Not enough samples for the current setup	The current configuration expects more samples.
Analysis failure : Invalid Result	Signal analysis has failed and results are invalid.
Analysis failure : Insufficient BW. Required BW : <x>	Signal analysis has failed due to insufficient bandwidth. The required bandwidth is denoted by the value in <x>.
Analysis failure : Trigger position is before analysis window	Signal analysis has failed due to the trigger position not available within the analysis window.
Analysis failure : Downlink measurement currently unsupported	Signal analysis has failed as the PVT measurement currently doesn't support downlink signals.
Analysis failure : Not enough data before trigger, requires: <x> data before trigger	Signal analysis has failed as the PVT measurement expects <x> time of data before the trigger.
Analysis failure : Invalid Configuration	Signal analysis has failed as there was an incorrect configuration.
Analysis failure : Insufficient Span or Incorrect Data for Analysis	Signal analysis has failed due to incorrect data or insufficient span.
Setup error No channels defined	Configuration settings error indicating that there are no adjacent channels or offsets defined.
Setup error Channels cannot overlap	Configuration settings error indicating that there are adjacent channels or offset that overlap each other.
Setup error Channel BW too wide for hardware	Configuration settings error indicating that the bandwidth requirements are not supported by hardware.
Setup error : Channel BW too wide for hardware, required BW = <x> including RBW	Configuration settings error indicating that the bandwidth requirements are not supported by hardware. The value in <x> determines the required bandwidth, including the resolution bandwidth.
RBW limited by Acq BW to <x>	The actual RBW achieved is less than requested, because the user requested RBW is too large compared to the current acquisition span for the measurement. The final RBW value is denoted by <x>.

NR Adjacent Channel Power Display

The NR Adjacent Channel Power (ACP) display shows the power leakage from the carrier channels into the neighboring frequency channels, known as offset channels.

To view the NR ACP display:

1. Select **File > Recall** to analyze a stored data file or go to the next step.
2. Select **Setup > Displays**.
3. In the Select Displays window, select **5GNR Analysis** in the Measurements box.
4. In the Available displays box, double-click . This moves the NR Adjacent Channel Power icon to the selected displays box.
5. Click **OK** to view the display.
6. Select **Setup > Settings** to display the control panel.
7. Select **Replay/Run** to take measurements on the acquired data.

8. If you are analyzing a data file, click **Replay** to take measurements on the recalled acquisition data file.

Elements of the display

The following image shows the NR ACP display.

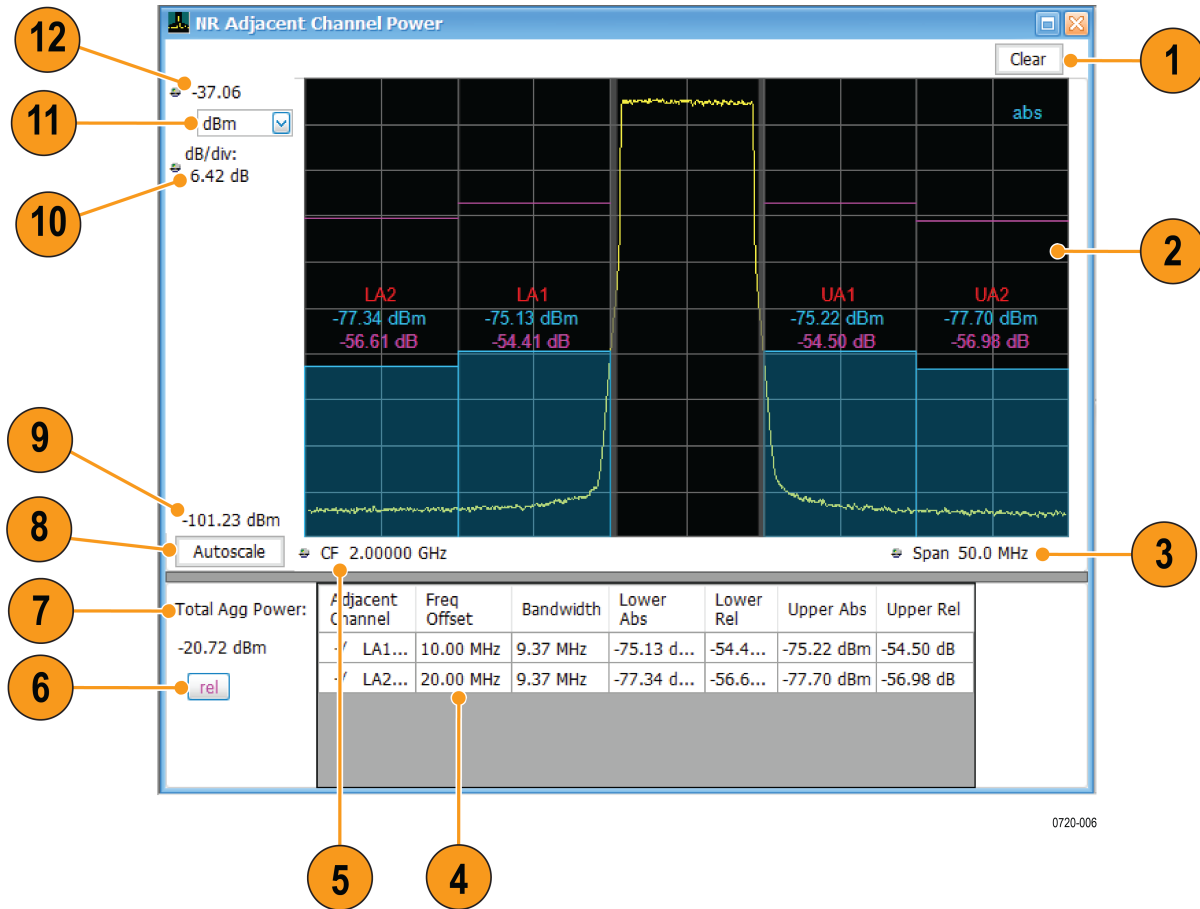

Item	Display element	Description
1	Clear	Resets the measurement and clears all the values.
2	Plot	Displays the reference channel(s) and adjacent channel(s) and the regions in between them. The Absolute and Relative limit lines are also shown. The integrated power is shown as a band. Scalar results are also shown.
3	Span	Adjust the span of the graph in symbols.
4	Results table	Tabulates the results in each adjacent band. The table shows the offset, bandwidth, Integrated Absolute and Relative power in the upper and lower adjacent channel regions.
5	CF	Center Frequency at which the measurement is performed.
6	rel	Opens relative adjacent channel power color palette.
7	Total Agg Power	Displays the total aggregated power of all subblocks.
8	Autoscale	Adjusts the adjacent channel power magnitude and frequency scale settings so that the entire trace fits in the graph.

Table continued...

Item	Display element	Description
9	Lower limit in the display graph	Displays the lower limit of the channel power in the graph.
10	dB/div	Shows the dB per each division in the vertical axis of the plot.
11	Units of adjacent channel power	Sets the global Amplitude units for all the views in the analysis window. This will change the amplitude selection in the Units tab of the Amplitude control panel.
12	Upper limit of the display graph	Displays the upper limit of the channel power in the graph.

NR Adjacent Channel Power Display Settings

Main menu bar: **Setup > Settings**

Favorites toolbar: 

The NR Adjacent Channel Power display settings control panel allows you to configure the settings of the NR adjacent channel power display.

Settings tab	Description
ACP	Allows you to configure the ACP-specific properties.
Signal Configuration	Allows you to configure the signal properties.
Subblock Configuration	Allows you to configure the properties needed to analyze a subblock in 5GNR signal.
Carrier Configuration	Allows you to configure the carrier properties.
Averaging	Allows you to configure the averaging parameters.
Prefs	Allows you to configure settings required to show/hide graticule, marker readouts, and readouts.

NR Channel Power Display

The NR Channel Power display shows the spectrum of the input signal across one channel. The channel power measures the RMS power in the carrier channel in dBm. Other units can be selected from the Units tab of the Analysis control panel.

To view the NR Channel Power display:

1. Select **File > Recall** to analyze a stored data file or go to the next step.
2. Select **Setup > Displays**.
3. In the Select Displays window, select **5GNR Analysis** in the Measurements box.
4. In the Available displays box, double-click . This moves the NR Channel Power icon to the selected displays box.
5. Click **OK** to view the display.
6. Select **Setup > Settings** to display the control panel.
7. Select **Replay/Run** to take measurements on the acquired data.
8. If you are analyzing a data file, click **Replay** to take measurements on the recalled acquisition data file.

Elements of the display

The following image shows the NR Channel power display.

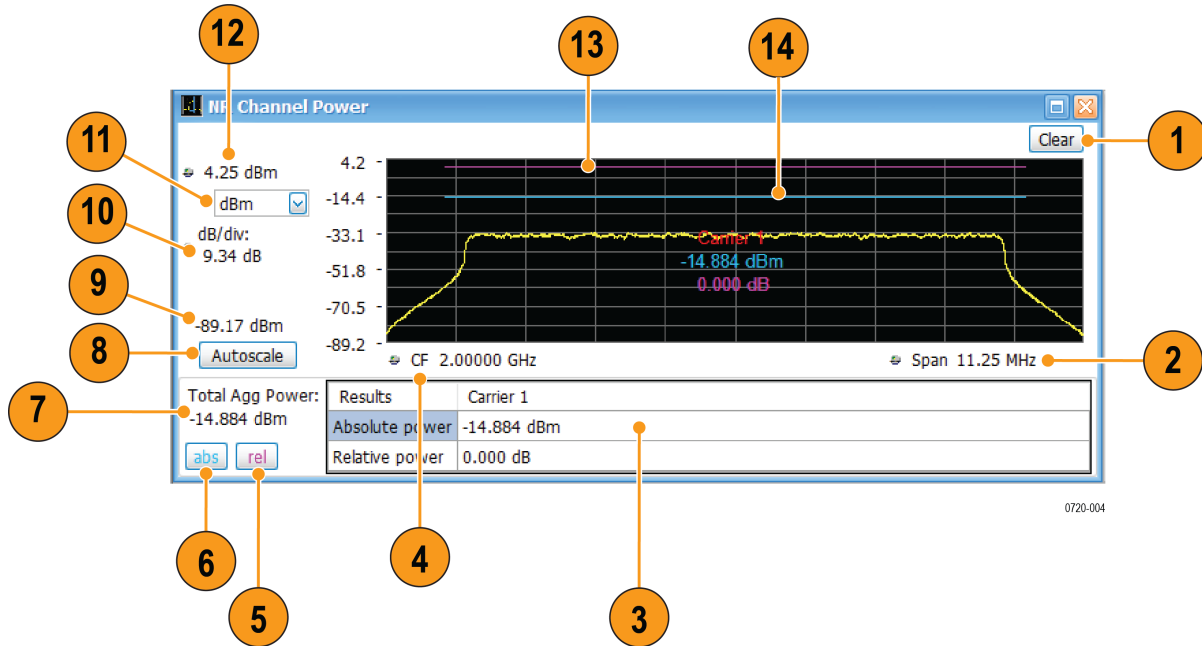

Item	Display element	Description
1	Clear	Resets the measurement and clears all the values.
2	Span	Adjust the frequency span of the graph in symbols.
3	Results table	Displays each component carrier's absolute and relative channel power.
4	CF	Center Frequency at which the measurement is performed.
5	rel	Opens relative channel power color palette
6	abs	Opens absolute channel power color palette
7	Total Agg Power	Displays total aggregated power of all the subblocks.
8	Autoscale	Adjusts the channel power magnitude and frequency scale settings so that the entire trace fits in the graph.
9	Lower Limit in the display graph	Displays the lower limit of the channel power in the graph
10	dB / div	Shows the channel power per division in the vertical axis of the plot.
11	Units for Channel Power	Sets the global Amplitude units for all the views in the analysis window. This will change the amplitude selection in the Units tab of the Amplitude control panel.
12	Upper Limit in the display graph	Displays the upper limit of the channel power in the graph
13	Rel power level	Displays the relative power level as a horizontal line in the user-selected color from the palette
14	Abs power level	Displays the absolute power level as a horizontal line in the user-selected color from the palette

NR Channel Power Display Settings

Main menu bar: **Setup > Settings**

Favorites toolbar:

The NR Channel Power display control panel allows you to configure the settings of the NR Channel power display.

Settings tab	Description
CHP	Allows you to configure the CHP specific properties.
Signal Configuration	Allows you to configure the signal properties.
Subblock Configuration	Allows you to configure the properties needed to analyze a subblock in 5GNR signal.
Carrier Configuration	Allows you to configure the carrier properties.
Averaging	Allows you to configure the averaging parameters.
Prefs	Allows you to configure settings required to show/hide graticule, marker readouts, and readouts.

NR Constellation Display

Displays the demodulated and equalized OFDM subcarrier symbols. The same display area is shared for plotting Data (PUSCH/PDSCH) and DMRS. The plot at a single instance shows a constellation graph for a single component carrier. You can select between different component carriers.

To view the NR Constellation display:

1. Select **File > Recall** to analyze a stored data file or go to the next step.
2. Select **Setup > Displays**.
3. In the Select Displays window, select **5GNR Analysis** in the Measurements box.



NR

4. In the Available displays box, double-click **Constellation**. This moves the NR Constellation icon to the selected displays box.
5. Click **OK** to view the display.
6. Select **Setup > Settings** to display the control panel.
7. Select **Replay/Run** to take measurements on the acquired data.
8. If you are analyzing a data file, click **Replay** to take measurements on the recalled acquisition data file.

Elements of the Display

The following image shows the NR Constellation display.

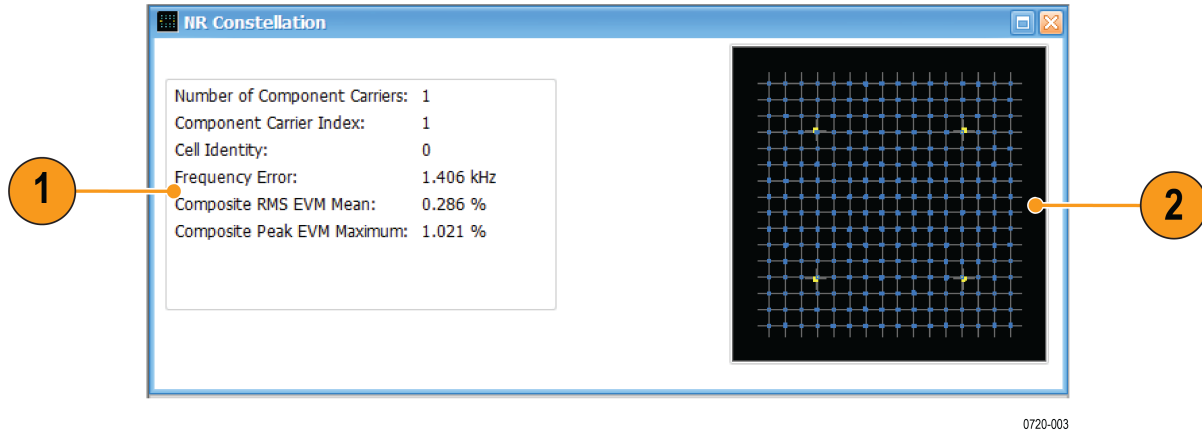

0720-003

Item	Display element	Description
1	Scalar results	Displays the selected component carriers Cell ID, Frequency Error, and EVM.
2	Plot	Displays data (PUSCH / PDSCH) and DMRS.

NR Constellation Display Settings

Main menu bar: **Setup > Settings**

Favorites toolbar: 

The NR Constellation display control panel allows you to configure the settings of the NR Constellation display.

Settings tab	Description
Modulation Accuracy	Allows you to configure the modulation accuracy-specific properties.
Estimation	Allows you to configure the modulation accuracy Estimation properties.
Signal Configuration	Allows you to configure the signal properties.
Subblock Configuration	Allows you to configure the properties needed to analyze a subblock in 5GNR signal.
Carrier Configuration	Allows you to configure the carrier properties.
Averaging	Allows you to configure the averaging parameters.
Traces	Allows you to set the display characteristics of the traces.
Prefs	Allows you to show/hide graticule and marker readouts.

NR Spectral Emission Mask display

The NR Spectral Emission Mask (SEM) display shows the margin of the emission level from the limit and reports the measurement status. Spectral emission mask measurements measure out-of-band emissions in the neighboring bands of the carrier.

To view the NR SEM display:

1. Select **File > Recall** to analyze a stored data file or go to the next step.
2. Select **Setup > Displays**.
3. In the Select Displays window, select **5GNR Analysis** in the Measurements box.

4. In the Available displays box, double-click  . This moves the NR Spectral Emission Mask icon to the selected displays box.
5. Click **OK** to view the display.
6. Select **Setup > Settings** to display the control panel.
7. Select **Replay/Run** to take measurements on the acquired data.
8. If you are analyzing a data file, click **Replay** to take measurements on the recalled acquisition data file.

Elements of the display

The following image shows the NR SEM display.

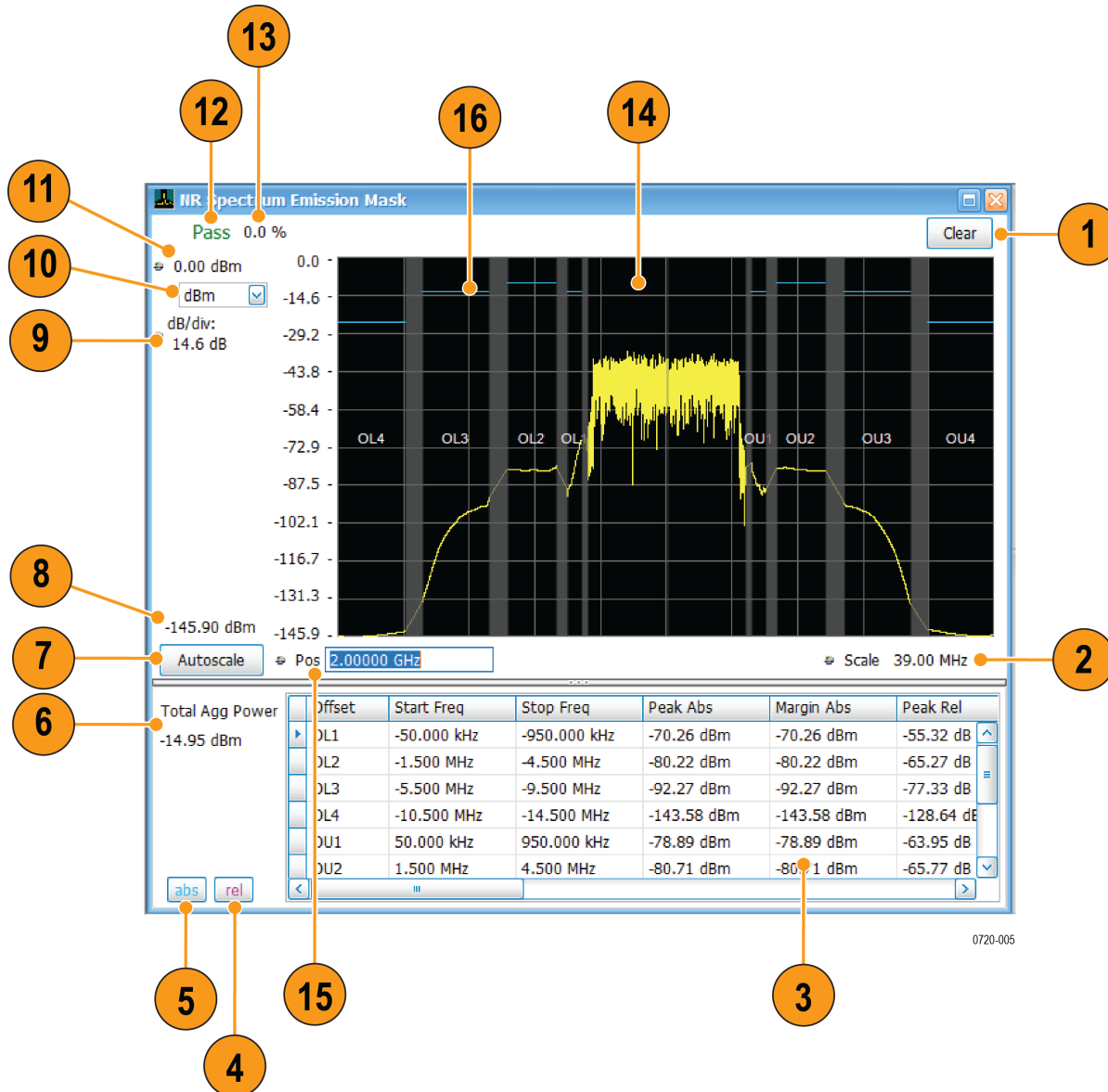

Item	Display element	Description
1	Clear	Resets the measurement and clears all the values.

Table continued...

Item	Display element	Description
2	Scale	Adjusts the frequency span of the graph.
3	Results table	Displays the spectral emission mask results.
4	rel	Displays the relative power SEM color palette
5	abs	Displays the absolute power SEM color palette
6	Total Agg Power	Displays the total aggregated power of all subblocks
7	Autoscale	Adjusts the channel power magnitude and frequency scale settings so that the entire trace fits in the graph.
8	Lower limit in the display graph	Displays the lower limit in the graph.
9	dB/div	Displays the channel power per division in the vertical axis of the plot.
10	Units	Sets the global amplitude units for all the views in the analysis window. This will change the amplitude selection in the units tab of the amplitude control panel.
11	Upper limit in the display graph	Displays the upper limit in the graph.
12	Pass/Fail	Indicates Pass or Fail based on absolute and relative limits set by the user. The failure condition is set by mask in the settings control panel.
13	Pass/Fail %	Gives Pass/Fail offset regions to total offset regions in terms of percentage
14	Plot	Shows the spectral emission offsets, masks, and the power in the offset region. The absolute limit lines are also shown.
15	Pos	Position in the frequency domain at which the measurement is performed.
16	Limit line (Blue in the plot)	Displays the mask limit lines for the SEM measurement.

NR Spectral Emission Mask Display Settings

Main menu bar: **Setup > Settings**

Favorites toolbar: 

The NR Spectral Emission Mask display control panel allows you to configure the settings of the NR Spectral Emission Mask display.

Settings tab	Description
SEM	Allows you to configure SEM specific properties.
Signal Configuration	Allows you to configure the signal properties.
Subblock Configuration	Allows you to configure the properties needed to analyze a subblock in 5GNR signal.
Carrier Configuration	Allows you to configure the carrier properties.
Averaging	Allows you to configure the averaging parameters.
Prefs	Allows you to configure settings required to show/hide graticule, marker readouts, and readouts.

NR Occupied Bandwidth Display

The NR OBW display shows the bandwidth in which 99% of the power transmitted within the measurement bandwidth falls.

To view the NR OBW display:

1. Select **File > Recall** to analyze a stored data file or go to the next step.
2. Select **Setup > Displays**.
3. In the Select Displays window, select **5GNR Analysis** in the Measurements box.
4. In the Available displays box, double-click . This moves the NR Occupied Bandwidth icon to the selected displays box.
5. Click **OK** to view the display.
6. Select **Setup > Settings** to display the control panel.
7. Select **Replay/Run** to take measurements on the acquired data.
8. If you are analyzing a data file, click **Replay** to take measurements on the recalled acquisition data file.

Elements of the display

The following image shows the NR OBW display.

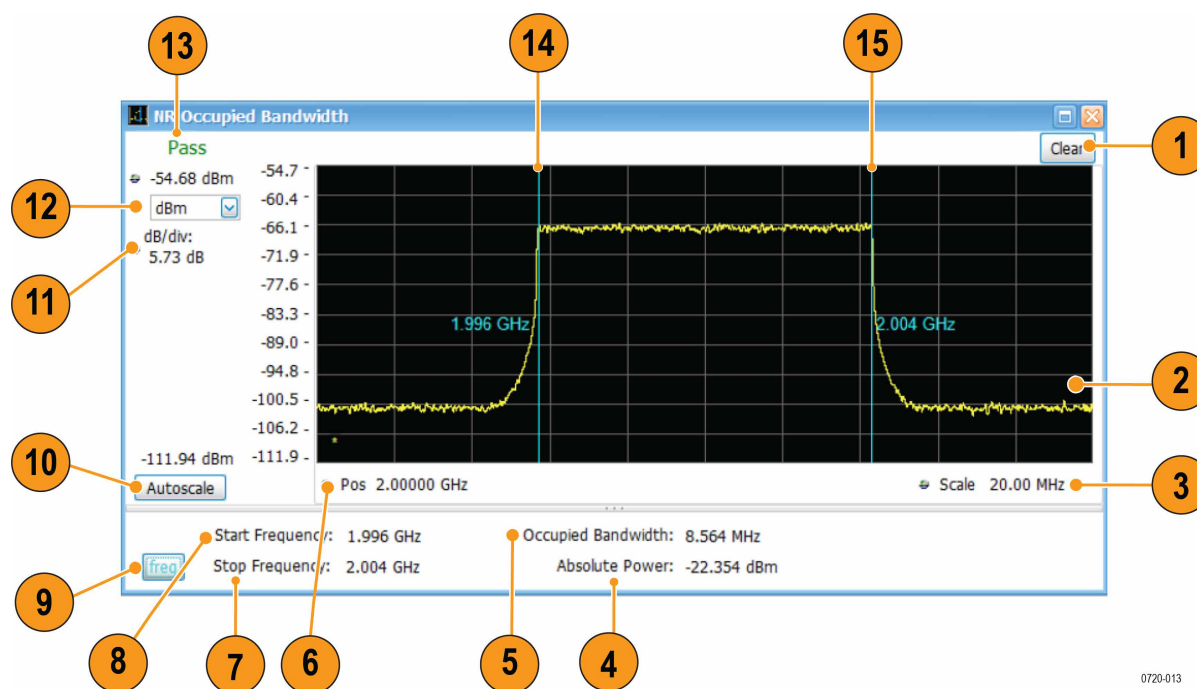

0720-013

Item	Display element	Description
1	Clear	Resets the measurement and clears all the values.
2	Plot	Displays Start Frequency and Stop Frequency of the occupied bandwidth.
3	Scale	Adjusts the frequency span of the graph.
4	Absolute Power	Displays the absolute power value.
5	Occupied Bandwidth	Displays the occupied bandwidth value.
6	Pos	Position in the center frequency at which measurement is performed.

Table continued...

Item	Display element	Description
7	Stop Frequency	Displays the Stop Frequency value.
8	Start Frequency	Displays the Start Frequency value.
9	freq	Displays the frequency color palette.
10	Autoscale	Adjusts the channel power magnitude and frequency scale settings so that the entire trace fits in the graph.
11	dB/div	Displays the channel power per division in the vertical axis of the plot.
12	Units	Sets the global amplitude units for all the views in the analysis window. This will change the amplitude selection in the units tab of the amplitude control panel.
13	Pass/Fail	Displays the result (Pass or Fail) based on the limit set in the OBW settings tab.
14	Start Frequency Indicator Line	Displays the Start Frequency line.
15	Stop Frequency Indicator Line	Displays the Stop Frequency line.

NR Occupied Bandwidth Display Settings

Main menu bar: **Setup > Settings**

Favorites toolbar: 

The NR Occupied Bandwidth display control panel provides access to settings that control parameters of the NR Occupied Bandwidth display.

Settings tab	Description
OBW	Allows you to configure the OBW specific properties.
Signal Configuration	Allows you to configure the signal properties.
Subblock Configuration	Allows you to configure the properties needed to analyze a subblock in 5G NR signal.
Carrier Configuration	Allows you to configure the carrier properties.
Averaging	Allows you to configure the averaging parameters.
Prefs	Allows you to configure settings required to show/hide graticule, marker readouts, and readouts.

NR EVM Display

The NR EVM displays the variation of an EVM over the OFDM symbol. Trace can be selected between RMS and Peak. Here EVM can either be the Peak value of EVM for each symbol or the RMS of each Symbol.

To view the NR EVM display:

1. Select **File > Recall** to analyze a stored data file or go to the next step.
2. Select **Setup > Displays**.
3. In the Select Displays window, select **5G NR Analysis** in the Measurements box.



4. In the Available displays box, double-click **NR EVM** . This moves the NR EVM icon to the selected displays box.

5. Click **OK** to view the display.
6. Select **Setup > Settings** to display the control panel.
7. Select **Replay/Run** to take measurements on the acquired data.
8. If you are analyzing a data file, click **Replay** to take measurements on the recalled acquisition data file.

Elements of the display

The following image shows the NR EVM display.

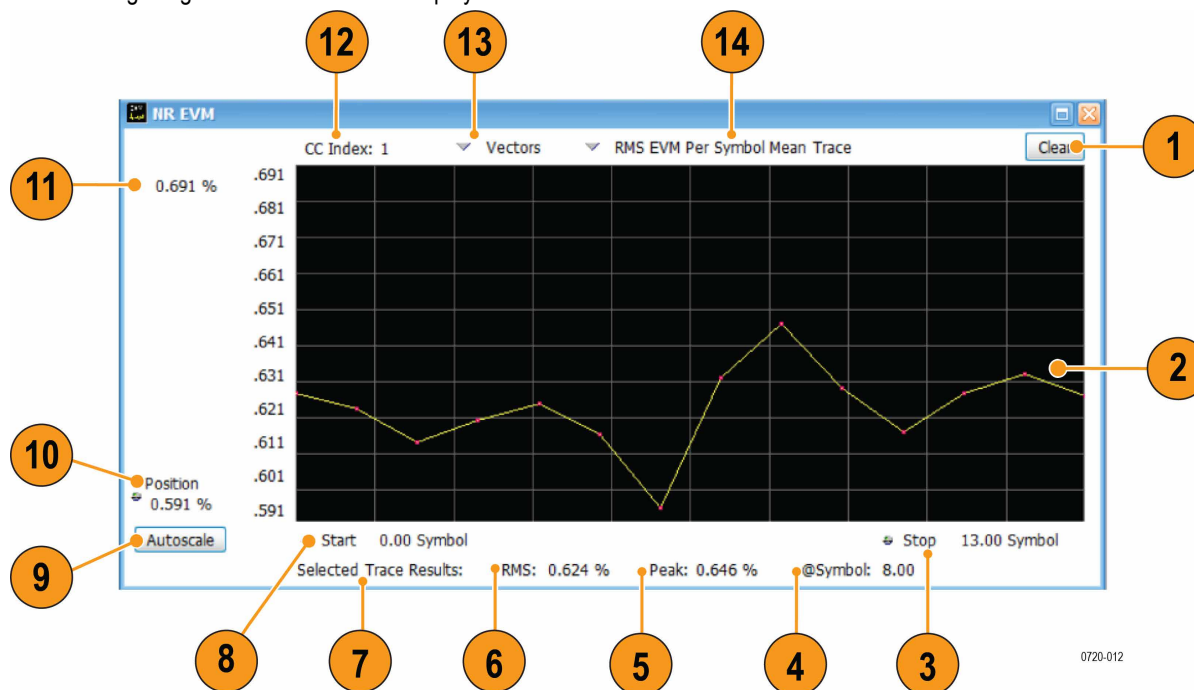

0720-012

Item	Display element	Description
1	Clear	Resets the measurement and clears all the values.
2	Plot	Displays the data symbol's EVM values versus symbol.
3	Stop symbol	Displays the stop symbol value.
4	@Symbol	Displays the symbol index at which the peak EVM occurred out of the entire set of symbols within the defined measurement length.
5	Peak	Displays the maximum value of peak EVMs calculated over measurement length.
6	RMS	Displays the mean value of RMS EVMs calculated over measurement length.
7	Selected Trace Results	Displays selected trace results.
8	Start symbol	Displays the start symbol value.
9	Autoscale	Adjusts the channel power magnitude and frequency scale settings so that the entire trace fits in the graph.
10	Position	Position in the frequency domain at which measurement is performed.
11	Peak EVM	Displays the peak EVM value.
12	CC Index	Displays the selected CC index. Available values: Depends on number of CCs.

Table continued...

Item	Display element	Description
13	Trace drawing	Allows to select the trace drawing mode. Available values: Vectors and Points.
14	Trace selection	Allows to select trace selection. Available values: RMS EVM Per Symbol Mean Trace, Peak EVM Per Symbol Maximum Trace

NR EVM Settings

Main menu bar: **Setup > Settings**

Favorites toolbar: 

The NR EVM display control panel provides access to settings that control parameters of the NR EVM display.

Settings tab	Description
Modulation Accuracy	Allows you to configure the modulation accuracy-specific properties.
Estimation	Allows you to configure the modulation accuracy Estimation properties.
Signal Configuration	Allows you to configure the signal properties.
Subblock Configuration	Allows you to configure the properties needed to analyze a subblock in 5G NR signal.
Carrier Configuration	Allows you to configure the carrier properties.
Averaging	Allows you to configure the averaging parameters.
Prefs	Allows you to configure settings required to show/hide graticule, marker readouts, and readouts.

NR Power vs Time Display

The NR Power vs Time display shows the signal power amplitude versus time.

To view the NR Power vs Time display:

1. Select **File > Recall** to analyze a stored data file or go to the next step.
2. Select **Setup > Displays**.
3. In the Select Displays window, select **5G NR Analysis** in the Measurements box.
4. In the Available displays box, double-click . This moves the NR Power vs Time icon to the selected displays box.
5. Click **OK** to view the display.
6. Select **Setup > Settings** to display the control panel.
7. Select **Replay/Run** to take measurements on the acquired data.
8. If you are analyzing a data file, click **Replay** to take measurements on the recalled acquisition data file.

Elements of the display

The following image shows the NR Power vs Time display.

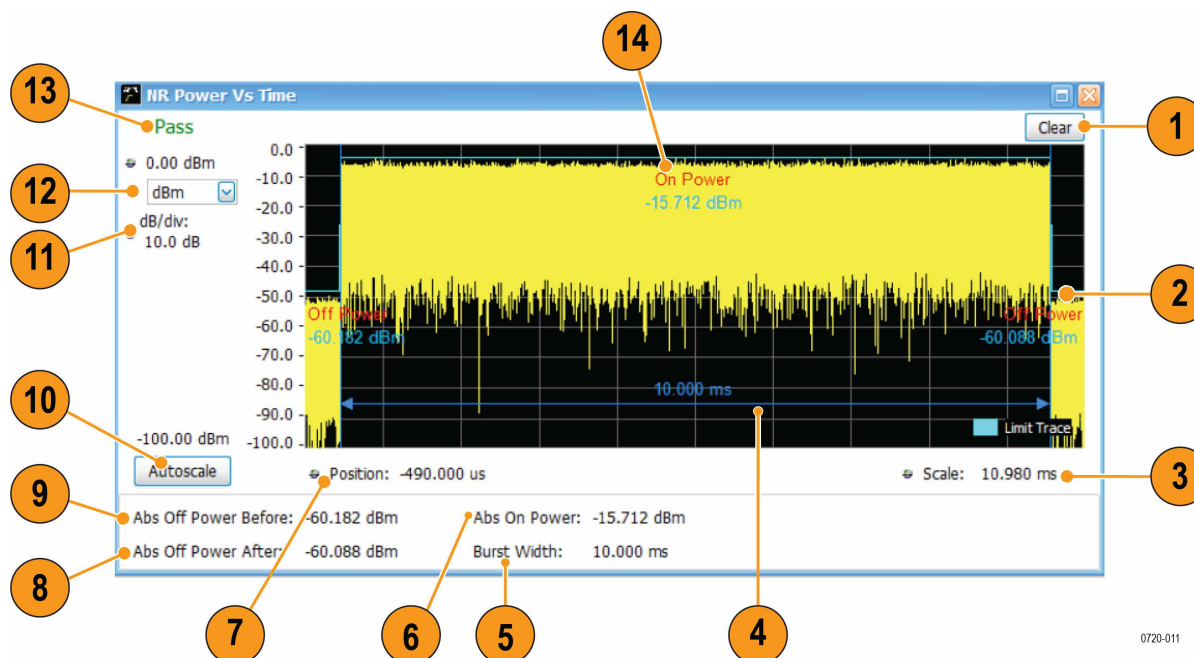

Item	Display element	Description
1	Clear	Resets the measurement and clears all the values.
2	Plot	Displays the signal power amplitude versus time.
3	Scale	Adjust the span of the graph.
4	Burst width level	Displays the burst width as a horizontal line.
5	Burst Width	Displays burst width value.
6	Abs On Power	Displays absolute on power value.
7	Position	Position in the frequency domain at which measurement is performed.
8	Abs Off Power After	Displays absolute off power after value.
9	Abs Off Power Before	Displays absolute off power before value.
10	Autoscale	Adjusts the channel power magnitude and frequency scale settings so that the entire trace fits in the graph.
11	dB/div	Displays the channel power per division in the vertical axis of the plot.
12	Units	Sets the global amplitude units for all the views in the analysis window. This will change the amplitude selection in the units tab of the amplitude control panel.
13	Pass/Fail	Displays the result (Pass or Fail) based on absolute and relative limits set.
14	Limit Trace	Displays the transmit ON/OFF time mask.

NR Power vs Time Settings

Main menu bar: **Setup > Settings**

Favorites toolbar: 

The NR Power vs Time display control panel provides access to settings that control parameters of the NR Power vs Time display.

Settings tab	Description
PVT	Allows you to configure the PVT specific properties.
Signal Configuration	Allows you to configure the signal properties.
Subblock Configuration	Allows you to configure the properties needed to analyze a subblock in 5G NR signal.
Carrier Configuration	Allows you to configure the carrier properties.
Averaging	Allows you to configure the averaging parameters.
Prefs	Allows you to configure settings required to show/hide graticule, marker readouts, and readouts.

NR Summary Display

Consolidated display of all the results from selected measurements like Modulation Accuracy, CHP, SEM, ACP, OBW and PVT. It provides an option to save all the results to a “.csv” file. Additional results related to the Modulation Accuracy measurement are available here.

To show the NR Summary display:

1. Select **File > Recall** to analyze a stored data file or go to the next step.
2. Select **Setup > Displays**.
3. In the Select Displays window, select **5G NR Analysis** in the Measurements box.



4. In the Available displays box, double-click **NR Summary**. This moves the NR Summary icon to the selected displays box.
5. Click **OK** to view the display.
6. Select **Setup > Settings** to display the control panel.
7. Select **Replay/Run** to take measurements on the acquired data.
8. If you are analyzing a data file, click **Replay** to take measurements on the recalled acquisition data file.

Elements of the display

The following images show the NR Summary display.

Summary view for Modulation Accuracy:

Number of component carriers: 4

Link direction: Uplink

Measurement Results	Carrier 1	Carrier 2	Carrier 3	Carrier 4
Cell ID	0	1	2	3
Carrier Offset	-75.000 MHz	-25.020 MHz	24.960 MHz	74.940 MHz
Composite RMS EVM Mean	0.483 %	0.546 %	0.476 %	0.495 %
Composite Peak EVM Maximum	1.543 %	8.620 %	1.443 %	1.668 %
Composite Peak EVM Slot Index	0	0	0	0
Composite Peak EVM Symbol Index	5	12	6	12
Composite Peak EVM Subcarrier Index	37	69	37	1019
Component Carrier Frequency Mean Error	826.231 Hz	847.748 Hz	869.046 Hz	890.632 Hz
Component Carrier IQ Origin Offset Mean	-77.157 dBc	-75.949 dBc	-89.485 dBc	-75.785 dBc
Component Carrier IQ Gain Imbalance Mean	-0.003 dB	0.000 dB	-0.003 dB	0.001 dB
Component Carrier IQ Quadrature Error Mean	0.018 °	-0.012 °	-0.014 °	-0.027 °
SCH Data Peak EVM Maximum	1.543 %	8.620 %	1.443 %	1.668 %
SCH Data RMS EVM Mean	0.484 %	0.548 %	0.475 %	0.495 %
SCH DMRS Peak EVM Maximum	1.139 %	1.689 %	1.272 %	1.176 %
SCH DMRS RMS EVM Mean	0.479 %	0.494 %	0.488 %	0.504 %

Item	Display element	Description
1	Number of component carriers	Displays the number of component carriers.
2	Link direction	Displays the link direction.
3	Results table	Displays the modulation accuracy results.

Summary view for CHP:

Total Agg Power: -8.718 dBm

Measurement Results	Carrier 1	Carrier 2	Carrier 3	Carrier 4
Absolute power	-14.324 dBm	-14.146 dBm	-14.773 dBm	-15.962 dBm
Relative power	-5.607 dB	-5.429 dB	-6.055 dB	-7.244 dB

0720-009

Item	Display element	Description
1	Total Agg Power	Displays the total aggregated power.
2	Results table	Displays the CHP results.

Summary view for ACP:

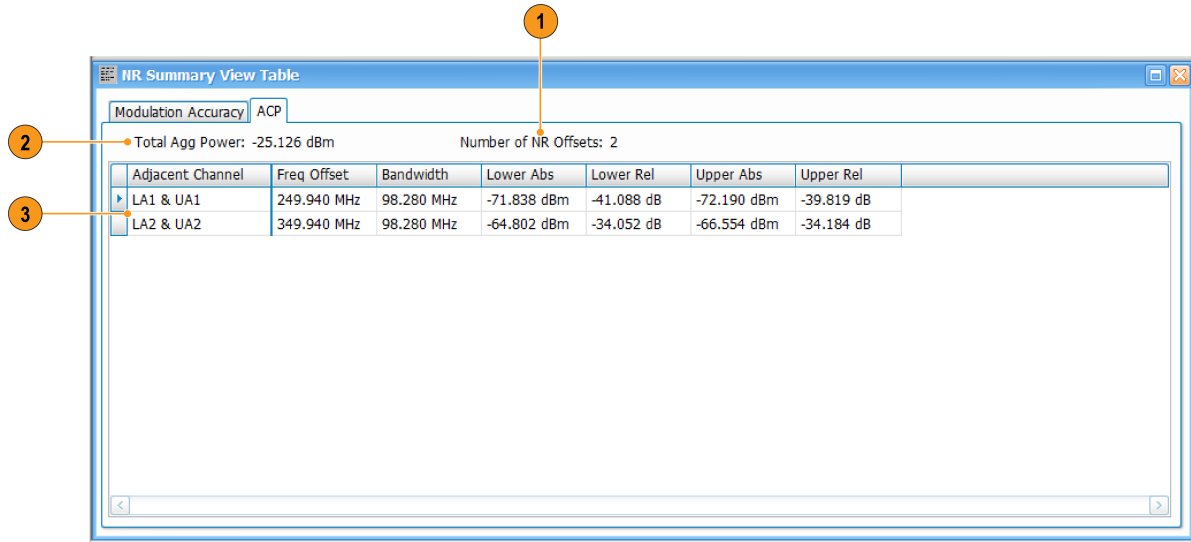

0720-008

Item	Display element	Description
1	Number of NR Offsets	Displays the number of NR Offsets.
2	Total Agg Power	Displays the total aggregated power.
3	Results table	Displays the ACP results.

Summary view for SEM:

Offset	Start Freq	Stop Freq	Peak Abs	Peak Rel	Peak Freq	Margin	Margin Abs	Margin Rel	Margin Freq	Int
OL1	-50.000 kHz	-5.050 MHz	-80.523 dBm	-66.136 dB	6.798 GHz	-71.811 dB	-83.556 dBm	-69.169 dB	6.795 GHz	-67
OL2	-5.050 MHz	-10.050 MHz	-81.442 dBm	-67.055 dB	6.791 GHz	-69.242 dB	-81.442 dBm	-67.055 dB	6.791 GHz	-67
OL3	-10.500 MHz	-15.500 MHz	-74.182 dBm	-59.795 dB	6.787 GHz	-61.182 dB	-74.182 dBm	-59.795 dB	6.787 GHz	-67
OU1	50.000 kHz	5.050 MHz	-83.215 dBm	-67.273 dB	7.204 GHz	-71.288 dB	-83.436 dBm	-67.493 dB	7.205 GHz	-6E
OU2	5.050 MHz	10.050 MHz	-82.479 dBm	-66.536 dB	7.209 GHz	-70.279 dB	-82.479 dBm	-66.536 dB	7.209 GHz	-6E
OU3	10.500 MHz	15.500 MHz	-74.511 dBm	-58.569 dB	7.215 GHz	-61.511 dB	-74.511 dBm	-58.569 dB	7.215 GHz	-6E

0720-007

Item	Display element	Description
1	Pass/Fail	Displays Pass/Fail result based on absolute and relative limits set by the user.
2	Total Agg Power	Displays the total aggregated power.
3	Results table	Displays the SEM results.

Summary view for OBW:

0720-014

Item	Display element	Description
1	Occupied Bandwidth	Returns the bandwidth that occupies the specified percentage of the total power of the signal. This value is expressed in Hz.
2	Absolute Power	Returns the total power measured in the spectrum acquired by the measurement. This value is expressed in dBm.
3	Start Frequency	Returns the Start Frequency of the occupied bandwidth of carrier/subblock. This value is expressed in Hz.
4	Stop Frequency	Returns the Stop Frequency of the occupied bandwidth of carrier/subblock. This value is expressed in Hz.

Summary view for PVT:

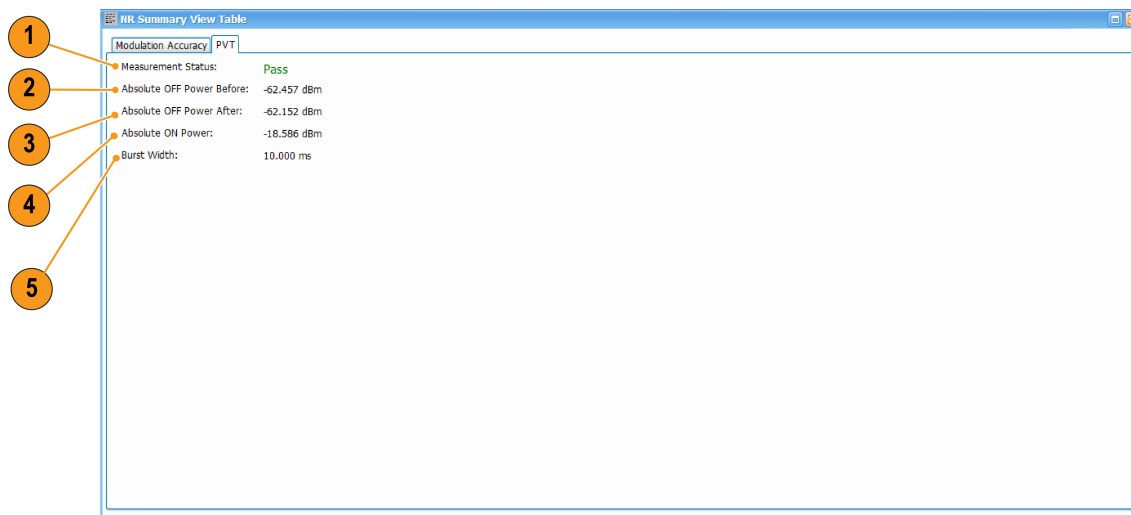

0720-015

Item	Display element	Description
1	Measurement Status	Returns the measurement status indicating whether the off power before and after is within the standard defined limit.
2	Absolute OFF Power Before	Returns the OFF power in the segment before the captured burst. The segment is defined as one slot prior to a short transient segment and the burst. This value is expressed in dBm.
3	Absolute OFF Power After	Returns the OFF power in the segment after the captured burst. The segment is defined as one slot after the burst and a short transient segment. This value is expressed in dBm.
4	Absolute ON Power	Returns the power of the slots within the captured burst. This value is expressed in dBm.
5	Burst Width	Returns the width of the captured burst. This value is expressed in seconds.

NR Summary Display Settings

Main menu bar: **Setup > Settings**

Favorites toolbar: 

The NR Summary display control panel allows you to configure the settings of the NR Summary display.

Settings tab	Description
Modulation Accuracy	Allows you to configure the modulation accuracy-specific properties.
ACP	Allows you to configure the ACP-specific properties.
CHP	Allows you to configure the CHP specific properties.
SEM	Allows you to configure SEM specific properties.
OBW	Allows you to configure the OBW specific properties.
PVT	Allows you to configure the PVT specific properties.
Signal Configuration	Allows you to configure the signal properties.
Subblock Configuration	Allows you to configure the properties needed to analyze a subblock in 5GNR signal.
Carrier Configuration	Allows you to configure the carrier properties.
Averaging	Allows you to configure the averaging parameters.

NR Analysis Measurement Settings

Main menu bar: **Setup > Settings**

Favorites toolbar: 

The control panel tabs in this section are shared between the displays in 5GNR Analysis (**Setup > Displays**). Some tabs are shared by all the displays and some tabs are shared by only a subset of displays. The settings available on some tabs change depending on the selected display.

Controls for 5GNR Analysis displays

Settings tab	Description
Modulation Accuracy	Allows you to configure the modulation accuracy-specific properties.
ACP	Allows you to configure the ACP-specific properties.
CHP	Allows you to configure the CHP specific properties.
SEM	Allows you to configure SEM specific properties.
OBW	Allows you to configure the OBW specific properties.
PVT	Allows you to configure the PVT specific properties.
Signal Configuration	Allows you to configure the signal properties.
Subblock Configuration	Allows you to configure the properties needed to analyze a subblock in 5GNR signal.
Carrier Configuration	Allows you to configure the carrier properties.
Averaging	Allows you to configure the averaging parameters.
Traces	Allows you to set the display characteristics of the traces. Available for the NR Constellation display only.

Table continued...

Settings tab	Description
Prefs	Allows you to configure settings required to show/hide graticule, marker readouts, and readouts.

ACP Tab

The **ACP** tab allows you to configure the settings required for the adjacent channel power measurement.

The following image is of the **ACP** tab for the NR adjacent channel power display.

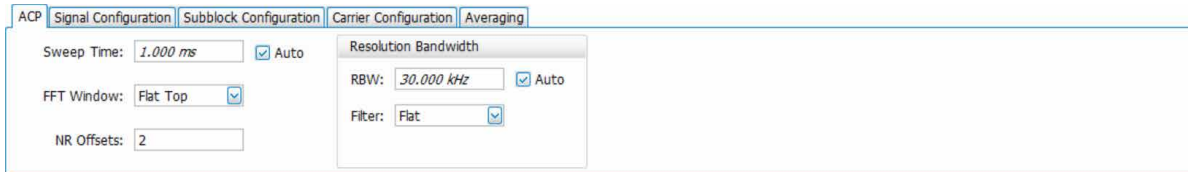

Setting	Available options	Description
Sweep Time	1 μ s to 20 ms	Specifies the sweep time or the total analysis time for the ACP measurement. To manually specify the sweep time, uncheck Auto . Default value: 1.000 ms
FFT Window	None	No FFT window.
	<ul style="list-style-type: none"> • Flat Top • Hanning • Hamming • Gaussian • Blackman • Blackman-Harris • Kaiser-Bessel 	Select reduce spectral leakage.
NR Offset	0, 1, 2, 3, 4, 5, 6	Specifies the number of offsets to be displayed and ACP measurement to be run. Default value: 2
Resolution Bandwidth		
RBW		Displays the Resolution Bandwidth (RBW) for NR measurements. To manually specify the RBW, uncheck Auto . Default value: 30 kHz

Table continued...

Setting	Available options	Description
RBW Filter		Specifies the RBW filter method used for the transform. Default value: FFT Based
	Flat	Specifies the RBW filter with a flat response.
	FFT Based	No RBW filtering is performed.
	Gaussian	Specifies the RBW filter with a gaussian response.

Signal Configuration Tab

The Signal Configuration tab allows you to configure the signal settings like link direction and transmitter architecture required for the 5G NR measurements. In downlink mode, it allows you to select the mode and the gNodeB category.

The following image is of the Signal Configuration tab available for the NR adjacent channel power, NR channel power, NR constellation, NR spectral emission mask, and NR summary displays.

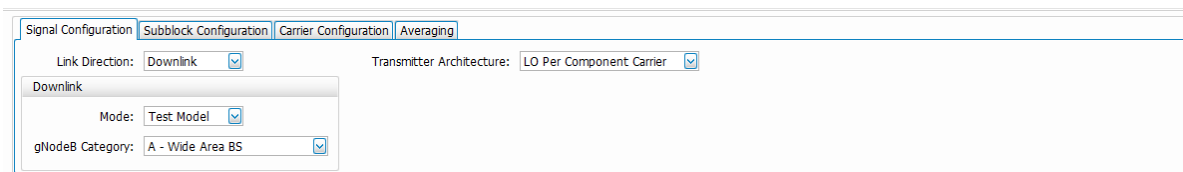

Setting	Available options	Description
Link Direction		Specifies the Link Direction of the signal. You can set to Uplink or Downlink depending on the signal type. Default value: Uplink
	Uplink	Unidirectional radio link for the transmission of signals from the user equipment to a base station, from a mobile station to a mobile base station, or from a mobile base station to a base station.
	Downlink	Unidirectional radio link for the transmission of signals from a base station to user equipment. Also, in general, the direction from network to user equipment.
Downlink		
Mode		Specifies downlink channel configuration mode. Default value: Test Model
	Test Model	A test model needs to be selected that will configure all the signals and channels automatically according to the specifications.
	User Defined	Select to manually configure the signals, subblocks, and channels.

Table continued...

Setting	Available options	Description
gNodeB Category	A - Wide Area BS	Specifies the Downlink gNodeB category Default value: A - Wide Area BS
	B (Option 1) - Wide Area BS	The gNodeB type is Wide Area Base Station - Category B Option1.
	B (Option 2) - Wide Area BS	The gNodeB type is Wide Area Base Station - Category B Option2.
	Local Area BS	The gNodeB type is Local Area Base Station.
	Medium Range BS	The gNodeB type is Medium Range Base Station.
Transmitter Architecture		Specifies the RF architecture at the transmitter in case of multi-carrier. Each carrier can have a separate Local Oscillator (LO) or one common for the entire subblock. Default value: Lo Per Component Carrier
	Lo Per Component Carrier	Local oscillator per component carrier.
	Lo Per SubBlock	Local oscillator per subblock.

Subblock Configuration Tab

The Subblock Configuration tab allows you to analyze a subblock in 5GNR signal.

The following image is of the Subblock Configuration tab available for the NR adjacent channel power, NR channel power, NR constellation, NR spectral emission mask, and NR summary displays.

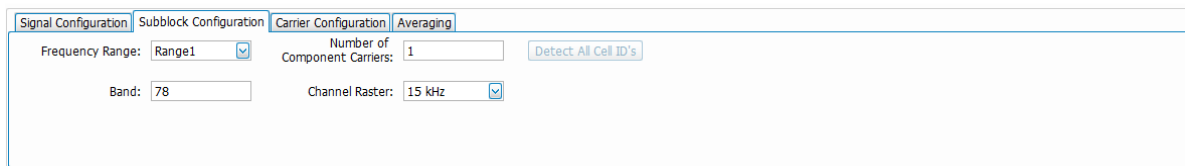

Setting	Available options	Description
Frequency Range		Specifies whether to use band, channel bandwidth, and subcarrier spacing configuration supported in the frequency range 1 or the frequency range 2. Default value: Range 1
	Range 1	The measurement uses the band, channel bandwidth, and the subcarrier spacing configuration supported in frequency range 1.
	Range2	The measurement uses the band, channel bandwidth, and the subcarrier spacing configuration supported in frequency range 2.

Table continued...

Setting	Available options	Description
Band		Specifies the E-UTRA or NR operating frequency of a subblock. The band determines the spectral flatness mask and spectral emission mask. Default value: 78
	1, 2, 3, 5, 7, 8, 12, 20, 25, 28, 34, 38, 39, 40, 41, 50, 51, 66, 70, 71, 74, 75, 76, 77, 78, 79, 80, 81, 82, 83, 84, and 86	Bands supported for frequency range 1
	257, 258, 260, and 261	Bands supported for frequency range 2
Number of Component Carriers		Specifies the number of component carriers in a subblock. Default value: 1
	1	Set to 1 for a single carrier.
	2 to 8	Number of component carriers in a subblock (greater than 2 for multiple component carriers in a subblock)
Channel Raster	15 kHz, 60 kHz, 100 kHz	Specifies the subblock channel raster which is used for computing nominal spacing between aggregated carriers. The value is expressed in Hz. The channel raster defines a subset of RF reference frequencies that can be used to identify the RF channel position in the uplink and downlink. The RF reference frequency for an RF channel maps to a resource element on the carrier. Default value: 15 kHz
Detect All Cell ID's		Select to detect all carrier's cell id. This is enabled when Link direction is set as Downlink and Downlink configuration mode is set to User Defined.

Carrier Configuration Tab

The Carrier Configuration tab allows you to configure the component carrier settings of the 5G NR signal. Each component carrier is represented by its row in the table. The corresponding PDSCH/PUSCH configurations are available through a button click at the right side of the table.

The following image is of the Carrier Configuration tab available for the NR adjacent channel power, NR channel power, NR constellation, NR spectral emission mask, NR Power vs Time, NR Occupied Bandwidth, NR EVM, and NR summary displays.

Select	Component Carrier	Bandwidth	Test Model	Duplex Scheme	Subcarrier spacing	Cyclic prefix
4		100 MHz	TM1.1	Downlink FDD	30 kHz	Normal
5		100 MHz	TM1.1	Downlink FDD	30 kHz	Normal
6		100 MHz	TM1.1	Downlink FDD	30 kHz	Normal
7		100 MHz	TM1.1	Downlink FDD	30 kHz	Normal
8		100 MHz	TM1.1	Downlink FDD	30 kHz	Normal

Setting	Available options	Description
Select		Allows to select the component carrier, which helps to : <ul style="list-style-type: none"> Configure all component carriers with the selected component carrier configurations.

Table continued...

Setting	Available options	Description
		<ul style="list-style-type: none"> • Detect selected component carrier Cell ID. • Configure parameters related to PUSCH/PDSCH for selected component carriers.
Component carrier		Specifies which component carrier is being configured.
Bandwidth		<p>Specifies component carrier's channel bandwidth.</p> <p>Default value: 100MHz</p> <p>Available values in MHz for Range 1: 5, 10, 15, 20, 25, 30, 40, 50, 60, 70, 80, 90, 100</p> <p>Available values in MHz for Range 2: 50, 100, 200, 400</p>
Frequency Offset		<p>Specifies the offset of the component carrier from the subblock center frequency.</p> <p>Default value: 0</p>
Test Model		<p>Specifies the NR downlink test models.</p> <p>This can be configured when the Link direction is Downlink and Downlink configuration mode is set to Test model.</p> <p>Default value: TM1.1</p> <p>Available values: TM1.1, TM1.2, TM2, TM2a, TM3.1, TM3.1a, TM3.2, TM3.3</p>
Duplex scheme	Downlink FDD, Downlink TDD	<p>Specifies the duplexing technique of the signal being measured.</p> <p>FDD refers to Frequency-Division duplexing.</p> <p>TDD refers to Time-Division duplexing.</p> <p>This can be configured when the Link direction is Downlink and Downlink configuration mode is Test model.</p> <p>Default value: Downlink FDD</p>
Cell ID	0 to 1007	<p>Specifies the physical layer cell identity.</p> <p>This can be configured when Auto calculation cell ID is deselected.</p> <p>Default value: 0</p>
Reference grid	Subcarrier spacing	<p>Specifies the subcarrier spacing of the reference resource grid. This should be the largest subcarrier spacing used in the component carrier.</p> <p>Default value: 30 kHz</p> <p>Available values for Range 1: 15 kHz, 30 kHz, 60 kHz</p> <p>Available values for Range 2: 60 kHz and 120 kHz</p>
	Start	<p>Default value: 0</p> <p>Available values: 0 to 275</p>
Bandwidth part	Subcarrier spacing	<p>Default value: 30kHz</p> <p>Available values for Range1: 15 kHz, 30 kHz, 60 kHz</p> <p>Available values for Range 2: 60 kHz and 120 kHz</p>

Table continued...

Setting	Available options	Description
	cyclic prefix	Specifies the cyclic prefix (CP) duration and the number of symbols in a slot for the signal being measured. Default value: Normal Available values: Normal
	Bandwidth part Grid start	Specifies the resource grid starts relative to reference point A in terms of resource block offset. Default value: 0
	RB offset	Specifies the resource block offset of a bandwidth part relative to the resource grid start the property. Default value: 0
	RBs	Specifies the number of consecutive resource blocks in a bandwidth part. Default value: 0
Auto Calculation		Deselection of any of these parameters enables manual mode which allows to configure them manually.
	Cell ID	Deselect to configure the cell ID manually.
	Frequency	Deselect to configure the Frequency manually.
	Reference Grid	Deselect to manually configure the Reference Grid Subcarrier spacing and Reference Grid Start values.
	Resource Block	Deselect to manually configure the RB offset and RBs values.
Expand		Click to view the table in a separate window. You can also configure the table.
PDSCH		Click to configure the PDSCH parameters. PDSCH button is enabled when link direction is selected as Downlink.
PUSCH		Click to configure the PUSCH parameters. PUSCH button is enabled when link direction is selected as Uplink.
Detect All Cell ID's		Select to manually identify the Cell ID of the signal. This button is enabled when link direction is configured as Downlink and Downlink.
Apply for All CC		Click to apply all the selected component carrier to all component carriers, except the Cell ID.

Physical Uplink Shared Channel for Component Carrier 1 Window

The **Physical Uplink Shared Channel for Component Carrier 1 Window** allows you to configure the PUSCH settings for the selected component carrier. The DMRS and PTRS settings related to the corresponding PUSCH are also configurable through this window.

The following image is of the **Physical Uplink Shared Channel for Component Carrier 1 Window** available in the carrier configuration tab.

Physical Uplink Shared Channel for Component Carrier 1

Modulation Type: Symbol Allocation: All Slot Allocation: All

Transform Precoding

DMRS (Release 16)

Number Of CDM Groups: Power Mode: Antenna Ports: Power:

Mapping

Configuration Type: Additional Positions: Duration: Mapping Type: Type A Position:

Transform Precoding

Group Hopping Sequence Hopping PUSCH Id Mode: User defined ID:

Scrambling

Mode: Identity: Initialization:

PTRS

PTRS

Power Mode: Power: Antenna Ports:

Mapping



Resource Element Offset: Frequency Density: Time Density:

Transform Precoding

Group Number: Samples:

Setting	Available options	Description
Modulation Type		Specifies the modulation scheme used in the physical uplink shared channel (PUSCH) of the signal being measured. Default value: QAM256
	PI/2 BPSK, QPSK, QAM16, QAM64, QAM256, QAM1024	Specifies a PI/2 BPSK modulation scheme. Specifies a QPSK modulation scheme. Specifies a 16 QAM modulation scheme. Specifies a 64 QAM modulation scheme. Specifies a 256 QAM modulation scheme. Specifies a 1024 QAM modulation scheme.

Table continued...

Setting	Available options	Description
Symbol Allocation	1:14	<p>Specifies the symbol allocation of each slot.</p> <p>Valid values are from 1 to 14, inclusive.</p> <p>The format is defined by range format specifiers. The range format specifier is a comma separated list of entries.</p> <p> Note: If incorrect value is entered in symbol allocation, the value will be highlighted in red color</p> <p>Examples: 2,4 will expand to {2,4} 1:3,7 will expand to {1,2,3,7}.</p> <p>To manually specify the symbol allocation, uncheck All.</p>
Slot Allocation	1:20	<p>Specifies the slot allocation in NR Frame. This defines the indices of the allocated slots.</p> <p>Valid values are from 1 to maximum number of slots in the frame max number of slots is dependent on numerology within the specifications</p> <p>The format is defined by range format specifiers. The range format specifier is a comma-separated list of entries.</p> <p> Note: If incorrect value is entered in slot allocation, the value will be highlighted in red color</p> <p>Examples: 2,4 will expand to {2,4} 1:3,7 will expand to {1,2,3,7}.</p> <p>To manually specify the slot allocation, uncheck All.</p>
DMRS (Release 16)		
Power Mode		<p>Specifies whether the value of PUSCH DMRS Pwr property is calculated based on the PUSCH DMRS number of CDM Groups value or specified by the user (user-defined).</p> <p>Select to calculate the PUSH DRMS Pwr value based on PUSCH DMRS number of CDM Groups value or by user-defined method.</p> <p>Default value: CDM</p>
	User Defined	Specifies the DMRS power manually.
Antenna Ports		Specifies the antenna ports used for DMRS transmission.
Power		Specifies the factor which boosts the PUSCH DMRS REs. This value is expressed in dB. This property is ignored if you set the "Power Mode" value to CDM Groups.
Number of CDM Groups		Specifies the number of CDM groups, when you set the PUSCH "Transform Precoding" value to False, otherwise, it is set to 2.
Mapping		
Table continued...		

Setting	Available options	Description
Configuration Type		Specifies the DMRS configuration type. Default value: Type 1
	<ul style="list-style-type: none"> • Type 1 • Type 2 	<ul style="list-style-type: none"> • One DMRS subcarrier alternates with one data subcarrier. • Two consecutive DMRS subcarriers alternate with four consecutive data subcarriers.
Duration		Specifies whether the DMRS is single-symbol or double-symbol.. Default value: Single Symbol
	Single Symbol	There are one or more non-consecutive DMRS symbols in a slot.
	Double Symbol	There are one or more sets of two consecutive DMRS symbols in the slot.
Type A Position	2,3	Specifies the position of the first DMRS symbol in a slot when you set the PUSCH "Mapping Type" value to Type A. 2: The first DMRS symbol index in a slot is 2. 3: The first DMRS symbol index in a slot is 3.
Additional Positions		Specifies the number of additional sets of consecutive DMRS symbols in a slot. Default value: 0
	0,1,2,3	0: No additional DMRS symbol set is present in the slot. 1: One additional DMRS symbol set is present in the slot. 2: Two additional DMRS symbol sets are present in the slot. 3: Three additional DMRS symbol sets are present in the slot.
Mapping Type		Specifies the mapping type of DMRS. Default value: Type A
	Type A	The first DMRS symbol index in a slot is either 2 or 3 based on PUSCH DMRS "Type A Position" value.
	Type B	The first DMRS symbol index in a slot is the first active PUSCH symbol.
Scrambling		
Mode		Specifies whether the configured Scrambling ID is honored or the Cell ID is used for reference signal generation. Default value: Cell ID
	Cell ID	The value of the PUSCH DMRS Scrambling ID is based on the Cell ID property.
	User Defined	Select this to configure the Scrambling ID manually.
Identity	0 to 65535	Specifies the value of scrambling ID. This property is valid only when you set the PUSCH "Transform Precoding" value to False.
Initialization		Specifies the DMRS nSCID used for reference signal generation.
Transform Precoding		Enable or disable Transform precoding configurations.

Table continued...

Setting	Available options	Description
Group Hopping		Specifies whether the group hopping is enabled. This parameter is valid only when you set the PUSCH "Transform Precoding" value is set to True.
Sequence Hopping		Enable or disable Sequence hopping.
PUSCH ID Mode		Specifies whether PUSCH DMRS PUSCH ID is based on Cell ID or user-defined. This parameter is valid only when you set the PUSCH "Transform Precoding" value is set to True. Default value: Cell ID
	Cell Id	The value of PUSCH DMRS PUSCH ID is based on the Cell ID property.
	User Defined	The value of the PUSCH DMRS PUSCH ID is specified by the user.
User Defined ID	0 to 1007	Specifies the value of PUSCH DMRS PUSCH ID used for reference signal generation. This property is valid only when you set the PUSCH "Transform Precoding" value to True and PUSCH DMRS "PUSCH ID Mode" value to User Defined.
PTRS		Enable or disable PTRS.
Power Mode	Standard, User Defined	Specifies the DMRS antenna ports associated with PTRS transmission. This property is valid only if you set the PTRS Enabled property to True. Default value: Standard
Power		Specifies the factor by which the PUSCH PTRS REs are boosted. This value is expressed in dB. This property is valid only if you set the PTRS Enabled property to True.
Antenna Ports		Specifies the DMRS antenna ports associated with PTRS transmission. This property is valid only if you set the PTRS Enabled property to True .
Mapping		
Resource Element Offset	00, 01, 10, 11	Specifies the RE offset to be used for transmission of PTRS. This property is valid only if you set the PTRS Enabled property to True and Transform Precoding Enabled property to False. Default Value: 00
Frequency Density	2, 4	Specifies the density of PTRS in frequency domain. This property is valid only if you set the PTRS Enabled property to True and Transform Precoding Enabled property to False. Default Value: 2
Time Density	1, 2, 4	Specifies the density of PTRS in time domain. This property is valid only if you set the PTRS Enabled property to True. Default Value: 1
Transform Precoding		Enable or disable Transform precoding configurations.
Group Number	2, 4, 8	Specifies the number of PTRS groups per OFDM symbol. This property is valid only if you set the PTRS Enabled property to True and Transform Precoding Enabled property to True. Default Value: 2

Table continued...

Setting	Available options	Description
Samples	2, 4	Specifies the number of samples per each PTRS group. This property is valid only if you set the PTRS Enabled property to True and Transform Precoding Enabled property to True. Default Value: 2

Physical Downlink Shared Channel for Component Carrier 1 Window

The **Physical Downlink Shared Channel for Component Carrier 1 Window** allows you to configure the PDSCH settings for the selected component carrier. The DMRS and PTRS settings related to the corresponding PDSCH are also configurable through this window.

The following image is of the **Physical Downlink Shared Channel for Component Carrier 1 Window** available in the carrier configuration tab.

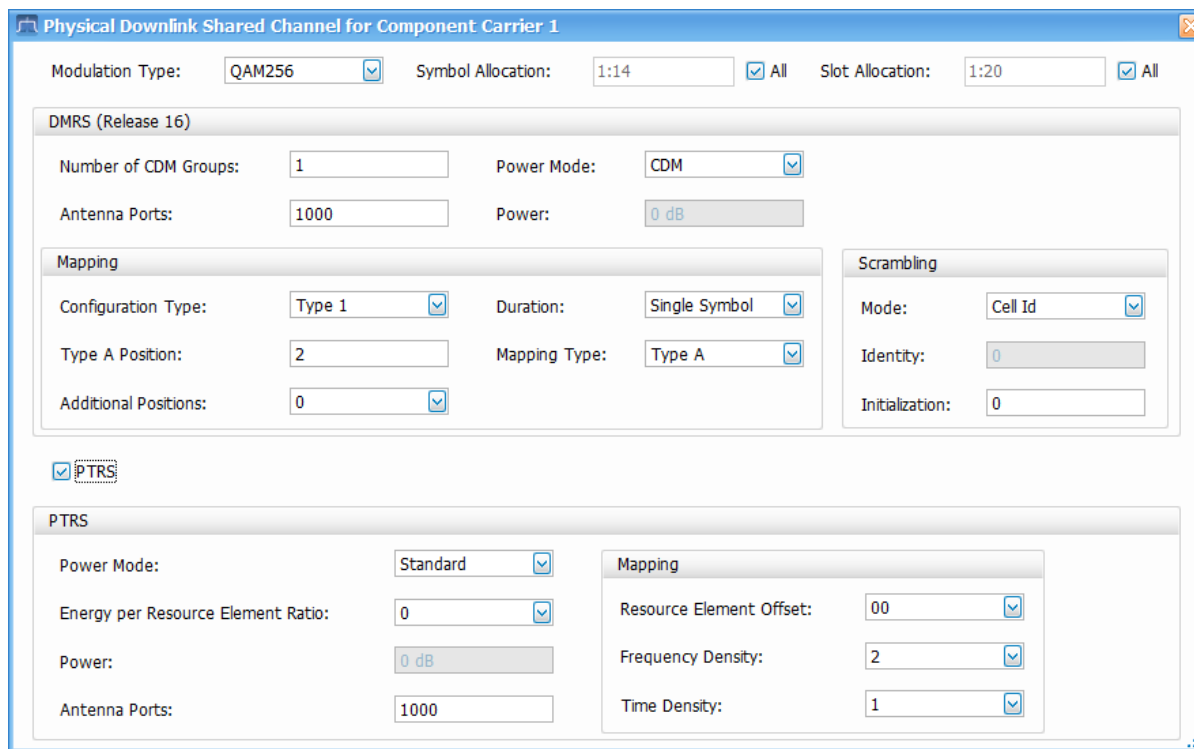

Setting	Available options	Description
Modulation Type		Specifies the modulation type used in the physical downlink shared channel (PDSCH) channel of the signal being measured. Default value: QAM256
	QPSK, QAM16, QAM64, QAM256, QAM1024	Specifies a QPSK modulation scheme. Specifies a 16 QAM modulation scheme. Specifies a 64 QAM modulation scheme. Specifies a 256 QAM modulation scheme. Specifies a 1024 QAM modulation scheme.
Symbol Allocation	1:14	Specifies the symbol allocation of each slot. To manually specify the symbol allocation, uncheck All.
Slot Allocation	1:20	Specifies the number of PDSCH slot configurations. To manually specify the slot allocation , uncheck All.
DMRS (Release 16)		
Power Mode	CDM	Specifies whether the DMRS power is calculated based on several CDM groups or manually entered by a user Default value: CDM
	User Defined	Specifies the DMRS power manually.
Antenna Ports		Specifies the Antenna ports used for DMRS transmission. Default value: 1000
Power		Specifies the DMRS power. Default value: 0
Number of CDM Groups		Specifies the number of CDM groups. Default value: 1
Mapping		
Configuration Type		Specifies the DMRS configuration type. Default value: Type 1
	<ul style="list-style-type: none"> • Type 1 • Type 2 	<ul style="list-style-type: none"> • One DMRS subcarrier alternates with one data subcarrier. • Two consecutive DMRS subcarriers alternate with four consecutive data subcarriers.
Duration		Specifies whether the DMRS is a single symbol or double symbol. Default value: Single Symbol
	Single Symbol	There are one or more non-consecutive DMRS symbols in a slot.
	Double Symbol	There are one or more sets of two consecutive DMRS symbols in the slot.
Table continued...		

Setting	Available options	Description
Type A Position		Specifies the position of the first DMRS symbol in a slot for Type A configurations. Default value: 2
Additional Positions	0	Specifies the number of additional sets of consecutive DMRS symbols in a slot. Default value: 0
	1,2,3	Different additional DMRS symbols are set in the slot.
Mapping Type		Specifies the mapping type of DMRS. Default value: Type A
	Type A	The first DMRS symbol index in a slot is either 2 or 3
	Type B	The first DMRS symbol index in a slot is 0.
Scrambling		
Mode	Cell ID	Specifies the configured Scrambling ID is based on Cell ID or specified by the user. Default value: Cell ID
	User Defined	Select this to configure Scrambling ID manually.
Identity		Specifies the scrambling ID used for reference signal generation. Default value: 0
Initialization		Specifies the DMRS nSCID used for reference signal generation. Default value: 0
PTRS		
Power Mode	Standard, User Defined	Specifies whether the configured PTRS Power is calculated as per standard specification or configured by you. Default value: Standard
Energy per Resource Element Ratio	0, 1	Specifies the EPRE Ratio Port used to determine the PDSCH PT-RS RE power scaling when you set the PTRS Power Mode property to Standard. Default Value: 0
Power		Specifies the factor by which the PDSCH PTRS REs are boosted, compared to PDSCH REs. This value is expressed in dB. The value of this property is taken as an input when you set the Power Mode property to User Defined. If you set the PDSCH PTRS Power Mode property to Standard, the value is computed from other parameters.
Antenna Ports	1000	Specifies the DMRS Antenna Ports associated with PTRS transmission.
Mapping		
Resource Element Offset	00, 01, 10, 11	Specifies the RE Offset to be used for transmission of PTRS. Default Value: 00
Frequency Density	2, 4	Specifies the density of PTRS in frequency domain. Default Value: 2

Table continued...

Setting	Available options	Description
Time Density	1, 2, 4	Specifies the density of PTRS in time domain. Default Value: 1

Averaging Tab

The Averaging tab allows you to configure the settings for averaging 5G NR measurements. The number of acquisitions and the averaging type for different measurements (modulation accuracy is always mean) is configurable in this tab.

The following image is of the Averaging tab available for the NR adjacent channel power, NR channel power, NR constellation, NR spectral emission mask, NR EVM, NR Occupied Bandwidth, NR Power vs Time, and NR summary displays.

Setting	Available options	Description
Averaging		Specifies whether the averaging parameters are available to configure.
Count		Specifies the number of acquisitions used for averaging. Default value: 10
ACP Averaging Type		Specifies the averaging type for averaging spectral acquisitions. Default value: RMS
	RMS	Spectral acquisitions are averaged linearly.
	Log	Spectral acquisitions are averaged on a logarithmic scale.
	Scalar	Square root of spectral acquisitions is averaged.
	Max	The maximum power in the spectrum at each frequency bin is retained from one acquisition to the next.
	Min	The lowest power in the spectrum at each frequency bin is retained from one acquisition to the next.
CHP Averaging Type		Specifies the averaging type for averaging spectral acquisitions. Default value: RMS
	RMS,	
	Log,	
	Scalar,	
	Max,	
	Min	

Table continued...

Setting	Available options	Description
SEM Averaging Type	RMS, Log, Scalar, Max, Min	Specifies the averaging type for averaging spectral acquisitions. Default value: RMS
OBW Averaging Type	RMS, Log, Scalar, Max, Min	Specifies the averaging type for averaging spectral acquisitions. Default value: RMS
PVT Averaging Type	RMS, Log	Specifies the averaging type for averaging spectral acquisitions. Default value: RMS
ModACC Averaging Type		Specifies the averaging type for averaging spectral acquisitions. Default value: Mean

Prefs Tab

The Prefs tab allows you to configure settings required to show/hide graticule, marker readouts and readouts.

The following image is of the Prefs tab available for the NR adjacent channel power, NR channel power, NR constellation, NR spectral emission mask, NR EVM, NR Occupied Bandwidth, and NR Power vs Time displays.

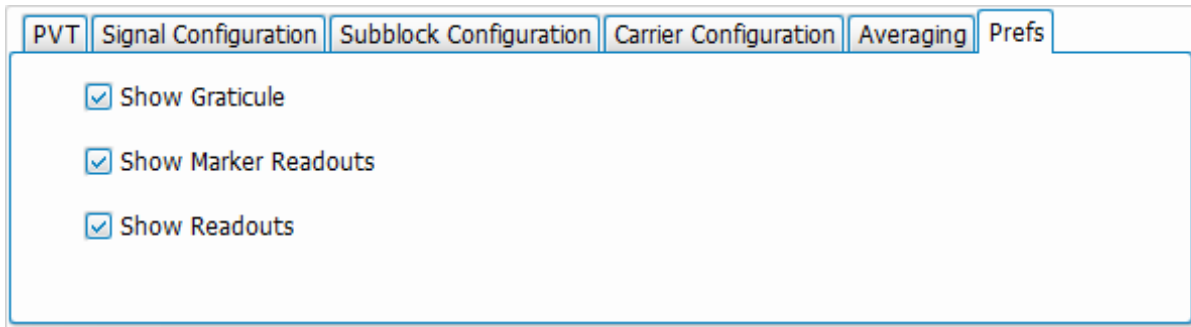

Setting	Available options	Description
Show Graticule		It controls the visibility of graticule in the plot.
Show Marker Readouts		It controls the visibility of marker readouts in the plot.
Show Readouts		It controls the visibility of readouts in the plot.

OBW Tab

The OBW tab allows you to configure the settings required for the occupied bandwidth measurement.

The following image shows the OBW tab for the NR Occupied Bandwidth display.

Setting	Available options	Description
Sweep Time		To manually specify the Sweep Time, uncheck Auto. Default Value: 1.000 ms
FFT Window	None Flat Top Hanning, Hamming, Gaussian, Blackman, Blackman-Harris, Kaiser-Bessel	Fast Fourier Transform (FFT) window type. Select to reduce the spectral leakage. Default Value: None
Measurement Bandwidth		Specifies the frequency range around the sub-block center frequency, which is used to find the sub-block occupied bandwidth. Default Value: 1.000 GHz
RBW		Displays the Resolution Bandwidth (RBW) for NR measurements. To manually specify the RBW, uncheck Auto. Default Value: 30 kHz
RBW Filter		Specifies the windowing method used for the transform. Default Value: FFT Based
	FFT Based	No RBW filtering is being performed.
	Gaussian	Specifies the RBW filter with a gaussian response.
	Flat	Specifies the RBW filter with a flat response.
Limit		To manually specify limit to check Pass/Fail condition of OBW measurement. If 'Auto' button checked OBW is compared if it is less than or equal to sub-block bandwidth of the signal. If 'Auto' button unchecked user can give limit to compare with OBW. Default Value: 100 MHz

PVT Tab

The PVT tab allows you to configure the settings required for the Power Vs Time measurement.

The following image shows the PVT tab for the NR Power Vs Time display.

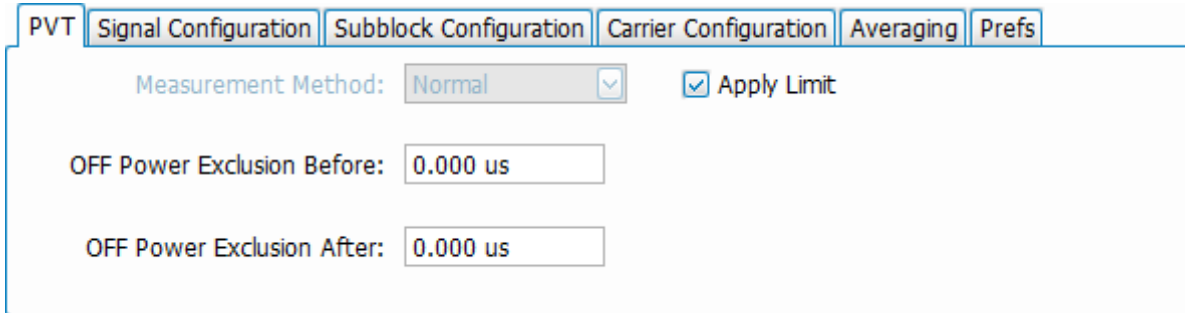

Setting	Available options	Description
Measurement Method		Specifies the measurement method. Default Value: Normal
Off Power Exclusion Before		Specifies the time excluded from the Off region before the burst. The value is expressed in seconds. Default value: 0.00 us
Off Power Exclusion After		Specifies the time excluded from the Off region after the burst. This value is expressed in seconds. Default value: 0.00 us
Apply Limit		IT enables pass/fail result and limit trace.

CHP Tab

The CHP tab allows you to configure the settings required for the channel power measurement.

The following image shows the CHP tab for the NR channel power display.

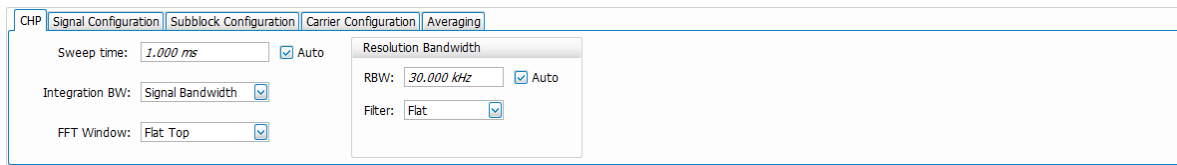

Setting	Available options	Description
Sweep Time		Specifies the sweep time or the total analysis time for the CHP measurement. To manually specify the sweep time, uncheck Auto. Default value: 1.000 ms

Table continued...

Setting	Available options	Description
Integration BW		Specifies the type of integration bandwidth to measure the power of the acquired signal. Default value: Signal Bandwidth
	Signal Bandwidth	Excludes the guard bands at the edges of the carrier or subblock.
	Channel bandwidth	Includes the guard bands at the edges of the carrier or subblock.
FFT Window		Fast Fourier Transform (FFT) window. Specifies the FFT window type. Default value: None
	None	No FFT window.
	Flat Top, Hanning, Hamming, Gaussian, Blackman, Blackman-Harris, Kaiser-Bessel	Select to reduce spectral leakage.
Resolution Bandwidth		
RBW		Displays the Resolution Bandwidth (RBW) for NR measurements. To manually specify the RBW, uncheck Auto. Default value: 30 kHz
Filter		Specifies the RBW filter method used for the transform. Default value: FFT Based
	Flat	Specifies the RBW filter with a flat response.
	FFT Based	No RBW filtering is being performed.
	Gaussian	Specifies the RBW filter with a gaussian response.

SEM Tab

The SEM tab allows you to configure the settings required for the spectral emission mask measurement.

The following image is of the SEM tab for the NR spectrum emission mask display.

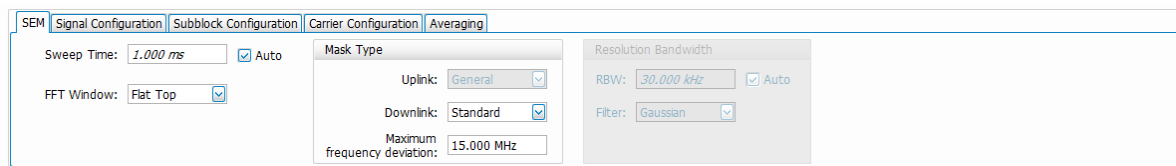

Setting	Available options	Description
Sweep Time		Specifies the sweep time or the total analysis time for the SEM measurement. To manually specify the sweep time, uncheck Auto. Default value: 1.000 ms

Table continued...

Setting	Available options	Description
FFT Window		Fast Fourier Transform (FFT) window. Specifies the FFT window type. Default value: None
	None	No FFT window.
	Flat Top, Hanning, Hamming, Gaussian, Blackman, Blackman-Harris, Kaiser-Bessel	Select to reduce spectral leakage.
Resolution Bandwidth		
RBW		Displays the Resolution Bandwidth (RBW) for SEM measurements. To manually specify the RBW, uncheck Auto. Default value: 30 kHz
Filter		Specifies the RBW filter method used for the transform. Default value: Gaussian
	Flat	Specifies the RBW filter with a flat response.
	FFT Based	No RBW filtering is being performed.
	Gaussian	Specifies the RBW filter with a gaussian response.
Mask Type		
Uplink		Specifies the spectrum emission mask used in the measurement when the link direction is uplink. Default value: General
	NS_35, NS_03, NS_04, NS_06, NS_21	Selection of the different SEM masks as defined in specifications for uplink.
	Custom	Define a custom SEM mask for uplink.
Downlink	Standard	Specifies the spectrum emission mask used in the measurement when the link direction is downlink. Default value: Standard
	Custom	Define a custom SEM mask for downlink.
Maximum frequency Deviation		Specifies the maximum frequency deviation of the offsets when the link direction is downlink and downlink mask type is set to standard. Default value: 15 MHz

Modulation Accuracy Tab

The Modulation Accuracy tab allows you to configure the settings needed to measure modulation accuracy. This tab contains important parameters related to OFDM symbol demodulation and EVM computation.

The following image shows the Modulation Accuracy tab for the NR constellation and NR EVM display.

Setting	Available options	Description
Measurement		
Unit	Slot	Specifies the units for measurement offset and measurement length. Slot: Length and offset are specified in units of slots. Default value: Slot
	Time	Measurement offset and measurement length are specified in seconds.
Length		Measurement length in units specified by the unit property. Default value: 1
Offset		Measurement offset to skip from the synchronization boundary. Default value: 0
FFT Window		
Type	Custom	Specifies FFT window type used for EVM calculation. The FFT window offset is used when set to custom, and the window length is set to 3GPP OFDM FFT size internally. Default value: Custom
	3GPP	The FFT window length is used when set to 3GPP, and the window offset is set as per 3GPP specs internally.
Length		Specifies the FFT window length as a percentage of cyclic prefix. This value is used when window type is set to 3GPP. To manually specify the length, uncheck Auto. Default value: 20
Offset		The starting position of the FFT window as a percentage of cyclic prefix is used to calculate the EVM when the FFT window type is set to custom. Default value: 50
Advanced		
Table continued...		

Setting	Available options	Description
Spectral Flatness	Normal	Specifies the test condition for spectral flatness measurement as per normal conditions in 3GPP Standard. Default value: Normal
	Extreme	Specifies the test condition for spectral flatness measurement as per extreme conditions in 3GPP Standard.
Phase Tracking		Enables or disables the phase tracking method.
DC Subcarrier Removal		Specifies whether the DC subcarrier is removed or not from the EVM results.
Spectrum Inverted		Specifies whether the spectrum of the signal should be inverted before analysis of modulation accuracy. This option can be utilized while analyzing down-converted IQ data.
Timing Tracking		Specifies whether to enable or disable timing tracking.
Composite Results		
EVM Units	dB	Specifies the units of EVM results. EVM is reported in dB. Default value: Percent
	Percent	EVM is reported in percentage.
Include DMRS		Specifies whether DMRS resource elements are included for composite EVM, magnitude and phase error results, and traces.
Include PTRS		Specifies whether PTRS resource elements are included for composite EVM, magnitude and phase error results, and traces.

Estimation Tab

The Estimation tab allows you to configure advanced modulation accuracy measurement estimation. It includes parameters needed to configure IQ impairments while using direct conversion architecture and timing related parameters.

The following image is of the Estimation tab for the NR constellation display.

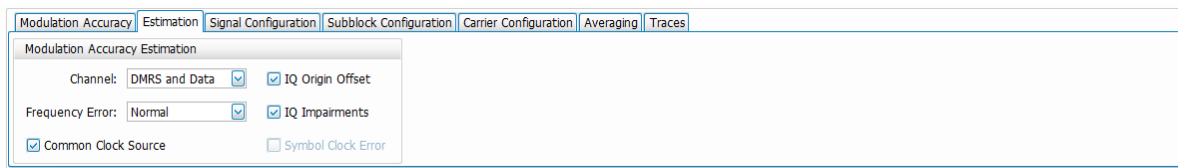

Setting	Available options	Description
Modulation Accuracy Estimation		
Channel	DMRS and Data	Select to improve the estimation of equalizer coefficients under high SNR conditions. Default value: DMRS and Data
	DMRS	Select to estimate the equalizer coefficients exclusively using DMRS symbols under any SNR condition.

Table continued...

Setting	Available options	Description
Frequency Error	Normal	Specifies the mode of carrier frequency error estimation. When normal is selected, the range of estimation is limited to +/- half the sub-carrier spacing. Default value: Normal
	Disable	Used to disable the estimation and correction of carrier frequency offset.
	Wide	When selected, frequency error estimation range is +/- half resource block when auto RB detection enabled is true, or range is +/- number of guard subcarrier when auto RB detection enabled is false.
Common Clock Source		Specifies whether the same reference clock is used for local oscillator and digital-to-analog converter. When the same reference clock is used, the carrier frequency offset is proportional to the sample clock error or/and digital-to-analog converter
IQ Origin Offset		Enables or disables estimation of IQ origin offset.
IQ Impairments		Enables or disables estimation of IQ gain and imbalance.
Symbol Clock Error		Enables or disables estimation of symbol clock error

Traces Tab

The Traces tab allows you to configure the display of constellation traces.

The following image is of the Traces tab for the NR constellation display.

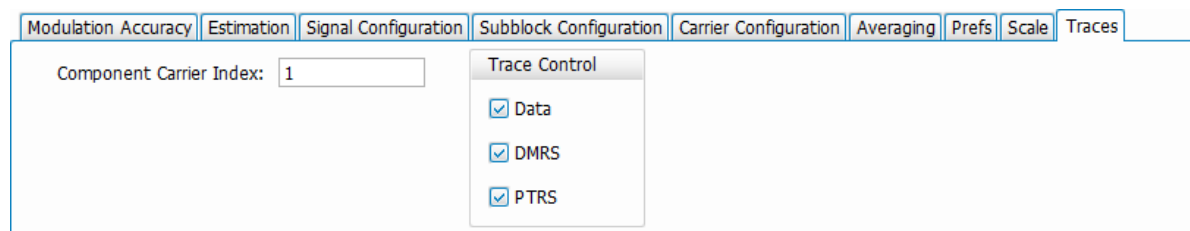

Setting	Available options	Description
Component Carrier Index	1, 2, 3, 4, 5, 6, 7, and 8	Select the component carrier index to display the component carriers demodulated data and DMRS. Also, the scalar results in the constellation display are modified accordingly. Default value: 1
Trace Control		
Data		Enables or disables plotting the constellation of data symbols.
DMRS		Enables or disables plotting the constellation of DMRS symbols.
PTRS		Enables or disables plotting the constellation of PTRS symbols.

Bluetooth Analysis

Overview

There are two Bluetooth Analysis options: Bluetooth (SV27) and Bluetooth 5 (SV31). These options allow you to evaluate short range RF signals to ensure that they meet Bluetooth standard per Bluetooth Special Interests Group (SIG) Test Specifications for version 5. This analysis option enables measurements and supports detection, demodulation, and decoding of packet information for the following three standards: Basic Rate, Low Energy (LE), and Enhanced Data Rate (EDR).

- Basic Rate with uncoded data at 1 Mb/s
- Low Energy (the following three variants are supported):
 - Low Energy 1M (LE 1M), with uncoded data at 1 Mb/s
 - Low Energy 2M (LE 2M), with uncoded data at 2 Mb/s (Requires Option SV31NL or SV31FL)
 - Low Energy Coded (LE Coded) with S=2 (500 Kb/s) or S=8 (125 Kb/s) (Requires Option SV31NL or SV31FL)
- Enhanced Data Rate (EDR) with 2 Mb/s or 3 Mb/s

You can also select from three RF test presets for the Low Energy standard and four test presets for the Basic Rate standard. This analysis option includes modulation, power, carrier drift, and spectral measurements as mentioned in the Radio Frequency test specification document by the Bluetooth SIG. These measurements are also compared with the limits provided by the standard to give pass/fail results. (There are no pass/fail results for EDR.)

With the Bluetooth Analysis test suite, test engineers can simplify the execution of a number of transmitter tests while still enabled to modify signal parameters for in-depth signal analysis. The analysis results give multiple views of Bluetooth signal characteristics to allow the diagnosis of signal imperfections and impairments quickly and easily. Display controls allow you to selectively display the analysis results to help locate trouble spots in the signal.

Bluetooth topics in this Help

The following information about Bluetooth Analysis is available:

- [Bluetooth key features](#) on page 604
- [Reference table of supported Bluetooth measurements](#)
- [Bluetooth measurements and test setups](#) on page 608
- [Bluetooth Status Messages](#) on page 612
- [Bluetooth Standards presets](#) on page 605
- [Bluetooth displays](#) on page 608
- [Bluetooth Analysis Measurement Settings](#) on page 636

Bluetooth key features

- Modulation/Carrier Drift/Output Power test setup in Bluetooth Standards Preset that will calculate results and compare against recommended or user defined limits or Basic Rate, LE 1M, LE 2M, and LE coded.
- In-band Emission measurement preset with capability to compare results against recommended or user defined limits for Basic Rate, LE 1M, LE 2M, and LE coded.
- 20 dB Bandwidth and Frequency Range measurement preset with capability to compare results against recommended or user defined limits for Basic Rate.
- Appropriate masks for Out-of-band Spurious measurements for ETSI and FCC specifications.
- Enhanced Data Rate (EDR) demodulation of GFSK and PSK data and relative power measurement preset.
- Automatic detection of standards

- Automatic detection of test pattern.
- Automatic determination of packet type.
- Summary display with decoded preamble, access code, packet header, payload header, and CRC packet information along with other scalar measurements.
- Symbol Table display with color coding to show different regions in the packet.
- Freq Dev vs Time display with zoomed Octet viewing to help you understand how the modulation characteristics measurement is done.
- CF Offset & Drift display with offset (calculated in preamble and 10 bit intervals in payload) and drift results in a tabular view.
- Summary display that allows you to edit pass/fail limits for comparison with actual results. (Default is recommended limits from the Bluetooth SIG Radio Frequency test specification document.)

Automatic detection of standards. This function can be enabled from the Standard Parameters control panel. This automatically detects whether the Bluetooth standard is Basic Rate, Low Energy, or Enhanced Data Rate (EDR). This function is not available as a test setup from the Standards Presets window.

Supported automated Bluetooth measurements

Bluetooth measurement	Bluetooth standard(s)
Modulation characteristics	Basic Rate LE 1M, LE 2M, LE coded
Carrier frequency offset and drift	Basic Rate LE 1M, LE 2M, LE coded
Output power	Basic Rate LE 1M, LE 2M, LE coded
In-band emission /ACPR	Basic Rate LE 1M, LE 2M, LE coded
Out-of-band spurious emission	Basic Rate LE 1M, LE 2M, LE coded
20 dB bandwidth	Basic Rate
Frequency range	Basic Rate
Power density	Basic Rate
Relative power	Enhanced Data Rate (EDR)

Bluetooth Standards presets

Presets > Standards

The Bluetooth Standards preset allows you to access displays preconfigured for the Bluetooth standard and test setup you select. The test setups load the displays and control setting options suggested by the standard to perform the measurements. You can read more about how Presets work [here](#).

There are four test setups for the LE 1M, LE 2M, and LE coded standard and eight test setups for the Basic Rate standard. There is one preset (no test setups) for the EDR standard.

The following table shows the set of Preset displays that load when the specified standards and test setups are selected.

Table 34: Bluetooth standards, test setups, and Preset displays

Standard	Test setup	Displays loaded with preset
LE 1M	Modulation/Frequency Offset/Drift/Output Power	BT Eye Diagram, BT Freq Dev vs Time, BT Summary, BT CF Offset and Drift, Spectrum, Time Overview
	In-band Emissions	BT InBand Emission, Spectrum, Time Overview
	Non-compliance	BT Freq Dev vs Time, BT Constellation, BT Summary, Spectrum, Spectrogram, Time Overview
LE 2M LE Coded (Requires Option SV31NL or SV31FL)	Modulation/Frequency Offset/Drift/Output Power	BT Eye Diagram, BT Freq Dev vs Time, BT Summary, BT CF Offset and Drift, Spectrum, Time Overview
	In-band Emissions	BT InBand Emission, Spectrum, Time Overview
	Non-compliance	BT Freq Dev vs Time, BT Constellation, BT Summary, Spectrum, Spectrogram, Time Overview
Basic Rate	Modulation/Frequency Offset/Drift/Output Power	BT Eye Diagram, BT Freq Dev vs Time, BT Summary, BT CF Offset and Drift, Spectrum, Time Overview
	In-band Emissions	BT InBand Emission, Spectrum, Time Overview
	Tx Output Spectrum — 20dB Bandwidth	Bluetooth 20 dB BW, Spectrum, Time Overview
	Non-compliance	BT Freq Dev vs Time, BT Constellation, BT Summary, Spectrum, Spectrogram, Time Overview
Enhanced Data Rate (EDR)	Generic	BT Eye Diagram, BT Constellation, BT Summary, BT Symbol Table, Spectrum, Time Overview

Retain current center frequency and reference level settings

The **Retain current Center Frequency setting** appears when the Bluetooth Standards Preset is chosen. This setting allows you to retain the previously used center frequency.

The **Retain current Ref Level setting** appears when the Bluetooth Standards Preset is chosen. This setting allows you to retain the previously used reference level.

To activate these settings, check the box next to the desired setting.

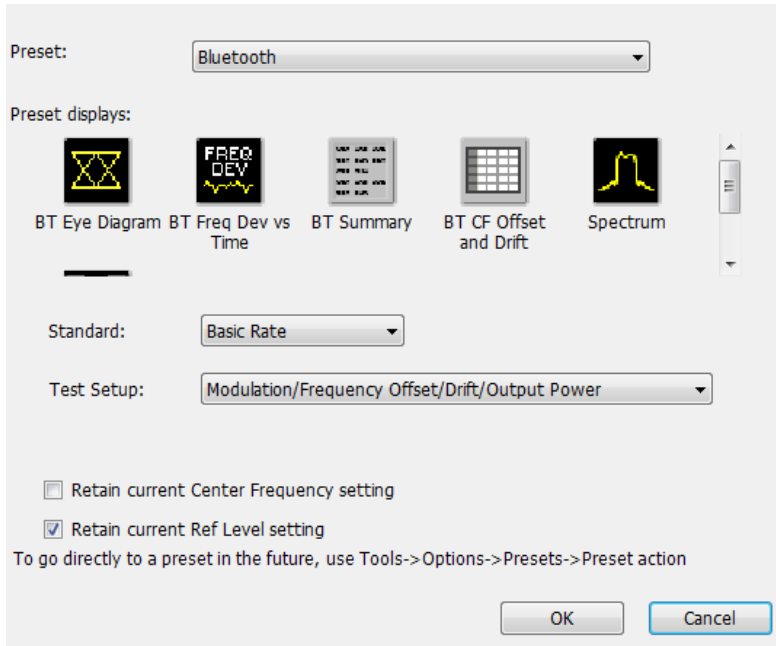

By default, the Ref Level setting box is checked.

By default, the Center Frequency setting box is unchecked and the Bluetooth preset displays will load with one of the center frequency values shown in the following table.

Table 35: Default center frequencies for Bluetooth test setups

Standard	Test setup	Center frequency
Basic Rate LE 1M LE 2M LE Coded	Modulation/Frequency Offset/Drift/Output Power	2.441 GHz
Basic Rate LE 1M LE 2M LE Coded	In-band Emissions	2.441 GHz
Basic Rate LE 1M LE 2M LE Coded	Out-of-band Spurious Emissions	2.441 GHz
Basic Rate	Tx Output Spectrum — 20dB Bandwidth	2.441 GHz
Basic Rate	Tx Output Spectrum — Power Density	2.441 GHz

Table continued...

Standard	Test setup	Center frequency
Basic Rate LE 1M LE 2M LE Coded	Non-compliance	2.441 GHz
Basic Rate	Tx Output Spectrum — Frequency Range Lower	2.402 GHz
Basic Rate	Tx Output Spectrum — Frequency Range Higher	2.480 GHz
Enhanced Data Rate	Generic	2.441 GHz



Note: Changing analysis and display parameters recalculates the measurement results, but does not affect acquisitions.

Bluetooth displays

The displays in Bluetooth Analysis (Setup > Displays > Measurements: Bluetooth Analysis) are:

- [Bluetooth 20dB Bandwidth display](#) on page 632
- [Bluetooth Carrier Frequency Offset and Drift display](#) on page 618
- [Bluetooth Constellation display](#) on page 613
- [Bluetooth Eye Diagram display](#) on page 615
- [Bluetooth Frequency Dev vs Time display](#) on page 629
- [Bluetooth InBand Emission display](#) on page 634
- [Bluetooth Summary display](#) on page 621
- [Bluetooth Symbol Table display](#) on page 625
- [Time Overview Display](#) on page 102

Bluetooth measurements and test setups

A variety of measurements and test setups are provided by the Bluetooth Analysis option for use in performance testing of transmitters. These test setups allow the analyzer to compare the measurement result to the standards limit. Test engineers can select from the test setups and measurements described here. The following topics contain important information you should know about specific Bluetooth measurements and test setups.



Note: Although the following information describes test setups for measurements recommended by the standard document, other measurement results may also be provided as additional information for a given measurement. For example, carrier frequency offset and drift results may be provided for modulation characteristics test setups.

Modulation characteristics (Basic Rate, LE 1M, LE 2M, LE Coded)

This measurement verifies that the modulation characteristics of the transmitted signal are correct. The Bluetooth test specification recommends this measurement be done using fixed frequency, also known as *hopping off*, and can be done in Direct Tx mode. This measurement can only be done if the payload has the bit pattern 10101010 or 11110000 for Basic Rate, LE 1M, and LE 2M; and 11001100 or 11110000 for LE Coded. This measurement and test setup are set to Free Run mode by default. However, you can set the analyzer to Triggered mode (Setup > Trigger) to do the measurements.

More information about this measurement:

- Select the Modulation/Frequency Offset/Drift/Output Power test setup from Presets > Standards to perform modulation characteristics measurements. This will load the displays found in the . Additionally, you can choose to load the BT Symbol Table and BT Constellation displays, which can provide useful information.
- The Bluetooth Analysis splits the frequency deviation results in the payload region into octets (8 bit intervals). If the payload pattern is 10101010 for LE 1M and LE 2M, and 11001100 for LE Coded, then the maximum frequency deviation is calculated in every bit interval within an octet and recorded as Δf_{max} . The Δf_{max} results are averaged to give Δf_{2avg} . The percentage of Δf_{max} values greater than recommended lower limit is also found.
- If the payload is 11110000, the average frequency deviation is found in 4 bit intervals (2, 3, 6 and 7) and the average of these values is calculated as Δf_{1avg} . The ratio of Δf_{2avg} and Δf_{1avg} is also found.
- BT Freq Dev vs Time display has an octet view (zoomed view of the 8 bit intervals in Payload) and also shows the bit intervals in which the Δf_{max} values are computed. The octet view option also allows you to see the regions in which the calculations are done.



Note: The octet view option is only available when Preamble is detected.

- Specify an octet to view by entering a value in the Octet # field in the BT Freq Dev vs Time display. This also shows the maximum number of octets used for analysis. The start and end point for every octet can be clearly seen using the octet view.
- In the Summary display, the scalar results (Δf_{1avg} , Δf_{2avg} , Ratio, Percentage of Δf_{max} values greater than a limit) averaged over the last 10 packets analyzed are shown along with the packet count. These averaged results can be compared against limits set in the Limits tab of the Settings control panel.
- The Points/symbol option in the Trace tab can be used to control how many samples per symbol should be used for computation of these measurements. The standard recommends 32 samples per symbol for Low Energy and 4 samples per symbol for Basic Rate. These are the default values provided for the respective standards in the Bluetooth Standards presets.

Carrier frequency offset and drift (Basic Rate, LE 1M, LE 2M, LE Coded)

This measurement verifies that the carrier frequency offset and carrier drift of the transmitted signal is within the specified limits for the specified standard. The Bluetooth test specification recommends this measurement be done using fixed frequency, also known as *hopping off*, and can be done in Direct Tx mode. This test can be done only if the payload contains 10101010 bit pattern. This measurement and test setup are set to Free Run mode by default. However, you can set the analyzer to Triggered mode (Setup > Trigger) to do the measurements.

More information about this measurement:

- Select the Modulation/Frequency Offset/Drift/Output Power test setup from Presets > Standards to perform carrier frequency offset and drift measurements. This will load the displays found in the [Table 34](#) on page 606. Additionally, you can choose to load the BT Symbol Table and BT Constellation displays, which can provide useful information.
- This measurement calculates the following:
 - Frequency offset in Preamble (initial Carrier Frequency Offset). Calculated in 8 bits for LE 1M (f_0), 16 bits for LE 2M (f_0) and 80 bits for LE Coded. For LE Coded the 80 bits preamble is split into five 16 bits parts (f_0 - f_4).
 - For LE Coded there is an option to select only first 8 bits of f_4 . (Selection available in Analysis Params). This will ensure that frequency offset computed in the interval f_4 is not biased.
 - Frequency offset in Payload (calculated in 10 bit intervals for LE 1M, 20 bits for LE 2M, and 16 bits for LE Coded in payload).
 - Drift (the difference in frequency offset calculated in Payload from that calculated in Preamble).
 - The drift is measured by taking the difference in frequency offset between two fixed intervals. For LE 1M, the interval length is 10 bits and the difference between intervals is 50 μ s (5 intervals away). For LE 2M, the interval length is 20 bits and the interval difference is 50 μ s (5 intervals away). For LE Coded, the interval length is 16 bits and f_{hs} interval difference is 48 μ s (3 intervals away).
- The BT CF Offset and Drift display shows all results in a table.
- The measurements shows the following scalar results:
 - Preamble frequency offset (initial carrier frequency offset).
 - Maximum frequency offset in Payload (along with the index number at which the offset is at maximum).

- Drift of frequency offset from Preamble to first 10 bit interval in Payload ($f_1 - f_0$).
- Maximum drift between Payload and Preamble ($f_n - f_0$) (along with index number at which the drift is maximum).
- Drift between two 10 and 20 bits intervals is denoted as $f_n - f_{n-5}$ for LE 1M and LE 2M. For LE Coded, it is denoted as $f_n - f_{n-3}$, which is 48 μ s away. The Maximum interval difference at which these values occur is shown in Frequency Drift display.
- The Preamble region in which the Preamble offset is calculated is shown in the BT Freq Dev vs Time display along with markings to show the region in which maximum drift occurred. Maximum drift between Payload and Preamble is shown from the end of Preamble to the end of 10 bit interval in Payload in which maximum drift occurred. Maximum drift in payload (in 50 μ s duration) is also shown.
- In the Summary display, the scalar results (mentioned above) averaged over the last 10 packets are shown along with the packet count. The results are compared against recommended limits. You can set these limits in the Limits tab of the Settings control panel.

In-band Emissions (Basic Rate, LE 1M, LE 2M, LE Coded)

This measurement verifies that the in-band spectral emissions are within limits. The standard document recommends that this measurement be done with Hopping off, finding the integrated power in 1 MHz band (with RBW 100 kHz) in 80 channels starting from 2401 MHz to 2481 MHz. The test can be done in Direct Tx mode. The integrated power values calculated in the adjacent channels are compared against recommended limits (except the three channels around transmitted frequency). This measurement is referred to as ACPR in the Radio Frequency Test Specification for Basic Rate. It is recommended to do this measurement in Free Run mode (set in Setup > Trigger) if the analyzer does not support the required BW (80 MHz). The measurement internally searches for burst and aligns the measurement to the on-slot region.



Note: For analyzers with limited bandwidth, this measurement will be done over multiple acquisitions to generate the data required for the entire span. Therefore, it is important for the user to set an analysis length that will ensure that on slot region is always included.

More information about this measurement:

- Select the In-band Emissions test setup from Presets > Standards to perform the in-band emissions measurements. This will load the displays found in the [Table 34](#) on page 606.
- The In-band Emissions display will set the Center Frequency to 2.441 GHz by default. When the Retain CF option is not enabled from Standards Presets, 80 bands (each of bandwidth 1 MHz) are analyzed and the integrated power is found (indicated by Blue lines in the plot).
- The integrated power is compared against limits for comparison (shown by white masks) in all bands except the three channels around the transmitted frequency. If any band fails, that band is shown in red color. If more than three channels fail to meet the recommended limits, a FAIL is shown in the top left corner of the display.
- The table below the plot shows the integrated power and also the limit for comparison.
- The limits for comparison are set to the values given by the standard by default, but you can manually set them from the Limits tab of the Settings control panel.
- This measurement is done only on the on slot region if a ramp-up and ramp-down portions are available. However, the measurement is done on the complete analysis region if a ramp up or ramp down is not available. It is recommended that a complete packet is included in the analysis region.
- When the analyzer does not support the 80 MHz bandwidth requirement, multiple acquisitions are taken in different bands and stitched together. This measurement is therefore best done in Free Run mode (set in Setup > Trigger) as Triggered mode might not find a proper edge in an acquisition taken for stitching purposes.

Output Power (Basic Rate, LE 1M, LE 2M, LE Coded)

This test verifies the maximum peak and average power emitted from the EUT. The standards document recommends this test be done for a PRBS payload pattern. Also, the measurement must be done over the duration of a burst starting at preamble position. The Bluetooth test specification recommends this measurement be done using fixed frequency, also known as *hopping off*, and can be done in Direct Tx mode.

More information about this measurement:

- Select the Modulation/Frequency Offset/Drift/Output Power test setup from Presets > Standards to perform carrier frequency offset and drift measurements. This will load the displays found in the [Table 34](#) on page 606.
- Calculates the average power and peak power for any Bluetooth signal. The peak power is the peak power value in the chosen on slot region.
- The measurement is done only on preamble detection; otherwise, it is invalid.
- The BT Summary display shows the averaged result over 10 packets.

20dB Bandwidth (Basic Rate)

This measurement verifies if the emissions inside the operating frequency range are within limits. This measurement is done with Hopping off. The difference between frequency points at which the power level drops to 20 dB below the peak power of the emission is found at 20 dB Bandwidth.

More information about this measurement:

- Select the 20dB Bandwidth test setup from Presets > Standards to perform the 20 dB emissions measurements. This will load the displays found in the [Table 34](#) on page 606.
- The BT 20 dB BW display allows you to set the relative power level (x dB BW) compared to the peak power at which the frequency points are to be found.
- When you select the 20dB Bandwidth test setup, the center frequency (CF), span, and relative bandwidth (RBW) are set as recommended by the standard document.
- It is recommended this measurement be done over three different center frequencies. You can do this by changing the center frequency as needed.
- From the Params tab of the Settings control panel, you can select that the search for the x dB relative power (20 dB in this case) be performed in one of two modes: from the edges towards the peak power (inwards) or vice versa (outwards). The default for this setting is Inwards (from edges to peak power) when this measurement is chosen from the Standards Preset menu, as recommended.
- The blue markings in the plot indicate the 20 dB bandwidth and the frequency points at which the power level drops down by 20 dB from the peak power.
- The resulting 20 dB bandwidth is compared with the limits recommended by the standard document and Pass/Fail is shown in the top left corner of the plot. This is not user defined.

If the highest power value measured in step d) is equal or higher than 0 dBm: $f = |fH - fL| \leq 1.0 \text{ MHz}$.

If the highest power value measured in step d) is lower than 0 dBm: $f = |fH - fL| \leq 1.5 \text{ MHz}$.

Frequency Range (Basic Rate)

These measurements verify if the emissions inside the operating frequency range are within limits. These measurements are done with Hopping off in two steps. The first measurement is done at the lower frequency spectrum of the Bluetooth band. (Start – 2399 MHz and Stop 2405 MHz). The second is done at the higher frequency spectrum of the Bluetooth band (Start -2475 MHz and Stop at 2485 MHz). The difference between the frequency point at which the power level drops to -30 dBm from the center frequency is measured. fL is the difference on the lower side from the center frequency when the lower end of the spectrum is being analyzed. fH is the difference from the center frequency on the higher side when the higher end of the spectrum is analyzed. fH – fL is the Frequency Range.

More information about these measurements:

- The BT 20dB BW display allows you to set the absolute power level (x dBm level) from the Parameters tab of the Settings control panel. The Bluetooth SIG Radio Frequency test specification document suggests that this value be set to -30 dBm for doing the Frequency Range measurement. If you chose to set up this measurement using start and stop frequencies and RBW, those should be set as recommended by the standard. Separate start and stop frequencies are given for the two steps of this measurement.
- You can select for the analysis to find the x dBm frequency difference from the center frequency either on the lower side, higher side, or both sides. This option (Meas Range) can be set from the Params tab of the Settings control panel.

- The blue marking indicates the frequency difference from the center frequency based on the Meas Range option choice. You can set this option to Low while analyzing in the lower range of the frequency spectrum, and set it to High when analyzing the higher range of the frequency spectrum.

Power Density (Basic Rate)

This measurement verifies the maximum RF output power density.

More information about this measurement:

- This measurement can be done using the Spectrum display (Displays > Measurements > General Signal Viewing) and by setting appropriate parameters as recommended in the Bluetooth SIG Radio Frequency test specification document.
- The Bluetooth test specification recommends this measurement be done using fixed frequency, also known as *hopping off*, and can be done in Direct Tx mode.

Out-of-band Spurious Emission (Basic Rate, LE 1M, LE 2M, LE Coded)

This measurement can be done for FCC or ETSI masks using the [Spurious](#) display.

Relative Power (Enhanced Data Rate)

This measurement calculates the relative power in the GFSK and PSK part of the Enhanced Data Rate (EDR) signal. This measurement is supported only when an EDR signal is detected.

Select the Enhanced Data Rate standard from Presets > Standards to perform the measurement. This will load the displays found in the [Table 34](#) on page 606.

Bluetooth Status Messages

The following status messages may appear. Each message indicates the related condition (Description) shown in the following table.

Status message	Description
Bluetooth Analysis: Preamble Not Detected	Shown in the display and status bar when no valid Sync and Preamble are found for the chosen standard. Also shown when no preamble is found for any of the standards in Automatic Standard Detection mode.
Bluetooth Analysis: LE 1M Sequence Detected	Shown in the status bar when the LE 1M standard is detected in Automatic Standard Detection mode.
Bluetooth Analysis: LE 2M Sequence Detected	Shown in the status bar when the LE 2M standard is detected in Automatic Standard Detection mode.
Bluetooth Analysis: LE Coded Sequence Detected	Shown in the status bar when the LE Coded standard is detected in Automatic Standard Detection mode.
Bluetooth Analysis: Basic Rate Sequence Detected	Shown in the status bar when the Basic Rate standard is detected in Automatic Standard Detection mode.
Bluetooth Analysis: EDR Signal Detected	Shown in the status bar when the EDR standard is detected in Automatic Standard Detection mode.
Bluetooth Analysis: EDR Sync Word Not Detected	Shown in the display and status bar when EDR Sync Word is not found (when EDR standard is selected).

Table continued...

Status message	Description
Bluetooth Analysis: Not enough payload data for Bluetooth measurements	Shown in the display and status bar when Preamble and Access Address/ Sync Word is detected but there is not enough payload data for Modulation Characteristics and CF Offset and Drift measurement.
Bluetooth Analysis: Meas BW may be too low	Shown in the InBand Emission display and in status bar when Measurement Bandwidth is too low.
Bluetooth Analysis: BT x dB BW detection failed	Shown in the BT 20 dB BW display when x dB measurement detection fails.
Bluetooth Analysis: BT x dBm BW detection failed	Shown in the BT 20 dB BW display when x dBm measurement detection fails.

Bluetooth Constellation display

The BT Constellation display shows a digitally modulated signal in constellation form. The constellation can be viewed either as IQ or Freq Dev. The default view is Freq Dev. The frequency deviation result that is shown in the Constellation display is compensated for the frequency error (shown as readout).

To show the BT Constellation display you can select **Presets > Standards > Bluetooth** or do the following:

1. If you are analyzing a stored data file, recall the data file now. Otherwise, go to the next step.
2. Press the **Displays** button or select **Setup > Displays**.
3. In the **Select Displays** window, select **Bluetooth Analysis** in the **Measurements** box.
4. In the Available displays box, double-click the **BT Constellation** icon or select the icon and click **Add**. The BT Constellation icon will appear in the **Selected displays** box and will no longer appear under Available displays.
5. Click the **OK** button to show the display.
6. Select **Setup > Settings** to display the control panel.
7. Select the **Standard Params** tab. Set the Standard, Power class (if required), and Measurement and Reference filters as appropriate for the input signal. You can also check the **Auto Detect Standard** box.
8. Select the **Trace** tab and set the **Trace Type** to Freq Dev or IQ, as required.
9. Select **Replay/Run** to take measurements on the acquired data.
10. If you are analyzing a data file, press the **Replay** button to take measurements on the recalled acquisition data file.

Elements of the Display

The following image shows the BT Constellation display of QPSK data in an EDR signal. Trace Type is set to IQ.

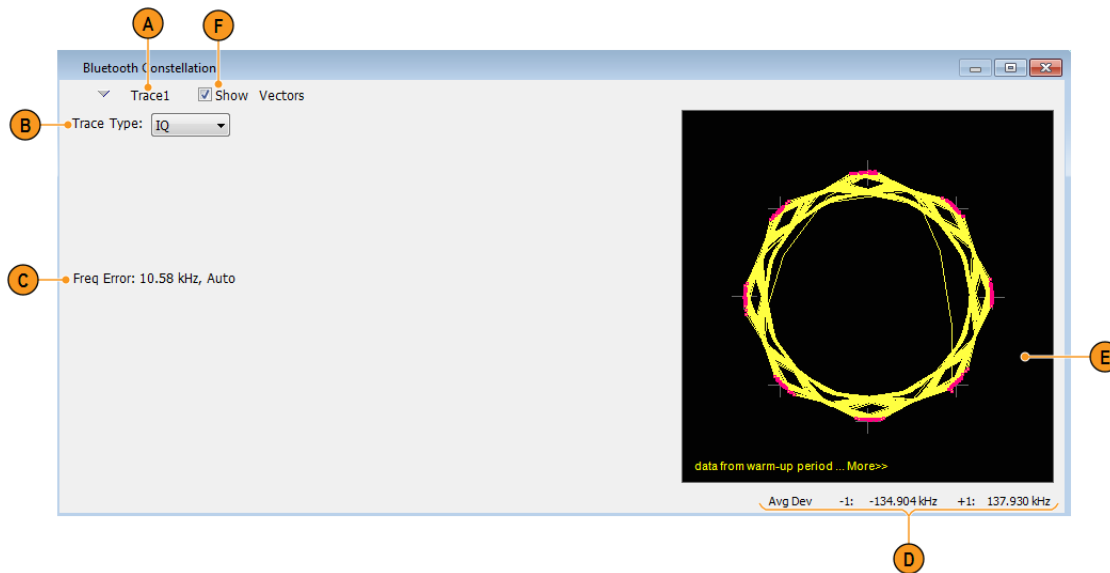

Item	Display element	Description
A	Trace	Select and enable a trace.
B	Trace Type	Specifies Trace type (choice between Freq Dev and IQ). This option appears only when EDR signal is detected.
C	Freq Error / Freq Offset / marker readouts	<p>The Freq Error, Freq Offset, and marker readout values appear here or below the plot, depending on the display view and size.</p> <p>The Freq Error value is the difference between the maximum and the minimum values of signal frequency during the measurement time. The Freq Error (Auto) value is displayed when the Auto check box is selected in the Analysis Params tab in the Settings control panel.</p> <p>The Freq Offset (Manual) value is displayed when the Auto check box is unselected in the Analysis Params tab in the Settings control panel.</p> <p>When markers are enabled, marker information (including time, magnitude, phase, symbol, and value) is displayed.</p>
D	Avg Dev	Shows the average deviation result at every symbol point.
E	Plot	Bluetooth constellation graph. Shown as either IQ or as Frequency Deviation. The trace type is controlled from the Settings > Trace tab.
F	Show Vectors	Specifies whether to show or hide the selected trace.

The following image shows the BT Constellation display of GFSK data in a Basic Rate signal. Trace Type is set to Freq Dev.

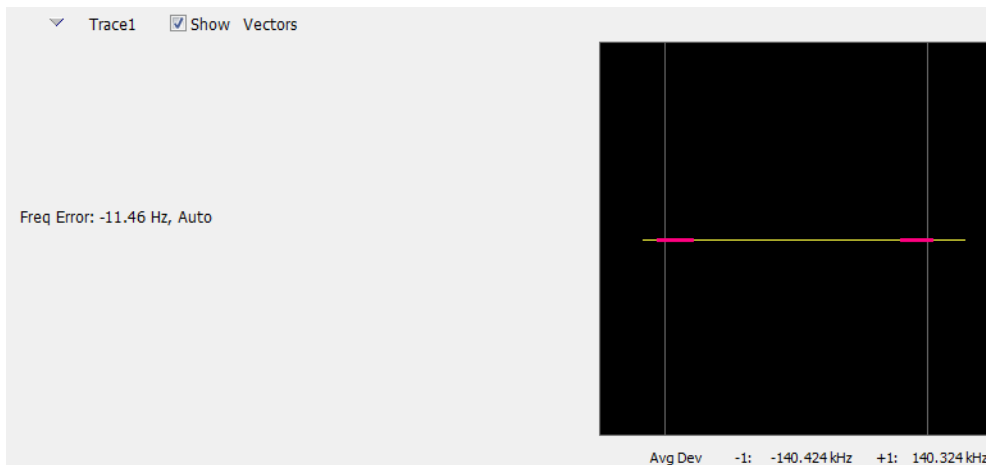

BT Constellation Settings

Main menu bar: Setup > Settings



The BT Constellation Settings control panel provides access to settings that control parameters of the Constellation Display.

Settings tab	Description
Standard Params	Select the standard, measurement filters, reference filters, and power class (when applicable). You can also set the analyzer to auto detect the standard.
Analysis Params	Specifies frequency error, frequency offset, measurement BW, and test patterns. You can also select to auto detect test patterns. These parameters are used by the instrument to analyze the input signal.
Analysis Time	Specifies parameters that define the portion of the acquisition record that is used for analysis. Also allows you to specify the Units (Symbols or Seconds) and Time Zero Reference (Trigger or Acquisition Start) for Bluetooth Analysis displays.
Traces	Allows you to select the trace to view, the trace type (IQ or Freq Dev), the number of points per symbol (when trace content is set to Vectors or Lines), and to show or freeze the selected trace.
Prefs	Allows you to select to show or hide the graticule and marker readouts.

Bluetooth Eye Diagram display

The BT Eye Diagram display shows a digitally modulated signal overlapped on itself to reveal variations in the signal.

To show the BT Eye Diagram display:

1. If you are analyzing a stored data file, recall the data file now. Otherwise, go to the next step.
2. Press the **Displays** button or select **Setup > Displays**.
3. From the **Measurements** box, select **Bluetooth Analysis**.

4. Double-click the **BT Eye Diagram** icon in the **Available Displays** box. This adds the BT Eye Diagram icon to the **Selected displays** box.
5. Click **OK** button. This displays the BT Eye Diagram view.
6. Select **Setup > Settings** to display the control panel.
7. Select the **Standard Params** tab. Set the Standard, Power class (when appropriate), and Measurement and Reference filters as appropriate for the input signal. You can also check the **Auto Detect Standard** box.
8. Select the **Trace** tab and set the **Trace Type** to Freq Dev or IQ, as required..
9. Select **Replay/Run** to take measurements on the acquired data.
10. If you are analyzing a data file, press the **Replay** button to take measurements on the recalled acquisition data file.

Elements of the Display

The following image shows the BT Eye display of a basic rate signal with Trace Type set to IQ.

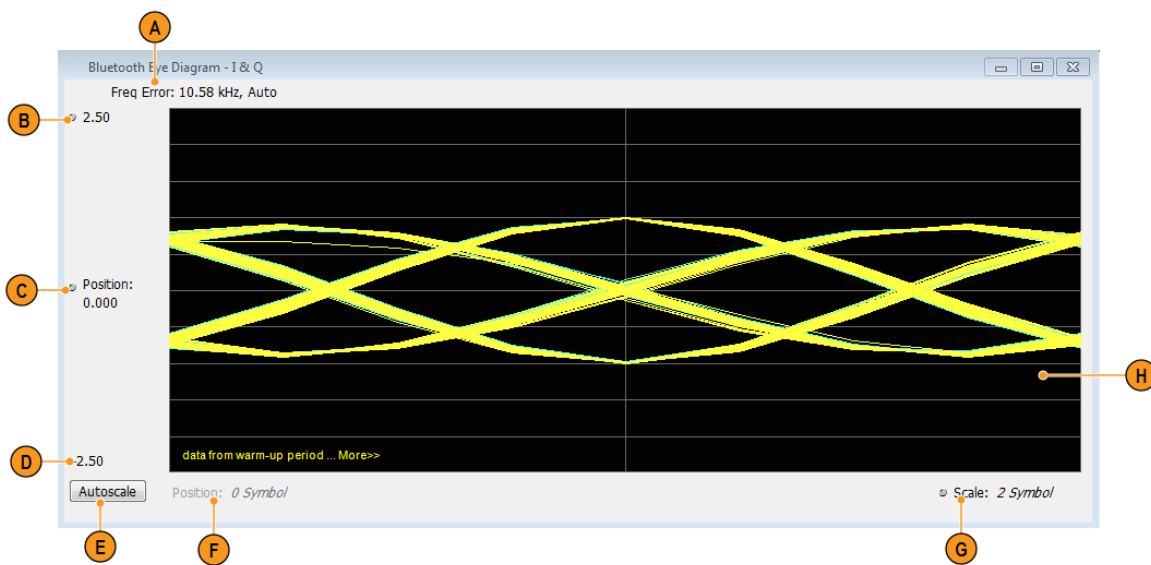

Item	Display element	Description
A	Freq Error / Freq Offset	The Freq Error value is the difference between the maximum and the minimum values of signal frequency during the measurement time. The Freq Error (Auto) value is displayed when the Auto check box is selected in the Analysis Params tab in the Settings control panel. The Freq Offset (Manual) value is displayed when the Auto check box is unselected in the Analysis Params tab in the Settings control panel.
B	Top of graph	The vertical scale is normalized with no units (for IQ) and with Hz (for Freq Dev).
C	Position	Specifies the value shown at the center of the graph display.
D	Bottom Readout	Displays the value indicated by the bottom of graph.
E	Autoscale	Adjusts the vertical and horizontal settings to provide the best display.

Table continued...

Item	Display element	Description
F	Position	Displays the horizontal position of the trace on the graph display.
G	Scale	Adjusts the span of the graph in symbols.
H	Plot	Displays the input signal.

The following image shows the BT Eye display of a Basic Rate signal with Trace Type set to Freq Dev.

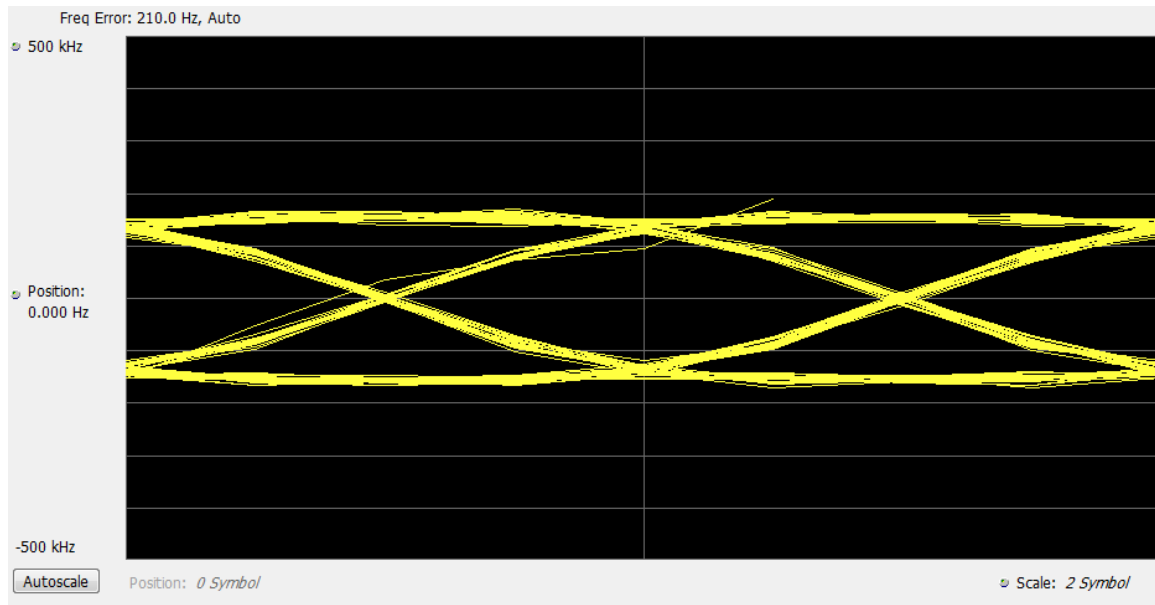

BT Eye Diagram Settings

Main menu bar: Setup > Settings



The settings for the BT Eye Diagram display are shown in the following table.



Note: You might save time configuring the BT Eye Diagram display by selecting the Standard Presets button in the Bluetooth Eye Diagram Settings control panel. This allows you to select a preset optimized for the selected standard.

Settings tab	Description
Standard Params	Select the standard, measurement filters, reference filters, and power class (when applicable). You can also set the analyzer to auto detect the standard.
Analysis Params	Specifies frequency error, frequency offset, measurement BW, and test patterns. You can also select to auto detect test patterns. These parameters are used by the instrument to analyze the input signal.

Table continued...

Settings tab	Description
Analysis Time	Specifies parameters that define the portion of the acquisition record that is used for analysis. Also allows you to specify the Units (Symbols or Seconds) and Time Zero Reference (Trigger or Acquisition Start) for Bluetooth Analysis displays.
Traces	Allows you to select the trace to view, the trace type (IQ or Freq Dev), the number of points per symbol (when trace content is set to Vectors or Lines), and to show the selected trace.
Scale	Allows you to specify the horizontal and vertical scale settings.
Prefs	Allows you to select to show or hide the graticule and marker readouts.

Bluetooth Carrier Frequency Offset and Drift display

The BT CF (Carrier Frequency) Offset and Drift display shows the frequency offset preamble, payload regions, and the drift result values are shown in this display. You can also view the values of frequency offset calculated in every ten bit interval in the payload and look for excursions.

To show the BT CF (Carrier Frequency) Offset and Drift display:

1. If you are analyzing a stored data file, recall the data file now. Otherwise, go to the next step.
2. Press the **Displays** button or select **Setup > Displays**.
3. In the **Select Displays** dialog, select **Bluetooth Analysis** in the **Measurements** box.
4. In the Available displays box, double-click the **BT CF Offset and Drift** icon or select the icon and click **Add**. The BT CF Offset and Drift icon will appear in the **Selected displays** box and will no longer appear under Available displays.
5. Click **OK** to show the display.
6. Select **Setup > Settings** to display the control panel.
7. Select the **Standard Params** tab. Set the Standard, Power class (when appropriate), and Measurement and Reference filters as appropriate for the input signal. You can also check the **Auto Detect Standard** box.
8. Select the **Limits** tab and set the limits, as required.
9. Select **Replay/Run** to take measurements on the acquired data.
10. If you are analyzing a data file, press the **Replay** button to take measurements on the recalled acquisition data file.

Elements of the Display

The following image shows the frequency offset and drift values of a basic rate (first image) and LE Coded signal in the BT Freq Offset and Drift display.

Interval#	Frequency offset (Hz)	Drift from f0 (Hz)	Drift - 50us (Hz)
	Limits fn (-150.0kHz to +150.0kHz)	Limits fn-f0 (-40.0kHz to +40.0kHz) f1-f0 (-20.0kHz to +20.0kHz)	Limits fn-f(n-5) (-20.0kHz to +20.0kHz)
▶ 0 (Preamble)	6434.094		
1	6422.583	-11.51074	
2	5296.85	-1137.244	
3	6478.38	44.28564	
4	6880.799	446.7051	
5	5173.156	-1260.938	
6	5455.798	-978.2959	-966.7852
7	5832.239	-601.855	535.3892
8	6631.489	197.395	153.1094
9	5221.211	-1212.883	-1659.588
10	4814.595	-1619.499	-358.5605
11	6111.346	-322.748	655.5479
12	6569.333	135.2388	737.0938
13	4871.332	-1562.763	-1760.158

Freq Offset Preamble: 6.434 kHz Drift f1-f0: -11.51 Hz Max Drift fn-f(n-5): 3.696 kHz @ 208
 Max Freq Offset (Payload): 7.826 kHz @ 131 Max Drift fn-f0: -4.080 kHz @ 115

Interval#	Frequency offset (Hz)	Drift from f0 (Hz)	Drift - 48us (Hz)
	Limits fn (-150.0kHz to +150.0kHz)	Limits fn-f0 (-50.0kHz to +50.0kHz)	Limits f0-f3 (-19.2kHz to +19.2kHz) f1-f4 (-19.2kHz to +19.2kHz) fn-f(n-3) (-19.2kHz to +19.2kHz)
▶ 0 (Preamble)	258.2126		
1 (Preamble)	-74.10534	-332.318	
2 (Preamble)	-289.2607	-547.4733	
3 (Preamble)	233.2176	-24.99501	24.99501
4 (Preamble)	15082.45	14824.24	-15156.55
5	-67.59009	-325.8027	
6	18.36853	-239.8441	
7	-228.1871	-486.3997	
8	-197.742	-455.9546	-130.1519
9	-47.53453	-305.7472	-65.90306
10	164.5431	-93.66956	392.7302
11	-333.5484	-591.7611	-135.8065
12	285.7397	27.5271	333.2743
13	-131.973	-390.1856	-296.5161
14	41.5774	-216.6353	375.1258
15	-388.7002	-646.9128	-674.4399
16	205.0563	-53.15637	337.0293
17	8.140196	-250.0724	-33.4372
18	-203.3326	-461.5452	185.3676
19	-213.4553	-471.668	-418.5116
20	63.34568	-194.867	55.20549
21	2.224886	-255.9878	205.5575

Freq Offset Preamble: 3.042 kHz Max Drift fn-f0: 14.82 kHz @ 4 Drift f1-f4: -15.157 kHz
 Max Freq Offset (Payload): 2.947 kHz @ 122 Drift f0-f3: 24.995 Hz Max Drift fn-f(n-3): -15.16 kHz @ 4

Display element	Description
Column 1	Indicates ten bit interval numbers. Zero indicates preamble region and the non-zero number indicate the ten bit intervals in payload.
Column 2	Shows the calculated frequency offset in the preamble and the ten bit intervals in the payload.
Column 3	Shows the drift of offset from the preamble and over a 50 μs for LE 1M, LE 2M and 48 μs for LE Coded duration.

Table continued...

Display element	Description
Column 4	Shows the drift of offset over a 50 μ s for LE 1M, LE 2M and 48 μ s for LE Coded duration.
—	Results that do not meet the limits are shown with a red colored background, indicating failure. (Limits can be set in the Limits tab from the Settings control panel.)
Scalar results	<p>The scalar results show below the table. They are as follows:</p> <p>Freq Offset Preamble</p> <p>Max Freq Offset (Payload)</p> <p>For LE 1M, LE 2M:</p> <p>Drift f_1-f_0</p> <p>Max Drift f_n-f</p> <p>Max Drift $f_n-f_{(n-5)}$</p> <p>For LE Coded:</p> <p>Drift f_0-f_3</p> <p>Max Drift f_1-f_4</p> <p>Max Drift $f_n-f_{(n-3)}$</p>

BT CF Offset and Drift Settings

Main menu bar: Setup > Settings



The settings for the BT CF Offset and Drift display are shown in the following table.

Settings tab	Description
Standard Params	Select the standard, measurement filters, and power class (when applicable). You can also set the analyzer to auto detect the standard.
Analysis Params	Specifies frequency error, frequency offset, measurement BW, and test patterns. You can also select to auto detect test patterns. These parameters are used by the instrument to analyze the input signal.
Analysis Time	Specifies parameters that define the portion of the acquisition record that is used for analysis. Also allows you to specify the Units (Symbols or Seconds) and Time Zero Reference (Trigger or Acquisition Start) for Bluetooth Analysis displays.
Limits	Allows you to load and define Bluetooth measurement limits for Pass/Fail comparison. You can save defined limits as a .csv file and also load previously saved .csv files. These limits also apply to the Settings control panel Limits tab of the BT Summary display.

Bluetooth Summary display

The BT Summary display shows a summary of all the scalar measurements done on the acquired test pattern. The summary display and contents will vary according to the selected standard.

Pass/Fail information is also provided in this display for all enabled scalar measurements. You can set limits and choose which measurement to compare for Pass/Fail from the Limits tab of the BT Summary Settings control panel. The default limits come from the performance recommendation limits given by the Standards document. The default limits can be reloaded by selecting the Bluetooth Standards Preset option.

The results presented in the BT Summary display include scalar results of modulation characteristics, frequency offset and drift and, output power measurements (these are averaged over the last 10 acquired packets). The display also shows packet related information for the current acquired packet.

To show the BT Summary display you can select **Presets > Standards > Bluetooth** or do the following:

1. If you are analyzing a stored data file, recall the data file now. Otherwise, go to the next step.
2. Press the **Displays** button or select **Setup > Displays**.
3. In the **Select Displays** dialog, select **Bluetooth Analysis** in the **Measurements** box.
4. In the Available displays box, double-click the **BT Summary** icon or select the icon and click **Add**. The BT Summary icon will appear in the **Selected displays** box and will no longer appear under Available displays.
5. Click **OK** to show the display.
6. Select **Setup > Settings** to display the control panel.
7. Select the **Standard Params** tab. Set the Standard, Power class (when appropriate), and Measurement and Reference filters as appropriate for the input signal. You can also check the **Auto Detect Standard** box.
8. Select the **Limits** tab and set the limits, as required.
9. Select **Replay/Run** to take measurements on the acquired data.
10. If you are analyzing a data file, press the **Replay** button to take measurements on the recalled acquisition data file.

Elements of the display

The following image shows all average scalar results and packet information for a Basic Rate signal in the BT Summary display. Modulation characteristics, carrier frequency offset and drift, and power measurements, along with packet information, are shown. The packet information will vary depending on the chosen or detected standard. For more information about specific measurement results, see the Bluetooth measurements and test setups section [here](#).

Standard: Basic Rate Class3 Clear

Modulation Characteristics [10 packet-average]	Packet Information
$\Delta F1_{avg}$ (00001111): -- Hz -- of 10 N/A	Packet Type: DH5
$\Delta F2_{avg}$ (10101010): 144.8 kHz	Preamble (4 bits): 0101
$\Delta F2_{Max\%} \geq 115$ kHz: 100.0 % 1 of 10 PASS	Sync Word (64 bits): 0x4F36F2CEE85390CB
$\Delta F2_{avg}/\Delta F1_{avg}$: -- N/A	Packet Header (18 bits)
Modulation Index: --	LT_ADDR (3 bits): 001
Frequency Offset and Drift [10 packet-average]	
Freq Offset (Preamble): 6.434 kHz PASS	Type (4 bits): 1111
Max Freq Offset: 7.826 kHz PASS	Flow (1 bit): 1
Drift f1-f0: -11.51 Hz PASS	ARQN (1 bit): 0
Max Drift fn-f0: -4.080 kHz PASS	SEQN (1 bit): 1
Max Drift fn-f(n-5): 3.696 kHz 1 of 10 PASS	HEC (8 bits): 00110001
Output Power [10 packet-average]	
Peak Power Ppk: -20.77 dBm PASS	PayLoad Length: 0101010011
Average Power Pavg: -21.04 dBm 1 of 10 PASS	CRC (16 bits): 0x273D

Element	Description
Standard	Display of the selected standard or the detected standard (if the Auto Detect Standard setting is chosen in the Standard Params tab of the Settings control panel).
Power class	Display of the Power class in the Standard Params tab of the Settings control panel. Only available when Basic Rate is the selected or detected standard.
Clear	Click button to reset measurement. Clears all values and all results in the queue used for average computation.
Modulation characteristics (ten packet average)	<p>Display of a group of scalar results related to Modulation Characteristics measurements. These scalar results are only populated in the BT Summary display if preamble is detected in the acquired data. The four scalar results are:</p> <p>$\Delta f1_{avg}$ is calculated when analyzed test pattern (payload) is 11110000.</p> <p>$\Delta f2_{avg}$ and the percentage of $\Delta f2_{max}$ value (greater than a given limit) are calculated only when analyzed test pattern (payload) is 10101010 for LE 1M and LE 2M, and 11001100 for LE Coded.</p> <p>The ratio of $\Delta f2_{avg}$ and $\Delta f1_{avg}$ is calculated provided both the results are available (or have been done before).</p> <p>All the results given are averaged over the last ten packets. The scalar results can be compared with pass/fail limits set in the Limits tab of the Settings control panel.</p> <p>More information can be found here.</p>
Modulation index	The Modulation index denotes if the transmitter of a BLE Packet is Stable or Standard. If it is Stable, the modulation index will be between 0.495 and 0.505. If it is Standard, the modulation index will be between 0.475 and 0.525. If neither of these conditions is satisfied, then no text is shown.

Table continued...

Element	Description
Frequency offset and drift (ten packet average)	<p>Display of a group of five scalar results related to the carrier frequency offset and drift measurement. These scalar results are only populated in the BT Summary display if preamble is detected and if the test pattern payload is a 10101010 pattern. All the results given are averaged over the last ten packets. The scalar results can be compared with pass/fail limits set in the Limits tab of the Settings control panel.</p> <p>The eight scalar results are:</p> <p>Preamble offset.</p> <p>Maximum offset in Payload (calculated over 10 bit intervals for LE 1M, 20 bit intervals for LE 2M, and 16 bit intervals for LE Coded).</p> <p>Drift (f_1-f_0)</p> <p>Max Drift (f_n-f_0).</p> <p>Max Drift (f_n-f_{n-5}) for LE 1M, LE 2M</p> <p>Drift (f_0-f_3)</p> <p>Max Drift (f_1-f_4)</p> <p>Max Drift (f_n-f_{n-3}) for LE Coded</p> <p>For more information about this measurement, see the Carrier frequency offset and drift (Basic Rate, LE 1M, LE 2M, LE Coded) on page 609 topic in <i>Bluetooth Measurements and test setups</i>.</p>
Output power	<p>Display of Average Power and Peak Power scalar results for Output Power. All the results given are averaged over the last ten packets. The scalar results can be compared with pass/fail limits set in the Limits tab of the Settings control panel.</p> <p>For Enhanced Data Rate signals, the relative power in GFSK and PSK regions is measured.</p> <p>For more information about this measurement, see the Output Power (Basic Rate, LE 1M, LE 2M, LE Coded) on page 610 topic in <i>Bluetooth Measurements and test setups</i>.</p>
Packet information	<p>The Packet information includes the Packet type, Preamble, Synchronization Word or Access Code, Packet Header, Payload length, and CRC details. The decoded bits are shown for the current analyzed packet.</p>

The following image shows all average scalar results and packet information for a LE 1M< LE 2M, and LE Coded signal in the BT Summary display.

Standard: LE 1M Clear

Modulation Characteristics [10 packet-average]		
ΔF1avg (00001111):	-- Hz	-- of 10 N/A
ΔF2avg (10101010):	229.1 kHz	
ΔF2Max% >= 185 kHz:	100.0 %	2 of 10 PASS
ΔF2avg/ΔF1avg:	--	N/A
Modulation Index:	--	

Frequency Offset and Drift [10 packet-average]		
Freq Offset (Preamble):	158.1 Hz	PASS
Max Freq Offset:	57.43 Hz	PASS
Drift f1-f0:	-100.7 Hz	PASS
Max Drift fn-f0:	-160.2 Hz	PASS
Max Drift fn-f(n-5):	-57.43 Hz	PASS
		2 of 10

Output Power [10 packet-average]		
Peak Power Ppk:	-29.51 dBm	FAIL
Average Power Pavg:	-30.00 dBm	FAIL
		2 of 10

Packet Information	
Packet Type	BLE_TEST
Preamble (8 bits)	01010101
Access Address (32 bits)	0x71764129
PDU Header (16 bits)	
Length (8 bits)	00100101
PDU Type (4 bits)	0010
ChSel (1 bit)	--
Tx Address (1 bit)	--
Rx Address (1 bit)	--
CRC (24 bits)	0x555555

The following image shows all average scalar results and packet information for an EDR signal in the BT Summary display.

Standard: EDR Clear

Modulation Characteristics [10 packet-average]		
ΔFavg:	-- Hz	0 of 10

Frequency Offset and Drift [10 packet-average]		
Freq Offset (Preamble):	-- Hz	N/A
Max FreqOffset:	-- Hz	
Drift f1-f0:	-- Hz	
Max Drift fn-f0:	-- Hz	
Max Drift fn-fn-s:	-- Hz	-- of 10 N/A

Output Power [10 packet-average]		
POWER GFSK:	-28.42 dBm	
POWER DPSK:	-28.51 dBm	1 of 10

Packet Information	
Packet Type	EDR_2DH1
Preamble (4 bits)	0101
Sync Word (64 bits)	0x4F36F2CEE85390CB
Packet Header (18 bits)	
LT_ADDR (3 bits)	001
Type (4 bits)	0100
Flow (1 bit)	1
ARQN (1 bit)	0
SEQN (1 bit)	1
HEC (8 bits)	11010111
PayLoad Length	110110
CRC (16 bits)	--

BT Summary Settings

Main menu bar: Setup > Settings



The settings for the BT Summary display are shown in the following table.

Settings tab	Description
<i>Standard Params</i>	Select the standard, measurement filters, reference filters, and power class (when applicable). You can also set the analyzer to auto detect the standard.
<i>Analysis Params</i>	Specifies frequency error, frequency offset, measurement BW, and test patterns. You can also select to auto detect test patterns. These parameters are used by the instrument to analyze the input signal.
<i>Analysis Time</i>	Specifies parameters that define the portion of the acquisition record that is used for analysis. Also allows you to specify the Units (Symbols or Seconds) and Time Zero Reference (Trigger or Acquisition Start) for Bluetooth Analysis displays.
<i>Limits</i>	Allows you to load and define Bluetooth measurement limits for Pass/Fail comparison. You can save defined limits as a .csv file and also load previously saved .csv files. The frequency offset and drift limits set here also apply to the CF Offset and Drift display.

Bluetooth Symbol Table display

The BT Symbol Table display shows decoded data values for each data symbol in the analyzed signal packet. It is like the BT Constellation display except that a text table is used to display data instead of a graph.

To show the BT Symbol Table display:

1. If you are analyzing a stored data file, recall the data file now. Otherwise, go to the next step.
2. Press the **Displays** button or select **Setup > Displays**.
3. In the **Select Displays** dialog, select **Bluetooth Analysis** in the **Measurements** box.
4. In the Available displays box, double-click the **BT Symbol Table** icon or select the icon and click **Add**. The BT Symbol Table icon will appear in the **Selected displays** box and will no longer appear under Available displays.
5. Click **OK** to show the display.
6. Select **Setup > Settings** to display the control panel.
7. Select the **Standard Params** tab. Set the Standard, Power class (when appropriate), and Measurement and Reference filters as appropriate for the input signal. You can also check the **Auto Detect Standard** box.
8. Select the **Limits** tab and set the limits, as required.
9. Select **Replay/Run** to take measurements on the acquired data.
10. If you are analyzing a data file, press the **Replay** button to take measurements on the recalled acquisition data file.

Regions of the Display

The BT Symbol Table is color coded to indicate different regions of the packet. The legend at the bottom of the symbol table lists the packet contents in their associated colors. The following image shows values for a Basic Rate signal.

0	1	0	1	0	1	1	0	1	0	0	1	1	0	0	0	0
16	1	0	0	1	1	1	0	0	1	0	1	0	0	0	0	1
32	0	1	1	1	0	1	1	1	0	0	1	1	0	1	0	0
48	1	1	1	1	0	1	1	0	1	1	0	0	1	1	1	1
64	0	0	1	0	0	0	0	0	0	0	0	0	0	1	1	1
80	1	1	1	1	1	1	1	1	1	1	1	1	1	1	1	0
96	0	0	1	1	1	0	0	0	0	0	0	0	0	0	1	1
112	1	1	1	1	0	0	0	0	0	0	1	1	1	1	1	0
128	0	1	0	1	0	1	0	0	0	0	1	1	1	1	0	0
144	0	0	1	1	1	1	0	0	0	0	1	1	1	1	0	0
160	0	0	1	1	1	1	0	0	0	0	1	1	1	1	0	0
176	0	0	1	1	1	1	0	0	0	0	1	1	1	1	0	0
192	0	0	1	1	1	1	0	0	0	0	1	1	1	1	0	0
208	0	0	1	1	1	1	0	0	0	0	1	1	1	1	0	0

Preamble
Synchronization/Access Address

Packet Header
Payload Header

Payload
MIC/CRC

Marker: Time: Symbol: Value:

Packet standard	Associated regions
Basic rate	4-bit preamble 64-bit access code 4-bit trailer 54-bit packet header 8- or 16-bit payload header based on packet type Variable length payload data 16-bit CRC (Cyclic Redundancy Check)
LE 1M	8-bit preamble 32-bit access address / synchronization word 16-bit payload header Variable length payload data (2–257 bytes) 24-bit CRC (Cyclic Redundancy Check)
LE 2M	8-bit preamble 32-bit access address / synchronization word 16-bit payload header Variable length payload data (32–257 bytes) 24-bit CRC (Cyclic Redundancy Check)

Table continued...

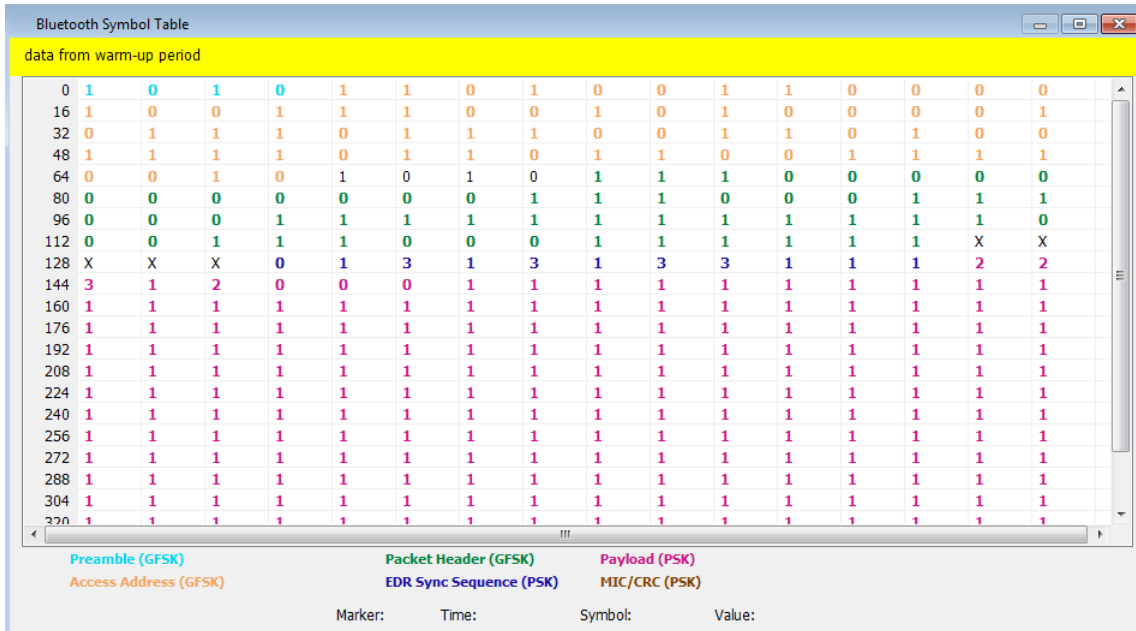

Markers and the BT Symbol Table. Markers are indicators in the display that you can position on a trace to measure values such as frequency, power, and time. A Marker always displays its position and, if the Delta Marker (M1-M4) readout is enabled, will display the difference between its position and that of the Marker Reference (MR). In the BT Symbol Table, colored cells indicate the location of markers. The selected Marker is highlighted with a light green background. All other markers are highlighted with a light gray background. In the BT Symbol Table, the marker readout below the table shows the marker location in time, symbol numbers and symbol value.

BT Symbol Table Settings

Main menu bar: Setup > Settings



The settings for the BT Symbol Table display are shown in the following table.

Settings tab	Description
Standard Params	Select the standard, measurement filters, reference filters, and power class (when applicable). You can also set the analyzer to auto detect the standard.
Analysis Params	Specifies frequency error, frequency offset, measurement BW, and test patterns. You can also select to auto detect test patterns. These parameters are used by the instrument to analyze the input signal.
Analysis Time	Specifies parameters that define the portion of the acquisition record that is used for analysis. Also allows you to specify the Units (Symbols or Seconds) and Time Zero Reference (Trigger or Acquisition Start) for Bluetooth Analysis displays.
Prefs	Allows you to select to show or hide the marker readouts and set the radix of shown symbols.

Bluetooth Frequency Dev vs Time display

The BT Freq Dev vs. Time display shows how the signal frequency varies with time.

To display the BT Freq Dev vs. Time display:

1. If you are analyzing a stored data file, recall the data file now. Otherwise, go to the next step.
2. Select the **Displays** button or **Setup > Displays**.
3. In the **Select Displays** dialog, select **Bluetooth Analysis** in the **Measurements** box.
4. In the **Available displays** box, double-click the **BT Freq Dev vs. Time** icon or select the icon and click **Add**. The BT Freq Dev vs. Time icon will appear in the **Selected displays** box and will no longer appear under Available displays.
5. Click **OK** to show the display.
6. Select the **Standard Params** tab. Set the Standard, Power class (when appropriate), and Measurement and Reference filters as appropriate for the input signal. You can also check the **Auto Detect Standard** box.
7. Select the **Trace** tab and set the **Content** to Vectors or Points, as required.
8. Select Replay/Run to take measurements on the acquired data.
9. If you are analyzing a data file, press the **Replay** button to take measurements on the recalled acquisition data file.

Elements of the Display

The following image shows the frequency deviation of the complete packet of a Basic Rate signal in the BT Freq Dev vs. Time display.

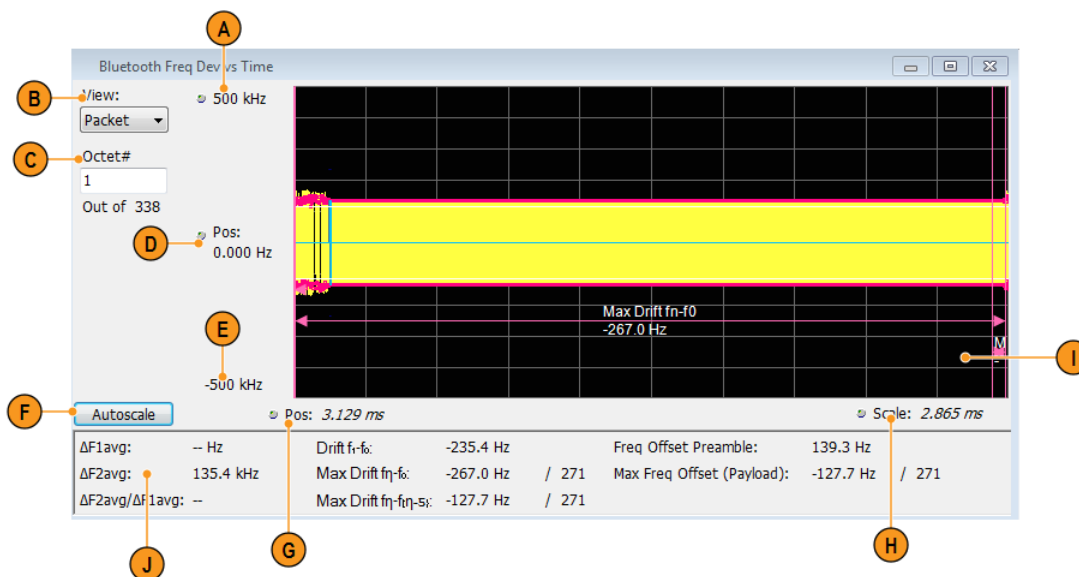

Item	Display element	Description
A	Top of graph	The vertical scale is normalized with Hz.

Table continued...

Item	Display element	Description
B	View	<p>(This option is visible only when Preamble is detected.)</p> <p>Select one of the following:</p> <p>Packet: view frequency deviation for an entire packet.</p> <p>Octet: view frequency deviation for a specified octet duration (8 μs). The Octet is specified in the Octet # field.</p>
C	Octet # (xx of total)	<p>(This option is visible only when Preamble is detected and Octet is selected as the View.)</p> <p>Specifies the Octet number. (The total number of octets is also indicated.) When View is set to Octet, you can enter a particular octet in the Octet # field for zoom view. The plot will show only 8 μs of information corresponding to the octet number chosen in the payload. The regions that are used for doing the exact measurements are highlighted in the Octet View. For F0F0 (Low Deviation) pattern in payload, bit intervals 2,3,6,7 regions are highlighted. For 10101010 LE 1M and LE 2M, and 11001100 for LE Coded (high deviation) pattern, all bit regions are highlighted with appropriate results. The offset calculated for every octet region (f1ccf or f2ccf) are also shown.</p>
D	Position (center)	Adjust the frequency shown at the center of the display.
F	Autoscale button	Adjusts the offset and range for both vertical and horizontal to provide the best display.
G	Position	Displays the horizontal position of the trace on the graph display.
H	Scale	Adjusts the horizontal scale (time).
I	Plot	Displays the last analyzed complete packet or the selected octet (Octet zoom view) of the signal. Markings are shown for Preamble offset and for Maximum Drift from preamble and Maximum Drift for 50 μ s.
J	Scalar results	<p>The Scalar results for Modulation Characteristics and Frequency Offset and Drift measurements are captured here. These results are from the last analyzed packet and therefore could be different from the Averaged Scalar results shown in the BT Summary display.</p> <p>For Drift results, the index is also shown where the maximum drift occurred. The Drift results are shown only when the preamble is detected and the test pattern payload detected is 10101010 for LE 1M and LE 2M, and 11001100 for LE Coded. ΔF_{1avg} or ΔF_{2avg} is shown only when the detected test pattern payload is (10101010) for LE 1M and LE 2M or (11001100) for LE Coded.</p>



Note: This display shows the frequency deviation results without compensating for the frequency error.

The following image shows the frequency deviation of the first octet in the payload of a Basic Rate signal (high deviation).

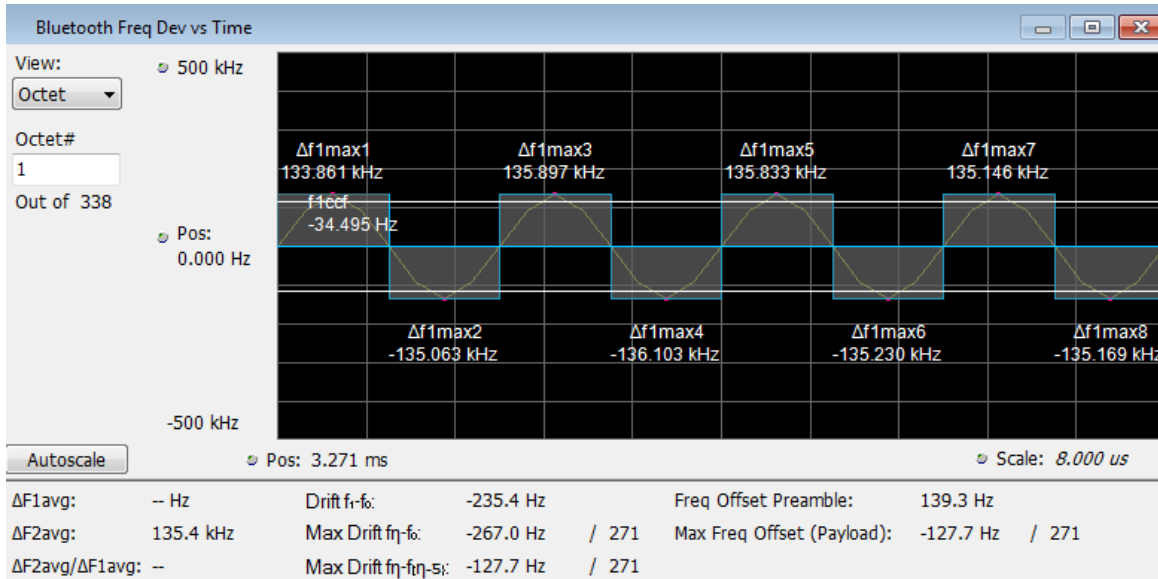

The following image shows the frequency deviation of the first octet in the payload of a Basic Rate signal (low deviation).

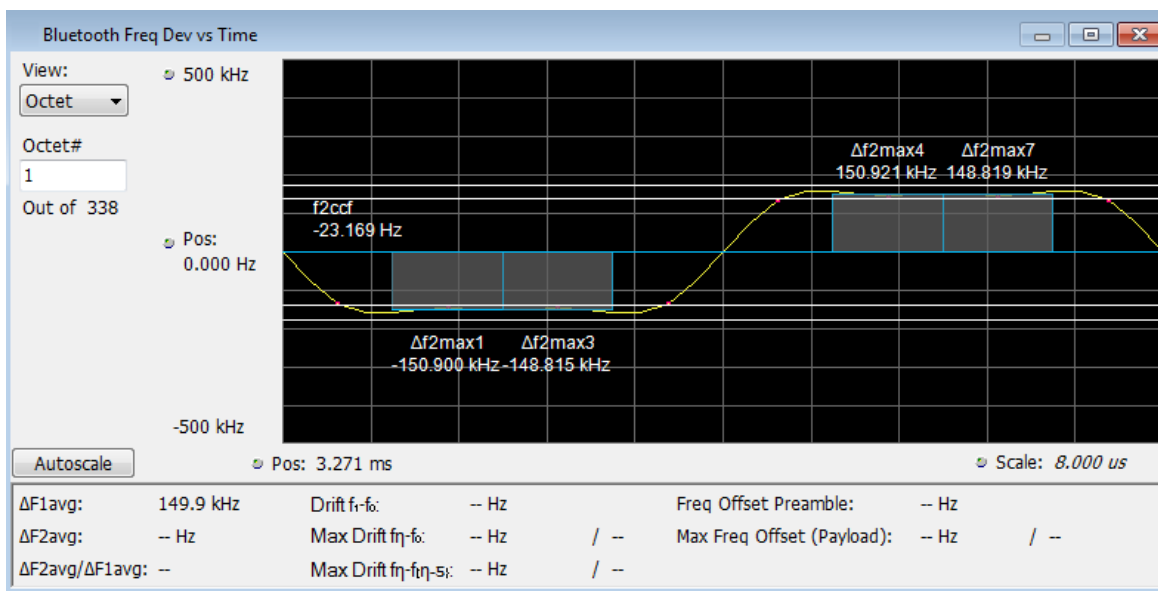

BT Frequency Dev Vs Time Settings

Main menu bar: Setup > Settings



The Setup settings for BT Freq Dev vs. Time are shown in the following table.

Settings tab	Description
Standard Params	Select the standard, measurement filters, reference filters, and power class (when applicable). You can also set the analyzer to auto detect the standard.
Analysis Params	Specifies frequency error, frequency offset, measurement BW, and test patterns. You can also select to auto detect test patterns. These parameters are used by the instrument to analyze the input signal.
Analysis Time	Specifies parameters that define the portion of the acquisition record that is used for analysis. Also allows you to specify the Units (Symbols or Seconds) and Time Zero Reference (Trigger or Acquisition Start) for Bluetooth Analysis displays.
Trace	Allows you to select the number of points per symbol, content, and to choose between entire packet view or zoom Octet view for a chosen octet number in a packet.
Scale	Allows you to specify the horizontal and vertical scale settings.
Prefs	Allows you to select to show or hide the graticule and marker readouts.

Bluetooth 20dB Bandwidth display

The BT 20dB BW display shows the results of two Bluetooth measurements: 20dB Bandwidth and Frequency Range. When the xdB BW is chosen, the display shows the x dB bandwidth from the peak power. More detailed information about this measurement is available [here](#).

To display the BT 20dB BW display:

1. If you are analyzing a stored data file, recall the data file now. Otherwise, go to the next step.
2. Select the **Displays** button or **Setup > Displays**.
3. In the **Select Displays** dialog, select **Bluetooth Analysis** in the **Measurements** box.
4. In the **Available displays** box, double-click the **BT 20dB BW** icon or select the icon and click **Add**. The BT 20dB BW icon will appear in the **Selected displays** box and will no longer appear under Available displays.
5. Click **OK** to show the display.
6. Select the **Standard Params** tab. Set the Standard, Power class (when appropriate), and Measurement and Reference filters as appropriate for the input signal. You can also check the **Auto Detect Standard** box.
7. Select the **Trace** tab and set the **Content** to Vectors or Points, as required.
8. Select Replay/Run to take measurements on the acquired data.
9. If you are analyzing a data file, press the **Replay** button to take measurements on the recalled acquisition data file.

Elements of the Display

The following image of the BT 20dB BW display shows a Basic Rate signal that would allow you to measure 20 dB bandwidth.

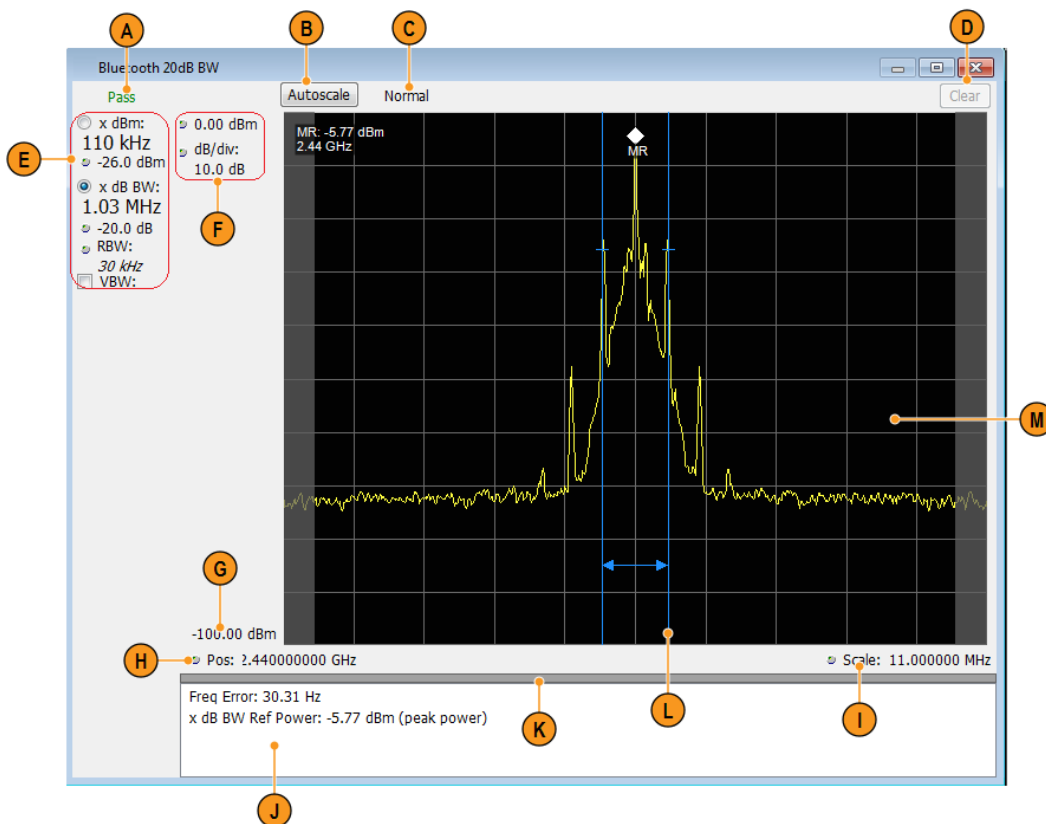

Item	Display element	Description
A	PASS / FAIL	Indicates Pass or Fail for the 20 dB BW measurement.
B	Autoscale	Adjusts the vertical and horizontal settings so that the entire trace fits in the graph.
C	Normal / MaxHold	Indicates whether the measurement is done with a MaxHold or a Normal condition.
D	Clear	Resets count for Average and MaxHold functions. Enabled only when Averaging or MaxHold is enabled. Pressing Clear will clear the trace and, if acquisition is running, restart the averaging or hold process.
E	Main results area	Shows the xdBm and xdB results. The requested dB or dBm value can be set in the controls below the result readout. Use the two radio buttons to select which of the two results are illustrated in the graph with the blue lines and arrows. RBW also can be set using the control. VBW enables the VBW (Video Bandwidth) filter. Displays current VBW filter setting. See Setup > Settings > Freq & RBW tab.
F	Position and dB/div Units (not shown) Fix. Slugger 2	Position sets the top of graph value. The dB/div setting is the vertical scale value. Set the global Amplitude units for all the views in the analysis window using the drop down menu that appears when you click on the box. This will change the amplitude selection in the Units tab of the Amplitude control panel.

Table continued...

Item	Display element	Description
G	Bottom readout	Displays the value indicated by the bottom of graph.
H	Position	Displays the horizontal position of the trace on the graph display.
I	Scale	Adjust the span of the graph in symbols.
J	Detailed results	<p>Displays the following additional measurements results:</p> <hr/> <p>Freq Error: The frequency difference between the measured carrier frequency of the signal and the user-selected center frequency of the analyzer.</p> <hr/> <p>x db BW Ref Power: The peak power measured within the measurement bandwidth.</p>
K	Grid divider	Determines the portion of the display allocated to the graph and detailed results area. You can move the grid divider all the way to the top or bottom and any position in between.
L	Blue lines	Indicates the measurement positions.
M	Plot	Displays the input signal. Shaded areas indicate the measurement bandwidth (Settings > Parameters tab > Measurement BW).

BT 20dB BW settings

Main menu bar: Setup > Settings



The Setup settings for BT 20dB BW are shown in the following table.

Settings tab	Description
<i>Freq & RBW</i>	Allows you to specify the frequency, resolution bandwidth (RBW), step, and VBW used for the MCPR measurements.
<i>Parameters</i>	Allows you to specify the x dB level, Measurement Direction, Measurement BW, xdBm level, xdBm Range, count, and to enable averaging and the Max Hold function.
<i>Scale</i>	Allows you to define the vertical and horizontal axes.
<i>Prefs</i>	Allows you to select show or hide the graticule and marker readouts.

Bluetooth InBand Emission display

The BT InBand Emission display verifies whether the emissions inside the operating frequency range are within limits. The power in adjacent channels of 1 MHz bandwidth around the frequency of transmission are calculated and compared against limits. The integrated power in the 1 MHz band for the adjacent channels is shown in a table below the plot.

Item	Display element	Description
D	Top of graph	The vertical scale is normalized with appropriate power units.
(not shown)	Units	Sets the global Amplitude units for all the views in the analysis window. This will change the amplitude selection in the Units tab of the Amplitude control panel.
E	dB/div	The vertical scale value.
F	Bottom readout	Displays the value indicated by the bottom of graph.
G	Autoscale	Adjusts the vertical and horizontal settings so that the entire trace fits in the graph.
H	Position	Displays the horizontal position of the trace on the graph display.
I	Scale	Adjust the span of the graph in symbols.
J	Plot	Divides the spectrum into different adjacent channels (each of 1 MHz bandwidth) as suggested in the standard document. You can select to show integrated power by checking the <i>Show power levels in graph</i> box in the Prefs tab in the Settings control panel). The integrated power level is shown in blue and the prescribed limits for comparison (set in the Limits tab of the Settings control panel) are shown in white. The region around the frequency of transmission is shown in a different color.
K	Results table	Reports the integrated power results (Channel frequency, Integrated power, and Limits) from the display in a table.

Bluetooth Analysis Measurement Settings

Main menu bar: Setup > Settings



The control panel tabs in this section are shared between the displays in Bluetooth Analysis (Setup > Displays). Some tabs are shared by all the displays, some tabs are shared by only a subset of displays. The settings available on some tabs change depending on the selected display.

Table 36: Common controls for Bluetooth Analysis displays

Settings tab	Description
Standard Params	Specifies the input signal standard and additional user-settable signal parameters.
Analysis Params	Specifies parameters used by the application to analyze the input signal.
Analysis Time	Specifies parameters that define the portion of the acquisition record that is used for analysis. Also allows you to specify the Units (Symbols or Seconds) for Bluetooth Analysis displays.

Table continued...

Settings tab	Description
Trace	Specifies the trace type (Vectors, Points, and Lines), the number of points per symbol when chosen to view as Vectors or Lines, and to control the view as Freq Dev or IQ.
Prefs	Allows preferences with Radix display and marker readouts.
Scale	Defines the vertical and horizontal axes.
Parameters	Specifies parameters used to analyze the signal.
Freq & RBW	Allows you to set Frequency and RBW settings for the BT 20 dB BW display.
Limits	Allows you to define limits for pass/fail comparison with calculated values. The default values are as recommended in the test specification.
Measurement Params	Allows you to set average (Time Domain, Off, or Frequency Domain) and to correct for noise floor.

Standard Params tab - BT

The Standard Params tab allows you to specify the standard, measurement and reference filters, power class (for some standards), and set standard auto detect.

The following image shows the tab for all of the Bluetooth displays except for the BT InBand Emission display. The Power Class menu only appears when Basic Rate is the selected standard.

The following image shows the tab for the BT InBand Emission display.

Settings	Description
Standard	Select the appropriate standard: Basic Rate, LE 1M, LE 2M, LE Coded, or Enhanced Data Rate.

Table continued...

Settings	Description
Auto Detect Standard	Check box to enable automatic detection of the Bluetooth standard (Basic Rate, Low Energy, or Enhanced Data Rate). A status message will appear indicating which of the three standards is detected and the result will show as Standard selection.
Measurement Filter	Specifies the filter used for measurement. The default filters for the Low Energy and Basic Rate standards are LE-Recommended and BR-Recommended, respectively.
Reference Filter	Specifies the filter used as a reference.
Power Class (only available for Basic Rate)	Select one out of three available power classes. This sets the default limits for comparison (set in the Limits tab of the Settings control panel) for Average and Peak power measurements.

Power class for the Basic Rate standard

The power class for Basic Rate is the reference receive power range as specified by the standard. It sets the default limits for comparison in the Limits tab of the control panel for Average and Peak power measurements. The power classes are specified as follows:

Class 1: max power 20 dBm (100 mW) with mandatory power control.

Class 2: max power 6 dBm (4 mW) with optional power control.

Class 3: max power 0 dBm (1 mW) with optional power control.

Recommended measurement and reference filters

The available measurement and reference filters depend on the selected standard. You can use the filters recommended by the standard (shown in following table) or load your own filters by selecting one of the User defined filters from a file.

The measurement filter is applied before the demodulation bit is detected and the ideal reference is calculated.

The reference filter is applied to the internally generated ideal reference signal.



CAUTION: Although there may be other filter types listed in the drop down menu, if you select any filter other than that which is recommended, the measurement results may not be accurate.

Standard	Measurement filters	Reference filters
Basic Rate	BR-Recommended	None
LE 1M	LE-Recommended	None
LE 2M	LE-Recommended	None
LE Coded	LE-Recommended	None
Enhanced Data Rate	BR-Recommended	None

How to select filters

In a signal transmitter/receiver system, the baseband signal might be filtered for bandwidth limiting or for another kind of necessary shaping that needs to be applied. Normally, a filter in the transmitter (Ft) and a filter in the receiver (Fr) are applied.

The Measurement Filter setting in the analyzer corresponds to the baseband filter in the receiver (Fr): This setting tells the analyzer what filter your receiver uses. When the analyzer is set to the same filter used by the receiver, the analyzer sees the signal as your receiver would. The Measurement Filter setting should be the same as the filter used in the receiver under normal operation (as opposed to testing).

Analysis Params tab - Bluetooth

The Analysis Params tab contains parameters that control the analysis of the input signal. The Test Patterns menu only appears when the Auto Detect Test Pattern is not checked. This tab is available for all displays except for the BT 20dB BW and the BT InBand Emission displays.

Settings	Description
Frequency Error	When the Auto box is checked, the analysis determines the Frequency Error and the measured Frequency Error is displayed. When the Auto box is unchecked, the entered value is used by the analysis as a fixed frequency offset. This is useful when the exact frequency offset of the signal is known.
Measurement BW	Specifies the bandwidth about the center frequency at which measurements are made. Select Manual, Auto, or Link to Span.
Auto Detect Test Pattern	When this box is checked, automatic detection of the test pattern is enabled. When this box is unchecked (Manual mode), automatic detection is disabled and you can select the test pattern and specify the Δf_{avg} for the other pattern for ratio computation.
Test Pattern	Allows you to select the test pattern to be analyzed. This choice is available only when Auto Detect Test Pattern is disabled.
Use 8 bits for f4 preamble interval	This option allows you to select only the first 8 bits of f4 for LE Coded. This ensures that the frequency offset computed in the interval f4 is not biased.

Analysis Time tab - Bluetooth

The Analysis Time tab contains parameters that define how the signal is analyzed in the Bluetooth Analysis displays. This tab is available for all displays except for the BT 20dB BW and the BT InBand Emission displays.

Standard Params	Analysis Params	Analysis Time	Trace	Prefs
Analysis Offset: <input type="text" value="0.000 s"/> <input checked="" type="checkbox"/> Auto Time Zero Reference: <input type="text" value="Trigger"/>				
Analysis Length: <input type="text" value="3.500 ms"/> <input type="checkbox"/> Auto Units: <input type="text" value="Seconds"/>				
Available: 0.000 s				

Settings	Description
Analysis Offset	Specifies the location of the first time sample to use in measurements.
Auto	When enabled, causes the instrument to set the Analysis Offset value based on the requirements of the selected display.
Analysis Length	Specifies the length of the analysis period to use in measurements. Length is specified in either symbols or seconds, depending on the Units setting.
Auto	When enabled, causes the instrument to set the Analysis Length value based on the requirements of the selected display.
Available	This is a displayed value, not a setting. It is the Analysis Length (time or symbols) being used by the analyzer. This value may not match the Analysis Length requested (in manual mode).
Time Zero Reference	Specifies the zero point for the analysis time.
Units	Specifies the units of the Analysis Length to either Symbols or Seconds.

Analysis Offset

Use analysis offset to specify where measurements begin. Be aware that you cannot set the Analysis Offset outside the range of time covered by the current acquisition data. (All time values are relative to the Time Zero Reference.)

You can set the Analysis Length so that the requested analysis period falls partly or entirely outside the current range of acquisition data settings. When the next acquisition is taken, its Acquisition Length will be increased to cover the new Analysis Length, as long as the Sampling controls are set to Auto. If the Sampling parameters are set to manual, or if the instrument is analyzing saved data, the actual analysis length will be constrained by the available data length, but in most cases, measurements are able to be made anyway. The instrument will display a notification when measurement results are computed from less data than requested. Range: 0 to [(end of acquisition) - Analysis Length]. Resolution: 1 effective sample (or symbol).

Analysis Length

Use the analysis length to specify how long a period of time is analyzed. As you adjust this value, the actual amount of time for Analysis Length, in Symbol or Seconds units, is shown below the control in the "Available" readout. This setting is not available when Auto is checked. Range: minimum value depends on the standard. Resolution: 1 symbol.

Time Zero Reference

All time values are measured from this point (such as marker position or horizontal position (in Y vs Time displays). Choices are: Acquisition Start or Trigger.

Parameter	Description
Acquisition Start	Time zero starts from the point at which the acquisition begins.
Trigger	Time zero starts from the trigger point.

Limits tab - Bluetooth

This tab is only available for the BT CF Offset and Drift, BT InBand Emission, and BT Summary displays. It enables you to load an existing limits table, save a limits table, or edit limits values. The content under Measurement Name varies based on the chosen standard and power class.

Some measurements are done only when a specific test pattern is detected. If the specific pattern is not detected, then N/A appears in blue in the BT Summary display because the measurement is not done. If the measurement is done, Pass or Fail is shown in the BT Summary display.

The following image shows the Limits tab for the BT CF Offset and Drift and BT Summary displays.

On	Measurement Name	Limit
<input checked="" type="checkbox"/>	BDR_DeltaF1Avg_Max	175.0 kHz
<input checked="" type="checkbox"/>	BDR_DeltaF1Avg_Min	140.0 kHz
<input checked="" type="checkbox"/>	BDR_DeltaFResult	115.0 kHz
<input checked="" type="checkbox"/>	BDR_DeltaFPercent	99.00 Percent
<input checked="" type="checkbox"/>	F2F1AvgRatio	0.8000
<input checked="" type="checkbox"/>	BDR_FreqOffsetPreamble	150.0 kHz

The following image shows the Limits tab for the BT InBand Emission display.

Standard Params	Freq & RBW	Measurement Params	Scale	Prefs	Limits
FTX +/- 2 MHz Limit : <input type="text" value="-20.0 dBm"/>					
FTX +/- [3+n] MHz Limit: <input type="text" value="-40.0 dBm"/>					

Settings	Description
Load	Click to load a saved Limits table from a .csv file.
Save	Click to save the current Limits table to a .csv file.

Edit limits

To directly edit measurement limits in the table, click on the value in the Limit column that you want to change. The following table describes the parameters that are set in the Limits Table.

Settings	Description
On	Click on the cell in the On column next to the measurement to specify whether or not measurements are selected for limit comparison to indicate Pass or Fail. A check mark means the measurement will be taken. An empty box means it will not be taken.
Measurement Name	Specifies the name of the measurement related to the limit. (Not editable.) The content under Measurement Name varies based on the chosen standard and power class.
Limit	Specifies the value of the limit to the related measurement. When the cell is selected, the value is shown along with the units.

Scale tab - Bluetooth

The Scale tab allows you to change the scale settings that control how the trace appears on the display but does not change control settings such as Measurement Frequency. In effect, these controls operate like pan and zoom controls. The Scale tab values are unique to each display. Also, note that each display uses horizontal and vertical units that are appropriate for that display. There are three versions of the Scale tab for Bluetooth displays.

The following image shows the Scale tab for the BT 20dB BW and BT InBand Emission displays.

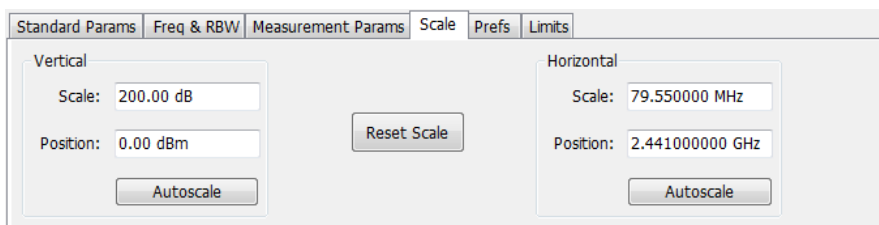

The following image shows the Scale tab for the BT Eye Diagram display.

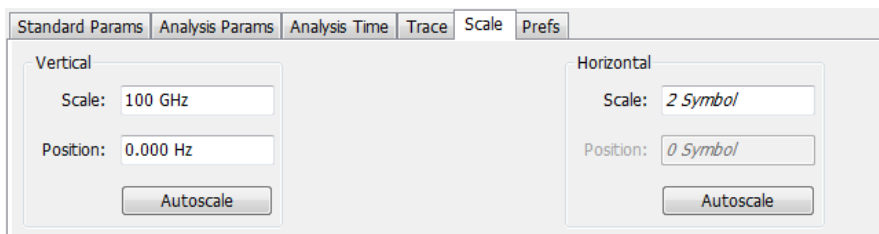

The following image shows the Scale tab for the BT Freq Dev vs Time display.

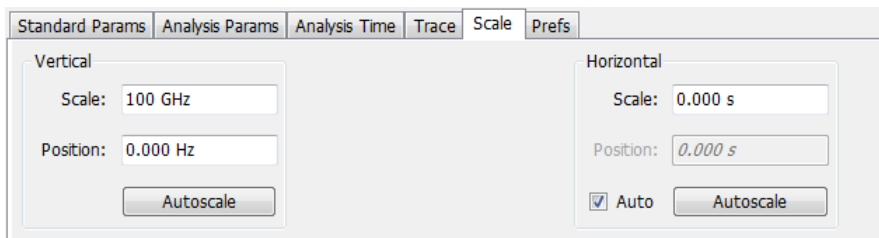

Settings	Description
Vertical	Controls the vertical position and scale of the trace display.
Scale	Changes the vertical scale of the graph.
Position	Adjusts the reference level away from top of the graph.
Autoscale	Resets the scale of the vertical axis to contain the complete trace.
Horizontal	Controls the horizontal span of the trace display and position of the trace.
Scale	Allows you to, in effect, change the horizontal span.
Position	Allows you to pan a zoomed trace without changing the frequency.
Autoscale	Resets the scale of the horizontal axis to contain the complete trace.
Auto	When Auto is checked, the scale and position values for the Symbols graph are automatically adjusted to maintain the optimal display.
Reset Scale	Resets all settings to their default values.



Note: The Units used for the horizontal scale for the BT Freq Dev vs Time display can be either Seconds or Symbols. To set the units for the horizontal scale, display the Analysis Time tab. On the tab, select the appropriate units from the Units drop-down list.

Traces tab - Bluetooth

The Traces tab allows you to set the trace display characteristics of the BT Constellation, BT Eye Diagram, and BT Freq Dev vs Time displays. The selections vary depending on the selected display.

The following image shows the tab for the BT Constellation display.

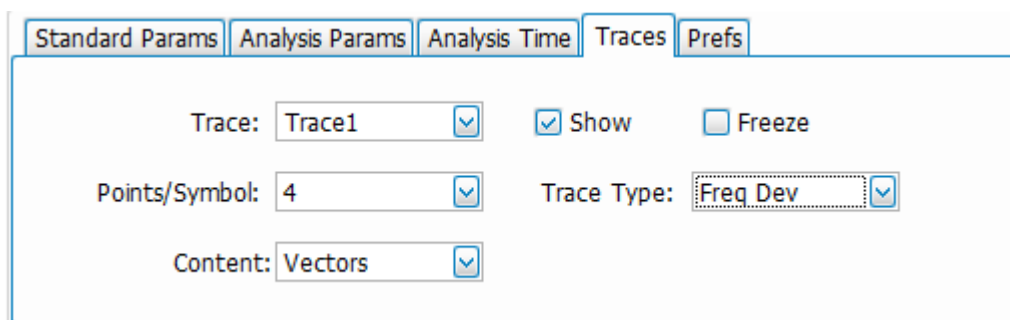

The following image shows the tab for the BT Eye Diagram display.

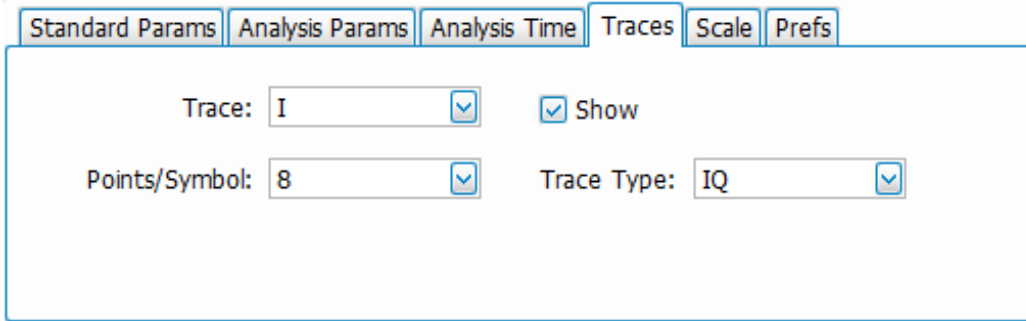

The following image shows the tab for the BT Freq Dev vs Time display.

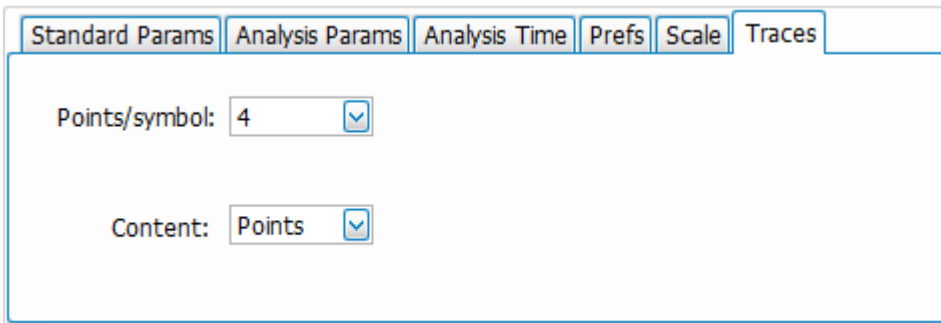

Setting	Description
Trace	Select the trace to display.
Show	Shows / hides the selected by trace.
Freeze	Halts updates to the selected trace.
Points/Symbol	Select how many points to use between symbols when connecting the dots. Values: 1, 2, 4, 8, 16, and 32.
Content	Select whether to display the trace as vectors (points connected by lines), points (symbols only without lines), or lines (lines drawn between symbols, but no symbols are displayed). The choices available depend on the display.
Trace Type	Select to specify whether the plot is shown as IQ or as Frequency Deviation.
View	Allows you to see the full packet or only the chosen Octet.
Octet # (of xx)	Allows you to view the specified octet. You can also select from the list of the available number of Payload octets in the packet.

Comparing two traces in the BT Constellation display

You can use the Traces tab to enable the display of a second trace. The second trace is a version of the current acquisition. You can choose to freeze a trace in order to display the current live trace to an earlier version of itself, you can display the trace as a second trace, or you can choose to display both traces frozen in order to compare the trace to itself at different times.

To display a second trace in the BT Constellation display:

1. If more than one display is present, select the BT Constellation display to ensure it is the selected display.
2. Click .
3. Select the Trace tab.
4. Select Trace 2 from the Trace drop-down list.
5. Click the Show check box so that it is checked.
6. Specify the Content as desired.

The Trace 2 lines will appear in blue to help you distinguish Trace 2 from Trace 1.

Prefs tab - Bluetooth

The Prefs tab enables you to change appearance characteristics of some of the Bluetooth Analysis displays.

The following image shows the Prefs tab for the BT 20dB BW, BT Freq Dev vs Time, BT Eye Diagram, and BT Constellation displays.

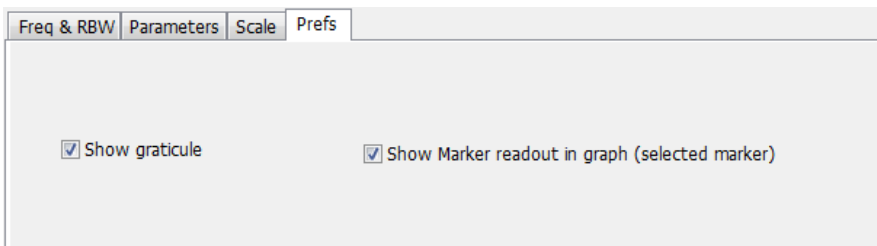

The following image shows the Prefs tab for the BT InBand Emission display.

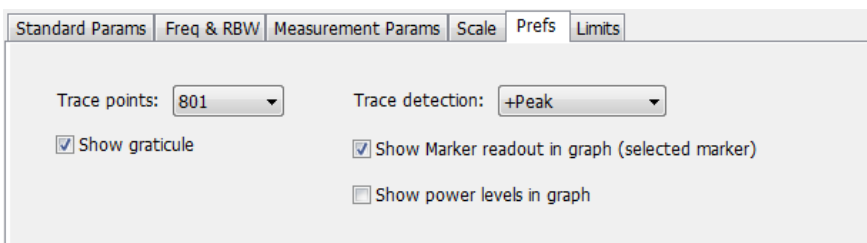

The following image shows the Prefs tab for the BT Symbol Table display.

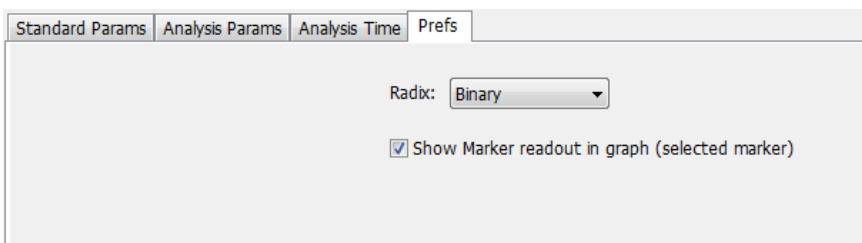

Setting	Description
Show graticule	Shows or hides the graticule.
Show Marker readout in graph (selected marker)	Shows or hides the readout for the selected marker in the graph area.

Table continued...

Setting	Description
Radix	Specifies how symbols are displayed in the Symbol Table display and in the Marker readout in the display. There are three choices for Radix: Binary (0,1) and Modulation Symbols (+1,-1). When EDR is detected, the symbol table will always show results in Hex for the PSK region (after guard).
Trace detection	<p>+Peak: Shows the peak power in a bin (of chosen RBW) if there are multiple points to choose from within a bin.</p> <p>Avg (VRMS): Shows the average power in a bin (of chosen RBW) if there are multiple points to choose from within a bin.</p>
Show power levels graph	Displays the calculated power levels in graph in each band.

Parameters tab - Bluetooth

The Parameters tab enables you to specify several parameters that control signal acquisition in the BT 20dB BW display.

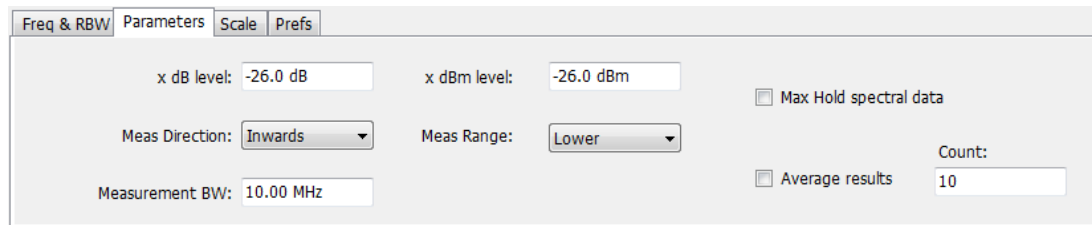

Setting	Description
x dB level	x dB level defines the x dB BW level search threshold.
Meas Direction	Specifies which way the search for the x dB level is done. Selecting Inwards directs the search for x dB from the edges towards maximum power. Selecting Outwards directs the search for x dB from maximum power (x dB ref power) to edges.
x dBm level	x dBm level defines the x dBm BW level search threshold.
x dBm range	Specifies the search direction for the x dBm level. The choices are Lower, Higher, or Both.
Measurement BW	Specifies the frequency range used by the measurement.
Max Hold spectral data	Enables the Max Hold function.
Average results	Enables/disables results average across acquisitions. (This is averaging of the results, not of the trace.)
Count	Specifies the number of results averaged to calculate the Occupied BW. Range: 2 to 10,000.

x dB level

The x dB level determines the x dB bandwidth. The analyzer analyses the spectrum trace to locate the frequencies at which the level is x dB down from the peak level, calculated over the measurement bandwidth. The frequency difference between the upper and lower crossing thresholds is the x dB BW.

Range: -80.0 to -1.0 dB; **Resolution:** 0.1%; Inc/dec small: 0.1%, large: 1%; **Default:** -20 dB

Meas Direction

The search for the x dB level or x dBm level can be done by selecting Inwards or Outwards in Meas Direction. Selecting Inwards directs the search from the edges towards maximum power. Selecting Outwards directs the search from maximum power (x dB ref power or CF for x dBm) to edges.

x dBm level

The x dBm level determines the x dBm bandwidth. The analyzer analyzes the spectrum trace to locate the frequencies at which the level is x dBm down from the Center frequency. The frequency range is calculated based on the choice of x dBm Range. The value of x dBm is set to -30 dBm when the BT 20dB BW display is launched from the Bluetooth Standards Presets.

Meas Range (Higher, Lower, Both)

This determines the search range for the x dB level. The options are as follows:

- **Lower:** Indicates the frequency range from center to the lower frequency at which the power level drops to x dBm.
- **Higher:** Indicates the frequency range from center to the higher frequency at which power level drops to x dBm.
- **Both:** Indicates the frequency between the upper and the lower crossing thresholds at which the power level drops to x dBm.

Max Hold spectral data

Max Hold displays the maximum value in the acquisition record for each display point. Each new trace display point is compared to the previous maximum value and the greater value is retained for display and subsequent comparisons.

Freq & RBW tab - Bluetooth

The Freq & RBW tab allows you to specify the bandwidth parameters used for setting measurement bandwidth in the BT 20dB BW display. This determines what acquisition bandwidth the measurement will request.

Setting	Description
Meas Freq	Specifies the measurement frequency.
RBW	Select Auto or Manual. Adjusts the resolution bandwidth for the entire measurement. This setting is independent of the Spectrum display's RBW setting.

Table continued...

Setting	Description
Step	Sets the increment/decrement size for the adjustment of the center frequency. If Auto is enabled, the analyzer will adjust the step size as required.
VBW	Adjusts the video bandwidth.

Measurement Params tab - Bluetooth

The Measurement Params tab is only available for the BT InBand Emission display. It allows you to select the average domain.

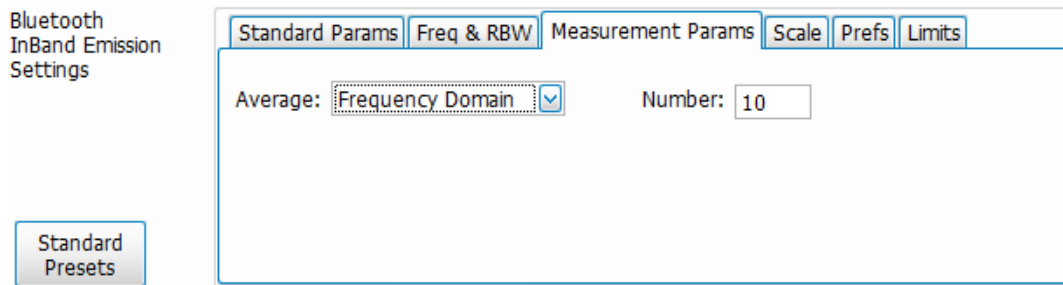

Setting	Description
Average	Specify the average domain (Time Domain, Frequency Domain) or set Average to Off. If a domain is selected, then you can also specify the number.
Number	Specify the number value associated with the Average setting.

Audio Analysis and Demodulation

Overview

Audio Analysis (Option SVNL-SVPC or SVFL-SVPC) measures basic time- and frequency-domain parameters of analog audio signals modulated on a carrier (AM, FM and PM modulation) or unmodulated (non-carrier) audio signals (Direct).

For modulated signals, the measurement analysis first demodulates the signal to provide the *Audio signal* waveform. Direct input signals bypass the demodulation step. For FM and PM demodulation, the carrier frequency error is estimated during demodulation.

The Audio signal waveform excursions are then measured to determine the Peak and RMS waveform parameters. Next, the analysis detects the highest-amplitude frequency component within the audio bandwidth, and makes a high-accuracy frequency measurement of the frequency component. This value is called the *Audio Frequency*.

A spectral analysis of the Audio signal waveform is performed to determine the presence and level of harmonically- and/or non-harmonically-related narrowband spurs and wideband noise. The Audio signal, harmonic and non-harmonic spurs, and noise level data are combined to produce signal summary parameters including SINAD, Modulation Distortion, Signal-to-Noise, Total Harmonic Distortion, and Total Non-Harmonic Distortion.

Controls are provided to allow the user to select audio filters of Low Pass, High Pass, FM De-emphasis, or Standard-defined response, as well as completely user-definable filter response. Filtering can be applied as needed to modify the audio spectrum result before measurement to remove unwanted spurs or noise.

Flexible control parameters are provided to allow setting the Audio Bandwidth for analysis, the Resolution Bandwidth (RBW) and RBW filter type of the spectral analysis, and number and level qualifications for Harmonic and Non-harmonic spur detection. Multiple-spectrum averaging can be enabled to provide a smoothed spectrum for results with less variability than single-spectrum results.

The Audio Spectrum display shows the frequency spectrum waveform with detected harmonic and non-harmonic components identified by markers, and a corresponding table of frequency and level values for the spur components. The markers and table provide easy visualization of the significant spurs and their relation to the fundamental Audio frequency signal.

Audio Spectrum Display

The Audio Spectrum display shows audio modulation characteristics. You can choose to show just the spectrum of the audio signal or show the audio spectrum of the signal and the results of distortion measurements. The Audio Spectrum display can show a table listing the frequency of a Harmonic Distortion (HD) and Non-Harmonic Distortion (NHD) and its level. The Spectrum graph indicates these harmonics and non-harmonics with special markers.

To display the Audio Spectrum display:

1. Recall an appropriate acquisition data file.
2. Press the **Displays** button or select **Setup > Displays**. This shows the **Select Displays** dialog box.
3. From the **Measurements** box, select **Audio Analysis**.
4. Double-click the **Audio Spectrum** icon in the **Available Displays** box. This adds the Audio Spectrum icon to the **Selected displays** box.
5. Click the **OK** button. This shows the Audio Spectrum display.

Elements of the Audio Spectrum Display



Item	Display element	Description
1	Vertical position	Sets the top of graph value.
2	dB/div	Sets the vertical scale value. The maximum value is 20.00 dB/division.
3	Audio BW	Specifies the measurement bandwidth of the Audio Spectrum display, which in turn can influence the acquisition bandwidth.
4	Table	Displays a table that shows the distortion measurement results and displays indicators on the graph that highlight the location of the harmonics on the trace.
5	Bottom of graph readout	Displays the bottom of graph value.
6	Non-harmonic threshold indicator	Displays the threshold for detecting non-harmonic components.
7	Analysis results	Display of the audio analysis results.

Audio Spectrum Settings

Main menu bar: Setup > Settings



The measurement settings for the Audio Spectrum display are shown in the following table.

Settings tab	Description
Params1 Tab on page 653	Specifies signal type, Audio Bandwidth, RBW, RBW filter, and Ref Audio Frequency.
Params2 Tab on page 654	Specifies Harmonics and Non-Harmonics measurement parameters.

Table continued...

Settings tab	Description
Audio Filters Tab on page 655	Specifies the audio filter characteristics.
Scale Tab on page 197	Sets vertical and horizontal scale and position parameters.
Prefs Tab on page 660	Specifies vertical units, and whether on not some features are displayed in the graph.

Audio Summary Display

To display the Audio Summary display:

1. Press the **Displays** button or select **Setup > Displays**. This shows the **Select Displays** dialog box.
2. From the **Measurements** box, select **Audio Analysis**.
3. Double-click the **Audio Summary** icon in the **Available Displays** box. This adds the Audio Summary icon to the **Selected displays** box.
4. Click the **OK** button. This shows the Audio Summary display.

The Audio Summary Display

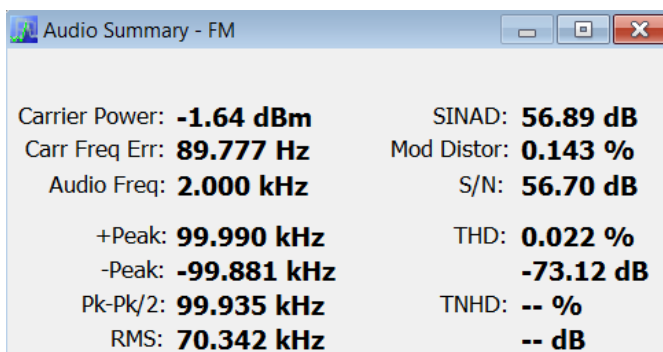

Carrier Power: -1.64 dBm	SINAD: 56.89 dB
Carr Freq Err: 89.777 Hz	Mod Distor: 0.143 %
Audio Freq: 2.000 kHz	S/N: 56.70 dB
+Peak: 99.990 kHz	THD: 0.022 %
-Peak: -99.881 kHz	-73.12 dB
Pk-Pk/2: 99.935 kHz	TNHD: -- %
RMS: 70.342 kHz	-- dB

Audio Summary Displayed Measurements

Table 37: Audio Summary Measurements

Signal type	Item	Description
AM, FM, PM	Carrier Power	Average power of the carrier signal with modulation removed.
Direct	Signal Power	Average power of the input signal
FM, PM	Carr Freq Err	Carrier frequency error
AM, FM, PM. Direct	Audio Freq	Fundamental audio frequency
	+Peak	+Peak modulation excursion (where the modulation excursion readout depends on the signal type) ⁴

Table continued...

⁴ For AM signal types, modulation excursion is "% Modulation Depth". For FM signal types, modulation excursion is "Frequency Deviation". For PM signal types, modulation excursion is "Phase Deviation". For Direct, there is no modulation excursion, it is actually "signal excursion".

Signal type	Item	Description
	-Peak	-Peak modulation excursion (where the modulation excursion readout depends on the signal type) ⁴
	Peak-Peak/2	Half peak-peak modulation excursion (where the modulation excursion readout depends on the signal type) ⁴
	RMS	RMS modulation excursion (where the modulation excursion readout depends on the signal type) ⁴
	SINAD	Signal to noise and distortion
	Mod Distor	Modulation distortion
	S/N	An estimate of the Signal level to Noise (only) level, with the HD and NHD components removed
	THD	Total harmonic distortion
	TNHD	Total non-harmonic distortion
	Ref	Ref is the RMS modulation value stored when the Capture Reference button is pressed. (Displayed only when Hum & Noise is enabled.)
	Diff	Diff is the difference between the current RMS mod value and the Ref value captured previously. (Displayed only when Hum & Noise is enabled.)

Audio Summary Settings

Main menu bar: Setup > Settings



The measurement settings for the Audio Summary display are shown in the following table.

Settings tab	Description
Params1 Tab on page 653	Specifies signal type, Audio Bandwidth, RBW, RBW filter, and Ref Audio Frequency.
Params2 Tab on page 654	Specifies Harmonics and Non-Harmonics measurement parameters.
Audio Filters Tab on page 655	Specifies the audio filter characteristics.
Hum & Noise Tab	Specifies whether or not Hum & Noise is measured and enables the capture of a signal to be used as a reference of the Hum & Noise measurement.

Audio Analysis Measurement Settings

The control panel tabs in this section are shared by the displays in the Audio Analysis folder (Setup > Displays).

Table 38: Common controls for Audio Analysis displays

Settings tab	Description
Params1 Tab on page 653	Specifies characteristics about the audio signal and how measurements are made.
Params2 Tab on page 654	Specifies parameters that control how measurements are made on harmonics.
Audio Filters Tab on page 655	Specifies characteristics of filters applied to the signal before measurements are taken.
Scale Tab on page 197	Sets vertical and horizontal scale and position parameters.
Prefs Tab for Audio Analysis	The Prefs tab enables you to change appearance characteristics of the Audio Analysis displays.

Params1 Tab

The Params1 tab is used to specify characteristics of the audio signal to be measured and how the signal will be measured.

The screenshot shows the Params1 tab with the following settings:

- Signal Type: AM
- Audio BW: 20.000 kHz
- Ref Audio Freq: 2.000 kHz (checked Auto)
- RBW: 40.0 Hz (checked Auto)
- RBW Filter: Kaiser

Figure 102: Params1 tab for AM signal types

Setting	Description
Signal Type	Specifies the type of signal to be analyzed. The available choices are AM, FM, PM, and Direct.
Audio BW	Specifies the bandwidth used for audio analysis.
Ref Audio Freq	A measured value when Auto is selected. If you want to specify the reference audio frequency, uncheck Auto and enter a value manually. If Ref Audio Freq is set manually, be aware that the automated detection is still performed, but it is limited to a frequency range of $\pm 1\%$ of the Audio BW centered around the manually specified value.
Carrier Freq Error / Carrier Freq Offset	(FM and PM only) A measured value, when Auto is selected. If Auto is unchecked, you can specify the Carrier Frequency Offset.
RBW	Displays the Resolution Bandwidth for Audio measurements. This value is automatically set by default to 1/500 of the measurement bandwidth. To manually specify the RBW, uncheck Auto. The minimum RBW value is limited to the larger of 1 Hz or AudioBW/10000. The maximum is limited to AudioBW/100.
RBW Filter	Specifies the windowing method used for the transform.

Setting Frequency for Direct Signal Types

Direct (unmodulated) signal analysis is only possible with the instrument Frequency control set to 0 Hz. You will receive a warning to set Frequency to 0 Hz when Direct signal type is selected, if you haven't already done so. Modulated signal types may be selected with Frequency set to 0 Hz, but results are not meaningful in that case. For modulated signals, Frequency should always be set to a value \geq Audio Bandwidth to avoid self-interference of the signal due to spectral folding.

Setting Audio Bandwidth

For AM, FM and PM, the Audio Bandwidth control sets not only the demodulated signal bandwidth, but also determines the pre-demodulation bandwidth. Set it to a value at least half the pre-demodulation signal bandwidth, as in this equation:

$$\text{Audio BW} \geq \text{Signal Bandwidth} / 2$$



Note: When performing audio analysis, you should allow the Audio BW control to automatically set the acquisition bandwidth, rather than manually adjusting the Acq BW control on the Sampling Parameters tab of the Acquire control panel. The audio measurement will cause the Acq BW setting to be \geq Audio BW (Direct) or $\geq 2 \times$ Audio BW (AM, FM, PM).

For Direct signals, set Audio Bandwidth large enough to include any significant harmonics/non-harmonics or other signal component of interest. For example, to measure up to the 10th harmonic of a signal with a 5 kHz fundamental component, set Audio Bandwidth to $10 \times 5 \text{ kHz} = 50 \text{ kHz}$.

For modulated signals, Audio Bandwidth must be set wide enough to include all significant signal modulation components in addition to the desired audio analysis bandwidth. For AM this is similar to Direct. For example, to measure up to the 10th harmonic of an AM signal with 3 kHz fundamental component, set Audio Bandwidth to $10 \times 3 \text{ kHz} = 30 \text{ kHz}$. This ensures that the bandwidth of the data provided by the system to the measurement will be at least of 60 kHz ($2 \times 30 \text{ kHz}$) which is sufficient for this signal and analysis requirement.

FM and PM are more complex. For FM, the analysis bandwidth needs to be at least twice as wide as the the sum of peak Frequency Deviation and the Fundamental Frequency (Carsons rule). This is a parallel condition along with setting Audio Bandwidth large enough for the maximum audio bandwidth to analyze. Therefore, for FM, Audio Bandwidth should be:

$$\text{AudioBW (FM)} = \text{MAX}(\text{MaxAudioAnalysisFreq}, \text{FreqDeviation} + \text{FundamentalFreq})$$

where MaxAudioAnalysisFreq is the highest audio frequency desired in the analysis. For example, for an FM signal with fundamental signal of 5 kHz and peak frequency deviation (one-sided) of 10 kHz, Acquisition Bandwidth should be at least $(2 \times (10\text{k} + 5\text{k})) = 30 \text{ kHz}$, or an Audio Bandwidth of 15 kHz. Also if the analysis should extend to the 8th harmonic, then the Audio Bandwidth needs to be at least $8 \times 5 \text{ kHz} = 40 \text{ kHz}$. So Audio Bandwidth should be set to 40 kHz. Using the equation:

$$\text{AudioBW (FM)} = \text{MAX}(8 \times 5 \text{ kHz}, (10 + 5) \text{ kHz}) = \text{MAX}(40 \text{ kHz}, 15 \text{ kHz}) = 40 \text{ kHz}$$

The formula for PM is:

$$\text{AudioBW (PM)} = \text{MAX}(\text{MaxAudioAnalysisFreq}, \text{PMFreqDeviation} + \text{FundamentalFreq})$$

where

$$\text{PMFreqDeviation} = \text{PMPhaseDeviationInRadians} \times \text{FundamentalFreq}$$

RBW Filter Shape

Select Kaiser in most cases for best measurement performance. Select Flattop only if you want to use standard markers to measure signal amplitude with highest accuracy.

Params2 Tab

The Params2 tab is used to specify how the signal harmonics are measured and to control spectrum averaging.

Params1	Params2	Audio Filters	Scale	Prefs
No. of Harmonics: 12		Non-Harmonics only		
No. of Non-Harmonics: 12		Ignore region: 0.0 Hz		
<input type="checkbox"/> Averaging: 10		Threshold: -65.0 dBc		
		Excursion: 6.0 dB		

Setting	Description
No. of Harmonics	Specifies the number of harmonics to detect. The detected harmonics are tagged with a number on the spectrum trace. The available range is 1–20.
No. of Non-Harmonics	Specifies the number of non-harmonics to detect. The detected non-harmonics are tagged with a number on the spectrum trace. The available range is 0–20.
Averaging	Specifies the number of averages used to compute the results. Range: 2–100.
Ignore region	Specifies the region about the signal frequency where the instrument will ignore non-harmonics.
Non-Harmonic Threshold	Specifies the level which a spectrum peak must exceed to be declared a non-harmonic signal component.
Non-Harmonic Excursion	Specifies the difference in level between a spectrum peak and the average noise level that must be exceeded for the peak to be declared a non-harmonic signal component.

About Averaging In Audio Analysis Displays

Analysis averaging is implemented using a “block” method. This means that the entire record required for multiple spectrum computations is acquired and analyzed within one analysis cycle. The result of each analysis update is a complete, independent result from a set of N spectrums averaged together, where N is the Averaging control value.. Since each update is a fully averaged result, no partially averaged results are output before a final result is available, so each output is fully valid. However, with large Averaging values, acquisition record sizes and measurement times may become large, so care should be taken to select the minimum amount of averaging needed.

Audio Filters Tab

The Audio Filters tab is used to specify filters to be applied to the acquired audio signal before measurements are taken. You can select from pre-defined filters or use a filter you define in a text file. You can also specify the de-emphasis time constant applied to the audio signal and the telecom weighting filters used to measure noise.

Params1	Params2	Audio Filters	Scale	Prefs
<input checked="" type="radio"/> Pre-defined Filters	<input checked="" type="checkbox"/> LPF: 300 Hz	<input type="checkbox"/> De-emphasis: 25 μ sec		
	<input type="checkbox"/> HPF: 50 Hz	<input type="checkbox"/> Standard: CCITT		
<input type="radio"/> File:	...			

Predefined Filters

You can specify low-pass filter (LPF) and high-pass filter (HPF) settings, a de-emphasis time constant and/or a telecom weighting filter to match the response of your receiver. Alternatively, you can create a text file to specify the frequency response points.

To use predefined filters:

1. Select the **Predefined Filters** option button.
2. Select the LPF, HPF, De-emphasis and Standard check boxes as appropriate.
3. Select the desired filter parameter from the drop-down list for each of the enabled filters or select User from the list if you wish to use a custom value. For LPF and HPF, the listed frequencies represent the 3dB cutoff point of the filter.
4. If you select **User** from the drop-down list, enter a value in the text entry box that appears.

To disable all filtering:

1. Select the **Predefined Filters** option button.
2. Deselect all four filter check boxes.

Table 39: Predefined audio filters

Filter type	Available settings
LPF (Low Pass Filter) (5th-order Butterworth response)	300 Hz
	3 kHz
	15 kHz
	30 kHz
	80 kHz
	300 kHz
	User ⁵
HPF (High Pass Filter) (5th-order Butterworth response)	20 Hz
	50 Hz
	300 Hz
	400 Hz
	User ⁵
Table continued...	

⁵ User-entered values are restricted to maximum of 0.9 * Audio BW, and will automatically adjust downward to meet this limit (if required) when AudioBW is decreased.

Filter type	Available settings
De-emphasis (FM only)	25 μ s
	50 μ s
	75 μ s
	750 μ s
	User. Range: 25 μ s to 10 ms
Standard	CCITT
	C-message

Standard. Use this setting to specify the telecom weighting filter. The characteristics of these filters are described in ITU-T Recommendation O.41, Psophometer for Use on Telephone-type Circuits.

Using Custom Audio Filters

If you want to use audio filters that have a different response shape than the pre-defined filters, you can create a custom audio filter using a text or CSV file to specify the desired filter frequency response.

To use a custom audio filter:

1. Verify that Audio Spectrum or Audio Summary is the selected display.
2. Click the Settings icon or select **Setup > Settings**.
3. Select the **Audio Filters** tab.
4. Click the **File** button.
5. Click the ... button and navigate to the location of the custom audio filter file you wish to use. Select the file you want to use and click Open.
6. Acquire a new trace or replay a saved file to see the effect of the custom filter.

Creating a Custom Audio Filter. A custom audio filter file is either a plain text file or a CSV format file. The file contains frequency (in Hz) and amplitude (in dB) value pairs which specify the filter frequency response shape. Each pair must be on a separate line. The filter response between the points is interpolated using a cubic spline fit.

The following table shows the first few lines of a custom audio filter text file.

0,	-100
16.66,	-85
50,	-63
100,	-41
200,	-21

Table continued...

300,	-10.6
400,	-6.3
500,	-3.6
600,	-2
700,	-0.9
800,	0
...	...

Format and rule-checking on custom audio filter files is performed as follows:

- The maximum number of frequency and amplitude pairs is 1000.
- Column 1 (frequency values in Hertz).
 - Non-negative values only (zero is allowed).
 - Strictly increasing order of frequencies (frequency value on each line > frequency value on previous line).
 - There is no upper limit on the frequency value.
- Column 2 (amplitude values in dB units, where gain is a positive value and attenuation is a negative value).
 - Values are restricted to the range -200 to +20 dB.

Scale Tab

The Scale tab allows you to change the vertical and horizontal scale settings. Changing the scale settings changes how the trace appears on the display but does not change acquisition control settings. In effect, these controls operate like pan and zoom controls.



Setting	Description
Vertical	
Scale	Changes the range shown between the top and bottom of the graph.
Position	Adjusts the level shown at the top of the graph for linear units or the top of the graph for log units (for example, dBm).
Autoscale	Resets the Position so that the highest trace points are in the graph. For linear units (Volts, Watts), the Autoscale also adjusts Scale.

Table continued...

Setting	Description
Horizontal	
Left	Changes the frequency shown at the left side of the graph.
Right	Changes the frequency shown at the right side of the graph.
Autoscale	Resets the Left and Right settings to show the entire trace.
Log	Sets the graph horizontal axis to a logarithmic scale.
Reset Scale	Resets the Vertical and Horizontal settings to their default values.

Hum & Noise Tab

Hum & Noise (available only when the Audio Summary display is the active display) is useful for comparing residual power or modulation if the Ref value is captured when the Signal is On (Direct) or modulated (AM/FM/PM). When the signal is turned off (Direct) or modulation turned off (AM/FM/PM), Diff indicates how much residual Hum and Noise are still present in the measurement value.

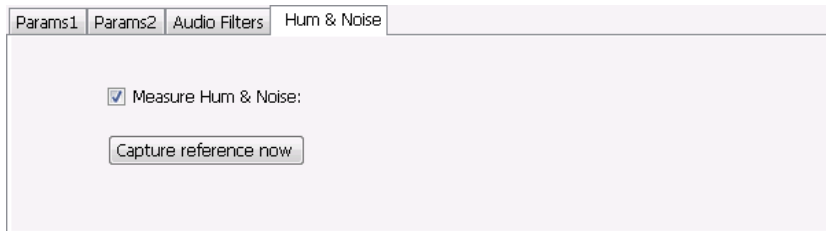

To display Hum & Noise measurement:

1. Select **Setup > Displays**.
2. In the Select Displays window, select the **Audio Analysis** folder.
3. Double-click the **Audio Summary** icon so that it appears in the **Selected displays** box.
4. Click **OK**
5. With the Audio Summary display selected, select **Setup > Settings**.
6. Select the **Hum & Noise** tab. Click on the **Measure Hum & Noise** checkbox so that it is checked.

The Hum & Noise values appear at the bottom list of measurements in the Audio Summary display.

7. Acquire an appropriate signal.
8. While the analyzer is analyzing a signal you want to use as a reference, click the **Capture reference now** button to save a reference value.

The Hum & Noise measurement compares the value of a specific signal quantity captured by the **Capture reference now** button with the current measured value of that quantity. For Direct signal types (set on the Params1 tab), the Signal Level is captured and compared. The Diff measurement is:

$$\text{SignalLevel}(\text{current}) - \text{SignalLevel}(\text{Ref})$$

in dB.

For AM, FM, and PM signal types, the RMS modulation value (related to Modulation Depth, Frequency Deviation or Phase Deviation) is captured and compared. The Diff measurement is:

$20 \times \log_{10} (\text{RMS}(\text{current})/\text{RMS}(\text{Ref}))$

in dB.

Prefs Tab

The Prefs tab enables you to change appearance characteristics of the Audio Spectrum display.

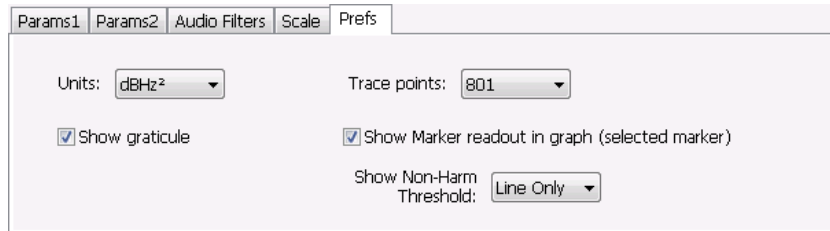

Setting	Description
Units:	Specifies the vertical scale units. The units available depend on the signal type selected.
Show graticule	Select to display or hide the graticule.
Trace points	Sets the number of trace points used for marker measurements and for results export.
Show Marker readout in graph (selected marker)	Shows or hides the readout for the selected marker in the graph area.
Show Non-Harm Threshold	Shows or hides the non-harmonic threshold line.

Audio Demodulation

Main menu bar: Setup > Audio

Favorites toolbar:



Selecting **Audio** displays the Audio demodulation control panel.

This panel is only available when SignalVu-PC is connected to an RSA306, RSA306B, RSA500A series, or RSA600A series instrument.



Note: Audio Demodulation is available only in real-time acquisition mode (not swept acquisition), and the Trigger mode must be set to Free Run (not Triggered).

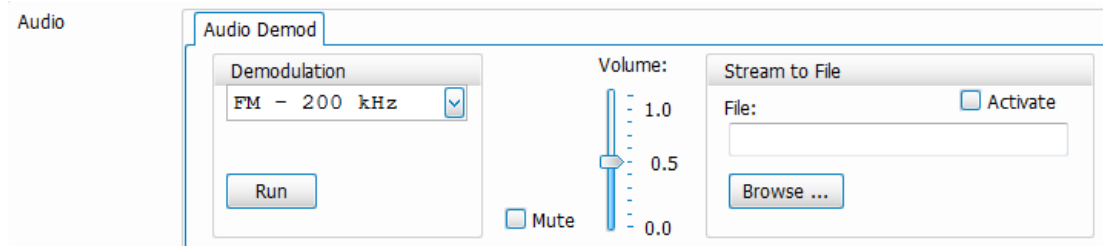

Setting	Description
Demodulation	Sets both the demodulation type and bandwidth.
Run	Starts and stops the live audio demodulation process.
Volume	Adjusts the volume of the demodulated audio signal played out through the PC speakers.
Mute	Inhibits the audio from playing out through the PC speakers
Stream to File	These controls allow you to stream the demodulated audio file directly to disc. The audio file is saved as a .WAV file.
File:	Displays the current location where the audio file is saved.
Browse:	Use the Browse... button to navigate to a location to save the audio file.
Activate	This enables the Stream to File function. When checked, anytime the Run button is pressed, the audio stream-to-file begins.

GP Digital Modulation

Overview

The displays in General Purpose (GP) Digital Modulation (Displays > Source > Measurements > GP Digital Modulation) are:

- Constellation
- Demod I & Q vs Time
- EVM vs Time
- Eye Diagram
- Frequency Deviation vs Time
- Magnitude Error vs Time
- Phase Error vs Time
- Signal Quality
- Symbol Table
- Trellis Diagram

The General Purpose Digital Modulation Analysis (Option 21) provides vector signal analyzer functionality. A wide variety of modulation types are supported, allowing you to view your signals in Constellation, Eye and Trellis diagrams, measure the quality of the modulation, display time-domain waveforms for demodulated I & Q signals, EVM, Phase Error, Magnitude Error, and more. When connected, the multiple incoming signals from different sources (RF/IQ/Differential IQ) can be acquired, analyzed, and the results is viewed at same time in multiple displays.

Modulation Measurements



Note: A maximum of approximately 163,800 samples can be analyzed by the General Purpose Digital Modulation measurements (the actual value varies with modulation type).

Measurement	Description
EVM	The normalized RMS value of the error vector between the measured signal and the ideal reference signal over the analysis length. The EVM is generally measured on symbol or chip instants and can be reported in units of percent or dB. EVM is usually measured after best-fit estimates of the frequency error and a fixed phase offset have been removed.
Phase Error	The RMS phase difference between the measured signal and the ideal reference signal.
Magnitude Error	The RMS magnitude difference between the measured signal and the ideal reference signal.
IQ Origin Offset	The magnitude of the DC offset of the signal measured at the symbol times. It indicates the magnitude of the carrier feed-through signal.
Gain Imbalance	The gain difference between the I and Q channels in the signal generation path. Constellations with gain imbalance show a pattern with a width that is different from height.
Rho ρ	The normalized correlated power of the measured signal and the ideal reference signal. Like EVM, Rho is a measure of modulation quality. The value of Rho is less than 1 in all practical cases and is equal to 1 for a perfect signal measured in a perfect receiver.
Frequency Error	The frequency difference between the measured carrier frequency of the signal and the user-selected center frequency of the analyzer.

Table continued...

Measurement	Description
Quadrature Error	The orthogonal error between the I and Q channels. The error shows the phase difference between I and Q channels away from the ideal 90 degrees expected from the perfect I/Q modulation. Constellations with quadrature error will show some leakage of I into Q and vice versa.

Constellation Display

The Constellation Display shows a digitally-modulated signal in constellation form.

To show the Constellation Display:

1. Recall an appropriate acquisition data file.
2. Select the **Displays** button or select **Setup > Displays**. This shows the **Select Displays** dialog box.
3. Select the **Source(s)** from drop-down list.
4. From the **Measurements** box, select **GP Digital Modulation**.
5. Double-click the **Constellation** icon in the **Available Displays** box. This adds the Constellation icon to the **Selected displays** box.
6. Click the **OK** button. This shows the Constellation display.
7. Press the **Replay** button to take measurements on the recalled acquisition data file.

Elements of the Constellation Display

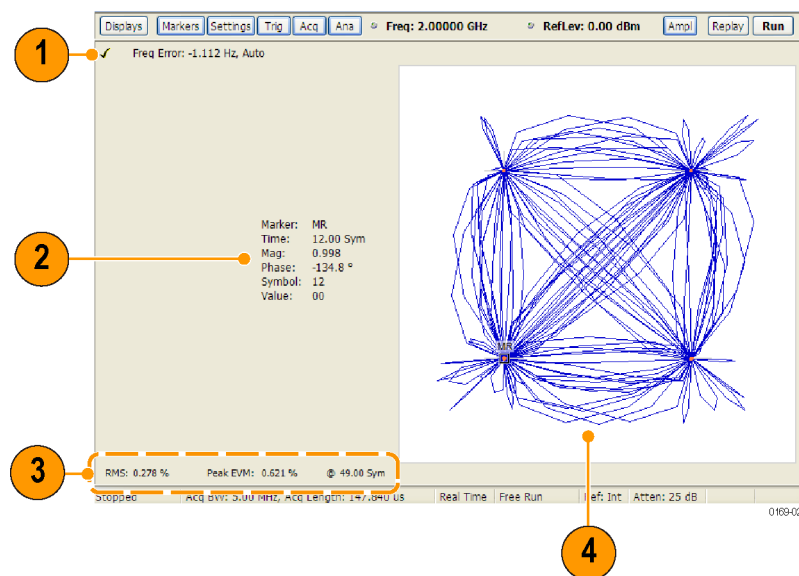

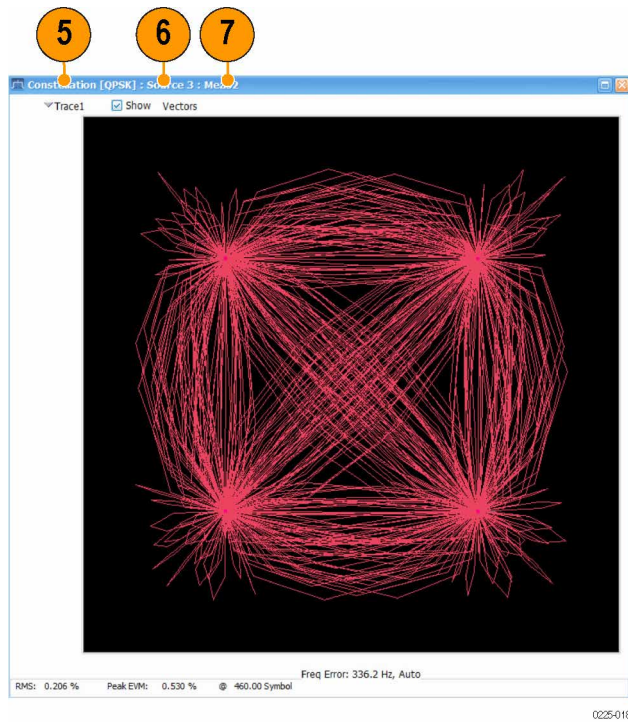

Item	Display element	Description
1	Check mark indicator	The check mark indicator in the upper, left-hand corner of the display shows when the Constellation display is the optimized display.  Note: When <i>Best for multiple windows</i> is selected in the Amplitude control panel's RF & IF Optimization control, none of the measurement displays shows a checkmark, as there is not a single optimized measurement.
2	Marker Readout	Located to the left of the constellation plot or below it, depending on the size of the window. If markers are enabled, the marker readout shows the time, mag, phase, symbol marker and symbol value of the point with the selected marker.
3	EVM Readouts	The EVM readouts are located below the Constellation plot. The readout shows EVM Peak (%) and location, RMS (%).
4	Plot	Constellation graph.
5	Modulation type	Modulation type configured for the selected source.
6	Source	Source corresponding to selected display.
7	Measurement Instance number	Represents the instance of measurement display created.

[Changing Constellation Settings](#)

Constellation Settings

Main menu bar: Setup > Settings



The settings for the Constellation view are shown in the following table.



Note: You might be able to save time configuring the Constellation display by pressing the Standard Settings button from the Settings control panel. This allows you to select a preset optimized for a standard from the Select Standard dialog box. See [Standard Settings Button](#) on page 694

Settings tab	Description
Modulation Params Tab on page 695	Specifies the type of modulation, symbol rate, and filters to be used in demodulating the input signal.
Freq & BW	Sets values for frequency error/offset, measurement bandwidth, and frequency deviation (not every control is present for every modulation type).
Equalizer Tab on page 701	Enable the Equalizer and adjust its parameters.
Advanced Params Tab on page 703	Specifies additional parameters that are less frequently used.
Find Tab on page 706	Used to set parameters for finding a burst within the data record and for entering a Synch word.
Analysis Time Tab on page 707	Contains parameters that define the portion of the acquisition record that is used for analysis. Also allows you to specify the Units (Seconds or Symbols) for the GP Digital Modulation displays.
Trace Tab on page 708	Allows you to set the trace display characteristics.
Prefs Tab on page 711	Enables you to set characteristics of the measurement display.

Demod I & Q vs Time Display

The Demod I & Q vs Time displays demodulated I and Q vs. Time. You can choose to display I only, Q only, or both.

Elements of the Display

To show the Demod I & Q vs Time display:

1. Recall an appropriate acquisition data file.
2. Select the **Displays** button or select **Setup > Displays**. This shows the **Select Displays** dialog box.
3. Select the **Source(s)** from drop-down list.
4. From the **Measurements** box, select **GP Digital Modulation**.
5. Double-click the **Demod I&Q vs Time** icon in the **Available Displays** box. This adds the Demod I&Q vs Time icon to the **Selected displays** box.
6. Click the **OK** button. This shows the Demod I&Q vs Time display.
7. Press the **Replay** button to take measurements on the recalled acquisition data file.

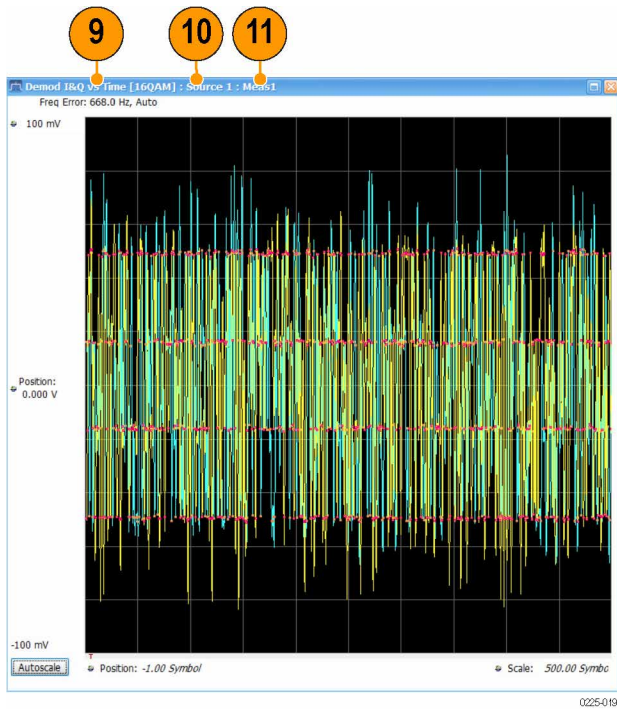
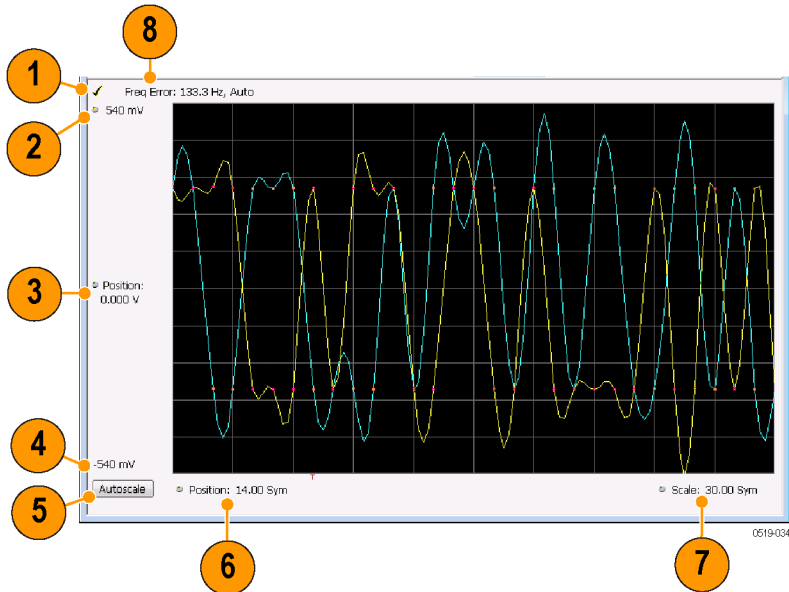

Item	Element	Description
1	Check mark indicator	<p>The check mark indicator in the upper, left-hand corner of the display shows when the Demod I & Q vs Time display is the optimized display.</p> <p>Note: When <i>Best for multiple windows</i> is selected in the Amplitude control panel's RF & IF Optimization control, none of the measurement displays shows a checkmark, as there is not a single optimized measurement.</p>

Table continued...

Item	Element	Description
2	Top of Graph	Sets the I and Q amplitude value indicated at the top of the graph. Changing the top value affects the bottom of graph readout. Also, note that the top of graph setting interacts with the internal vertical scale setting (which is not user settable) such that the range between the top and bottom of the graph increases or decreases automatically.
3	Position	Specifies the I and Q amplitude value shown at the center of the graph display.
4	Bottom Readout	Displays the I and Q amplitude value shown at the bottom of graph.
5	Autoscale	Adjusts the vertical and horizontal settings to provide the best display.
6	Position	Specifies the horizontal position of the trace on the graph display.
7	Scale	Adjusts the span of the graph. By decreasing the scale (time per division), the graph essentially becomes a window that you can move over the acquisition record by adjusting the offset.
8	Freq Error	This readout can show Freq Error or Freq Offset. When it displays Freq Error, it shows the difference between the instrument Frequency setting and the measured value of the signal's carrier frequency. When it displays Freq Offset, it shows the frequency offset specified on the Settings & Freq & BW tab. If Freq Error is displayed, it also indicates that the Carrier frequency detection setting is Auto. If Freq Offset is displayed, it indicates that the Carrier frequency detection setting is manual.
9	Modulation type	Modulation type configured for the selected source.
10	Source	Source corresponding to selected display.
11	Measurement Instance number	Represents the instance of measurement display created.

[Changing Demod I&Q Settings.](#)

Demod I & Q vs Time Settings

Main menu bar: **Setup > Settings**



The settings for the Demod I & Q vs Time display are shown in the following table.



Note: You might be able to save time configuring the Demod I & Q display by pressing the Standard Settings button from the Settings control panel. This allows you to select a preset optimized for a standard from the Select Standard dialog box. See [Standard Settings Button](#) on page 694

Settings tab	Description
Modulation Params Tab on page 695	Specifies the type of modulation used for the input signal and other parameters.
Freq & BW	Specifies settings for frequency error, measurement BW and Frequency Deviation. Each of these settings is set internally when set to Auto. Alternatively, you can specify values appropriate for specific measurement needs.
Equalizer Tab on page 701	Enable the Equalizer and adjust its parameters.

Table continued...

Settings tab	Description
Advanced Params Tab on page 703	Specifies additional parameters.
Find Tab on page 706	Used to set parameters for finding a burst within the data record and for entering a Synch word.
Analysis Time Tab on page 707	Contains parameters that define the portion of the acquisition record that is used for analysis. Also allows you to specify the Units (Seconds or Symbols) for the GP Digital Modulation displays.
Trace Tab on page 708	Allows you to set the trace display characteristics.
Scale Tab on page 710	Specifies the horizontal and vertical scale settings.
Prefs Tab on page 711	Enables you to set characteristics of the measurement display.

EVM vs Time Display

The EVM vs. Time Display shows the Error Vector Magnitude plotted over Time.



Note: A maximum of approximately 80,000 samples can be analyzed by the General Purpose Digital Modulation measurements (the actual value varies with modulation type).

To show an EVM vs. Time display:

1. Recall an appropriate acquisition data file.
2. Press the **Displays** button or select **Setup > Displays**. This shows the **Select Displays** dialog box.
3. Select the **Source(s)** from drop-down list.
4. From the **Measurements** box, select **GP Digital Modulation**.
5. Double-click the **EVM vs. Time** icon in the **Available Displays** box. This adds the EVM vs. Time icon to the **Selected displays** box.
6. Click the **OK** button. This displays the EVM vs. Time view.
7. Press the **Replay** button to take measurements on the recalled acquisition data file.

Elements of the EVM vs Time Display

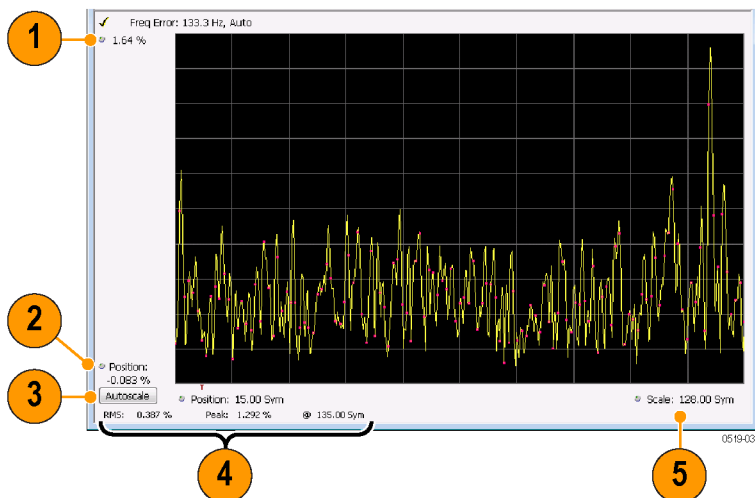

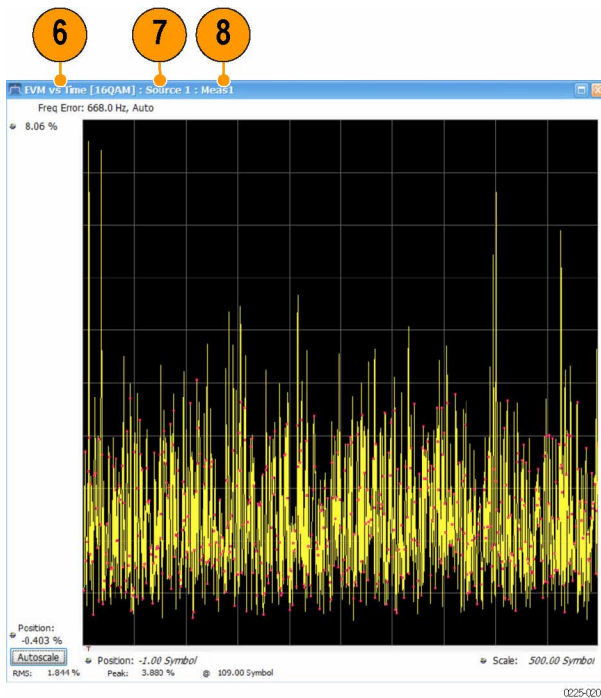

Item	Display element	Description
1	Top of graph adjustment	Use the knob to adjust the vertical scale.
2	Position	Adjusts the vertical position.
3	Autoscale	Adjusts the Horizontal and Vertical scale to show the entire trace.
4	Peak and RMS value readout	Shows the maximum result, the time it occurred, and the RMS of the result over the entire analysis length.
5	Scale	Sets the length of time shown in the graph.
6	Modulation type	Modulation type configured for the selected source.
7	Source	Source corresponding to selected display.
8	Measurement Instance number	Represents the instance of measurement display created.

[Changing the EVM vs Time Display Settings](#)

EVM vs Time Settings

Main menu bar: **Setup > Settings**



The settings for the EVM vs. Time display are shown in the following table.



Note: You might be able to save time configuring the EVM vs. Time display by pressing the Standard Settings button from the Settings control panel. This allows you to select a preset optimized for a standard from the Select Standard dialog box. See [Standard Settings Button](#) on page 694

Settings tab	Description
Modulation Params Tab on page 695	Specifies the type of modulation used in the input signal and other parameters that controls the demodulation of the input signal.
Freq & BW	Specifies settings for frequency error, measurement BW and Frequency Deviation. Each of these settings is set internally when set to Auto. Alternatively, you can specify values appropriate for specific measurement needs.
Equalizer Tab on page 701	Enable the Equalizer and adjust its parameters.
Advanced Params Tab on page 703	Specifies Freq Offset, Magnitude normalization parameters, and enables swapping I and Q.
Find Tab on page 706	The Find tab is used to set parameters for finding bursts within the data record.
Analysis Time Tab on page 707	The Analysis Time tab contains parameters that define how the signal is analyzed in the general purpose digital modulation displays.
Trace Tab on page 708	Specifies the display characteristics of the displayed trace.
Scale Tab on page 710	Specifies the horizontal and vertical scale settings.
Prefs Tab on page 711	Specifies whether certain display elements are visible.

Eye Diagram Display

The Eye Diagram Display shows a digitally modulated signal overlapped on itself to reveal variations in the signal.

To show an Eye Diagram display:

1. Recall an appropriate acquisition data file.
2. Press the **Displays** button or select **Setup > Displays**. This shows the **Select Displays** dialog box.
3. Select the **Source(s)** from drop-down list.
4. From the **Measurements** box, select **GP Digital Modulation**.
5. Double-click the **Eye Diagram** icon in the **Available Displays** box. This adds the Eye Diagram icon to the **Selected displays** box.
6. Click the **OK** button. This displays the Eye Diagram view.
7. Press the **Replay** button to take measurements on the recalled acquisition data file.

Elements of the Display

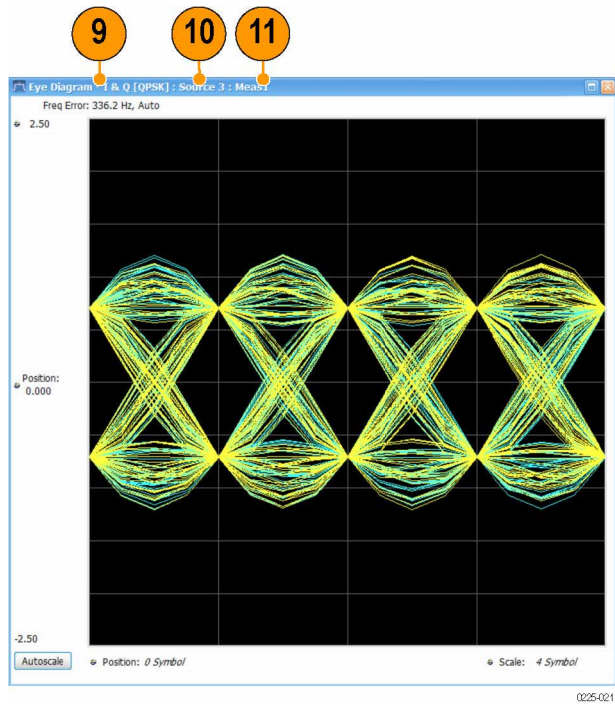
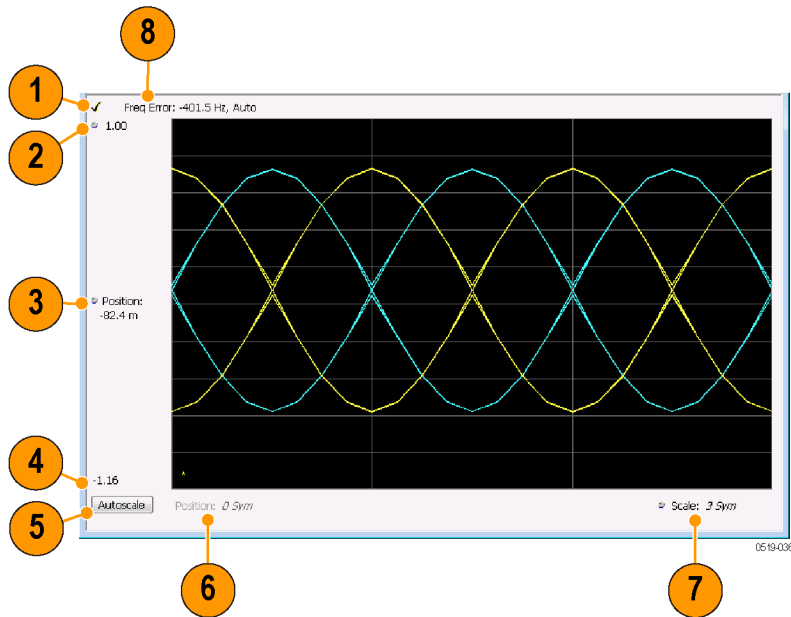

Item	Element	Description
1	Check mark indicator	<p>The check mark indicator in the upper, left-hand corner of the display shows when the Frequency Deviation vs Time display is the optimized display.</p> <p> Note: When <i>Best for multiple windows</i> is selected in the Amplitude control panel's RF & IF Optimization control, none of the measurement displays shows a checkmark, as there is not a single optimized measurement.</p>
2	Top of Graph	The vertical scale is normalized with no units (except for nFSK and C4FM modulation types where the vertical units are Hz).
3	Position	Specifies the value shown at the center of the graph display.
4	Bottom Readout	Displays the value indicated by the bottom of graph.
5	Autoscale	Adjusts the vertical and horizontal settings to provide the best display.
6	Position	Displays the horizontal position of the trace on the graph display.
7	Scale	Adjusts the span of the graph in symbols.
8	Freq Error	Displays the difference between the maximum and minimum measured values of the signal frequency during the Measurement Time. The displayed frequency error is followed by either Auto or Manual . This indicates the selected carrier frequency detection method (see Settings > Freq & BW).
9	Modulation type	Modulation type configured for the selected source.
10	Source	Source corresponding to selected display.
11	Measurement Instance number	Represents the instance of measurement display created.

[Changing Eye Diagram Settings](#)

Eye Diagram Settings

Main menu bar: Setup > Settings



The settings for the Eye Diagram display are shown in the following table.



Note: You might be able to save time configuring the Eye Diagram display by pressing the Standard Settings button from the Settings control panel. This allows you to select a preset optimized for a standard from the Select Standard dialog box. See [Standard Settings Button](#) on page 694

Settings tab	Description
Modulation Params Tab on page 695	Specifies the type of modulation used for the input signal and other parameters.

Table continued...

Settings tab	Description
Freq & BW	Specifies settings for frequency error, measurement BW and Frequency Deviation. Each of these settings is set internally when set to Auto. Alternatively, you can specify values appropriate for specific measurement needs.
Advanced Params Tab on page 703	Specifies additional parameters.
Find Tab on page 706	Used to set parameters for finding a burst within the data record and for entering a Synch word.
Analysis Time Tab on page 707	Contains parameters that define the portion of the acquisition record that is used for analysis. Also allows you to specify the Units (Seconds or Symbols) for the GP Digital Modulation displays.
Trace Tab on page 708	Allows you to set the trace display characteristics.
Scale Tab on page 710	Specifies the horizontal and vertical scale settings.
Prefs Tab on page 711	Enables you to set characteristics of the measurement display.

Frequency Deviation vs Time Display

To show a Frequency Deviation vs Time display:

1. Recall an appropriate acquisition data file.
2. Press the **Displays** button or select **Setup > Displays**. This shows the **Select Displays** dialog box.
3. Select the **Source(s)** from drop-down list.
4. From the **Measurements** box, select **Frequency Deviation vs Time**.
5. Double-click the **Frequency Deviation vs Time** icon in the **Available Displays** box. This adds the Frequency Deviation vs Time icon to the **Selected displays** box.
6. Click the **OK** button. This displays the Frequency Deviation vs Time view.
7. Press the **Replay** button to take measurements on the recalled acquisition data file.

Elements of the Display

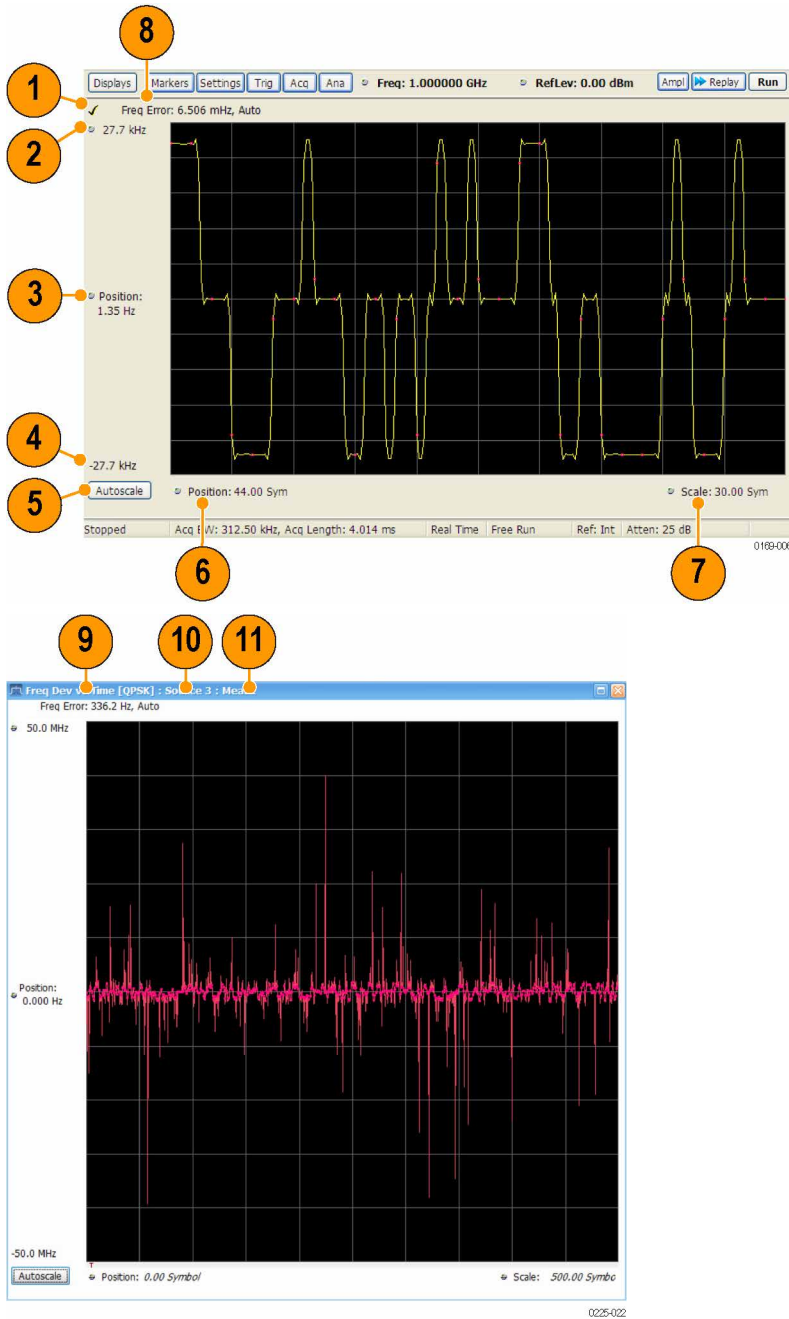

Item	Element	Description
1	Check mark indicator	The check mark indicator in the upper, left-hand corner of the display shows when the Frequency Deviation vs Time display is the optimized display. <div style="display: flex; align-items: center;"> <p>Note: When <i>Best for multiple windows</i> is selected in the Amplitude control panel's RF & IF Optimization control, none of the measurement displays shows a checkmark, as there is not a single optimized measurement.</p> </div>

Table continued...

Item	Element	Description
2	Top of Graph	Sets the frequency deviation value indicated at the top of the graph. Changing the top value affects the bottom of graph readout. Also, note that the top of graph setting interacts with the internal vertical scale setting (which is not user settable) such that the range between the top and bottom of the graph increases or decreases automatically.
3	Position	Specifies the frequency deviation value shown at the center of the graph display.
4	Bottom Readout	Displays the value of the frequency deviation value shown at the bottom of graph.
5	Autoscale	Adjusts the vertical and horizontal settings to provide the best display.
6	Position	Specifies the horizontal position of the trace on the graph display.
7	Scale	Adjusts the span of the graph. By decreasing the scale (time per division), the graph essentially becomes a window that you can move over the acquisition record by adjusting the offset.
8	Freq Error	Displays the difference between the maximum and minimum measured values of the signal frequency during the Measurement Time. The displayed frequency error is followed by either Auto or Manual . This indicates the selected carrier frequency detection method (see Settings > Freq & BW).
9	Modulation type	Modulation type configured for the selected source.
10	Source	Source corresponding to selected display.
11	Measurement Instance number	Represents the instance of measurement display created.

Changing Frequency Deviation vs Time Settings

Frequency Deviation vs Time Settings

Main menu bar: Setup > Settings



The Setup settings for Frequency Deviation vs. Time are shown in the following table.



Note: You might be able to save time configuring the Frequency vs. Time display by pressing the Standard Settings button from the Settings control panel. This allows you to select a preset optimized for a standard from the Select Standard dialog box. See [Standard Settings Button](#) on page 694

Settings tab	Description
Modulation Params Tab on page 695	Specifies the type of modulation used for the input signal and other parameters.
Freq & BW Equalizer Tab on page 701	Specifies settings for frequency error, measurement BW and Frequency Deviation. Each of these settings is set internally when set to Auto. Alternatively, you can specify values appropriate for specific measurement needs.
	Enable the Equalizer and adjust its parameters.

Table continued...

Settings tab	Description
Advanced Params Tab on page 703	Specifies additional parameters.
Find Tab on page 706	Used to set parameters for finding a burst within the data record and for entering a Synch word.
Analysis Time Tab on page 707	Contains parameters that define the portion of the acquisition record that is used for analysis. Also allows you to specify the Units (Seconds or Symbols) for the GP Digital Modulation displays.
Trace Tab on page 708	Allows you to set the trace display characteristics.
Scale Tab on page 710	Specifies the horizontal and vertical scale settings.
Prefs Tab on page 711	Enables you to set characteristics of the measurement display.

Magnitude Error vs Time Display

The Magnitude Error displays the magnitude of the symbol error. The amplitude appears on the vertical axis while time is plotted along the horizontal axis.



Note: A maximum of approximately 80,000 samples can be analyzed by the General Purpose Digital Modulation measurements (the actual value varies with modulation type).

To display Magnitude Error vs. Time:

1. Recall an appropriate acquisition data file.
2. Select the **Displays** button or **Setup > Displays**. This displays the Select Displays dialog box.
3. Select the **Source(s)** from drop-down list.
4. Select **GP Digital Modulation** in the **Measurements** box.
5. Double-click the **Mag Error vs. Time** icon or select the icon and click **Add**. The icon will appear in the **Selected displays** box and will no longer appear under Available displays.
6. Click **OK**.
7. Press the **Replay** button to take measurements on the recalled acquisition data file.

Elements of the Display

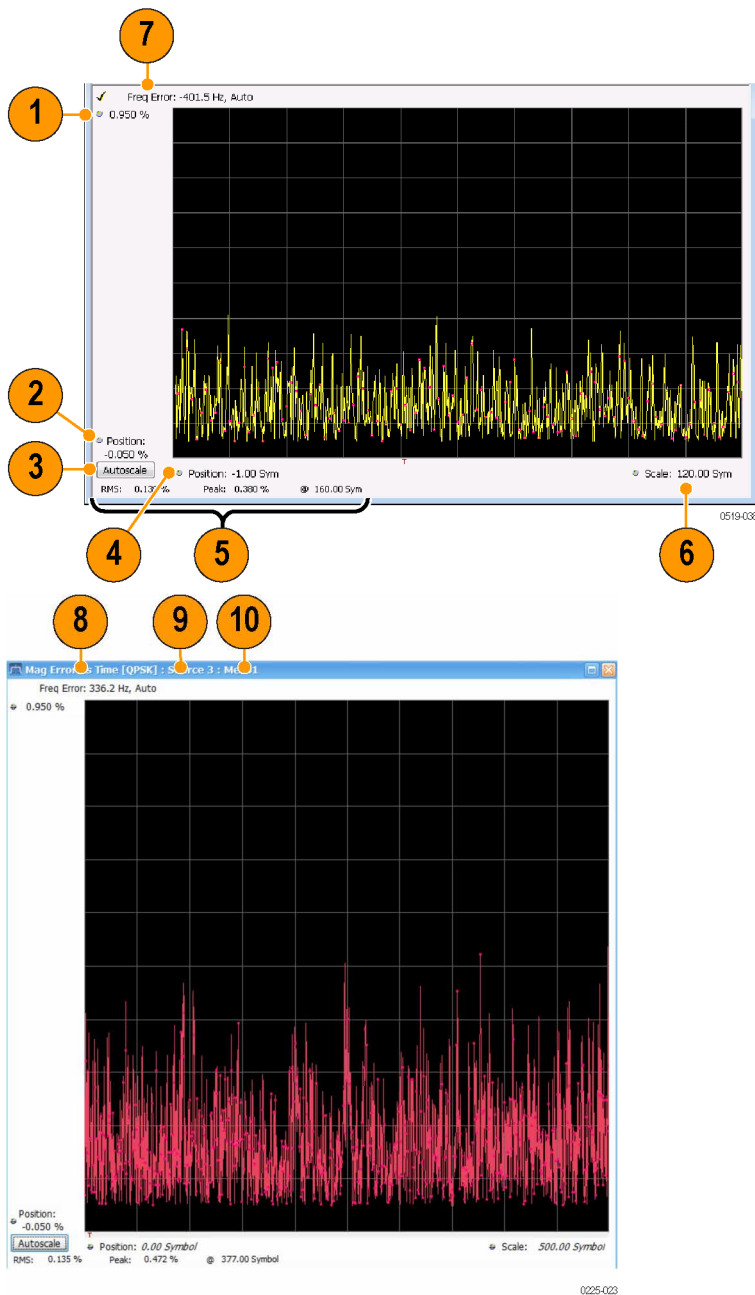

Item	Display element	Description
1	Top of graph adjustment	Use the knob to adjust the value of the vertical scale.
2	Position	Adjusts the level shown at the bottom of the display.
3	Autoscale button	Adjusts the vertical and horizontal settings to provide the best display.
4	Horizontal Position	Adjusts the horizontal position of the signal. Units can be either Symbols or Seconds (Settings > Analysis Time tab > Units).

Table continued...

Item	Display element	Description
5	Peak and RMS value readout	Displays the Peak value of the magnitude error, the RMS value of the magnitude error, and the time at which it occurs within the acquisition. Units can be either Symbols or Seconds (Settings > Analysis Time tab > Units).
6	Horizontal Scale	Sets the time spanned by the graph. Units can be either Symbols or Seconds (Settings > Analysis Time tab > Units).
7	Freq Error	Freq Error is the difference between the Center Frequency and the measured frequency of the signal being tested. This readout will be Freq Offset if the Freq Offset parameter on the Settings > Advanced Params tab is set to Manual .
8	Modulation type	Modulation type configured for the selected source.
9	Source	Source corresponding to selected display.
10	Measurement Instance number	Represents the instance of measurement display created.

Changing Magnitude Error vs Time Display Settings

Magnitude Error vs Time Settings

Main menu bar: **Setup > Settings**



The Setup settings for Magnitude Errors vs. Time are shown in the following table.



Note: You might be able to save time configuring the Magnitude vs. Time display by pressing the Standard Settings button from the Settings control panel. This allows you to select a preset optimized for a standard from the Select Standard dialog box. See [Standard Settings Button](#) on page 694

Settings tab	Description
Modulation Params Tab on page 695	Specifies the type of modulation used for the input signal and other parameters.
Freq & BW	Specifies settings for frequency error, measurement BW and Frequency Deviation. Each of these settings is set internally when set to Auto. Alternatively, you can specify values appropriate for specific measurement needs.
Equalizer Tab on page 701	Enable the Equalizer and adjust its parameters.
Advanced Params Tab on page 703	Specifies additional parameters.
Find Tab on page 706	Used to set parameters for finding a burst within the data record and for entering a Synch word.
Analysis Time Tab on page 707	Contains parameters that define the portion of the acquisition record that is used for analysis. Also allows you to specify the Units (Seconds or Symbols) for the GP Digital Modulation displays.
Trace Tab on page 708	Allows you to set the trace display characteristics.
Scale Tab on page 710	Specifies the horizontal and vertical scale settings.

Table continued...

Settings tab	Description
Prefs Tab on page 711	Enables you to set characteristics of the measurement display.

Phase Error vs Time Display

The Phase Error vs. Time display shows the phase angle of the symbol error over time. The phase is plotted along the vertical axis while time is plotted along the horizontal axis.



Note: A maximum of approximately 80,000 samples can be analyzed by the General Purpose Digital Modulation measurements (the actual value varies with modulation type).

To show the Phase Error display:

1. Recall an appropriate acquisition data file.
2. Press the **Displays** button or select **Setup > Displays**.
3. Select the **Source(s)** from drop-down list.
4. In the **Select Displays** dialog, select **GP Digital Modulation** in the **Measurements** box.
5. In the **Available displays** box, double-click the **Phase Error** icon or select the icon and click **Add**. The Phase Error icon will appear in the **Selected displays** box and will no longer appear under Available displays.
6. Click **OK** to display the Phase Error.
7. Press the **Replay** button to take measurements on the recalled acquisition data file.

Elements of the Phase Error vs Time Display

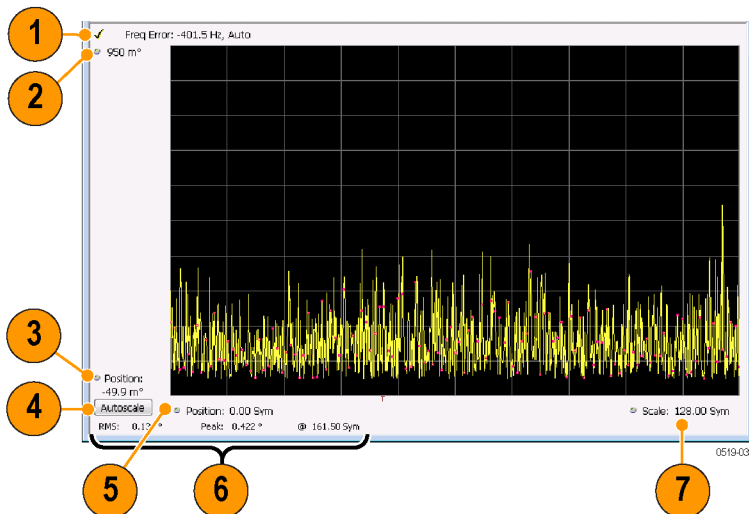

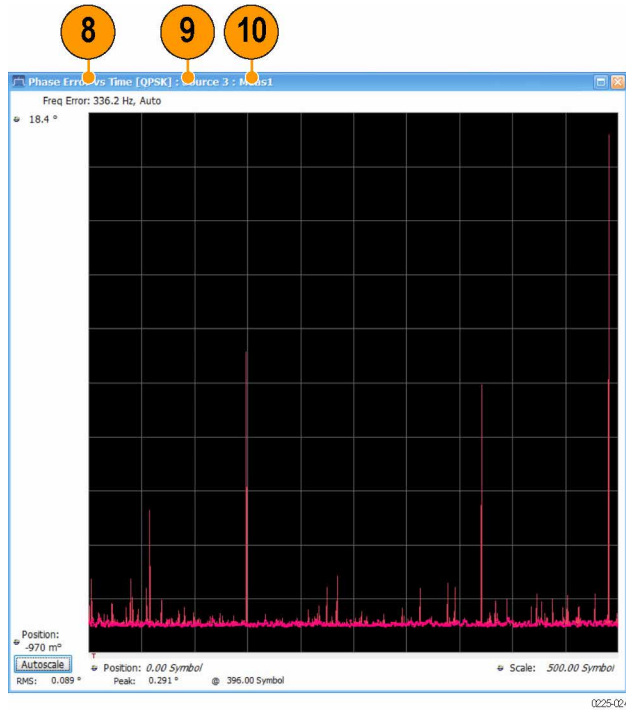

Item	Display element	Description
1	Freq Error	Freq Error is the difference between the Center Frequency and the measured frequency of the signal being tested. This readout will be Freq Offset if the Freq Offset parameter on the Settings > Advanced Params Tab on page 703 tab is set to Manual.
2	Top of graph adjustment	Adjusts the phase angle shown at the top of the graph.
3	Position	Adjusts the vertical offset.
4	Autoscale	Adjusts the vertical and horizontal settings so that the entire trace fits in the graph.
5	Offset	Adjusts the horizontal offset.
6	Peak and RMS readouts	Displays the Peak value of the phase error and the time at which it occurred. Also displays the RMS value over the analysis length.
7	Scale	Sets the time spanned by the graph.
8	Modulation type	Modulation type configured for the selected source.
9	Source	Source corresponding to selected display.
10	Measurement Instance number	Represents the instance of measurement display created.

[Changing the Phase Error vs Time Display Settings](#)

Phase Error vs. Time Settings

Main menu bar: Setup > Settings



The settings for the Phase Error vs. Time display are shown in the following table.



Note: You might be able to save time configuring the Phase Error vs. Time display by pressing the Standard Settings button from the Settings control panel. This allows you to select a preset optimized for a standard from the Select Standard dialog box. See [Standard Settings Button](#) on page 694

Settings tab	Description
Modulation Params Tab on page 695	Specifies the type of modulation used for the input signal and other parameters.
Freq & BW	Specifies settings for frequency error, measurement BW and Frequency Deviation. Each of these settings is set internally when set to Auto. Alternatively, you can specify values appropriate for specific measurement needs.
Equalizer Tab on page 701	Enable the Equalizer and adjust its parameters.
Advanced Params Tab on page 703	Specifies additional parameters.
Find Tab on page 706	Used to set parameters for finding a burst within the data record and for entering a Synch word.
Analysis Time Tab on page 707	Contains parameters that define the portion of the acquisition record that is used for analysis. Also allows you to specify the Units (Seconds or Symbols) for the GP Digital Modulation displays.
Trace Tab on page 708	Allows you to set the trace display characteristics.
Scale Tab on page 710	Specifies the horizontal and vertical scale settings.
Prefs Tab on page 711	Enables you to set characteristics of the measurement display.

Signal Quality Display

The Signal Quality display shows several measurements of signal quality. The measurements displayed depend on the modulation type. There is a set of measurements displayed for all modulation types except nFSK and C4FM. There is a second set of measurements displayed for nFSK and C4FM modulation types.

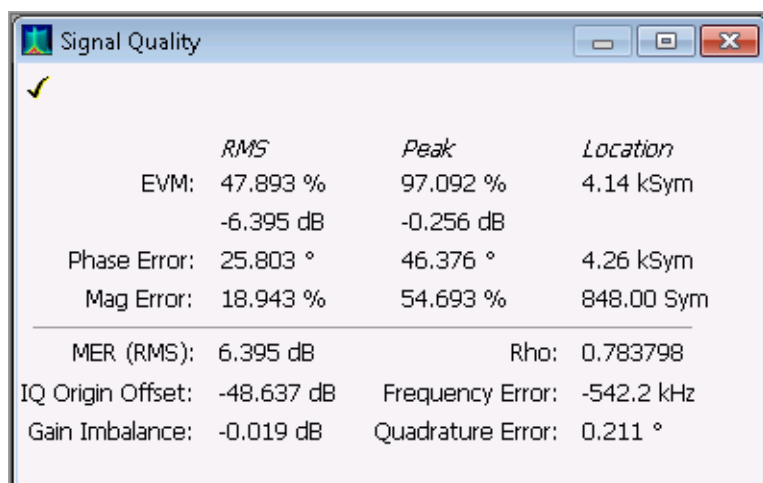

Figure 103: Signal Quality display for all modulation types except nFSK, C4FM, OQPSK, and SOQPSK

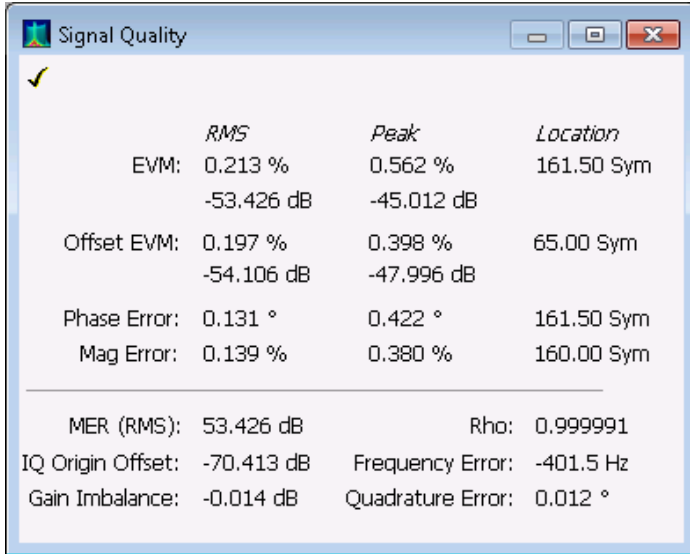

Figure 104: Signal Quality display for OQPSK and SOQPSK modulation types

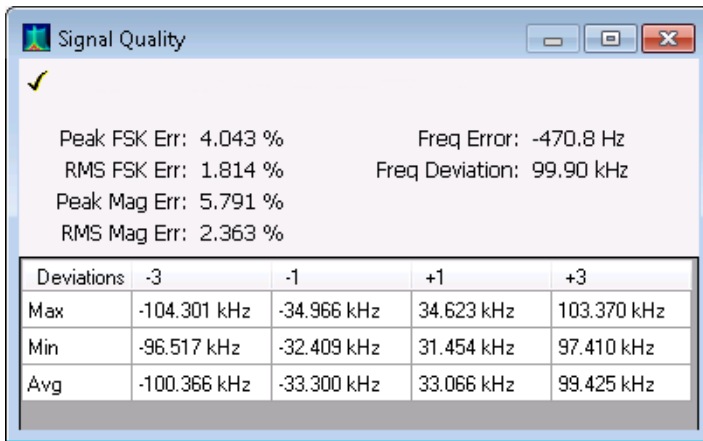

Figure 105: Signal Quality display for nFSK modulation type

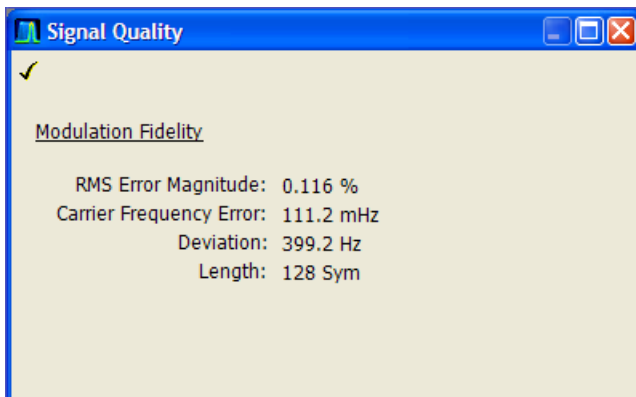

Figure 106: Signal Quality display for C4FM modulation type

Symbol Index	Bit 1	Bit 2	Bit 3	Bit 4
0	0111	0110	0100	1101
4	0000	0000	1110	1001
8	0111	1011	1010	0110
12	1000	1011	0111	1000
16	0011	0011	1100	0001
20	0010	0111	0100	0111
24	0101	1101	1000	0100
28	1010	1011	0110	0000
32	1111	0011	1010	0010
36	1000	1001	0100	0000
40	1110	1011	0110	0010
44	1110	1010	1110	1110
48	1110	1100	1101	0100
52	0000	1100	1010	1111
56	0110	0010	1100	1011
60	0111	1010	0010	1010
64	1000	1101	0100	0010
68	1101	0011	1011	1010
72	0100	1001	0010	0011
76	0100	0101	0110	0101
80	0101	1100	0000	1000
84	1010	1101	0101	1010
88	0001	0011	1101	1001
92	1110	0111	0010	0100
96	1111	0011	1000	0011
100	0001	1101	1000	0110
104	1011	0010	0010	1100
108	1001	0110	0011	0110
112	0110	1110	1000	1101
116	0110	0011	0100	0111
120	0111	1100	0001	0000
124	0110	1101	0011	1001
128	1011	1101	1101	1110
132	0101	0001	1100	0010
136	1011	0010	0000	1101
140	0000	0010	1111	0000
144	0011	0111	1100	0011
148	0001	1111	1001	1111

Elements of the Display

Table 40: Measurements for all modulation types except nFSK, C4FM, OQPSK and SOQPSK

Measurement	Description
EVM	The normalized RMS value of the error vector between the measured signal and the ideal reference signal over the analysis length. The EVM is generally measured on symbol or chip instants and is reported in units of percent and dB. EVM is usually measured after best-fit estimates of the frequency error and a fixed phase offset have been removed. These estimates are made over the analysis length. Displays RMS and Peak values with location of Peak value.

Table continued...

Measurement	Description
Phase Error	The RMS phase difference between the measured signal and the ideal reference signal. Displays RMS and Peak values with location of Peak value.
Mag Error	The RMS magnitude difference between the measured signal and the reference signal magnitude. Displays RMS and Peak values with location of Peak value.
MER (RMS)	The MER is defined as the ratio of I/Q signal power to I/Q noise power; the result is indicated in dB.
IQ Origin Offset	The magnitude of the DC offset of the signal measured at the symbol times. It indicates the magnitude of the carrier feed-through signal.
Frequency Error	The frequency difference between the measured carrier frequency of the signal and the user-selected center frequency of the instrument.
Gain Imbalance	The gain difference between the I and Q channels in the signal generation path. Constellations with gain imbalance show a pattern with a width that is different from height.
Quadrature Error	The orthogonal error between the I and Q channels. The error shows the phase difference between I and Q channels away from the ideal 90 degrees expected from the perfect I/Q modulation. Not valid for BPSK modulation type.
Rho	The normalized correlated power of the measured signal and the ideal reference signal. Like EVM, Rho is a measure of modulation quality. The value of Rho is less than 1 in all practical cases and is equal to 1 for a perfect signal measured in a perfect receiver.

Table 41: Measurements for OQPSK and SOQPSK modulation types

Measurement	Description
EVM	The normalized RMS value of the error vector between the measured signal and the ideal reference signal over the analysis length. The EVM is generally measured on symbol or chip instants and is reported in units of percent and dB. EVM is usually measured after best-fit estimates of the frequency error and a fixed phase offset have been removed. These estimates are made over the analysis length. Displays RMS and Peak values with location of Peak value.
Offset EVM	Offset EVM is like EVM except for a difference in the time alignment of the I and Q samples. For EVM, I and Q samples are collected at the same time, for every symbol decision point (twice the symbol rate for offset modulations). For Offset EVM, the I and Q symbol decision points are time-aligned before collecting the I and Q samples. In this case, one I and one Q sample is collected for each symbol (half as many samples as the same number of symbols for (non-offset) EVM).
Phase Error	The RMS phase difference between the measured signal and the ideal reference signal. Displays RMS and Peak values with location of Peak value.
Mag Error	The RMS magnitude difference between the measured signal and the reference signal magnitude. Displays RMS and Peak values with location of Peak value.
MER (RMS)	The MER is defined as the ratio of I/Q signal power to I/Q noise power; the result is indicated in dB.

Table continued...

Measurement	Description
IQ Origin Offset	The magnitude of the DC offset of the signal measured at the symbol times. It indicates the magnitude of the carrier feed-through signal.
Frequency Error	The frequency difference between the measured carrier frequency of the signal and the user-selected center frequency of the instrument.
Gain Imbalance	The gain difference between the I and Q channels in the signal generation path. Constellations with gain imbalance show a pattern with a width that is different from height.
Quadrature Error	The orthogonal error between the I and Q channels. The error shows the phase difference between I and Q channels away from the ideal 90 degrees expected from the perfect I/Q modulation. Not valid for BPSK modulation type.
Rho	The normalized correlated power of the measured signal and the ideal reference signal. Like EVM, Rho is a measure of modulation quality. The value of Rho is less than 1 in all practical cases and is equal to 1 for a perfect signal measured in a perfect receiver.

Table 42: Measurements for nFSK modulation types

Measurement	Description
Peak FSK err	Peak value of the frequency deviation error at the symbol point.
RMS FSK Err	RMS value of the frequency deviation error at the symbol point.
Peak Mag Err	The Peak magnitude difference between the measured signal and the reference signal magnitude.
RMS Mag Err	The RMS magnitude difference between the measured signal and the reference signal magnitude.
Freq Error	The frequency difference between the measured carrier frequency of the signal and the user-selected center frequency of the instrument.
Freq Deviation	Frequency distance from the center frequency at the symbol point.
Symbol Rate Error	This compares the user-entered symbol rate to the instrument calculated symbol rate of the analyzed signal.
Symbol Rate	When in Auto-symbol rate, the instrument calculates the symbol rate of the signal and the instrument calculates the error between the user entered value and the instrument calculated value.

Table 43: Measurements for C4FM modulation type

Measurement	Description
RMS Error Magnitude	RMS value of the frequency deviation error at the symbol point.
Carrier Frequency Error	Frequency difference between averaged signal frequency and the center frequency.
Deviation	Frequency distance from the center frequency at the symbol point.
Length	Number of symbols in the analysis area.

Changing the Signal Quality Display Settings

Signal Quality Settings

Main menu bar: Setup > Settings



The Setup settings for Signal Quality are accessible only when the Signal Quality display is selected.



Note: You might be able to save time configuring the Signal Quality display by pressing the Standard Settings button from the Settings control panel. This allows you to select a preset optimized for a standard from the Select Standard dialog box. See [Standard Settings Button](#) on page 694

Settings tab	Description
Modulation Params Tab on page 695	The Modulation tab specifies the type of modulation used for the input signal and other parameters.
Freq & BW Equalizer Tab on page 701	Specifies settings for frequency error, measurement BW and Frequency Deviation. Each of these settings is set internally when set to Auto. Alternatively, you can specify values appropriate for specific measurement needs.
Advanced Params Tab on page 703	The Advanced Params tab specifies frequency offset, magnitude normalization method and allows you to swap the I and Q signals.
Find Tab on page 706	Find tab is used to set parameters for finding bursts within the data record.
Analysis Time Tab on page 707	The Analysis Time tab contains parameters that define the portion of the acquisition record that is used for analysis.
Prefs Tab on page 711	The Prefs tab enables you to set characteristics of the measurement display.

	RMS	Peak	Location
EVM:	1.853 %	3.961 %	109.00
	-34.643 dB	-28.044 dB	
Phase Error:	1.035 °	4.042 °	292.00
Mag Error:	1.500 %	3.448 %	360.00
MER (RMS):	34.643 dB	Rho:	0.999656
IQ Origin Offset:	-56.173 dB	Frequency Error:	667.9 Hz
Gain Imbalance:	-0.001 dB	Quadrature Error:	0.110 °

Using Markers

Markers are indicators in the display that you can position on a trace to measure values such as frequency, power, and time. A Marker always displays its position and, if the Delta readout is enabled, will display the difference between its position and that of the Marker Reference. Within the Symbol Table, colored cells indicate the location of markers. The selected Marker is highlighted with a light green background. All other markers are highlighted with a light gray background. In the Symbol Table, the marker readout below the table shows the marker location in time, symbol numbers and symbol value.

[Changing the Symbol Table Display Settings](#)

Symbol Table Settings

Main menu bar: **Setup > Settings**



The Setup settings for the Symbol Table view are shown in the following table.



Note: You might be able to save time configuring the Symbol Table display by pressing the Standard Settings button from the Settings control panel. This allows you to select a preset optimized for a standard from the Select Standard dialog box. See [Standard Settings Button](#) on page 694

Settings tab	Description
Modulation Params Tab on page 695	The Modulation tab specifies the type of modulation used for the input signal and other parameters.
Freq & BW	Specifies settings for frequency error, measurement BW and Frequency Deviation. Each of these settings is set internally when set to Auto. Alternatively, you can specify values appropriate for specific measurement needs.
Equalizer Tab on page 701	Enable the Equalizer and adjust its parameters.
Advanced Params Tab on page 703	The Advanced Params tab specifies additional parameters.
Find Tab on page 706	Find tab is used to set parameters for finding bursts within the data record.
Analysis Time Tab on page 707	The Analysis Time tab contains parameters that define the portion of the acquisition record that is used for analysis.
Prefs Tab on page 711	The Prefs tab enables you to set characteristics of the measurement display.

Trellis Diagram Display

To show an Trellis Diagram display:

1. Recall an appropriate acquisition data file.
2. Press the **Displays** button or select **Setup > Displays**. This shows the **Select Displays** dialog box.
3. Select the **Source(s)** from drop-down list.
4. From the **Measurements** box, select **GP Digital Modulation**.
5. Double-click the **Trellis Diagram** icon in the **Available Displays** box. This adds the Trellis Diagram icon to the **Selected displays** box.
6. Click the **OK** button. This displays the Trellis Diagram view.
7. Press the **Replay** button to take measurements on the recalled acquisition data file.

Elements of the Display

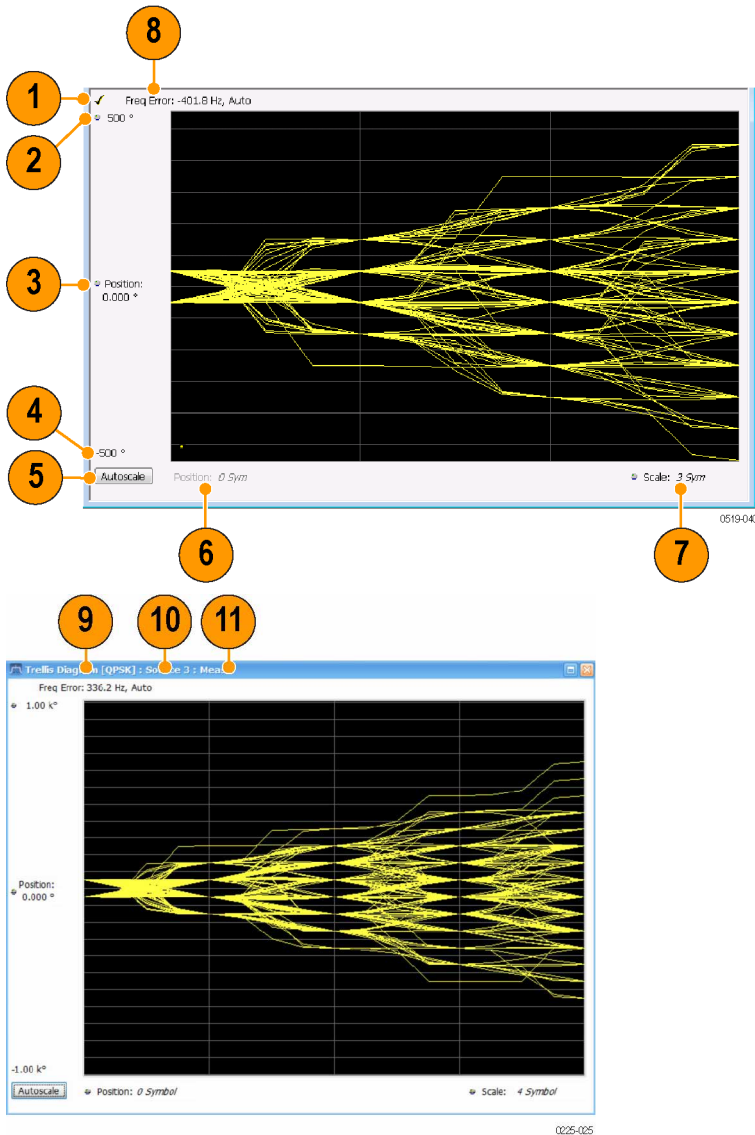

Item	Element	Description
1	Check mark indicator	The check mark indicator in the upper, left-hand corner of the display shows when the Frequency Deviation vs Time display is the optimized display. Note: When <i>Best for multiple windows</i> is selected in the Amplitude control panel's RF & IF Optimization control, none of the measurement displays shows a checkmark, as there is not a single optimized measurement.
2	Top of Graph	Sets the phase value indicated at the top of the graph. Changing the top value affects the bottom of graph readout. Also, note that the top of graph setting interacts with the internal vertical scale setting (which is not user settable) such that the range between the top and bottom of the graph increases or decreases automatically.
3	Position	Specifies the phase value shown at the center of the graph display.
4	Bottom Readout	Displays the value of the phase value shown at the bottom of graph.

Table continued...

Item	Element	Description
5	Autoscale	Adjusts the vertical and horizontal settings to provide the best display.
6	Position	Displays the horizontal position of the trace on the graph display.
7	Scale	Adjusts the span of the graph in symbols.
8	Freq Error	Displays the difference between the maximum and minimum measured values of the signal frequency during the Measurement Time. The displayed frequency error is followed by either Auto or Manual . This indicates the selected carrier frequency detection method (see Settings > Freq & BW).
9	Modulation type	Modulation type configured for the selected source.
10	Source	Source corresponding to selected display.
11	Measurement Instance number	Represents the instance of measurement display created.

Changing the Trellis Diagram Settings

Trellis Diagram Settings

Main menu bar: **Setup > Settings**



The settings for the Trellis Diagram display are shown in the following table.



Note: You might be able to save time configuring the Trellis Diagram display by pressing the Standard Settings button from the Settings control panel. This allows you to select a preset optimized for a standard from the Select Standard dialog box. See [Standard Settings Button](#) on page 694

Settings tab	Description
Modulation Params Tab on page 695	Specifies the type of modulation used for the input signal and other parameters.
Freq & BW Equalizer Tab on page 701	Specifies settings for frequency error, measurement BW and Frequency Deviation. Each of these settings is set internally when set to Auto. Alternatively, you can specify values appropriate for specific measurement needs.
Advanced Params Tab on page 703	Specifies additional parameters.
Find Tab on page 706	Used to set parameters for finding a burst within the data record and for entering a Synch word.
Analysis Time Tab on page 707	Contains parameters that define the portion of the acquisition record that is used for analysis. Also allows you to specify the Units (Seconds or Symbols) for the GP Digital Modulation displays.
Trace Tab on page 708	Allows you to set the trace display characteristics.
Scale Tab on page 710	Specifies the horizontal and vertical scale settings.

Table continued...

Settings tab	Description
Prefs Tab on page 711	Enables you to set characteristics of the measurement display.

GP Digital Modulation Shared Measurement Settings

The displays in the GP Digital Modulation folder (Setup > Displays) are each a different format for presenting the results of a single underlying analysis. For this reason, all controls that affect the analysis parameters are shared by all the displays in the GP Digital Modulation folder.

Changing a setting on one tab changes that setting for all the GP Digital Modulation displays. For example, if you change the Modulation Type for the Constellation Display, it also changes the Modulation type setting for the Signal Quality display. There are some controls that affect only the way an individual display presents its results, such as graph scaling.

Table 44: Common controls for GP digital modulation displays

Settings tab	Description
Modulation Params Tab on page 695	Specifies the type of modulation, symbol rate, and filters to be used in demodulating the input signal.
Freq & BW	Sets values for frequency error/offset, measurement bandwidth, and frequency deviation (not every control is present for every modulation type).
Equalizer Tab on page 701	Enable the Equalizer and adjust its parameters.
Advanced Params Tab on page 703	Specifies additional parameters that are less frequently used.
Find Tab on page 706	Used to set parameters for finding a burst within the data record and for entering a Synch word.
Analysis Time Tab on page 707	Contains parameters that define the portion of the acquisition record that is used for analysis. Also allows you to specify the Units (Seconds or Symbols) for the GP Digital Modulation displays.
Trace Tab on page 708	Allows you to set the trace display characteristics.
Prefs Tab on page 711	Enables you to set characteristics of the measurement display.

Source Selection

Source can be changed for selected measurements from Settings control panel using Source drop-down. The number of sources depends on the number of sources connected to the instrument.



Note: The measurement source cannot be changed to the source which is available for other measurement. Acquisition must be stopped in order to change source.

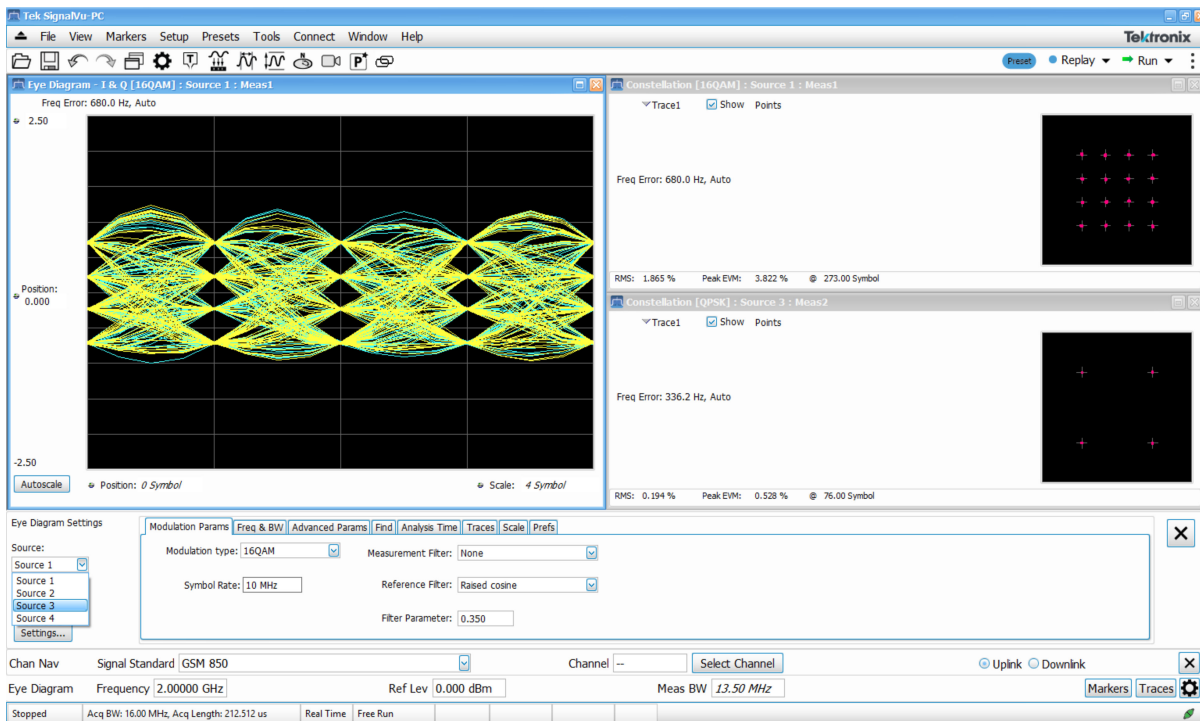
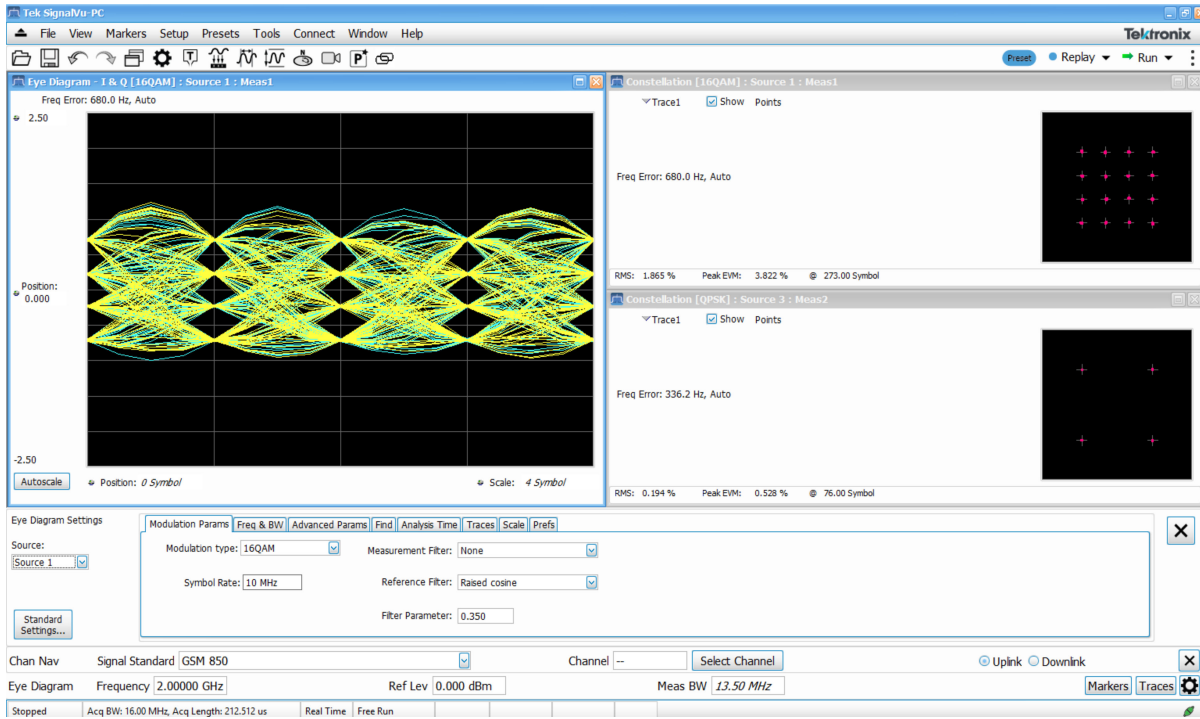

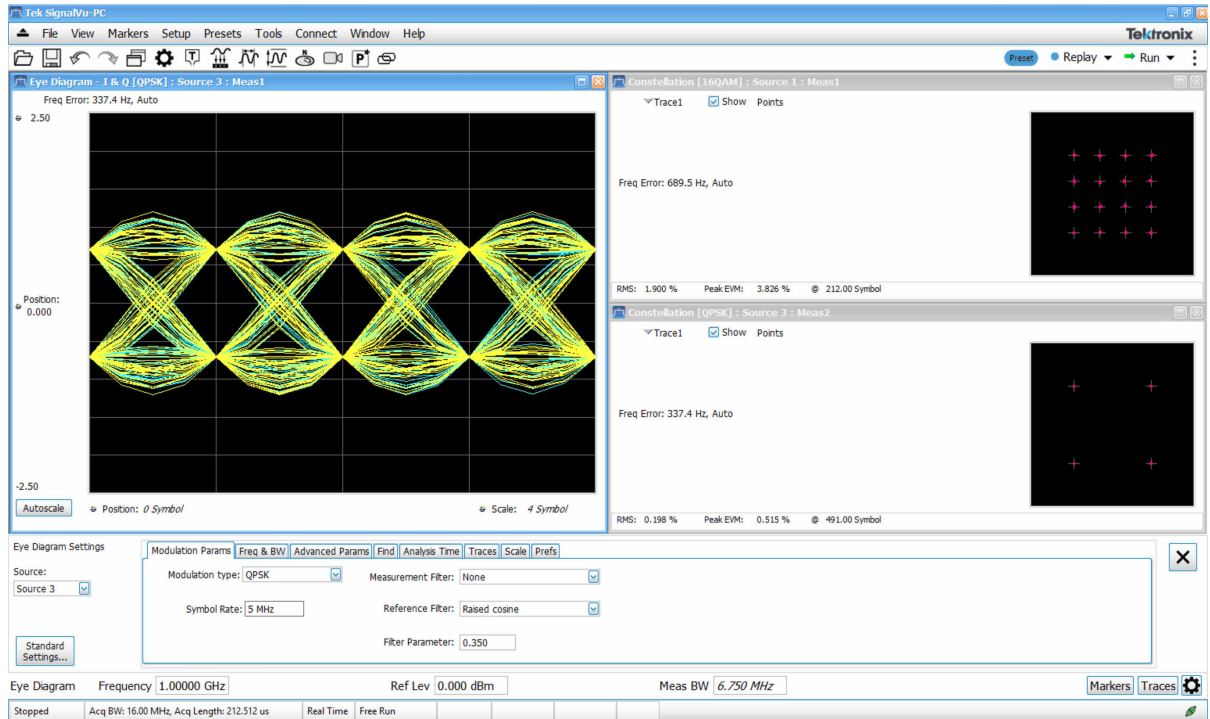

Standard Settings Button

On every GP Digital Modulation control panel there is a button labeled **Standard Settings**. This button is used to recall settings optimized for analyzing the selected standard. See the following table for a list of the standards for which standard settings are available. Choosing a standard from the dialog box changes only settings for GP Digital Modulation displays.

All of the presets in the Standard Settings Dialog make the following settings:

- Analysis Length: Auto
- Points per Symbol: 4
- Data Differential: No
- Burst Mode: Off
- Burst Detection Threshold: -10 dBc

Table 45: Parameter values set by presets in the standard settings dialog

Standard	Modulation	Symbol Rate	Meas. Filter	Reference Filter	Filter Parameter	Other
802.15.4	OQPSK	1e6	None	Half sine	NA	
SBPSK-MIL	SBPSK	2.4e3	None	SBPSK-MIL	NA	
SOQPSK-MIL	SOQPSK	2.4e3	None	SOQPSK-MIL	NA	6
CPM-MIL	CPM	19.2e3	None	None	NA	

Table continued...

⁶ Center Symbol Position, Half Shift Removed

Standard	Modulation	Symbol Rate	Meas. Filter	Reference Filter	Filter Parameter	Other
SOQPSK-ARTM Tier 1	SOQPSK	2.5e6	None	SOQPSK-ARTM	NA	6
Project25 Phase 1	C4FM	4.8e3	C4FM-P25	RC	0.2	
CDMA2000–Base	QPSK	1.2288e6	IS-95 TXEQ_MEA	IS-95 REF	NA	
W-CDMA	QPSK	3.84e6	RRC	RC	0.22	

Modulation Params Tab

Menu bar: Setup > Settings > Modulation Params

The Modulation Params tab specifies the type of modulation on the input signal and other parameters that control the demodulation of the input signal.

Parameter	Description
Modulation type	Specifies the type of modulation on the input signal.
Symbol Rate	Specifies the symbol rate in Hertz.
Measurement Filter	Specifies the filter used for measurements.
Reference Filter	Specifies the filter used as a reference.
Filter Parameter	Enter a value used for defining the Reference Filter. (Not present for some filter types)
Modulation index	(Present only for CPM modulation type)

Modulation Type

The modulation types that can be demodulated and analyzed are:

Modulation type	Description
QPSK	Quadrature Phase Shift Keying
8PSK	8-Phase Shift Keying
D8PSK	Differential Eight Phase Shift Keying
D16PSK	Differential Sixteen Phase Shift Keying
PI/2DBPSK	PI/2 Differential Binary Phase Shift Keying

Table continued...

Modulation type	Description
DQPSK	Differential Quadrature Phase Shift Keying
PI/4DQPSK	Pi/4 Differential Quadrature Phase Shift Keying
BPSK	Binary Phase Shift Keying
OQPSK	Offset Quadrature Phase Shift Keying
16QAM	16-state Quadrature Amplitude Modulation
32QAM	32-state Quadrature Amplitude Modulation
64QAM	64-state Quadrature Amplitude Modulation
128QAM	128-state Quadrature Amplitude Modulation
256QAM	256-state Quadrature Amplitude Modulation
1024QAM	1024-state Quadrature Amplitude Modulation
MSK	Minimum Shift Keying
2FSK	2-Frequency Shift Keying
4FSK	4-Frequency Shift Keying
8FSK	8-Frequency Shift Keying
16FSK	16-Frequency Shift Keying
CPM	Continuous Phase Modulation
SOQPSK	Shaped Offset Quadrature Phase Shift Keying
SBPSK	Shaped Binary Phase Shift Keying
C4FM	Constant Envelope 4-Level Frequency Modulation
16APSK	16-symbol Amplitude Phase Shift Keying
32APSK	32-symbol Amplitude Phase Shift Keying



Note: The modulation type of a particular source can also be seen at the top of GP Demod measurement window.

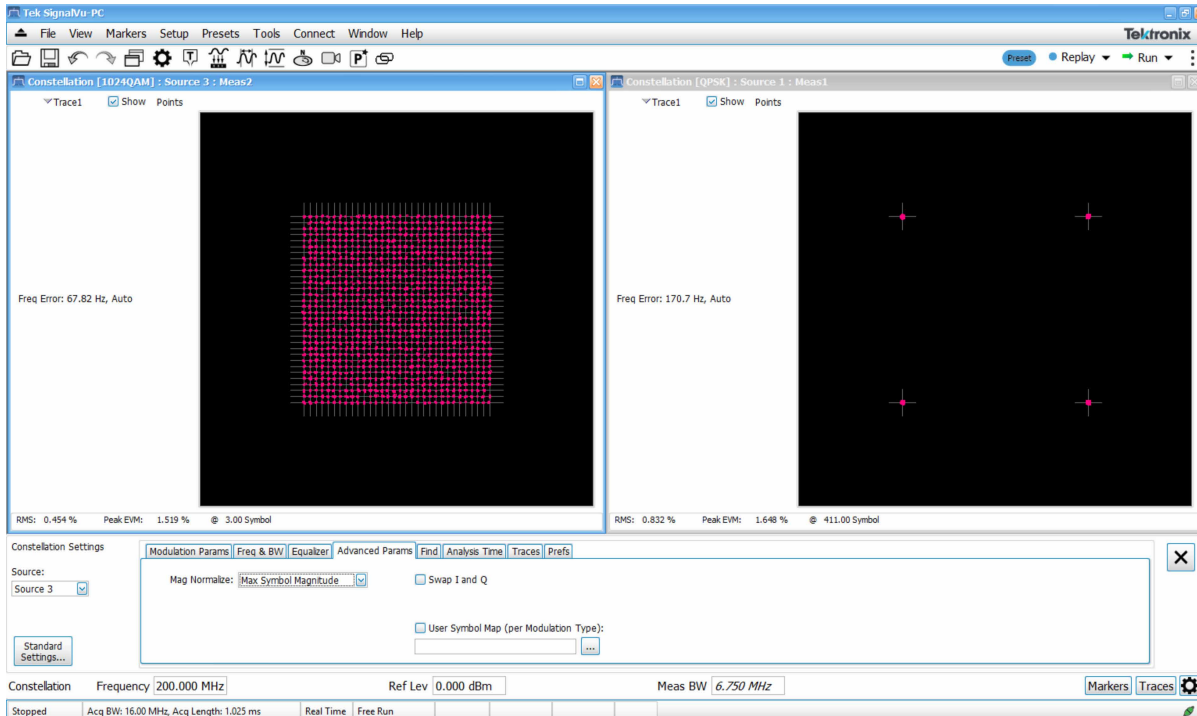

Symbol Rate

Specifies the symbol rate for demodulating digitally modulated signals. The symbol rate and the bit rate are related as follows:

$$(\text{Symbol rate}) = (\text{Bit rate}) / (\text{Number of bits per symbol})$$

For example, the number of bits per symbol is 3 for 8PSK.

Measurement and Reference Filters

The available measurement and reference filters depend on the selected modulation type. If a particular filter is not practical for a selected modulation type, it is not presented as an available filter. To determine which filters are available, make certain that your desired modulation type is selected. See the following table.

Modulation type	Measurement filters	Reference filters
BPSK	None	None
PI/2DBPSK	RootRaisedCosine	RaisedCosine
8PSK	RaisedCosine	Gaussian
D8PSK	Gaussian	User
DQPSK	User	Rectangular (freq)
PI/4DQPSK	Rectangular (freq)	IS-95REF
16QAM	IS-95TX_MEA	
32QAM	IS-95TXEQ_MEA	
64QAM		
128QAM		
256QAM		
1024QAM		
QPSK		
16APSK		
32APSK		
MSK	None Root Raised Cosine RaisedCosine Gaussian User Rectangular (freq)	None Gaussian User
OQPSK	None RootRaisedCosine User IS-95TX_MEA IS-95TXEQ_MEA	None Half sine RaisedCosine User IS-95REF
HDQPSK	HDQPSK-P25	None RaisedCosine Gaussian User Rectangular (freq)
SOQPSK	None User	SOQPSK-MIL SOQPSK-ARTM User

Table continued...

Modulation type	Measurement filters	Reference filters
CPM	None	None
	User	User
2FSK	None	None
4FSK	Gaussian	Gaussian
8FSK	RootRaisedCosine	RaisedCosine
16FSK	RaisedCosine	User
	Rectangular (freq)	
	User	
C4FM	C4FM-P25	RaisedCosine
		User
SBPSK	None	SBPSK-MIL
	User	User

The measurement filter is applied before the demodulation bit is detected and the ideal reference is calculated.

The reference filter is applied to the internally generated ideal reference signal before the EVM is calculated.

Measurement BW

The measurement BW (reported on the Settings > Freq & BW tab) is computed based on the Modulation Type, the Symbol Rate (SR), the Reference Filter type, and the Filter Parameter (alpha). The following table shows the formulas used, where SR= symbol rate, and α = filter parameter.

Modulation type	Measurement filter	Measurement bandwidth
QPSK, 8PSK, D8PSK, DQPSK, PI/4DQPSK, BPSK, PI/2DBPSK, QAM16-256, APSK	Raised Cosine	$SR * (1 + \alpha)$
	None / Rectangular	$SR * 16$
	All others	$SR * 2$
D16PSK	Raised Cosine	$SR * (1.5 + \alpha)$
	None / Rectangular	$SR * 16$
	All others	$SR * 2.5$
OQPSK	Raised Cosine	$SR * 2$
	Half Sine	$SR * 12$
	None / Rectangular	$SR * 16$
	All others	$SR * 2$

Table continued...

Modulation type	Measurement filter	Measurement bandwidth
GMSK	Gaussian	$SR * 12 * \alpha$
	None / Rectangular	$SR * 4$
	All others	$SR * 4$
GFSK, FSKn, C4FM	All	$SR * 8$

How to Select Filters

In a signal transmitter/receiver system, the baseband signal might be filtered for bandwidth limiting or for another kind of necessary shaping that needs to be applied. Normally, a filter in the transmitter (F_t) and a filter in the receiver (F_r) are applied.

The Measurement Filter setting in the analyzer corresponds to the baseband filter in the receiver (F_r): This setting tells the analyzer what filter your receiver uses. When the analyzer is set to the same filter used by the receiver, the analyzer sees the signal as your receiver would. The Measurement Filter setting should be the same as the filter used in the receiver under normal operation (as opposed to testing).

The Reference Filter setting in the analyzer corresponds to the baseband filter in the transmitter-receiver combination ($F_r * F_t$). The baseband filter for the transmitter-receiver combination is often referred to as the *System Filter*. This filter is called the reference filter because it is used to recreate a reference signal that is compared to the received signal. This recreated reference signal is the *ideal signal* with $F_r * F_t$ applied; differences between this *ideal signal* and the received signal enables the determination of signal quality, such as EVM measurements.

The following is an example of a hypothetical signal that is transmitted into a vector signal analyzer for analysis:

Assume that a signal is transmitted using a baseband filter (F_t). It then travels through a transmission medium (air/cable/etc) where it may be affected by the communication channel (F_c). The signal is received and filtered by the receiver's filter (F_r). At this point, the signal has passed through F_t and F_r , and in addition, the communication channel might have affected it (so: $F_t * F_r * F_c$). This double-filtered signal is demodulated as it was received to determine the symbols/bits in it. The obtained bits are used to regenerate a baseband ideal signal that can be compared against the received signal to determine signal quality. However, to determine the effect of the environment on the signal quality, the ideal signal must be filtered by the REFERENCE FILTER ($F_t * F_r$), so that the ideal signal and the filtered signal differ only by the effect of the environment. So, the received signal is the ideal signal filtered by $F_t * F_r * F_c$ and the reference signal is the ideal signal filtered by $F_t * F_r$, since they only differ by the effect of F_c , the comparison will show the effect of the communication channel on the signal. The communication channel can also include the hardware path the signal follows after (Tx) or before (Rx) digitizing; this would account for Tx/Rx hardware linear and non-linear distortion.

Common examples of how these filters are used are shown below:

- For Transmit Filter = Root Raised Cosine (RRC), Measurement Filter = RRC, the Reference Filter = RRC^2 = Raised Cosine
- For Transmit Filter = Raised Cosine (RC), Measurement Filter = None, the Reference Filter = Raised Cosine (When the Measurement Filter = None, the Reference Filter = Transmit Filter)
- For Transmit Filter = Gaussian, Measurement Filter = None, the Reference Filter = Gaussian

Filter Parameter

The filter parameter specifies the alpha for the Root Raised Cosine or Raised Cosine filter, or the bandwidth-time product (BT) for the Gaussian filter, when selected as the Reference filter. Some filter types have a fixed parameter value that is specified by industry standard, while other filter types by definition have no filter parameter. For filter types with no filter parameter, there is no filter parameter control present in the control panel.

Freq & BW Tab

The Freq & BW tab specifies a group of settings that affect how measurements are made.

Modulation Params | **Freq & BW** | Advanced Params | Find | Analysis Time | Trace | Scale | Prefs

Frequency Error: Auto

Measurement BW: ▾

Frequency Deviation: Auto

Figure 107: Freq & BW tab with nFSK or C4FM modulation type selected and Frequency Error readout enabled (Auto selected)

Modulation Params | **Freq & BW** | Advanced Params | Find | Analysis Time | Trace | Scale | Prefs

Frequency Error: Auto

Measurement BW: ▾

Figure 108: Freq & BW tab with SOQPSK modulation type selected and Frequency Offset enabled (Auto deselected)

Setting	Description
Frequency Error / Frequency Offset	When Auto is enabled, this readout displays frequency error and the measurement is made at the calculated frequency. When Auto is disabled, this setting changes to Frequency Offset. When set to Frequency Offset, this setting is used to demodulate a signal that is not at the center frequency. The measurement is made at the user-entered offset. The Measurement Filter (if any, specified on the Modulation Params tab) is applied about the offset frequency whether set automatically or manually.
Measurement BW	This setting allows you to override the automatic bandwidth calculation and directly enter a bandwidth value. If you enter a value for the measurement bandwidth, be aware that the actual bandwidth of data provided to the measurement will be at least as wide as the value you request and may be as much as two times wider than requested. This override of the selected measurement bandwidth is done so that the instrument uses sufficient bandwidth relative to the chosen symbol rate to ensure good signal quality measurements.
Frequency Deviation	For nFSK modulation types, this setting specifies the frequency deviation. Select Auto to make the instrument do this automatically. Deselect Auto to enter a value manually. This setting is present for only nFSK and C4FM modulation types.

Equalizer Tab

The Equalizer tab enables you to apply an adaptive equalizer to a digitally modulated signal to compensate for linear distortions in the signal. The Equalizer is available only for displays in the GP Digital Modulation folder (Select Displays window). The analyzer implements a decision directed, feed-forward FIR filter to correct linear distortion in the input signal.

Modulation Params	Freq & BW	Equalizer	Advanced Params	Find	Analysis Time	Trace	Scale	Prefs
<input type="checkbox"/> Enable Equalization	Mode: <input type="text" value="Train"/>	Taps/Symbol: <input type="text" value="2"/>						
<input type="button" value="Reset Equalization"/>	Convergence: <input type="text" value="0.0005"/>	Taps: <input type="text" value="41"/>						
<input checked="" type="checkbox"/> Enable EQ Export	Length: <input type="text" value="21 Symbol"/>							

Parameter	Description
Enable Equalization	This setting turns the Equalizer on and off.
Reset Equalization	Initializes the equalizer filter for training.
Enable EQ Export	Exports a text file with equalizer taps in I/Q pairs.
Mode	Specifies whether the equalizer is in learning (Train) mode or analysis (Hold) mode.
Convergence	Specifies the update rate. Maximum value: 0.002. Default value: 0.0005
Taps/Symbol	The number of filter coefficients per symbol used by the filter. Available choices are 1, 2, 4, and 8.
Taps	The number of filter coefficients. Range: 3 to 100 (you can set a higher number, but 100 is the practical limit).
Length	Specifies the number of symbols analyzed (or filter length).

Selecting the Mode

When enabled, the Equalizer is in either Train mode or Hold mode. When the equalizer is in Train mode, it will update internal filter parameters whenever you adjust the Convergence, Taps/Symbol, Taps, or Length values. When it is in Hold mode, the Equalizer uses the parameter values (both internal and the values accessible on the Equalizer tab) in effect when it was placed into Hold mode.



Note: The Equalizer does not need to be retrained if the modulation type is changed. You can train the Equalizer by using a simpler modulation type (such as QPSK), place the Equalizer into Hold mode and can then measure more complex modulation types such as QAM.

Training the Equalizer

To obtain the desired results using the Equalizer, you must first train the Equalizer. This is an iterative process where you adjust some filter parameters (and the analyzer adjusts internal parameters) to achieve the lowest error possible on the acquired signal.

To configure the Equalizer:

1. Press the **Displays** button or select **Setup > Displays**.
2. In the **Select Displays** window, select **GP Digital Modulation** from **Measurements**.
3. Add **Signal Quality** to the **Selected Displays** and select **OK**.
4. With the Signal Quality display selected, select **Setup > Settings**.
5. Select the **Modulation Params** tab set the parameters as necessary for the signal.
6. Select the **Equalizer** tab.
7. Set the **Convergence** value to 0.0005.
8. Set **Taps/Symbol** to 2.

9. Click the **Reset Equalization** button to reset the equalizer.
10. Set the **Mode** to **Train**.
11. Click **Enable Equalization** so it is checked.
12. On the Signal Quality display, examine the value for EVM.
13. Change the Convergence, Taps/Symbol, and Taps values iteratively to achieve a minimum EVM value.



Note: Changing the Taps/symbol or Taps values resets the equalizer.

Using the Equalizer

To use the equalizer:

1. Select and configure a **GP Digital Modulation** display.
2. Select **Setup > Settings**.
3. Select the **Equalizer** tab.
4. Select **Enable Equalization** so it is checked.
5. Verify that Mode is set to **Hold** if you have previously trained the Equalizer. If you have not previously trained the Equalizer, [Training the Equalizer](#) on page 702 and then set the Mode to Hold.

Exporting EQ Files

If the **Enable EQ Export** box is checked, the following outputs files are automatically generated to these locations after each measurement update cycle if the EQ coefficients change: *c:\temp\EqTaps.txt* and *c:\temp\EqTapsHdr.txt*. These files have EQ taps in I/Q pairs (one pair per row).

The *Hdr* version file has a five line header before the EQ tap data. Each line in the five line header of the Hdr version file has two data values, with the second one always being "0":

```
<line1>Number_of_Header_Lines 0
<line2>EQ_Sample_Rate_Hz 0
<line3>Demod_Symbol_Rate_Sps 0
<line4>EQ_Samples_per_Symbol 0
<line5>Number_of_EQ_Taps_Following 0
```

Exporting EQ Files

Advanced Params Tab

The Advanced Params tab specifies additional parameters that control the demodulation of the signal.

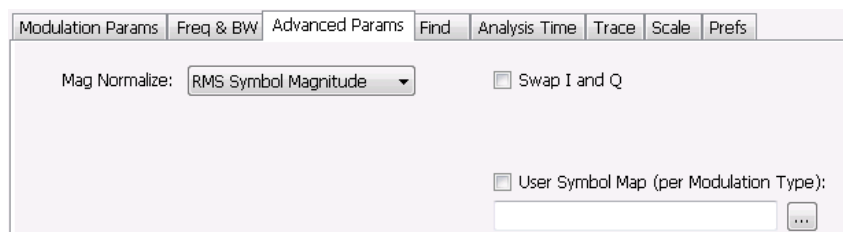

Figure 109: Advanced Params tab for all modulation types except nFSK and C4FM

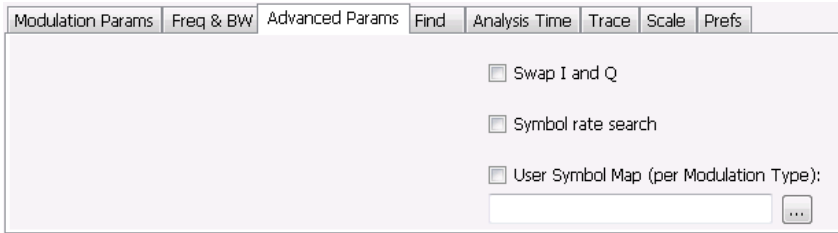

Figure 110: Advanced Params tab for modulation type nFSK

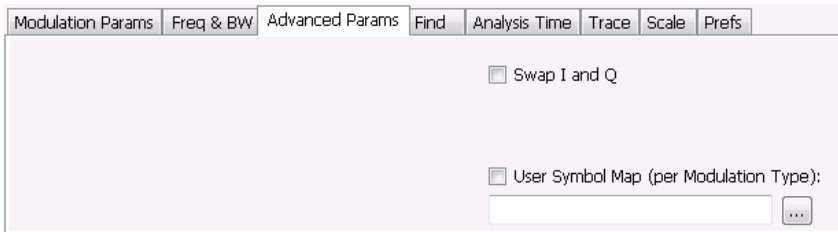

Figure 111: Advanced Params tab for modulation type C4FM

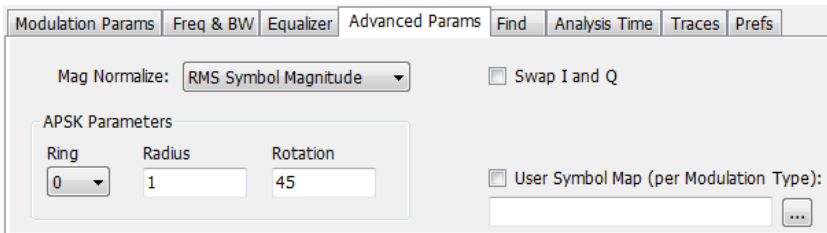

Figure 112: Advanced Params tab for modulation type APSK

Parameter	Description
Mag Normalize (not present for nFSK or C4FM modulation types)	Select RMS Symbol Magnitude or Max Symbol Magnitude. This setting applies to Mag Error and EVM.
Swap I and Q	When enabled, the I and Q data are exchanged before demodulating.
APSK Parameters (Present only for APSK modulation types)	Sets Constellation display parameters for APSK modulation types.
Symbol rate search (Present only for nFSK modulation types)	Determines whether to automatically detect or manually set the symbol rate. When selected, automatically detects the symbol rate to perform analysis. The calculated symbol rate is displayed in the Signal Quality display. The Symbol Rate Error is also calculated and displayed when Symbol rate search is enabled.
User Symbol Map (per Modulation Type)	Enables the use of custom symbol maps. This enables you to specify the location of symbols in the display. This control can be set independently for each of the modulation types.

Mag Normalize

Specifies whether Magnitude Normalization uses the RMS Symbol Magnitude or the Maximum Symbol Magnitude as the basis for normalization. Use RMS Symbol Magnitude on QPSK modulations (equal magnitude symbol locations), and use Maximum Symbol Magnitude for signals that have a large difference in magnitude among the symbol locations (such as 128QAM). It prevents the instrument

from using the very low magnitude center symbols when normalizing the constellation. The outer symbols are a better normalization reference than the center in this case.

Swap I and Q

Use the Swap I and Q control to correct a signal sourced by a downconverter that inverts the frequency of the signal under test.

APSK Parameters

Three parameters can be set for Constellation display of APSK modulation types.

Parameter	Description
Ring	Use to select which ring the radius and rotation values are being specified for. Values are 0 and 1 for 16APSK. 0, 1, and 2 for 32APSK.
Radius	Sets the Ring ratio relative to Ring 0 (inner most ring). Set after selecting the appropriate Ring setting.
Rotation	Sets the rotation value from the I axis. Set after selecting the appropriate Ring setting.

User Symbol Map

A User Symbol Map is a text file that specifies the location of symbols in the display. The symbol map is unique for each modulation type. The easiest way to create a custom symbol map is to start with the default symbol map and modify it. The default symbol map file is located at C:\SignalVu-PC\ExampleFiles. The default symbol map file is named **DefaultSymbolMaps.txt**. See [Symbol Maps](#) on page 712 for illustrations of the default symbol mapping.

To specify a user symbol map:

1. Click the ... button.
2. Navigate to the directory containing the user symbol text file you want to use.
3. Select the desired file in the Open window and click **Open**.
4. Select **User Symbol Map** to enable the user symbol map.

Editing the User Symbol Map. The symbol map is a plain text file and can be edited with any plain text editor.



CAUTION: Whenever you reinstall the program software, the existing DefaultSymbolMaps.txt file will be overwritten. To create a custom symbol map, you should make a copy of the default symbol map file, edit the copy to suit your needs, and save it with a new name. Guidance on how to edit the symbol map file is contained within the default symbol map file.

The following excerpt from the default symbol map file explains the structure of the file and how to edit it.

```
## Symbol Mapping Definitions
## Version 1.2
## This file defines the mapping of modulation states to symbol values.
##
## File Format :
## -----
## 1. Comments begin with '##' and may appear after the last field in a line
## 2. A symbol map begins and ends with a line containing the name of the
## modulation type. These names must exactly match the name of one of the
```

```
## modulation types in the RSA software
## 3. Empty cells may be included to preserve the constellation shape.
## 4. Blank lines are ignored.
## 5. A modulation type which does not match the name of an existing
## type will be ignored.
##
## Usage :
## -----
## 1. The file is intended to be edited with Notepad or similar text editor
```

The following text is an example of a symbol map.

```
## Symbol Map for 32 QAM
## (Resembles the shape of the constellation)
          32QAM
00011 00010 00001 00000
01001 01000 00111 00110 00101 00100
01111 01110 01101 01100 01011 01010
10101 10100 10011 10010 10001 10000
11011 11010 11001 11000 10111 10110
          11111 11110 11101 11100
          32QAM
```

Find Tab

The Find tab is used to set parameters for finding bursts within the data record. This is a post-acquisition operation. Synch Word search controls are also on this tab.

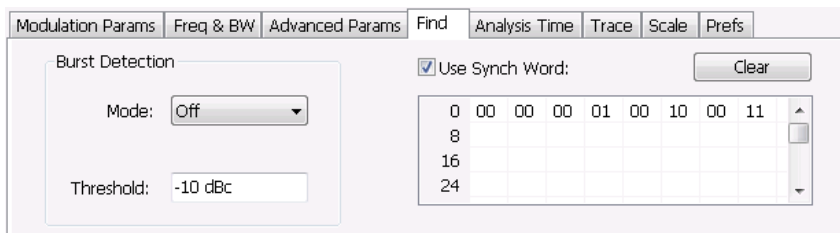

Setting	Description
Burst Detection: Mode	Select whether to analyze bursts - Auto: If a burst is found, analyze just that burst period. If a burst is not found, analyze the whole analysis length. - On: If a burst is found, analyze just that burst period. If a burst is not found, display an error message. - Off: Analyze the whole analysis length. If the signal isn't adequate for demodulation, an error message is shown.
Burst Detection: Threshold	Sets the level required for the signal to qualify as a burst. Enter a value in dBc down from top of the signal.
Use Synch Word	When enabled, specifies the string of symbols to look for. Enter the search string with external keyboard or the on-screen keyboard.
Clear	Blanks the search string field.

Analysis Time Tab

The Analysis Time tab contains parameters that define how the signal is analyzed in the general purpose digital modulation displays.

Modulation Params | Freq & BW | Equalizer | Advanced Params | Find | **Analysis Time** | Trace | Scale | Prefs

Analysis Offset: Auto Time Zero Reference:

Analysis Length: Auto Units:

Actual: 128 Sym

The settings values on this tab are the same as those on the main Analysis control panel for the instrument with the only difference being that Analysis Length can be set in either Seconds or Symbols in this location.

Setting	Description
Analysis Offset	Specifies the location of the first time sample to use in measurements.
Auto	When enabled, causes the instrument to set the Analysis Offset value based on the requirements of the selected display.
Analysis Length	Specifies the length of the analysis period to use in measurements. Length is specified in either seconds or symbols, depending on the Units setting. For most modulation types, the Analysis Length set when Auto is enabled is 128 symbols. For some modulation types, a longer length is used.
Auto	When enabled, causes the instrument to set the Analysis Length value based on the requirements of the selected display.

Table continued...

Setting	Description
Time Zero Reference	Specifies the zero point for the analysis time.
Actual	This is a displayed value, not a setting. It is the Analysis Length (time or symbols) being used by the analyzer; this value may not match the Analysis Length requested (in manual mode).
Units	Sets the units of the Analysis Length to either Symbols or Seconds.

Analysis Offset

Use analysis offset to specify where measurements begin. Be aware that you cannot set the Analysis Offset outside the range of time covered by the current acquisition data. (all time values are relative to the Time Zero Reference).

You can set the Analysis Length so that the requested analysis period falls partly or entirely outside the current range of acquisition data settings. When the next acquisition is taken, its Acquisition Length will be increased to cover the new Analysis Length, as long as the Sampling controls are set to Auto. If the Sampling parameters are set to manual, or if the instrument is analyzing saved data, the actual analysis length will be constrained by the available data length, but in most cases, measurements are able to be made anyway. The instrument will display a notification when measurement results are computed from less data than requested. Range: 0 to [(end of acquisition) - Analysis Length]. Resolution: 1 effective sample (or symbol).

Analysis Length

Use the analysis length to specify how long a period of time is analyzed by a measurement. As you adjust this value, the actual amount of time for Analysis Length, in Symbol or Seconds units, is shown below the control in the "Actual" readout. This setting is not available when Auto is checked. Range: minimum value depends on modulation type. Resolution: 1 symbol. A maximum of approximately 80,000 samples can be analyzed (the actual value varies with modulation type).

Time Zero Reference

All time values are measured from this point (such as marker position or horizontal position (in Y vs Time displays). Choices are: Acquisition Start or Trigger.

Parameter	Description
Acquisition Start	Offset is measured from the point at which acquisition begins.
Trigger	Offset is measured from the trigger point.

Trace Tab

Menu Bar: Setup > Settings > Trace

The Trace tab allows you to set the trace display characteristics of the selected display.

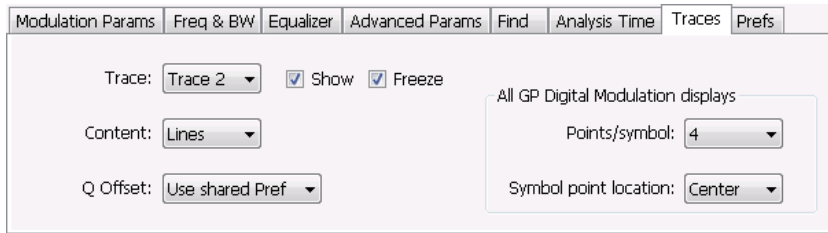

Figure 113: Example traces tab for constellation display set to SOQPSK modulation type

Note that some settings are not present for all modulation types and some settings are not present for all displays.

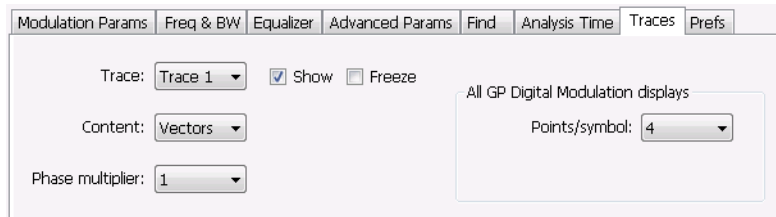

Figure 114: Example trace tab for constellation display set to CPM modulation type

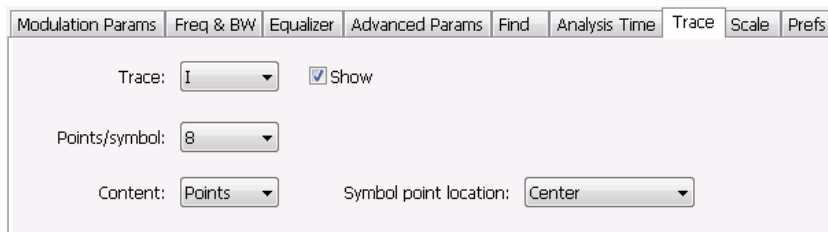

Figure 115: Example trace tab for Demod I&Q display

Setting	Description
Trace	Selects the trace that is hidden or displayed based on whether or not Show is selected.
Show	Specifies whether the trace selected by Trace is displayed or hidden.
Freeze	Halts updates to the trace selected by the Trace setting. Present for the Constellation display only.
Content	Selects whether to display the trace as vectors (points connected by lines), points (symbols only without lines), or lines (lines drawn between symbols, but no symbols are displayed). The choices available depend on the display.
Q Offset	For traces with offset modulation (OQPSK and SOQPSK), this setting enables the trace to be displayed with Q offset or without Q offset. Choices available are Remove Q offset , Include Q Offset , and Use Shared Pref . Selecting Use Shared Pref causes the analyzer to add or remove Q offset according to the Remove Q Offset setting located on the Prefs tab. Setting the Q Offset on the Traces tab changes the Q offset only for the Constellation display. If other GP Digital Modulation displays are shown, they will use the use the Remove Q Offset setting on the Prefs tab regardless of the Q Offset setting on the traces tab for the Constellation display. The Q Offset setting is available only when the modulation type is set to OQPSK or SOQPSK.

Table continued...

Setting	Description
Points/symbol	Select how many points to use between symbols when connecting the dots. Values: 1, 2, 4, 8.
Symbol point location	Selects whether to evaluate the symbol value at the center or the end of the eye opening. This control is only present for some of the supported modulation types.
Phase Multiplier	Sets the multiplication constant for the phase multiplication display: ×1 (default), ×2, ×4, ×8, ×16, or ×32. The phase multiplication display facilitates observation of noisy CPM signals by multiplying measurement signal phase by the constant to reduce the number of phase states and expand the phase difference between adjacent symbols.

Comparing Two Traces in the Constellation Display

When the Constellation display is the selected display, you can use the Traces tab to enable the display of a second trace. The second trace is a version of the current acquisition. You can choose to freeze a trace in order to display the current live trace to an earlier version of itself, you can display the trace as a second trace with or without Q Offset, or you can choose to display both traces frozen in order to compare the trace to itself at different times.

To display a second trace in the Constellation display:

1. If more than one display is present, select the Constellation display to ensure it is the selected display.
2. Click the settings icon or select **Setup > Settings** from the menu bar.
3. Select the **Traces** tab.
4. Select **Trace 2** from the **Trace** drop-down list.
5. Click the **Show** checkbox so that it is checked.
6. Specify the **Content** as desired. Trace 2 lines appear in blue to aid in distinguishing Trace 2 from Trace 1.

Scale Tab

The Scale tab allows you to change the vertical and horizontal scale settings. Changing the scale settings changes how the trace appears on the display but does not change control settings such as Measurement Frequency.



Setting	Description
Vertical	Controls the vertical position and scale of the trace display.
Scale	Changes the vertical scale units.

Table continued...

Setting	Description
Position	Position adjusts the reference level away from top of the graph.
Autoscale	Resets the scale of the vertical axis to contain the complete trace.
Horizontal	Controls the span of the trace display and position of the trace.
Scale	Allows you to, in effect, change the span.
Position	Allows you to pan a zoomed trace without changing the Measurement Frequency. Position is only enabled when the span, as specified by Freq/div, is less than the acquisition bandwidth.
Autoscale	Resets the scale of the horizontal axis to contain the complete trace.
Auto	

A Note About Units

The Units used for the horizontal scale can be either Seconds or Symbols. To set the units for the horizontal scale, display the **Analysis Time** tab. On the tab, select the appropriate units from the **Units** drop-down list.

Prefs Tab

The Prefs tab enables you to change appearance characteristics of the GP Digital Modulation displays.

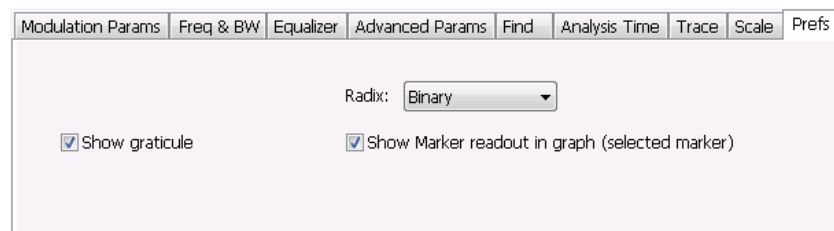

Setting	Description
Show graticule	Shows or hides the graticule.
Show Marker readout in graph (selected marker)	Shows or hides the readout for the selected marker in the graph area.
Radix	Specifies how symbols are displayed in the Symbol Table display and in the Marker readout in the Constellation display.
Remove Q offset	The I and Q data traces are displayed with an offset of half a symbol when the modulation type is set to SOQPSK or OQPSK. You can remove this offset by selecting Remove Q offset . (Which is only present when the modulation type is set to OQPSK or SOQPSK.)

Table continued...

Setting	Description
Show EVM and Offset EVM results	Adds EVM results in the display when enabled (Offset EVM is always displayed). Present only in Signal Quality display and with SOQPSK and OQPSK modulation types only

Symbol Maps

This topic shows the symbol mapping for each digital modulation technique.

QPSK		OQPSK		SOQPSK	
1	3	01	11	01	11
0	2	00	10	00	10

0169-018

8PSK

Left Right

		3		
	2		1	
6				0
	7		4	
		5		

0169-009

BPSK		SBPSK	
1	0	1	0

0169-019

D8PSK	
Phase shift (radians)	Symbol value (binary)
0	000
$\pi/4$	001
$\pi/2$	011
$3\pi/4$	010
π	110
$5\pi/4$	111
$3\pi/2$	101
$7\pi/4$	100

Pi/2 DBPSK	
Phase shift (radians)	Symbol value (binary)
$+\pi/2$	0
$-\pi/2$	1

DQPSK	
Phase shift (radians)	Symbol value (binary)
0	00
$\pi/2$	01
π	11
$3\pi/2$	10

Pi/4 DQPSK	
Phase shift (radians)	Symbol value (binary)
$+\pi/4$	00
$+3\pi/4$	01
$-\pi/4$	10
$-3\pi/4$	11

MSK	
Phase shift direction	Symbol value (binary)
-	0
+	1

16QAM

Left Right

3	2	1	0
7	6	5	4
B	A	9	8
F	E	D	C

0169-010

32QAM

Left Right

	3	2	1	0	
9	8	7	6	5	4
F	E	D	C	B	A
15	14	13	12	11	10
1B	1A	19	18	17	16
	1F	1E	1D	1C	

0169-011

64QAM

Left Right

7	6	5	4	3	2	1	0
F	E	D	C	B	A	9	8
17	16	15	14	13	12	11	10
1F	1E	1D	1C	1B	1A	19	18
27	26	25	24	23	22	21	20
2F	2E	2D	2C	2B	2A	29	28
37	36	35	34	33	32	31	30
3F	3E	3D	3C	3B	3A	39	38

0169-012

128QAM

		5D	5F	4F	4D	1A	1B	0B	0A		
		5C	5E	4E	4C	18	19	09	08		
4A	48	54	56	46	44	10	11	15	14	1C	1D
4B	49	55	57	47	45	12	13	17	16	1E	1F
5B	59	51	53	43	41	02	03	07	06	0E	0F
5A	58	50	52	42	40	00	01	05	04	0C	0D
6D	6C	64	65	61	60	20	22	32	30	38	3A
6F	6E	66	67	63	62	21	23	33	31	39	3B
7F	7E	76	77	73	72	25	27	37	35	29	2B
7D	7C	74	75	71	70	24	26	36	34	28	2A
		68	69	79	78	2C	2E	3E	3C		
		6A	6B	7B	7A	2D	2F	3F	3D		

0169-017

256QAM

Left															Right
EF	FD	EB	F9	E7	F5	E3	F1	0F	3F	4F	7F	8F	BF	CF	FF
CE	DC	CA	D8	C6	D4	C2	D0	0C	3C	4C	7C	8C	BC	CC	FC
AF	BD	AB	B9	A7	B5	A3	B1	0B	3B	4B	7B	8B	BB	CB	FB
8E	9C	8A	98	86	94	82	90	08	38	48	78	88	B8	C8	F8
6F	7D	6B	79	67	75	63	71	07	37	47	77	87	B7	C7	F7
4E	5C	4A	58	46	54	42	50	04	34	44	74	84	B4	C4	F4
2F	3D	2B	39	27	35	23	31	03	33	43	73	83	B3	C3	F3
0E	1C	0A	18	06	14	02	10	00	30	40	70	80	B0	C0	F0
E1	D1	A1	91	61	51	21	11	01	13	05	17	09	1B	0D	1F
E2	D2	A2	92	62	52	22	12	20	32	24	36	28	3A	2C	3E
E5	D5	A5	95	65	55	25	15	41	53	45	57	49	5B	4D	5F
E6	D6	A6	96	66	56	26	16	60	72	64	76	68	7A	6C	7E
E9	D9	A9	99	69	59	29	19	81	93	85	97	89	9B	8D	9F
EA	DA	AA	9A	6A	5A	2A	1A	A0	B2	A4	B6	A8	BA	AC	BE
ED	DD	AD	9D	6D	5D	2D	1D	C1	D3	C5	D7	C9	DB	CD	DF
EE	DE	AE	9E	6E	5E	2E	1E	E0	F2	E4	F6	E8	FA	EC	FE

0169-013

2FSK

Left	Right
0	1

4FSK

Left	Right
0 1 3	2

0169-014

8FSK

Left	Right
0 1 2 3 7 6 5	4

0169-015

16FSK

Left	Right
0 1 2 3 4 5 6 7 15 14 13 12 11 10 9	8

0169-016

C4FM

Left	Right
11 10 00 01	

0169-020

CPM	
Phase shift (h = modulation index)	Symbol value (binary)
-3h	11
-h	10
+h	01
+3h	00

Overview: User Defined Measurement and Reference Filters

The Modulation Parameters control tab for GP Digital Modulation displays enables you to load custom measurement and reference filters. If the existing filters do not meet your requirements, you can create your own filters for use in the measurement and reference settings. This section describes the structure of user filters and provides two examples of customized filters. See [User Filter File Format](#) on page 717.

Loading a User Measurement Filter

To load a your own measurement filter:

1. From the Modulation Params control tab (Settings > Modulation Params), click on the drop-down list for **Measurement Filter**.
2. Select one of the filter names that starts with **User**. This displays the **Manage user filters** window.
3. Enter a name for the filter in one of the **Name (editable)** boxes. This name will appear in the drop-down list on the Modulation Params tab, prefaced with **User**. The maximum number of characters for the filter name is 20.
4. Click the **Browse** button and navigate to the directory containing the filter you want to load. Select the filter and click **Open**. If you wish to use a filter that is not in the list, select **User other** and locate and open the file you wish to use.
5. Click **OK** to load the filter and return to the Modulation Params page.

User Filter File Format

The filter file is selected on the Modulation Params control panel tab used by the GP Digital Modulation displays (Option 21 only). It stores the user-defined measurement or reference filter coefficient data in CSV format. The following figure shows the file structure.

```
# Rate
10
# FilterI,FilterQ
0.97321,0.01947
0.89559,0.04051
0.77497,0.05942
0.62333,0.07202
0.45524,0.07438
0.28614,0.06354
...
0.13045,0.01947
```

Oversampling rate of the filter (samples/symbol)

IQ pairs (1 to 1024) of the filter coefficient in time domain

0169-023

Figure 116: User filter file structure

A filter file is a plain text file, in comma-separated-variable format. The file extension must be CSV.

The filter file contains the following variables:

Rate. Specifies the oversampling rate (the number of samples per symbol). The filter coefficient data will be interpolated by the specified rate.

FilterI,FilterQ. Specifies IQ pairs (1 to 1024) of the filter coefficient in time domain.

Rules for Creating a Filter File

- A line beginning with “#” is a comment line.
- Enter a positive value for the oversampling rate.
- A decimal number can be expressed by fixed point or floating point. For example, 0.01 and 1.0E-2 are both valid.
- “0” (zero) and “,0” (comma zero) can be omitted. For example, “1.5,0”, “1.5,”, and “1.5” are equivalent.
- Lines with only a comma and blank lines are skipped.

Example filters. For your reference, two example filters, Raised Cosine and Gaussian, are shown here. Both filters contain 65 data points with an oversampling rate of 8.

Raised Cosine ($\alpha = 0.3$)			
(Row 1 to 18)	(Row 19 to 36)	(Row 37 to 54)	(Row 55 to 68)
# Rate	0.0383599,0	0.973215,0	0.0743803,0
8	0,0	0.895591,0	0.0720253,0
# FilterI,FilterQ	-0.047715,0	0.774975,0	0.0594205,0
0,0	-0.0984502,0	0.623332,0	0.0405144,0
-0.0062255,0	-0.143898,0	0.455249,0	0.0194761,0
-0.0136498,0	-0.174718,0	0.286147,0	0,0
-0.0209294,0	-0.181776,0	0.130455,0	-0.0151973,0
-0.0263419,0	-0.157502,0	0,0	-0.0246357,0
-0.0280807,0	-0.0971877,0	-0.0971877,0	-0.0280807,0
-0.0246357,0	0,0	-0.157502,0	-0.0263419,0
-0.0151973,0	0.130455,0	-0.181776,0	-0.0209294,0
0,0	0.286147,0	-0.174718,0	-0.0136498,0
0.0194761,0	0.455249,0	-0.143898,0	-0.0062255,0
0.0405144,0	0.623332,0	-0.0984502,0	0,0
0.0594205,0	0.774975,0	-0.047715,0	

Table continued...

Raised Cosine ($\alpha = 0.3$)			
(Row 1 to 18)	(Row 19 to 36)	(Row 37 to 54)	(Row 55 to 68)
0.0720253,0	0.895591,0	0,0	
0.0743803,0	0.973215,0	0.0383599,0	
0.063548,0	1,0	0.063548,0	

Gaussian (BT = 0.5)			
(Row 1 to 18)	(Row 19 to 36)	(Row 37 to 54)	(Row 55 to 68)
# Rate	0.00191127,0	0.978572,0	0.000401796,0
8	0.00390625,0	0.917004,0	0.000172633,0
# FilterI,FilterQ	0.00764509,0	0.822878,0	7.10E-05,0
2.33E-10,0	0.0143282,0	0.707107,0	2.80E-05,0
9.11E-10,0	0.0257149,0	0.581862,0	1.06E-05,0
3.42E-09,0	0.0441942,0	0.458502,0	3.81E-06,0
1.23E-08,0	0.0727328,0	0.345977,0	1.32E-06,0
4.21E-08,0	0.114626,0	0.25,0	4.37E-07,0
1.39E-07,0	0.172989,0	0.172989,0	1.39E-07,0
4.37E-07,0	0.25,0	0.114626,0	4.21E-08,0
1.32E-06,0	0.345977,0	0.0727328,0	1.23E-08,0
3.81E-06,0	0.458502,0	0.0441942,0	3.42E-09,0
1.06E-05,0	0.581862,0	0.0257149,0	9.11E-10,0
2.80E-05,0	0.707107,0	0.0143282,0	2.33E-10,0
7.10E-05,0	0.822878,0	0.00764509,0	
0.000172633,0	0.917004,0	0.00390625,0	
0.000401796,0	0.978572,0	0.00191127,0	

Table continued...

Gaussian (BT = 0.5)			
(Row 1 to 18)	(Row 19 to 36)	(Row 37 to 54)	(Row 55 to 68)
0.000895512,0	1,0	0.000895512,0	

Marker Measurements

Using Markers

Markers are indicators in the display that you can position on a trace to measure values for the X and Y axes, such as frequency, power, and time. If Marker is enabled it will display the difference between its position and that of the Marker Reference (MR).

You can display up to five markers including the reference marker. Markers can all be placed on the same trace or they can be placed on different traces. There are three types of Markers: Reference, Delta, and Power Markers. The Marker Reference (labeled MR in the graph) makes absolute measurements and is also used for calculating differences when Delta or Power readouts are enabled. The Delta Markers (labeled M1 to M4 in the graph) are used to measure other points on the trace or the difference between the Marker Reference and the Delta marker. The Power Markers (labeled M1 to M4 in the graph) function the same way as the Delta Markers, except they show power density and integrated power density (dBm/Hz) instead of power level (dBm).

The following two tables show the appearance of the four types of marker readouts.

Marker Reference Readout	Absolute Marker Readout	Power Marker Readout	Delta Marker Readout
<p>Reference Marker label</p> <p>Power level at marker</p> <p>MR -10.00 dBm 1.004 GHz</p> <p>Frequency at marker</p>	<p>Absolute Marker label</p> <p>Power level at marker</p> <p>M1 -40.54 dBm 999 MHz</p> <p>Frequency at marker</p>	<p>Power Marker Readout</p> <p>Power density at Power Marker</p> <p>M1 -64.97 dBm/Hz 240.10 MHz IntPowerM1 -9.98 dBm PwrDenM1 -72.86 dBm/Hz</p> <p>Difference in frequency between Power Marker and Reference Marker</p> <p>Integrated power value from points between and including Reference Marker to Power Marker</p> <p>Integrated power density value from points between and including Reference Marker to Power Marker</p>	<p>Delta Marker label</p> <p>Difference in power level between Delta Marker and Marker Reference</p> <p>ΔM1 -30.54 dB -5 MHz</p> <p>Difference in frequency between Delta Marker and Marker Reference</p>

The following table shows the appearance of the marker indicators as they appear on the trace. Whichever marker is active will appear as a solid diamond.

Marker Reference	Absolute, Delta, and Power Marker

Controlling Markers with the Right-Click Actions Menu

In addition to controlling the marker actions from the menu controls, you can use the right-click actions menu to move markers or add and delete markers. Some items are not available for certain displays.

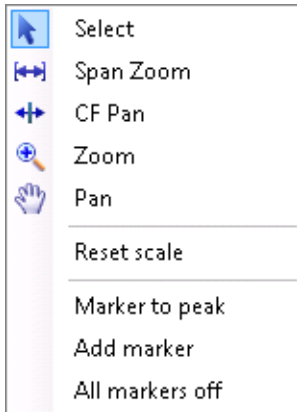

You display the Right-click Action menu by clicking the right mouse button.

Menu item	Description
Marker to peak	Moves the selected marker to the highest peak. If no marker is turned on, this control automatically adds a marker.
Next Peak	Moves the selected marker to the next peak. Choices are Next left, Next right, Next lower (absolute), and Next higher (absolute).
Add marker	Defines a new marker located at the horizontal center of the graph.
Delete marker	Removes the last added marker.
All markers off	Removes all markers.

Markers Context Menu

The Markers context menu appears when you right-click (or touch and hold) on a marker. The Markers context menu enables you to assign a marker to a different trace and pan the trace to place the marker at the measurement frequency.

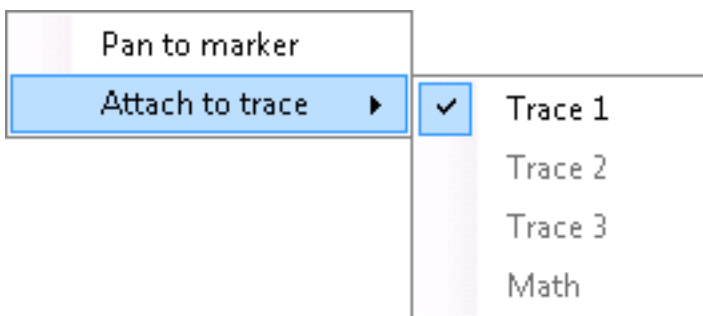

Icon	Menu	Description
-	Pan to marker	Adjusts horizontal position of the waveform to locate the selected marker at the measurement frequency.

Table continued...

Icon	Menu	Description
-	Attach to trace	Attaches the selected marker to Trace 1, Trace 2, Trace 3 or the Math trace. A trace must be enabled to assign a marker to it.

Measuring Frequency and Power in the Spectrum Display

To measure the frequency and power at a point on a Spectrum trace:

1. Select **Markers > Define Markers**.
2. Select the **Marker Properties** tab.
3. Click **Add**. This displays a drop-down list under **MR** (Marker Reference), found inside the **Reference** box. The first marker defined is always designated the Marker Reference. Subsequently defined markers are Delta Markers for which readouts can be selected for Delta, Power, or Absolute. You can also select and adjust markers by clicking on an existing marker on a trace.
4. From the drop-down list, select the trace to which you want to assign the marker.



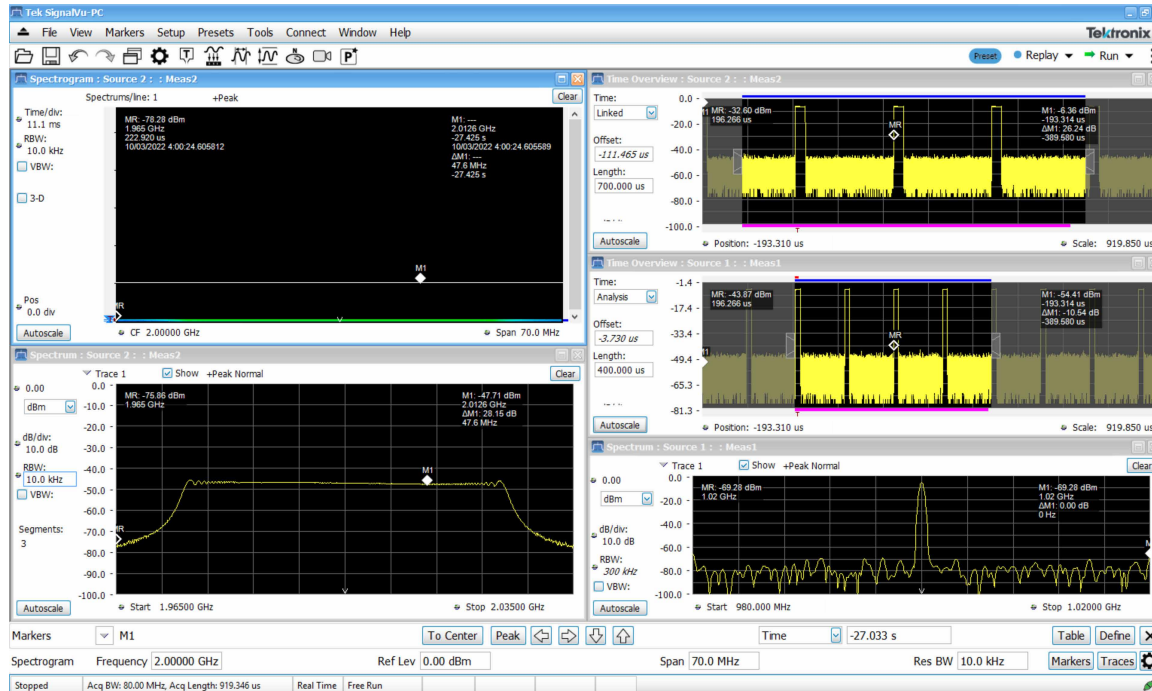

Figure 117: Marker correlation across various measurements with different sources

5. Click the close control panel button to remove the Define Markers control panel.
6. Click on the marker on the trace to activate that marker.
7. Drag the marker in the graph using a mouse to move the marker to the desired location on the trace. You can also click on the marker location text box in the Markers toolbar at the bottom of the screen and adjust it with your mouse wheel. The Peak button in the Markers toolbar and the arrow buttons to the right of it control marker peak searching on the trace.
8. Read the frequency and power level of the marker position on the display.
9. Read the signal density, frequency, and power level of the marker position on the display.
10. If Power markers are selected, read the point power density and the integrated power density.

Marker Action Controls

Controls for enabling and moving markers and for initiating marker peak searches are found in several locations. There are buttons for a few of the most common marker activities on the front panel of the instrument, used along with the knob for adjusting marker positions. The Markers menu contains selections for peak searches. Each graph display has a Marker button on the status bar that provides access to the Markers toolbar. The Markers toolbar has buttons for peak searches, centering, and defining markers.

Peak

Selecting **Peak** from the Markers menu moves the selected marker to the highest level peak within the acquisition record.

Next Peak

Selecting **Next Peak** displays a submenu that enables you to move the selected marker to the next peak.

Setting	Description
Next Left	Moves the selected marker to the next peak to the left of the current marker position.
Next Right	Moves the selected marker to the next peak to the right of the current marker position.
Next Lower (absolute)	Moves the selected marker to the lower level peak (in absolute terms) on the trace.
Next Higher (absolute)	Moves the selected marker to the higher level peak (in absolute terms) on the trace.

Marker to Center Frequency

Changes the center frequency to match the frequency of the selected marker.

Enabling Markers and Setting Marker Properties

The Define Markers Control Panel is used to enable markers and set their properties. You can set up to five markers including the marker reference. Markers are shown in most displays.

Markers have three types of on-screen readouts: Absolute, Delta, and Power. When **Readouts** is set to **Absolute**, each readout displays only the marker's position on the trace. In Frequency displays, this means the marker readout shows the frequency and power of the trace at the marker position. When **Readouts** is set to **Delta**, each delta marker (M1-M4) readout displays both the marker's position on the trace and the difference between its position and the position of the Reference Marker (MR). When **Readouts** is set to **Power**, each delta marker (M1-M4) readout displays the marker's position on the trace, the difference between its position and the position of the Reference Marker (MR), the point power density, and the integrated power density.

Defining Markers

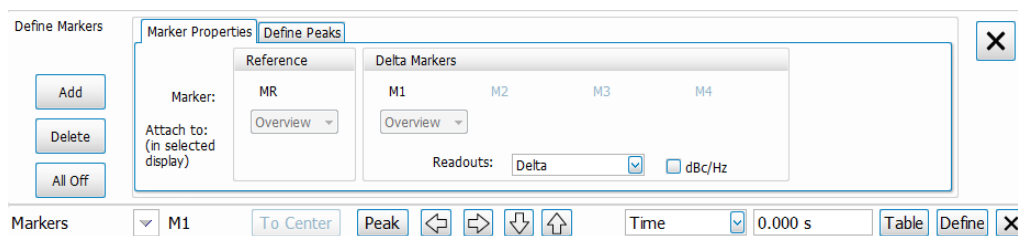

1. Click the **Markers** button on the basic control toolbar to view the Markers toolbar.
2. Click the **Define** button on the Markers toolbar to open the Define Markers control panel.
3. In the Marker Properties tab, select **Add** to turn on the next marker. A drop-down list under the marker label allows you to assign the marker to a trace.



Note: The first marker defined will always be **MR**. The MR marker is the reference for delta marker readouts.

4. Select the trace to which the marker should be attached from the drop-down list.
5. Click **Add** to add additional markers.
6. Readouts for delta across opened displays or source are available
7. Click the close button to remove the Define Markers control panel.

Defining Peaks

You can specify two amplitude values that define peaks. For the DPX display, you can also define peaks based on signal density characteristics.

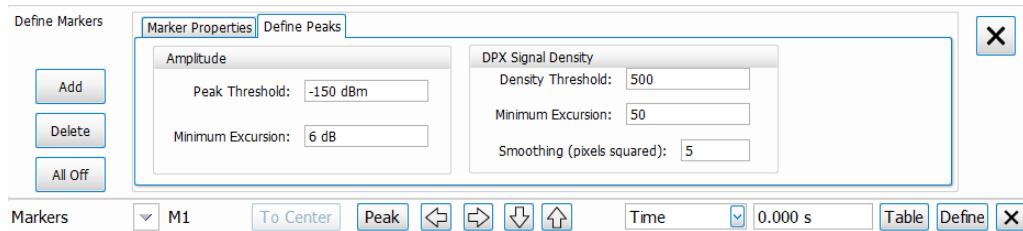

Note: The settings shown in the DPX Signal Density section of the Define Peaks tab are not used by SignalVu-PC.

Amplitude	
Peak Threshold	Peak Threshold specifies the level that the signal must exceed to be considered a peak.
Minimum Excursion	Minimum Excursion specifies how much the signal must decrease and then increase before another peak can be declared.

DPX Signal Density	
Density Threshold	Density Threshold specifies the signal density (number of hits per displayed pixel) that the DPX bitmap must exceed to be considered a trigger event.
Minimum Excursion	Minimum Excursion specifies how much the signal density must decrease and increase again before another peak can be declared.
Smoothing (pixels squared)	Smoothing specifies the number of pixels around the marker that are averaged together to reduce "noise" in the readout of signal density. The value of this control is the number of pixels on each side of the square area used for averaging. With Smoothing = 1, no averaging is done and the marker z-axis readout is the hit count (density) of a single pixel. Use this control to characterize how wide or narrow a range of pixels should be averaged to determine the signal density.

1. Select **Markers > Define Markers** to display the Define Markers control panel.
2. Select the **Define Peaks** tab.
3. To define the level for Peak Threshold, enter a value in the Peak Threshold number entry box.
4. To define the amount the trace must dip, enter a value in the Peak Excursion number entry box.
5. Click the close button to remove the Define Markers control panel.

Using the Markers Toolbar

Favorites toolbar: 

Status bar: **Markers** button

Select **Markers** to display or hide the Markers toolbar at the bottom of the application window. The Markers toolbar enables you to operate existing markers or define new markers.



Enabling a marker or adjusting the position of a marker automatically opens the Markers toolbar.

Icon / Readout	Description
	Opens the Define Markers control panel.
	Selected marker readout. This readout shows which marker is selected. The pop-up menu allows you to choose the selected marker, add markers, and turn all markers off.
	Marker position controls. For frequency displays, this readout shows the marker position in Hertz. For time displays, this readout shows the marker position in seconds. The position of the selected marker can be changed by selecting the numeric readout and using the knob to adjust the value.
	Changes the analyzer's Center Frequency to the frequency of the selected marker. Not selectable for time markers.
	Moves the marker to the highest peak on the signal. On displays that scale about zero on the vertical axis (for example, Magnitude Error, EVM, and Frequency vs. Time), the highest peak selected by the Peak button is an "absolute value", therefore, negative peaks are included in the search for the highest peak.
	Moves the selected marker to the next peak to the left of the current position.
	Moves the selected marker to the next peak to the right of the current position.
	Moves the selected marker to the next lower peak value. The peak value here refers to the numeric value of the peak amplitude. Thus, when repeatedly moving the marker, it can move to the right or left depending on the location of the next lower value.
	Moves the selected marker to the next higher peak value. The peak value here refers to the numeric value of the peak amplitude. Thus, when repeatedly moving the marker, it can move to the right or left depending on the location of the next higher value.
	Displays/hides the marker table from the display.
	Removes the Markers toolbar from the display.

Measuring Noise Using Delta Markers in the Spectrum Display

In the Spectrum display, you can set Markers to dBc/Hz to measure noise on the trace. Markers in this mode operate just as they do in normal mode, but the readouts for the markers are in dBm/Hz and dBc/Hz.

dBm/Hz is the power in milliwatts referenced to a 1 Hz bandwidth. To make this measurement, the analyzer assumes that the measured signal is random noise. It then converts the measured power (made at any RBW) to the power that would be measured had a 1 Hz filter been applied for the measurement.

dBc/Hz represents dBm/Hz referenced to a carrier. Here, it is assumed that the carrier is a CW signal, and its signal level does not change when the RBW is changed, so the Reference Marker measurement on the carrier is unchanged from any other marker measurement. However, the delta marker values are converted to dBm/Hz, and then a difference value, in dBc/Hz, is calculated between each delta measurement and the reference.

Measuring Noise

To measure noise on a Spectrum trace:

1. Select **Markers > Define** to display the Markers control panel.
2. Click **Add**. The first marker defined is always designated the Marker Reference. Subsequently defined markers are Delta Markers for which readouts can be selected for Delta, Power, or Absolute. You can also select and adjust markers by clicking on an existing marker on a trace.
3. Click **Add** again so that there are at least two markers defined.
4. Check that **Readouts** is set to Delta and check the **dBc/Hz** box.
5. If you have more than one trace defined, use the drop-down list for each marker to set it to the trace on which you want to measure noise.
6. Notice that Detection is set to **Average** for the trace you are using for this measurement.
7. Check that the Amplitude units are set to dBm (that is the default). If they are not, click the (Analysis) icon, select the **Units** tab, and select **dBm**.
8. Click the Close button to remove the control panel.
9. Move the markers to the desired locations on the trace.
10. Read the frequency and power level for the selected marker in the upper corners of the display. To display the delta measurement in dBc/Hz, select the delta marker (M1, M2, M3 or M4) by clicking on it or by selecting it in the drop-down marker list in the Markers toolbar.

The following image shows the Spectrum display with a Delta Marker.

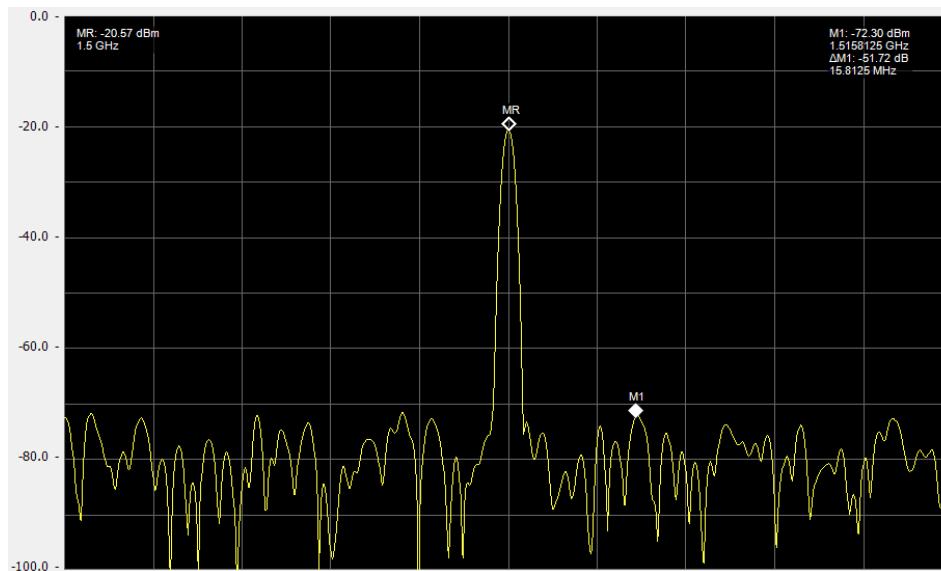

The following image shows the Spectrum display with Power Markers.



Mask Testing

The Mask Test Tool

You can specify pass/fail and mask parameter conditions for the Spectrum, Spurious, Gain, Frequency Settling Time and Phase Settling Time displays. When these conditions are met, the instrument can perform actions such as stopping acquisitions or saving data.

Mask Test Settings

Menu Bar: Tools > Mask Test

Selecting **Mask Test** displays the Mask Test control panel. These settings define test parameters and specify actions to be performed when the test conditions are met. Checking the **Enable Test** box sets the application to perform the test once the conditions are defined.

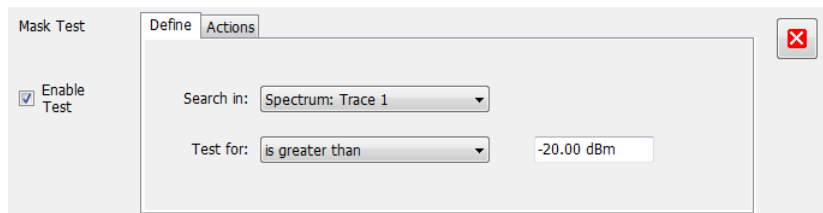

Setting	Description
Enable Test	Select to perform a test, then set the test conditions.
<i>Define</i>	Specifies which result to test and what to test for.
<i>Actions</i>	Specifies the action to take when the test condition is met.

Define Tab (Mask Test)

The Define tab sets the parameters for tests. From this tab, you specify which result to test and what kind of violation to test for.

The following image shows the Define tab with *is great than* selected. After you select that test, you will enter the desired signal level. The procedure is the same if you select *is less than*.

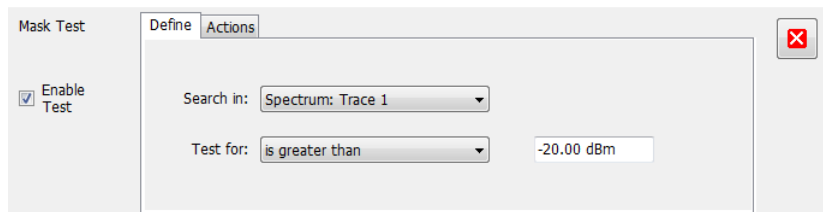

The following image shows the Define tab with *is outside mask* selected. After you select that test, you need to click the Edit limits button and set the desired test limits. The procedure is the same if you select *is inside mask*.

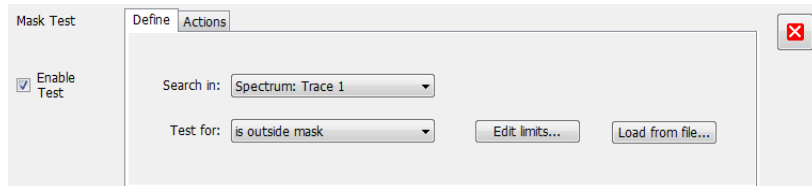

Setting	Description
Search in	Specifies which result to test.
Test for	Specifies what to test for. You can specify a test based on a signal level (“is greater than”, “is less than”) or a mask (“is outside mask”, “is inside mask”). Options for Spurious and Settling Time are Pass and Fail.

Search In

The possible choices for **Search in** include traces from Spectrum, DPX, Noise Figure, Spurious, and Settling Time displays. The available choices are Trace 1, Trace 2, Trace 3, Math, Spectrogram Trace, Spurious, and Settling Time. The available choices include only results from displays that are currently open.



Note: If you select a result that is not the selected trace or result in the target display, you will not see the results of the test. To see the results, select the trace from the drop-down menu in the target measurement display and check the Show box:

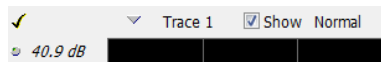

Test For

The **Test for** setting has selections that vary based on which display's results you are testing.

Pass/Fail Tests for Spurious and Settling Time

The Frequency Settling Time, Phase Settling Time measurements, and Spurious measurements test functions provide pass/fail results.

Greater Than/Less Than Tests for Spectrum

If you select a greater than/less than test, you also specify the level that defines a violation. When you select either **is greater than** or **is less than**, a text entry box appears to the right of the drop-down list. Use the text entry box to specify the signal level you wish to test for. While not as flexible as mask testing, this type of test is quicker to set up.

The following figure shows the results of an **is greater than** test. The vertical red bar highlights results that match the test definition.

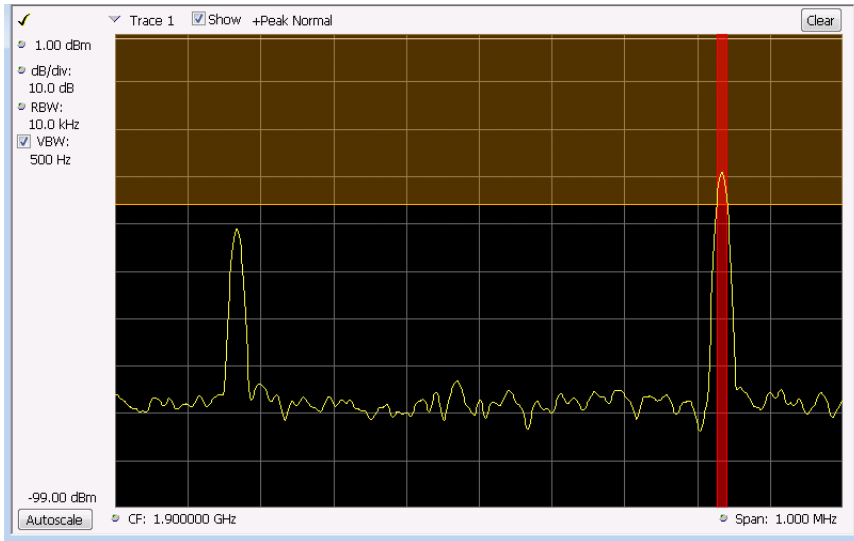

Outside/Inside Mask Tests

If you specify a mask-based test, then you need to edit the mask to specify the levels that define a violation. When you select **is outside mask** or **is inside mask**, an **Edit limits** button is displayed. Click the **Edit limits** button to display the Mask Test Editor window.

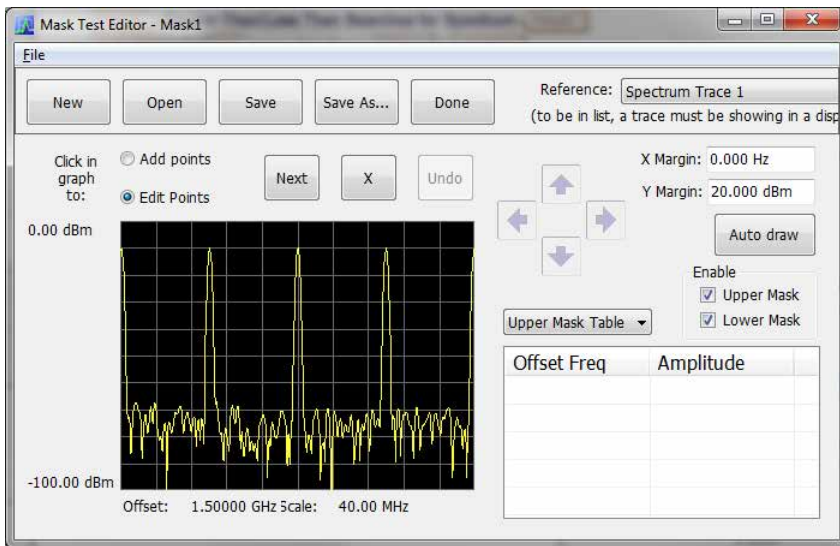

To set up and save mask test limits for a test. Perform the following procedure to set up a test using the mask limits.

1. After choosing the desired **Search in** and **Test for** items, click **Edit limits** to display the Mask Test Editor window.
2. Click the **New** button to create a table. This clears the existing points and loads the default table. You can also click **Open** to open an existing table.
3. To edit values, add points, or delete points in a table:
 - a. To edit an existing value, double-click on the cell you want to edit and enter the desired value. The active point shows as a red point on the plot.

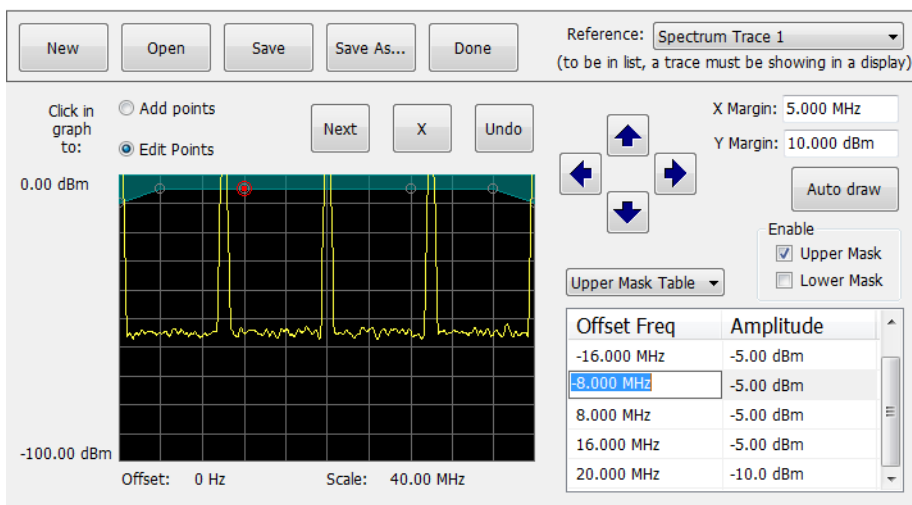

- b. To add a new point, check the box next to the target mask (located below the **Auto draw** button).
- c. Select **Add points** located below the **Open** button.
- d. Select the target mask (Upper Mask Table or Lower Mask Table) from the drop-down menu.
- e. Click in the desired location on the plot to add the point.

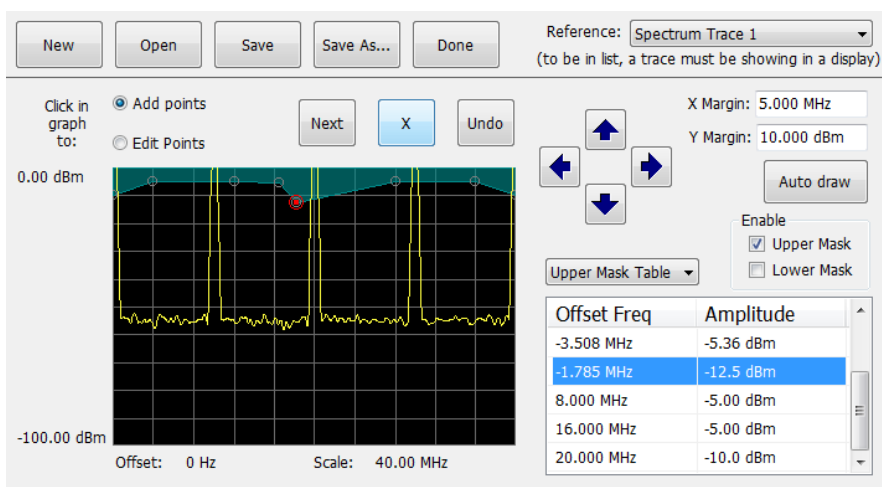

- f. To use the auto draw feature to automatically place points on the chosen mask, enable the desired mask from the drop-down menu and then click the **Auto draw** button.

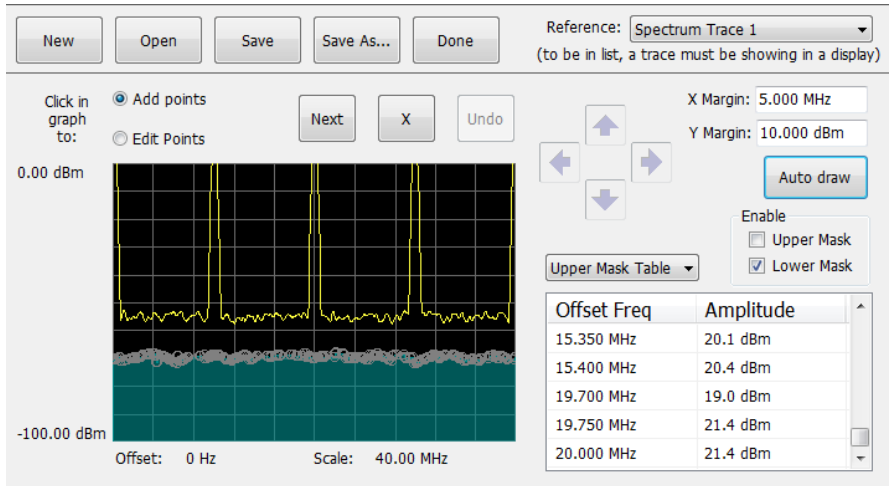

Note: Units may be changed for measurements other than Noise Figure in Setup > Analysis > Units.

4. To delete a point from the table, select the point to be removed, and click the **X** button.
5. To save the mask to a file for later recall, click **Save As**.
6. From the Save As dialog, name the file and save it in the desired location.



Note: Masks are saved in XML format with a .msk extension.

7. To dismiss the Mask Test Editor window, click **Done**.

Mask Test Result Example

The following figure shows the results of a Spectrum **is outside mask** test with Upper Mask enabled. The vertical red bar highlights results that have exceeded the test limits. The shaded region shows the mask area.

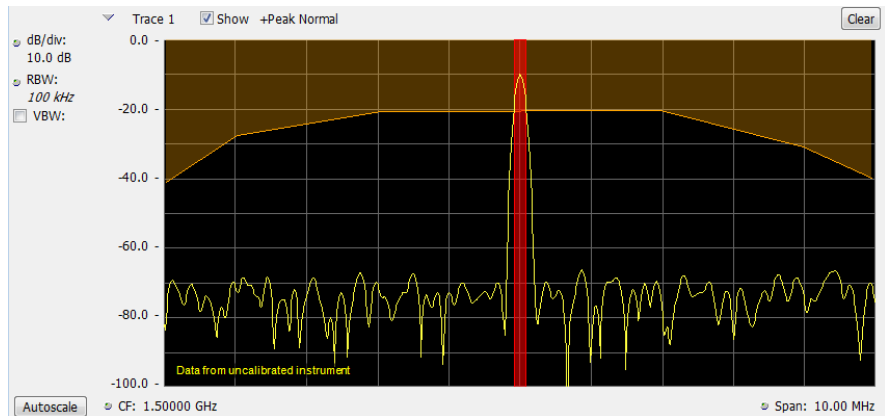

The following figure shows the results of a passing Noise Figure **is outside mask** test with Upper Mask enabled. Markers are also in use.

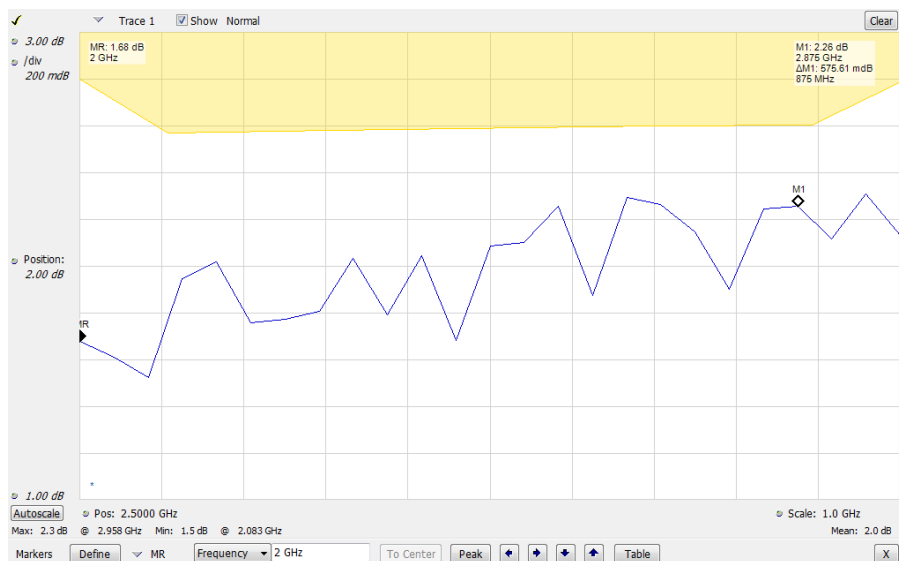

The following figure shows the results of a failing Noise Figure **is outside mask** test with Lower Mask and Upper Mask enabled. The red area highlights the area of failure, which occurs at the lower mask. Markers are also in use.



Actions Tab

The Actions tab allows you to trigger the application when a signal in the frequency domain violates the mask.

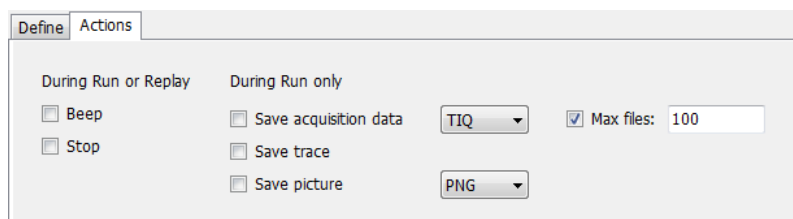

Setting	Description
During Run or Replay	Actions specified here will occur in either Run mode or Replay mode. (Run actions not available in SignalVu-PC.)
Beep	The analyzer beeps when the test condition is met.
Stop	The analyzer stops when the test condition is met.
During Run Only	Actions specified here are taken only during Run mode (while acquiring live data).
Save acquisition data	Saves acquisition data to a file when the test condition is met. Use the drop-down list to specify the format of the saved data. The available file formats are: <i>TIQ, CSV, and MAT</i> .
Save trace	Saves Trace data to a file when the test condition is met.
Save picture	Saves a screen capture to a file when the test condition is met. Use the drop-down list to specify the format of the saved picture. The available file formats are: <i>PNG, JPG, and BMP</i> . Note that no trace will be saved if the tested trace isn't a saveable trace type. For example, a Spurious trace is not saveable.
Max files	Specifies the number of times a test action stores a file. After this limit is reached, no more files are saved. The instrument will continue to run, but no additional files are saved when test conditions are met. Keep in mind when setting this number that picture files are counted as part of the total number of files. For example, if you set Max files to 100, the instrument will save 100 acquisitions if only acquisitions are saved or only pictures are saved. But, if both acquisitions and pictures are saved, then 50 acquisitions and 50 pictures will be saved.

AutoSave File Naming

When one of the AutoSave actions is enabled, the name of the saved file is automatically incremented even if the **Automatically generate filenames** option (Tools > Options > Save and Export) is not enabled. When the file is saved, it will be saved to *C:\<instrument name>Files*.

Analyzing Data

Analysis Settings

Menu Bar: Setup > Analysis

Favorites toolbar: 

The Analysis control panel displays Analysis offset and Analysis length for the source corresponding to highlighted measurement.

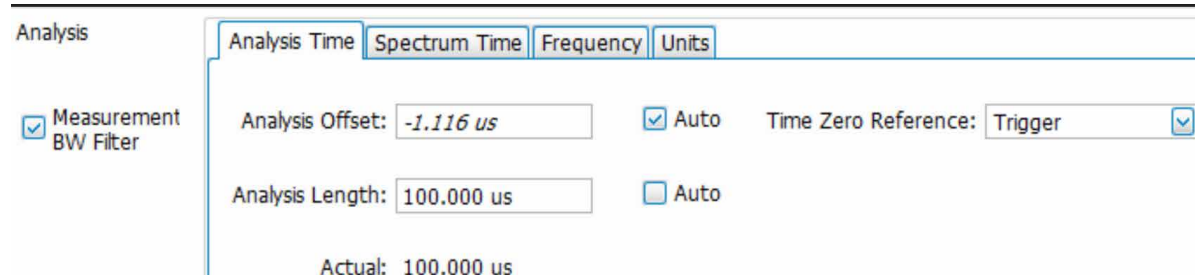

Analysis

Analysis Time | Spectrum Time | Frequency | Units

Measurement BW Filter

Analysis Offset: Auto Time Zero Reference:

Analysis Length: Auto

Actual: 100.000 us

Measurement Bandwidth Filter

Each measurement can set the measurement bandwidth to analyse in a specific bandwidth region. The measurement bandwidth is linked to span by default. When the measurement bandwidth is set to less than span and the measurement is run, if this button is checked, the acquired data is pass through the filter to filter out all the frequency components outside the measurement bandwidth region.

Setting	Description
Analysis Time Tab on page 737	Specifies the length of time to use in measurements.
Spectrum Time Tab on page 739	Specifies whether the Spectrum Analysis display uses the same Analysis Time parameters as all the other displays or if it uses a different Offset and Length.
Frequency Tab on page 741	Specifies the measurement frequency (center frequency).
Units Tab on page 744	Specifies the Power units for all displays.

Analysis Time Tab

The Analysis Time tab contains parameters that define the portion of the acquisition record that is used for analysis.

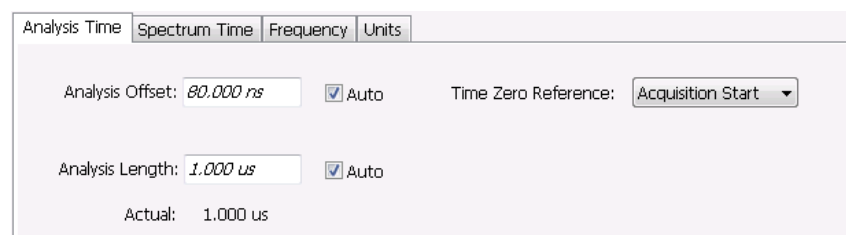

Analysis Time | Spectrum Time | Frequency | Units

Analysis Offset: Auto Time Zero Reference:

Analysis Length: Auto

Actual: 1.000 us

Analyzing Data

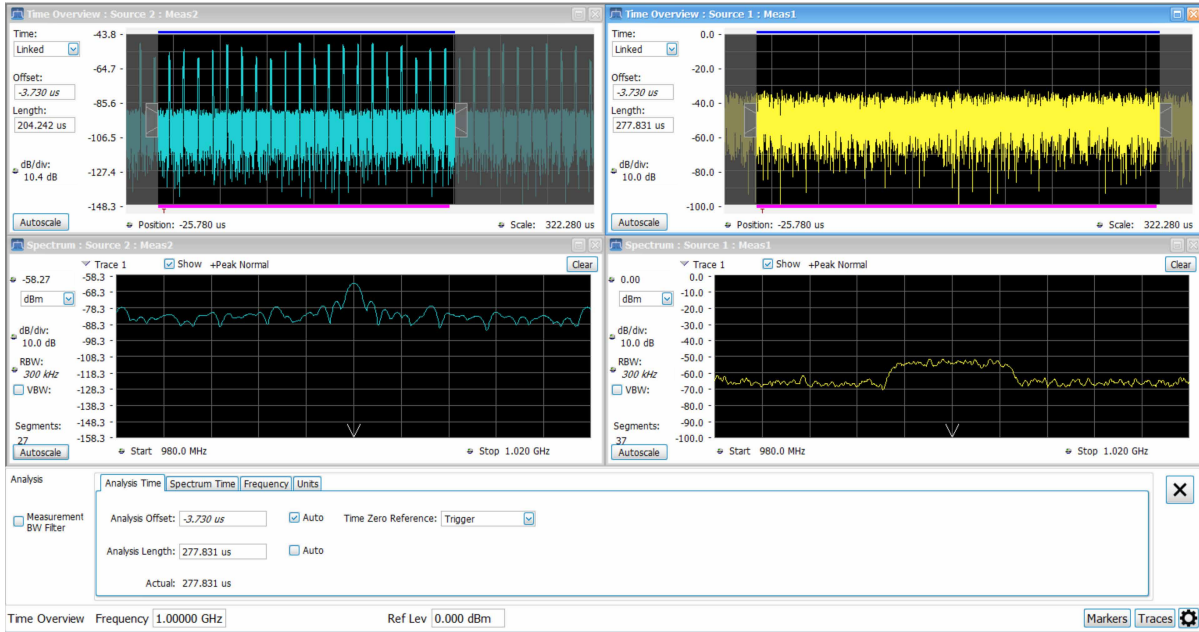

Figure 118: Analysis time for Source 1 when connected to MSO/LPD

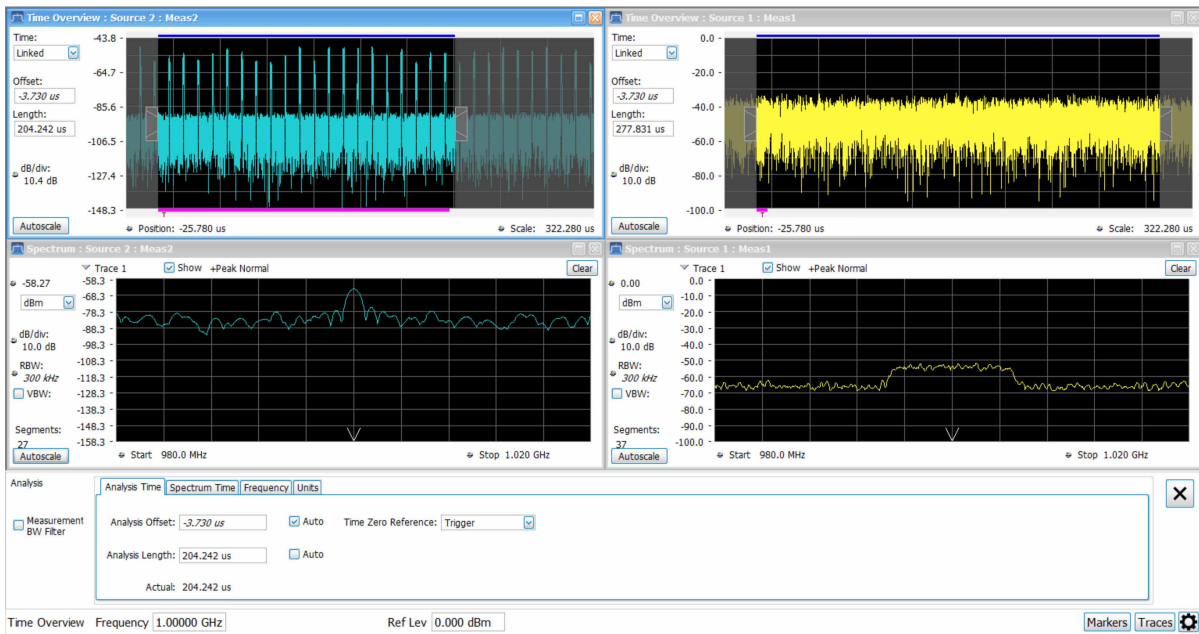

Figure 119: Analysis time for Source 2 when connected to MSO/LPD

Setting	Description
Analysis Offset	Specifies the location of the first time sample to use in measurements.
Auto	When enabled, causes the instrument to set the Analysis Offset value based on the requirements of the selected display.

Table continued...

Setting	Description
Analysis Length	Specifies the length of time to use in measurements.
Auto	When enabled, causes the instrument to set the Analysis Length value based on the requirements of the selected display.
Time Zero Reference	Specifies the zero point for the analysis time.
Actual	This is a displayed value, not a setting. It is the Analysis Length (time) being used by the analyzer; this value may not match the Analysis Length requested (in manual mode).



Note: When connected to MSO/LPD, all these parameters are with respect to source corresponding to selected measurement.

Analysis Offset

SignalVu-PC when connected to MSO/LPD, It is per source basis and is with respect to source corresponding to selected measurement.

Use analysis offset to specify where measurements begin. Range: 0 to [(end of acquisition) - Analysis Length]. Resolution: 1 effective sample (or symbol).

Analysis Length

SignalVu-PC when connected to MSO/LPD, It is per source basis is with respect to source corresponding to selected measurement.

Use the analysis length to specify how long a period of time is analyzed by a measurement. After you enter a value, this box changes to show the actual value in use, which is constrained by Acquisition Time. This setting is not available when Auto is checked. Range: minimum value depends on modulation type to Acquisition Length. Resolution: 1 effective sample (or symbol).

Time Zero Reference

The analysis offset is measured from this point. Choices are: Acquisition Start or Trigger Point.

Parameter	Description
Acquisition Start	Offset is measured from the point at which acquisition begins.
Trigger Point	Offset is measured from the trigger point.

Spectrum Time Tab

This tab displays whether the Spectrum display uses same Analysis Time parameters as all the other views or uses a different Offset and Length.

The screenshot shows the 'Spectrum Time' tab selected. Under 'Spectrum Time Mode', the 'Independent' radio button is selected. Under 'Spectrum Time', the 'Spectrum Offset' is set to 80.000 ns with the 'Auto' checkbox checked. The 'Spectrum Length' is set to 1.520 ms with the 'Auto' checkbox checked. Below these, the 'Actual' value for Spectrum Length is displayed as 1.520 ms.

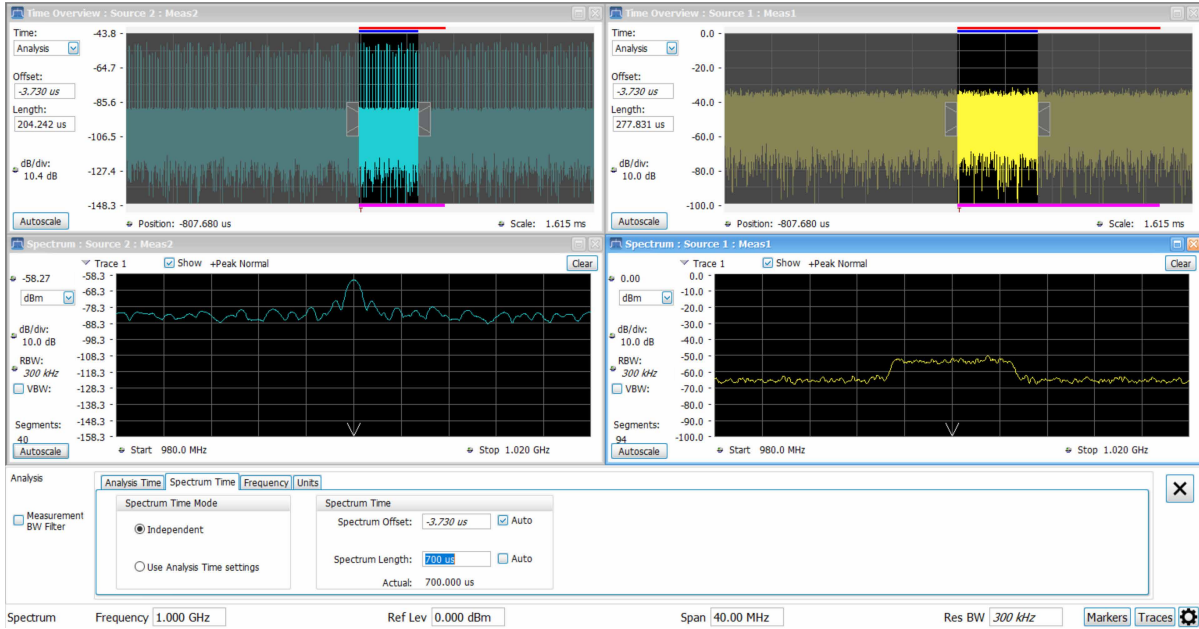

Figure 120: Spectrum time for Source 1

The above figure is shown when connected to MSO/LPD.

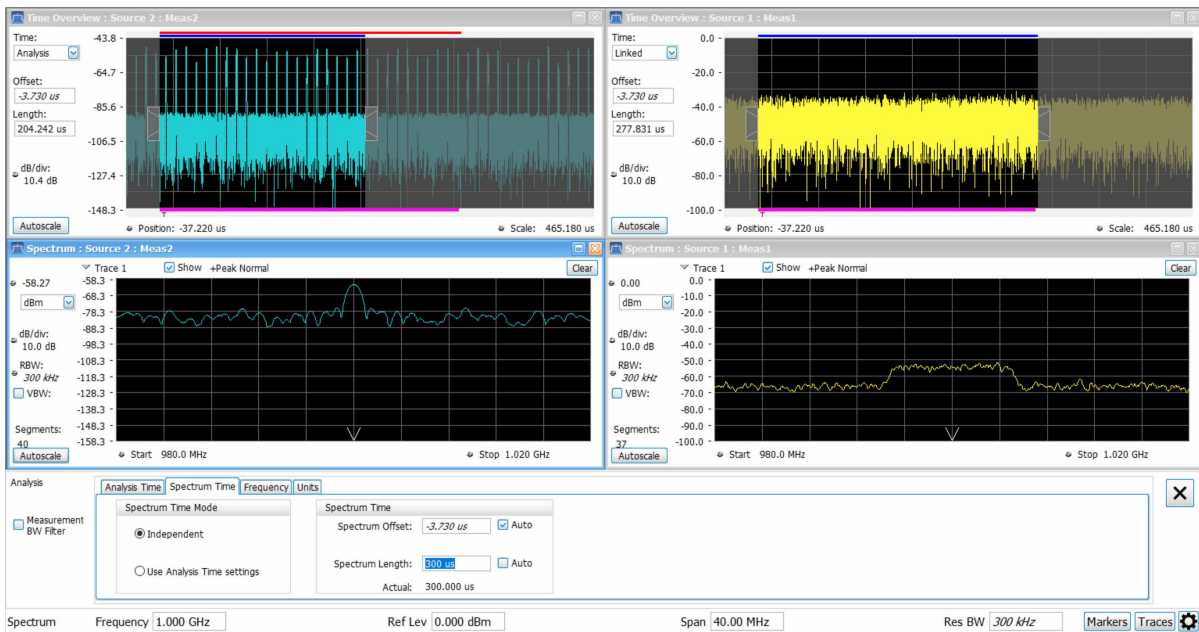

Figure 121: Spectrum time for Source 2

Settings	Description
Spectrum Time Mode	
Independent	Causes the spectrum analysis views to use the settings unique to those displays.
Use Analysis Time settings	Causes the spectrum analysis views to use the settings on the Analysis Time tab.
Table continued...	

Settings	Description
Spectrum Time (only available when <i>Independent</i> is selected)	Spectrum time is with respect to source corresponding to selected measurement.
Spectrum Offset	Sets the beginning of Spectrum Time with respect to the selected time reference point (selectable in the Analysis Time tab as either Acquisition Start or Trigger). When connected to MSO/LPD, Spectrum offset is with respect to source corresponding to selected measurement.
Spectrum Length	The amount of data, in terms of time, from which spectrum traces are computed. When connected to MSO/LPD, Spectrum length is with respect to source corresponding to selected measurement
Auto	When enabled, causes the instrument to set the Spectrum Length value based on the RBW setting.
Actual	This is a displayed value, not a setting. It is the Spectrum Length (time) being used by the analyzer; this value may not match the Spectrum Length requested (in manual mode). The actual spectrum length is always an integer multiple of the time needed to support the RBW value.



Note: When connected to MSO/LPD all these parameters are with respect to source corresponding to selected measurement.

Frequency Tab

The Frequency tab specifies two frequency values: the Measurement Frequency and the Spectrum Center Frequency. The Measurement Frequency is the frequency at which most displays take measurements. The Spectrum Center Frequency is the center frequency used by the Spectrum, DPX Spectrum, Spectrogram and Time Overview displays.

The SignalVu-PC when connected to MSO/LPD, the Measurement Frequency with respect to source is corresponding to the selected measurement.

Analysis Time | Spectrum Time | **Frequency** | Units

Measurement Frequency: 1.500000 GHz

Lock Center Frequency of Spectrum displays to Measurement Frequency

Spectrum Center Frequency: 1.500000 GHz

The following screen capture shows a display with both the Measurement Frequency and the Spectrum Center Frequency locked together.



Figure 122: Frequency tab in SignalVu

The above figure is shown when connected to MSO/LPD

Normally, the Measurement Frequency and the Spectrum Center Frequency are locked together so that both have the same setting. But in some situations, for example, where a signal contains a set of channels, it is useful to unlock the Measurement Frequency from the Spectrum Center Frequency. When the Spectrum Center Frequency is unlocked from the Measurement Frequency, you can adjust the Measurement Frequency so that measurements can be taken at different frequencies without resetting the center frequency. The following screen capture shows the magenta-colored measurement frequency indicator still located at the center frequency.



The above figure is shown when connected to MSO/LPD

The following screen capture shows the measurement frequency indicator located at 1.98 GHz while the Spectrum Center Frequency is still located at 2.0000 GHz.

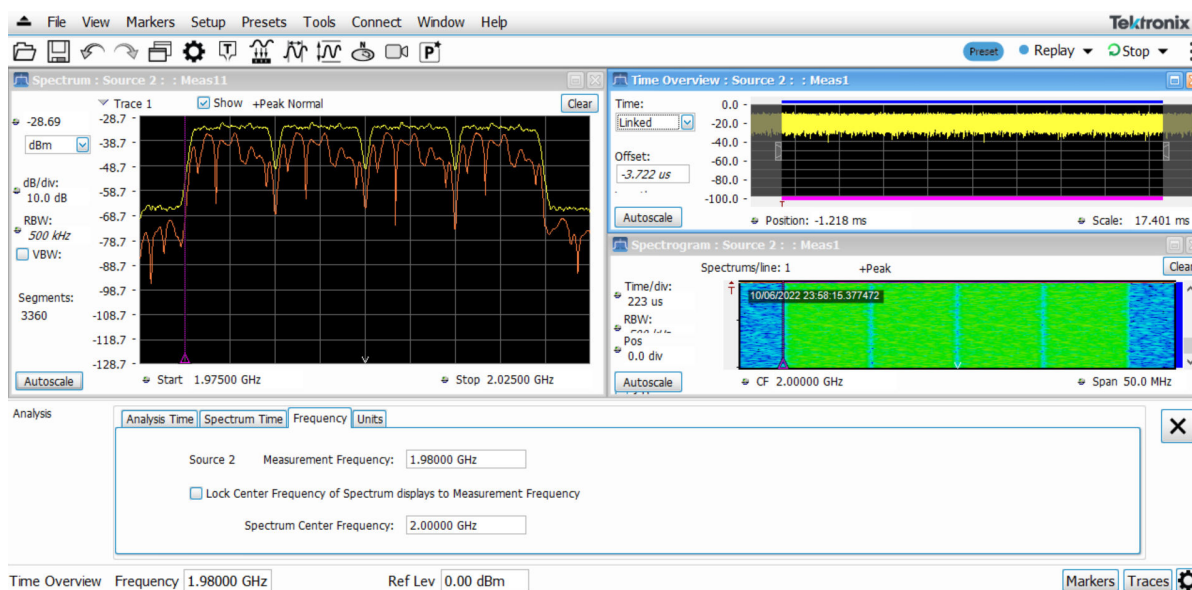

Figure 123: When Lock Center Frequency is disabled, you can configure Center Frequency and Measurement Frequency independently in SignalVu.

The above figure is shown when connected to MSO/LPD

You can drag the Measurement Frequency indicator on the screen to set the measurement frequency. Note the base of the Measurement Frequency indicator. The width of the box indicates the widest measurement bandwidth in use among the open displays. You can see how the width of this box changes with the measurement bandwidth by, in this example, adjusting the Measurement BW setting for the Constellation display (Settings > Freq & BW tab). As you adjust the setting, you will see how the width of the box at the base of the Measurement Frequency Indicator changes.

The Measurement Frequency indicator is useful for interpreting system behavior when MeasFreq is unlocked. If a measurement has a wide bandwidth relative to the spectrum span, and the Measurement Frequency is far from spectrum center, the measurement is likely to fail because its required frequency range exceeds the frequency range of the available data. In such a case, the navigation control will show that the measurement bandwidth extends outside the Spectrum's span.

There are interactions between frequency unlocking and RF & IF Optimization (see the [Amplitude Settings](#) on page 749). When **Best for multiple displays** is the selected optimization, the instrument is allowed to use its full bandwidth to meet the needs of all open displays. This is the most user-friendly optimization because it decreases the number of **Acq BW too small** errors, but it can increase noise and slightly decrease measurement accuracies. For all other optimization types, the instrument optimizes the acquisition bandwidth for the selected display, improving measurement quality somewhat, but reducing concurrent measurement capability.

There are also interactions with trigger settings. When the Spectrum Center Frequency is unlocked from Measurement Frequency, the RF triggers (Trigger Source = RF Input) can tune to either Spectrum Center Frequency or Measurement Frequency. When a spectrum display is selected, the trigger frequency is the same as the Spectrum Center Frequency. When one of the other displays that uses Measurement Frequency is selected, the trigger is tuned to the Measurement Frequency also. This allows you to trigger on the signal you are measuring. But, there is an exception: when the selected RF & IF Optimization is **Best for multiple displays**, the trigger is always tuned to the Spectrum Center Frequency.

The reason the trigger frequency is affected by Measurement Frequency and RF & IF Optimization, is that these functions control how the acquisition is tuned. The optimization **Best for multiple displays** keeps the acquisition centered about the Spectrum Center Frequency at all times. To accommodate off-center Measurement Frequencies, it just widens the acquisition bandwidth. Other optimizations tune the acquisition frequency to match that of whichever display is currently selected. The RF trigger module receives the same acquisition data as all the measurements, tuned to the center of the current acquisition bandwidth.

Units Tab

The Units tab specifies the global Amplitude units for all the views in the analysis window.

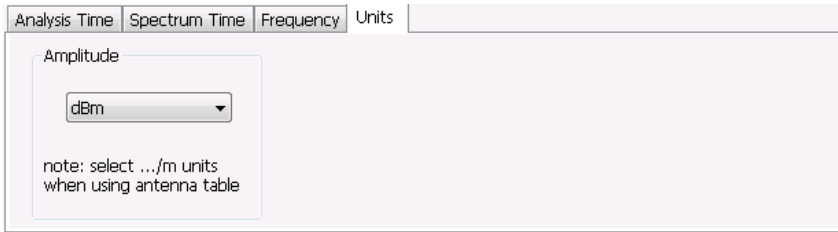

Replay Overview

The Replay function enables you to reanalyze data with different settings and even different measurements. You can replay all the acquisitions in memory, a single acquisition, a single frame within an acquisition (if Fast Frame is enabled or was enabled when the waveform file was saved), or any contiguous set of data records from acquisition history.

Displaying the Replay Control Panel

To display the Replay control panel:

1. Select **View** from the main menu bar.
2. Select **Replay Toolbar** in the menu. The toolbar will appear near the bottom of the display.



3. Click the **Define** button to open the Replay control panel.



Tip: You can read more about the other toolbar buttons [here](#).

Selecting the Data Type to Replay

You can choose to replay either acquisition data or DPX spectra (providing DPX Spectra were saved in the waveform file). Choose **Acq Data** to replay any acquisitions except DPXogram acquisitions. Choose **DPX Spectra** to replay a DPXogram acquisition.

Select Data Records Tab

The Select data records tab is used to select which data records to replay. A data record is the smallest unit that can be replayed. Note that what constitutes a data record can vary. If FastFrame is not enabled, a data record consists of a single acquisition. If FastFrame is enabled, each acquisition can contain multiple frames, and a data record consists of a single frame.

Select data records	Acquisition Info	Replay Speed
Select acquisitions <input type="button" value="Select All"/>		
1 : 7/25/2011 17:39:29.72		
Start: 1	7/25/2011	17:39:29.72
Stop: 304	7/25/2011	17:39:33.79
304 : 7/25/2011 17:39:33.79		

Figure 124: Without FastFrame enabled

Select data records	Acquisition Info	Replay Speed
Select acquisitions <input type="button" value="Select All"/>		
1 : 3/10/2010 4:47:40.22		
Start: 1	3/10/2010	4:47:40.22
Stop: 1	3/10/2010	4:47:40.22
1 : 3/10/2010 4:47:40.22		
Select frames		
1 : 3/10/2010 4:47:40.22		
Start: 1	3/10/2010	4:47:40.22
Stop: 10	3/10/2010	4:47:51.74
10 : 3/10/2010 4:47:51.74		

Figure 125: With FastFrame enabled

Date and Time Stamps. The line that appears above each Start box (one for acquisitions and one for frames when FastFrame is enabled) is a date stamp that displays the date and time the first record in the current acquisition was acquired. The line that appears below each Stop box is a date stamp that displays the date and time the last record in the current acquisition was acquired.

The line that appears to the right of each Start box displays the date and time the selected acquisition or frame was acquired. The line that appears to the right of each Stop box displays the date and time the selected record or frame in the current acquisition was acquired.

Select All button. Selecting Select All resets the Start and Stop values. The Start value is reset to the first acquisition or frame of the current acquisition. The Stop value is reset to the last acquisition or frame in the current acquisition.

Select DPX Spectra Tab

The Select DPX Spectra tab is used to select which DPXogram spectra to replay. A spectra is the smallest DPXogram unit that can be replayed. It is equivalent to one line in the DPXogram display.

Select data records	Select DPX Spectra	Acquisition Info	Replay Speed
Select spectra <input type="button" value="Select All"/>			
1 : 9/29/2011 17:36:53.05			
Start: 1	9/29/2011	17:36:53.05	
Stop: 602	9/29/2011	17:37:7.82	
602 : 9/29/2011 17:37:7.82			

Date and Time Stamps. The line that appears to the right of each Start box displays the date and time the selected DPX Spectra was acquired. The line that appears to the right of each Stop box displays the date and time the selected DPX Spectra in the current acquisition was acquired.

Select All button. Selecting Select All resets the Start and Stop values. The Start value is reset to the first DPX Spectra of the current acquisition. The Stop value is reset to the last DPX Spectra in the current acquisition.

Acquisition Info Tab

Displays information about acquisition settings and sets the number of decimal places used for displaying the time stamp.

Select data records | Select DPX Spectra | Acquisition Info | **Replay Speed**

Timestamp decimal places:

Acq Center Freq:	1.90 GHz	Preamp:	Off
Acq Bandwidth:	85.0 MHz	RF Atten:	15.00 dB
Sampling Rate:	150 MHz	Ref Level:	0.00 dBm
Dither:	On	Acq Length:	5.19 us

Replay Speed Tab

Sets the speed at which data records are replayed.

Select data records | Select DPX Spectra | Acquisition Info | **Replay Speed**

Slow Fast

Replay Menu

The Replay menu provides controls that let you choose how to replay acquisitions. The replay function enables you to, in effect, “rerun” an analysis while applying different measurements to the same set of acquisition data.

Menu item	Description
Acq Data	Select Acq Data to replay acquisitions.
DPX Spectra	Select DPX Spectra to replay a DPXogram display.
Replay all selected records	Replays the sequence of records specified by Start and Stop on the Select data records tab.
Loop overall selected records	Replays the sequence of records specified by Start and Stop on the Select data records tab continuously.
Replay current record	Replays the currently selected acquisition (or frame).
Replay from selected	Displays a submenu that you use to specify which records are to be replayed.
First record	Replays the first record within the selected set.
Previous	Replays the previous record within the selected set.
Next	Replays the next record within the selected set.
Last record	Replays the last record within the selected set.
Pause	Suspends replay of the data records as soon as the current record's replay action is completed. Press Pause again to begin replay with the next record in the sequence.
Stop	Halts the replay of acquisitions. If replay is started after Stop has been selected, replay starts from the first acquisition.
Select all	Selects all acquisitions for replay.
Select records from history	Displays the Select data records tab of the Replay control panel. Use the Select data records tab to specify which acquisitions and frames you would like to replay.
Replay toolbar	Displays or hides the Replay toolbar.

Acq Data

Selecting **Acq Data** selects acquisition data as the source for replay. Selecting Acq Data does not start replay, it only selects the type of acquisition data that will be replayed.

DPX Spectra

Selecting **DPX Spectra** selects DPX spectra as the source for replay. Selecting DPX Spectra does not start replay, it only selects the type of acquisition data that will be replayed.

Replay All Selected Records

Selecting **Replay all selected records** replays all the selected data records. The set of selected records may comprise a single record, all records in acquisition history, or a subset of the records in history.

Replay Current Record

Selecting **Replay current record** replays the current data record. You can identify the current acquisition record by looking at the Replay toolbar. The first number to the right of the Select button identifies the current data record. For example, if the number is 2:10, it means the current record is the tenth frame of the second acquisition in history.

Replay from Selected

Select **Replay from selected** to replay records as selected from the submenu. The records replayed can be from the acquisition memory (history) or from a saved acquisition data file that has already been recalled as the current acquisition data.

Pause

Select Pause to suspend playback. Selecting Pause again restarts the replay at the point it was paused.

Stop

Select **Stop** to halt the replay of data. Selecting any Replay action restarts replay of records from the beginning.

Select All

Select **Select all** to select all data records for replay.

Select Records from History









Selecting **Select records from history** displays the **Select data records** tab of the **Replay** control panel. The Select data records tab allows you to specify which records in the acquisition history will be used when the Replay button is selected.

Replay Toolbar

Displays or hides the Replay toolbar that appears below the main tool bar.



Figure 126: Replay toolbar

Item	Description
Replay	Selects data type to be replayed. Select DPX Spectra to replay a DPXogram. Select Acq Data for all other types of replay.
	Replays the first record in the selected set.
	Replays the previous record in the selected set.
	Replays the current record in the selected set.
	Replays the next record in the selected set.
	Replays the last record in the selected set.
	Replays all records in the selected set.
	Replays all records in the selected set continuously until stopped.
	Pauses replay. Pressing pause suspends replay with the current record. Selecting pause again starts Replay with the next record.
	Stops replay. Starting any replay action after pressing stop starts a new Replay action rather than continuing from the record at which the previous replay action was stopped.
Select All	Clicking Select All selects all records in history for replay. Selecting Select all resets the Start and Stop values on the Select data records tab of the Replay control panel.
Define	Clicking the Define button displays the Define Replay control panel. The Acquisition Info tab displays information about the acquisition data such as acquisition bandwidth, sampling rate and acquisition length. All data records in the acquisition history were acquired with identical parameters. When any of these parameters are changed, all records in history are deleted as soon as the first record acquired under the new parameter values is received. You can also view and use the Select data records tab, Select DPX Spectra tab, and Replay Speed tab.
1:10 3/10/2010 4:47:51.74	This readout shows information about the data record being replayed. The information displayed shows the acquisition and frame number and time stamp for the current data record.

Amplitude Corrections

Amplitude Settings

Main menu Bar: Setup > Amplitude

Favorites toolbar: 

The Amplitude control panel provides access to power-related settings that are used by all displays within the SignalVu-PC application.

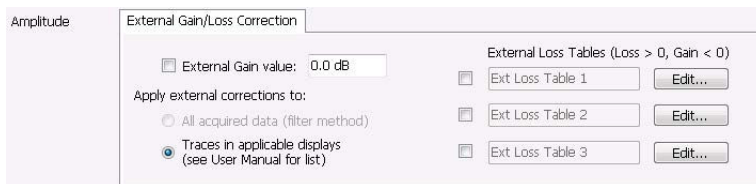

Setting	Description
Internal Settings	Sets the parameters that control the acquisition of the signal.
External Gain/Loss Correction	Specifies whether a correction is applied to the signal to compensate for the use of external equipment.

Internal Settings Tab

When connected to an RSA500A Series, RSA600A Series, or RSA7100, the Internal Settings tab is available from the Amplitude Settings control panel. From this tab, you can specify the Reference Level for the signal analyzer's RF front end. Depending on which instrument is connected, you may also be able to access the settings for the internal attenuator, enable/disable the optional internal preamp, and specify the RF & IF Optimization. The following image shows the tab as it appears when an RSA7100 instrument is connected.

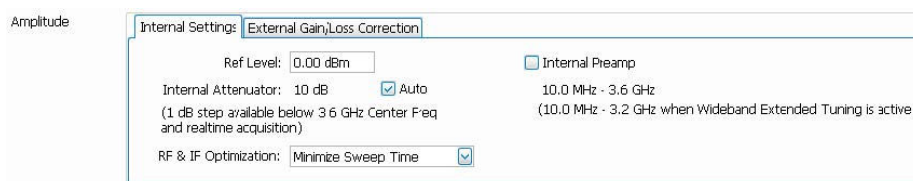

Ref Level

The reference level can be set for the RF Input of the connected instrument.

Internal Attenuator

The Internal Attenuator setting can be set to Auto or Manual. When Auto mode is enabled, the attenuation setting is displayed but is not adjustable. When Auto is disabled, the attenuator operates in manual mode, allowing you to set the internal attenuation. The internal attenuation setting range varies depending on the instrument in use.

Internal Preamp

Use this setting to switch the preamp on or off.



Note: To ensure the best accuracy, thermally stabilize before taking critical measurements.

RF & IF Optimization (Only available when an RSA7100 is connected)

Specifies how the gain and bandwidth should be optimized (in the RF and IF stages of the front end).

You can select RF & IF optimizations to achieve the best dynamic range, fastest sweep speed, or minimum displayed noise. These choices affect the RF and IF attenuation levels, the selection of the acquisition bandwidth, digitizer and the resolution of the mathematical operation performed on the acquisitions used in varying conditions of span, reference level and resolution bandwidth.

The following paragraphs describe the effects of choosing each of the available choices.

Best for multiple displays (Default). This setting is the instrument default and is set as part of the Preset function. When this is selected, the instrument considers all the open displays and chooses an Acquisition Bandwidth wide enough to satisfy as many measurements as possible. Instead of optimizing the measurement performance of the selected display, this setting decreases the incidence of non-selected displays being unable to run because the acquisition bandwidth is set too small by the selected display.

Minimize sweep time. Selecting Minimize Sweep Time causes the instrument to use the widest available acquisition bandwidth when sweeping across spans greater than the maximum available real-time span. Available for RSA7100 instruments with Option B800 (800 MHz bandwidth).

The start frequency must be set to >3.2 GHz to view 800 MHz. A start frequency of <3.2 GHz will result in a set BW of 320 MHz (with preselector Off).



Tip: See the [Advanced](#) on page 759 topic for more information about preselector settings.

External Gain/Loss Correction Tab

The External Gain/Loss Correction tab allows you to apply a correction to a signal to compensate for the use of external equipment, such as an amplifier or attenuator. You can specify whether the corrections on this tab apply to all acquired data or only to a set group of displays. You can also apply external corrections to traces in the Spectrum, Spectrogram, Spurious, and Amplitude vs Time displays.

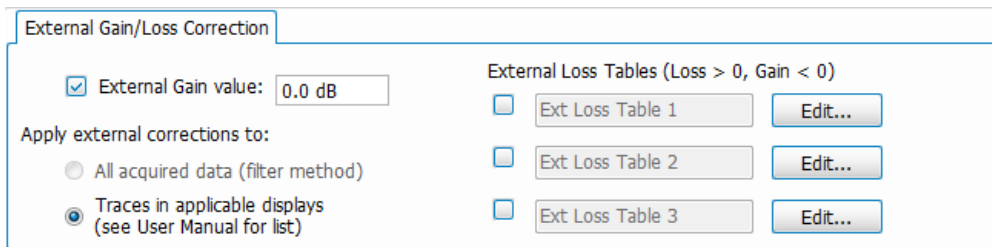

External Gain Value

Use the External Gain Value setting to apply a flat gain/loss correction to the signal. Positive values represent a gain and negative values represent a loss. The range is -80 to +50 dB. Resolution is 0.1 dB.



Note: Selecting Preset clears the check box, but it does not change the value.

Apply External Corrections To

Use the two selections to specify how the enabled external loss tables are applied.

- 1. All acquired data (filter method):** This selection applies corrections to all acquired data.

- 2. Traces in applicable displays:** This selection applies corrections only to traces in the Spectrum, Spectrogram, Spurious, and Amplitude vs Time displays. Note that the loss at the center frequency is the correction applied to the Amp vs Time display.

When choosing whether to correct sample data or traces, keep the following in mind:

- If sample data is acquired while data correction is enabled, that data record is permanently corrected. If the acquisition is saved and recalled, the recalled acquisition includes corrections. Corrections are not saved separately from the raw data; they are used during the acquisition process to adjust the data values.
- Trace corrections can be applied at any time, as they are part of the measurement's computations. Using Replay will apply trace corrections to a trace if this control is enabled (and an external loss table is specified and enabled).
- Be aware that if you recall acquisition data that was saved with data corrections and you use Replay with trace corrections selected and an external loss table enabled, the trace will be calculated using corrected data and also corrected with trace corrections. This probably creates incorrect traces.
- Triggering operates on uncorrected acquisition data. Frequency masks and trigger level lines in the displays are also not corrected, so there is a visual discrepancy between data traces and trigger indicators in the graphs under this condition.

Trace Corrections Versus Data Corrections

Because of the real-time nature of the analyzer and desire to frequently reanalyze stored acquisitions, it is possible to apply amplitude corrections in real time. Applying real-time corrections to the incoming data means that, the correction factors present during the acquisition are already part of the data when the data is stored and then reanalyzed. This also allows the DPX display to maintain its update rate while presenting an amplitude-corrected display.

Real-time gain/loss factors are applied by creating a correction filter that is applied by the same digital signal processing used to correct for calibration and alignment factors in the instrument. This process does have limitations. In creating a digital filter to represent the gain/loss table, a limited number of filter taps are used in order for the filter to be practically realizable. If your amplitude corrections contain discontinuities or extremely sharp transitions, the filter used will contain errors and ringing.

If the above is the case, we recommended that you use trace corrections. These are very similar to a conventional spectrum analyzer, and may be applied to the Spectrum, Spectrogram, Spurious search and Amplitude vs. Time displays. These traces may contain transitions of any type within the maximum and minimum correction values allowed in the tables.

External Loss Tables

Use an External Loss Table to apply a frequency dependent gain/loss correction to the signal. When an External Loss Table is selected, the analyzer adjusts the signal according to the values in the table. An external loss table allows you to compensate the signal level for variations in cable loss, antenna frequency response or preamp frequency response.

You can create external loss tables from the analyzer application and save them as files. External loss tables are saved as plain text files in CSV (Comma Separated Value) format. The tables have a CSV file extension.

You can change the title for each table. However, note that the title is only a label. It is not tied to the file name of any table you may have loaded or saved.



Note: If you are using an External Loss Table for antenna corrections, be sure to set the Amplitude units (Setup > Analysis > Units) to dBuA/m or dBuV/m.

Creating an External Loss Table

You can create an external loss table with the analyzer application. No external application is required.

To create an external loss table:

1. Click **Edit.** to display the Table Editor.

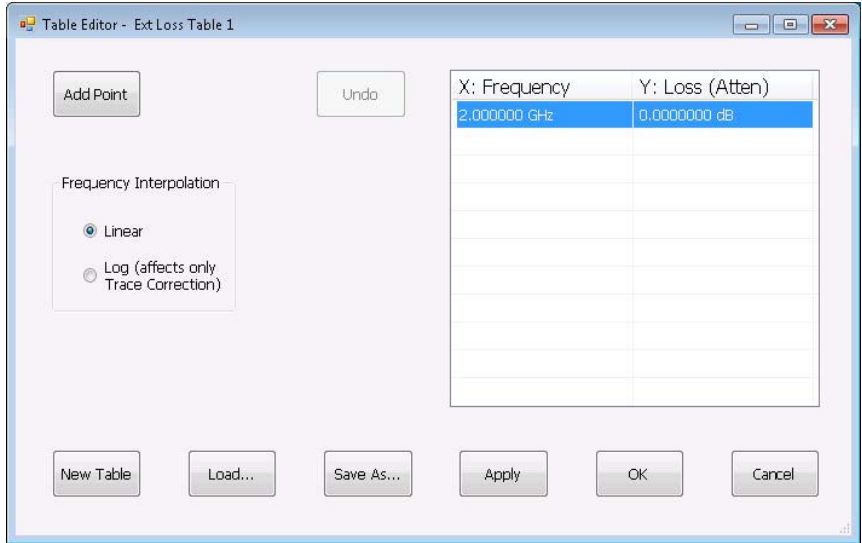

2. Click **New Table** to create a table. This clears all entries in the existing table and loads the default table.
3. To edit values in the table:
 - a. To edit an existing value, double-click on the cell you want to edit.
 - b. To add a new point to the table, click on **Add Point**. Edit the values as required.
 - c. Click **Apply** if you want to test your table without closing the editor (the table must be enabled with the check box in the control panel and measurements must already be running).

To specify a frequency multiplier, you can type K, M, or G.
4. To delete a point from the table, select the point to be removed, and click **Delete**.
5. Select the Frequency Interpolation method:
 - Select Linear when the frequency scale of the spectrum or spurious measurements are linear.
 - Select Log when the frequency scale of the spectrum is logarithmic.
6. When you have entered all the necessary values, click **Save As** (to save the table in a file) or click **OK**.
7. From the Save As dialog, name the file and save it in the desired location.

External loss tables are saved in CSV (Comma Separated Value) format.

Loading an External Loss Table

To load an external loss table file:

1. Click **Edit** to display the Table Editor.
2. Click **Load** to display the Open dialog box.
3. Navigate to the location of the desired file, select it and click Open.
4. Click **OK**.

Controlling the Acquisition of Data

Run Menu: Continuous Versus Single Sequence

Menu Bar: Run > Single Sequence / Continuous



Note: SignalVu-PC must be connected to an instrument to display the Run menu.

Selecting **Single** Sequence sets the acquisition mode so that when you press Run, a single acquisition sequence is performed and the instrument stops once the acquisition sequence is completed. Selecting **Continuous** sets the acquisition mode so that an acquisition sequence is started as soon as you select Continuous and as one acquisition sequence completes, another begins.

Note that an acquisition sequence can require more than one acquisition. For example, in a spectrum view, the trace function might be set to Average 100 acquisitions. Thus, a complete acquisition sequence would consist of 100 acquisitions that are averaged together to create the trace that is displayed.

Run

Menu Bar: Run > Run

Favorites Bar: Run

Selecting **Run** begins a new acquisition/measurement cycle.



Note: SignalVu-PC must be connected to an instrument to display the Run menu.

Run mode specifies whether the analyzer will stop acquiring data after it completes a measurement sequence.

- Continuous: In Continuous mode, once the analyzer completes a measurement sequence, it begins another.
- Single: In Single mode, once the analyzer completes a measurement sequence, it stops.

Resume

Favorites Bar: Run > Resume

Restarts data acquisition, but does not reset accumulated results, such as Average or MaxHold. This allows you to stop acquisitions temporarily, then continue. If the accumulation is already complete, for example, 10 acquisitions or 10 averages have already been completed, each subsequent Resume command will cause one more acquisition to be taken, and its results added to the accumulation. Not available if instrument settings have been changed.



Note: SignalVu-PC must be connected to an instrument to display the Run menu.

Abort

Favorites Toolbar: Run > Abort

Selecting **Abort** immediately halts the current acquisition/measurement cycle. In-process measurements and acquisitions are not allowed to complete. Visibility and accuracy of results is unspecified after an abort.



Note: SignalVu-PC must be connected to an instrument to display the Run menu.

Acquire

Main menu: Setup > Acquire

Favorites toolbar:

Selecting **Acquire** displays the Acquire control panel. The tabs available on this panel vary depending on the connected instruments. This panel enables you to change sampling parameters, view sample rate, view record length, configure frequency reference and timing reference.

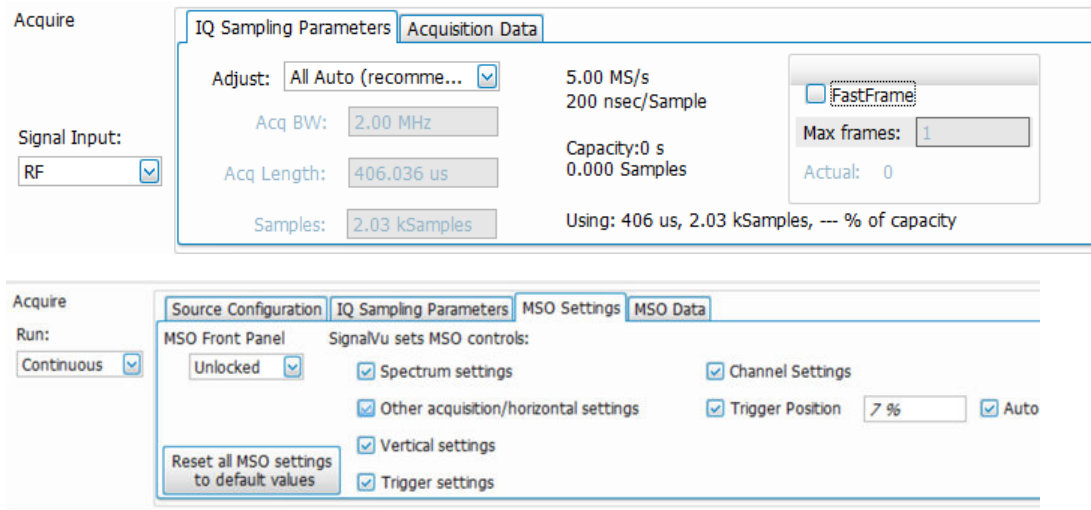

Figure 127: SignalVu-PC when connected to MSO/LPD

The above figure is shown when connected to MSO/LPD.

Signal Input. The Signal Input control can be used when an instrument is connected. The I & Q and Diff I & Q input selections are only valid when an MDO4000B/C is connected.

When Connected to MSO/LPD, multiple incoming signals from different sources (RF / IQ / Differential IQ) can be acquired, analyzed and the results can be viewed at same time in multiple displays.

Setting	Description
IQ Sampling Parameters	Enables you to set the controls for real-time acquisition.
Acquisition Data (Only available when an instrument is not connected)	Displays the sample rate and record length reported by the analyzer.
Advanced (Only available when an RSA7100 is connected)	Enables you to set the preselector state to control image suppression.
Frequency Reference (Only available when an instrument is connected)	Specifies the source for the frequency reference.

Table continued...

Setting	Description
Timing Reference (Only available when an RSA7100 with Option GPS and an IRIGB connector is connected)	Specifies the source for the timing reference (GPS, PPS, System, IRIGB DC).
Source Configuration	Enables user to select the source(s) type and configure the source.
MSO Settings	Enables user to configure MSO settings through SignalVu-PC.
External Downconverter	Allows the user to enable and configure External Downconverter(s) connected to the instrument.

Selecting Source Type

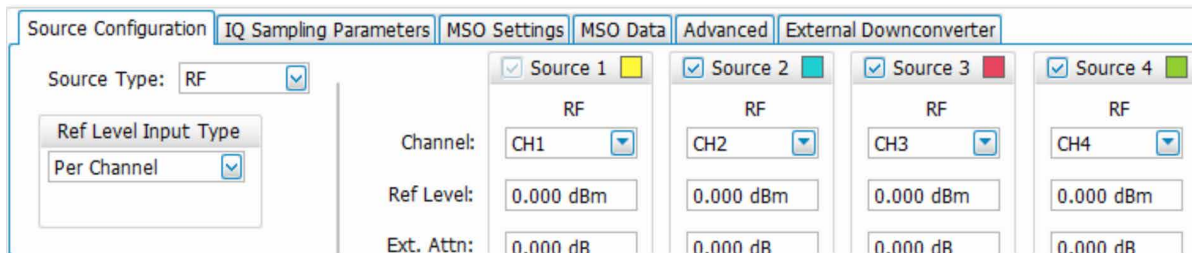

Figure 128: RF Source Type

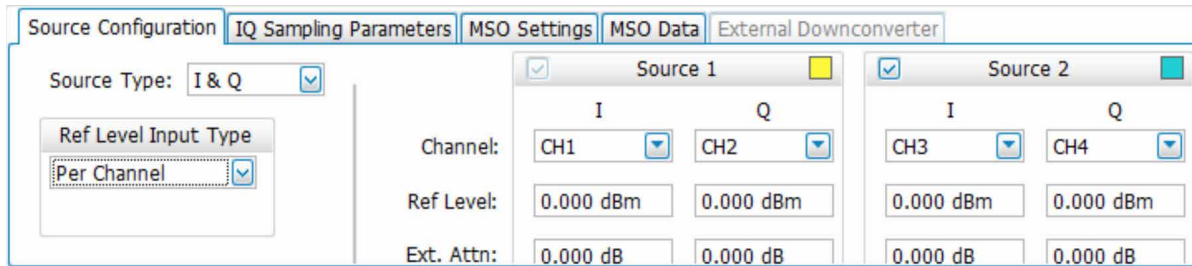

Figure 129: IQ Source Type

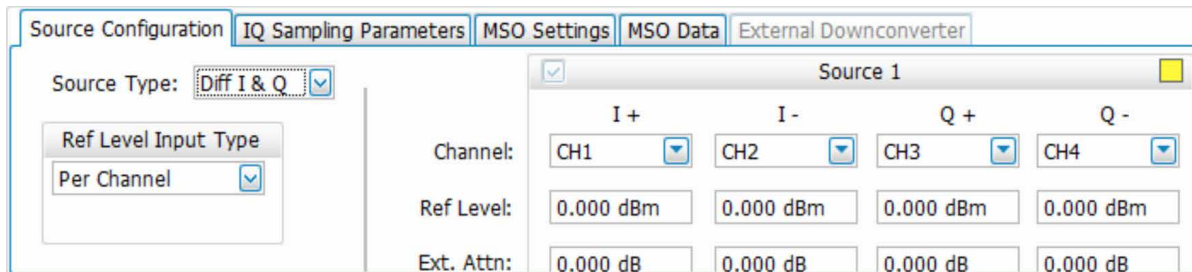

Figure 130: Diff IQ Source Type

Source Type	Description
RF Source Type	Select when each source need to be configured to any channel of the instrument connected. The number of sources and number of channels connected to instrument are equal.
IQ Source Type	Select when each source is a combination of I, Q and can be configured to any of the two channels of connected instrument.

Table continued...

Source Type	Description
Diff IQ Source Type	Selected when each source is a combination of I+, I-, Q+, Q- and can be configured to any of the four channels of connected instrument.

IQ Sampling Parameters

The IQ Sampling Parameters tab enables you to set the controls for real-time acquisition. Normally, the best results are achieved by leaving the Adjust control set to the recommended setting of All Auto. This allows the settings to be automatically adjusted for selected measurements. Depending on the setting chosen for Adjust, two additional parameters can be set.

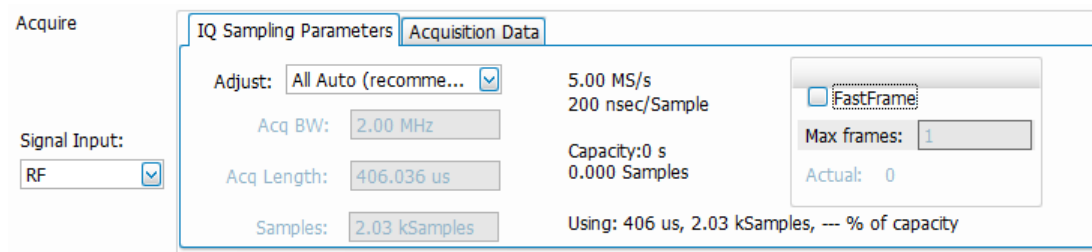

Sampling control

Adjust	User Sets	Analyzer Calculates
All Auto	N /A	N /A
Acq BW / Acq Samples	Acq BW	Acq Samples
Acq BW / Acq Length	Acq BW	Acquisition Length

Acquisition Memory Usage

The center portion of the tab shows how the acquisition memory is used.

Readout	Description
Samples/s, sec/Sample	Readout of the acquisition sample rate and sample period.
Capacity	The maximum period of time and number of samples that can be acquired with the current sampling parameters.
Using	The total amount of acquisition memory that will be used based on the current settings.

Fast Frame

Fast Frame is a feature that allows you to segment the acquisition record into a series of frames, or data records. A typical use of Fast Frame is to record data samples around signal events of interest, while not wasting memory on irrelevant data between these events.

Fast Frame is only valid for real-time acquisitions. If any measurement is configured for swept acquisitions, the following error message is displayed: *Disabled: Fast Frame does not support swept settings.*



Note: Fast Frame is only available when an RSA7100 is connected.

Acquire

Run:

IQ Sampling Parameters | **Advanced** | Frequency Reference

Adjust: 62.5 MS/s
16.0 nsec/Sample

Acq BW: Capacity: 0 s
0.000 Samples

Acq Length: Using: 225 us, 14.1 kSamples, --- % of capacity

Samples:

Fast Frame
 Fast Frame
Max frames:
Actual: 1

Setting	Description
Fast Frame	Enables Fast Frame acquisition mode when box is checked.
Max frames	Specifies the maximum number of frames to record in a single acquisition process.
Actual	Shows the actual number of frames that will be acquired into the acquisition memory. This number changes based on the Acq BW, Acq Samples, and Acq Length values. This number will never be greater than the value set by Max frames.

Acquisition Data

The Acquisition Data tab lists the Sample Rate and Record length of the recalled acquisition data file.

This tab is only available when not connected to an instrument.

Acquire

IQ Sampling Parameters | **Acquisition Data**

Signal Input:

Sample Rate: -- S/s

Record Length: -- Samples

Source Configuration

Source Configuration tab allows you to select source type and configure the source(s) when connected to MSO/LPD. Coupling, Termination, and Bandwidth are pre-defined for a particular instrument.

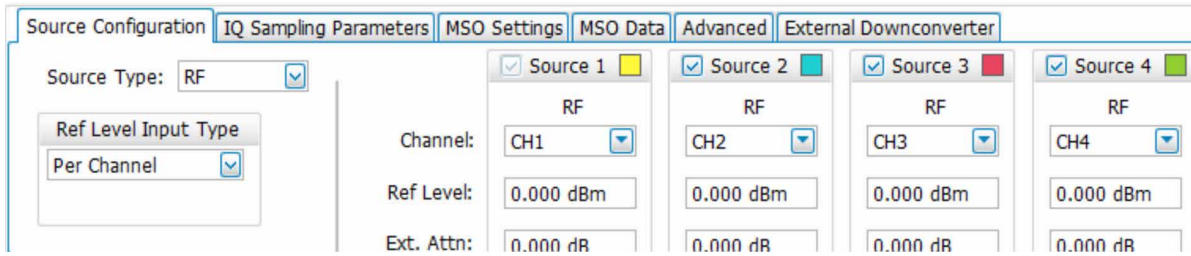

The above figure is shown when connected to MSO/LPD.

		MSO Model:		
		MSOX4 / LPD64	MSOX6	MSOX8
Source Type:	RF	4	6	8
	IQ	2	3	4
	Differential IQ	1	1	2
		x = 5/6/5B/6B		

The above table shows number of sources available based on the source type selected for different MSO models.

Parameters	Description
Source type	Select to configure the input signal as RF, IQ and Diff I&Q.
Source	Select or de-select the measurement source for analysis. The number of Sources depends on the input source type.
Channel	Select the MSO/LPD channels to configure the source.
Ref level	Enter the reference level to be set on MSO/LPD channels
External Attenuation	Enter the external attenuation value to be set on MSO/LPD channels
Deskew	Enter the Deskew value to be set on MSO/LPD channels

Reference level

There are 3 different ways to configure reference level for MSO/LPD

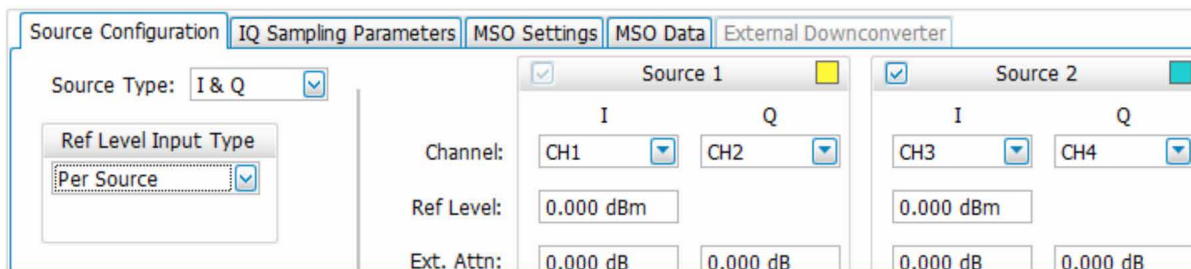

The above figure shows when connected to MSO/LPD

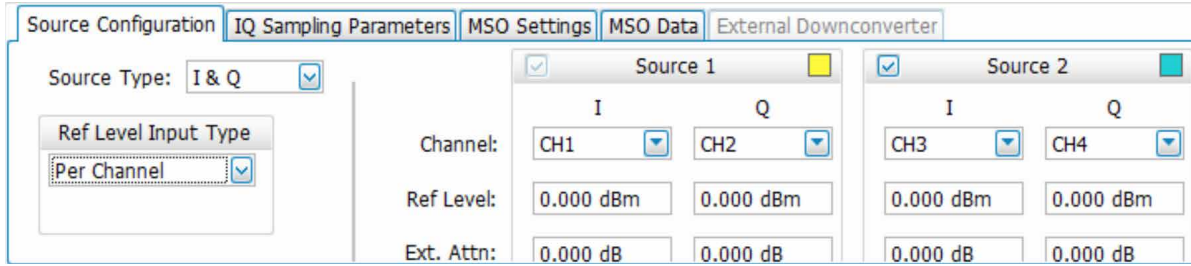

The above figure shows when connected to MSO/LPD

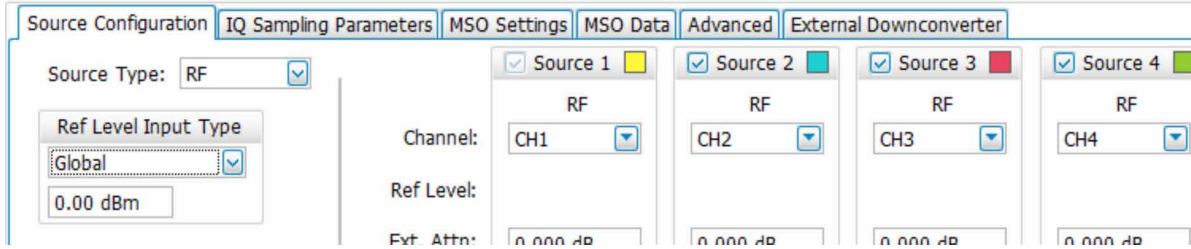

The above figure shows when connected to MSO/LPD

per channel	Allows Reference level to be set on each channel independently.
per source	Allows Reference level to be set on each source independently. All the channels corresponding to that Source use the same Reference Level.
Global	Reference level is common across all the channels. Global Reference Level corresponds to Source 1 Reference Level.

MSO Settings

When connected to MSO/LPD, MSO Settings tab enables user to configure MSO settings through SignalVu-PC.

Settings	Description
MSO front panel	Unlock to enable the remaining settings.
Spectrum settings	Select to control Spectrum settings of MSO.
Other Acquisition/Horizontal settings	Select to control Acquisition/Horizontal settings of MSO.
Vertical Settings	Select to control Vertical settings of MSO.
Trigger Settings	Select to control Trigger settings of MSO.
Channel Settings	Select to control Channel settings of MSO.
Trigger Position	Select to specify the Trigger position in MSO.
Reset All MSO Settings	Select to reset all the MSO Settings.

Advanced

The Advanced tab is available only when an RSA7100 is connected. It contains the preselector setting. The preselector uses input filters for image suppression when the span of the instrument allows for their use.

Two methods of preselection are used in the RSA7100: a fixed low-pass filter (LPF) and a tunable bandpass filter (BPF). Due to the narrow-band nature of the tuned BPF, it is necessary to bypass this filter for wideband analysis of signals with bandwidth >50 MHz. The tuned BPF preselector is enabled depending on the acquisition mode (swept or real-time), frequency range, and user selection of preselector state (Auto, On, Off). The LPF preselector is naturally wideband, so that filter is always present, even when the preselector Off mode is manually selected.

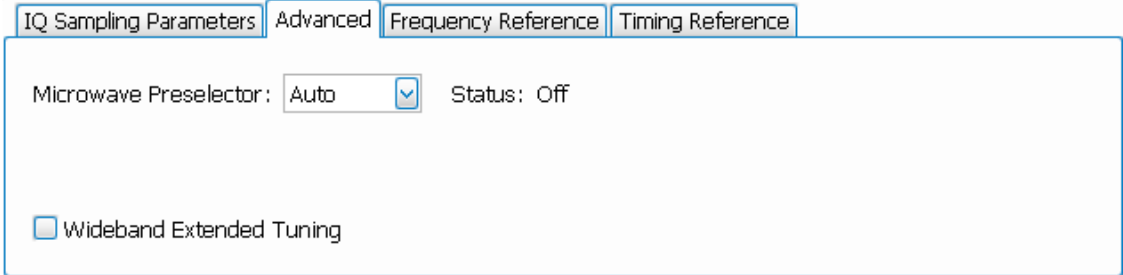

Microwave preselector setting	Description
Auto	This setting balances maximizing acquisition bandwidth with image suppression. The analyzer will operate up to its maximum acquisition bandwidth and may turn off the microwave preselector to accommodate this. When the requested span exceeds the acquisition bandwidth, the microwave preselector is engaged and the step size used is 50 MHz/step. This is the default setting.
On	This setting sets the preselector to always be on, independent of span. When the span exceeds 50 MHz, the instrument is stepped in frequency to create the display.
Off	This setting bypasses the preselector filters (except for the LPF, which is always present) when the span is greater than the allowed acquisition bandwidth. The maximum available real time span is equal to the maximum available acquisition bandwidth at the selected frequency. When the span of the analysis exceeds the available acquisition bandwidth for the selected frequency, the step size of the sweep is set to 320 MHz.
Wideband Extended Tuning (RSA7100 with Option B800 only)	Check the box to enable for tuning down to a center frequency of 3.2 GHz at an acquisition bandwidth of 800 MHz. The default is On and the setting does not change by Preset.

800 MHz sweep mode (RSA7100 with Option B800 only)

To set the acquisition BW to 800 MHz, you need to select Minimize Sweep Time as the RF & IF Optimization setting in the Internal Settings tab in the Amplitude control panel (Favorites toolbar: ). Note that the start frequency must be set to >3.2 GHz to view 800 MHz. A start frequency of <3.2 GHz will result in a set BW of 320 MHz (with preselector Off).

The following table shows the microwave preselector state by acquisition mode.

Acquisition mode	Auto	On	Off
Swept, 50 MHz steps	On	On	CF ≤ 3.6 GHz: On CF > 3.6 GHz: Off

Table continued...

Acquisition mode	Auto	On	Off
Swept, 320 MHz steps	Not applicable	Not applicable	CF ≤ 3.41 GHz: On CF > 3.41 GHz: Off
Real time span ≤ 50 MHz	On	On	CF ≤ 3.6 GHz: On CF > 3.6 GHz: Off
Real time span > 50 MHz	CF ≤ 3.41 GHz: On CF > 3.41 GHz: Off	Not applicable	CF ≤ 3.41 GHz: On CF > 3.41 GHz: Off

Frequency Reference

This tab is only available when an RSA306B, RSA500A series, RSA600A series, or RSA7100 instrument is connected. Available selections depend on which instrument is connected.

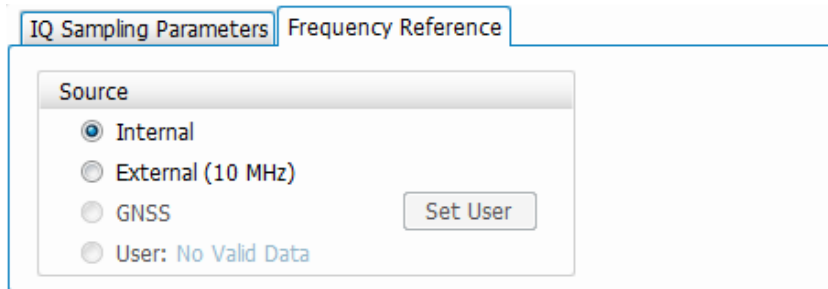

Setting	Description
Internal	Uses the internal 10 MHz clock of the connected instrument as the reference frequency.
External	For the RSA306, RSA306B, and RSA7100 instruments, 10 MHz is the only allowed reference. For the RSA500A series and RSA600A series instruments, a broad selection of external reference frequencies are allowed. If you select External, the instrument will auto-detect the external reference and attempt to lock to this reference if it falls within acceptable accuracy range of the "defined" frequencies. If no external signal is detected, or the instrument cannot lock to the connected signal, it will revert back to Internal reference after displaying a dialog box indicating it could not lock.

Table continued...

Setting	Description
GNSS <i>(Only available when an RSA500A series, RSA600A series, or RSA7100 instrument is connected.)</i>	<p>Selectable when GNSS is enabled from Setup > GNSS/Antenna.</p> <p>When selected, the analyzer will use timing signals from the internal GNSS receiver to align the internal 10 MHz clock frequency to GNSS reference. Clock frequency adjustment status is shown as one of the following states:</p> <ul style="list-style-type: none"> - Acquiring: Waiting for GNSS receiver lock and performing initial clock frequency adjustment. - Tracking: Updating clock frequency adjustment while GNSS receiver is locked. - Holding: Maintaining last clock frequency adjustment when GNSS receiver is unlocked. <p>If Frequency Reference is changed to another selection, the GNSS-derived clock adjustment is discarded and will restart from the original value if GNSS is reselected.</p> <p>When the GNSS status is Tracking or Holding, click the Set User button to store the current GNSS-derived clock adjustment information in the User setting. The User setting can then be selected as the Frequency Reference source at any time.</p> <p>In Tracking state, the status also includes the quality of the clock correction relative to GNSS timing, as indicated by the following:</p> <ul style="list-style-type: none"> - Low: Clock error is greater than $\pm 200 \times 10^{-9}$ - Medium: Clock error is less than $\pm 200 \times 10^{-9}$ - High: Clock error is less than $\pm 25 \times 10^{-9}$ <p>Once the status is Holding, a date/time stamp will show next to User (see following setting) and that setting will become selectable.</p>
User <i>(Only available when an RSA500A series or RSA600A series instrument is connected.)</i>	<p>Selectable when a GNSS frequency reference setting has been saved with the Set User button. The date and time at which the setting was saved are displayed. This setting is the default setting for this tab if a valid User setting has been saved. The User setting information is stored on the PC and so will not be available if the device is connected to a different PC.</p>
Set User button <i>(Only available when an RSA500A series or RSA600A series instrument is connected.)</i>	<p>This button is available when a GNSS acquired frequency reference has been acquired after selecting GNSS. Clicking this button saves the frequency reference and enables the User setting.</p>



Tip: See the [Features by product](#) topic for more information about which features are available with which connected analyzers.

Timing Reference

The Timing Reference tab is part of the Acquire control panel. It is only available when an RSA7100 with Option GPS is connected (units with an IRIG-B connector). This tab allows you to specify the following sources for the timing reference.

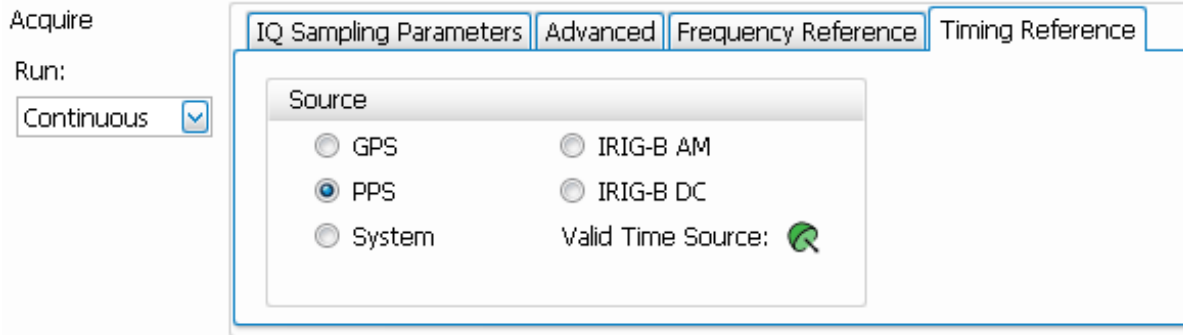

Setting	Description
GPS	Specifies the timing reference for GPS from the GPS/Antenna connector on the instrument front panel. Click the icon or select Setup >GNSS/Antenna from the Main menu bar of the SignalVu-PC application to access the GNSS and Antenna tabs in the GNSS/Antenna control panel. From there you can set GNSS source and baud rate and antenna settings.
PPS	Specifies the timing reference for PPS (Pulse Per Second) from the 1 PPS connector on the instrument front panel. The time code of that signal is used to set the time of SignalVu-PC.
System	Set the timing reference to local PC time. This is the default setting.
IRIG-B AM	When an IRIG-B signal is connected to the instrument using the IRIG-B connector on the front panel, the system first checks if an IRIG-B AM signal is present. If detected, the time code of that signal is used to set the time of SignalVu-PC.
IRIG-B DC	When an IRIG-B signal is connected to the instrument using the IRIG-B connector on the front panel, the system first checks if an IRIG-B DC signal is present. If detected, the time code of that signal is used to set the time of SignalVu-PC.
Valid Time Source indicator	This dish icon indicates the lock status of the selected time source. Green indicates that the system is locked to the selected time source. Yellow indicates that the system is not locked to the selected time source.

Time stamps and timing reference sources

- The default timing reference source upon launch of SignalVu-PC is system time.
- If you change the source in the Timing Reference tab in the UI from default to one of the externally generated sources (GPS, PPS, IRIG-B) without a valid signal, the time will remain system time.
- If you set the source to GPS, PPS, or IRIG-B after launch of SignalVu-PC (thus changing the time from the default system time), and then disconnect from that source or otherwise lose the lock to that source, the time used will be that of the previous externally generated source. This will remain so until you set a different source with a valid signal.

GPS, PPS, and IRIG-B sources will update the xmrk file to include the following parameters: `timestamp_source` to indicate last valid signal type, `event_code` to indicate software_marker, and each signal pulse to be noted with a time and sample number. All other event codes, such as triggers and acquisition status events, will reference the last valid external timing reference signal.

Stored information

When recording with the XDAT format selected, a marker file (.xmrk) is generated that lists time, location (GPS only), and the time stamp of the GPS, PPS, or IRIG-B event during recording. You can read more about file formats and what they contain in the [Saved File Types](#) and the [Record Setup](#) topics.

IRIG-B signals

You can use the IRIG-B connector on the RSA7100 to connect to an IRIG-B signal generator. SignalVu-PC allows you to select one of two IRIG standard signals to use for timing reference. IRIG-B is the standard for 1 kHz IRIG signals with frame lengths of 1 second. SignalVu-PC can detect IRIG-B AM and DC signals.

- IRIG-B detection is only available on RSA7100 units with Option GPS and an **IRIG-B** connector.
- When switching from any time reference to IRIG-B, it takes several seconds for the time to update with a valid signal.

PPS signals

A PPS (Pulse Per Second) source can be used as a timing reference to sync multiple devices. You can use the 1 PPS connector on the RSA7100 to sync the RSA7100 to a source.

- The PPS selection is only available on RSA7100 units with Option GPS and a **1 PPS** connector.

External Downconverter

The External Downconverter tab is available when RSA or 5/6 Series MSO is connected to SignalVu-PC. It allows you to configure the external downconverter settings connected with the instrument. This can help you to analyse and visualize the RF signals at the actual input frequency of downconverter.

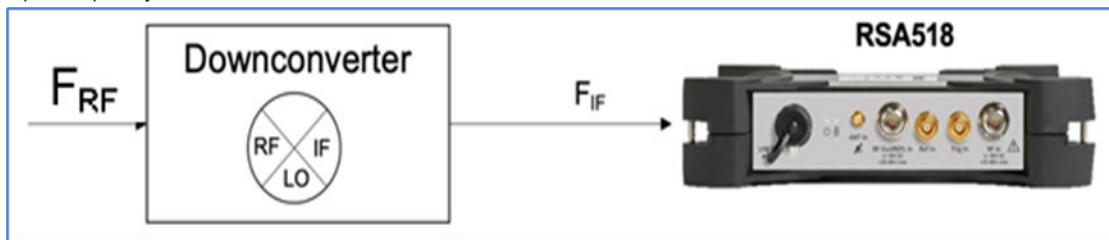

You can enable the downconverter for any source(s), configure the LO frequency, and the instrument bandwidth sub-range to be used. You can also choose between Low or High Injection side. Based on the above configured parameters, enter the range of input frequency. If you select High Injection side, the spectrum inversion takes place.

	Instrument Bandwidth		Downconverter On	LO Frequency	Injection	Input Center Frequency Range	Spectrum Inverted
Source 1	0.000000 Hz	8.00000 GHz	✓	1.00000 GHz	Low Side	1.00000 GHz - 9.00000 GHz	No
Source 2	0.000000 Hz	8.00000 GHz		1.00000 GHz	Low Side	1.00000 GHz - 9.00000 GHz	No
Source 3	0.000000 Hz	8.00000 GHz		1.00000 GHz	Low Side	1.00000 GHz - 9.00000 GHz	No
Source 4	0.000000 Hz	8.00000 GHz		1.00000 GHz	Low Side	1.00000 GHz - 9.00000 GHz	No

Figure 131: External Downconverter tab when connected to MSO.

Parameter	Description
Instrument Bandwidth Minimum	Configures the minimum value of the instrument bandwidth being used.
Instrument Bandwidth Maximum	Configures the maximum value of the instrument bandwidth being used.
Downconverter On	Enables/disables the external downconverter for a source.
LO Frequency	Configures the LO frequency for external downconverter.
Injection Side	Configures injection side as Low or High <ol style="list-style-type: none"> 1. Low Injection side : When Input CF > LO 2. High Injection side : When Input CF < LO
Input Center Frequency Range	Based on the instrument bandwidth range, LO frequency, and Injection side, user can configure the input CF range.
Spectrum Inverted	When high side is selected, spectrum inversion happens.

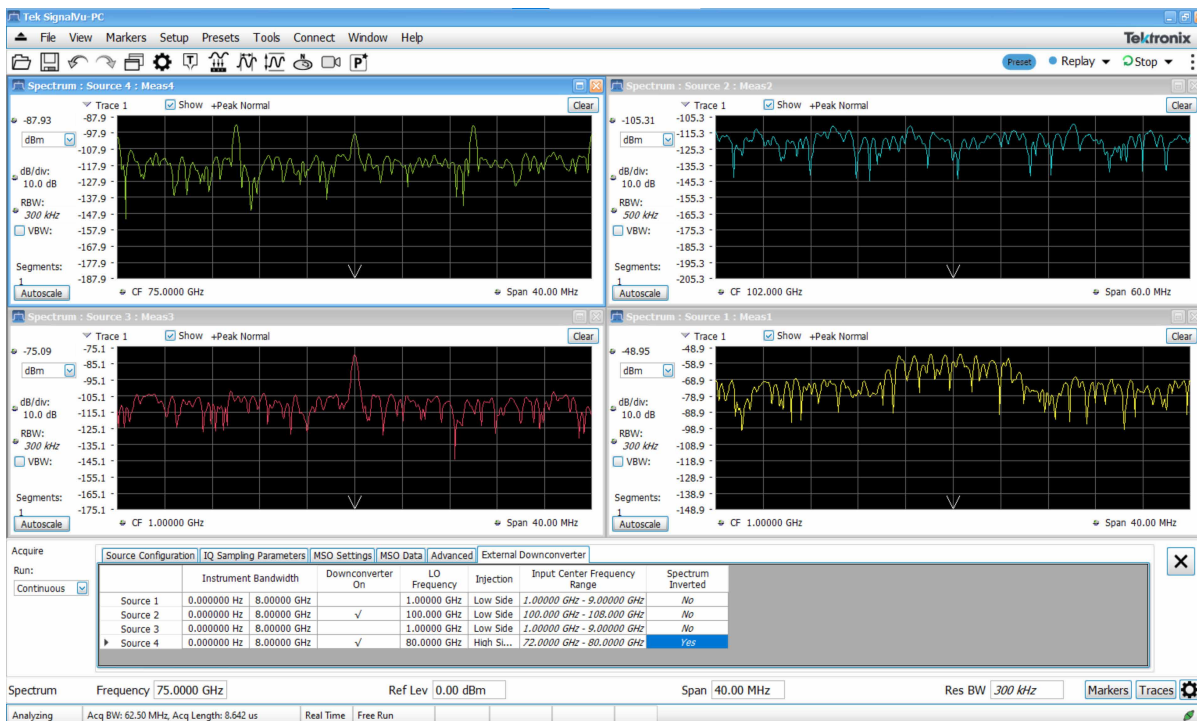

Figure 132: Source 4 with external downconverter enabled.

Controlling the Acquisition of Data

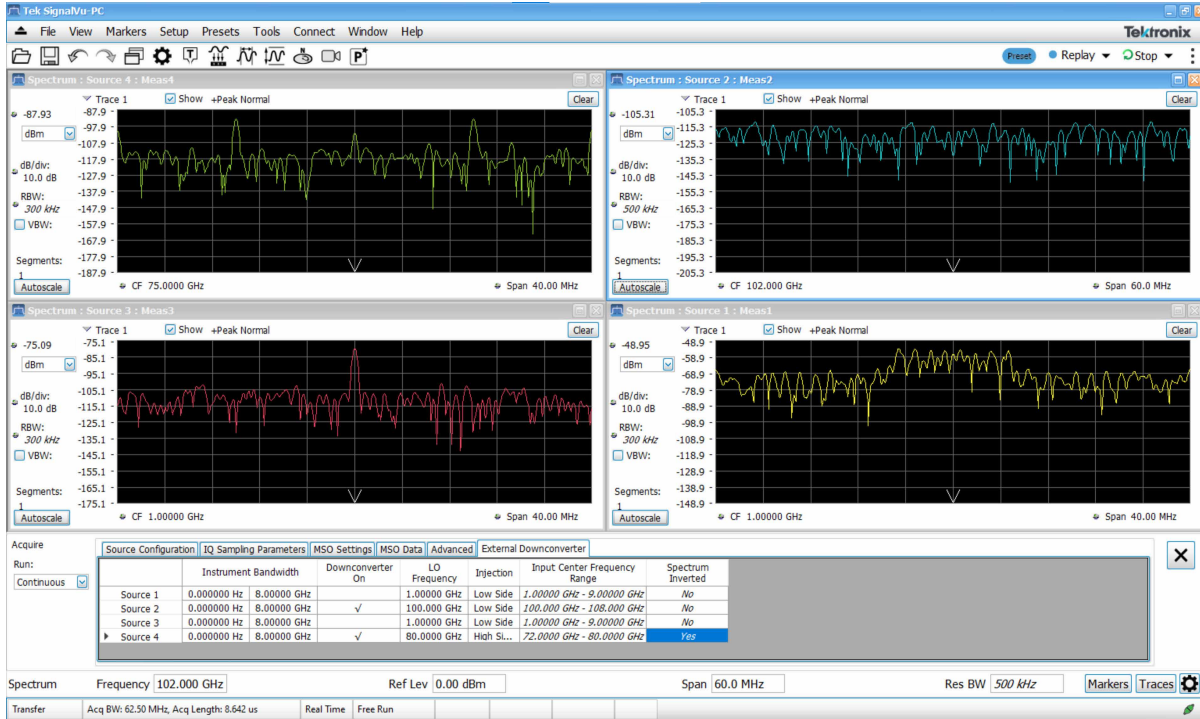

Figure 133: Source 2 with external downconverter enabled.



Figure 134: External downconverter enabled for different sources.

The Recording Control Panel

Main menu: **Setup > Recording**



Selecting **Recording** displays the Recording control panel. This panel contains tabs that allow you to access the functions in the following table. You can play back recorded files with an optional playback feature. Playback can only play files that were recorded using the Formatted data structure, although you can use other applications, such as MATLAB, to read files recorded in any of the file formats.

Playback of recorded files is available for the RSA7100 when using an external application. The Playback feature described in this topic is not available for use with the RSA7100. You can read more about file formats used by the RSA7100 [here](#).

You can purchase Option SV56-SVPC to enable the Playback tab when connected to the RSA306, RSA306B, and RSA500A and RSA600A series instruments.

Tab	Description
Record Setup	Enables you to define the save location, base filename, and data structure of the recording.
Record	Records the acquisition data directly to a file.
Playback (Requires Option SV56-SVPC) (Not available on the RSA7100.)	Plays the saved files recorded with the Record feature. Playback only plays .r3f file formats.



Tip: See the [Features by product](#) topic for more information about which features are available with which connected analyzers.

Record Setup

The screenshot shows the 'Record Setup' tab of the software interface. It contains three tabs: 'Record Setup', 'Record', and 'Playback'. The 'Record Setup' tab is active and displays the following configuration options:

- Location:** A text field containing 'C:\SignalVu-PC Files' and a button with three dots to the right.
- Base filename:** A text field containing 'DATA'.
- File format:** A dropdown menu with 'Formatted (R3F)' selected.

Figure 135: The above image shows the Record Setup tab when a RSA306B, RSA500A Series, or RSA600A Series is connected.

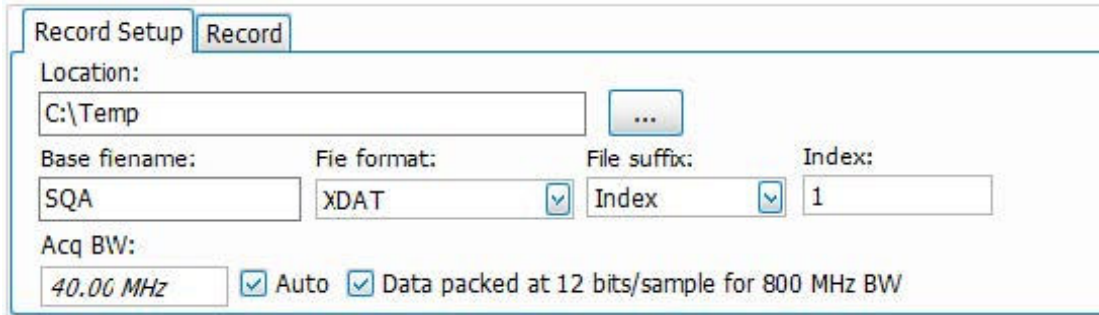

Figure 136: The above image shows the Record Setup tab when a RSA7100 is connected.

The Record Setup tab allows you to set the following:

Setting	
Location	Sets the destination folder or directory for the recorded file(s).
Base file name	Enter a base name that will be used for all recorded files. This base name is appended with additional information, creating unique file names.
File format (Only available when a RSA is connected)	Choose the output data file format. Files created with the Recording feature: Raw recordings contain instrument setting and other information in a separate file from the raw ADC samples. Formatted recording files contain all information in a single file. If you are using the RSA306, RSA306B, RSA500A series, or RSA600A series, the API programming manual has more detailed information about the data files created with the Recording feature.
Formatted (R3F) (Not available for the RSA7100)	Formatted files for IF data are created, ending with a .r3f suffix, and contain a single Header info block, followed by blocks of data and status information. Each data block is called a frame which is 16384 bytes (16 kB) in size. Formatted files can only contain complete frames.
Raw (R3H+R3A) (Not available for the RSA7100)	Unformatted files for IF data are created. Raw recordings contain instrument setting and other information in a separate file from the raw ADC samples. Two files are created for each recording, a header file (.r3h) and the raw data file (.r3a). Raw data files contain only ADC samples. The samples are contiguous, with all transport frame information removed before storage. The header file, if available, contains the Config data which can be used to interpret and scale the ADC data samples for further processing.

Table continued...

Setting	
XDAT (RSA7100 only)	<p>Generates 3 output files (all with the same file name) for each recording run. The files are as follows:</p> <p>.xdat: sample data file containing binary IQ samples in normal (16 bit integer) or packed (12-bit integer) data type.</p> <p>.xhdr: header file containing instrument setup information in XML format.</p> <p>.xmrk: marker file in XML format containing time, location (GPS only), and the time stamp of the GPS, PPS, or IRIGUID-A88BD14F-0A29-4276-A887-CB84AB2B2A94B event during recording.</p>
Midas 2.0 (CDIF)	<p>Generates a combined file (.cdif) containing header and data samples in Midas 2.0 (Platinum BLUE) format. Uncorrected IF samples are stored by the RSA306B, RSA500A and RSA600A. Corrected IQ samples are stored by the RSA7100.</p> <p>When using the RSA7100, recordings cannot be saved as CDIF for acquisition bandwidths above 320 MHz with the packed data setting on.</p> <p>See the Midas recording choices table on page 770 for more information.</p>
Midas 2.0 Detached (CDIF+DET)	<p>Generates separate header (.cdif) and sample data (.det) files in Midas 2.0 (Platinum BLUE) format. Uncorrected IF samples are stored by the RSA306B, RSA500A and RSA600A. Corrected IQ samples are stored by the RSA7100.</p> <p>When using the RSA7100, recordings for acquisition bandwidths above 320 MHz with the packed data setting on will generate a .cdif and a .det12 file.</p> <p>See the Midas recording choices table on page 770 for more information.</p>
File suffix (RSA7100 only)	<p>Allows you to select a filename suffix to append to the output base filename. You can select from the following:</p> <p>Timestamp: Formed from the file creation time. For example, <i>myfile-2018.08.15.09.33.12.522.xmrk</i></p> <p>None: Base filename is used without a suffix. For example, <i>myfile.xmrk</i>.</p> <p>Index: For example, <i>myfile-00004.xmrk</i>. Value can be an integer between 0 and 99999.</p>
Index (RSA7100 only)	<p>When Index is the selected file suffix type, this field becomes available. Enter an index value (integer) between 0 and 99999.</p>
Acq BW	<p>Shows the current acquisition bandwidth. Check the Auto box to automatically set this value. Uncheck the Auto box to set it manually.</p>
Data packed at 12 bits/sample for 800 MHz BW (RSA7100 only)	<p>For acquisition bandwidths above 320 MHz, data is packed at 12 bits/sample to avoid gaps in the streamed recording. If you require 16-bit samples, uncheck the box.</p> <p>You can convert 12-bit data to 16 bits/sample using DataVu-PC or the unpacking utility. Streaming unpacked data at 800 MHz bandwidth may result in occasional small gaps in the recording.</p>



Note: You can read about the formatted data structure (.xcom) for files recorded using the RSA7100 in the [Data Settings and Picture File Formats](#) topic.

Midas recording choices table

Acquisition bandwidth	Sample bitwidth	Combined file	Detached file
≤320 MHz	16b	Yes (.cdif)	Yes (.cdif + .det)
800 MHz	16b	Yes (.cdif)	Yes (.cdif + .det)
(> 320 MHz (CF > 3.6 GHz, RSA7100 only)	12b	No	Yes (.cdif + .det12) ⁷

Unpacking packed saved files to RAID in the RSA7100

DataVu-PC provides a more complete unpack mechanism through its Export function than the utility described here. However, if you are going to use the .xdat file with an application other than DataVu-PC, you can use this unpacking utility to convert 12 bits/sample data to 16 bits/sample data. Note that the unpacking utility does not generate header or marker files.

1. Open a command prompt in Windows from the CTRL7100.
2. Type the location of the file you want to unpack.
3. Type **unpack** after the command prompt. You will then see a usage command with arguments after it.

```
Administrator: Command Prompt - unpack slugger-2016.10.27.17.14.21.030.xdat unpacked...
D:\>unpack
Usage: Unpack <packed file path> <unpacked file path> [output file size]
D:\>unpack slugger-2016.10.27.17.14.21.030.xdat unpacked.xdat
```

4. After the next command prompt, type the following:
 - a. **unpack**
 - b. Input file name (the file you want to unpack). For example, **packed.xdat**.
 - c. Enter a space using the spacebar.
 - d. Output file name (the unpacked file you are saving). For example, **unpacked.xdat**. This must be an .xdat file type. You can also specify a location to which the file is saved.
5. If desired, enter an output file size. If the output size is smaller than the input size, the output file will contain the first portion of the input file up to the specified file size.
6. Press the Enter key to execute the command.
7. Navigate to the location to the unpacked file.

Record

The recording feature lets you record the acquisition data directly to a file. Selections on this tab vary depending on the connected instrument.

⁷ Use the unpacking utility to convert a 12-bit .det12 file to a 16-bit .det file.



Note: SignalVu-PC does not accept changes while recording is active. Stop the current recording session to change settings. Changing settings during streaming will result in start of a new streaming file.

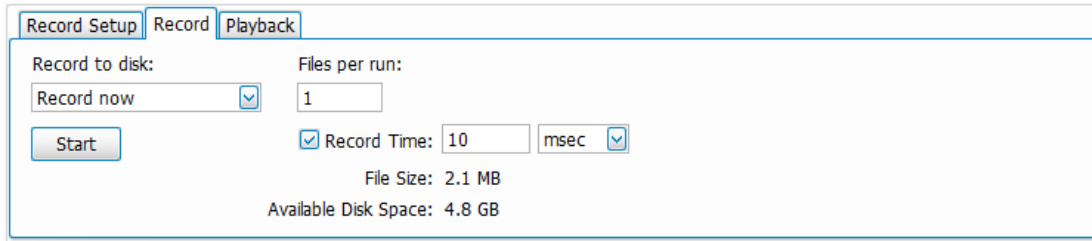

Figure 137: The above image shows the Record tab when Record Time is selected (when the RSA500A series, RSA600A series, or RSA306B is connected).

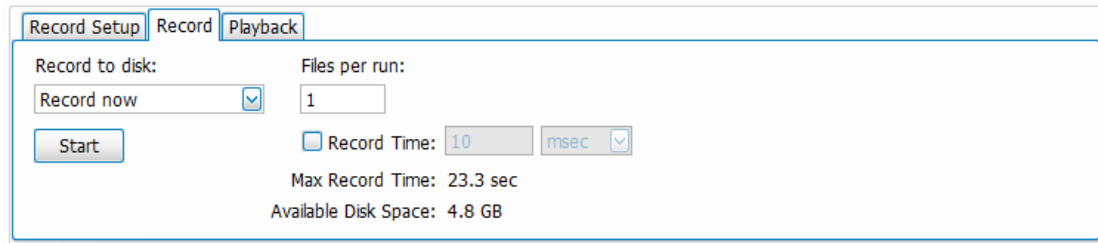

Figure 138: The above image shows the Record tab when Record Time is not selected (when the RSA500A series, RSA600A series, or RSA306B is connected).

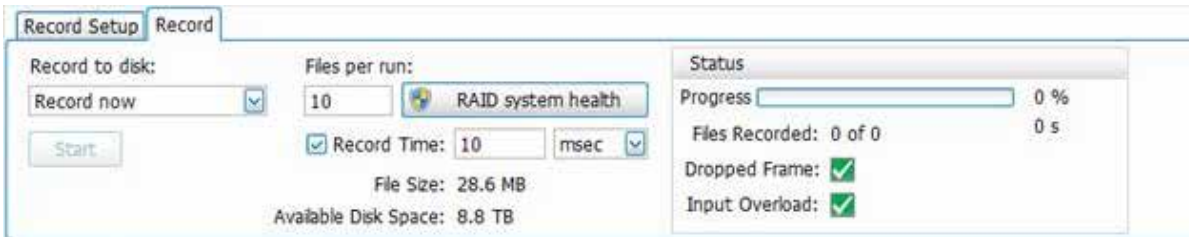

Figure 139: The above image shows the Record tab when the RSA7100 is connected.

The Record tab allows you to set the following:

Setting	
Record to disk:	
Record now	Data recording starts immediately when the Start button is pressed. Data is continuously recorded until either stopped by the Start (Stop) button or the Record Time condition is met. If Record Time is enabled, then pressing the Start button will result in creating the specified number of files (Files per run), each of the specified length (Record Time). If Record Time is disabled, only one file is saved and recording continues until the Stop button is pressed (or the specified save location runs out of space).

Table continued...

Setting	
Record on trigger	<p>Data recording starts when an appropriate trigger signal is received (triggering must be separately enabled in the Trigger control panel).</p> <p>If Record Time is enabled, then pressing the Start button will result in creating one file per trigger for the specified number of files (Files per run), each of the specified length (Record Time).</p> <p>If Record Time is disabled, only one file is saved and recording continues until the Stop button is pressed (or the specified save location runs out of space).</p>
Start	<p>The Start button is enabled when the Record to disk is set to Record now or when Triggering is enabled and Record to disk is set to Record on Trigger.</p> <p>Pressing Start begins the data recording. The button changes to Stop and recording continues until pressed or the Record Time condition is met.</p>
Files per run	<p>This determines how many files are created of the specified Record Time length.</p> <p>If Record Time is disabled, then this setting is ignored and only one file is recorded when Start is pressed.</p> <p>Maximum number of files per run is 1 million.</p>
RAID system health (RSA7100 only)	<p>Launches an application that allows you to view the % life remaining (i.e., number of writes left to the drive) in each installed RAID drive. This application must be run as an Administrator. When the application launches, click the Query System Health button to run the query and view the results.</p>  <p>Click on an Identify button to light the LED next to the specific drive on the CTRL7100.</p>
Record Time:	<p>Record Time is enabled by default. This determines how much data (time in milliseconds, seconds, or minutes) is recorded after recording starts.</p> <p>Disabling Record Time allows the recording to continue until the Stop button is pressed (or the specified save location runs out of space).</p>
File size	<p>Indicates the size of each recorded file. This item is only displayed when Record Time is enabled.</p>

Table continued...

Setting	
Max Record Time	<p>Indicates the maximum length of the record time based on available disk space.</p> <p>This setting indicates the longest Record Time possible with current acquisition settings and Available Disk Space.</p> <p>This item is only displayed when Record Time is disabled.</p>
Available Disk Space	Indicates the amount of disk space available for recording.
Status (RSA7100 only)	
Progress	Indicates the current progress of the recording.
Files recorded	Indicates how many of the selected number of files to record per run have been recorded.
Dropped Frame	<p>Indicates a missed frame has been detected in the recording.</p> <p>The Marker file (.xmrk) indicates the sample in which the Dropped Frame is detected. If the recording is done using the unpack data format and the acquisition bandwidth is equal to 800 MHz, you can select the packed data format to reduce Dropped Frame.</p>
Input Overload	<p>Indicates if an overload has been detected in the record.</p> <p>The Marker file (.xmrk) indicates the sample in which the Input Overload is detected. You can increase the reference level to avoid Input Overload.</p>

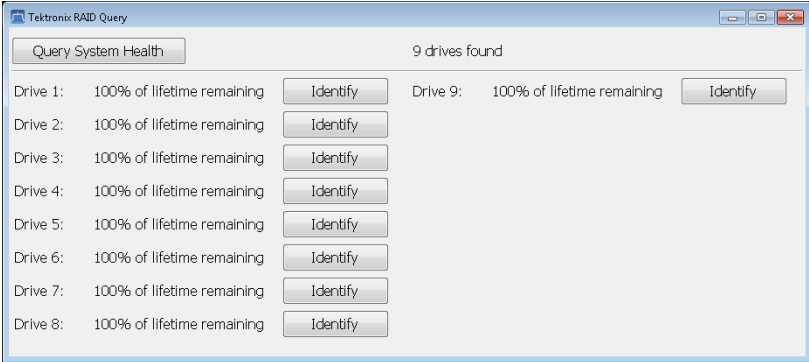

Note: The record feature is best suited for PCs using a solid-state drive (SSD) to achieve the read/write speeds necessary for best performance. Recording performance will be degraded on PCs with slower drives.

Playback

Playback lets you play acquisition files that were recorded with SignalVu-PC's recording feature. Recorded files for the RSA306, RSA306B, RSA500 series, and RSA600 series have a .r3f file extension and only these file types can be played with the Playback feature (Option SV56-SVPC).

The Playback option described in this topic is not available for use with the RSA7100, though playback of recorded files from the RSA7100 can be done using an external application. You can read more about file formats used in recording with the RSA7100 [here](#).



Note: The playback feature is best suited for PCs using a solid-state drive (SSD) to achieve the read/write speeds necessary for best playback performance. Playback performance will be degraded on PCs with slower drives.

If an instrument is connected through the Connect feature, you must first click the Stop button on the Playback tab to enable Playback. SignalVu-PC acquires and analyzes the data of a recorded file as if it were obtaining data from an instrument. Therefore, once you enable Playback, SignalVu-PC disconnects the currently connected instrument. However, the connection indicator will still display as green () because the analyzer treats the playback file as live data acquisition. The Run/Stop toolbar remains active, allowing you to stop and start the playback of the selected file (like the Stop and Play button in the Playback screen).



Note: Most controls in the Playback tab are not active while acquiring live data from a connected instrument. The only control available is the Stop button, which will halt the acquisition of data from the connected instrument. Once acquisition has stopped, the Playback controls become active.

Record Setup | Record | Playback

Location: Progress 0%

Range (%)

Skip: Units: Live rate

Loop file Begin End



Setting	
Location:	Navigate to the location of the recorded file(s).  Note: You can also use the File > Recall menu to navigate to recorded files. You must set the file type (to search for) to ADC sample data (.r3f).
Skip:	Defines the amount of time skipped between frames of the playback data. For long recordings, this allows you to skip portions of the data, allowing you to perform a coarser analysis, but much quicker. The amount of skip cannot be less than the defined acquisition length. The resolution for setting the skip is one USB frame (73 µs).
Units:	Defines the units of the Skip setting (µsec, msec, seconds).
Live rate	This setting forces SignalVu_PC to attempt to play the file at the same rate as when it was acquired, making the playback operation appear to be identical to having the instrument connected. This setting is very useful when listening to audio.
Loop file	When selected, the file selected for playback continues to loop until playback is stopped. If only a portion of the file is selected for playback (with the Begin and End sliders) only that portion is looped.
Playback fields	
Progress	Provides an indication of the current status of the file being played.
Begin	Use the Begin slider to choose a starting point within the recorded file to begin playback.
End	Use the End slider to choose an end point within the recorded file to stop the playback.
Stop/Play	This button toggles between Stop and Play.  Note: The Run/Stop toolbar in the SignalVu-PC application also performs the same functions as the Stop/Play button in the Playback screen.

Table continued...

Setting	
Stop	<p>Stop is displayed while a recorded data file is being played. Pressing Stop halts the playback operation.</p> <p>Stop is also displayed if SignalVu-PC is currently connected to an instrument. Pressing Stop stops the acquisition of data from the instrument.</p> <p>No changes can be made to playback while Stop is displayed.</p>
Play	<p>Pressing Play starts playout of the file defined in the Location field.</p> <p>If SignalVu-PC is connected to an instrument, acquisition of data from the instrument is stopped before the file starts to play.</p>
Exit Playback	<p>Exits the playback mode, disconnecting the recorded file (and the connected status indicates no connection).</p> <p>After you exit playback, you can replay the currently selected file, choose another file to play, or reestablish a connection to an instrument.</p>

Triggering

Trigger configuration

When SignalVu-PC is connected to MSO/LPD only Edge Type Triggering is supported and you can configure the trigger settings with respect to selected trigger source. In this case only Event tab is available

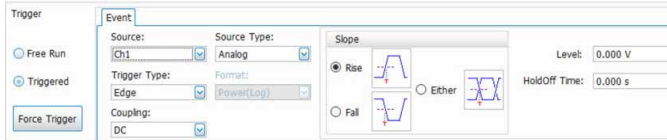

The above figure is shown when connected to MSO/LPD

Table 46: Trigger Configurations

Trigger Setting	Description
Trigger mode	<ol style="list-style-type: none"> Free run : Select to set trigger mode to Auto in MSO. Triggered: Select to set trigger mode to Normal in MSO
Source	Select to specify channel on which signal is to be monitored for a trigger event.
Trigger Type	Set conditioning to apply the source signal trigger circuit from source signal. When connected to MSO/LPD only Edge Type triggering is supported.
Coupling	<ol style="list-style-type: none"> DC coupling passes all input signals directly to the trigger circuitry. HF Reject coupling attenuates signals above 50 kHz before passing the signal to the trigger circuitry. LF Reject coupling attenuates signals below 50 kHz before passing the signal to the trigger circuitry. Noise Reject coupling provides stable triggering by increasing the trigger hysteresis. Increased hysteresis reduces the trigger sensitivity to noise so may require greater signal amplitude.
Source Type	Select the choice of source type: <ul style="list-style-type: none"> Analog Magnitude vs Time Frequency vs Time
Format	Select to sets the vertical scale mode to Amplitude (Vrms) or Power (log).
Slope	Select to determine whether instrument finds the trigger point on rising or falling edge or either edge of a signal.
Level	Determines where the trigger point occurs.
Hold-off Time	Select to set the time after triggering on an event, that the instrument waits before detecting the same trigger event to start the next acquisition.

Trigger source

Main menu bar: Setup > Trigger

Favorites toolbar: 

Click  to view the Trigger control panel. The panel has three controls on the left side and settings tabs on the right side that provide access to various trigger settings.

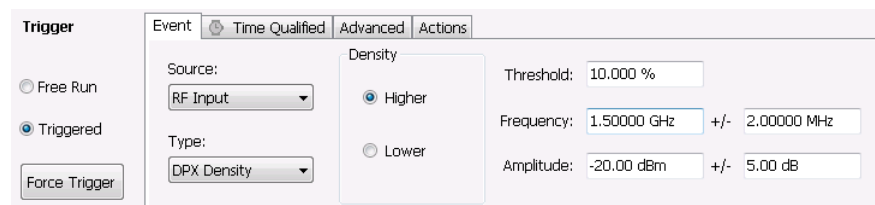

Mode/control	Description
Free Run	Sets the analyzer to acquire without considering any trigger conditions. It is a fast and easy way to see signals. Free Run is usually adequate for the Spectrum display unless you need to specify a particular time at which to collect the data record.
Triggered	Sets the analyzer to initiate an acquisition when a trigger event is recognized. The conditions that define a trigger event depend on the selected trigger source and type.
Force Trigger	Click this button to manually initiate a trigger.

The Source selection allows you to specify the source of the signal to be monitored for a trigger event. The RF Input source has a set of defined trigger types available. The Source and Type drop-down lists are visible on the Event tab.

Click on the links in the following table to jump to the related source information in this topic.

Source	Description	Available types
RF Input	Sets the source for a trigger to the RF Input on the instrument.	Power Frequency Mask DPX Density
External	Sets the source for a trigger to the Ext connector on the rear of the analyzer.	(None)
Internal Time	Sets the source to generate a trigger event at one or more time points based on the analyzer system internal time.	(None)

RF Input

Sets the source for a trigger to the RF Input on the instrument. You can then select the trigger type. See the [Trigger type](#) topic for detailed information about trigger types and their related settings.

External

Sets the source for a trigger to the Ext connector on the rear of the analyzer.

Setting	Description
Slope	The slope control determines whether the analyzer finds the trigger point on the rising or the falling edge of a signal.
External Impedance	Shows the output impedance.

Internal Time



Note: Not available when an MDO4000B/C is connected.

The Internal Time trigger source generates a trigger event at one or more time points based on the analyzer system internal time. The time points are local time zone wall-clock times (e.g., 14:45:13.566 corresponding to 2:45:13.566 pm). A single trigger event, or multiple repeated trigger events, can be specified by clicking **Trigger Time** or **Repeat Interval** in the Event tab and then using the **Configure Internal Time Trigger** dialog.

These dialog controls specify how internal time is used to generate trigger events. Changes to these settings take effect only after you have clicked **OK**. Click **Cancel** to discard changes.



Note: Trigger system time is initialized with the PC system clock when initial connection to the device is done. If the connected device has an internal GPS/GNSS receiver, enabling it and allowing it to lock to GNSS signals automatically aligns the trigger system time to GPS time. This supports high-precision, time-based triggering in these devices.

Configure Internal Time Trigger

Instrument current time: 4:03:18 Set Trigger Time To This

hr min sec

Trigger Time 03 : 55 : 59.83967

Repeat Interval 1.0

Both

Requested trigger time occurs on the next day

OK Cancel

Setting	Description
Trigger Time	<p>Click on the field next to Trigger Time in the Event tab to open the Configure Internal Time Trigger dialog. You can then set the instrument to trigger one measurement acquisition at the specified time. Time values are in 24-hour format. For example, a Trigger Time of 12:34:56.123456 causes one acquisition to be triggered at 123456 μsec after 12:34:56 PM.</p> <p>The minimum resolution of the time value is 1 μsec. If the time value occurs before the current time, the trigger event will be scheduled for that time on the following day and a warning message displayed. When setting the Trigger Time, it is recommended to set the time value at least 5 seconds after the current time to allow the analyzer to set up for the acquisition. After the single trigger acquisition completes, SignalVu-PC is set to Stop state.</p>
Repeat Interval	<p>Click on the field next to Repeat Interval in the Event tab to open the Configure Internal Time Trigger dialog. You can then set the instrument to continuously trigger measurement acquisitions at the specified time intervals. Initial triggering starts as soon as you close the dialog box. For example, a Repeat Interval of 0.5 seconds with an Acquisition Length of 1.1 seconds will result in acquisitions at 1.5 second intervals (or 2.0, 2.5, etc. seconds, if acquisition and processing take more time).</p> <p>Trigger events will be generated at each time point that is an integer multiple of the Repeat Interval value following the arbitrary start point. Minimum setting value and is 1 μsec and the maximum is 600 seconds. Acquisitions will only be taken at trigger times at which the system is armed and ready for a new acquisition. Repeat trigger events continue occurring until triggering is reconfigured or the analyzer is set to Stop state.</p>
Both	<p>This option in the Configure Internal Time Trigger dialog allows you to specify an initial Trigger Time to begin trigger events and a trigger Repeat Interval following the initial trigger time. Once the initial trigger time is reached, further trigger events will be generated similar to Repeat Interval behavior.</p>
Set Trigger Time To This	<p>Click to copy the current time value into the Trigger Time field. This can help with configuring the time setting. When setting the Trigger Time, it is recommended to set the time value at least 5 seconds after the current time to allow the analyzer to set up for the acquisition.</p>

Trigger type

When RF Input is the selected trigger source, you can select from the following trigger types.

(Trigger type selections depend on the connected instrument model.)

- [Power](#)
- [Frequency Mask](#)
- [DPX Density](#)

Power trigger

When trigger Type is set to Power, a transition through an adjustable level of the selected source determines a trigger event. Power triggering triggers the instrument on time-domain signal transitions. The incoming data is compared to a user-selected level in dBm. You can trigger on the rising or falling edge.

If the RF input signal crosses the specified level (in the direction set by the Slope setting), a trigger event occurs. A trigger event does not occur if the power level of the signal simply exceeds the level setting. There must be a power level transient that crosses the specified level.

Setting	Description
Slope	The slope control determines whether the signal analyzer finds the trigger point on the rising or falling edge of the RF input signal.
Level	The Level setting determines the power level that will be recognized as a trigger event. The Level is indicated in the Amplitude vs Time and Time Overview displays with a dark cyan colored-line.
Trigger BW	Trigger BW is a filter used to process the trigger input signal before the trigger system analyzes the signal. The frequency edge trigger point must lie within the range of time domain bandwidth. This makes the range of the frequency edge trigger = Center Frequency \pm (0.5 \times Trigger Bandwidth)

To trigger acquisitions based on the power of the signal:

1. Click the **Triggered** option button.
2. Select **RF Input** from the Source drop-down list.
3. Select **Power** from the **Type** drop-down list.



Note: You can also set a Time Qualified trigger from the [Time Qualified tab](#) (RSA7100 only).



Tip: See the following topics for more information about power trigger:

[Event tab](#)

[Time qualified](#)

[Trigger modes and settings](#)

Frequency Mask trigger

Frequency Mask triggering allows you to trigger the instrument when a signal in the frequency domain violates the mask. You can draw a mask to define the conditions within the real-time bandwidth that will generate the trigger event. It allows you to trigger on weak signals in the presence of strong signals. This triggering is also useful for capturing intermittent signals.

The frequency mask trigger monitors all changes in frequency occupancy within the capture bandwidth.

Event tab when trigger type is Frequency Mask

Setting	Description
Violation	Specifies the type of transition that defines a violation.
RBW	Specifies the resolution bandwidth.
Auto	Specifies whether the RBW is adjusted automatically or manually.
Mask Editor	Displays the Mask Editor so that you can create and edit Frequency Masks. You can read more about using this tool in the Mask Editor (Frequency Mask Trigger) topic.
Load from file	Opens the Open dialog for selecting a previously saved frequency mask file.

Violation. Violations are state changes (or a sequence of state changes) defined by whether a point on the signal falls within the frequency mask or outside the frequency mask. A True violation occurs if even a single point on the trace falls inside the mask (above the mask's lower edge). Conversely, a False violation occurs if no points on a signal fall inside the mask (all trace points are below the mask's lower edge).



A trigger event is initiated based on the type of violation that occurs and the sequence of violations that occur.

Violation	Description
T	Only one state is required to initiate a trigger event. The signal has at least one data point inside (above) the mask. The trigger event occurs when the instrument detects the first signal with a point violating the mask. A trigger event could occur on the first acquisition.
F	Only one state change is required to initiate a trigger event. The signal has all data points outside (below) the mask. The trigger event occurs when the instrument has detected the first spectral waveform that lies completely below (outside) the mask. A trigger event could occur on the first acquisition.
T - F (Out)	Two states are required to initiate a trigger event. The signal must be inside the mask and then passes out of the mask. The trigger event occurs when the first non-violating waveform is detected.
F - T (In)	Two states are required to initiate a trigger event. The signal must be outside the mask and then passes into the mask. The trigger event occurs when the first non-violating waveform is detected.
T - F - T (Out & In)	Three states are required to initiate a trigger event. The signal starts inside the mask and then passes out of the mask. Next, the signal must pass into the mask. The trigger event occurs at the second transition where the signal passes back into the mask.
F - T - F (In & Out)	Three states are required to initiate a trigger event. The signal starts outside the mask and then passes into the mask. Next, the signal must pass back outside the mask. The trigger event occurs at the second transition where the signal passes back out of the mask.

Mask Editor. Launches the [Mask Editor](#) that enables you to create and edit Frequency Masks.

Load from file. Enables you to load an existing frequency mask for use with Frequency Mask Trigger.

Tip: See the following topics for related frequency mask trigger information:



- [Event tab](#)
- [Mask Editor](#)

Trigger modes and settings

Mask Editor (Frequency Mask Trigger)

The Mask Editor is used to create masks that are used by the Frequency Mask Trigger function. The Frequency Mask Trigger (FMT) function is used to define trigger events to capture signal anomalies based on their frequency and amplitude.

Displaying the Mask Editor

To display the Mask Editor:

1. Click  on the Favorites toolbar or select **Setup > Trigger** to access the Trigger control panel.
2. Select the **Event** tab.
3. Set **Source** to **RF Input**.
4. Set **Type** to **Frequency Mask**.
5. Select **Mask Editor**.

Creating a Mask

The simplest way to create a mask is to use the **Auto draw** function.

To create a new mask using **Auto draw**:

1. Select the trace on which to base the mask from the **Reference trace** drop-down list. (Only traces that are shown can be selected from the drop-down list. To show a trace that isn't currently in the list, open its display and enable the trace of interest.)
2. Specify the margins to be applied between the mask and the reference trace. Enter values for the X Margin and the Y Margin.
3. Click **Auto draw**.

The following screen shows a mask created with Auto draw.

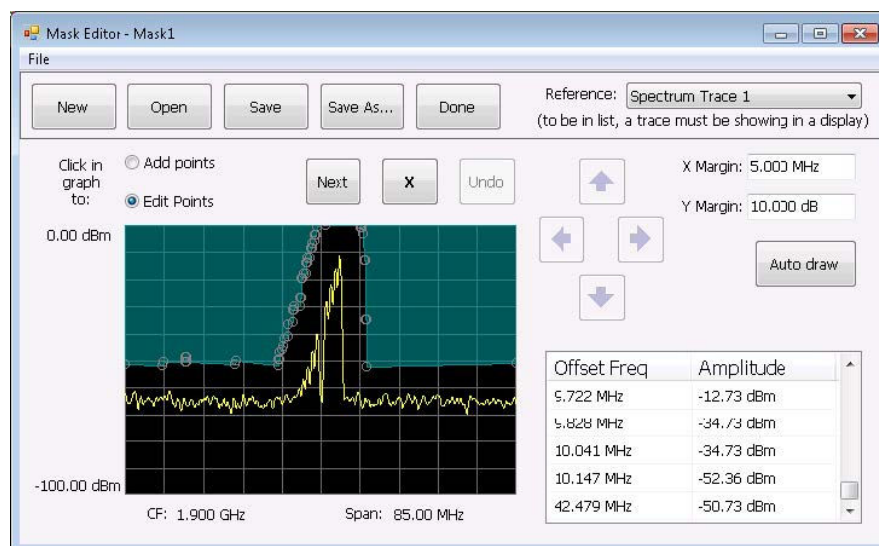

To create a new mask without using Auto draw:

- Click the **New** button.

Changing a Mask

A mask is a collection of points specified by their frequency (defined by their offset from the center frequency) and their amplitude. You can change a mask by adding (or removing) points and editing points.



Note: When placing points in the frequency mask, keep in mind that in most cases, the Frequency Mask Trigger has a range of 80 dB below Reference Level. However, for values of Reference Level lower than -50 dBm, this range decreases as the RefLevel decreases. The FMT range is also reduced when the Acquisition Bandwidth contains frequencies near 0 Hz. In both these situations, the underlying reason the trigger range is reduced is because the instrument is using various amounts of "digital gain" in addition to hardware gain. You are not prevented from placing mask points outside the usable range of the instrument, but at the time the mask is applied, the instrument adjusts its range. When the mask is adjusted, you can see this in the Spectrum display and the Mask Editor. The mask's shaded fill shows the usable vertical range. Points outside this range are shown, but will not cause a trigger.

Adding Points

To add a point to a mask:

1. Click the **Add points** option button. (Alternatively, you can right-click on the desired point location (or left-click and hold for about a second) and release.)
2. Click in the graph area where you want the new point added to the mask.

You can also add a point to the mask while it is in Edit Points mode:

- Right-click in the graph area where you wish to add a point to the mask. You can also left-click and hold the button down for one second.

If you add a point by accident, click **Undo**. You can click Undo until the Undo button is grayed out.

Editing Points

When you edit a point, you change its offset from the center frequency and/or its amplitude. There are two ways to edit the offset and amplitude of a point on a mask. First, you can drag a point to the desired position. Second, you can double-click on the offset or amplitude value in the table and enter a new value.

To edit a point on a mask:

1. Click the **Edit Points** option button.
2. Click on the point you wish to change.
3. Change the position of the point using the following methods:
 - a. Dragging it with the mouse to the desired position.
 - b. Clicking the arrow keys in the Mask Editor window to move the point to the desired position. Use the left/right keys to change the frequency offset. Use the up/down arrow keys to change the amplitude.
4. To edit another point, click **Next**.

You can also edit a point by double-clicking on the value in the table that you want to change and typing in a new value.

Deleting Points

To delete points from the mask:

1. Click the **Edit Points** option button.
2. Click on the point to be removed and click the **X** button to delete the point.

You can also delete a point by clicking on the point in the table that you want to delete and clicking the **X** button.

If you delete a point by accident, click **Undo**. You can click Undo until the Undo button is grayed out.

Saving a Mask

To save a mask:

- Click the **Save** button.

To save an edited mask under a new name:

- Click the **Save As** button.

Opening an Existing Mask

To open an existing mask:

1. Click on **Open**. This displays the Open dialog box.
2. Navigate to the location of the mask file.
3. Select the desired file and click **Open**.

DPX Density trigger

DPX Density triggering uses characteristics of the DPX display to specify trigger parameters. When using DPX Density triggering, the percentage of time the signal falls within the measurement box is used to define a trigger event. The measurement box is defined by frequency and amplitude values.

Click to read more about [density measurements and DPX](#).



Note: Requires an RSA7100 with Option TRIGH.

Event tab when trigger type is DPX Density

The screenshot shows the 'Trigger' dialog box with the 'Event' tab selected. On the left, there are radio buttons for 'Free Run' and 'Triggered' (selected), and a 'Force Trigger' button. The main area has tabs for 'Event', 'Time Qualified', 'Advanced', and 'Actions'. Under 'Event', there are dropdowns for 'Source' (RF Input) and 'Type' (DPX Density). The 'Density' section has radio buttons for 'Higher' (selected) and 'Lower'. To the right, there are input fields for 'Threshold' (10.000 %), 'Frequency' (1.50000 GHz +/- 2.00000 MHz), and 'Amplitude' (-20.00 dB +/- 5.00 dB).

Setting	Description
Density	Specifies whether a density value higher or lower than the threshold value defines a trigger event.
Threshold	Specifies the DPX Density threshold that defines a trigger event. The DPX Density must be higher or lower (specified by the Density selection) than this value to define a trigger event. Density is a measure of how much time the signal is present in a particular region in the DPX Spectrum graph. The range for this value is 0 to 100%.
Frequency	Specifies the center of the measurement box on the frequency axis (horizontal).
+/-	Specifies the width of the measurement box (the edges of the measurement box above and below the Frequency setting).
Amplitude	Specifies the center of the measurement box on the power level (vertical) axis.

Table continued...

Setting	Description
+/-	Specifies the height of the measurement box (the edges of the measurement box above and below the Amplitude setting).

To trigger acquisitions based on the density of the DPX Bitmap trace:

1. Click the **Triggered** option button.
2. Select **RF Input** from the Source drop-down list.
3. Select **DPX Density** from the **Type** drop-down list.
4. Set the DPX Density parameters as appropriate. You can do this one of the following ways:
 - Check the **Show measurement** box in the Density tab of the DPX Settings control panel to view the measurement box in the display. Use the mouse to move and size the measurement box that appears on the display to set the values for Frequency and Amplitude.



Note: If the Amplitude units (Setup > Analysis > Units) is set to Watts or Volts, you cannot move the measurement box using a mouse. Set the amplitude units to any unit other than Watts or Volts to move or resize the measurement box.

- Check the **Show measurement** box in the Density tab of the DPX Settings control panel to view the measurement box in the display. Enter the Frequency, Threshold, and Amplitude in the Density tab.

Tip: See the following topics for more information about DPX density trigger.



[Event tab](#)

[Trigger modes and settings](#)

Event Tab

The Event tab is used to set the parameters that define trigger events. The parameters that appear on the Event tab change depending on the selected Trigger source and type.

Click on the links in the following table to view detailed information about the settings on the Event tab by source and type.

Source	Description	Available types
RF Input	Sets the source for a trigger to the RF Input on the instrument.	Power Frequency Mask DPX Density
External	Sets the source for a trigger to the Ext connector (None) on the rear of the analyzer.	(None)
Internal Time	Sets the source to generate a trigger event at one or more time points based on the analyzer system internal time.	(None)

Time Qualified Tab

The Time Qualified tab allows you to specify whether triggers are accepted based on timing characteristics. Trigger events that pass the timing qualification result in an acquisition. Trigger events that do not pass the timing qualification are ignored. Time-qualification can be applied when the trigger source is RF Input and the trigger type is Power.

Event | **Time Qualified** | Advanced | Actions

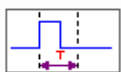
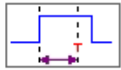
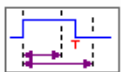
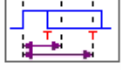
None
 Shorter 
 Longer 
 Inside 
 Outside 

Time 1:
 Time 2:

Setting	Description
None	No timing qualification is applied to trigger events. Acquisitions occur whenever a trigger event occurs (as specified on the Event tab).
Shorter	If the length of the trigger event is shorter than the time specified by the Time 1 setting, then the trigger event is accepted and an acquisition is completed.
Longer	If the length of the trigger event is longer than specified by the Time 1 setting, then the trigger event is accepted and an acquisition is completed.
Inside	If the length of the trigger event is longer than or equal to the minimum time (Time 1 setting) AND shorter than the maximum time (Time 2 setting), then the trigger event is accepted and an acquisition is completed.
Outside	If the length of the trigger event is shorter than or equal to the minimum time (Time 1 setting) OR longer than the maximum time (Time 2 setting), then the trigger event is accepted and an acquisition is completed.
Time 1	Enter the Time 1 reference value here. Range: 0 ns to 1 s.
Time 2	Enter the Time 2 reference value here. Range: 0 ns to 1 s.

Minimum off time between trigger events and pulse width.

The minimum off time is the length of time for which trigger conditions must be absent between the end of one trigger event and the start of the next trigger event to ensure that the end of the first event is recognized. It is the same as the minimum pulse width. For example, if the minimum off time is 34 ns and the time difference between pulses is 10 ns, then the data would show one pulse instead of two pulses (assuming no trigger violations occurred).

Sample rate	Minimum pulse width	Minimum off time
15.6 MS/s	64 ns	64 ns
31.2 MS/s	32 ns	32 ns

Table continued...

Sample rate	Minimum pulse width	Minimum off time
62.5 MS/s	16 ns	16 ns
75.0 MS/s	27 ns	27 ns
150 MS/s	21 ns	21 ns
250 MS/s	20 ns	20 ns
500 MS/s	34 ns	34 ns
1 GS/s	34 ns	34 ns

Detectable triggers per second. The analyzer can acquire up to 100,000 triggers per second. However, to ensure no missed data, keep triggers to $\leq 10,000$ triggers per second. As the number of triggers increases, processing speed will slow.

Setup for a time qualified trigger

In this example, we use a known signal source with a $10 \mu\text{s}$ pulse train (period) with a 50% duty cycle, and a frequency of 4 GHz, and amplitude of -10 dBm .

1. Connect the signal source to the RF Input of the RSA7100,
2. In the SignalVu-PC application, set the Span to include the frequency of the signal source.
3. Click  to open the Trigger control panel.
4. Select **Triggered**.
5. Set Source to **RF Input**, Type to **Power**, and Level to the amplitude of the signal source.

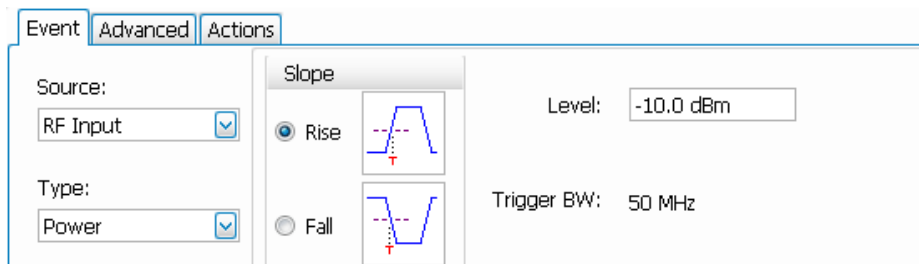

6. Select the Time Qualified tab and set the Time 1 and Time 2 values.

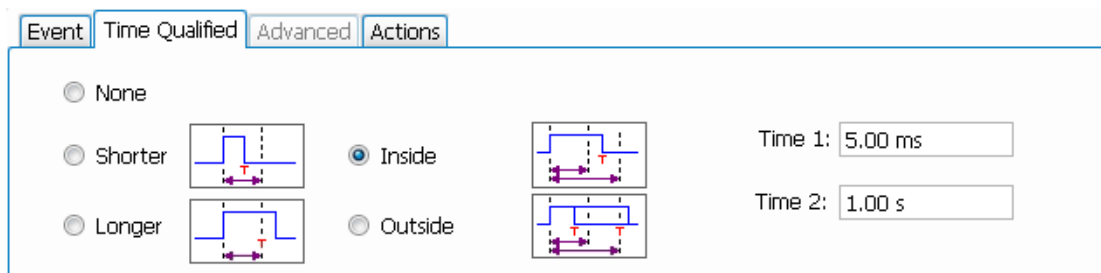

7. If desired, you can view the sample rate in the Acquisition Data tab of the Acquire control panel. The sample rate allows you to find the corresponding minimum off time and pulse width in the above [table](#).

Acquisition data (RSA7100)

Time qualified trigger data is included in the .xmrk file for a recorded acquisition. Read more about XDAT files in the [Data, Settings, and Picture File Formats](#) topic.

Advanced Tab (Triggering)

Menu Bar: Setup > Trigger > Advanced

Favorites toolbar: 

Allows you to set the following parameters. Available parameters vary depending on the trigger selections and settings in the Events tab.

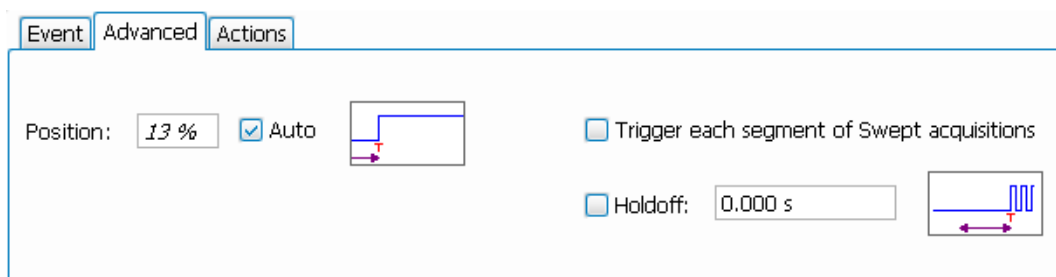

Figure 140: Advanced tab when an RSA7100 is connected.

Setting	Description
Position	Sets the point along the acquisition record the trigger event should occur.
Auto	Enables the instrument to set the position of the trigger event. To manually specify the position of the trigger event, unselect Auto.
Holdoff	Prevents triggers until there have been no trigger events for at least the specified time. Range: 20 ns-1 s.
Trigger each frequency segment in Swept acquisition mode	Sets the analyzer to wait for a trigger for each acquisition in a swept spectrum or other measurement requiring multiple acquisitions worth of span.

Holdoff

Holdoff on the analyzer does not work exactly like the traditional Holdoff setting on an oscilloscope. On an oscilloscope, once the instrument triggers, the holdoff setting causes the oscilloscope to refuse to accept another trigger until the holdoff time has expired. On the analyzer, once a trigger event is identified, the analyzer determines how long it has been since the previous trigger event occurred and if the time since the previous trigger event is greater than the holdoff time, the trigger event is accepted and an acquisition is completed. If the time since the previous trigger event is less than the holdoff time, the latest trigger event is ignored (no acquisition occurs) and the holdoff time count restarts.

Actions Tab (Triggering)

The Actions tab sets parameters for the Save on trigger function. The Save on trigger function allows you to save an acquisition data file and/or a screen capture when a trigger event occurs.

Trigger events are defined on the [Event](#) and [Time Qualified](#) tabs.

Event
Advanced
Actions

Save acq data on Trigger: TIQ (1 complete acquisition, not valid when swept)

Max total files saved per Run: 100

Save picture on Trigger: PNG

Table 47: Action tab settings

Setting	Description
Save acq data on Trigger	<p>Enables the Save on Trigger function. The list box to the right of the Save acq data on Trigger check box specifies the format of the saved file. Acquisition data files can be saved in TIQ (native) format, CSV format, and MAT (MATLAB) format. For descriptions of these file formats, see Data, Settings and Picture File Formats.</p> <p>When TIQ is the selected file type, a file is saved after a complete acquisition, which can include multiple frames. When CSV or MAT is the selected file type, a separate file is saved for each frame.</p> <p>Files are saved in the last location a file was saved. If Automatically increments filename/number is enabled (see Save and Export), files will be saved without user interaction. If Automatically increments filename/number is not enabled, you will be prompted for a filename when a trigger event occurs.</p>
Save picture on Trigger	<p>Enables saving a picture of the display when a trigger event occurs. Files can be saved in PNG, JPG, and BMP format. For descriptions of these file formats, see Data, Settings, and Picture File Formats.</p>
Max total files saved per Run	<p>Specifies the number of times a Save on Trigger action stores a file. After this limit is reached, no more files are saved. The instrument will continue to run, but no additional files are saved when a trigger event occurs.</p> <p>Keep in mind when setting this number that picture files are counted as part of the total number of files. For example, if you set Max total files to 100, the instrument will save 100 acquisitions if only acquisitions are saved or only pictures are saved. But, if both acquisitions and pictures are saved, then 50 acquisitions and 50 pictures will be saved.</p>

Trigger save and status

Save on trigger

An additional feature of the triggering capability is to save acquisition data when a trigger event occurs. When the analyzer is run in Triggered mode, you can configure the instrument to save acquisition data to a file. You can also set the instrument to save a picture of the screen when the trigger event occurs. See [Action Tab \(Triggering\)](#) for details on configuring Save on trigger.

Global Synchronization Settings

The global synchronizing settings are used to synchronize different parameters and settings of the measurements across various sources. These settings are supported for Multichannel plugins such as General Signal Viewing, General Purpose Demodulation, and Pulsed RF. The global synchronizing settings are enabled using below settings.

1. Link Settings:

The link settings is the initial step to enable the global settings.

Click **File > Setup > Link Settings** or click  icon from the tool bar menu to enable the global settings. On enabling, Link Settings icon changes from grey to green.

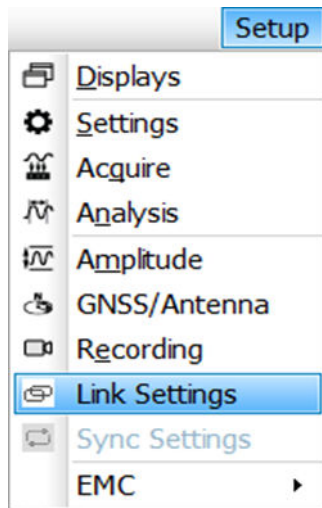

2. Sync Settings:

The Sync Settings menu is used to synchronize the settings across the measurements, displays, sources, and channels. This menu is enabled only if the Link Settings option is enabled.

Click **File > Setup > Sync Settings** or click  icon from the tool bar menu to synchronize the settings across all measurement displays, source settings, and channel settings.

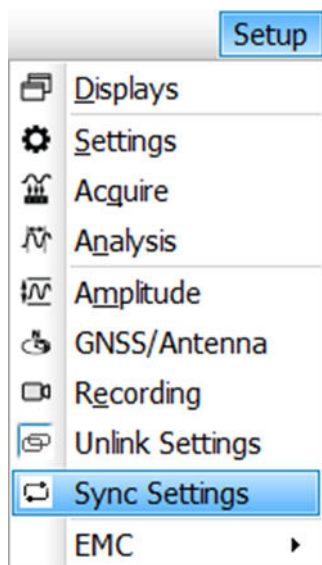

The following types of settings are synchronized with the global synchronization:

- Measurement settings
- Source settings
- Channel settings

Measurement Settings

When Link Settings is enabled, any changes to the measurement settings will also be applied to the measurements with other sources. The settings are updated when you modify them from control panels or from PI commands.

For example, with link settings enabled, when you changes the frequency in Meas1, then it will be applied in other sources as well as there are four sources available and created the spectrum display for each source. The below image shows the measurement settings panel for Meas1, the frequency value as 5 GHz, the same will be applied to other spectrum measurements.

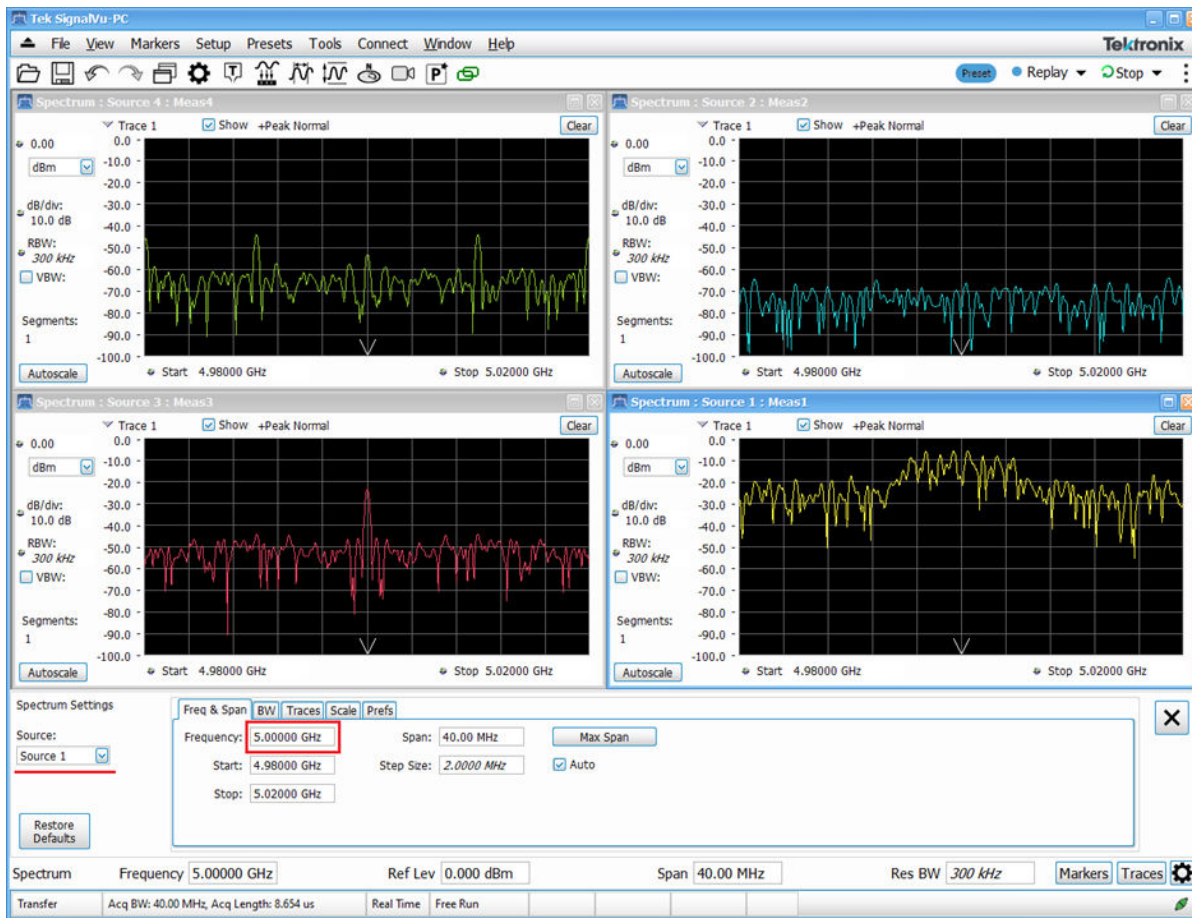

Figure 141: The image shows the synchronization of the measurement settings when global settings are applied.

Source Settings

If any source specific parameter is modified in one source, then it will be applied to all other sources. For example, Measurement frequency, Centre frequency, Analysis length, Offset, Measurement Bandwidth etc.

For example, modify the Analysis offset in current active analysis panel. The modified value will be applied to other sources as well as there are four sources and created the spectrum display for each source.

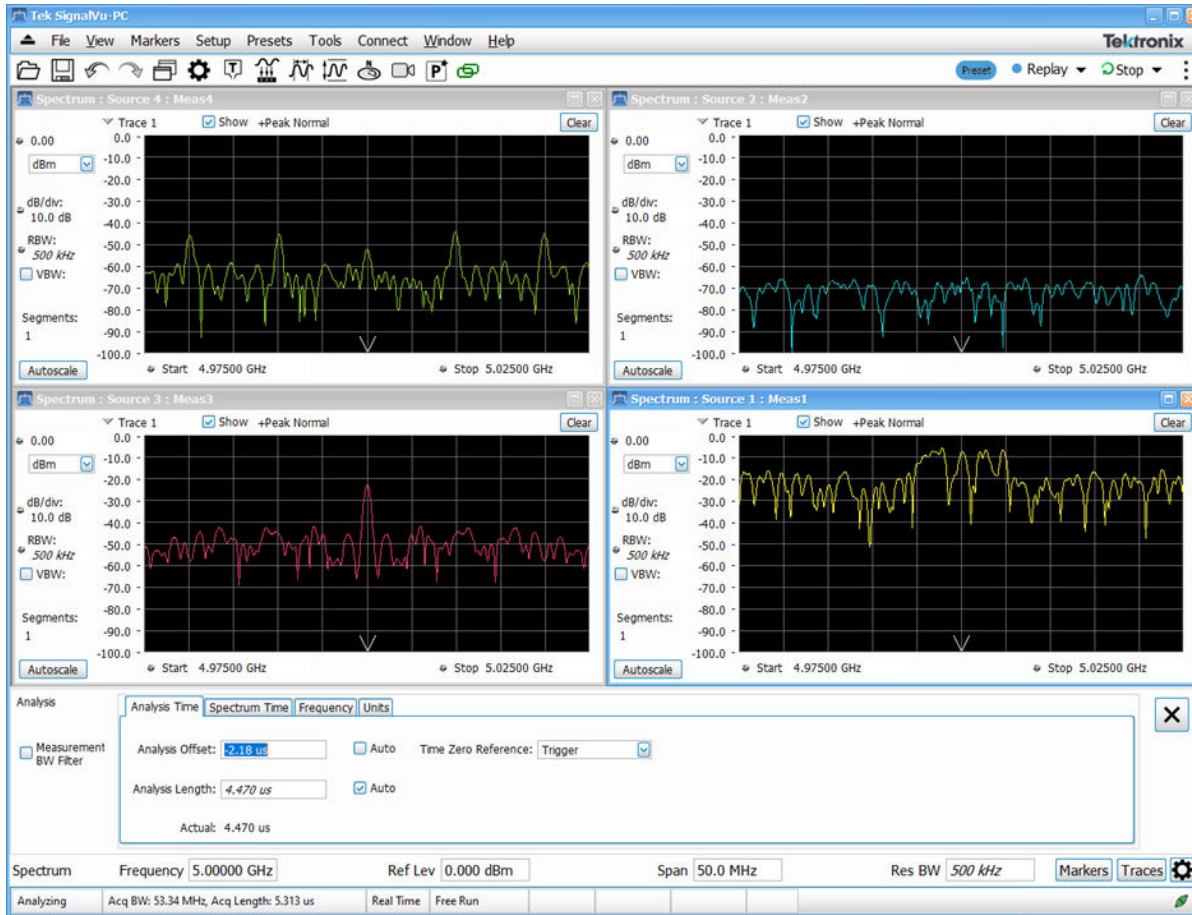

Figure 142: The image shows the synchronization of the source settings when global settings are applied.

Channel Settings

If any channel parameter such as External attenuation, Termination etc., is modified, then it will also be applied to all other channels.



Note: The reference level parameter is excluded from global synchronization. When reference level is modified for a channel, it will only be applied to that channel. No other channel's reference level is changed.

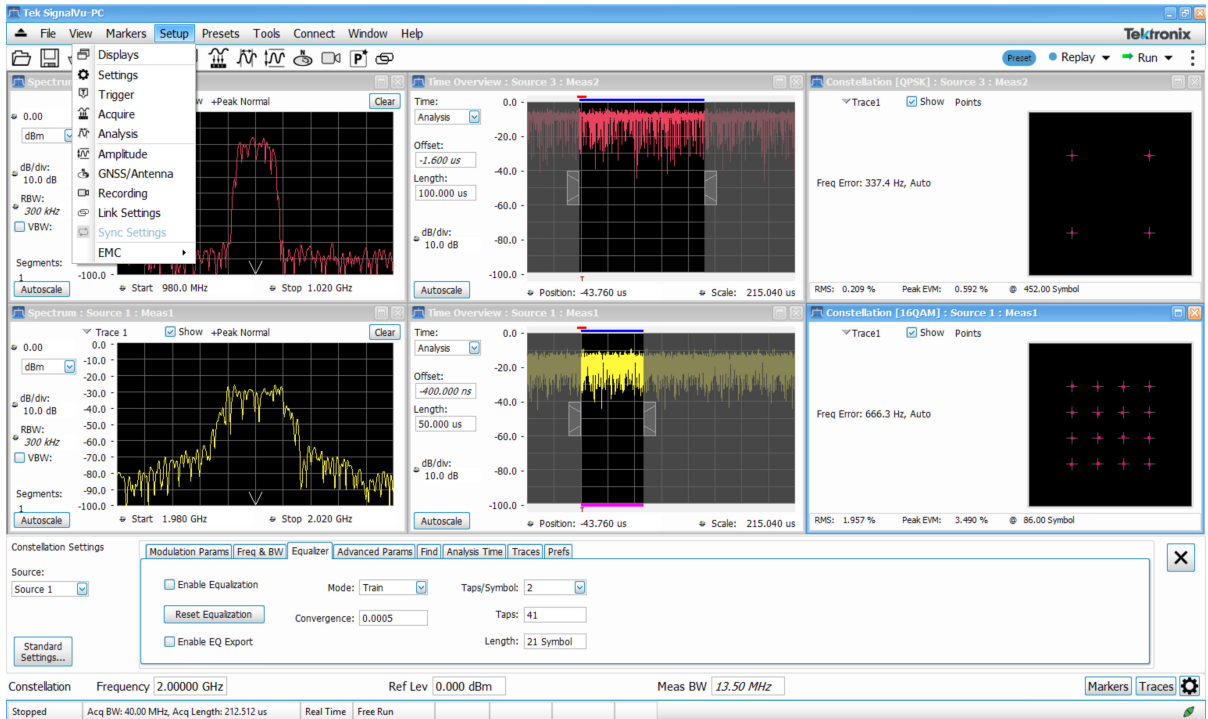

Note: To synchronize the settings across all the measurement displays with the active window settings, we need to first enable the link settings followed by the sync settings.



Note: To ensure sync, sync the settings again between the newly added measurements with the different source settings and the measurements currently in sync.



Note: To configure different values for different sources, first unlink the settings then modify the parameters, so that rest of measurement settings remains same.

GNSS and Antenna Features

How to set up GNSS

The combined use of the GNSS, Antenna, and Map It features allows you to capture and map location coordinates when using an antenna and a GNSS receiver. The Map It feature requires that the optional MAP application license be installed.

You can use the GNSS and Map It features to connect a Global Navigation Satellite System (GNSS) receiver to a communication (COM) port on your PC to capture the timing and positioning data of the receiver for a measurement from a satellite or constellation of satellites. The receiver must output navigation messages using NMEA 0183 serial data format, and the messages must include at least one of these sentence types: RMC, GGA or GNS.

The RSA7100 with Option GPS, the RSA500A series, and the RSA600A series instruments have an internal GNSS receiver.

How to access the GNSS/Antenna control panel

Click the  icon or select **Setup > GNSS/Antenna** from the Main menu bar to view the GNSS/Antenna control panel.

GNSS settings

The following images and table show the GNSS tab of the GNSS/Antenna control panel and its contents.

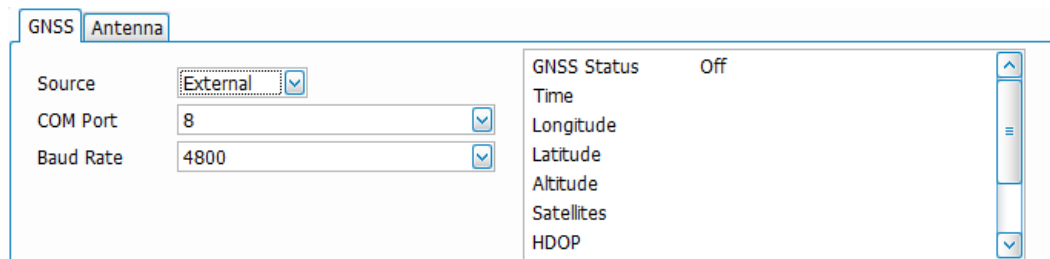

Figure 143: The above image shows the GNSS tab as it appears when the GNSS selection is External, None, or Simulator.

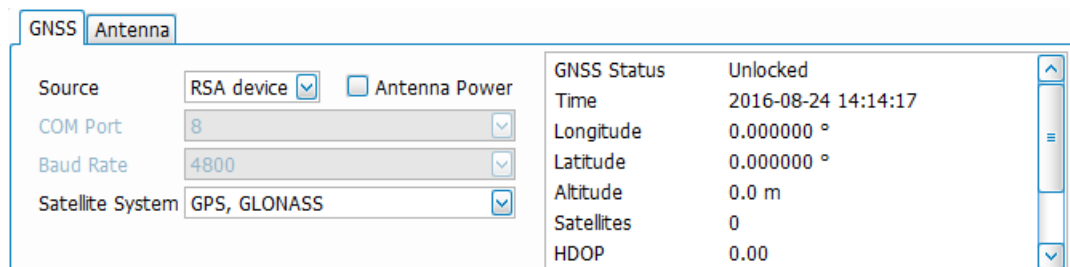

Figure 144: The above image shows the GNSS tab as it appears when the GNSS selection is RSA Device. This selection is only available when an RSA7100 (with Option GPS), RSA500A series, or RSA600A series instrument is connected.



Setting	Description
Source	<p>Select the GNSS source as None, RSA Device (GPS), or External.</p> <p>None disables use of GNSS data.</p> <p>RSA Device selects the internal GNSS receiver in the connected analyzer.</p> <p>External selects a user-provided GNSS receiver in the PC with SignalVu-PC installed, or it may be one you connect through USB or some other method.</p> <p> Note: When recording with XDAT format, a marker file (.xmrk) is generated that lists GPS data, such as time, location, and the time stamp of the GPS event during recording. You can read more about file formats in the Saved File Types topic.</p>
Antenna Power	<p>This item appears when RSA Device is the GNSS selection. Check this box to supply power to an attached antenna. Power is provided as a DC voltage on the connector center conductor.</p> <p>Unchecking the box turns power to the antenna off. Changing the selection from RSA Device to any other selection also turns the power to the antenna off.</p>
COM Port	<p>This list is auto-populated with the COM ports on your PC, as well as a simulation port.</p> <p>This selection is not available when RSA Device is selected.</p> <p> Note: You must first select the COM port to which the antenna is connected before an antenna connection can be established.</p>
Baud rate	<p>Select a baud rate. Selection of this rate will depend on your GNSS receiver and COM port specifications. Options are 4800, 9600, 19200, and 38400.</p> <p>This selection does not apply when RSA Device is selected.</p>
Satellite System	<p>Select a satellite system: GPS, GLONASS; GPS, BeiDou; GPS; GLONASS, BeiDou.</p>
GNSS readout	<p>This readout shows the status of the GNSS connection and time, location, and satellite information. Each item is described below.</p>
GNSS Status	<p>GNSS receiver connection status: Off, Comm error, Unlocked, Locked.</p>
Time	<p>Date (yyyy-mm-dd) and time (hh:mm:ss).</p>
Longitude	<p>East-west position (shown in degrees), where the prime meridian is 0°. Positive numbers indicate East and negative numbers indicate West.</p>
Latitude	<p>North-south position between the poles (shown in degrees), where the equator is 0°. Positive numbers indicate North and negative numbers indicate South.</p>
Altitude	<p>Elevation from sea level (shown in meters).</p>
Satellites	<p>Number of GNSS satellites currently tracked by the GNSS receiver.</p>
HDOP	<p>Horizontal Dilution of Precision (HDOP). This value indicates the quality of the satellite signal using the relative geometry of the satellite to receiver. An ideal value is <1. The lower the value, the better the positional precision.</p>

Table continued...

Setting	Description
Speed	Speed of receiver (shown in km/s).
Course	Compass bearing (shown in degrees).

The icon  appears in the right corner of the Status Bar. It is green when GNSS is locked, yellow if unlocked, and red if there is a communication error.

How to set up the GNSS feature with an external GNSS receiver

1. Install a GNSS receiver to a COM port on your PC.
2. Select **Setup > GNSS/Antenna** from the Main menu bar to view the GNSS/Antenna control panel.
3. Select **External** from the drop-down menu in the GNSS tab.
4. From the COM Port drop-down list, select the COM port to which the GNSS receiver is connected.

You can also select RSA Device as your GNSS source if you are using an RSA500A or RSA600A series, or RSA7100 instrument.



Note: You can select Simulation Port to run a simulation when no GNSS receiver is present. Copy the file GnssSimCom19 from C:/RSAMap Files/Example Files and place it in the Windows C:/Temp directory, then select Simulation Port from the COM Port drop down menu.

5. Set the Baud Rate as appropriate for the connected GNSS receiver. The default is 4800, which is a typical rate.

GNSS		Antenna	
GNSS	External	GNSS Status	Locked
COM Port	9 - Prolific USB-to-Serial Comm Port	Time	2015-11-11 15:17:08
Baud Rate	4800	Longitude	-122.823183 °
		Latitude	45.499185 °
		Altitude	76.1 m
		Satellites	11
		HDOP	0.70

When the GNSS receiver is communicating with the analyzer, the readouts in the right portion of the GNSS panel (status area) will update to display current location information and GNSS receiver status. Lock times will vary depending on the receiver and receiving conditions.

See also:

[How to use the Antenna feature](#)

[How to use Map It](#)

[Frequency Reference tab and GNSS settings](#)

[Timing Reference tab and GNSS settings](#)

How to use the Antenna feature

The antenna feature allows you to connect to an Alaris DF-A0047 USB-connected antenna that reports bearing/azimuth data over USB. In conjunction with a GNSS receiver, you can capture location and azimuth data using the Map It feature. If you do not use an Alaris DF-A0047 antenna, you can use the manual controls to enter an azimuth.

Explore the following topics in this section:



Note: A USB driver is installed for the Alaris antenna with SignalVu-PC. However, Windows will search for new drivers if the PC is connected to the internet. The first time you plug an antenna into the port, it may take several minutes for the driver to be installed (when connected to the internet).

- [Antenna settings.](#)
- [How to set up the Antenna feature with an antenna.](#)
- [How to use the antenna Simulator.](#)
- [How to use the Alaris function button](#)

How to access the Antenna control panel

Click  or select **Setup > GNSS/Antenna** from the Main menu bar to view the GNSS/Antenna control panel. Then click on the **Antenna** tab in the control panel.

Antenna settings

Following is an image and a description of the Antenna tab of the GNSS/Antenna control panel.

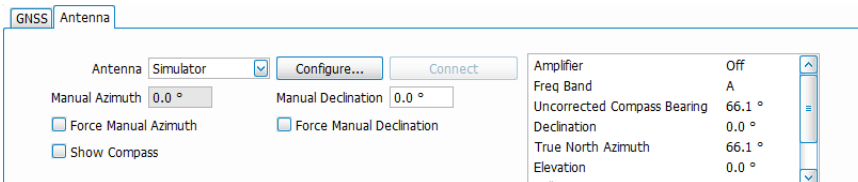

Setting	Description
Antenna	Select the antenna. Choices are None, Alaris DF-A0047, and Simulator. The Simulator simulates an antenna connection and readouts for demonstration purposes.
Manual Azimuth	Enter a value here to force the azimuth (compass direction in degrees) to be a specific value. The azimuth is the angle measured clockwise between the reference meridian (geographic north) and the current antenna direction. It can range from 0 to 360°.
Force Manual Azimuth	Check this box to force the analyzer to read the azimuth at the entered value instead of the antenna generated value.
Show Compass	Check this box to view a visual, qualitative representation of the bearing (a virtual compass). To remove the compass, uncheck the box. To adjust the compass size, click and drag from the bottom right corner.
Configure...	This button opens the Antenna Setup window. In this window you can enter the antenna serial number and set the following antenna related parameters: baud rate, data bits, stop bits, and parity.
Connect	Click this button to connect to the antenna or to start the antenna simulator.  Note: You must first select the COM port to which the antenna is connected before a connection can be established. Use the Windows Device Manager to find the port used by your antenna.

Table continued...

Setting	Description
Manual Declination	Enter a value here to force the declination (angle in degrees between magnetic (true) north and geographic north) to be a specific value.
Force Manual Declination	Check this box to force the analyzer to use the manually entered declination value. Otherwise, the analyzer will assume that geographic north and magnetic north are the same and use 0°.
Antenna readout	This readout field will contain some or all of the following readings, depending on your setup.
Amplifier	Shows Off or On depending on whether or not you have enabled the amplifier on the antenna.
Freq Band	The current operating frequency band of the antenna. For the Alaris DF-A0047, this value can be one of the following: A (0.009 - 20 MHz) B (20 - 50 MHz) C (50 - 8500 MHz)
Uncorrected Compass Bearing	Shows the azimuth reading from geographic north.
Declination	Shows the declination.
True North Azimuth	Shows the azimuth reading after declination is applied.
Elevation	Shows the antenna elevation.
Roll	Shows the antenna roll.

How to set up the Antenna feature with an antenna

1. Install the Alaris DF-A0047 driver. The driver can be copied from the SignalVu-PC Software and Documentation USB stick supplied with the RSA306, RSA306B, RSA500A series, and RSA600A series instruments. It can also be download from www.Tek.com/downloads.
2. Connect an Alaris DF-A0047 antenna to the PC.



Note: Connecting an RSA306, RSA306B, RSA500A series, or RSA600A series is not required, but provides increased functionality of this feature.



Note: A USB driver is installed for the Alaris antenna with SignalVu-PC. However, Windows will search for new drivers if the PC is connected to the internet. The first time you plug an antenna into the port, it may take several minutes for the driver to be installed (when connected to the internet).

3. Select **Setup > GNSS/Antenna** to open the GNSS/Antenna control panel.
4. Select **Alaris DF-A0047** from the Antenna drop-down menu. Selections also include None (default) and Simulator.
5. Click the **Configure...** button to launch the Antenna Setup window.

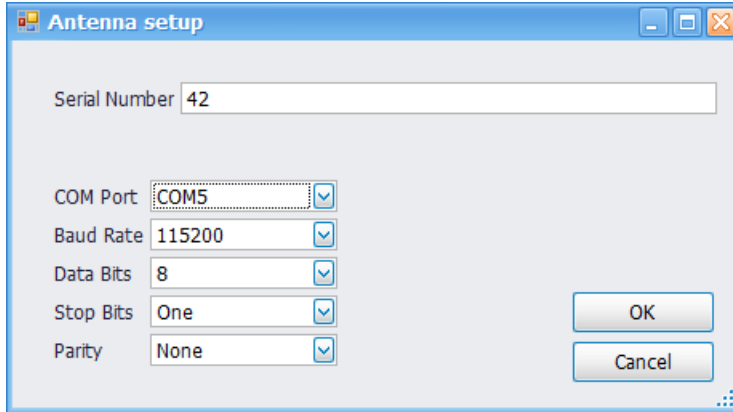

6. Do the following in the Antenna Setup window:
 - a. Enter the serial number of the antenna, if desired.
 - b. Select the COM port to which the antenna is connected. You can see a list of COM ports for your PC in the Microsoft Windows Control Panel. Use the Windows Device Manager to find the port used by your antenna.
 - c. You can change the following parameters; however, the default values are set for the Alaris DF-A0047 antenna. If you change these parameters, you may lose communication with the Alaris antenna: baud Rate, data bits, stop bits, and parity.
7. Click **OK** to save the changes and close the Antenna Setup window.
8. You can now choose to manually set the declination, if desired. To do this, check the box next to **Force Manual Declination** in the Antenna tab of the GNSS/Antenna control panel and then enter the desired value. Notice that the value you enter will appear in the antenna readout to the right of the Connect button. The True North Azimuth reading is the sum of the Uncorrected Compass Bearing and the Declination.

You can also check the box next to **Force Manual Azimuth** and enter a desired value if you want to force the azimuth or are using an antenna that does not report azimuth.

When you select to manually force the declination and/or azimuth, those values will not change in the readout, even if the antenna direction changes.

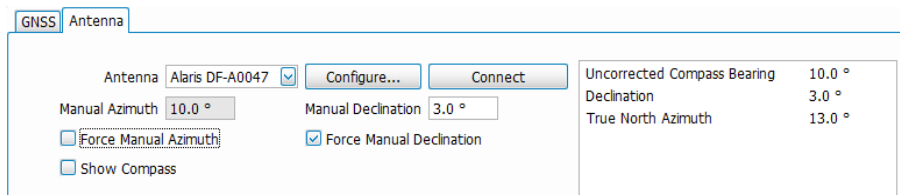

9. Check the **Show Compass** box to view a visual, qualitative representation of the bearing. As you move the antenna, the compass needle will move.

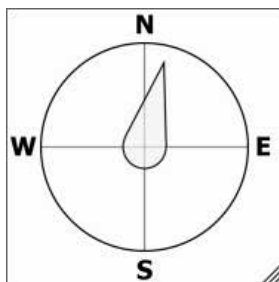

TIP : You can adjust the size of the compass by clicking on the right bottom corner and dragging it.

10. Click the **Connect** button to connect to the antenna. Connection may take about 10 seconds. Once connected, the antenna readout will reflect the antenna direction and other readings.

How to use the antenna Simulator

1. Select **Setup > GNSS/Antenna** to open the GNSS/Antenna control panel.
2. Select **Simulator** from the Antenna drop-down menu. Selections also include None (default) and Alaris DF-A0047.
3. Click the **Connect** button to launch the Smart Antenna Control Form.

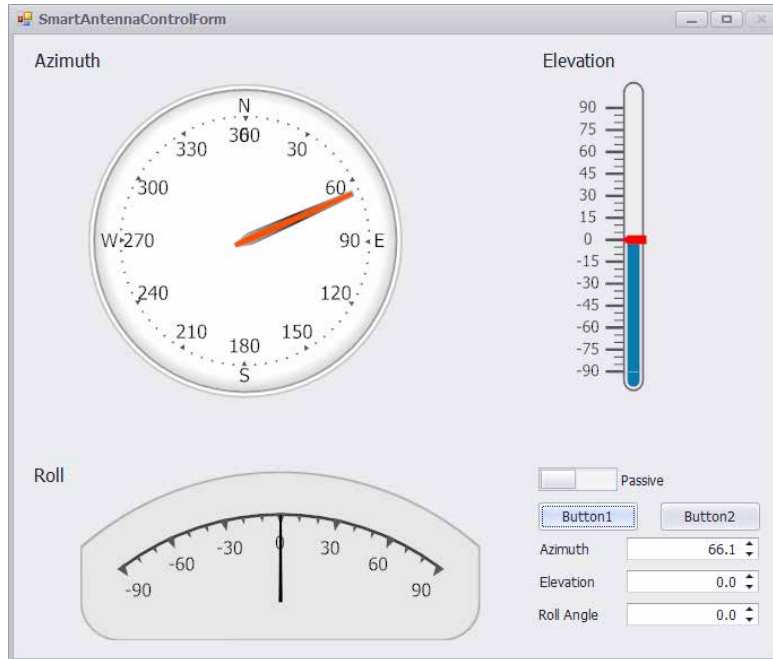

4. Click on the various areas of the Smart Antenna window to adjust azimuth, roll, or elevation. You can also enter the values directly in the Azimuth, Elevation, and Roll Angle fields. This Smart Antenna window simulates a physical antenna, except that there is no amplification available (the Passive/Active switch in non-functional).
5. Click the **Button1** button to capture the GNSS information. (See the How to use Map It topic for more information on capturing data.)
6. You can now choose to manually set the declination, if desired. To do this, check the box next to **Force Manual Declination** in the Antenna tab of the GNSS/Antenna control panel and then enter the desired value. Notice that the value you enter will appear in the antenna readout to the right of the Connect button. The True North Azimuth reading is the sum of the Uncorrected Compass Bearing and the Declination.

You can also check the box next to **Force Manual Azimuth** and enter a desired value if you want to force the azimuth or are using an antenna that does not report azimuth.

When you select to manually force the declination and/or azimuth, those values will not change in the readout, even if the antenna direction changes.

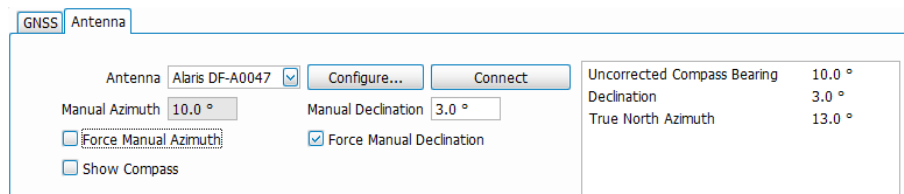

7. Check the **Show Compass** box to view a visual, qualitative representation of the bearing. As you move the antenna, the compass needle will move.

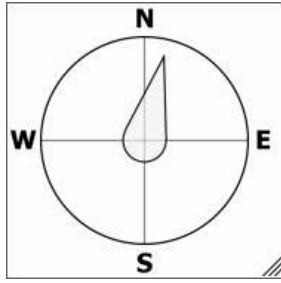

TIP : You can adjust the size of the compass by clicking on the right bottom corner and dragging it.

How to use the Alaris function button

The Alaris antenna has a function button that allows you to make Band and Mode selections. These can be selected using the rotary encoder and push button located on the front of the Alaris antenna grip.

To select a frequency:

1. Turn the rotary switch either to the left or right.
2. Watch the LEDs on the back of the grip. The LEDs indicate which frequency band is selected. Selections are:
 - Top LED, Band A: 9 kHz – 20 MHz
 - Middle LED, Band B: 20 MHz – 500 MHz
 - Bottom LED, Band C: 500 MHz – 8500 MHz

To select an amplifier mode:

1. Push the button on the front of the antenna grip.
2. Watch the LED on the back of the grip. It indicates the mode status as:
 - LED on: Active mode (amplifier on)
 - LED off: Bypass mode (amplifier off)

To take a measurement using the button:

1. Hold the button down for two seconds.
2. Release the button. The measurement is transferred and stored via the Map It function of SignalVu-PC.

See also:

[How to set up GNSS](#)

[How to use Map It](#)

How to use Map It

Select **View > Map It Toolbar** from the Main menu bar to open the Map It toolbar.

Once you have set up the GNSS receiver as shown [here](#), perform the following steps to capture the data. A Map It file includes trace data, measurement data, time, and location information for use in the RSA Map program.



Note: The Map It feature requires that the optional MAP application license be installed.

1. Check that at least one of the following displays is active: Spectrum, DPX, Spectrogram, Amplitude vs Time, Channel Power, or Occupied Bandwidth.
2. If an RSA306, RSA306B, RSA500A series, RSA600A series, or RSA7100 is not currently connected to the PC, you can connect one now, if desired.
3. Select **View > Map It Toolbar** from the main menu bar to view the Map It toolbar. Notice that the current GNSS location and time information are shown on the toolbar.

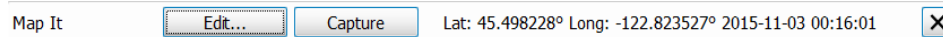

4. Click the **Edit...** button to open the Map It Editor window.
5. In the Map It Editor window, click the **Capture** button to capture data. If you prefer, you can click the **Capture** button on the Map It toolbar first, and then click **Edit...** to open the Map It Editor window to view the result.
6. You can now import, export, or recall captured data using the related buttons at the bottom of the Map It Editor window. If you export a file, you can then open it using the RSAMap application (open from the Tools menu).

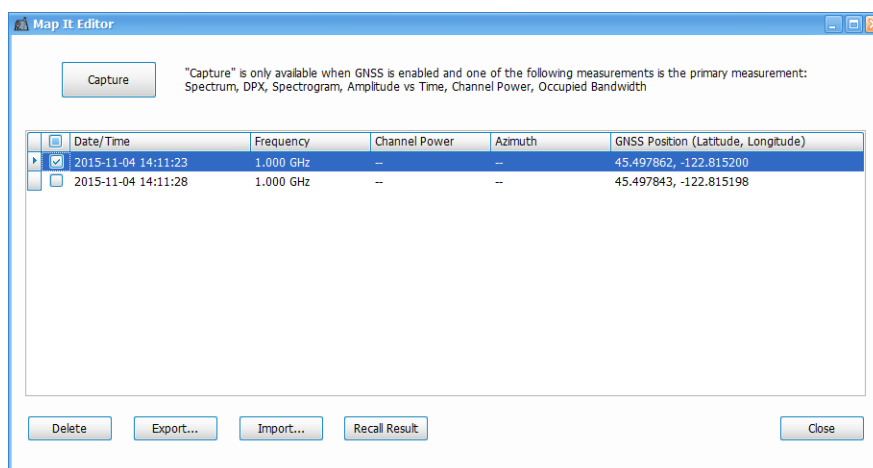

Importing and exporting Map It files

The information you capture can be zipped and stored as a single file with multiple captures. Recalling results will recall the trace data and settings stored with Map It. Make sure to uncheck the Show box in the traces menu of the selected display when you have completed examination of the Map It data.

The Map It zip file is structured as follows:

```
\(root)
+ Readme.txt = This document.
+ \Data = Contains all exported comma-separated trace data and image captures.
Also contains a measurement summary file.
  + Measurements.csv
  + <Timestamp>_Result.csv
  + <Timestamp>_Picture.png
+ \Mifmid = Contains exported .mif and .mid files.
  + <ArchiveFilename>.mif
  + <ArchiveFilename>.mid
+ \KMZ = Contains the exported .kmz file.
  + <ArchiveFilename>.kmz
+ \RSA = Contains RSA trace files for all measurements.
+ \Tek = Contains files for use by RSA Map.
+ \Map = Contains files and data for the map used with this archive.
```

Viewing live updates after viewing an imported file

When you want to view live updates again in a Spectrum, DPX, or Spectrogram display, you must go into the Traces tab of the Settings control panel and uncheck the **Show recalled trace** box. If you are using a DPX display, do this twice, once each for Bitmap and Trace 1.

See also:

[How to use the Antenna feature](#) [How to set up GNSS](#)

Configure In/Out and IQ Streaming

IQ Streaming overview

IQFlow™ provides IQ streaming with SignalVu-PC and the RSA7100. It allows you to use the analyzer as a down-converter and then pass the down-converted baseband I/Q signals to external equipment or locations for either additional processing or storage. Connection to an RSA7100 with one of the following options installed is required: 05 (LVDS), STREAM (40 GbE), and CUSTOM-API (API).

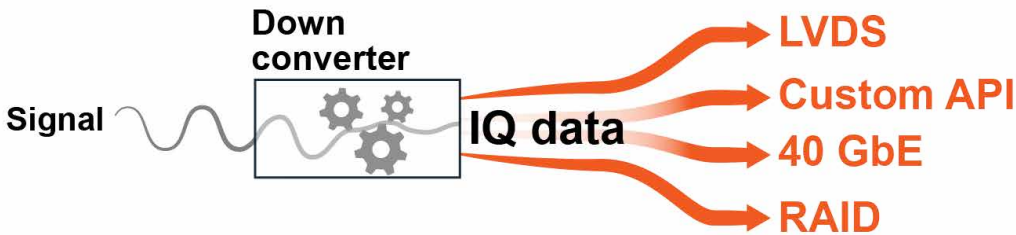

The Configure In/Out menu allows you to access the IQ Streaming control panel with its related features. Select **Setup > Configure In/Out** from the Main menu to access the IQ Streaming control panel.

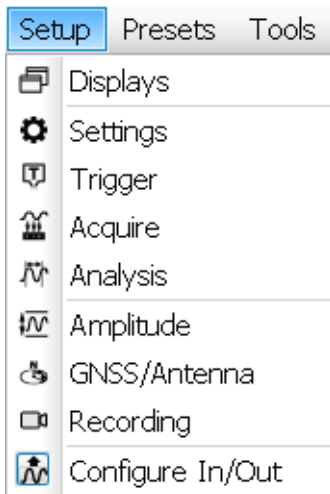

You can set the system to continuously stream IQ data from the device to one or more clients from the tabs on the IQ Streaming control panel.

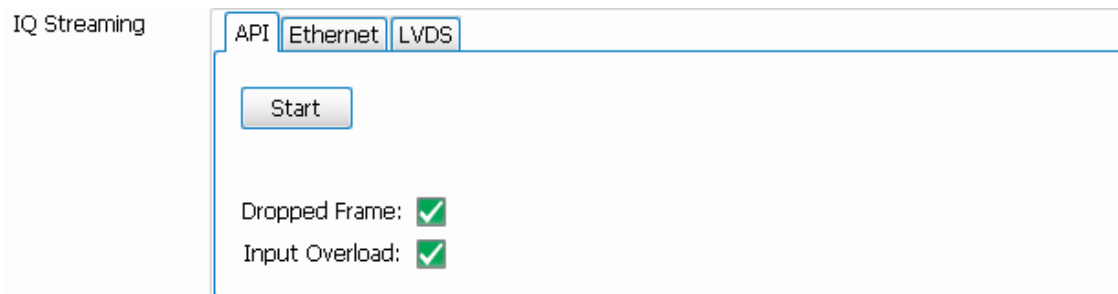

IQ Streaming control panel features

Tab	Description
API	Stream IQ data to your custom application.
Ethernet	Stream IQ data to the 40 GbE card on a client controller.
LVDS	Stream IQ data through the LVDS interface to a client controller.

IQ Streaming API

SignalVu-PC uses IQ block streaming. The API commands enable IQ data blocks to be streamed to a user program. You can specify to send the IQ data block and/or the Trigger time stamp using an API command. The Auxiliary data block is always sent. The **API** tab allows you to stream the specified IQ data to your custom application. This feature requires a RSA7100 with Option CUSTOM-API.

Select **Setup > Configure In/Out** from the Main menu to access the IQ Streaming control panel and the **API** tab.

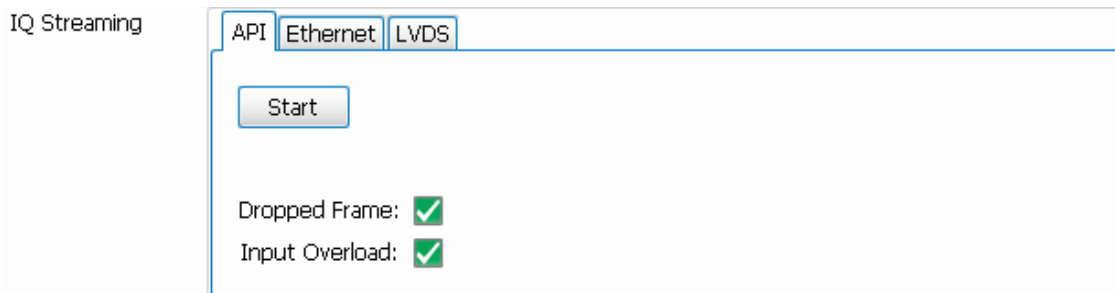

How to use the IQ Streaming API feature

1. Ensure the analyzer system has been running for the prescribed 30 minute warm-up period. If you start to stream data before this, SignalVu-PC will initiate an alignment. IQ outputs are disabled when an alignment is running and this causes streaming to stop.

The application will also initiate alignments at long intervals. To avoid later interruptions in streaming, select **Alignments** from the Main menu bar and click **Run alignments only when "Align" button is pressed** in the Alignments dialog that opens.

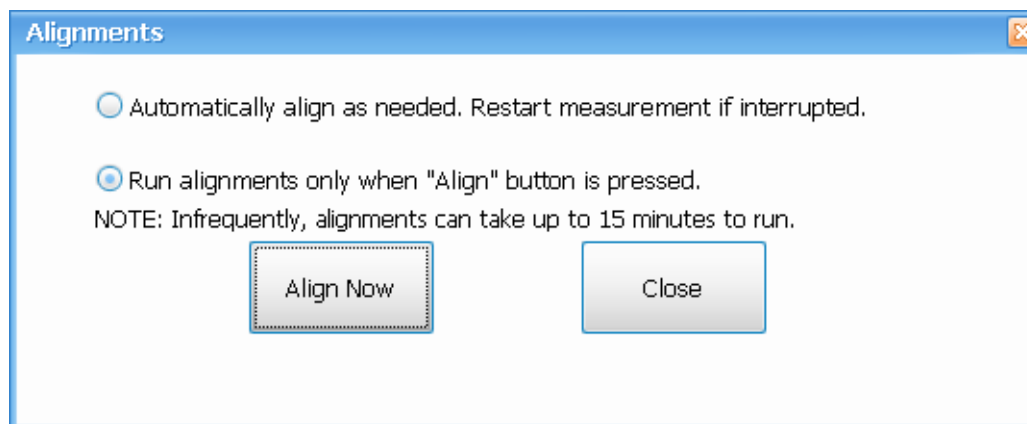

2. Run your custom application.
3. Click the **Start** button in the Streaming API tab in SignalVu-PC. The button will change to a Stop button when the data is streaming.

4. Check that the acquisition of data in your custom application is occurring.
5. Click the **Stop** button when you want to stop the streaming.



Tip: Ensure the analyzer system has been running for the required 30 minute warm-up time. If you start to stream data before this, SignalVu-PC will initiate an alignment, causing streaming to stop. To restart streaming, you need to click the Start button in the API tab. If you set the analyzer to only run alignments when the Align Now button is pressed, you can avoid interruption in streaming. However, alignments help ensure optimized performance.

API tab functions

Item	Description
Start button	Starts the streaming of recorded data to your custom application.
Dropped Frame	Indicates a missed frame has been detected in the streaming data. You can decrease the sample rate or increase the data block size to avoid missed frames. The Marker file (.xmrk) indicates the sample in which the Dropped Frame is detected. If the recording is done using the unpack data format and the acquisition bandwidth is equal to 800 MHz, you can select the packed data format to reduce Dropped Frame
Input Overload	Indicates if an overload has been detected in the stream. You can increase the reference level to avoid Input Overload. The Marker file (.xmrk) indicates the sample in which the Input Overload is detected. You can increase the reference level to avoid Input Overload.

40 GbE IQ Streaming Ethernet

Select **Setup > Configure In/Out** from the Main menu to access the IQ Streaming control panel and the **Ethernet** tab. This feature allows you to stream IQ data using 40 GbE on a host PC (CTRL7100 running SignalVu-PC) to a 40 GbE receiver on a client PC. This feature requires a RSA7100 with Option STREAM.

IQ Streaming

API Ethernet LVDS

Start

Address:

Port:

Dropped Frame:

Input Overload:

How to use the 40 GbE IQ streaming feature

1. Open a command prompt on the receiver PC. This is the PC on which you will run your application to receive the data.
2. Type ipconfig to query all addresses associated with an Ethernet connection.
3. Copy the IP address associated with the 40 GbE card.



Note: If needed, you can open the Network & Sharing Center in Windows to view connection properties. The 40 GbE card is labeled Mellanox ConnectX-3 Ethernet Adapter.

4. Run your application using the IP address and valid port number. For example, you would type `AppCustom.exe 33.0.0.1 21505` in the command prompt and then Enter.
5. In the SignalVu-PC application on the host PC (CTRL7100)
6. Click the Start button in the Streaming Ethernet tab in SignalVu-PC. The button will change to a Stop button when the data is streaming.
7. Check that the acquisition of data in your custom application is occurring.
8. Click the Stop button when you want to stop the streaming.

Table 48: Ethernet tab functions

Item	Description
Start button	Starts the stream of 40 GbE data from the host PC (CTRL7100 running SignalVu-PC) to a receiver (a PC running your custom application).
Address	Enter the IP address associated with the 40 GbE card in the receiver (PC running your custom application).
Port	Enter the valid port number of the receiver 40 GbE card.
Dropped frame	Indicates a missed frame has been detected in the streaming data. You can decrease the sample rate or increase the data block size to avoid missed frames.
Input overload	Indicates if an overload has been detected in the stream. You can increase the reference level to avoid Input Overload.

IQ Streaming LVDS

Select **Setup > Configure In/Out** from the Main menu to access the IQ Streaming control panel and the **LVDS** tab. This feature allows you to stream IQ data through the LVDS interface to a client controller. This feature requires a RSA7100 with Option 05.

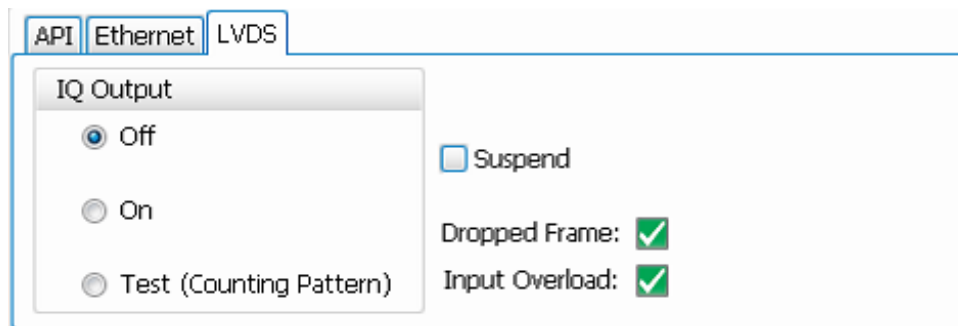

How to use the LVDS IQ streaming feature

1. While the system is powered off, connect the LVDS cable to the rear panel of the CTRL7100 controller hosting SignalVu-PC.

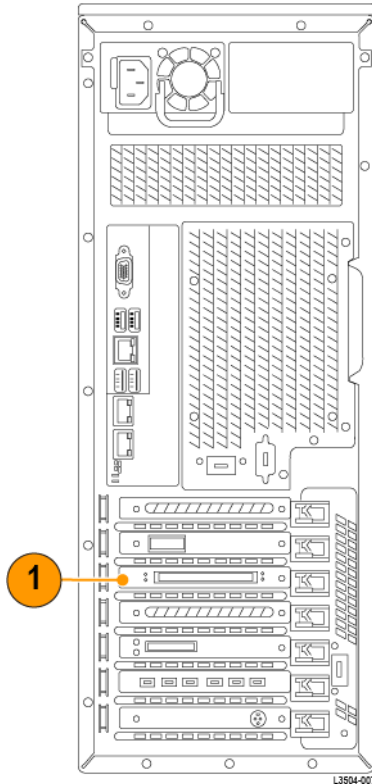

CAUTION: The pins and casing of the 80-pin connector on the LVDS port in the CTRL7100 controller are fragile. Use great care when disconnecting and connecting the ribbon cable. If the pins are bent or the casing broken, the LVDS card in the controller may need to be replaced.

2. Connect other end of the cable to the LVDS port in the client side of the system.
3. Turn on the host system.
4. Launch SignalVu-PC and select **Setup > Configure In/Out** from the Main menu to access the IQ Streaming control panel and the **LVDS** tab.
5. If you want to test the LVDS device is functioning before streaming the IQ data, click **Test (Counting Pattern)** and check that data is being received in the client side application.
6. When you ready to stream the IQ data, click **On** to start streaming of IQ data through the LVDS.
7. You can now view data in your client side application.

LVDS tab functions

Item	Description
Off	Stops streaming of IQ data through the LVDS.
On	Turns on streaming of IQ data through the LVDS.
Test (Counting Pattern)	Validates that the LVDS in the device is functioning.

Table continued...

Item	Description
Suspend	Check box to enable detection of the receiver suspend line. The receiver will raise the suspend line when the buffer is full and lower the suspend line when the buffer is ready to receive data (positive logic). Default is that the suspend line is ignored (unchecked).
Dropped Frame	Indicates a missed frame has been detected in the streaming data. You can decrease the sample rate to avoid missed frames.
Input Overload	Indicates if an overload has been detected in the stream. You can increase the reference level to avoid Input Overload.

Signal Database and Channel Navigation

How to use the Signal Database

Select **Tools > Signal Database** to open the Signal Database window. Here you can select which signal standards and types are listed (and selectable) in the Channel Navigation toolbar and/or the Define Survey control panel.

Signal standards and signal types defined

The analyzer uses the following definitions of signal standards and signal types to populate the Signal Database.

- **Signal standard:** A group of channels that adheres to the parameters and characteristics of a given signal type. These channels could include both uplink and downlink frequencies.
- **Signal type:** Parameters and characteristics (bandwidth, spectral shape) common to a given signal. A signal type can be shared by multiple signal standards.

How to select signal standards in the database window

The following image is of the Signal Database window with the Signal Standards tab selected. The table describes the fields and buttons of the tab. The standards selected here show in the Define Survey control panel and the [Channel Navigation](#) toolbar.

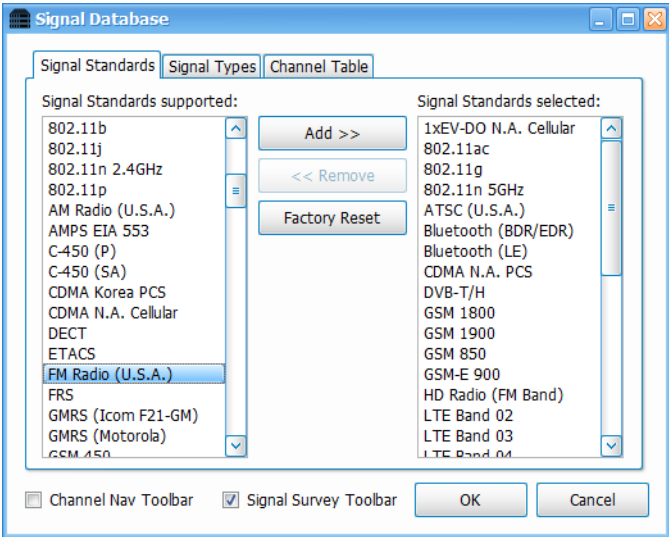

Setting	Description
Signal Standards Supported	List of all available signal standards. Click a standard to select it or click and drag to select a contiguous range of standards.
Add >>	Adds (moves) selected items from the Signal Standards Supported list to the Signal Standards selected list.
<< Delete	Deletes (moves) selected items from the Signal Standards selected list to the Signal Standards Supported list.

Table continued...

Setting	Description
Signal Standards selected	List of selected signal standards that will be made available in the Channel Navigation toolbar and the Region tab of Define Survey control panel. To delete items, select one or more signal standards and click the Delete button.
Factory Reset	Sets the supported and selected fields to the factory-specified signal standards.
Channel Nav Toolbar check box	Check box to open the Channel Navigation toolbar. The Signal Database window stays open. You can read more about the Channel Navigation toolbar here .
Signal Survey Toolbar check box	Check box to open the Signal Survey toolbar. The Signal Database window stays open. You can read more about the Signal Survey toolbar here .

How to merge the H500 signal database with SignalVu-PC default database

You can merge all user-defined signal types and signal standards from the Tektronix H500 instrument into the default SignalVu-PC signal database. This provides the advantages the new items introduced in SignalVu-PC without losing your user-defined additions. Merge databases as follows:

1. Close SignalVu-PC.
2. Make a copy of \BuiltInDisk\NetTekApps\Database\sst_db file to a USB memory stick from the H500 instrument.
3. Rename the copy of the sst_db file to SignalDatabase.rsadb.
4. On the PC with SignalVu-PC installed, overwrite the C:\SignalVu-PC Files\SignalDatabase\SignalDatabase.rsadb file with that you made in step 3 on page 812.
5. Start SignalVu-PC.
6. Verify all H500 user-defined signal standards and signal types are now available in SignalVu-PC.

How to select signal types in the database window

The following image is of the Signal Database window with the Signal Types tab selected. The table describes the fields and buttons of the tab. The types selected here show in the Define Survey control panel.

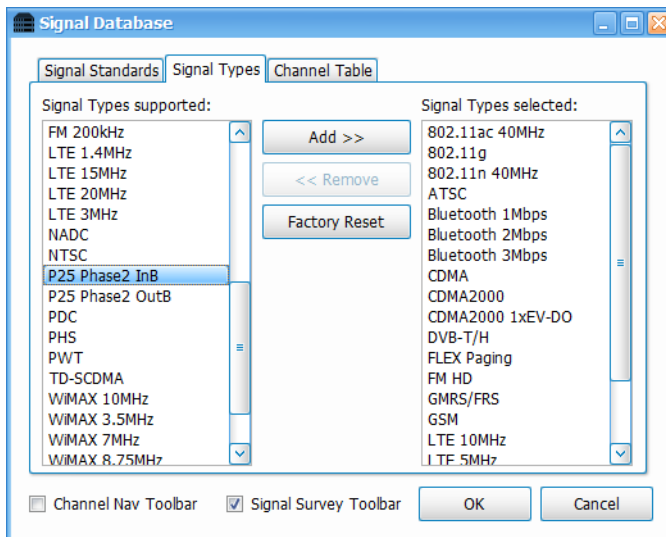

Item	Description
Signal Types supported	List of all available signal types. Click a type to select it or click and drag to select a contiguous range of types.
Add >>	Adds (moves) selected items from the Signal Types Supported list to the Signal Types selected list.
<< Delete	Deletes (moves) selected items from the Signal Types selected list to the Signal Types Supported list.
Signal Types selected	List of selected signal types made available in the Region tab of the Define Survey control panel. To delete items, select one or more signal types and tap the Delete button.
Factory Reset	Sets the supported and selected fields to the factory-specified signal types.
Channel Nav Toolbar check box	Check box to open the Channel Navigation toolbar. The Signal Database window stays open. You can read more about the Channel Navigation toolbar here ..
Signal Survey Toolbar check box	Check box to open the Signal Survey toolbar. The Signal Database window stays open. You can read more about the Signal Survey toolbar here ..

How to select channels in the database window

The following image is of the Signal Database window with the Channel Table tab selected. The table describes the fields and buttons of the tab. The channels selected here are included in the Signal Channel Selection window. (See the [Channel Navigation toolbar](#) on page 814 section for information about channel selection.)

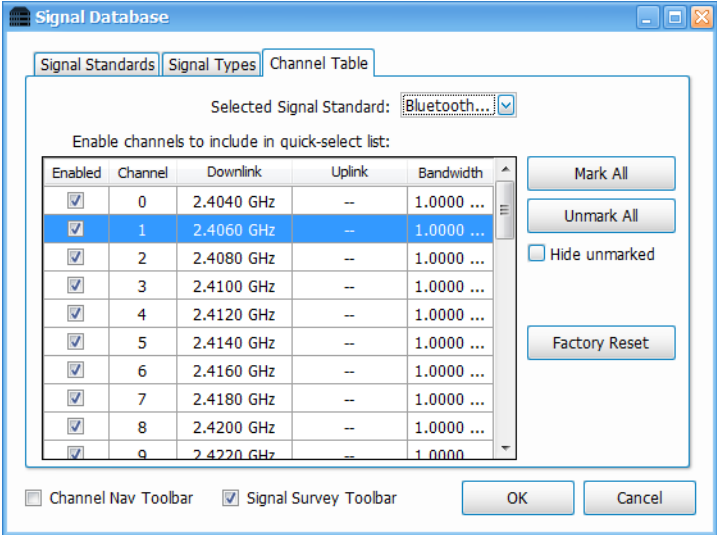

Item	Description
Selected Signal Standard	Drop down list allows you to select the signal standard, the channels of which will populate the channel table. This list is taken from the enabled standards in the Signal Standards tab.
Enabled column checkboxes	Enables/disables the channel in the row.
Mark All	Selects all channels in the table to enable them.
Table continued...	

Item	Description
Unmark All	Deselects all channels in the table to disable them.
Hide unmarked checkbox	Hides any deselected channels so that you can view only the enabled channels in the table.
Factory Reset	Sets each channel to the factory-specified enabled/disabled state.
Channel Nav Toolbar checkbox	Check box to open the Channel Navigation toolbar. The Signal Database window stays open. You can read more about the Channel Navigation toolbar here .
Signal Survey Toolbar checkbox	Check box to open the Signal Survey toolbar. The Signal Database window stays open. You can read more about the Signal Survey toolbar here .

Channel Navigation toolbar

Select **View > Chan Nav Toolbar** to view the Channel Navigation toolbar. This toolbar allows you to navigate easily from channel to channel in any measurement display. It provides the following capabilities:

- Select a channel for enabled standards (only standards selected in the Signal Database).
- Select the channel direction, if applicable (uplink or downlink).
- Access the Signal Channel Selection window, which allows you to select from a list of enabled channels.

The following image shows the toolbar and the following table describes how it functions.

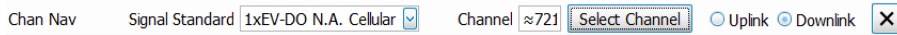

Item	Description
Signal Standard	Drop down list allows you to select the signal standard, the channels of which will populate the Channel field to the right. This list is taken from the enabled standards in the Signal Standards tab of the Signal Database.
Channel	<p>This field shows the channel number of the currently selected signal standard that the instrument is currently tuned to. An entry of "--" indicates that the current instrument frequency does not match that of any of the currently enabled channels.</p> <p>Clicking in this field allows for direct channel number entry. To select the next or previous channel, you can use the up and down arrow keys on your keyboard or the arrows in the Numeric Keypad (in the View menu, check the Numeric Keypad box). Note that this applies to enabled channels only.</p> <p>If you see a ≈ in front of the channel number, it means that the current instrument frequency is close to, but not exactly equal to, the currently selected channel. It means that the current instrument frequency does not exactly match the currently selected channel frequency, but that it is within the current channel bandwidth.</p> <p>You cannot directly enter or use the arrow keys to select non-numeric channel names for signal standards. You must use the Select Channel button.</p>

Table continued...

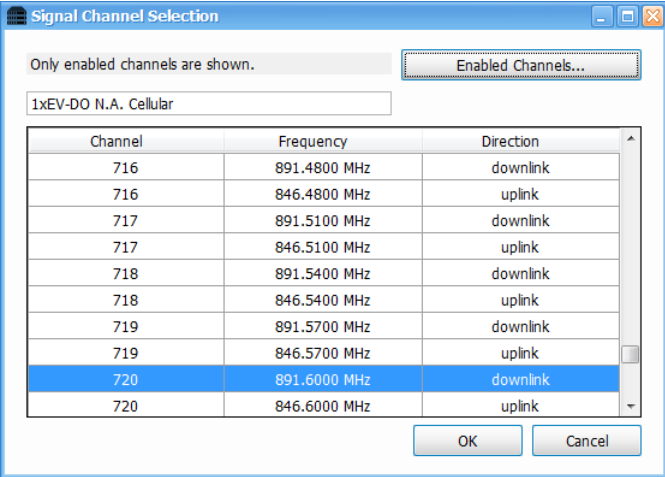
Item	Description																																	
Select Channel	<p>Opens the Signal Channel Selection window. This window shows a table of enabled channels for the selected standard. Click on the channel you want to view in the plot and then click the OK button. This window also allows you to access the Signal Database window (using the Enabled Channels button) so that you can enable different channels or change standards or types, if desired.</p>  <table border="1"><thead><tr><th>Channel</th><th>Frequency</th><th>Direction</th></tr></thead><tbody><tr><td>716</td><td>891.4800 MHz</td><td>downlink</td></tr><tr><td>716</td><td>846.4800 MHz</td><td>uplink</td></tr><tr><td>717</td><td>891.5100 MHz</td><td>downlink</td></tr><tr><td>717</td><td>846.5100 MHz</td><td>uplink</td></tr><tr><td>718</td><td>891.5400 MHz</td><td>downlink</td></tr><tr><td>718</td><td>846.5400 MHz</td><td>uplink</td></tr><tr><td>719</td><td>891.5700 MHz</td><td>downlink</td></tr><tr><td>719</td><td>846.5700 MHz</td><td>uplink</td></tr><tr><td>720</td><td>891.6000 MHz</td><td>downlink</td></tr><tr><td>720</td><td>846.6000 MHz</td><td>uplink</td></tr></tbody></table>	Channel	Frequency	Direction	716	891.4800 MHz	downlink	716	846.4800 MHz	uplink	717	891.5100 MHz	downlink	717	846.5100 MHz	uplink	718	891.5400 MHz	downlink	718	846.5400 MHz	uplink	719	891.5700 MHz	downlink	719	846.5700 MHz	uplink	720	891.6000 MHz	downlink	720	846.6000 MHz	uplink
Channel	Frequency	Direction																																
716	891.4800 MHz	downlink																																
716	846.4800 MHz	uplink																																
717	891.5100 MHz	downlink																																
717	846.5100 MHz	uplink																																
718	891.5400 MHz	downlink																																
718	846.5400 MHz	uplink																																
719	891.5700 MHz	downlink																																
719	846.5700 MHz	uplink																																
720	891.6000 MHz	downlink																																
720	846.6000 MHz	uplink																																
Uplink	Click to select the uplink channels for the currently selected signal standard.																																	
Downlink	Click to select the downlink channels for the currently selected signal standard.																																	

See also:

[How to use the Signal Database](#) on page 811

Signal Classification

Overview

With the SV54 optional application license for SignalVu-PC installed, you can use the signal classification toolset to help you classify signals. You will first define areas of interest as regions anywhere on a Spectrum or DPX waveform. You can then use our Signal Database tool to compare the spectral shape of the selected signal area to known signal types, and the center frequency of the selected signal area to known signal standard channels. Finally, you can assign classification labels to regions, record related notes, and save all defined regions to a region survey file. This toolset also allows you to import and export survey files. The following information and procedures are available to help you find, navigate through, and use the signal classification tools to classify a signal.

- [Step by step procedures for classifying a signal](#). These procedures walk you through the classification process from start to finish using the analyzer's signal classification tools. Examples are included.
- [How to use the Signal Survey toolbar](#). Once launched, this toolbar allows you to access the Create/Edit, Define, and Classify tools. These tools allow you to create a new survey/region, import and export surveys, define region signal standards and types, navigate quickly through regions in a survey, and classify a signal in a region.
- [Signal Survey toolbar](#) on page 823 [How to use the Signal Survey Editor window](#). This window is accessed through a Signal Survey toolbar button. It allows you to create and edit regions or import or export a survey.
- [How to use the Define Survey control panel](#). This panel is accessed through a Signal Survey toolbar button. It allows you to select signal standards and types from the Standards Database; see bandwidth, frequency, and channel information; view all regions and related information in a survey in a table; and select and view a spectral profile (most signal types have an available profile).

How to classify a signal

The following procedure shows you how to use the signal classification tools to classify a signal. It is divided into four main tasks.



Note: Before you proceed, you will need to select a list of enabled signal standards, signal types, and channels in the [Signal Database](#). You do not need to perform this setup each time you classify a signal. Once set up, this list does not change unless you reset to default or change the selections.

1. [Create](#) areas of interest as regions (center frequency and frequency span) anywhere on the signal.
2. [Define](#) a survey (a region or collection of regions) by comparing the bandwidth of the unknown signal to that of known signal types, and the center frequency of the unknown signal to that of known signal standard channel frequencies.
3. [Classify](#) the signal by assigning classification labels and notes to a defined region.
4. [Export or import](#) a region survey file.

Create a region

The first step in classifying a signal is to create a region that defines the portion of the signal you want to use.

1. Open a Spectrum or DPX display to view the signal you want to classify.
2. Select **View** from the analyzer menu bar and select (check) **Signal Survey Toolbar**. The toolbar will appear near the bottom of the screen.
3. Click the **Create/Edit...** button in the Signal Survey tool bar to open the Signal Survey Editor window.

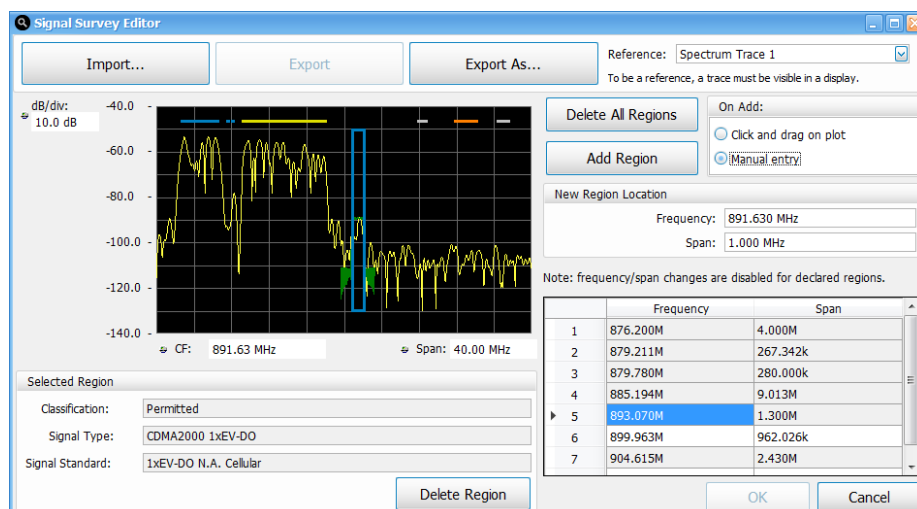

4. Check that the selected reference trace is correct in the Reference dropdown list which is located to the right of the **Export As...** button. Note that for a trace to be in the list, it must be enabled in the Spectrum or DPX display.
5. Click the **Add Region** button.
6. By default, **Click and drag on plot** is selected for the add region method. Click and drag on the plot around the signal area of interest to define the width (span) of the region. The analyzer will draw a box on the plot that is outlined in gray, indicating that the region is as yet undefined. Click on the  icon at the bottom of the region to change the CF. You can also click and drag on the left or right edge of the region rectangle to change its span. The amplitude of the signal does not need to be totally enclosed in the region box.
7. If you want to manually enter the center frequency and span parameters to create a region, select **Manual entry**, enter the values in the New Region Location fields, and then click the **Add Region** button.
8. Create more than one region, if needed.



Note: A maximum of two regions can overlap at any given frequency. If you try to create a new region that contains any frequency point that is already shared by two other regions, an error message is displayed stating that too many regions overlap.

9. If you want to edit a region, then you can use the same tools as when you first created the region (click, drag, ). If you want to delete a region, select the desired region and then click the **Delete Region** button. You can also click **Delete All Regions** to delete all regions in the display.

When Manual entry is selected in the On Add area, you can manually edit the Frequency and Span.

10. Click the **OK** button when you are finished creating and editing regions. Clicking the **Cancel** button will result in all additions/changes made during the current edit session (as long as the Signal Survey Editor dialog has been open) being discarded.

See also:

[How to use the Signal Survey Editor window.](#)

[How to use the Signal Survey toolbar.](#)

[How to use the Define Survey control panel.](#)

[What region color codes mean.](#)

[How to use the Signal Database](#) on page 811

Define a region using known standards

The next step after creating a region is to define it by comparing the unknown signal's bandwidth and frequency to the known signal standards and signal types. Doing this allows you to potentially find a match and classify the unknown signal. You can also use known signal standard channel frequencies to match against a region's center frequency.



Note: You can also define a region using a known signal standard channel frequency and match it against the center frequency of a region.

1. Click the **Define** button to open the Define Survey panel.
2. Do one of the following to select a region:
 - Click on a region (shown as a horizontal bar along the top edge of the plot) in the Spectrum or DPX display. When selected, the region will expand to a rectangular box around the signal.

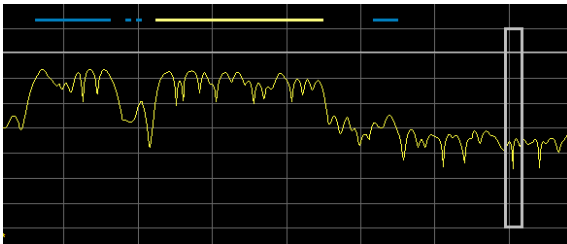

- Click on a row in the Survey Summary tab table of the Define Survey panel. This table is scrollable and contains summary information about all of the regions in the current display (called a survey). Clicking on a row in the table selects the region in the display. Information in the rows is not editable.

Region	Frequency	Span	Classification	Type	Standard
5	893.07038 MHz	1.3 MHz	None	CDMA2000 1xEV-DO	1xEV-DO N.A. Cellular
6	899.963038 MHz	962.026 kHz	None	Bluetooth 1Mbps	Bluetooth (LE)
7	904.614684 MHz	2.43038 MHz	Unauthorized	Not Set	Not Set
8	908.583544 MHz	1.392404 MHz	None	Not Set	Not Set

- Use the left or right arrows on the Signal Survey toolbar to navigate to the desired region. Notice that this will highlight the row number in the Survey Summary tab table of the associated region, and thus select the region in the display.



Note: Only one region can be active at a time. Inactive regions are shown as horizontal bars along the top edge of the signal. An active region is shown as a box drawn around the signal.

3. In the Define Signal panel, select the Region tab and click to view the drop-down list under the Signal Type Bandwidth. In the below image, you can see that in the list, the Bluetooth signal type has a star next to it. The degree and darkness of the shading of a star indicates how close of a bandwidth match the given signal type is to the unknown signal. (You can read about how the star indicator works in [The Define Survey control panel](#) topic.)

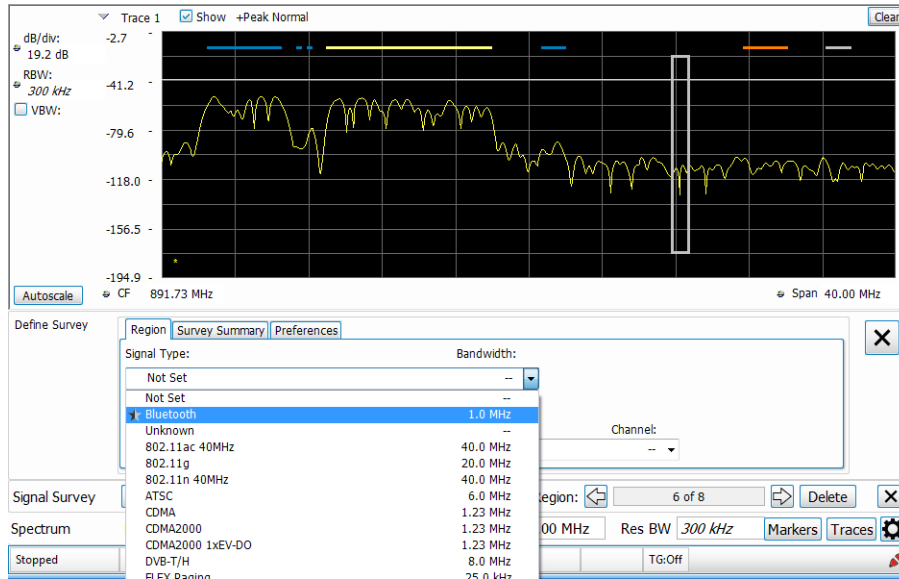

4. You now want to select from this list of known signal types and associated bandwidths. Once selected, a spectral profile (shown as a green waveform in the example image) will be overlaid on the portion of the signal in the region. The spectral profile is used to compare against the signal in the region. If the profile and the signal match, then there is a good chance the signal is that given signal type.

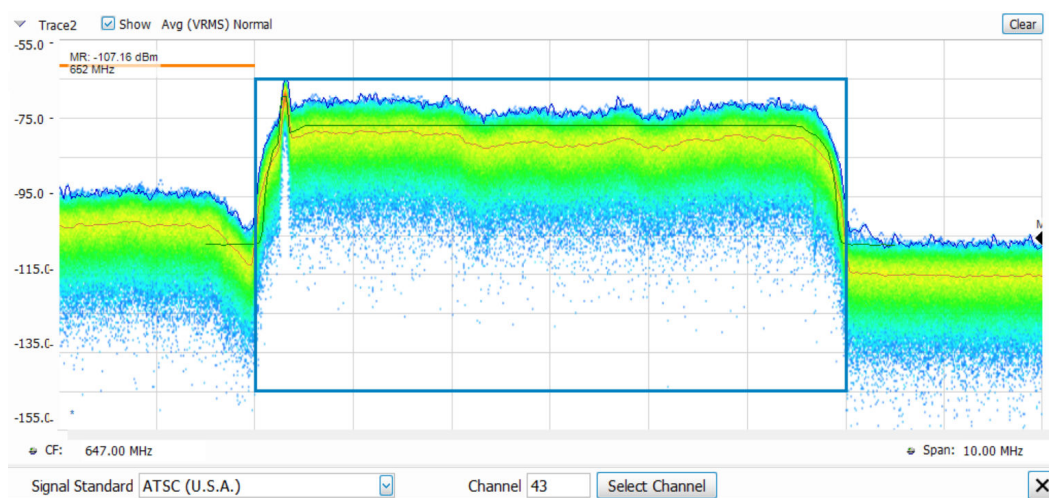

Note: Most, but not all, signal database signal types have spectral profiles.

5. Click on the Prefs tab in the Define Survey panel to set the spectral profile to do one of the following:
- **Snap to Channel Frequency:** Use this option if you want to verify the frequency of the signal is aligned with the selected signal standard channel frequency. If the selected signal standard channel frequency is within the selected region, then the spectral profile will center on that channel frequency. If the channel frequency is outside of the selected region, then the spectral profile will revert to being centered within the region.
 - **Snap to Center of Region:** Use this option if you know that the frequency you are viewing has no defined signal standard channels in the database.
 - **Off:** Use this option if you want to view the signal in the region without the spectral profile overlaid on the signal.

See also:

[The Signal Survey Editor](#) on page 823

[How to use the Signal Survey toolbar](#)

[How to use the Define Survey control panel.](#)

[What region color codes mean](#)

[Signal Database](#)

Classify a region

After you have created a region, you can classify it by assigning classification labels and notes to it.

1. Select a region.
2. Click the **Classify** button in the Signal Survey toolbar to view the Declare Region window.

3. Select a Classification state from the drop-down list and enter a Description and Comments for the region.

Classification state and region color coding.

Each region's outline is colored according to its classification state:

- Gray = None
- Yellow = Unknown
- Orange = Unauthorized
- Blue = Permitted

4. Click **OK** to save the classification information as a survey and close the window. Once a region has been classified, the signal type and signal standard used for classification are locked. To apply different signal types and standards to the region, set the classification to **None**.

The following example survey is of a portion of the TV broadcast band. Seven regions have been declared as either Permitted, Unknown, or Unauthorized, as indicated by the color bars for each region.

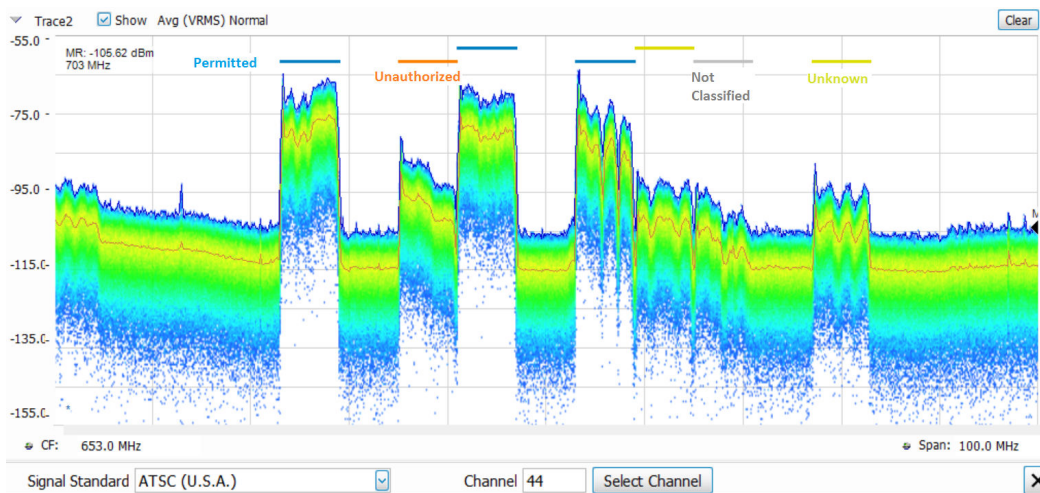

The illustration below shows a detailed portion of one of the declared regions. Since we have declared this to be an ATSC video signal, the spectral profile for the ATSC signal is shown overlaid in the region. The signal is a close match to the spectral profile, including the vestigial carrier at the lower side of the signal, characteristic of ATSC broadcasts.

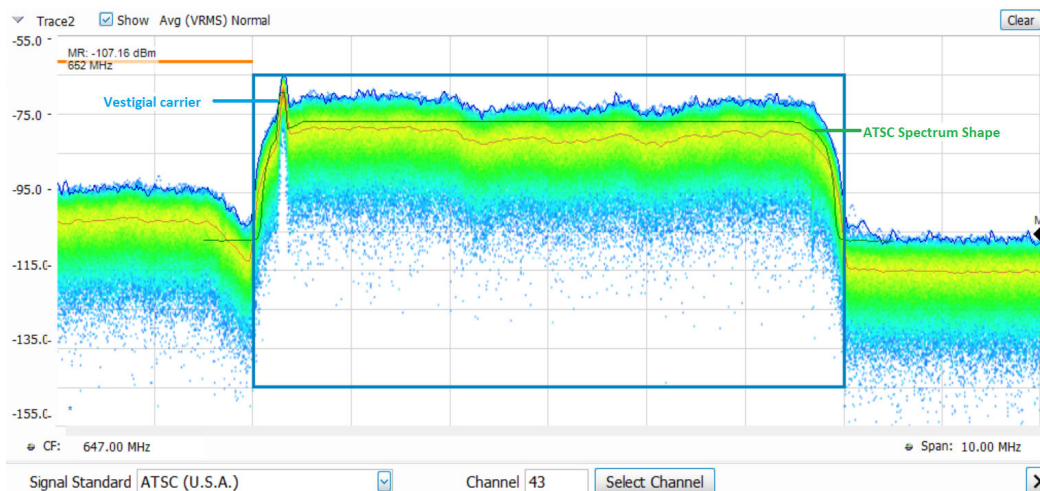

See also:

[How to use the Signal Survey Editor window](#)

[Signal Survey toolbar](#) on page 823

[The Define Survey control panel](#) on page 824

[How to use the Declare Region window](#)

[Signal Database](#)

Export or import a survey file

The application does not enforce a hard limit on the total number of regions you can create. However, as the number or regions increase, system performance decreases. A good rule of thumb is to keep the total number of regions under 500. If more than that are required, create and save separate surveys, each with no more than 500 regions.

Export a file. To export a region or set of regions in a file, do the following:

1. Click the **Create/Edit...** button in the Signal Survey toolbar to open the Signal Survey Editor window.

2. Click the **Export As...** button in the Signal Survey Editor window.
3. Navigate to the location you want to save the file.
4. From the Save as type drop down list in the Save As window, select one of the following:
 - *.Survey – survey in an internal format
 - *.txt – survey in a tab separated format
 - *.csv – survey in a comma separated format
5. Enter the file name and click **Save** to save the file.

Survey Import/Export file format notes.

- All lines starting with a "#" character are treated as a comment line.
- All blank lines are ignored.
- Lines starting with "Signal Classification: Number of Regions" are ignored (in order to be compatible with H500/SA2500 survey import/export files).
- The only required fields are the region center frequency and region bandwidth all other fields can be left blank.

Survey file field definitions. You can create your own .txt and .csv Survey files using software applications such as Excel or Notepad, and then import them. The following information will help you do this. You can also refer to the *SurveyImportFileExample.txt* sample import/export file installed with SignalVu-PC in the *C:\SignalVu-PC\SignalVuRSA5100BFiles\Example Files\SignalClassification* directory.

- **#** - Region number. Note that the value specified is not used during import (regions are renumbered as necessary)
- **Freq (Hz)** - Center frequency of the region
- **Span (Hz)** - Bandwidth of the region
- **Description** - Short description of the region
- **Classification** - Declared region classification (None, Unknown, Permitted, or Unauthorized)
- **Type** - Declared region signal type ("Not Set", "Unknown" or any currently defined signal type name)
- **Standard** - Declared region signal standard ("Not Set", "Unknown" or any currently defined signal standard name)
- **Channel** - Declared region channel number (channel number from the specified signal standard; "----" can be used to denote no channel number specified)
- **Ch Freq (Hz)** - Declared region channel frequency (for the specified channel number; "----" can be used to denote no channel frequency specified)
- **Comments** - Declared region comments

Import a file. To import a region or survey file, do the following:



Note: If a problem is found with the format of the file being imported, a dialog will be displayed indicating the file line number where the problem was found and a short description of the problem. For example, "Survey Import failed: Syntax Error near line 10: Invalid span value".

1. Click the **Create/Edit...** button in the Signal Survey toolbar to open the Signal Survey Editor window.
2. Click the **Import...** button in the Signal Survey Editor window.
3. Navigate to the location of the saved file and select to import one of the following file types:
 - *.Survey – survey in an internal format
 - *.txt – survey in a tab separated format
 - *.csv – survey in a comma separated format
4. Click **Open** to open the selected file.

Importing guidelines. If you try to import a survey when regions are already defined, an Import Regions dialog will appear and prompt you to select one of the following import options:

1. Delete all existing regions prior to import.

2. Attempt to merge the imported regions with the existing regions.
3. Cancel the import.

If an import and merge action does not successfully merge all regions, the "Warning: not all regions were successfully merged" message will be displayed in the informational area of the Signal Survey Editor dialog.

Signal Survey toolbar

Select **View > Signal Survey Toolbar** to view the Signal Survey toolbar. It allows you to create, edit, define, and classify a signal. It also allows you to navigate from one region to another in the DPX or Spectrum display and to delete the selected region. This topic describes the toolbar and all of its related windows and functions.



Item	Description
Create/Edit...	Opens the Signal Survey Editor window that allows you to create and edit regions and import and export region survey files.
Define	Opens the Define Survey control panel. This panel allows you to view a survey summary, select how to view spectral profiles, and to specify a signal type and signal standard channel for each region.
Classify	Opens the The Declare Region window (classify) that allows you to classify a region.
Selected Region	Click the arrows to navigate from region to region.
Delete	Click to delete a selected region.

The Signal Survey Editor

Click the **Create/Edit...** button on the Signal Survey toolbar to access the Signal Survey Editor window. Following is an image of the window and a table describing it.



Note: If you change which waveforms are enabled in the DPX or Spectrum display after the Signal Survey Editor window is open, the Reference list in the Editor will no longer be accurate. You must close and then reopen the Editor to refresh the list.

Item	Description
Import	Click this button to import a survey from a file.
Export	Click this button to save changes made to a previously saved survey file. This button is only available for previously saved surveys. This function is like the common Save function.
Export As...	Click this button to export all of the region information to a survey file. This function is like the common Save As function.
Reference	This drop down list shows all active traces from the currently displayed Spectrum and/or DPX measurement displays. When you first open the Editor, the displayed reference trace will be the trace in the currently selected Spectrum or DPX measurement display.
Delete All Regions	Click this button to delete all regions on the plot.
Add Region	Click the Add Region button to enable the plot to allow you to add a region by clicking and dragging or entering the values manually, depending on the selected On Add setting.
On Add:	Select to add a region manually or by clicking and dragging on the plot.
New Region Location	When Manual entry is selected in the On Add area, the New Region Location area appears. Here you can manually enter the Frequency and Span.
Status message area	Shows informational and error messages.

Table continued...

Item	Description
Region table	Shows regions and the related frequency and span. These are editable in the table for regions that have not yet been classified.
Measurement display	Interactive view of the active measurement plot (DPX or Spectrum). You can click and drag on the plot to create a region and left-click in the display area to select the current click/drag mode. Allowable modes are Select, Span Zoom, and CF Pan. You can also adjust the area of the signal within the region using the following:
dB/div	Shows the dB per division on the y-axis of the plot.
CF	Shows the current region center frequency. Click on the field to enter a new value.
Span	Shows the current region span. Click on the field to enter a new value.
Classification	Shows the classification label of the selected region: Unknown, Unauthorized, or Permitted. If it has not been classified, this field reads None.
Signal Type	Shows the signal type of the selected region, if the signal in the region has been classified. If it has not been classified, this field reads Not Set.
Signal Standard	Shows the signal standard of the selected region, if the signal in the region has been classified. If it has not been classified, this field reads Not Set.
Delete Region	Click this button to delete the selected region.

See also:

The [Create a region](#) on page 816 topic to see how the Signal Survey Editor works when creating/editing a region.

The Define Survey control panel

Click the **Define** button on the Signal Survey toolbar to access the Define Survey control panel. The following images and tables describe the Define Survey control panel and its tabs.

Region tab

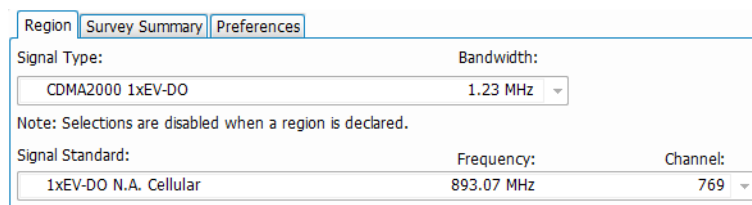

Item	Description
Signal Type	For classified regions, this field is not editable. For unclassified regions, this field is a drop-down list of all enabled signal types (set in the Signal Database). The types that best match the signal are starred in this list. See here for star rating definitions.
Bandwidth	Shows the bandwidth of the selected signal type.
Notification area	Notes may appear between the Signal Type and Signal Standard fields.
Signal Standard	For classified regions, this field is not editable. For unclassified regions, this field is a drop-down list of all enabled signal standards (set in the Signal Database) and standards for which channels are enabled. The standards and their channels that best match the center frequency of the region are starred in this list. See here for star rating definitions.
Frequency	Shows the channel frequency of the selected signal standard.
Channel	Shows the channel number for the selected signal standard. .

Criteria for signal standard and type star ratings.

Criteria		
Star	Signal standards	Signal types
★	The region center frequency matches the selected signal standard channel frequency and the selected signal standards database signal type matches that of the selected signal type.	The region bandwidth exactly matches the selected signal type bandwidth.
★	The region center frequency matches the selected signal standard channel frequency.	The region bandwidth is within $\pm 5\%$ of the selected signal type bandwidth and does not exceed the defined min/max matching bandwidth range of the selected signal type.
★	A large portion of the region start/stop frequency overlaps the selected signal standard channel frequency.	The region bandwidth is within the defined min/max matching bandwidth range of the selected signal type.
★	A small portion of the region start/stop frequency overlaps the selected signal standard channel frequency.	Not applicable.
No star	No portion of the region start/stop frequency overlaps the selected signal standard channel frequency.	The region bandwidth is outside the defined min/max matching bandwidth range of the selected signal type.

Survey Summary tab

Region	Survey Summary	Preferences			
	Frequency	Span	Classification	Type	Standard
1	876.2 MHz	4.0 MHz	Permitted	WCDMA	WCDMA 850
2	879.210653 MHz	267.342 kHz	Permitted	GSM	GSM 850
3	879.78 MHz	280.0 kHz	Permitted	GSM	GSM 850
4	885.19443 MHz	9.012658 MHz	Unknown	Not Set	Not Set
5	893.07038 MHz	1.3 MHz	Permitted	CDMA2000 1xEV-DO	1xEV-DO N.A. Cellular

Item	Description
Summary table of all of the regions in the active plot	Each region is identified by a number.
	The center frequency of the region.
	The span of the region.
	The classification of the signal in the region.
	The signal type of the signal in the region, if it has been set. Otherwise, this field reads Not Set.
	The signal standard and channel of the signal in the signal in the region, if it has been set. Otherwise, this field reads Not Set.

Preferences tab

Region	Survey Summary	Preferences
Spectral Profile:		
Snap to Channel Frequency		
Off		
Snap to Center of Region		
Snap to Channel Frequency		

Item	Description
Spectral Profile	<p>Off turns the spectral profile off so that it does not appear on the plot. Use this option if you want to view the signal in the region without the spectral profile overlaid on the signal.</p> <p>Snap to Center of Region aligns the spectral profile to the center of the region. Use this option if you know that the frequency you are viewing has no defined signal standard channels in the database.</p> <p>Snap to Channel Frequency aligns the spectral profile with the specified signal standard channel frequency of the signal. Use this option if you want to check that the channel frequency of the spectral profile matches the signal frequency you are looking at. If the selected signal standard channel frequency is within the selected region, then the spectral profile will center on that channel frequency. If the channel frequency is outside of the selected region, then the spectral profile will snap to the center of the region.</p>

See also:

[Define a region using known standards.](#)

The Declare Region window (classify)

Click the **Classify...** button on the Signal Survey toolbar to access the Declare Region window. Once a region is classified, you can no longer change the signal type or signal standard in the Region tab of the [Define Survey control panel](#). The following image and table describe the Declare Region window.

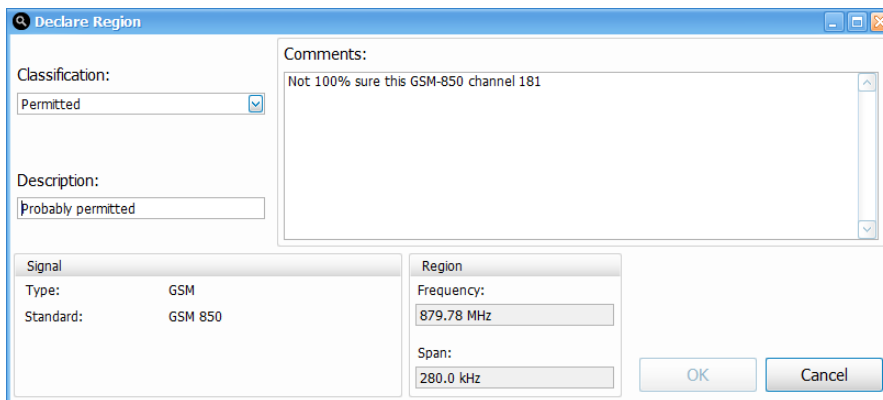

Item	Description
Classification	<p>Lists classification types to assign to the current region. Each classification has a unique color that is assigned to the region box:</p> <ul style="list-style-type: none"> None: Gray Unknown: Yellow Unauthorized: Orange Permitted: Blue
Description	Enter a brief description to identify the region.
Comment/Notes	Enter additional comments to provide needed information regarding the region.
Signal	Lists the selected signal type and signal standard of the selected region.
Region	Lists the span and center frequency of the selected region.



Note: If a region is classified, you need to change the classification to "None" before you can make any changes to that region.

Managing Data, Settings, and Pictures

Saving and Recalling Data, Settings, and Pictures

You can save different types of data for later recall and analysis.

Data type	Description	Save as type
Setup files	Saves all of the setup information for all displays, except those settings that are not part of Preset.	Setup (.Setup)
Picture of Selected Display (PNG/JPG/BMP)	Saves a capture of the screen in the specified format. This option is useful for including the graphic in reports or other applications. Marker readouts and other information are included.	Picture (.BMP, .PNG, .JPG)
Results Export files	Saves the trace and numeric data for the selected display. The trace and numeric data are saved as CSV files.	Results export (various)
Measurement Settings	Saves a list of settings relevant to the selected measurement. This option is useful for including the measurement settings in reports.	Measurement settings export (TXT)
Trace	Saves a trace for later recall into the display from which it was saved.	Selected trace (various)
Data	Saves data for reanalysis later or as data to use with external software (either CSV (comma-separated value) or MAT (MATLAB format)).	Acquisition data with setup (TIQ); or Acquisition data export (CSV or MAT) Acquisition data with setup for multichannel (TIQM). When connected to MSO/LPD the data is exported in CSV and MAT, only the data from the source corresponding to the selected measurement will be saved.

Saving Files

Saving files follows the same procedure regardless of the type of data being saved. To save setups (including application presets), pictures, results, or acquisition data:

1. If you are going to save DPX Spectra (DPXogram) acquisition data, stop acquisitions.

Saving while running is allowed by the analyzer, but data files saved while running will not contain any DPX spectral data (Not applicable for MSO / LPD).

2. Select **Save As** from the **File** menu to open the **Save As** dialog box.
3. Navigate to the folder where you want to save the setups, or use the default location.
 - To save setups so that they appear in the Application Presets window, save your setup in the folder **C:\SignalVu-PC Files\User Presets**. The saved setup will appear in the Application Presets window with the name you give the file.
4. Enter a file name.
5. Select the type of file to save from the **Save as type** drop-down list.
6. Click **Save**.

Recalling Files

You can recall three types of files: Setup files, Selected Trace, and Acquisition data with setup. Recalling data follows the same procedure regardless of the type of data being recalled.

1. Select **Recall** from the **File** menu to open the **Open** dialog box.
2. Navigate to the folder containing the file you want to recall.
3. Select the type of file to recall from the **Files of type** drop-down list. This selection determines the files that appear in the Open dialog box.
4. Select the file to recall.
5. Click **Open**.

Recalling waveforms with SignalVu-PC

SignalVu-PC can recall waveform files saved by Tektronix oscilloscopes and spectrum analyzers. It can also read files saved in MATLAB level 5 and level 7.3 formats. Waveform files can be recalled two ways: as Data and setup, and as Data only.

The following tables lists the supported file formats and includes notes about using the files.

Table 49: MSO 5/6 Series/LPD/RSA file formats supported by SignalVu-PC

Generated by		MSO 5/6 Series/LPD		
File type		.tiq	.tiqm	.mat
File description		Contains corrected I and Q time-domain data, all settings and measurement setup	Contains corrected I and Q time domain data, all settings and measurement setup for multiple sources.	Contains I and Q time-domain data, center frequency, sample rate
What SignalVu-PC can do with this format	Open with settings	All Settings and Measurements are Recalled	✓	✓
	Open as data only	Uses settings from SignalVu-PC when opened	✓	✓
Notes		tiq : Recalls saved displays	tiqm : Recalls saved displays along with their respective sources.	.mat: Recalls saved measurement along with its source in the selected display

Table 50: RSA5000/RSA6000/SPECMON file formats supported by SignalVu-PC

Generated by		RSA5000/ RSA6000/ SPECMON		
File type		.tiq		.mat
File description		Contains corrected I and Q time-domain data, all settings and measurement setup		Contains I and Q time-domain data, center frequency, sample rate
What SignalVu-PC can do with this format	Open with settings	All Settings and Measurements are Recalled	✓	✓
	Open as data only	Uses settings from SignalVu-PC when opened	✓	✓
Notes		This is the native format for SignalVu-PC. It contains all information needed to open and analyze all displays available, plus system information not used in analysis.		Contains all information needed to open and analyze files with SignalVu-PC. Can be opened by MATLAB.

Table 51: RSA3000 and WCA200 file formats supported by SignalVu-PC

Generated by		RSA3000, WCA200		
File type		.tiq		.mat
File description		Contains I and Q time-domain data, center frequency, sample rate, amplitude and phase corrections		Contains I and Q time-domain data, center frequency, sample rate
What SignalVu-PC can do with this format	Open with settings	All Settings and Measurements are Recalled		
		Automatically Sets Span, Center Frequency	✓	✓
	Open as data only	Uses settings from SignalVu-PC when opened	✓	✓
Notes		Recommend saving as .tiq file after opening		Recommend saving as .tiq file after opening

Table 52: WCA300 file formats supported by SignalVu-PC

Generated by	WCA300	
File type	.iqt	
File description	Contains I and Q time-domain data, center frequency, sample rate, amplitude and phase corrections	
What SignalVu-PC can do with this format	Open with settings	All Settings and Measurements are Recalled
		Automatically Sets Span, Center Frequency ✓
	Open as data only	Uses settings from SignalVu-PC when opened ✓
Notes	Recommend saving as .tiq file after opening	

Table 53: SignalVu on oscilloscopes file formats supported by SignalVu-PC

Generated by			SignalVu on oscilloscopes		
File type			.tiq	.tiqm	.mat
File description			.tiq format as used by SignalVu, all versions, includes I and Q time domain data, all settings and measurement setup	tiq format as used by SignalVu, all versions, includes I and Q time domain data, all settings and measurement setup for multiple sources.	Contains I and Q time-domain data, center frequency, sample rate

Table continued...

What SignalVu-PC can do with this format	Open with settings	All Settings and Measurements are Recalled	✓	✓	✓
		Automatically Sets Span, Center Frequency			✓
	Open as data only	Uses settings from SignalVu-PC when opened	✓	✓	✓
Notes			This is the native format for SignalVu-PC. It contains all information needed to open and analyze all displays available	This is the native format for SignalVu-PC. It contains all information needed to open and analyze all displays available for multiple sources.	Recommend saving as .tiq file after opening

Table 54: Performance Oscilloscope (without SignalVu) file formats supported by SignalVu-PC

Generated by	MSO/DPO/DSA5000/7000/70000				
File type	.wfm				
File description	Amplitude vs. Time, includes sample rate information				
What SignalVu-PC can do with this format	Open with settings	All Settings and Measurements are Recalled			
		Automatically Sets Span, Center Frequency			
	Open as data only	Uses settings from SignalVu-PC when opened	✓		
Notes	Prior to opening: Preset SignalVu-PC. Set span and center frequency. After opening, save as .tiq file. Reopen the .tiq file for further changes to the measurement settings and opening additional displays				

Table 55: Bench Oscilloscope file formats supported by SignalVu-PC

Generated by	MSO/DPO 2000, 3000, 4000		
File type	.isf		
File description	Amplitude vs. Time, includes sample rate information		
What SignalVu-PC can do with this format	Open with settings	All Settings and Measurements are Recalled	
		Automatically Sets Span, Center Frequency	
	Open as data only	Uses settings from SignalVu-PC when opened	✓
Notes	Prior to opening: Preset SignalVu-PC. Set span and center frequency. After opening, save as .tiq file. Reopen the .tiq file for further changes to the measurement settings and opening additional displays		

Table 56: MDO4000B/C mixed domain oscilloscope file formats supported by SignalVu-PC

Generated by	MDO4000B/C, RF channel		
File type	.tiq		
File description	Contains I and Q time domain data. Opens with spectrum analyzer and time overview.		
What SignalVu-PC can do with this format	Open with settings	All Settings and Measurements are Recalled	
		Automatically Sets Span, Center Frequency	
	Open as data only	Uses settings from SignalVu-PC when opened	✓
Notes	Native format for SignalVu-PC. Opens with Time Overview and Spectrum Display active		

Table 57: H500 and SA2500 file formats supported by SignalVu-PC

Generated by	RF Hawk	
File type	.iqt	.mat

Table continued...

File description		Contains I and Q time-domain data, center frequency, sample rate	Contains I and Q time-domain data, center frequency, sample rate
What SignalVu-PC can do with this format	Open with settings	All Settings and Measurements are Recalled	
		Automatically Sets Span, Center Frequency	✓
	Open as data only	Uses settings from SignalVu-PC when opened	✓
Notes		Recommend saving as .tiq file after opening	Recommend saving as .tiq file after opening

Table 58: User generated (including Agilent 89601 software) file formats supported by SignalVu-PC

Generated by	User generated (including Agilent 89601 software)		
File type	.mat		
File description	MATLAB level 5 and level 7.3 formats, must contain at least InputCenter, InputZoom, Xdelta, and Y		
What SignalVu-PC can do with this format	Open with settings	All Settings and Measurements are Recalled	
		Automatically Sets Span, Center Frequency	✓
	Open as data only	Uses settings from SignalVu-PC when opened	✓
Notes	Recommend saving as .tiq file after opening		

To recall a acquisition data file, see [Recalling Files](#) on page 829 above.

Supported MAT File versions

Data recall and saving using .mat file supports two versions: MATLAB Level 5 (v6) and MATLAB v7.3.



Note: Note: When connected to MSO/LPD Source 1 Analysis length is default.

MATLAB v7.3 uses HDF5 format to store data and does not have the limit of 2 GB per variable that Level 5 does. If you try to save more than 2 GB in MATLAB Level 5 (v6 format), a warning shows and prompts you to select Level 7.3 format.

Opening .iqt files saved by RSA3000 and WCA300 analyzers. To open a .iqt file:

1. Select **File > Preset (Main)**.
2. Select **File > Recall** and select **Acq Data with Settings (IQT) (*.iqt)** in the Open dialog. Select the desired file and click **OK** to open the file.
3. Save the file by selecting **File > Save As** and set the file type to **Acq data with setup (TIQ) (*.tiq)**. Save the file by clicking **OK**.

Saving the file in .tiq format preserves all of the settings in the analyzer and associates them with the data set. After saving the file in .tiq format, recall the saved .tiq file and add measurements and change settings.

The .iqt file format contains I and Q waveforms plus instrument amplitude/phase correction data, analysis bandwidth and center frequency. When SignalVu-PC opens an .iqt file, the amplitude and phase corrections are applied to the IQ data to produce a corrected data set. The span and center frequency information present in the .iqt file are used to set the SignalVu-PC span and center frequency. However, no information about analysis length, offset or type is preserved in the .iqt file.

Opening .mat files saved by RSA5000/6000/SPECMON series and third party waveforms. To open a .mat file from these instruments:

1. Select **File > Preset (Main)**.
2. Select **File > Recall** and select **Acq Data with Setup (MAT) (*.mat)** in the Open dialog. Select the desired file and click **OK** to open the file

If you choose to save the file in .mat format, SignalVu-PC automatically adds all of the SignalVu-PC settings needed for your analysis into the stored .mat file.

Opening files saved with oscilloscopes. Oscilloscopes acquire and store data in an amplitude vs. time format that must be converted by SignalVu-PC into an IQ format for further processing. Sample-rate and amplitude information is available in these files, but no other information is available to SignalVu-PC.

To open files stored in either .ISF or .WFM format saved by Tektronix oscilloscopes, use the following procedure:

1. Preset SignalVu-PC. This resets the analysis so that only the spectrum analyzer display is present, with a center frequency of 250 MHz and a span of 200 MHz.
2. Set the Span of SignalVu-PC to $0.2 \times$ Sample Rate of the acquisition.

How to determine the maximum available span for your .ISF or .WFM file: The maximum span is calculated to be $0.4 \times$ Sample Rate. For example, a waveform sampled at 1 GSample/second will have a maximum span of $0.4 \times (109) = 400$ MHz. This represents the Nyquist bandwidth of the sampling system plus an allowance for filter bandwidth. Note that this span may exceed the bandwidth of the oscilloscope used, and results at frequencies higher than the oscilloscope bandwidth will be attenuated.

When processing the waveform, SignalVu-PC automatically sets the bandwidth to twice the entered span to allow for increasing the span in later analysis. Set the span of the spectrum analyzer to $\frac{1}{2}$ the calculated maximum span. In the case of the example of above, this is $\frac{1}{2} \times 400$ MHz, or 200 MHz.

3. Set the center frequency to $\frac{1}{2}$ of the span. This puts the analysis frequency within the first Nyquist zone to prevent aliasing of the signal.
4. Open the .ISF or .WFM file with the settings above.

5. Set the span to the calculated maximum (in the example above, $0.4 \times \text{Sample Rate} = 400 \text{ MHz}$) and reanalyze.
6. Save the results as a .TIQ file. This preserves all of the settings in the analyzer and associates them with the data set.

Note: When connected to MSO/LPD



- Source 1 Analysis length is default.
- DPX Spectra is disabled

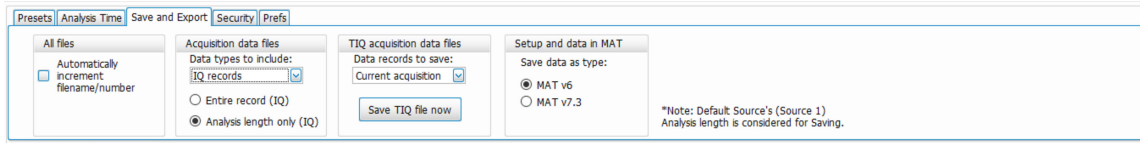

The above figure is shown when connected to MSO/LPD.

Setup Files

You can set up the instrument as desired and then save the settings in a setup file. This enables you to quickly setup the instrument by recalling previously saved setups.

Exporting Results

Save for further analysis of results in other programs, such as MATLAB or Excel.

Pictures of the Selected Display

You can save pictures of the instrument display for documentation purposes. When saving pictures of the display, you can select from three file types: BMP, JPG, or PNG.

Measurement Settings

You can save a list of settings relevant to the selected display to a file for documentation purposes. The exported file uses tab characters to separate values. The settings included in the file depend on the selected display. The contents of the file are the same as a Results export except it does not include the results.

Saving Acquisition Data with Setup

Save for later analysis with the analyzer. The setup is saved as part of the acquisition data file so you can choose when recalling data whether or not to also recall the associated acquisition and analysis parameters.

Saving Acquisition Data Export in CSV Format

Save for examining results in other programs, such as MATLAB or Excel.

Data, Settings, and Picture File Formats

You can save different types of data for later recall and analysis.

Saved File Types

File type	File extension	Description
Setup files	.setup	Setup files enable you to save instrument settings for later recall. Using these files saves setup time and ensures consistent measurements.

Table continued...

File type	File extension	Description
Picture	.png/.jpg/.bmp	Screen capture of SignalVu-PC application window. They are useful for documenting results in test reports.
Results Export	.csv	Results files contain the trace points and numeric values that were produced by the selected measurement. The header of a Results file includes key acquisition and analysis settings to aid in the interpretation of the data. The file is saved as a plain text file, but the contents are formatted as CSV (comma-separated values). Results files can be opened from applications such as Microsoft Excel.
Measurement Settings	.txt	Measurement settings files contain a list of settings that describe how the instrument is set up for the selected measurement. The list contains measurement settings (for example, Span), trace settings (for example, whether or not a trace is selected) and global settings (for example, Frequency and Reference Level). The list of settings contained in the file varies depending on which display is selected.
Selected Trace	Varies with display	Trace files contain the trace results data in binary format. These files are only readable by the SignalVu-PC application. Several of the instrument's measurements allow you to recall a Trace file for visually comparing a saved trace to a live trace.
Acquisition Data with Setup	.tiq .tiqm (Multichannel)	<p>These files contain the acquisition data record and complete instrument setup (in binary format). Use these files to save data for later recall and analysis. When you save an Acquisition Data file, the current Setup is always saved with all the opened displays. At the time of recall, you will be asked whether you want to restore only the acquisition data or both data and setup. If the instrument is already set up for a specific measurement, you will probably want to recall only the acquisition data. Recalling both data and setup returns the instrument to the same state it was in at the time you saved the file.</p> <p>When connected to MSO, When you save an Acquisition Data file, the current Setup is always saved with all the opened displays with respective source as tiqm file.</p> <p>GNSS time locked with GPS enabled.</p>
Acquisition Data	.csv	<p>These files contain IQ sample data before it has been processed by a measurement. The acquisition data points are saved as IQ pairs for the selected display. Use this format to import the acquisition data into Microsoft Excel for further analysis.</p> <p>When connected to MSO/LPD, the acquisition data points are saved as IQ pairs for the selected display with its respective source.</p>

Table continued...

File type	File extension	Description
Acquisition Data	.mat	<p>These files contain IQ sample data before it has been processed by a measurement. The acquisition data points are saved as IQ pairs for the selected display. Use this format to import the acquisition data into MATLAB for further analysis.</p> <p>When connected to MSO/LPD Acquisition data in .mat with respect to active display is saved and recalled</p> <p>These files also contain instrument setting information. You do not have to use the settings information. To remove it, you can load all information to MATLAB, then write out is a .mat file without the settings information. (See the Acquisition Data Files (.mat) topic for required .mat format.)</p>
Range file	.csv	<p>These files contain a list of settings that describe how the instrument is set up for the Spurious measurement. The file contains the number of ranges enabled, the start and stop frequencies for each enabled range, the limits for each enabled range, the mask type and more.</p>
Recorded file (RSA500A series, RSA600A series, and RSA306B only)	.r3f	<p>These files contain acquisition data that was recorded directly to a file from an RSA306B, RSA500A series, RSA600A series spectrum analyzer.</p> <p>These files can be played back using the Playback feature located in the Acquisition control panel (with Option SV56-SVPC).</p>
Recorded file (When connected to an RSA)	.cdif	<p>This combined file contains header and IF samples (IQ samples for the RSA7100) in Midas 2.0 (Platinum BLUE) format. These files contain acquisition data that was recorded directly to a file from an RSA306B, RSA500A series, RSA600A series, or RSA7100 spectrum analyzer.</p>
Recorded file (When connected to an RSA)	.cdif + .det (or .det12)	<p>This is a separate header (.cdif) file and an IF sample (IQ sample for RSA7100) data (.det or .det12) file in Midas 2.0 (Platinum BLUE) format.</p> <p>When using the RSA7100, recordings at 800 MHz bandwidth with the packed data setting on will generate a .cdif and a .det12 file. (See the Midas recording choices table for more information about the .det12 file type.)</p>
Recorded file (RSA7100 only)	xdat, .xhdr, .xmrk	<p>These 3 files (all with the same file name) are generated when XDAT is the selected format for recording. They can be played back using an external application. GNSS time locked with GPS enabled.</p> <p>.xdat: sample data file containing binary IQ samples in normal (16 bit integer) or packed (12-bit integer) data type.</p> <p>.xhdr: header file containing instrument setup information in XML format.</p> <p>.xmrk: marker file in XML format containing time, location (GPS only), and the time stamp of the GPS, PPS, or IRIGUID-A88BD14F-0A29-4276-A887-CB84AB2B2A94B event during recording. Includes time qualified triggers.</p> <p>See the Record Setup topic for more information.</p>

Results Export File Format

The Results Export format contains trace points and/or scalar results produced by the measurement. The file contains general information about the measurement settings at the top of the file and the results data in the second part of the file. Groups of settings or results are headed with [text], as described below.

At the top of the file is the measurement name and the date and time data was acquired.

The first group of settings is [Global Parameters]. These settings include the Measurement Frequency, Acquisition Data, Reference Level and others.

The second group of settings is [Parameters]. These settings are specific parameters which vary depending on the measurement.



Note: When connected to MSO/LPD the source specific parameters are second group in Measurement Settings Export (.txt) and Results export (.csv).

The next group is [Trace Parameters], which may not be present, depending on the measurement. Within this group, there are parameters specific to a trace. There will be a Trace Parameters group for each trace shown on the display.

The next group is [Results]. These are scalar results for the measurement.

Next is [Traces]. The Traces group consists of one or more [Trace] groups. There is one Trace group for each trace. Each [Trace] group contains background information about the trace (units, number of points, x scaling, and others depending on the measurement) at the top of the group, followed by the trace points.

Acquisition Data with Setup File (.tiq) Format

The file consists of two parts: The header that is in XML and the data that is in binary format.

Header: The header consists entirely of the DataFile element. This element is broken down into sub-elements.

1. DataSetsCollection
2. Setup for different sources
3. GNSS data: The GnssData group starts at byte location 612,312. GNSS data is bracketed as <GnssData></GnssData>. Each GNSS parameter is bracketed by its name. For example, <PositionX>76.854334</PositionX>.

In order of occurrence:

- Status
- Position X
- Position Y
- Altitude
- Timestamp
- Speed
- Course
- Satellites Locked

DataSetsCollection: The DataSetsCollection contains a DataDescription element, a DataSet element, and a ProductSpecific element.

Binary data: The binary data is a sequence of Int32 values, which are IQ pairs (I,Q,I,Q, ...) in binary Little Endian format. To convert these values to volts, multiply the individual values by the Scaling value in the DataDescription. The binary data starts at an offset into the file == the "offset" attribute in the DataFile element. This offset number will always start at the 19th character into the file (starting with 1), and will always be 9 characters long.



Note: Modifying the XML header changes the offset to the start of the binary data.



Note: Saving a multi-source setup as TIQ file saves the data only for Source 1.

Table 59: Backward compatibility for TIQ files

Recalled in SignalVu Version				
TIQ File Saved in SignalVu Version		Version 4.5 or previous	Version 5.0/ 5.1 / 5.2	Version 5.3
	Version 4.5 or previous	Yes	Yes	Yes
	Version 5.0/ 5.1 / 5.2	No	Yes	Yes
	Version 5.3	Yes	Yes	Yes

Acquisition Data with Setup for Multichannel File (.tiqm) Format

The file consists of two parts: the header that is in XML and the data that is in binary format.

Header: The header consists entirely of the DataFile element. This element is broken down into sub-elements.

1. DataSetsCollection
2. Setup for different sources
3. GNSS data

The GnsData group starts at byte location 612,312. GNSS data is bracketed as <GnsData></GnsData>. Each GNSS parameter is bracketed by its name. For example, <PositionX>76.854334</PositionX>.

In order of occurrence:

- Status
- Position X
- Position Y
- Altitude
- Timestamp
- Speed
- Course
- Satellites Locked

DataSetsCollection: The DataSetsCollection contains a DataDescription element, a DataSet element, and a ProductSpecific element.



Note: The data and setup for multiple sources can be saved as tiqm file. This is available from version 5.3 onwards.

Acquisition Data Files (.csv)

The acquisition data files have two sections. At the top of the file is the following information:

- SamplingFrequency - The sampling frequency in Hertz.
- NumberSamples - The number of IQ samples in the file.
- DateTime - When the data was acquired.
- Frequency - The center frequency in Hertz.
- AcquisitionBandwidth - The acquisition bandwidth Hz.

Following the AcquisitionBandwidth are the data. The data are IQ pairs, in volts.

Groups of settings or results are headed with [some text].

The first thing in the file is the measurement name and the date/time when the acquisition was taken.

The first group [Parameters] are global parameters. Measurement Bandwidth in this group is the measurement bandwidth used by the General Signal Viewing measurements (Spectrum, Amplitude vs. Time, etc). It also includes some source settings, like Acq BW, Dither, Preamp, and RF Attenuation.

The second group [Parameters] are measurement-specific parameters.

Another group which can occur is [Trace Parameters]. Within this group, there will be a set of parameters, one for each trace that is currently shown.

Another group is [Results]. These are scalar results for the measurement.

Another group is [Traces]. It has [Trace] groups under it, one for each trace. Each [Trace] group has some background information about the trace (units, number of points, x scaling, etc), and the trace points themselves.

Acquisition Data Files (.mat)

The acquisition data files saved in MATLAB format contain the following MATLAB variables:

- InputCenter - The center frequency in Hertz.
- XDelta - The sample period in seconds.
- Y - A complex array containing IQ pairs.
- InputZoom - The acquisition bandwidth in Hertz.

The MATLAB format used to save acquisition data has the following properties and limitations:

- Files are stored in MATLAB Level 5 (when v6 is selected) or Level 7.3 (when v7.3 is selected) format.
- MATLAB Level 5 file size is limited to 2 GB. If you try to save more than 2 GB in MATLAB Level 5 (v6 format), the following warning shows and prompts you to select Level 7.3 format.



Printing Screen Shots

You can print screen shots (screen captures) two ways: use File >Print or save a picture file and print the file using a separate graphics program. Printing a screen capture is the same as printing with any windows program. For details on the available file formats for saving a screen capture, refer to [Data, Settings, and Picture File Formats](#). For details on saving a picture to a file, see [Saving and Recalling Data, Settings, and Pictures](#).

To print a screen shot:

1. Select **File >Print**.
2. Select **File >Print Preview** if you wish to review the screen shot before sending it to the printer.
3. Select **File >Print** to print the file to a printer.

Reference

Application Help

Menu Bar: Help > User Manual

This menu item displays this Help. It is a standard Windows help system. The Help menu item is the only method available to display the help; there are no other links to the help within the software.

About the Vector Signal Analysis Software

This window displays information about the SignalVu-PC software.

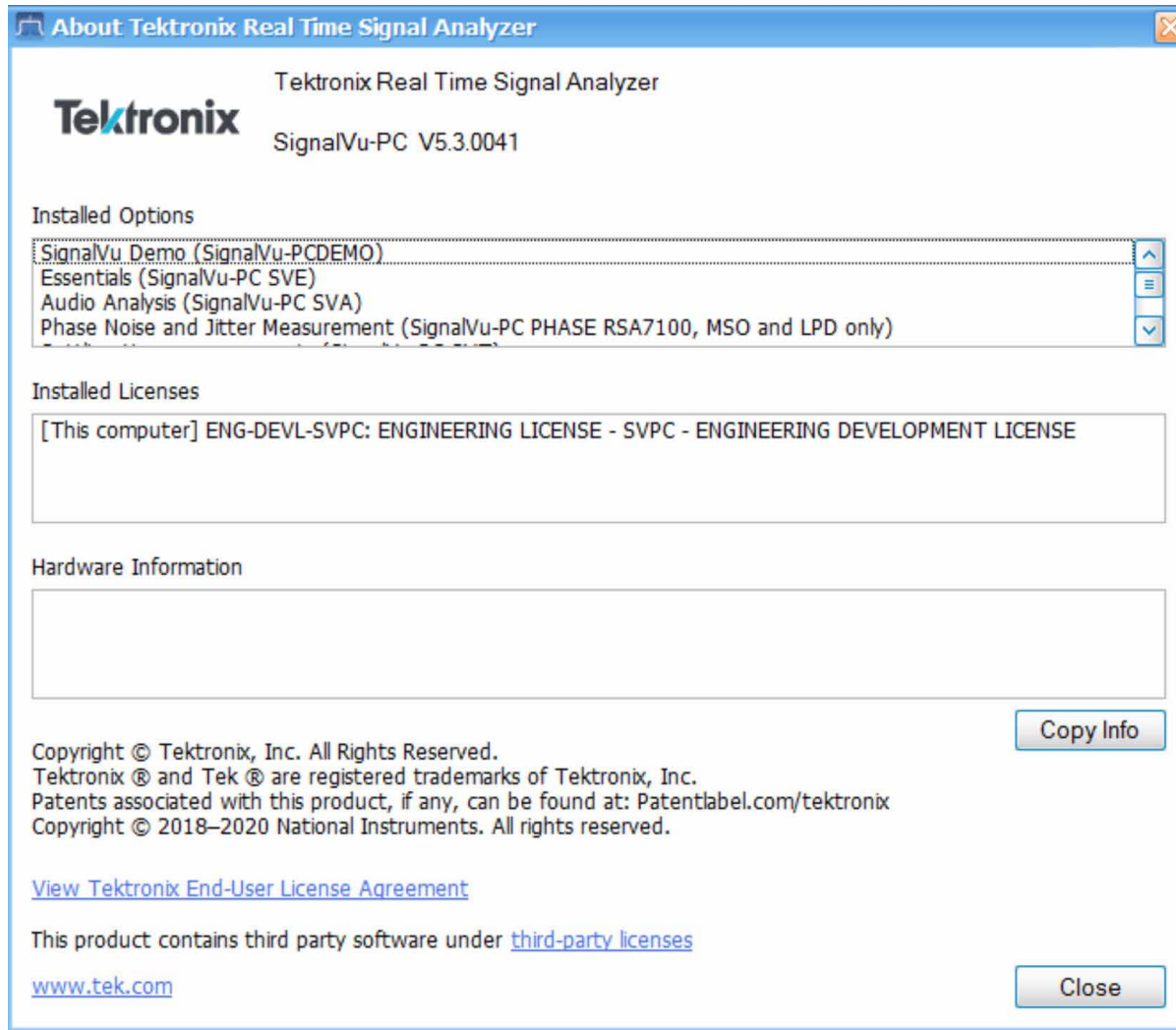

Version

At the top of the window is a line that displays the version of the SignalVu-PC software.

Installed Options

This text box lists the software options installed.

Hardware Information

This text box lists the serial number of the software and information about connected instruments.

Copy Info

The Copy Info button copies the information to the Windows clipboard, which you can then paste into a document. This information may be useful if you need to contact Tektronix about the software.

Mapping Measurements

The RSA Map software lets you record measurements on a geo-referenced map or a bitmap map for documentation purposes. If an external GPS receiver is connected to the analyzer, measurements can be mapped at the GPS coordinates where the measurement was taken. Using an external GPS receiver, RSA Map can perform repeat measurements using either time or distance to initiate measurements. RSA Map software can also save results for future reference or analysis.

To map measurements:

- Select Tools > RSA Map. This launches the RSAMap software in a separate window.

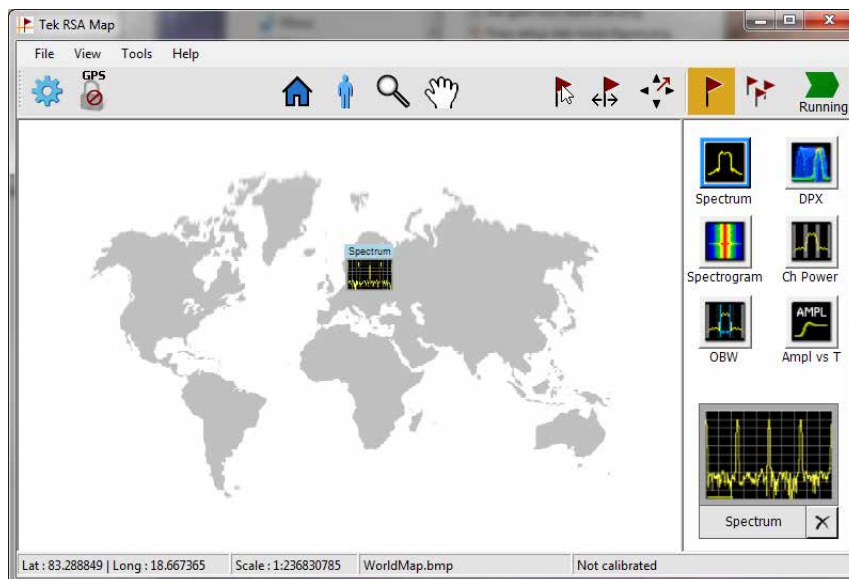

Full documentation on how to use RSA Map is provided in the RSA Map Help. In RSA Map, select **Help > User Manual**.

Main menu overview

The main menus are:

Menu	Description
	<p>The display icon indicates which display is currently active in the application. Right click on this icon to view the following drop-down menu. These options allow you to control the individual measurement window view.</p> 
Favorites bar toggle 	This icon allows you to toggle to hide or show the <i>Favorites bar</i> . The Favorites bar is located just below the Main Menu bar, is editable, and provides icons for quick and easy access to functions and menus.
File	Select measurements, open and save files, print documents, and preset.
View	Change display size, display the Marker toolbar and Status bar.
Run	<p>Start, stop and abort acquisitions, select single or continuous acquisition mode.</p> <p>Only available when connected to an RSA306, RSA306B, RSA500A series, RSA600A series, RSA7100 series spectrum analyzer, or an MSO4000B/C oscilloscopes.</p>
Replay	Replay measurements; select which record(s) to play, Replay/Stop/Pause, or enable continuous loop.
Markers	Search for signal peaks, center the display to a marker, and access the Define Marker panel.
Setup	Change settings for acquisition, analysis, and measurements.
Presets	Load and configure presets.
Tools	Perform searches and configure user preferences.
Connect	Connect and disconnect from instruments.
Window	Controls the size and layout of displays within the SignalVu-PC application.
Help Menu on page 860	Access the help and display information about the application software.

File Menu

Command	Description
Recall	The Recall dialog enables you to recall saved data, setups and traces.
Save	Saves a file without asking for a file parameters (based on most recent settings).
Save As	Displays the Save dialog enabling you to specify the parameters of the save operation.
Save on trigger	Displays the Actions tab of the Trigger control panel which allows you to configure the Save on Trigger function. This is only available when connected to an RSA306, RSA306B, RSA500A series, and RSA600A series or MDO4000B/C.
Acquisition save options	Displays the Save and Export tab of the Options control panel which allows you to specify how much data is saved in acquisition files.
Acquisition data info	Displays the Acquisition Info tab of the Replay control panel. The info on this tab describes such acquisition parameters as acquisition bandwidth, sampling rate, RF attenuation, and acquisition length.
Measurement Data Info	Displays the characteristics of the most recently analyzed record in the display.
Print	Prints the selected display.
Print Preview	Displays a preview of the print output.
Exit	Closes the SignalVu-PC application.

Recall

Main menu bar: **File > Recall**



Use the Recall command to load previously saved acquisition data, setups or trace data.

To Recall Data or Setups

1. Select **File > Recall**. This displays the **Open** dialog box.

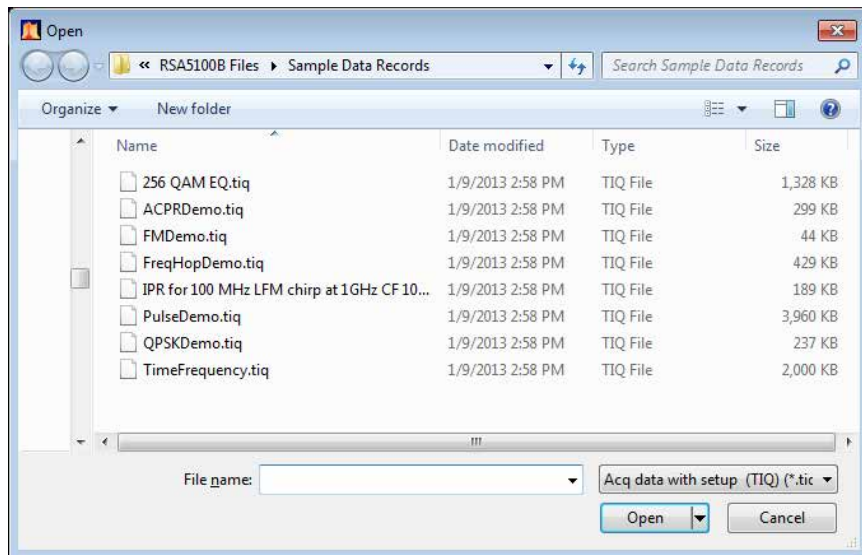

2. Select the file type to be recalled and click **Open**.

Save / Save As

Menu Bar: File > Save / Save As

Use Save / Save As to store acquisition data, setups, and traces. Save is also used to export traces, results and pictures of the display for use in other programs.

Difference Between Save and Save As

Use Save As to specify what kind of data you want to save and where the data should be saved. Use Save to quickly save the same data as you saved the last time you executed a Save, without having to specify the data type and location.

Save the data with their respective sources for MSO 5/6 Series/ LPD.

For example, suppose you want to save a picture of a spectrum trace each time you adjust a circuit to document how the adjustments affect the output of the circuit. The first time you want to save a picture of the display, you will need to select Save As. From the Save As dialog box, you specify the type of data you want to save (Picture of Selected Display) and specify the location of the saved file. As long as the [Save and Export option](#) is set to automatically name saved files, the next time you want to save a picture of the display, you can just press Save on the front panel and a picture of the selected display will be saved without requiring you to type a file name or the location of the file to be saved. Save data with respective sources for MSO 5/6 Series/ LPD.

What Data Types Can Be Saved

Data type	Description
Acquisition Data	Acquisition data previously recalled can be exported with different settings. Data is saved in a format readable only by SignalVu-PC, oscilloscopes running SignalVu software, or RSA6100/RSA5100/SPECMON Series instruments.
Setup	Configuration information detailing instrument settings. Data can be saved in a format readable only by SignalVu-PC, oscilloscopes running SignalVu software, or RSA6100/RSA5100/SPECMON Series instruments.

Table continued...

Data type	Description
Selected Trace	Saves the selected trace for later analysis by the analyzer. Data is saved in a format readable only by SignalVu-PC, oscilloscopes running SignalVu software, or RSA6100/RSA5100/SPECMON Series instruments.
Exported Traces and Numeric Results	Save traces and results in a file format that can be used by other programs.
Pictures of the Display	Save screen images in graphic image file formats that can be used in other programs.
Exported Acquisition Data	Save acquisition data records in a file format that can be used by other programs. Acquisition data can be saved in either comma-separated-variable format or MATLAB format.

[Data, Settings, and Picture File Formats.](#)

Options for Saving Pictures of the Display

Option	Setting	Description
Image Format	PNG	Saves exported screen captures in Portable Network Graphics format.
	JPG	Saves exported screen captures in Joint Photographic Experts Group (JPEG) format.
	BMP	Saves exported screen captures in Windows bitmap format.

Measurement Data Info

The Measurement Data Info command in the File menu displays a listing of acquisition-related information about the last data analyzed by the selected measurement with its respective source. The last data can be from the current acquisition or it could be from a recalled data file.

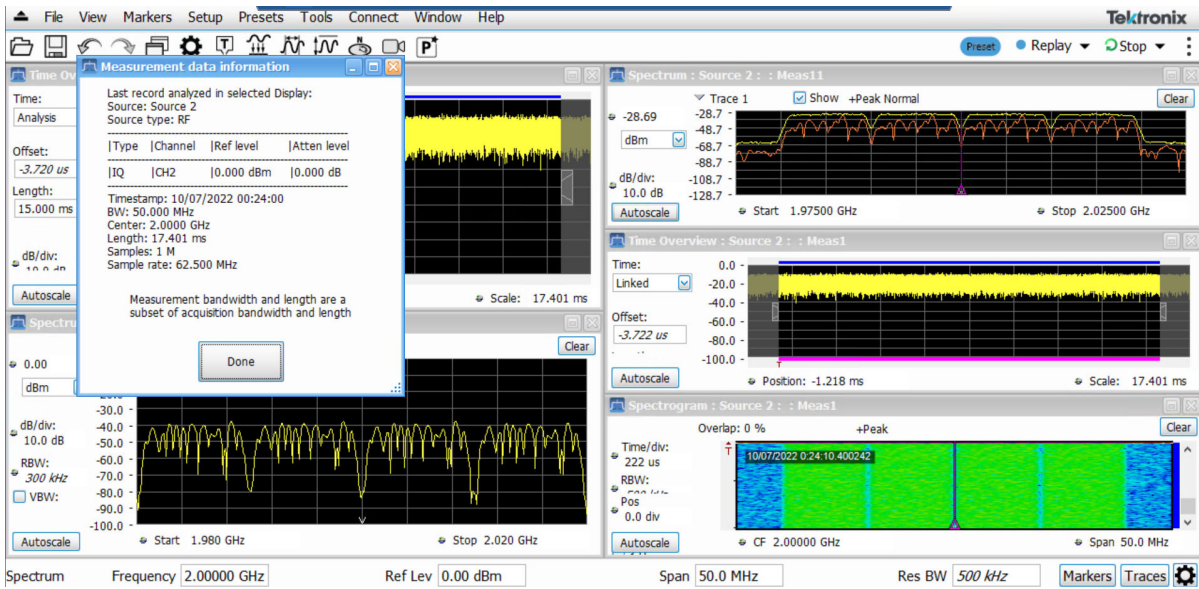
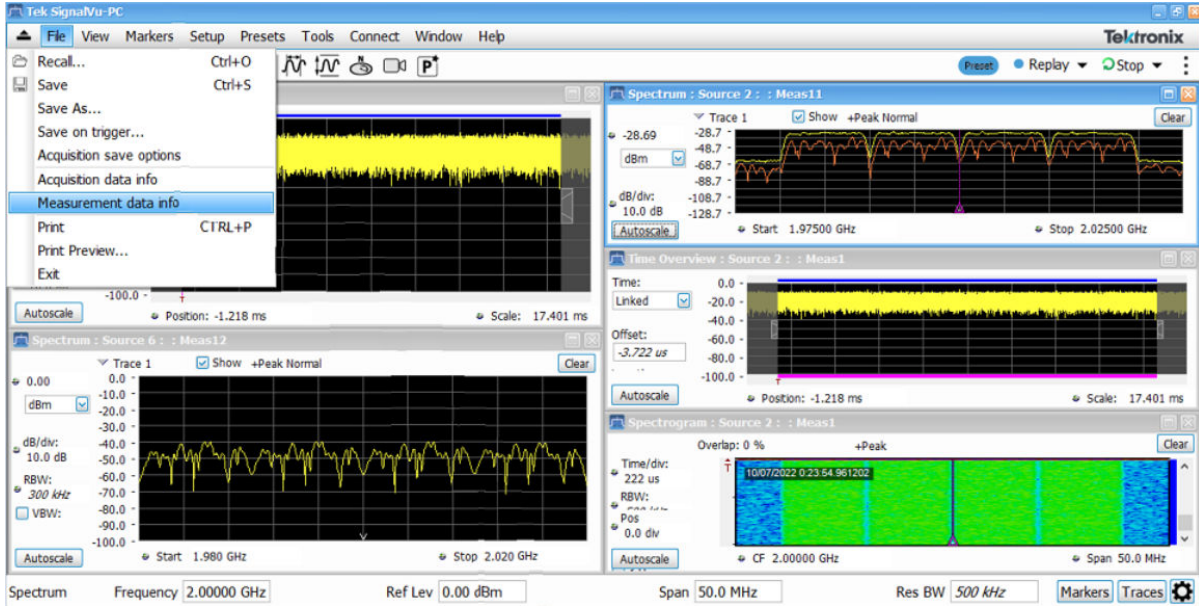

Acquisition Data

The Acquisition Data tab displays the sample rate and record length of the data received from the oscilloscope or from a recalled oscilloscope waveform file for that particular source.

Acquisition Data
Sample Rate: 3.125 GS/s
Record Length: 165.177 kSamples

Print

Menu Bar: File > Print

Print displays the Windows Print dialog box for printing a screen capture of the display. To save ink when printing, use the Colors tab to set the color scheme. See [Options Settings](#).

Print Preview

Menu Bar: File > Print Preview

Print Preview shows how a print out will appear when it is printed.

View Menu

The View menu enables you to control the display of views and toolbars in the application window.

Command	Description
Full Screen	Toggles all views between full-screen size and user-selected size.
Navigator View	<p>Selecting Navigator View adds the Time Overview display to the existing measurement displays to provide a better perspective of the signal.</p> <p>When the Navigator View is enabled, the Time Overview display is always located above any other measurement displays and uses the maximum horizontal resolution of the display area, regardless of the Window Tile setting.</p>

Table continued...



Command	Description
<p>Numeric Keypad</p>	<p>When selected, any time you place the cursor within a control or setting that takes a numeric value, you are presented with a dialog box to easily enter a value.</p> <p>For instance, placing the cursor in the Frequency setting, displays the following dialog screen.</p>  <p>Use the arrow buttons to change the value.</p> <p>Press the calculator icon to display a keypad that allows you to enter values and suffixes.</p>
<p>Chan Nav Toolbar</p>	<p>Check to view the Channel Navigation toolbar. Uncheck to hide it. Detailed information about this toolbar is available in the Channel Navigation toolbar topic.</p>
<p>Signal Survey Toolbar</p>	<p>Check to view the Signal Survey toolbar. Uncheck to hide it. Detailed information about this toolbar is available in the Signal Survey toolbar topic.</p>
<p>Map It Toolbar (Only available with optional MAP application license.)</p>	<p>Check to view the Signal Survey toolbar. Uncheck to hide it. Detailed information about this toolbar is available in the How to use Map It topic.</p>
<p>Replay Toolbar</p>	<p>Check to view the Replay toolbar. Uncheck to hide it.</p>
<p>Traces Toolbar</p>	<p>Check to view the Traces toolbar. Uncheck to hide it. This toolbar can also be accessed from the Basic Controls Toolbar. It allows quick access to the trace controls of the selected measurement display. This example is the Spectrum trace toolbar.</p> 
<p>Markers Toolbar</p>	<p>Check to view the Markers toolbar. Uncheck to hide it. This toolbar can also be accessed from the Basic Controls Toolbar. It enables you to define Markers and perform Peak searches. Click the Define button on the toolbar to define markers. See the Define Markers menu topic for detailed information.</p>

Table continued...

Command	Description
Basic Controls Toolbar	<p>The Basic Controls toolbar is defaulted to on and is located just above the Status Bar. It allows quick access to controls and settings of the selected measurement display. This example is the Spectrum Basic Controls toolbar.</p>  <p>It contains the following:</p> <ul style="list-style-type: none"> • Name of selected measurement window • Frequency: The center frequency in the active display. To change the value, click the text and enter a value with a keyboard or the numeric keypad. For fine adjustments, you can use the mouse wheel. • Reference: Reference level in the active display. To change the value, click the text and enter a value with a keyboard or the numeric keypad. • Span: The span in the active display. To change the value, click the text and enter a value with a keyboard or the numeric keypad. For fine adjustments, you can use the mouse wheel. • Res BW: The resolution bandwidth (RBW) in the active display. To change the value, click the text and enter a value with a keyboard or the numeric keypad. For fine adjustments, you can use the mouse wheel. • Show or hide the Markers toolbar • Show or hide the Traces toolbar • Show or hide the Settings Control Panel
Status Bar	The Status bar is defaulted to on and is located at the bottom of the application window.

Full Screen

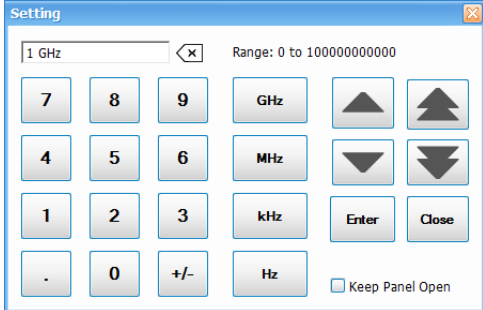
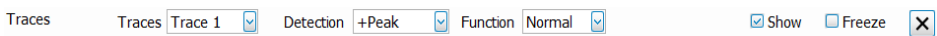
Menu Bar: View > Full Screen

When unchecked, clicking **Full Screen** resizes the application window to fill the screen. Full Screen mode maximizes the application window, and turns off the application title bar.



When checked, clicking **Full Screen** restores the application window to its previous size. The application title bar is restored.

Status Bar

The Status Bar displays information on specific instrument settings. It contains only status information; it does not display any error information. The Status bar has no controls. It cannot be hidden.



Elements of the Status Bar

Area within Bar	Description
Run status	Displays the running state. For example, some run states are Arm, Ready, Triggered, Analyzing, or Stopped.
Status message area	Displays status messages (for example, ADC Overage). When there are no status messages to report, displays current acquisition parameters (for example, Acq Length: 22.320 us).
Acquisition mode	Displays either Real Time or Swept. Indicates how the next acquisition will be acquired.
Trigger settings (Shows only when connected to an RSA)	Displays Trigger settings. For example, you will see Free Run, Power, Trig In (front), Frequency Mask and others.
Frequency Reference setting	Indicates whether the internal or external reference source is selected. Displays Ref: Int or Ref: Ext.
Attenuation settings (Shows only when connected to an RSA)	Displays the setting of the internal attenuator.
Preamp setting (Shows only when connected to an RSA)	If the optional preamp is installed, this indicates whether the preamp is on or off. If the preamp is on, displays Preamp: ON, 3 GHz max. as a reminder that the input frequency range is restricted when using the preamp.
TG (tracking generator) status (Shows only when connected to an RSA500 or RSA600 with Option 04 installed)	Indicates whether the tracking generator is on or off.
Battery status (Shows only when connected to an RSA500)	Shows a battery status icon when connected to an RSA500 instrument. See the Battery Status topic for details.
Connection status (Shows only when connected to a RSA or MDO)	<p> indicates a GNSS, 1PPS, or IRIG-B connection status (a green icon indicates locked and a yellow icon indicates unlocked).</p> <p> indicates the application is connected to an instrument;  indicates the application is not connected to an instrument.</p> <p>See the Connect menu topic for details.</p>

Run Status Indicators

Indicator	Description
Acquiring	SignalVu-PC is capturing the signal from a connected MDO series oscilloscope or RSA306, RSA306B, RSA500A series, RSA600A series, or RSA7100 spectrum analyzer.
Analyzing	SignalVu-PC is processing the signal record from a connected MDO series oscilloscope or an RSA306, RSA306B, RSA500A series, RSA600A series, or RSA7100 spectrum analyzer.
Replaying	SignalVu-PC is analyzing recalled waveform or acquisition records.
Stopped	If Stopped is displayed, no analysis being performed. This can occur because the Stop button has been pressed (when Replay is set to Loop) or because the software has just been launched and no analysis has been performed yet.
Triggered	If Triggered is displayed, the analyzer has recognized a valid trigger and is filling the posttrigger portion of the signal record.

Run Menu

(The Run menu is available only when connected to an RSA306, RSA306B, RSA500A series, RSA600A series, or RSA7100 series spectrum analyzer or an MDO instrument.)

The Run menu provides access to commands that control the signal acquisition.

Command	Description
<i>Run Single</i>	Sets the acquisition mode to Single and runs one measurement/acquisition cycle. If acquisition mode is already Single, selecting Run Single begins a new measurement/acquisition cycle. If acquisition mode is Continuous, selecting Run Single halts the current measurement/acquisition cycle after it completes.
<i>Run Continuous</i>	Sets the acquisition mode to Continuous and starts the measurement/acquisition cycle. If acquisition mode is already Continuous, selecting Run Continuous toggles the measurement/acquisition cycle between Run and Stop.
<i>Resume</i>	Restarts data acquisition, but does not reset accumulated results, such as Average or MaxHold. This allows you to stop acquisitions temporarily, then continue. If the accumulation is already complete, for example, 10 acquisitions or 10 averages have already been completed, each subsequent Resume command will cause one more acquisition to be taken, and its results added to the accumulation. Resume is not available if instrument settings have been changed.
<i>Abort</i>	Immediately halts the current measurement/acquisition cycle.

Replay Menu

The Replay Menu allows you to run measurements using the data in a recalled acquisition data file. You can use this to compute new results for old data after you change settings or measurements.

Markers Menu

The Markers menu provides to settings that define and control the location of markers.

Setting	Description
<i>Peak</i>	Moves the selected marker to the highest peak on the trace.
Next Peak >	Moves the selected marker to next peak depending on the setting chosen.
Marker to Center Frequency	Sets center frequency to the frequency of the selected marker.
<i>Define Markers</i>	Displays the Define Marker control panel.

Setup Menu

The Setup menu provides access to control panels that specify parameters for numerous signal analyzer functions.

Command	Description
<i>Displays</i>	Displays the Select Displays window.
<i>Settings</i>	Displays the Settings control panel for the selected display.
<i>Trigger</i> (Available when connected to an RSA306, RSA306B, RSA500A series, RSA600A series, RSA7100, or MDO4000B/C)	Displays the Trigger control panel.
<i>Acquire</i>	Displays the Acquire control panel.
<i>Analysis</i>	Displays the Analysis control panel.
<i>Amplitude</i>	Displays the Amplitude control panel.
<i>GNSS/Antenna</i>	Displays the GNSS/Antenna control panel.
<i>Audio</i> (Available when connected to an RSA306, RSA306B, RSA500A series, or RSA600A series)	Displays the Audio demodulation control panel.
<i>Recording</i>	Displays the Recording control panel, providing access to record file and playback file functions.

Table continued...

Command	Description
Configure In/Out and IQ Streaming	Displays the IQ Streaming control panel. This panel provides access to some IQ streaming features, allowing you to stream IQ data using API, 40 GbE Ethernet,, and LVDS.

Presets Menu

The Presets menu provides you access to instrument presets and preset options. Source1 is set default for MSO's and LPD's

Command	Description
Main	Resets the instrument to factory defaults. Acquisition data and settings that have not been saved will be lost.
DPX	Recalls the DPX presets.
Standard Presets	Recalls the Standards presets.
Application	Recalls the Application presets.
User (Favorites)	Recalls the User (Favorites) presets.
Preset Options	Displays a control panel where you can configure options for Presets.

Tools Menu

Provides access to several utilities for controlling instrument functions.

Command	Description
Mask Test	Enables you to locate and highlight specified signal levels in specified displays.
Alignments	Runs an alignment. If the analyzer is already aligned and you select Align Now, nothing will appear to happen because it is already aligned.
Licenses	Used to activate SignalVu-PC optional application licenses (options).
Licenses > Legacy > Manage...	Used to activate a demo license or deactivate a license (used to move the license between PCs).
Options	Displays the Options control panel.
Signal Database	Allows you to select which signal standards and types are listed (and selectable) in the Channel Navigation toolbar and/or the Define Survey control panel.
RSAMap	Launches the optional MAP application.

Table continued...

Command	Description
Battery Status	Provides battery status information if a RSA500 series instrument is connected.

Alignments

Menu Bar: Tools > Alignments

When SignalVu-PC is connected to an RSA300 series, RSA500 series, RSA600 series, or RSA7100, this menu option is available. The analyzer can adjust itself, optimizing the internal signal path used to acquire the signal you measure. Alignment optimizes the analyzer to take more accurate measurements based on the ambient temperature. The Alignments dialog enables you to specify when alignments occur, either automatically or only when manually initiated.

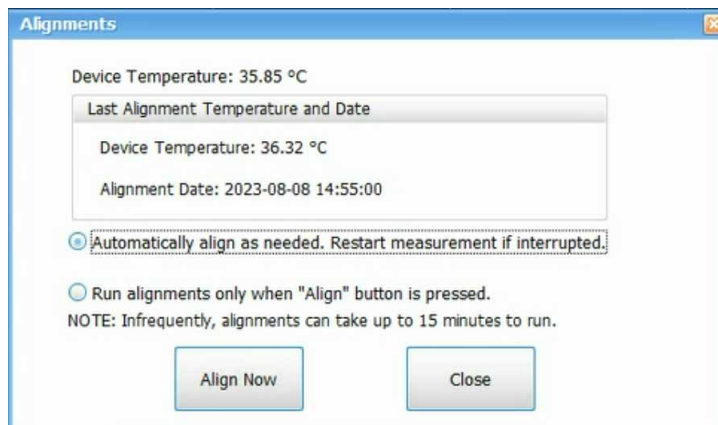
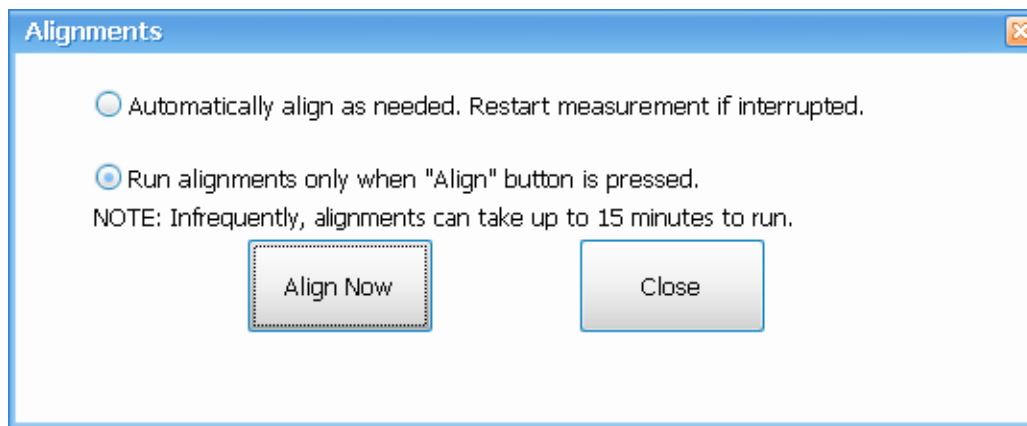

Note: You can see the current device temperature, the last alignment temperature, date, and time of last alignment in RSA7100.



Note: Acquisition must be started before attempting alignment.



Tip: Running an alignment during the warm-up period may result in a failed alignment. If this occurs, wait for the complete warm-up period of 30 minutes before performing an alignment.

Elements of the Alignments Dialog

Setting	Description
Automatically align as needed	Specifies that alignments run as ambient conditions require.
Run alignments only when Align Now button is pressed.	Specifies that alignments will never run unless manually initiated.
Align Now	Use to manually initiate an alignment. If the instrument is already aligned and you click the Align Now button, nothing will appear to happen. This is not an error of failure, but means that the instrument is already aligned the specified temperature range.
Close	Closes the Alignments dialog box.

Battery Status tab

Menu Bar: Tools > Battery Status

The Battery Status option in the Tools menu is only visible if you have an RSA500 series instrument connected. It opens the Battery Status tab. This tab displays the following details about the instrument's battery.







Item	Description
State	Shows the battery state as one of the following, along with the corresponding icon.
	<p>AC Present, No Battery</p> <p>A battery icon with a red circle and line through it indicates that no battery is detected and that power is being supplied through the power cord.</p>
	<p>Fully Discharged</p> <p>An empty battery icon indicates the battery is 0% charged.</p>
	<p>In Use</p> <p>A green battery icon with varying degrees of fill indicates the battery is in use and at the following % charged: 20%, 30%, 40%, 50%, 60%, 70%, 80%, 90%, 100%</p>
	<p>In Use</p> <p>A red battery icon with varying degrees of fill indicates the charge is getting critically low and you should charge the battery. This icon appears at the following % charged: 5%, 10%</p>

Table continued...

Item	Description
	<p>AC Present, Charging</p> <p>A green battery with a lightening bolt icon indicates that power is being supplied through the power cord and that the battery is charging.</p>
	<p>AC Present, Charged</p> <p>A green battery with a plug icon indicates power is being supplied through the power cord and that the battery is fully charged.</p>
Charge	Shows the current state of the battery charge status in %.
Manufactured	Shows the battery manufactured date.
Serial number	Shows the battery serial number.
Charge cycles	Shows how many charge cycles the battery has had.
Temperature	<p>Shows the current temperature of the battery.</p> <p>The internal charging circuit monitors the internal battery temperature. Normal charging is allowed when the battery temperature is between 0° C and 46° C. If the battery temperature falls outside of this range, charging will be suspended. Battery charging may resume once the battery temperature falls within this range.</p>



Tip: The battery will charge at a faster rate when the instrument is turned off. Charging the battery while the instrument is running will require a longer time to reach a full charge.



Connect menu

Connect allows you to connect your PC (with SignalVu-PC installed) to the following instruments:

- MDO4000B/C Series instruments using USB, wireless, or LAN (SignalVu-PC with option CON required)
- RSA306, RSA306B, RSA500A Series, and RSA600A Series using USB
- RSA7100 using PCIe
- 5 Series/6 Series/6 Series B MSO
- LPD

By connecting to one of these instruments, you are able to view and analyze waveforms in real time using the SignalVu-PC software.

Elements of the Connect Menu

Menu item	Description
Search for instruments	<p>An RSA306, RSA306B, RSA500A series, and RSA600A series connected via USB is automatically recognized by the software and automatically establishes a connection, so you do not need to search for the instrument.</p> <p>When connecting to an MDO4000B/C series instrument, use this menu to activate TekVISA to search for MDO4000B/C instruments that are connected by USB or through a LAN network.</p> <p>This menu is disabled if a connection to an instrument has been established.</p>
Connect to instrument	<p>Select to view a list of currently connected instruments or to manually look for an instrument.</p> <p>This menu is disabled if a connection to an instrument has been established.</p> <p>When tried to connect to MSO/LPD, without CON license you will see connection error message as shown.</p>  <p>The screenshot shows a 'Connection Error' dialog box with a red 'X' icon. The text inside reads: 'The required CON license is not detected. Please ensure you have the CON license installed to connect to the instrument. For installation instructions or to obtain a license, please refer to the user manual or contact technical support.' There is an 'OK' button at the bottom.</p>
Manually look for LAN instrument	<p>Select to open a dialog window that allows you to enter the IP address of an instrument to connect to.</p> <p>When tried to connect to MSO/LPD, without CON license you will see connection error message as shown.</p>  <p>The screenshot shows a 'Connection Error' dialog box with a red 'X' icon. The text inside reads: 'The required CON license is not detected. Please ensure you have the CON license installed to connect to the instrument. For installation instructions or to obtain a license, please refer to the user manual or contact technical support.' There is an 'OK' button at the bottom.</p>
Disconnect from instrument	<p>Select to disconnect from the currently connected instrument. This is only available when you are connected to an instrument.</p>

Window menu

Use the Window menu to arrange how windows are displayed. Displays can be set to appear full screen (one display at a time) or with all (selected) displays visible at once. When all displays are visible at once, you can rearrange the displays by dragging the title bar of a window (deselect Window > Lock Windows to move displays around).

Command	Description
Close View	Closes the selected view.
Cascade	Positions windows in a cascade view (not available when Lock Windows is selected).
Tile Horizontally	Positions widows in a horizontal orientation (top to bottom).

Table continued...

Command	Description
Tile Vertically	Positions widows in a vertical orientation (side by side).
Lock Windows	Locks the windows into their current position, preventing them from being moved. If the windows are locked, the Cascade arrangement is not selectable.
Group by Source	When selected, all the open displays get arranged based on the source of the display. Available when Lock windows is enabled.
Group by measurement	When selected, all the open displays get arranged based on the name of the display. Available when Lock Windows is enabled.
(List of windows)	A numbered list of open windows.

Help Menu

The Help menu provides access to the Help and version information about the vector signal analysis software

Command	Description
User Manual	Displays a navigable, searchable Help tool.
User Manual (PDF)	Displays a PDF version of the Help.
Application Reference (PDF)	Displays a PDF version of the vector analysis software application Reference Manual.
Quick Start Manual (PDF)	Displays a PDF version of the vector analysis software application Quick Start User Manual.
PI Command Search	Displays a navigable, searchable PI command search tool.
About Tektronix Real Time Signal Analyzer Software	Displays information about the vector analysis software application and installed options.

PI Command Search tool

The PI Command search tool allows you to search for programming commands by typing the syntax or key words into the search text box.

For a quick search, do the following:

1. Select the **Search** tab from the dialog box.
2. Type in the syntax or key word you are looking for in the text box.
3. Click on **List Topics**.

TO obtain an updated version of the PI commands manual, do the following:

1. Download the latest PI manual .CHM file from www.Tek.com/downloads.
2. Copy the downloaded *PICommandSearch.chm* file into the installer path *C:\Program Files\Tektronix\SignalVu-PC\RSA*.



CAUTION: Do not change the file name PCommandSearch.chm or the file will not be found by the application.

Favorites bar menus

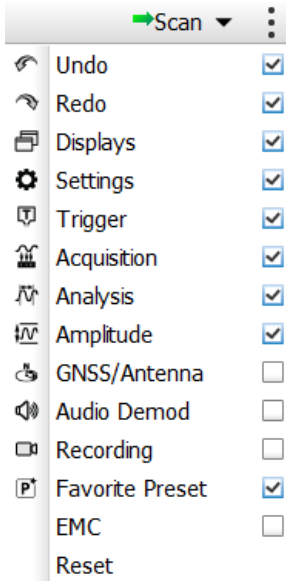

Menu	Description
Icons	The icons on the Favorites bar are detailed in the Elements of the Display on page 39 topic.
Preset	Recalls the Main preset.
Replay	Replay measurements; select which record(s) to play, Replay/Stop/Pause, or enable continuous loop.
Run	Start, stop and abort acquisitions, select single or continuous acquisition mode. Only available when connected to an RSA306, RSA306B, RSA500A series, RSA600A series, RSA7100 spectrum analyzer or an MSO4000B/C oscilloscope.
⋮	<p>Click this icon to view the Edit Favorites menu:</p>  <p>(Audio demodulation icon is not available when connected to the RSA7100.)</p>

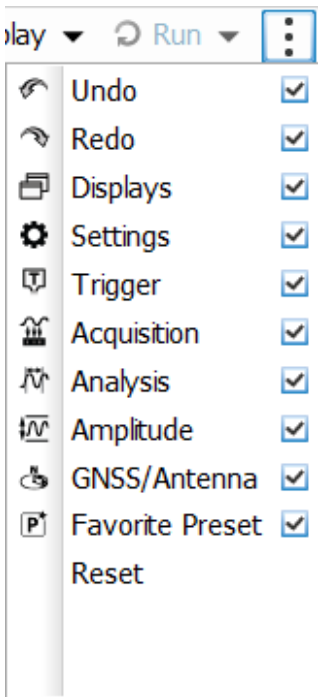
Menu	Description
Icons	The icons on the Favorites bar are detailed in the Elements of the Display on page 39 topic.
Preset	Recalls the Main preset.
Replay	Replay measurements; select which record(s) to play, Replay/Stop/Pause, or enable continuous loop.
Run	Start, stop and abort acquisitions, select single or continuous acquisition mode.
⋮	Click this icon to view the Edit Favorites menu: 

Error and Information Messages

The following list describes some of the common error and information messages that might appear during instrument operation. Messages that apply specifically to one or more measurements appear in the displays. Messages that pertain globally, such as those about hardware status, are shown in the Status Bar at the bottom of the analyzer application window.

Acq BW too small for current setup

The display needs a wider acquisition bandwidth than what the current data record contains. This can be due to any of the following reasons:

- The sampling parameters are being manually controlled.

In the Acquire control panel > Sampling Parameters tab, set the Adjust control to All Auto to allow the software to pick the sample rate and record length that it needs.

- A display other than the one you intended has been selected. The selected display has requested a smaller acquisition bandwidth to achieve a better accuracy or dynamic range for its particular measurement.

Select the display that contains the message. Click Run if the instrument is not already acquiring data.

- Acquisitions are not running and the measurement now requests a wider bandwidth than the last acquisition.

Click Run to perform a new acquisition with a wider bandwidth.

- The data is from a recalled TIQ file.

There is no way to increase the acquisition bandwidth for saved IQ data. You must adjust the measurement settings so that less bandwidth is required.

Analysis failure: <description of error>

The instrument is unable to complete a measurement due to difficulty in characterizing the signal. For example, due to either the signal or settings, the instrument may not be able to recognize a pulse so it can compute the pulse measurements.

- Try changing settings to improve analysis. For example, when Pulse Trace is displayed, try changing the settings on the Settings > Params.

Analysis failure: Carrier detection failed

The instrument was unable to locate a carrier signal. Try adjusting the Carrier Threshold or Integration BW values, if the measurement has these controls.

Analysis Length was limited

This message appears if the "Results Length", the time over which the measurement computed its results, is less than the Actual Analysis Length reported in the Analysis Time control panel tab and the Time Overview display. The Results Length is indicated by the magenta line below the Time Overview graph. This can occur because the acquisition contained more data samples than a measurement can process (for example, digital demodulation is limited to 80,000 samples) or the measurement had to use some of the first and last samples for pre-measurement processes.

Analysis length too small for current setup

Increase the Analysis Length or decrease the RBW (Spectrum, ACPR, MCPR).

Avg Tx not available in Volts units

The Average Transmitted Power measurement is not defined for Volts.

Can't get acquisition data record

No acquisition record currently exists in memory (run an acquisition or recall a file), or an error has occurred. Repeat the acquisition.

Can't replay data from swept acq

The measurement could not produce results because it is a real-time only measurement but was asked to reanalyze (Replay) an acquisition taken in swept mode.

Can't replay. Live data needed for swept settings

The measurement could not produce results because it was asked to reanalyze (Replay) the acquisition but it is in Swept acquisition mode. Swept-mode measurements cannot analyze recalled data.

CISPR accuracy limited by acq memory. Adjust RBW or freq range

The CISPR function was applied, but the available data did not represent a long enough time to satisfy CISPR requirements. Increasing RBW reduces the amount of time needed for analysis. Reducing frequency range (for example, by reducing Span), decreases sample rate, allowing the available memory to cover a longer time period.

If this data is from a saved file, this error cannot be cleared.

This data was acquired when the input signal contained peaks greater than 6 dB above the Reference Level setting.

If the data is from a file, this error cannot be cleared.

Data from warm-up period

This data was acquired while the analyzer was warming up. The warm-up period is 30 minutes. Until this warm-up period is completed, the analyzer is considered uncalibrated.

Disabled: data is from swept acquisition

The display needs to run in real-time mode. The display associated with this message cannot run now because it is not the selected display, and the selected display is performing multiple acquisitions (it is in swept mode).

- Change the settings of the selected display so it is performing real-time acquisitions.
- Select the associated display to make it the selected display. When it is selected, it will force the acquisition parameters to change to meet its own needs.

Frequency exceeds preamp range

This is a warning that signals below the minimum preamp operating frequency are likely to be severely attenuated (this is 100 kHz for option 51, 1 MHz for option 50).

Needs swept acq or larger AcqBW - Acquire data while display is selected

The display is not running because it needs to perform multiple acquisitions (it must be in swept mode) but it is not the selected display. Only the selected display can perform multiple acquisitions.

- Select the display showing this message to give it control of acquisitions parameters.

Sometimes, only one display can work and the others will be blank and show errors. This happens when different displays have conflicting demands on the acquisition data record.

Export failure: file not saved

An error occurred while exporting Results. The file was not created.

- Export the results again.

Export failure: unable to open results file for export. File not saved.

The Export Results file could not be opened for writing, so the export of results was not completed.

- Verify that there is sufficient free space on hard disk.

Insufficient data for CISPR. Acquire while display is selected

This message appears when a measurement is not the selected measurement and CISPR filters are selected. Set the measurement to be the selected measurement and reacquire the signal.

IQ Processing Error: 8012

This message occurs in GP Digital Modulation displays. The most likely cause for this message is that there are not enough symbols to analyze. This can happen if:

- The Analysis Length is set too short. Increase the Analysis Length on the Analysis Time tab.
- The Analysis Offset has pushed the Analysis Time so far out that the actual Analysis Length is too short, even though the user-requested Analysis Length would have been long enough without the excessive offset. Decrease the Analysis Offset on the Analysis Time tab.
- The input signal is bursted, and the burst does not contain enough symbols.

Needs swept acq or larger Acq BW - Acquire data while display is selected

The display has one of two problems: It is not the selected display, which prevents it from controlling the hardware acquisition parameters, and setting the acquisition mode to Swept; or its settings require a wider data bandwidth.

- Select the display that you are interested in and it will change the acquisition to meet its own needs.

- Increase the acquisition bandwidth manually or by changing the selected display's settings to cause the wider bandwidth.

No Math trace: unmatched trace lengths

A math trace could not be produced because the traces selected to generate the math trace do not have the same number of points. This can easily happen if both traces are recalled, but were saved under different "Points" settings. This can also occur if one of the selected traces is a live trace and the other trace is a recalled trace.

- In a Spectrum display, as long as one trace is live, you can change the "Points" setting (Setup > Settings > Freq & Span tab) to match the recalled trace.
- If you are using two recalled traces to generate the Math trace. You must recreate at least one of the traces.

No burst detected

The Burst Detection Mode is On, but no burst was detected in the signal.

- Check that the Threshold setting is properly set.

Not enough samples for current setup

The measurement was not able to run because the combination of analysis length, offset, and measurement bandwidth relative to acquisition bandwidth, were such that not enough samples were available for the measurement to analyze. This can occur when two or more displays are shown and one display requires a wide acquisition bandwidth and another display requires a much narrower bandwidth. The display requiring the much narrower bandwidth must decimate and filter the acquisition record which can result in too few samples left for the measurement.

- Increase the Analysis Length to provide more samples.
- Close any displays you don't currently need.

Not enough samples – try increasing MeasBW

The measurement was not able to run because there are not enough samples available for the measurement to analyze. The Settling Time measurement requires at least 256 samples. This can occur when two or more displays are shown and one display requires a wide acquisition bandwidth and another display requires a much narrower bandwidth. The display requiring the much narrower bandwidth must decimate and filter the acquisition record which can result in too few samples left for the measurement.

- Increase the Analysis Length to provide more samples.
- Close any displays you don't currently need.

No FFT (not all pulses have results)

If a pulse cannot be measured (because its shape is too indistinct or it does not meet the parameters that define a pulse), its results will be "- -" for every measurement on that pulse. The instrument cannot compute an FFT.

No pulses found

The instrument was unable to find any complete pulses in the signal.

- Make sure the analysis length includes at least one complete pulse cycle, from before one rising edge until after the next rising edge.

Pulse Detection Error

The instrument was unable to detect a pulse.

- The pulse Measurement Filter needs to be smaller. Try reducing the bandwidth and/or selecting the Gaussian filter.
- Detection threshold is not set to the proper level for the signal. Adjust the Power threshold to detect pulses.
- The pulse interval is too long for the current settings. Try decreasing the filter bandwidth, as this may reduce the number of data points to a manageable quantity.

RBW conflict. Increase Span or Analysis Length

The measurement is not running because the actual RBW used by the measurement is too large for the current acquisition span. Typically, the analysis length is too short as well.

- Either increase the span or increase the Analysis Length.

RBW decreased

The current span or acquisition bandwidth is too small to allow a wider RBW filter.

- Increase the span or acquisition bandwidth if the decreased RBW is not acceptable.

RBW increased

The current Spectrum Length (or Analysis Length if Spectrum Length is not Independent) is too small to allow the requested RBW.

- Increase the Spectrum Length (or Analysis Length) if the increased RBW is not acceptable.

RBW limited by AcqBW to: XX Hz

The requested RBW is too close to the acquisition BW. Increase the frequency range of the measurement (for example, Span).

RBW too small/large for current Acq BW

If the RBW is set manually, it is possible for the acquisition bandwidth to be incompatible with the RBW setting.

- Change the RBW setting.
- Adjust the Acq BW setting, either directly (Setup > Acquire > Sampling Params: select on of the manual modes) or by adjusting the measurement bandwidth of the selected display (Setup > Acquire > Sampling Params: All Auto).

Recall error: Setup not completely restored

An error occurred while recalling a Setup file. Thus, the current setup may be a combination of settings from the Setup file and the previous Setup.

- Recall the setup again.

Recall failure: problem with file or file contents

An error occurred while recalling a Setup, Trace or Data file. This can occur because of a problem opening the file (operating system error) or because of a problem with the contents of the file.

- Recall the file again.

Restoring acquisition data

This is a status message displayed while data is being restored from a file.

Save failure: file not saved

An error occurred while saving a Setup or Data file.

- Save the file again.

Saving acquisition data

This is a status message displayed while data is being saved to a file.

Selected VBW does not use full Spectrum Length

This message can occur when the Spectrum Length is greater than required for the VBW filter. If you look at the Time Overview display, the Magenta line for Results Length indicates the part of the Spectrum Length that was actually used. The measurement results are correct, but don't include some of the data in the selected Spectrum Length. To clear this message, you can set the Spectrum Length to Auto.

Setup error: <description of error>

When this message appears, it includes text that explains the problem. For example, the ACPR display might show: "Setup error: channels can't overlap". Setup errors are the result of conflicts in instrument settings. These types of errors occur when a user makes manual changes to settings. In the example above, the channel settings in the Channel Power and ACPR display have been set so that the channels overlap in frequency.

- Adjust the instrument settings, or change a setting back to Auto, to eliminate the error.

Setup error: Integration BW exceeds Measurement BW

When this message appears, it includes text that explains the problem. Setup errors are the result of conflicts in instrument settings. These types of errors occur when a user makes manual changes to settings.

- Adjust the instrument settings, or change a setting back to Auto, to eliminate the error.

Setup error: Measurement time for Freq & Phase results

The Measurement time for Freq & Phase results specifies how far across the pulse top the instrument should wait before measuring the Phase Difference and Frequency Difference for each pulse. If this value is set too large for any of the pulses in the signal, the measurement point ends up on the falling edge or during the pulse off time.

- Decrease the Measurement time for Freq & Phase results setting (Settings > Define tab).

Unexpected software error. Please cycle power and try again. If the problem persists, contact your Tektronix Service Center.

An unrecoverable error has occurred, and the instrument application software will shut down.

- Relaunch the SignalVu-PC application.

VBW not applied - Acq BW too small

Increase VBW or measurement bandwidth. Make sure Sampling Parameters are set to Auto.

VBW not applied - Spectrum Length too short

This message occurs when the requested VBW can't be produced because the Spectrum Length is too short.

To clear this problem, set the Spectrum Length to Auto or manually increase the Spectrum Length (see Setup > Analysis > Spectrum Time tab). If Spectrum Length is coupled to Analysis Length, set Analysis Length to Auto or manually increase it (see Setup > Analysis > Analysis Time tab).

Displaying the Windows Event Viewer

When the analyzer generates an error message, information about the error is logged to the Windows Event Viewer.

To display the Windows Event Viewer:

1. Select Start > Control Panel.
2. Select Administrative Tools. (If your instrument displays control panels in Category View, select System and Security, and then select Administrative Tools.)
3. Double-click **Event Viewer**.
4. From the Event Viewer window, select **Windows Logs**, then select **Application**. This displays a list of all errors that have been reported to the operating system from applications.

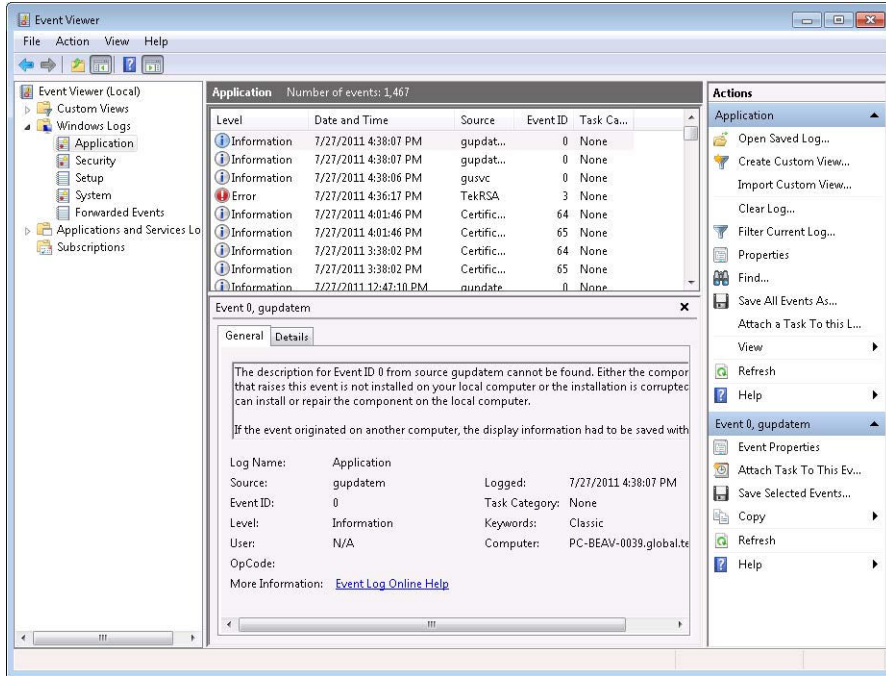

Errors reported to the Event Viewer from the analyzer application appear under Source as TekRSA.

- Double-click the last error reported for TekRSA to see details on the most recently reported error. Please note that many items reported as “errors” are simply informational and do not mean that your instrument is impaired. Contact the Tektronix Customer Support Center or Service Center if you are concerned about an error shown in the Event Viewer. Do not send an instrument out for repair based solely on these event reports.

How to Find Out if Software Upgrades are Available

Software upgrades might be available can be downloaded from the Tektronix Web site. To see if a software upgrade is available for your product, use your browser to go to www.tektronix.com/software. Search by the product model number.

To add additional software options or features, you will need an option key from Tektronix. In some instances, you may need to upgrade the product software before adding the new option key. Follow the installation instructions provided with your software option.

Settings

Main menu bar: Setup > Settings 

The Settings menu item enables access to control panels that allow you to change settings for the selected display. The control panel that appears when you select **Settings** depends on the selected display. The Settings control panel for the Spectrum display is shown in the following figure.

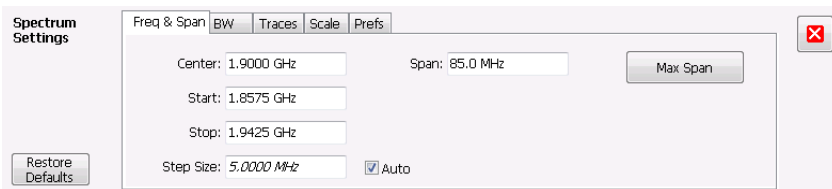

The control panel for the CCDF display is shown in the following figure.

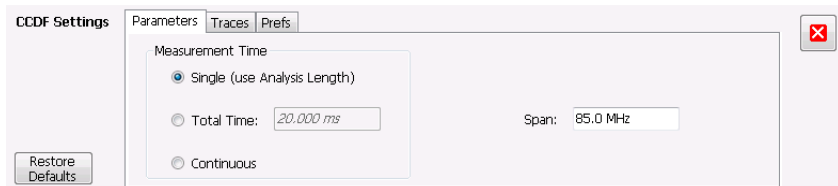

Settings Control Panels

[AM Settings](#) on page 145

[FM Settings](#) on page 151

[PM Settings](#) on page 157

[Channel Power and ACPR Settings](#) on page 166

[Signal Strength Settings](#) on page 169

[MCPR Settings](#) on page 176

[Occupied BW & x dB BW Settings](#) on page 183

[Spurious display settings](#) on page 189

[CCDF Settings](#) on page 196

[Phase Noise Settings](#) on page 201

[Settling Time Settings](#) on page 214

[Common Controls Settling Time Displays Shared Measurement Settings](#) on page 215

[Spectrum Emission Mask Settings](#) on page 224

[Common Controls RF Measurements Shared Measurement Settings](#) on page 230

[Transmission Gain Display Settings](#) on page 240

[Cable Loss Display Settings](#) on page 267

[RL/DTF Display Settings](#) on page 271

[WLAN Channel Response Settings](#) on page 282

[WLAN Constellation Settings](#) on page 284

[WLAN EVM Settings](#) on page 286

[WLAN Magnitude Error Settings](#) on page 288

[WLAN Phase Error Settings](#) on page 290

[WLAN Power vs Time Settings](#) on page 293

[WLAN Spectral Flatness Settings](#) on page 295

[WLAN Summary Settings](#) on page 298

[802.11ad/11ay Control Panel Settings](#) on page 326

[OFDM Channel Response Settings](#) on page 338

[OFDM Constellation Settings](#) on page 339

[OFDM EVM Settings](#) on page 341

[OFDM Spectral Flatness Settings](#) on page 342

[OFDM Magnitude Error Settings](#) on page 344
[OFDM Phase Error Settings](#) on page 345
[OFDM Power Settings](#) on page 347
[OFDM Summary Settings](#) on page 348
[OFDM Symbol Table Settings](#) on page 350
[OFDM Analysis Shared Measurement Settings](#) on page 350
[Cumulative Histogram display settings](#) on page 362
[Cumulative Statistics Table display settings](#) on page 367
[Pulse-Ogram display settings](#) on page 369
[Pulse Table display settings](#) on page 371
[Pulse Trace display settings](#) on page 373
[Pulse Statistics settings](#) on page 379
[Pulsed RF measurement settings](#) on page 380
[EMC-EMI settings](#) on page 452
[P25 Constellation Settings](#) on page 493
[P25 Eye Diagram Settings](#) on page 495
[P25 Power vs Time Settings](#) on page 498
[P25 Summary Settings](#) on page 501
[P25 Symbol Table Settings](#) on page 503
[P25 Frequency Dev Vs Time Settings](#) on page 506
[LTE ACLR Settings](#) on page 530
[LTE Channel Spectrum Settings](#) on page 533
[LTE Constellation Settings](#) on page 534
[LTE Power vs Time Settings](#) on page 537
[LTE Analysis Measurement Settings](#) on page 537
[NR Adjacent Channel Power Display Settings](#) on page 565
[NR Analysis Measurement Settings](#) on page 581
[NR Channel Power Display Settings](#) on page 566
[NR Constellation Display Settings](#) on page 568
[NR Spectral Emission Mask Display Settings](#) on page 570
[NR Summary Display Settings](#) on page 580
[BT Constellation Settings](#) on page 615
[BT Eye Diagram Settings](#) on page 617
[BT CF Offset and Drift Settings](#) on page 620
[BT Summary Settings](#) on page 624
[BT Symbol Table Settings](#) on page 628

[BT Frequency Dev Vs Time Settings](#) on page 631

[BT 20dB BW settings](#) on page 634

[Bluetooth Analysis Measurement Settings](#) on page 636

[Audio Spectrum Settings](#) on page 650

[Audio Summary Settings](#) on page 652

[Audio Analysis Measurement Settings](#) on page 652

[Constellation Settings](#) on page 664

[Demod I & Q vs Time Settings](#) on page 667

[EVM vs Time Settings](#) on page 669

[Eye Diagram Settings](#) on page 672

[Frequency Deviation vs Time Settings](#) on page 675

[Magnitude Error vs Time Settings](#) on page 678

[Phase Error vs. Time Settings](#) on page 680

[Signal Quality Settings](#) on page 686

[Symbol Table Settings](#) on page 688

[Trellis Diagram Settings](#) on page 691

[GP Digital Modulation Shared Measurement Settings](#) on page 692

[Mask Test Settings](#) on page 730

[Analysis Settings](#) on page 737

[Amplitude Settings](#) on page 749

Glossary

Accuracy

The closeness of the indicated value to the true value.

ACLR

Adjacent Channel Leakage power Ratio is the ratio of the RRC (Root Raised Cosine) filtered mean power centered on the assigned channel frequency to the RRC filtered mean power centered on an adjacent frequency (defined in 3GPP).

ACPR Measurement

Adjacent Channel Power Ratio (ACPR) is the ratio of the mean power centered on the assigned channel frequency to the mean power centered on an adjacent channel frequency. In the 3GPP specification, it is called ACLR (Adjacent Channel Level Ratio) and both the main channel and adjacent channels are required to be filtered with RRC (Root Raised Cosine) filters.

Acquisition

A series of time-contiguous frames. This is also called a Block.

Analysis Length

The length of time in the Analysis Time.

Analysis Time

The portion of the acquisition record over which one or more measurements are calculated.

ASK

Acronym for Amplitude Shift Keying. The process, or result of a process, in which the amplitude of the carrier is varied in accordance with the state of a digital input signal.

Block

An integer number of time-contiguous frames. See also: Acquisition.

Calibrator

A signal generator producing a specified output used for calibration purposes.

Carrier

The RF signal upon which modulation resides.

Carrier Frequency

The frequency of the CW component of the carrier signal.

Carrier Signal

The electrical signal, typically a sine wave, upon which modulation is impressed.

Carrier-to-Noise Ratio (C/N)

The ratio of carrier signal power to average noise power in a given bandwidth surrounding the carrier; usually expressed in decibels.

CCDF - Complimentary Cumulative Distribution Function

The Complementary Cumulative Distribution Function (CCDF) represents the probability that the peak power above average power of a measured signal exceeds a threshold.

CCDF is a plot of the percent of time that a signal's power value exceeds its average value versus the amount by which it exceeds the average. The CCDF plot has a log of probability on the Y-axis (100% at the top) and dB above average amplitude on the X-axis (0 at the left).

CDMA

Acronym for Code Division Multiple Access.

Center Frequency

The frequency corresponding to the center of a frequency span of the analyzer display.

Check Mark Indicator

The check mark indicator in the upper-left corner of the display indicates the display for which the acquisition hardware is optimized. When you have more than one display open, the display with the check mark indicator has control over the acquisition hardware. To give a display priority over any others, click its title bar.

When *Best for multiple windows* is selected in the Amplitude control panel's RF & IF Optimization control, none of the measurement displays shows a checkmark, as there is not a single optimized measurement.

CISPR

International special committee on radio interference. (Comité international spécial des perturbations radioélectriques)

CW

Acronym for Continuous Wave.

CW Signal

Continuous wave signal - a sine wave.

DANL

Acronym for Displayed Average Noise Level. See [Sensitivity](#) on page 880.

dBfs

A unit to express power level in decibels referenced to full scale. Depending on the context, this is either the full scale of the display screen or the full scale of the analog-to-digital converter (ADC).

dBm

A unit of expressed power level in decibels referenced to 1 milliwatt.

dBmV

A unit to express voltage levels in decibels referenced to 1 millivolt.

dBuV

A unit to express voltage levels in decibels referenced to 1 microvolt.

Decibel

Ten times the logarithm of the ratio of one electrical power to another.

Detection

The process by which a long waveform is decimated (reduced) down to the desired number of trace points, by dividing the waveform into intervals and choosing a single value to represent each interval in the trace.

Display Reference Level

A designated vertical position representing a specified input level. The level may be expressed in dBm, volts, or any other units.

Distortion

Degradation of a signal, often a result of nonlinear operations, resulting in unwanted signal components. Harmonic and intermodulation distortion are common types.

Dynamic Range

The maximum ratio of the levels of two signals simultaneously present at the input which can be measured to a specified accuracy.

EVM

Acronym for Error Vector Magnitude.

Export

Save data to a file in a format other than application-native.

FastFrame

FastFrame segments the acquisition record into a series of frames and then captures acquisitions as single frames. You can then view and measure each frame individually.

FFT

Fast Fourier Transform - a mathematical process to calculate the frequency spectrum of a discrete number of time domain sample points.

Filter

A circuit that separates electrical signals or signal components based on their frequencies.

FM

Acronym for Frequency Modulation.

Frame

A series of time-contiguous samples, long enough in duration and at a sufficient sample rate to produce a spectrum view of a specified span and RBW.

Frequency

A series of time-contiguous samples, long enough in duration and at a sufficient sample rate to produce a spectrum view of a specified span and RBW.

Frequency Band

The continuous range of frequencies extending between two limiting frequencies, expressed in hertz.

Frequency Domain View

The representation of the power of the spectral components of a signal as a function frequency; the spectrum of the signal.

Frequency Drift

Gradual shift or change in displayed frequency over the specified time due to internal changes in the analyzer, where other conditions remain constant. Expressed in hertz per second.

Frequency Range

The range of frequencies over which the performance of the instrument is specified.

Frequency Span

A continuous range of frequencies extending between two frequency limits.

Frequency Settling Time

The time measured from a reference point to when the signal of interest settles to within user-defined tolerance.

GPIB

Acronym for General Purpose Interface Bus, the common name for the communications interface system defined in IEEE Std. 488.

Graticule

The calibrated grid overlaying the display screen of analyzers, oscilloscopes, and other test instruments.

Grayed Out

An on-screen control is "Grayed Out" if it is not adjustable.

I/Q

Acronym for In-phase / Quadrature.

IF

Acronym for Intermediate Frequency.

Import

Bring data into the application from a file of some format other than application-native.

Impulse Response

The Impulse Response trace display shows normalized power on the vertical axis and time on the horizontal axis.

Input Impedance

The impedance at the desired input terminal. Usually expressed in terms of VSWR, return loss, or other related terms for low impedance devices and resistance-capacitance parameters for high impedance devices.

LISN

Acronym for Line Impedance Stabilization Network.

Local Oscillator (LO)

An oscillator which produces the internal signal that is mixed with an incoming signal to produce the IF signal.

Marker

A visually identifiable point on a waveform trace, used to extract a readout of domain and range values represented by that point.

Max Hold

Digitally stored display mode which, at each frequency address, compares the incoming signal level to the stored level and retains the greater level. In this mode, the display indicates the peak level at each frequency after several successive acquisitions.

MCPR (Multiple Carrier Power Ratio)

The ratio of the signal power in the reference channel or group of channel to the power in adjacent channels.

Min Hold

Digitally stored display mode which, at each frequency address, compares the incoming signal level to the stored level and retains the lower level. In this mode, the display indicates the minimum level at each frequency after several successive sweeps.

Modulate

To regulate or vary a characteristic of a signal, typically in order to transmit information.

Modulating Signal

The signal which modulates a carrier. The signal which varies or regulates some characteristic of another signal.

Modulation

The process of varying some characteristic of a signal with a second signal.

Noise

Unwanted random disturbances superimposed on a signal which tend to obscure it.

Noise Bandwidth (NBW)

The exact bandwidth of a filter that is used to calculate the absolute power in dBm/Hz.

Noise Floor

The noise intrinsic to a system that represents the minimum limit at which input signals can be observed; ultimately limited by thermal noise (kTB). The analyzer noise floor appears as a “grassy” baseline in the display, even when no signal is present.

Open (Recall)

Bring data into the application from a file of application-native format.

OQPSK

Acronym for Offset QPSK (Quadrature Phase Shift Keying).

Phase Settling Time

The time measured from a reference point to when the signal of interest settles to within user-defined tolerance.

PM

Acronym for Phase Modulation.

Primary Marker

The marker displayed in the Single Marker mode whose frequency and/or position is changed when tuning with the general purpose knob.

PSK

Acronym for Phase Shift Keying. The process, or result of a process, in which the carrier phase is varied discretely in accordance with a digital code.

QAM

Acronym for Quadrature Amplitude Modulation. The process, or result of a process, in which the amplitude and phase of the carrier are varied concurrently by synthesizing two orthogonal ASK waves (see ASK).

Real-Time Analysis

Measurement technique based on triggering on an RF signal, seamlessly capturing it into memory, and analyzing it in the frequency, time, and modulation domains.

Real-Time Bandwidth

The frequency span over which real-time seamless capture can be performed, which is a function of the digitizer and the IF bandwidth of a Real-Time Signal Analyzer.

Real-Time Seamless Capture

The ability to acquire and store an uninterrupted series of time domain samples that represent the behavior of an RF signal over a long period of time.

Reference Level

The signal level represented by the uppermost graticule line of the analyzer display.

Residual FM (Incidental FM)

Short term displayed frequency instability or jitter due to instability in the analyzer local oscillators. Given in terms of peak-to-peak frequency deviation and expressed in hertz or percent of the displayed frequency.

Residual Response

A spurious response in the absence of an input signal. (Noise and zero pip are excluded.)

RBW

The RBW determines how well the analyzer can resolve or separate two or more closely spaced signal components.

Ripple

The Ripple measurement result is displayed in either Watts or Volts. The amplitude units selected on the Setup > Analysis > Units tab determine whether the measurement is presented in Watts or Volts. Volts are shown for linear units (for example, volts or amps); Watts are shown for non-linear units (for example, watts or dBm).

The Ripple measurement, in Watts, is calculated as follows:

$$\%RippleWatts = 10 \times \text{RatioPos} + \text{RatioNeg}$$

Where:

$$\text{RatioNeg} = \frac{\text{DelNeg}}{\text{RefNeg}} + 1^2 - 1$$

$$\text{RatioPos} = \frac{\text{DelPos}}{\text{RefPos}} + 1^2 - 1$$

- DelPos = Delta Positive in Volts
- RefPos = Reference Positive in Volts
- DelNeg = Delta Negative in Volts (this is a positive value)
- RefNeg = Reference Negative in Volts

The Ripple measurement, in Volts, is calculated as follows:

$$\%RippleVolts = 100 \times \text{RatioPosV} + \text{RatioNegV}$$

Where:

- RatioPosV = DelPos/RefPos
- RatioNegV = DelNeg/RefNeg

Secondary Marker

The “second” marker displayed only in the Delta Marker mode.

Sensitivity

Measure of an analyzer’s ability to display minimum level signals, usually expressed as displayed average noise level ([DANL](#) on page 874).

Shape Factor (Skirt Selectivity)

The ratio of the frequency separation of the two (60 dB/3 dB) down points on the response curve to the static resolution bandwidth.

Signal

As used in this help, the signal refers to the input signal before it is processed. The signal is an input.

Signal Strength

Signal Strength locates the direction of a signal using a directional antenna and an audio tone and a visual display.

Span

Span is the range of frequencies displayed in a spectrum window. Span, start frequency and stop frequency are related by the following equation: $\text{Span} = (\text{stop frequency}) - (\text{start frequency})$. The settings for center, start and stop frequencies are related to the setting for span; when one parameter is changed, the others are changed automatically.

Span Per Division (Span/Div)

Frequency difference represented by each major horizontal division of the graticule.

Spectrogram

Frequency vs. time vs. amplitude display where the frequency is represented on the x-axis and time on the y-axis. The power level is indicated by variations in color.

Spectrum

The frequency domain representation of a signal showing the power distribution of its spectral component versus frequency.

Spectrum Analysis

The technique or process of determining the frequency content of an RF signal.

Spectrum Analyzer

A device for determining the frequency components of a signal.

Spectrum Time

Analysis Time for spectrum analysis views. Spectrum time can be the same as Analysis Time, but it can be different.

Spur/Spot

A spur is a signal peak that exceeds a user-definable threshold (See Spurious > Settings > Ranges) and excursion setting. A spur that also exceeds a limit (either Absolute or Relative) specified on the Settings > Limits tab is considered a violation. This is called a spot in the EMC-EMI display.

Index

Special Characters

- AM
 - AM display [66](#)
- Peak
 - Audio Summary display [652](#)
- Pk
 - FM display [67](#)
 - PM display [67](#)
- +AM
 - AM display [66](#)
- +Peak
 - Audio Summary display [651](#)
- +Pk
 - FM display [67](#)
 - PM display [67](#)

Numerics

- 20 dB bandwidth
 - Bluetooth [68](#)
- 3-D Spectrogram display [112](#)
- 3-D Waterfall
 - Spectrogram/DPXogram [117](#)
- 5GNR measurements [69](#)
- 802.11ad/11ay displays [316](#)
- 802.11ad/11ay measurements [315](#)
- 802.11ad/11ay Standards presets [312](#)
- 802.11ay BW packet measurements [312](#)

A

- Abort acquisition [753](#)
- About the Software [21](#), [842](#)
- Abs
 - Ranges and Limits table [193](#)
- Abs & Rel
 - Ranges and Limits table [193](#)
- Abs OR Rel
 - Ranges and Limits table [193](#)
- Abs Same
 - Ranges and Limits table [193](#)
- Abs Start (dBm)
 - Ranges and Limits table [193](#)
- Abs Stop (dBm)
 - Ranges and Limits table [193](#)
- Absolute Frequency [72](#), [360](#)
- Accessories tab [423](#)
- Accessories tab plot [460](#)
- accuracy [872](#)
- ACLR
 - LTE [69](#)
- ACLR measurement [166](#)
- ACPR measurement [872](#)
- Acq Data

- Acq Data (*continued*)
 - Replay menu [746](#)
- Acq Data/DPX Spectra [744](#)
- Acquire control panel [754](#)
- acquisition [872](#)
- acquisition data
 - saving [828](#)
- Acquisition data files [51](#)
- Acquisition Data tab [757](#), [848](#)
- Acquisition Info tab [745](#)
- Acquisition memory usage [756](#)
- activate the 5GNR analysis [26](#)
- adaptive equalizer [701](#)
- Adjacent Channel Power measurement [166](#)
- Adjacent Channel Power Ratio [61](#)
- Advanced Params tab
 - OFDM Analysis displays [351](#)
- Advanced Params Tab
 - GP Digital Modulation displays [703](#)
- Alaris
 - antenna function button [802](#)
- Alignments [856](#)
- AM display [144](#)
- AM measurements [66](#)
- Amplitude control panel [749](#)
- Amplitude vs. Time display [119](#)
- Amplitude vs. Time display Settings [121](#)
- Analysis
 - 802.11ad/11ay [315](#)
 - Analysis control panel [737](#)
 - analysis length [872](#)
 - Analysis Params tab
 - P25 Analysis displays [509](#)
 - WLAN Analysis displays [303](#)
 - Analysis tab
 - Pulse-Ogram display [390](#)
 - analysis time [872](#)
 - Analysis Time tab
 - GP Digital Modulation displays [707](#)
 - OFDM Analysis displays [353](#)
 - Options control panel [51](#)
 - P25 Analysis displays [509](#)
 - WLAN Analysis displays [305](#)
 - Analysis Time tab (Analysis control panel) [737](#)
- Antenna
 - Alaris function button [802](#)
 - control panel [798](#)
 - how to set up [799](#)
 - settings [798](#)
- Antenna Power [796](#)
- APCO P25 measurements [67](#)
- Application
 - moving a license [25](#)
- Application Help [842](#)
- Application preset

- Application preset (*continued*)
 - modulation analysis [48](#)
 - pulse analysis [48](#)
 - spectrum analysis [49](#)
 - Time-Frequency analysis [49](#)

- application presets
 - saving [828](#)

- Applications
 - install [23](#)
 - uninstall [24](#)

- Apply ampl corrections [386](#)

- APSK [696](#), [698](#)

- APSK parameters [705](#)

- APSK Parameters [704](#)

- ASK [872](#)

- Attenuator settings [749](#)

- Audio BW
 - setting [654](#)

- audio filters
 - custom [657](#)

- Audio Filters tab
 - Audio Analysis displays [655](#)

- Audio Freq
 - Audio Summary display [651](#)

- Audio Spectrum display [649](#)

- Auto
 - Ranges and Limits table [193](#)

- Automatically increment filename/number [51](#)

- Average Channel Power measurement [165](#)

- Average ON Power [70](#), [358](#)

- Average Transmitted Power [70](#), [358](#)

- Averaging
 - Audio Analysis displays [654](#)
 - Params2 tab [655](#)

B

- Battery status
 - Tools menu [857](#)

- black text
 - settling time measurements [210](#)

- Blizzard color scheme [52](#)

- block [872](#)

- Bluetooth
 - Analysis Params tab [639](#)
 - Analysis Time tab [639](#)
 - BT 20dB Bandwidth display [632](#)
 - Freq & RBW tab [647](#)
 - Frequency Dev vs Time (BT) display [629](#)
 - Limits tab [641](#)
 - Measurement Params tab [648](#)
 - Parameters tab [646](#)
 - Power class [638](#)
 - Prefs tab [645](#)
 - Scale tab [642](#)
 - Trace tab [643](#)

- Bluetooth measurements [68](#)

- BT Constellation
 - settings [615](#)

- BT limits [621](#)

- Burst detect threshold [152](#), [158](#)

- BW (Hz)
 - Ranges and Limits table [193](#)

- BW Tab
 - DPXOgram display [136](#)

C

- C4FM modulation type measurements [66](#)

- C4FM signal quality measurements [685](#)

- Cable loss [62](#)

- Cable Loss display settings [257](#)

- calibrator [872](#)

- Carr Freq Err
 - Audio Summary display [651](#)

- carrier [873](#)

- carrier frequency [873](#)

- Carrier frequency detection [152](#), [158](#)

- Carrier Frequency Error [66](#)

- Carrier frequency offset and drift
 - Bluetooth [68](#)

- Carrier Power
 - Audio Summary display [651](#)

- carrier signal [873](#)

- carrier-to-noise ratio (C/N) [873](#)

- CCDF [61](#)

- CCDF - Complimentary Cumulative Distribution Function [873](#)

- CCDF display [195](#)

- CDMA [873](#)

- Cell ID detection
 - LTE [69](#)

- center frequency [873](#)

- Change start and stop freq
 - EMC Range & Limits table [467](#)

- Channel direction [814](#)

- Channel Power
 - LTE [69](#)

- Channel Power and ACPR (Adjacent Channel Power Ratio) display [163](#)

- Channel Power and ACPR Settings control panel [166](#)

- Channel Power measurement [165](#)

- Channel Response
 - OFDM [62](#)
 - WLAN [63](#)

- Channel Settings [793](#)

- Channels
 - how to enable [815](#)
 - in signal database [813](#)

- Channels tab
 - Channel Power & ACPR display [166](#)
 - Signal Strength display [171](#)

- Channels tab (MCP) [179](#)

- check mark indicator [873](#)

- CISPR [873](#)

- Classic color scheme [52](#)

- Classify a signal [826](#)

- Combined impact gains/losses [460](#)

- Compare traces

- Compare traces (*continued*)
 - EMC troubleshooting [444](#)
- Configure
 - accessories [423](#)
- Connect [55](#)
- Connection
 - LAN or wireless to an MDO4000B/C [57](#)
 - PCIe to a RSA7100A [56](#)
 - to an RSA306, RSA306B, RSA500A series, RSA600A series, RSA7100 [55](#)
 - USB to an MDO4000B/C [56](#)
 - USB to RSA306, RSA306B, RSA500A series, RSA600A series [55](#)
- Constellation
 - 802.11ad [63](#)
 - OFDM [62](#)
 - WLAN [63](#)
- Constellation display
 - displaying a second trace [710](#)
- Constellation display settings [664](#)
- Convergence
 - Equalizer tab [702](#)
- Create a region (Signal Classification) [816](#)
- creating a mask [783](#)
- CW [874](#)
- CW signal [874](#)

D

- DANL [874](#)
- Data properties
 - File menu [847](#)
- Database
 - how to select channels [813](#)
 - how to set up signal types [812](#)
 - how to set up standards [811](#)
 - of signal standards [811](#)
- dBfs [874](#)
- dBm [874](#)
- dBmV [874](#)
- dBuV [874](#)
- De-emphasis
 - Audio Filters tab [655](#)
- deactivating options [30](#)
- decibel [874](#)
- Decimal separators [53](#)
- Declare a signal [826](#)
- default settings, restore [42](#)
- Define a region (Signal Classification) [816](#)
- Define Peaks tab [726](#)
- Define tab
 - Pulsed RF displays [385](#)
 - Settling Time displays [215](#)
- Demod I&Q vs Time display settings [667](#)
- Demodulation
 - audio [660](#)
- Density tab [101](#)
- detect
 - AM display [148](#)

- detect (*continued*)
 - FM display [153](#)
 - General Signal Viewing displays [133](#)
 - Time Overview [107](#)
- Detect
 - PM display [160](#)
- detection
 - AM display [148](#)
 - FM display [154](#)
 - General Signal Viewing displays [133](#)
 - Time Overview [107](#)
- Detection
 - DPX display [97](#)
 - PM display [160](#)
- detector
 - AM display [148](#)
 - FM display [153](#)
 - General Signal Viewing displays [133](#)
 - Time Overview [107](#)
- Detector
 - PM display [160](#)
 - Ranges and Limits table [193](#)
- Deviation [66](#)
- Diff
 - Audio Summary display [652](#)
- Disconnect from instruments
 - Connect [858](#)
- Display
 - EMC-EMI [447](#)
 - Pulse Statistics [374](#)
- display reference level [874](#)
- Displays
 - 802.11ad/11ay [316](#)
 - 802.11ad/11ay Constellation [316](#)
 - 802.11ad/11ay EVM vs Time [319](#)
 - 802.11ad/11ay Summary [323](#)
 - 802.11ad/11ay Symbol Table [322](#)
 - arranging [59](#)
 - BT CF Offset and Drift [618](#)
 - BT Constellation [613](#)
 - BT Eye Diagram [615](#)
 - BT Symbol Table [625](#)
 - Cumulative Histogram [360](#)
 - Cumulative Statistics Table [364](#)
 - EMC Analysis [415](#), [439](#)
 - LTE ACLR [528](#)
 - LTE Channel Spectrum [531](#)
 - LTE Constellation [533](#), [535](#)
 - OFDM Channel Response [336](#)
 - OFDM Constellation [338](#)
 - OFDM EVM [340](#)
 - OFDM Mag Error [343](#)
 - OFDM Phase Error [344](#), [345](#)
 - OFDM Power [346](#)
 - OFDM Spectral Flatness [341](#)
 - OFDM Summary [347](#)
 - OFDM Symbol Table [349](#)
 - P25 Constellation [491](#)
 - P25 Eye Diagram [493](#)
 - P25 Power [496](#)

- Displays (*continued*)
 - P25 Symbol Table [501](#)
 - SEM (Spectrum Emission Mask) [221](#)
 - WLAN Channel Response [281](#)
 - WLAN Constellation [283](#)
 - WLAN EVM [285](#)
 - WLAN Mag Error [287](#)
 - WLAN Phase Error [289](#), [290](#)
 - WLAN Power [291](#)
 - WLAN Spectral Flatness [293](#)
 - WLAN Summary [295](#)
- Distance to fault (DTF) [62](#)
- distortion [875](#)
- Done
 - Ranges and Limits table [194](#)
- Downlink [814](#)
- DPX Density Trigger [785](#), [786](#)
- DPX Spectra
 - Replay menu [746](#)
- DPX Spectra/Acq Data [744](#)
- Droop [71](#), [359](#)
- Droop dB [71](#), [359](#)
- DTF/Return Loss display settings [266](#)
- Duty Factor (%) measurement [71](#), [358](#)
- Duty Factor (Ratio) measurement [71](#), [358](#)
- Dwell Time [131](#)
- dynamic range [875](#)

E

- EMC
 - accessories setup [455](#)
 - Analysis option [414](#)
 - key features [415](#)
 - pre-compliance testing [415](#)
 - standards [414](#)
 - troubleshooting [415](#)
- EMC Analysis
 - displays [415](#), [439](#)
 - troubleshooting tools [439](#)
- EMC Analysis tool
 - how to open [415](#)
- EMC reports
 - generating [436](#)
- EMCVu
 - how to open [415](#)
- Enable EQ Export
 - Equalizer tab [702](#)
- Enable Equalization
 - Equalizer tab [702](#)
- error message
 - Windows Event Viewer [867](#)
- Error messages [862](#)
- EVM
 - 802.11ad [63](#)
 - OFDM [62](#)
 - WLAN [63](#)
- EVM tab
 - WLAN Analysis displays [309](#)

- EVM vs. Time display [668](#)
- Excrsn (dB)
 - Ranges and Limits table [193](#)
- Expand
 - Ranges and Limits Tab [192](#)
- export [875](#)
- External connections [53](#)
- External Gain value [750](#)
- Eye Diagram display settings [672](#)

F

- Fall Time [70](#), [358](#)
- Fast Frame [757](#)
- FastFrame [875](#)
- FFT [875](#)
- file formats supported
 - waveform [829](#)
- File types [836](#)
- filter [875](#)
- Filter Shape
 - Ranges and Limits table [192](#)
- Find tab
 - GP Digital Modulation displays [706](#)
- Flatness
 - OFDM [62](#)
 - WLAN [63](#)
- FM [875](#)
- FM display [150](#)
- FM measurements [66](#)
- frame [875](#)
- Freq and RBW tab
 - LTE [547](#)
- Freq Deviation [66](#), [72](#), [359](#)
- Freq Diff, Phase Diff, Freq Abs settings [387](#)
- Freq Error [66](#)
- Freq Estimation tab
 - Pulsed RF displays [389](#)
- Freq-domain Linearity setting [385](#)
- Freq, Span & RBW tab
 - Channel Power & ACPR display, MCPR display [177](#)
 - RF Measurements displays [231](#)
- Freq, Span & RBW tab
 - Signal Strength display [170](#)
- frequency [875](#)
- frequency band [876](#)
- Frequency Dev vs Time (P25) display [504](#)
- Frequency deviation
 - P25 [67](#)
- Frequency Deviation vs. Time settings [675](#)
- frequency domain view [876](#)
- frequency drift [876](#)
- Frequency Error [64](#), [684](#)
- Frequency Offset
 - GP Digital Modulation displays [701](#)
- frequency range [876](#)
- Frequency range
 - Bluetooth [68](#)
- Frequency Reference [761](#)

- Frequency scale
 - linear [460](#)
 - log [460](#)
- frequency settling time
 - measuring [212](#)
- frequency span [876](#)
- Frequency tab (Phase Noise) [202](#)
- Frequency vs. Time display [122](#)
- Full Screen [851](#)

G

- Gain Imbalance [64](#), [684](#)
- General signal viewing [73](#)
- Global Synchronization Settings [791](#)
- GNSS
 - control panel [795](#)
 - how to set up [797](#)
 - RSA source [797](#)
 - Simulation [797](#)
- GPIB [876](#)
- GPS
 - time stamp [764](#)
- graticule [876](#)
- Graticule On/Off
 - RF Measurements displays [235](#)
 - Signal Strength display [172](#)
- grayed out [876](#)

H

- H500 signal database [812](#)
- Harmonic markers
 - EMC troubleshooting [440](#)
- HCPM transmitter logical channel time alignment
 - P25 [68](#)
- Help Menu [860](#)
- Hide Sensitive readouts [51](#)
- Histogram readout
 - Pulsed RF displays [394](#)
- HPF
 - Audio Filters tab [655](#)
- Hum & Noise
 - Audio Summary display [659](#)

I

- I/Q [876](#)
- IF [877](#)
- Ignore Region
 - Params2 tab [655](#)
- import [877](#)
- Impulse Response Amplitude [72](#), [359](#)
- Impulse Response setting [386](#)
- Impulse Response Time [72](#), [359](#)
- In-band emission / ACPR
 - Bluetooth [68](#)
- InBand Emission
 - Bluetooth [634](#)

- input impedance [877](#)
- Inspect suspect frequencies
 - EMC troubleshooting [440](#)
- Install software [21](#)
- Internal Attenuator
 - Internal Settings tab [749](#)
- Internal Preamp
 - Internal Settings tab [749](#)
- IQ Origin Offset [64](#), [684](#)
- IQ Sampling Parameters tab [756](#)
- IQ streaming [805](#), [806](#), [808](#)
- IQ vs. time view [126](#)
- IRIG-B
 - time stamp [764](#)
- is greater than (Test) [731](#)
- is inside mask (Test) [732](#)
- is less than (Test) [731](#)
- is outside mask (Test) [732](#)

K

- Keep-out time [386](#)

L

- Launch EMC Analysis tool [415](#)
- Length
 - Equalizer tab [702](#)
- Level target
 - EMC troubleshooting [443](#)
- Levels tab
 - Pulsed RF displays [389](#)
- license
 - deactivating [30](#)
- License
 - install [23](#)
 - moving an application [25](#)
 - return [24](#)
 - trial [23](#)
 - uninstall [24](#)
- Licenses
 - available application options [31](#)
 - how to view [23](#)
- Limit lines [730](#)
- Limits
 - Spurious display [194](#)
- Limits tab
 - P25 Analysis displays [514](#)
- Linear frequency scale [460](#)
- LISN [877](#)
- Load
 - Ranges and Limits Tab [192](#)
 - Ranges and Limits table [194](#)
- local oscillator (LO) [877](#)
- Lock Center Frequency of Spectrum displays to Measurement Frequency
 - Frequency tab [742](#)
- Log
 - Audio Spectrum display [659](#)

- Log (Horizontal)
 - Spectrum display [112](#)
- Logarithmic frequency scale [460](#)
- Loop over all selected records
 - Replay menu [746](#)
- LPF
 - Audio Filters tab [655](#)
- LTE
 - Analysis Params tab [549](#)
 - Analysis Time tab [550](#)
 - Channels tab [538](#)
 - Freq and RBW tab [547](#)
 - Measurement Params tab [548](#)
 - Modulation Params tab [548](#)
 - Offsets and Limits Table tab [542](#)
 - Parameters tab [540](#)
 - Prefs tab [546](#)
 - Processing tab [541](#)
 - Scale tab [544](#)
 - Trace tab [551](#)
 - VBW (Channels tab) [539](#)
 - VBW (Freq & RBW tab) [547](#)
- LTE ACLR
 - settings [530](#)
- LTE measurements [69](#)

M

- Mag Error
 - OFDM [62](#)
 - WLAN [63](#)
- Magnitude Error vs. Time display [676](#)
- Magnitude Error vs. Time settings [678](#)
- Map It
 - how to use [802](#)
- marker [877](#)
- Marker noise mode (dBc/Hz) [725](#)
- Marker to Center Frequency [725](#)
- Markers
 - in the BT Symbol Table [628](#)
 - Marker Toolbar [726](#)
 - Using Markers [721](#)
 - Using Markers in Noise Mode [727](#)
- Markers menu [854](#)
- Markers snap to peaks when dragged [53](#)
- Mask
 - Ranges and Limits table [193](#)
- Mask Editor [730](#)
- Mask tab
 - Settling Time displays [217](#)
- mask testing
 - settling time measurement [204](#)
- MAT files
 - supported versions [834](#)
- Math trace
 - Traces tab [96](#)
- MATLAB
 - choose a data type [52](#)
- MATLAB Level 5 (v6) [52](#)
- MATLAB Level 7.3 (v7.3) [52](#)
- Max Freq Error [71](#), [359](#)
- max hold [877](#)
- Max Number of Pulses
 - Params tab [384](#)
- Max Phase Error [71](#), [359](#)
- Max total files saved per Run [790](#)
- MCPR (multiple carrier power ratio) [877](#)
- MCPR display [173](#)
- MCPR settings [176](#)
- Meas BW
 - Frequency Settling Time [216](#)
- Meas Frequency
 - Frequency Settling Time [216](#)
- Measurement Filter
 - Params tab [383](#)
- Measurement Length
 - Time Params tab [217](#)
- Measurement Params tab
 - Channel Power & ACPR display, MCPR display [178](#)
 - Signal Strength display [170](#)
- Measurement point [387](#)
- Measurement Settings [792](#)
- Measurements
 - 802.11ad/11ay [315](#)
 - APCO P25 [67](#)
 - Bluetooth [68](#)
 - LTE [69](#)
- Measurements tab [383](#)
- measuring settling time [212](#)
- Menus [843](#)
- MER (RMS) [64](#), [684](#)
- min hold [877](#)
- Min Settled Duration
 - Time Params tab [217](#)
- Minimum off time between pulses
 - Params tab [384](#)
- Mod Distor
 - Audio Summary display [652](#)
- Mode
 - Equalizer tab [702](#)
- modulate [878](#)
- modulating signal [878](#)
- modulation [878](#)
- Modulation analysis
 - application presets [48](#)
- Modulation characteristics
 - Bluetooth [68](#)
- Modulation fidelity
 - P25 [67](#)
- modulation measurements [662](#)
- Modulation measurements [64](#)
- Modulation Params tab
 - GP Digital Modulation displays [695](#)
 - OFDM Analysis displays [351](#)
 - P25 Analysis displays [507](#), [637](#)
 - WLAN Analysis displays [302](#)
- Modulation types supported [695](#)
- moving windows [859](#)
- MSO Settings [759](#)

Multi-Carrier Power Ratio [61](#)
Multi-channel analysis [59](#)
Multiple Carrier Power Ratio [176](#)

N

nFSK modulation type measurements [65](#)
nFSK signal quality measurements [685](#)
No. of Harmonics
 Params2 tab [655](#)
No. of Non-Harmonics
 Params2 tab [655](#)
noise [878](#)
noise bandwidth (NBW) [878](#)
noise floor [878](#)
Non-Harmonic Excursion
 Params2 tab [655](#)
Non-Harmonic Threshold
 Params2 tab [655](#)
NR Averaging tab [595](#)
NR Carrier Configuration tab [585](#)
NR Channel power display [565](#)
NR CHP tab [598](#)
NR Estimation tab [602](#)
NR Modulation Accuracy tab [601](#)
NR SEM tab [599](#)
NR Signal Configuration tab [583](#)
NR Subblock Configuration tab [584](#)
NR Traces tab [603](#)
Numeric keypad [850](#)

O

OBW Level Left/Right [181](#)
Occupied bandwidth
 LTE [69](#)
Occupied Bandwidth [183](#)
OFDM Channel Response
 settings [338](#)
OFDM Constellation
 settings [339](#)
Off
 Ranges and Limits table [193](#)
Offset & Limits Table tab
 SEM display [228](#)
Offset EVM [684](#)
On
 Ranges and Limits table [192](#)
open (recall) [878](#)
Open EMC Analysis tool [415](#)
Operating band unwanted emission
 LTE [69](#)
Operating frequency accuracy
 P25 [67](#)
option
 activate with Internet [28](#)
 activate without Internet [29](#)
Option key
 activate [28](#)

options
 deactivating [30](#)
 deactivating legacy [30](#)
Options
 transferring an application license [25](#)
OQPSK [878](#)
OQPSK and SOQPSK modulation type measurements [64](#)
Out-of-band spurious emission
 Bluetooth [69](#)
Output power
 Bluetooth [68](#)
Overshoot
 dB [359](#)
Overshoot dB [71](#), [359](#)
Overshoot settings [388](#)

P

P25
 presets [47](#)
P25 Constellation
 settings [493](#)
P25 limits [498](#)
P25 measurements [67](#)
Parameters tab
 AM display [146](#)
 CCDF display [197](#)
 FM display [152](#)
 Occupied BW display [184](#)
 Phase Noise display [203](#)
 PM display [158](#)
 SEM display [224](#)
 Spurious display [189](#)
Params tab
 Pulsed RF displays [383](#)
Params1 tab
 Audio Analysis displays [653](#)
Params2 tab
 Audio Analysis displays [654](#)
Pass /Fail readout
 SEM display [222](#)
Pass/Fail Limit Testing
 Spurious display [195](#)
Pass/fail testing
 EMC Range & Limits table [468](#)
Pass/Fail tests [731](#)
Pause
 Replay menu [746](#)
Peak FSK err [65](#)
Peak Mag Err [66](#)
Peak Power [70](#), [358](#)
Peak-Peak/2
 Audio Summary display [652](#)
Peak/Avg Ratio [61](#)
Phase Deviation [72](#), [359](#)
Phase Difference [359](#)
Phase Error
 OFDM [62](#)
 WLAN [63](#)

- Phase Error vs. Time display [679](#)
- Phase Error vs. Time settings [680](#)
- Phase Noise display [198](#)
- phase settling time
 - measuring [212](#)
- Phase Settling Time display [208](#)
- Phase Settling Time settings [211](#), [214](#)
- Phase vs. Time display [124](#)
- Phase vs. Time settings [126](#)
- pictures
 - saving [828](#)
- Pk-Pk
 - FM display [67](#)
 - PM display [67](#)
- Pk-Pk/2
 - FM display [67](#)
- Playback
 - Define skip [774](#)
 - Exit playback [775](#)
 - Live rate [774](#)
 - Location [774](#)
 - Loop file [774](#)
 - Progress bar [774](#)
- Plot
 - Accessories tab [460](#)
- PM [878](#)
- PM measurements [67](#)
- Power
 - OFDM [62](#)
- Power class
 - Bluetooth [638](#)
- Power density
 - Bluetooth [69](#)
- power measurements [163](#)
- Power measurements [61](#)
- Power Threshold to Detect Pulses
 - Params tab [384](#)
- Power vs Time
 - WLAN [63](#)
- PPS
 - time stamp [764](#)
- Pre-defined Filters
 - Audio Filters tab [656](#)
- Prefs tab
 - AM display [149](#)
 - FM display [155](#)
 - GP Digital Modulation displays [711](#)
 - OFDM Analysis displays [356](#)
 - Options control panel [52](#)
 - P25 Analysis displays [514](#)
 - PM display [161](#)
 - WLAN Analysis displays [309](#)
- Presets
 - 802.11ad/11ay [312](#)
 - P25 [47](#)
 - recalling [45](#)
 - Standards [42](#), [47](#)
 - WLAN [47](#)
- Presets tab
 - Options control panel [51](#)
- primary marker [879](#)
- Print [849](#)
- Print Preview [849](#)
- Processing tab
 - SEM display [226](#)
- Product documentation [34](#)
- PSK [879](#)
- Pulse analysis
 - application presets [48](#)
- Pulse measurements [70](#), [358](#)
- Pulse Table display [369](#)
- Pulse Trace display [371](#)
- Pulse Width [70](#), [358](#)
- Pulse-Pulse Frequency Difference [72](#), [360](#)
- Pulse-Pulse Phase Difference [72](#), [360](#)
- Pulse-ref Freq Difference [71](#), [359](#)
- Pulse-ref Phase Difference [71](#), [359](#)
- pulses
 - how many can be analyzed [384](#)

Q

- QAM [879](#)
- Quadrature Error [64](#), [684](#)

R

- Ranges and Limits Tab
 - Spurious display [191](#)
- RBW [880](#)
- real-time analysis [879](#)
- real-time bandwidth [879](#)
- real-time seamless capture [879](#)
- Recalling Presets [45](#)
- Record [767](#)
- Record control panel
 - Record [770](#)
- Record to disk [771](#)
- red text
 - settling time measurements [210](#)
- Ref
 - Audio Summary display [652](#)
- Ref Channel tab
 - SEM display [227](#)
- reference level [879](#)
- Reference tab
 - Spurious display [190](#)
- Rel
 - Ranges and Limits table [193](#)
- Rel Same
 - Ranges and Limits table [194](#)
- Rel Start (dB)
 - Ranges and Limits table [194](#)
- Rel Stop (dB)
 - Ranges and Limits table [194](#)
- Relative power
 - Bluetooth [69](#)
- Repeat [753](#)
- Repetition Interval [70](#), [358](#)

- Repetition Rate [70, 358](#)
- Replay all selected records
 - Replay menu [746](#)
- Replay current record
 - Replay menu [746](#)
- Replay from selected
 - Replay menu [746](#)
- Replay menu [746](#)
- Replay Speed tab [746](#)
- Replay toolbar
 - Replay menu [746](#)
- Reports
 - EMC Analysis [432](#)
 - generate EMI test [436](#)
 - save EMI test results [435](#)
- Reset Equalization
 - Equalizer tab [702](#)
- Reset layout
 - Ranges and Limits Tab [192](#)
- residual FM (incidental FM) [879](#)
- residual response [879](#)
- results
 - saving [828](#)
- Resume [753, 853](#)
- Return loss (RL) [62](#)
- Return loss measurements [62](#)
- RF Channel Power measurement [165](#)
- RF output power
 - P25 [67](#)
- Rho [64, 684](#)
- Ripple [71, 359](#)
- Ripple dB [71, 359](#)
- ripple measurement
 - calculation [880](#)
- Ripple settings [387](#)
- Rise Time [70, 358](#)
- RMS
 - Audio Summary display [652](#)
 - FM display [67](#)
 - PM display [67](#)
- RMS Error Magnitude [66](#)
- RMS Freq Error [71, 359](#)
- RMS FSK Err [65](#)
- RMS Mag Err [66](#)
- RMS Phase Error [71, 359](#)
- RSA Device [796](#)
- Run [753](#)
- Run menu [853](#)

S

- S/N
 - Audio Summary display [652](#)
- Save
 - Ranges and Limits Tab [192](#)
- Save acq data on Trigger [790](#)
- Save and Export tab
 - Options control panel [51](#)
- Save As

- Save As (*continued*)
 - Ranges and Limits table [194](#)
- Save on trigger [789](#)
- Save picture on Trigger [790](#)
- saved file types [828](#)
- saving
 - acquisition data [828](#)
 - pictures [828](#)
 - results [828](#)
 - setups [828](#)
- Scale tab
 - AM display [149](#)
 - Audio Analysis displays [658](#)
 - CCDF display [197](#)
 - DPX Spectrum display [99, 100](#)
 - FM display [154](#)
 - General Signal Viewing displays [137](#)
 - GP Digital Modulation displays [710](#)
 - OFDM Analysis displays [355](#)
 - P25 Analysis displays [512](#)
 - PM display [161](#)
 - Pulsed RF displays [392](#)
 - RF Measurements displays [234](#)
 - SEM display [229](#)
 - Settling Time displays [219](#)
 - Signal Strength display [172](#)
 - WLAN Analysis displays [307](#)
- Search control panel [735](#)
- Search In [731](#)
- secondary marker [880](#)
- Security tab
 - Options control panel [52](#)
- Select all
 - Replay menu [746](#)
- Select data records tab [744](#)
- Select DPX Spectra tab [745](#)
- Select records from history
 - Replay menu [746](#)
- sensitivity [880](#)
- Set limits
 - EMC Range & Limits table [468](#)
- Set to max BW [131](#)
- Settings
 - AM display [145](#)
 - Audio Spectrum display [650](#)
 - Audio Summary display [652](#)
 - BT 20dB BW [634](#)
 - BT CF Offset and Drift [534, 537, 620](#)
 - BT Constellation [615](#)
 - BT Eye Diagram [617](#)
 - BT Frequency Dev vs. Time [631](#)
 - BT Summary [624](#)
 - BT Symbol Table [628](#)
 - Cable Loss display [257](#)
 - CCDF display [196](#)
 - Cumulative Histogram display [362](#)
 - Cumulative Statistics Table display [367](#)
 - DPX Spectrum [95](#)
 - DTF/Return Loss display [266](#)
 - EVM vs. Time display [669](#)

Settings (continued)

- FM display [151](#)
- Frequency vs. Time [124](#)
- LTE ACLR [530](#)
- LTE Channel Spectrum [533](#)
- Occupied Bandwidth [183](#)
- OFDM Constellation [339](#)
- OFDM EVM [341](#)
- OFDM Flatness [342](#)
- OFDM Mag Error [344](#)
- OFDM Power [347](#)
- OFDM Summary [348](#)
- OFDM Symbol Table [350](#)
- P25 Constellation [493](#)
- P25 Eye Diagram [495](#)
- P25 Frequency Dev vs. Time [506](#)
- P25 Power vs Time [498](#)
- P25 Summary [501](#)
- P25 Symbol Table [503](#)
- Phase Noise [201](#)
- Phase Settling Time [211](#)
- Pulse Statistics display [379](#)
- Pulse Table display [371](#)
- Pulse Trace display [373](#)
- Pulse-Ogram display [369](#)
- RF I & Q vs. Time [128](#)
- Spectrogram display [116](#)
- Spectrum Emission Mask [224](#)
- Spurious display [189](#)
- Symbol Table display [688](#)
- WLAN Constellation [284](#)
- WLAN EVM [286](#)
- WLAN Mag Error [288](#)
- WLAN Power vs Time [293](#)
- WLAN Spectral Flatness [295](#)
- WLAN Summary [298](#)
- Settled Frequency
 - definition [204](#)
- Settled Phase
 - definition [204](#)
- settling time
 - measuring [212](#)
- Settling Time
 - definition [203](#)
- Settling Time decimal places
 - Settling Time displays [220](#)
- settling time measurement
 - text color [210](#)
- Setup Menu [854](#)
- setups
 - saving [828](#)
- shape factor (skirt selectivity) [880](#)
- Show graticule
 - General Signal Viewing Displays [139](#)
- Show points [460](#)
- signal [880](#)
- Signal Classification
 - create a region [816](#)
 - define a region [816](#)
- Signal database

Signal database (continued)

- merge the H500 database [812](#)
- Signal Power
 - Audio Summary display [651](#)
- Signal Quality display [681](#)
- Signal quality measurements [683](#)
- Signal Quality settings [686](#)
- Signal standards [811](#)
- signal strength [881](#)
- Signal Strength [61](#)
- Signal Strength display [168](#)
- Signal Strength Settings control panel [169](#)
- Signal types [811](#)
- Simulation
 - GNSS [797](#)
- SINAD
 - Audio Summary display [652](#)
- Source Configuration [757](#)
- Source Selection [692](#)
- Source Settings [792](#)
- span [881](#)
- span per division [881](#)
- spectrogram [881](#)
- spectrum [881](#)
- spectrum analysis [881](#)
- Spectrum analysis
 - application presets [49](#)
 - spectrum analyzer [881](#)
- Spectrum display [109](#)
- Spectrum display settings [111](#)
- Spectrum Monitor
 - Spectrogram [119](#)
- spectrum time [881](#)
- Split
 - DPX display [90](#)
- spot [881](#)
- Spot requirements
 - EMC Range & Limits table [468](#)
- Spur
 - defining [194](#)
- Spurious [185](#)
- Standard
 - Audio Filters tab [655](#)
- Standard Settings button [694](#)
- Standards
 - 802.11ad/11ay [312](#)
 - how to set up database [811](#)
- Standards presets
 - P25 [47](#)
 - WLAN [47](#)
- Start (Hz)
 - Ranges and Limits table [192](#)
- Status Bar [851](#)
- Stop
 - Replay menu [746](#)
- Stop (Hz)
 - Ranges and Limits table [192](#)
- Summary
 - 802.11ad [64](#)
 - WLAN [63](#)

- supported file formats
 - waveform [829](#)
- symbol maps [712](#)
- Symbol Rate [66](#)
- Symbol rate accuracy
 - P25 [68](#)
- Symbol Rate Error [66](#)
- Symbol Table
 - 802.11ad [63](#)
 - WLAN [63](#)
- Symbol Table display [687](#)

T

- Taps
 - Equalizer tab [702](#)
- Taps/Symbol
 - Equalizer tab [702](#)
- Target Reference
 - Frequency Settling Time [216](#)
- Test For [731](#)
- Test Patterns tab
 - P25 Analysis displays [511](#)
- Test using a mask [732](#)
- THD
 - Audio Summary display [652](#)
- Threshld (dBm)
 - Ranges and Limits table [193](#)
- Thunderstorm color scheme [52](#)
- Time [359](#)
- Time & Freq Scale tab
 - Spectrogram display [100](#), [118](#)
- Time Overview [102](#)
- Time Overview display settings [104](#)
- Time Params tab
 - Settling Time displays [216](#)
- Time stamp
 - GPS, PPS, IRIG-B [764](#)
- Time-Frequency analysis
 - application presets [50](#)
- TIQ acquisition data files [51](#)
- TIQ acquisition data files parameters [50](#)
- TNHD
 - Audio Summary display [652](#)
- TOFF
 - LTE [69](#)
- Tolerance (+/-)
 - Frequency Settling Time [216](#)
- Tools Menu [855](#)
- Total AM
 - AM display [66](#)
- Touch-screen Actions [37](#)
- Trace 2
 - Constellation display [710](#)
- Trace tab
 - AM display [147](#)
 - FM display [153](#)
 - GP Digital Modulation displays [708](#)
 - OFDM Analysis displays [354](#)

- Trace tab (*continued*)
 - P25 Analysis [511](#)
 - PM display [159](#)
 - Settling Time displays [218](#)
 - Time Overview display [106](#)
 - WLAN Analysis displays [306](#)
- Traces tab
 - General Signal Viewing displays [132](#)
 - Pulse-Ogram display [391](#)
 - RF Measurements display [232](#)
 - Spectrogram display [117](#)
 - WLAN Channel Response display [306](#)
- Traces tab - Math Trace
 - General Signal Viewing displays [135](#)
- Transmission Gain [62](#)
- Transmitter frequency behavior
 - P25 [68](#)
- Transmitter power and encoder attack time
 - P25 [68](#)
- Transmitter power and encoder attack time with busy/idle
 - P25 [68](#)
- Transmitter throughput delay
 - P25 [68](#)
- Trellis Diagram display settings [691](#)
- Trial license [23](#), [26](#), [855](#)
- Trial licenses [30](#)
- Trig Meas tab
 - P25 Analysis displays [513](#)
- Trigger
 - detectable per second [788](#)
 - frequency mask [781](#)
 - frequency mask editor [783](#)
 - power [780](#)
 - type [780](#)
- Trigger configuration [776](#)
- Trigger On This [785](#)
- Trigger settings
 - Advanced tab [789](#)
- Trigger source
 - RF Input [777](#)
- Troubleshooting tools
 - EMC Analysis [439](#)
- Troubleshooting tools EMC
 - persistence display [446](#)
- Types
 - how to set up signal database [812](#)

U

- Units tab [744](#)
- Unwanted emissions (ACPR)
 - P25 [67](#)
- Uplink [814](#)
- User Filters
 - file format [717](#)
 - loading [717](#)
- User Symbol Map [705](#)

V

VBW

LTE [539](#), [547](#)

VBW (Hz)

Ranges and Limits table [193](#)

VBW On

Ranges and Limits table [193](#)

Video tutorials [36](#)

View

Basic Controls Toolbar [851](#)

Full Screen [849](#)

Markers Toolbar [850](#)

Navigator View [849](#)

Numeric keypad [850](#)

Replay Toolbar [850](#)

Status Bar [851](#)

Traces Toolbar [850](#)

View Menu [849](#)

violation (frequency mask trigger) [781](#)

W

Warm-up period data [53](#)

waveform file formats supported [829](#)

WLAN

presets [47](#)

WLAN Channel Response

settings [282](#)

WLAN Constellation

settings [284](#)

X

x dB Level [184](#)